

SAMSUNG

COLOR MONITOR

SMC-213

SMC-214

User Guide

Guide de l'utilisateur

Bedienungsanleitung

Guía del Usuario

Manuale d'uso

Руководство пользователя

Instrukcja obsługi

E

F

D

ES

I

RU

PL

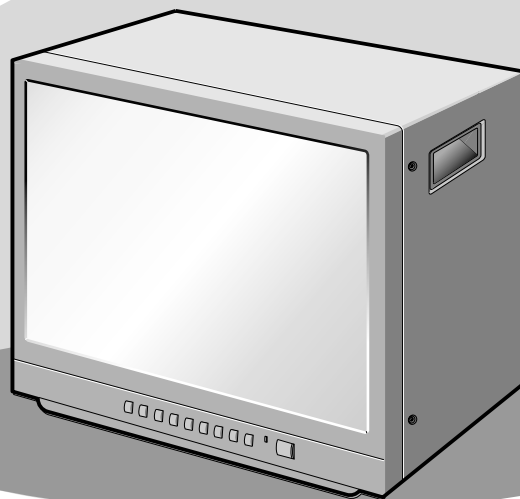

IMPORTANT SAFETY INSTRUCTIONS

1. Read these instructions.
2. Keep these Instructions.
3. Heed all warnings.
4. Follow all instructions.
5. Do not use this apparatus near water.
6. Clean only with dry cloth.
7. Do not block any ventilation openings. Install in accordance with the manufacturer's instructions.
8. Do not install near any heat sources such as radiators, heat registers, stoves, or other apparatus (including amplifiers) that produce heat.
9. Do not defeat the safety purpose of the polarized or grounding-type plug. A polarized plug has two blades with one wider than the other. A grounding type plug has two blades and a third grounding prong. The wide blade or the third prong are provided for your safety. If the provided plug does not fit into your outlet, consult an electrician for replacement of the obsolete outlet.
10. Protect the power cord from being walked on or pinched particularly at plugs, convenience receptacles and the point where they exit from the apparatus.
11. Only use attachment/accessories specified by the manufacturer.
12. Use only with the cart, stand, tripod, bracket or table specified by the manufacturer or sold with the apparatus. When a cart is used, use caution when moving the cart/apparatus combination to avoid injury from tip-over.
13. Unplug this apparatus during lightning storms or when unused for long periods of time.
14. Refer all servicing to qualified service personnel. Servicing is required when the apparatus has been damaged in any way, such as power-supply cord or plug is damaged, liquid has been spilled or objects have fallen into the apparatus the apparatus has been exposed to rain or moisture does not operate normally or has been dropped.



CAUTION

**RISK OF ELECTRIC SHOCK
DO NOT OPEN**

CAUTION : TO REDUCE THE RISK OF ELECTRIC SHOCK, DO NOT REMOVE COVER (OR BACK). NO USER SERVICEABLE PARTS INSIDE. REFER SERVICING TO QUALIFIED SERVICE PERSONNEL.



Graphic Symbol Explanation

The lightning flash with arrowhead symbol, within an equilateral triangle, is intended to alert the user to the presence of uninsulated 'dangerous voltage' within the product's enclosure that may be of sufficient magnitude to constitute a risk of electric shock to persons.

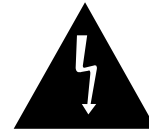

The exclamation point within an equilateral triangle is intended to alert the user to the presence of important operating and maintenance (servicing) instructions in the literature accompanying the appliance.



Warning - To Prevent Fire or Shock Hazard, Do Not Expose This Monitor To Rain or Moisture.

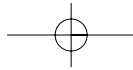



IMPORTANT SAFEGUARDS

Caution

Power source is indicated on the rear of the set. It contains high-voltage parts. If you remove the cover, it may cause fire or electric shock. Do not remove the cover by yourself. (Control switches are at the front of the monitor.)

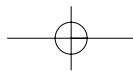
- 1. Read Instructions :** All the safety and operating instructions should be read before the appliance is operated.
- 2. Retain Instructions :** The safety and operating instructions should be retained for future reference.
- 3. Heed Warnings :** All warnings on the monitor and in the operating instructions should be adhered to.
- 4. Follow Instructions :** All operating and user instructions should be followed.
- 5. Cleaning :** Unplug this monitor from the wall outlet before cleaning. Do not use liquid cleaners or aerosol cleaners. Use a damp cloth for cleaning.
Exception. A monitor that is meant for uninterrupted service and that for some specific reason, such as the possibility of the loss of an authorization code for a CATV converter is not intended to be unplugged by the user for cleaning or any other purpose may exclude the reference to unplugging the monitor in the cleaning description otherwise required in Item 5.
- 6. Attachments :** Do not use attachments not recommended by Samsung as they may cause hazards.
- 7. Water and Moisture :** Do not use this monitor near water for example, near a bathtub, wash bowl, kitchen sink or laundry tub in a wet basement or near a swimming pool and the like wet basement or near a swimming pool and the like.

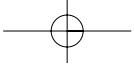

- 
-
- 8. Accessories :** Do not place this monitor on an unstable cart, stand, tripod, bracket or table. The monitor may fall, causing serious injury to a child or adult and serious damage to the appliance. Use only with a cart, stand, tripod, bracket or table recommended by Samsung or sold with the monitor. Any mounting of the monitor should follow Samsung's instructions and should use a mounting accessory recommended by Samsung.
- 9. Ventilation :** Slots and openings in the cabinet are provided for ventilation and to ensure reliable operation of the monitor and to protect it from overheating and these openings should never be blocked by placing the monitor on a bed, sofa, rug or other similar surface. This monitor should never be placed near or over a radiator or heat register. This monitor should not be placed in a built-in installation such as a bookcase or rack unless proper ventilation is provided or Samsung's instructions have been adhered to.
- 10. Power Sources :** This monitor should be operated only from the type of power source indicated on the making label. If you are not sure of the type of power supply to your installation site, consult your Samsung dealer or local power company.
- 11. Grounding or Polarization :** For monitors equipped with a 3-wire grounding-type plug having a third(grounding) pin. This plug will only fit into a grounding type power outlet. This is a safety feature. If you are unable to insert the plug into the outlet, contact your electrician to replace your obsolete outlet. Do not defeat the safety purpose of the grounding-type plug.
- 12. Power :** Cord Protection-Power supply cords should be routed so that they are not likely to be walked on or pinched by items placed upon or against them, paying particular attention to cords at plugs, convenience receptacles and the point where they exit from the monitor.
- 
- 



User Guide

- 13. Lightning :** For added protection for this monitor during a lightning storm or when it is left unattended and unused for long periods of time, unplug it from the wall outlet and disconnect the cable system. This will prevent damage to the monitor due to lightning and power-line surges.
- 14. Overloading :** Do not overload wall outlets and extension cords as this can result in a risk of fire of electric shock.
- 15. Object and liquid Entry :** Never push objects of any kind into this monitor through openings as they may touch dangerous voltage points or short-out parts that could result in a fire or electric shock.
Never spill liquid of any kind on the monitor.
- 16. Servicing :** Do not attempt to service this monitor yourself as opening or removing cover may expose you to dangerous voltage or other hazards. Refer all servicing to qualified service personnel.
- 17. Damage Requiring Service :** Unplug this monitor from the wall outlet and refer servicing to qualified service personnel under the following conditions.
- When the power-supply cord or plug is damaged.
 - If liquid has been spilled or objects have fallen into the monitor.
 - If the monitor has been exposed to rain or water.
 - If the monitor does not operate normally by following the operating instructions. Adjust only those controls that are covered by the operating instructions as an improper adjustment of other controls may result in damage and require extensive work by a qualified technician to restore the monitor to its normal operation.
 - If the monitor has been dropped or the cabinet has been damaged.
- 18. Replacement Parts :** When replacement parts are required, be sure the service technician has used replacement parts specified by Samsung or have the same characteristics as the original parts.
Unauthorized substitutions may result in fire, electric shock or other hazards.

19.Safety Check : Upon completion of any service or repairs to this monitor, ask the service technician to preform safety checks to determine that the monitor is in proper operating condition.

FCC information

Warning



This equipment has been tested and found to comply the limits for a class A digital device, pursuant to part 15 of the FCC Rules and ICES-003 of Industry Canada.

These limits are designed to provide reasonable protection against harmful interference when the equipment is operated in a commercial environment. This equipment generate, uses and can radiate radio frequency energy and, if not installed and used in accordance with the instruction manual, may cause harmful interference to radio communications.

Operation of this equipment in a residential area is likely to cause harmful interference in which case the user will be required to correct the interference at his own expense.

User-Installer Caution

Changes or modifications not expressly approved by the party responsible for compliance could void the user's authority to operate the equipment.

User Guide

Information to user

Changes or modifications not expressly approved by the party responsible for compliance could void the user's authority to operate the equipment.

NOTE: This equipment has been tested and found to comply with the limits for a Class A digital device, pursuant to Part 15 of the FCC Rules.

These limits are designed to provide reasonable protection against harmful interference when the equipment is operated in a commercial environment. This equipment generates, uses and can radiate radio frequency energy and, if not installed and used in accordance with the instruction manual, may cause harmful interference to radio communications.

Operation of this equipment in a residential area is likely to cause harmful interference in which case the user will be required to correct the interference at his own expense.

This device complies with Part 15 of the FCC Rules. Operation is subject to the following two conditions: (1) this device may not cause harmful interference and (2) this device must accept any interference received, including interference that may cause undesired operation.

Changes or modifications not expressly approved by the party responsible for compliance could void the user's authority to operate the equipment.

If necessary, consult your dealer or an experienced radio/television technician for additional suggestions. You may find the booklet called How to Identify and Resolve Radio/TV Interference Problems helpful.

This booklet was prepared by the Federal Communications Commission. It is available from the U.S. Government Printing Office, Washington, DC 20402, Stock Number 004-000-00345-4.

The party responsible for product compliance:
SAMSUNG ELECTRONICS CO., LTD.
America QA Lab of Samsung
3351 Michelson Drive,
Suite #290, Irvine, CA92612 USA

IC Compliance Notice



This Class (A) digital apparatus meets all requirements of the Canadian Interference-Causing Equipment Regulations.
Cet appareil numérique de la classe (A) respecte toutes les exigences du Règlement sur le matériel brouilleur du Canada.

This Class A digital apparatus complies with Canadian ICES-003.
Cet appareil numérique de la classe A est conforme à la norme NMB-003 du Canada.

Warning

This is a class A product. In a domestic environment this product may cause radio interference in which case the user may be required to take adequate measures.

CALIFORNIA USA ONLY

This Perchlorate warning applies only to primary CR (Manganese Dioxide) Lithium coin cells in the product sold or distributed ONLY in California USA.

“Perchlorate Material - special handling may apply,
See www.dtsc.ca.gov/hazardouswaste/perchlorate.”

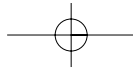

User Guide

Contents

IMPORTANT SAFETY INSTRUCTIONS.....	English-2
IMPORTANT SAFEGUARD.....	English-4
FCC informatio.....	English-7
Front Panel Components and Controls(SMC-213).....	English-11
• Using buttons on the front panel	English-12
Settings Range of Each Button.....	English-13
Front Panel Components and Controls(SMC-214).....	English-15
Strcture of the Setup Menu	English-16
Rear Panel Components and Controls(SMC-213).....	English-17
Rear Panel Components and Controls(SMC-214).....	English-18
Connections.....	English-19
Maintenance.....	English-20
Specifications.....	English-21

English-10

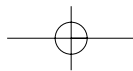

Front Panel Components and Controls (SMC-213)

Using buttons on the front panel

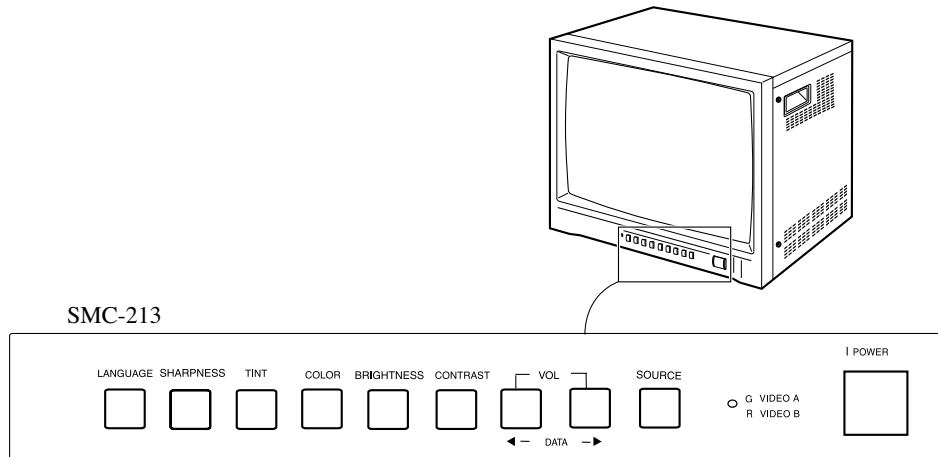

I POWER



Power Switch

On/Off switch. If you press this button, the monitor is turned on and the LED of selected input signal is lit.

SOURCE



SOURCE(VIDEO Input Selection)Switch

It selects video input signal. To change input signal, press this button.

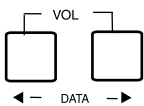

VOL, DATA Control Switch

VOL key has two functions :

- Vol Control : To change volume, press only this key.
- Data Control : If you press CONTRAST, BRIGHT, COLOR, TINT or SHARP and then VOL key, you can change the value of each key.

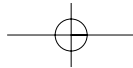

User Guide

CONTRAST



CONTRAST Switch

This control adjusts the contrast of the screen image. Press CONTRAST switch and then VOL(DATA) switch to control the contrast.

SHARPNESS



BRIGHTNESS Switch

This control adjusts the bright of the screen image. Press BRIGHTNESS switch and then VOL(DATA) switch to control the bright.

COLOR



COLOR Switch

This control adjusts the color intensity of the screen image. Press COLOR switch and then VOL(DATA) switch to control the color intensity.

TINT



TINT Switch

With this switch, you can control the color to be close to natural color. For the best result, control screen image with this switch so that skin color is natural. Press TINT switch then VOL(DATA) switch to control the color. (Only NTSC)

BRIGHTNESS



SHARPNESS Switch

This control adjusts the sharpness of the screen image. Press SHARPNESS switch and then VOL(DATA) switch to control the sharpness.

LANGUAGE



LANGUAGE Switch

Press this switch to select language.

You can select the language in following order :
English –Germany – France–Chinese–Spain – Italy
(SMC-213/SMC-214)(depending on the model)

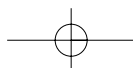

Settings Range of Each Button

MENU	Settings Range	Explanation
Contrast	0~100	To select a specific Contrast within the setting range.
Brightness	0~100	To select a specific Brightness within the setting range.
Sharpness	0~100	To select a specific Sharpness within the setting range.
Color	0~100	To select a specific Color within the setting range.
Tint (NTSC)	Red 0~100 Green 0~100	To select specific Tint within the setting range.
Language	6	English-Germany- France-Chinese- Spain - Italy



Adjusting Settings of Menus : Contrast, Brightness, Sharpness, Color, and Tint(NTSC), with ◀ VOL ▶ button.

- Select each Menu and then press ◀ VOL ▶ button.
- A bar with which settings of the selected menu can be adjusted will be displayd.
- Pressing ◀ VOL button decrease setting of the menu.
- Pressing VOL ▶ button increase setting of the menu.

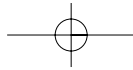

User Guide

Preset	Default setting
Contrast	50
Brightness	50
Sharpness	50
Color	50
Tint (NTSC)	Green 50, Red 50
Language	English

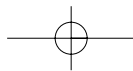

Front Panel Components and Controls (SMC-214)

Using buttons on the front panel

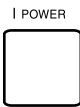
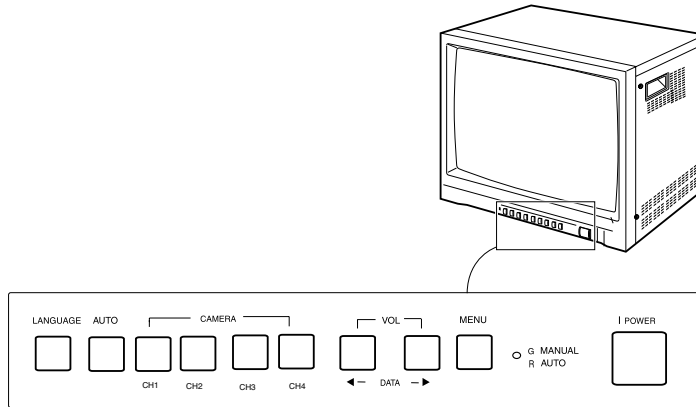

Power Switch

On/Off switch. If you press this button, the monitor is turned on and the LED of selected input signal is lit.

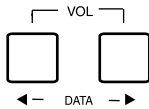

VOL, DATA Control Switch

VOL key has two functions :

- Vol Control : To change vol, press only this key.
- Data Control: If you press this key, you can change the value of each key.



AUTO: If you press this key , you can automatically change the channel. There are four channels on the Frant Panel CH1 ,CH2 ,CH3 ,CH4, The four channels can connect the Camera.

User Guide

Structure of the Setup Menu

ADJUST	→	Contrast	:	50
	→	Brightness	:	50
	→	Sharpness	:	50
	→	Colour	:	50
	→	Tint	:	G 50 R 50
	→	Colour Tone	:	Cool 1 /Cool2 /Normal/Warm1/Warm2
	→	Reset	▶	
	→	Return	▶	

Dwell time	→	Ch1	:	3 Sec (0 ~ 3 0)
	→	Ch2	:	3 Sec (0 ~ 3 0)
	→	Ch3	:	3 Sec (0 ~ 3 0)
	→	Ch4	:	3 Sec (0 ~ 3 0)
	→	Return	▶	

OSD Setting	→	Ch OSD	:	On/Off
	→	Auto OSD	:	On/Off
	→	No Input OSD	:	On/Off
	→	Return	▶	

Digital NR	:	On/Off
Melody	:	On/Off

When you press the MENU key , you will enter this choose

If you want to adjust every function in MENU, please press ◀VOL ▶

- Choose the MENU and then press ◀VOL ▶
- If you want to turn down the setting of function of the MENU, please press ◀VOL
- If you want to turn up the setting of function of the MENU, please pressVOL ▶

Rear Panel Components and Controls

SMC-213

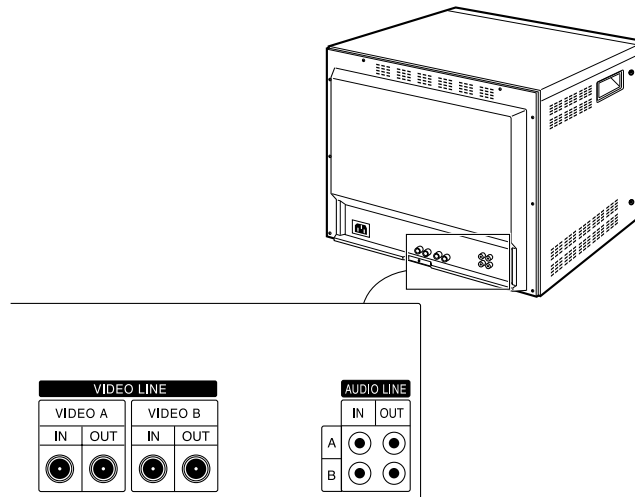

VIDEO A (IN) / VIDEO B (IN)

This is connector for inputting Video signals.

VIDEO A (OUT) / VIDEO B (OUT)

This is connector for outputting Video signal.

AUDIO A (IN) / AUDIO B (IN)

This is connector for inputting audio signal.

AUDIO A (OUT) / AUDIO B (OUT)

This is connector for outputting audio signal.

Rear Panel Components and Controls

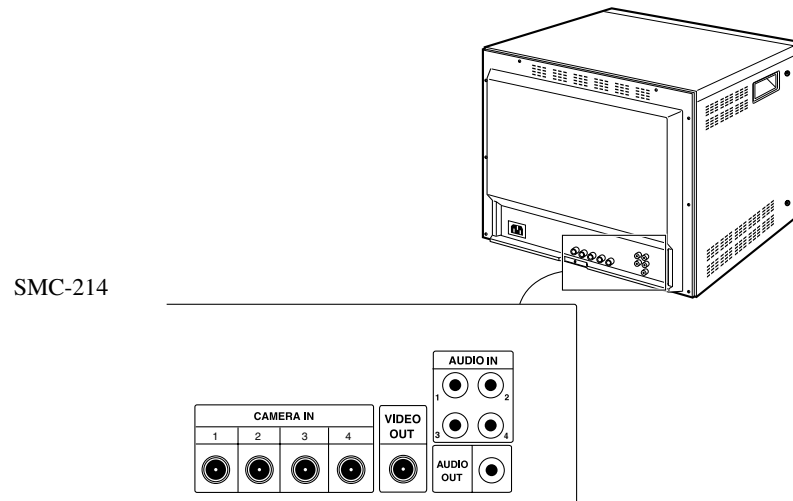

AUDIO 1~4

This is connector for inputting AUDIO signal.

AUDIO OUT

This is connector for outputting AUDIO signal.

CAMERA IN 1~4

This is connector for inputting VIDEO signal.

VIDEO OUT

This is connector for outputting VIDEO signal.

Connections

SMC-213

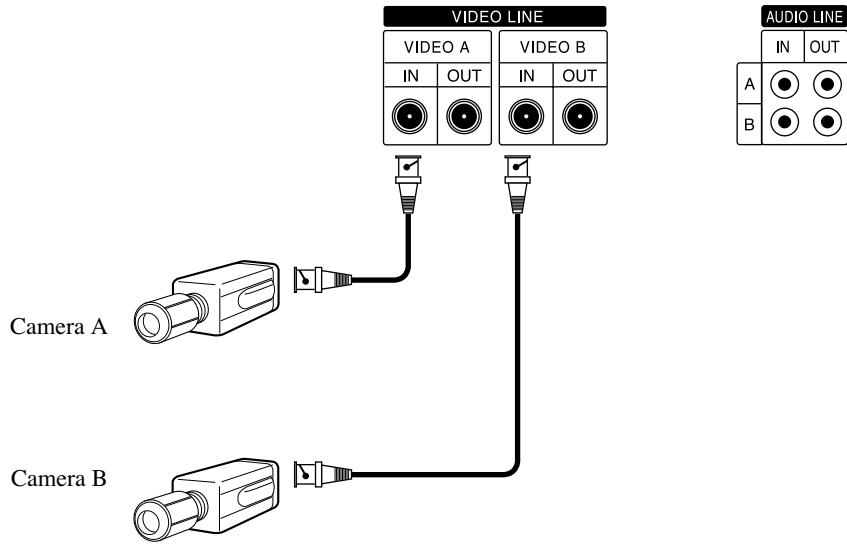

SMC-214

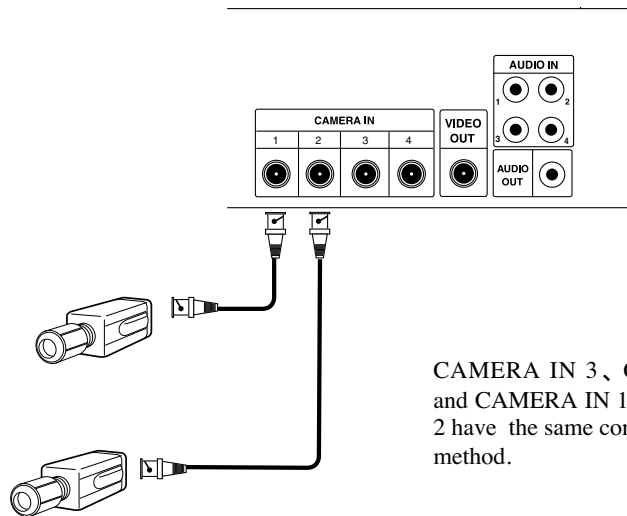

CAMERA IN 3、CAMERA IN 4
and CAMERA IN 1、CAMERA IN
2 have the same connection
method.

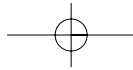

Maintenance

If the quality of the picture on the COLOR MONITOR is poor and cannot be improved, inspect all system connections and cable runs. Repairs should be performed by a qualified technician with adequate test equipment and facilities.

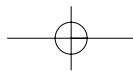

Specifications

System	SMC-213 / SMC-214 (NTSC/PAL)
CRT	21" diagonal, 0.7stripe pitch, 90° deflection
Video In/Out	2 Channel Input/2 Channel Ouput(SMC-213) 4 Channel Input/1 Channel Ouput(SMC-214)
Audio In/Out	2 Channel Input/2 Channel Ouput(SMC-213) 4 Channel Input/1 Channel Ouput(SMC-214)
Power Source	Control range of main section 110V~220V or "Indicated on the rear of the MONITOR set"
Power Consumption	90Watts (max)
Dimensions (W x D x H)	490mm x 325.7mm x467mm (without packing)
Weight	25Kg (about)
Video System	Multiple system (NTSC/PAL)
Horizontal Stabilization	Pull in Range $\pm 500\text{Hz}$ Holding Range $\pm 500\text{Hz}$
Vertical Stabilization	Pull in Range $\pm 4\text{Hz}$ Holding Range $\pm 4\text{Hz}$
Sub Carrier Stabilization	Pull in Range $\pm 400\text{Hz}$ Holding Range $\pm 400\text{Hz}$
Audio	1.5Watts
Convergence	Less than 0.5mm Max (Center)
Overscan	10%
Operating Temperature	-10°C ~ +50°C
Operating Humidity	10 ~ 90% (Non-condensing)

E

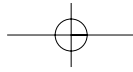

AB68-00653B

