

# Always there to help you

Register your product and get support at  
[www.philips.com/support](http://www.philips.com/support)



BT1300



## User manual

# PHILIPS



# Contents

---

<b>1</b>	<b>Important</b>	<b>2</b>
----------	------------------	----------

---

<b>2</b>	<b>Your Bluetooth speaker</b>	<b>3</b>
	Introduction	3
	What's in the box	3
	Overview of the speaker	4

---

<b>3</b>	<b>Get started</b>	<b>5</b>
	Attach the string	5
	Charge the built-in battery	5
	Turn on/off	5

---

<b>4</b>	<b>Play</b>	<b>6</b>
	Use Bluetooth devices	6
	Play from external devices	7
	Adjust volume	7

---

<b>5</b>	<b>Product information</b>	<b>8</b>
	Specifications	8

---

<b>6</b>	<b>Troubleshooting</b>	<b>9</b>
	General	9
	About Bluetooth device	9

---

<b>7</b>	<b>Notice</b>	<b>10</b>
	Compliance	10
	Care of the environment	10
	Trademark notice	11

# 1 Important



## Warning

- Never remove the casing of this speaker.
  - Never lubricate any part of this speaker.
  - Never place this speaker on other electrical equipment.
  - Keep this speaker away from direct sunlight, naked flames or heat.
- 
- Make sure that there is enough free space around the speaker for ventilation.
  - Only use attachments or accessories specified by the manufacturer.
  - The battery shall not be exposed to excessive heat such as sunshine, fire or the like.
  - The speaker shall not be exposed to dripping or splashing.
  - Do not place any sources of danger on the speaker (e.g. liquid filled objects, lighted candles).



## Note

- The type plate is located on the back of the product.

## 2 Your Bluetooth speaker

Congratulations on your purchase, and welcome to Philips! To fully benefit from the support that Philips offers, register your product at [www.philips.com/welcome](http://www.philips.com/welcome).

---

### Introduction

With this speaker, you can enjoy audio from your Bluetooth-enabled devices, or other external audio devices.

---

### What's in the box

Check and identify the contents of your package:

- Speaker
- USB cable for charging
- String for carrying
- Short user manual
- Safety and notice leaflet

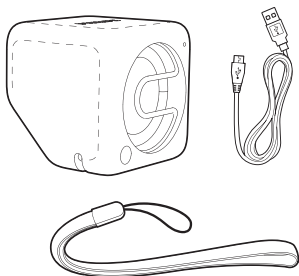

## Overview of the speaker

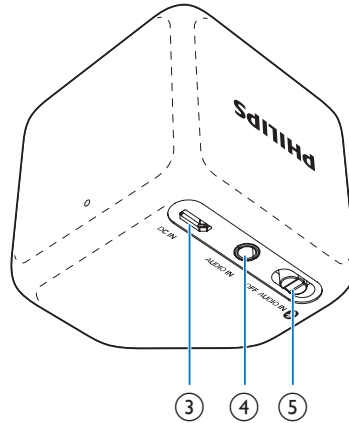
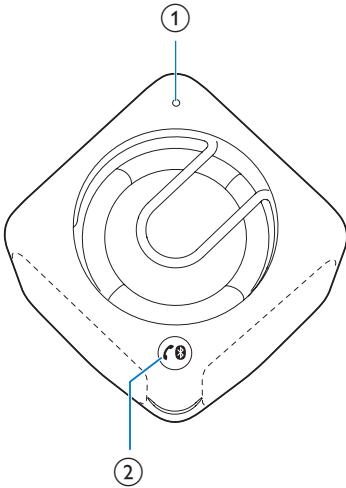

① LED indicator

② 

- Disconnect Bluetooth connection.
- Enter Bluetooth pairing mode.
- Answer or reject an incoming call.
- End the current phone call.
- Transfer the call to your mobile device.

③ DC IN

- Recharge the built-in battery with a USB cable.

④ AUDIO IN

- Connect an external audio device.

⑤ OFF/AUDIO IN/ 

- Select Bluetooth or AUDIO IN source.
- Turn the speaker off.

# 3 Get started

Always follow the instructions in this chapter in sequence.

## Attach the string

For easy carrying, attach the supplied string to this speaker as illustrated.

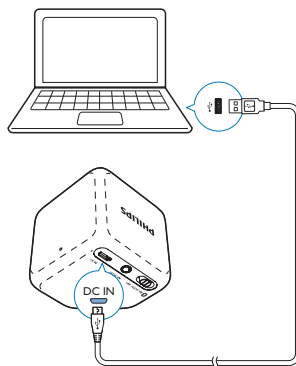
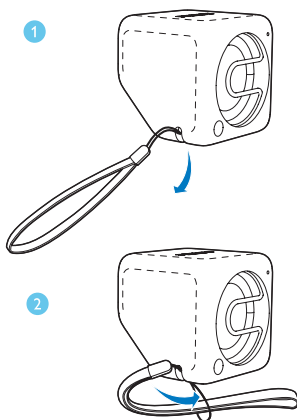

## Charging indicator status

The LED indicator indicates the battery status.

	Under charging	Fully charged
"OFF" mode	Flashing white	Off
"AUDIO IN" mode	Flashing white	Solid white
"Bluetooth" mode	Flashing blue or solid blue (depending on Bluetooth connection status)	Flashing blue or solid blue (depending on Bluetooth connection status)

## Charge the built-in battery

The speaker is powered by a built-in rechargeable battery.

### Note

- Before use, fully charge the built-in battery.
- The micro USB socket is for charging only.
- Rechargeable battery has a limited number of charge cycles. Battery life and number of charge cycles vary by use and settings.

Connect the supplied USB cable between

- the **DC IN** socket on the speaker; and
- a USB socket of a computer.

## Turn on/off

- To turn the speaker on, slide the **OFF/AUDIO IN/** switch to **0** or **AUDIO IN**.
  - **0**: Listen to an external Bluetooth device through Bluetooth connection.
  - **AUDIO IN**: Listen to an external device through an audio input cable.
- To turn the speaker off, slide the switch to **OFF**.

# 4 Play



## Use Bluetooth devices

With this speaker, you can listen to audio from Bluetooth-enabled devices and control the incoming call through Bluetooth.

### Play from Bluetooth devices

#### Note

- Make sure that your Bluetooth device is compatible with this speaker.
- Before pairing a device with this speaker, read its user manual for Bluetooth compatibility.
- The speaker can memorize a maximum of 4 paired devices.
- Make sure that Bluetooth function is enabled on your device, and your device is set as visible to all other Bluetooth devices.
- Any obstacle between this speaker and a Bluetooth device can reduce the operational range.
- Keep away from any other electronic device that may cause interference.
- The operational range between this speaker and a Bluetooth device is approximately 10 meters (30 feet).
- If there is an incoming call on the connected mobile phone, music playback pauses.

- 1 Slide the **OFF /AUDIO IN/**  switch to .  
↳ The LED indicator flashes blue.
- 2 On your Bluetooth device, enable Bluetooth and search for Bluetooth devices that can be paired (refer to the user manual of the device).
- 3 When [**Philips BT1300**] is displayed on your device, select it to start pairing and connection. If necessary, input "0000" as the pairing password.  
↳ After successful pairing and connection, the speaker beeps twice, and the LED indicator turns solid blue.
- 4 Play audio on the Bluetooth device.  
↳ Audio streams from your Bluetooth device to the speaker:

#### To disconnect the Bluetooth-enabled device:

- Press and hold  for two seconds;
- Disable Bluetooth on your device; or
- Move the device beyond the communication range.  
↳ The LED indicator flashes blue.

#### To reconnect the Bluetooth device:

- Next time you turn on the speaker, the speaker will reconnect the last connected device automatically; or
- On your Bluetooth device, select "**Philips BT1300**" on your Bluetooth menu to start pairing.





#### To connect another Bluetooth-enabled device:

- 1 Press and hold  for two seconds to disconnect the currently connected device;  
↳ The speaker enters Bluetooth pairing mode.
- 2 Connect another Bluetooth device.

LED indicator	Description
Flashing blue	Connecting; Waiting for pairing
Solid blue	Connected

## Control your phone call

After Bluetooth connection, you can control an incoming call with this speaker:

Button	Function
	Press to answer an incoming call.
	Press and hold to reject an incoming call.
	During a call, press to end the current call.
	During a call, press and hold to transfer the call to your mobile device.

#### Note

- Music play pauses when there is an incoming call, and resumes when your phone call ends.



---

## Play from external devices

With this speaker, you can also listen to an external audio device such as an MP3 player.

- 1 Connect an audio input cable (not supplied) with a 3.5 mm connector on both ends to
  - the **AUDIO IN** socket on this speaker, and
  - the headphone socket on the external device.

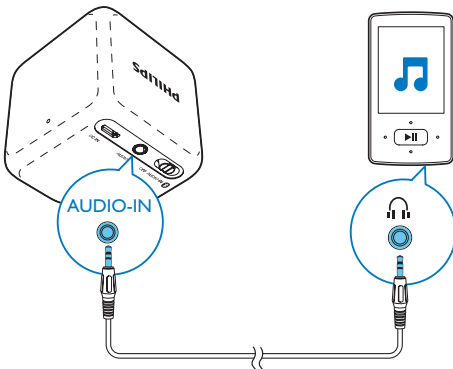

- 2 Slide the **OFF /AUDIO IN/** switch to **AUDIO IN**.  
↳ The LED indicator becomes white.
- 3 Play audio on the external device (refer to its user manual).

---

## Adjust volume

During play, use the volume control on your Bluetooth or external device to adjust volume.

# 5 Product information



## Note

- Product information is subject to change without prior notice.

## General information

Power Supply (through USB socket)	5 V $\pm$ 0.5 A
Built-in Battery	Li-polymer battery (3.7V, 500 mAh)
Dimensions - Main Unit (W x H x D)	55 x 55 x 55 mm
Weight - Main Unit	0.1 kg

## Specifications

### Amplifier

Rated Output Power	2 W RMS
Frequency Response	80 -16000 Hz, $\pm$ 3 dB
Signal to Noise Ratio	>70 dBA
Audio-in Input	300 mV RMS

### Speakers

Speaker Impedance	4 ohm
Speaker Driver	4.5 cm full range
Sensitivity	>81dB/m/W $\pm$ 3dB/ m/W

### Bluetooth

Bluetooth Version	V3.0
Bluetooth Profile	HFP, HSP, A2DP
Bluetooth Frequency	2.4 GHz ~ 2.48 GHz
Brand	
Bluetooth Range	10 m (Free space)

# 6 Troubleshooting



## Warning

- Never remove the casing of this device.

To keep the warranty valid, never try to repair the system yourself.

If you encounter problems when using this device, check the following points before requesting service. If the problem remains unsolved, go to the Philips Web page ([www.philips.com/support](http://www.philips.com/support)). When you contact Philips, make sure that the device is nearby and the model number and serial number are available.

---

## General

### No power

- Recharge your speaker.

### No sound or poor sound

- Adjust volume on the connected device.

### No response from the speaker

- Restart the speaker.

---

## About Bluetooth device

### The audio quality is poor after connection with a Bluetooth-enabled device.

- The Bluetooth reception is poor. Move the device closer to this product or remove any obstacle between them.

### Cannot connect with the device.

- The Bluetooth function of the device is not enabled. Refer to the user manual of the device for how to enable the function.
- This product is already connected with another Bluetooth-enabled device. Disconnect that device and then try again.

### Fail to search out BT1300 on your device for pairing.

- Press and hold  for three seconds, and then try again.

### The paired device connects and disconnects constantly.

- The Bluetooth reception is poor. Move the device closer to this product or remove any obstacle between them.
- For some devices, Bluetooth connection may be deactivated automatically as a power-saving feature. This does not indicate any malfunction of this product.

# 7 Notice

Any changes or modifications made to this device that are not expressly approved by WOOX Innovations may void the user's authority to operate the equipment.

## Compliance

# CE 0700

Hereby, WOOX Innovations declares that this product is in compliance with the essential requirements and other relevant provisions of Directive 1999/5/EC. You can find the Declaration of Conformity on [www.philips.com/support](http://www.philips.com/support).

## Care of the environment

### Disposal of your old product and battery



Your product is designed and manufactured with high quality materials and components, which can be recycled and reused.



This symbol on a product means that the product is covered by European Directive 2012/19/EU.



This symbol means that the product contains a built-in rechargeable battery covered by European Directive 2013/56/EU which cannot

be disposed of with normal household waste. We strongly advise you to take your product to an official collection point or a Philips service centre to have a professional remove the rechargeable battery.

Inform yourself about the local separate collection system for electrical and electronic products and rechargeable batteries. Follow local rules and never dispose of the product and rechargeable batteries with normal household waste. Correct disposal of old products and rechargeable batteries helps prevent negative consequences for the environment and human health.

### ! Caution

- Removal of the built-in battery invalidates the warranty and may destroy the product.

Always bring your product to a professional to remove the built-in battery.

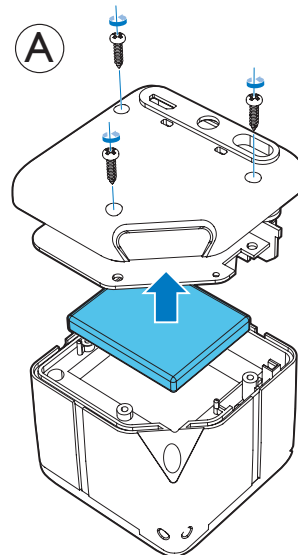

### Environmental information

All unnecessary packaging has been omitted. We have tried to make the packaging easy to separate into three materials: cardboard (box),

polystyrene foam (buffer) and polyethylene (bags, protective foam sheet.)

Your system consists of materials which can be recycled and reused if disassembled by a specialized company. Please observe the local regulations regarding the disposal of packaging materials, exhausted batteries and old equipment.

---

## Trademark notice



The Bluetooth® word mark and logos are registered trademarks owned by Bluetooth SIG, Inc. and any use of such marks by WOOX Innovations is under license.



2014 © WOOX Innovations Limited. All rights reserved.

Philips and the Philips' Shield Emblem are registered trademarks of Koninklijke Philips N.V. and are used by WOOX Innovations Limited under license from Koninklijke Philips N.V.

BT1300\_00\_UM\_V2.0

