



FOR PERFECT RESULTS

Thank you for choosing this AEG product. We have created it to give you impeccable performance for many years, with innovative technologies that help make life simpler – features you might not find on ordinary appliances. Please spend a few minutes reading to get the very best from it.

ACCESSORIES AND CONSUMABLES

In the AEG webshop, you'll find everything you need to keep all your AEG appliances looking spotless and working perfectly. Along with a wide range of accessories designed and built to the high quality standards you would expect, from specialist cookware to cutlery baskets, from bottle holders to delicate laundry bags...

Visit the webshop at
www.aeg-electrolux.com/shop



CONTENTS

- 3 Important safety instructions
- 7 Appliance overview
- 8 Before first use
- 10 Microwave cooking advice
- 12 Microwave operation
- 18 Programme charts
- 22 Recipes
- 26 Care & cleaning
- 27 What to do if . . .
- 27 Specifications
- 28 Installation
- 31 Environmental information
- 32 Service & spare parts
- 33 Guarantee conditions



Important information concerning your safety or the operation of your appliance is noted by this symbol and/or mentions words such as «Warning», «Take care». Be sure to follow all instructions carefully.



This symbol indicates further information concerning the use of the appliance.



The clover indicates energy-saving tips and hints for environmentally friendly use of your appliance.

In the event of malfunctioning, please follow the instructions given in the section «What to do if...»



IMPORTANT SAFETY INSTRUCTIONS

Important safety instructions: Read carefully and keep for future reference

To avoid the danger of fire

The microwave oven should not be left unattended during operation. Power levels that are too high or cooking times that are too long may overheat foods resulting in a fire.

The electrical outlet must be readily accessible so that the unit can be unplugged easily in an emergency.

Do not store or use the oven outdoors.

If food being heated begins to smoke, DO NOT OPEN THE DOOR. Turn off and unplug the oven and wait until the food has stopped smoking. Opening the door while food is smoking may cause a fire.

Only use microwave-safe containers and utensils.

Do not leave the oven unattended when using disposable plastic, paper or other combustible food containers.

Clean the waveguide cover, the oven cavity, the turntable and turntable support after use. These must be dry and free from grease. Built-up grease may overheat and begin to smoke or catch fire.

Do not place flammable materials near the oven or ventilation openings. Do not block the ventilation openings.

Remove all metallic seals, wire twists, etc., from food and food packages. Arcing on metallic surfaces may cause a fire.

Do not use the microwave oven to heat oil for deep frying. The temperature cannot be controlled and the oil may catch fire.

To make popcorn, only use special microwave popcorn makers.

Do not store food or any other items inside the oven.

Check the settings after you start the oven to ensure the oven is operating as desired.

See the corresponding hints in this operation manual.

To avoid the possibility of injury



Warning!

Do not operate the oven if it is damaged or malfunctioning. Check the following before use:

- a) The door; make sure the door closes properly and ensure it is not misaligned or warped.
- b) The hinges and door safety latches; check to make sure they are not broken or loose.
- c) The door seals and sealing surfaces; ensure that they have not been damaged.
- d) Inside the oven cavity or on the door; make sure there are no dents.
- e) The power supply cord and plug; ensure that they are not damaged.

Never adjust, repair or modify the oven yourself. It is hazardous for anyone other than a competent person to carry out any service or repair operation which involves the removal of a cover which gives protection against exposure to microwave energy.

Do not operate the oven with the door open or alter the door safety latches in any way. Do not operate the oven if there is an object between the door seals and sealing surfaces.

Do not allow grease or dirt to build up on the door seals and adjacent parts. Follow instructions for "Care & cleaning". Failure to maintain the oven in a clean condition could lead to a deterioration of the surface that could adversely affect the life of the appliance and possibly result in a hazardous situation.

Individuals with PACEMAKERS should check with their doctor or the manufacturer of the pacemaker for precautions regarding microwave ovens.

To avoid the possibility of electric shock

Under no circumstances should you remove the outer cabinet.

Never spill or insert any objects into the door lock openings or ventilation openings. In the event of a spill, turn off and unplug the oven immediately and call your local Service Force Centre.

Do not immerse the power supply cord or plug in water or any other liquid.

Do not allow the power supply cord to run over any hot or sharp surfaces, such as the hot air vent area at the top rear of the oven.

Do not attempt to replace the oven lamp yourself or allow anyone who is not authorised by Service Force to do so. If the oven lamp fails, please consult your dealer or contact your local Service Force Centre.

If the power supply cord of this appliance is damaged, it must be replaced with a special cord. The exchange must be made by an authorised Service Force technician.

To avoid the possibility of explosion and sudden boiling:



Warning!

Liquids and other foods must not be heated in sealed containers since they are liable to explode.

Never use sealed containers. Remove seals and lids before use. Sealed containers can explode due to a build up of pressure even after the oven has been turned off.

Take care when microwaving liquids. Use a wide-mouthed container to allow bubbles to escape.

Microwave heating of beverages can result in delayed eruptive boiling, therefore care has to be taken when handling the container.

To prevent sudden eruption of boiling liquid and possible scalding:

1. Stir liquid prior to heating/reheating.
2. It is advisable to insert a glass rod or similar utensil into the liquid whilst reheating.
3. Let liquid stand for at least 20 seconds in the oven at the end of cooking time to prevent delayed eruptive boiling.

Do not cook eggs in their shells, and whole hard boiled eggs should not be heated in microwave ovens since they may explode even after microwave cooking has ended. To cook or reheat eggs which have not been scrambled or mixed, pierce the yolks and the whites, or the eggs may explode. Shell and slice hard boiled eggs before reheating them in the microwave oven.

Pierce the skin of such foods as potatoes, sausages and fruit before cooking, or they may explode.

To avoid the possibility of burns

Use pot holders or oven gloves when removing food from the oven to prevent burns.

Always open containers, popcorn makers, oven cooking bags, etc., away from the face and hands to avoid steam burns.

To avoid burns, always test food temperature and stir before serving and pay special attention to the temperature of food and drink given to babies, children or the elderly.

Temperature of the container is not a true indication of the temperature of the food or drink; always check the food temperature.

Always stand back from the oven door when opening to avoid burns from escaping steam and heat.

Slice stuffed baked foods after heating to release steam and avoid burns.

Keep children away from the door to prevent them burning themselves.

To avoid misuse by children



Warning:

Only allow children to use the oven without supervision when adequate instructions have been given so that the child is able to use the oven in a safe way and understands the hazards of improper use.

This appliance is not intended for use by persons (including children) with reduced physical, sensory or mental capabilities, or lack of experience and knowledge, unless they have been given supervision or instruction concerning use of the appliance by a person responsible for their safety.

Children should be supervised to ensure that they do not play with the appliance.

Do not lean or swing on the oven door. Do not play with the oven or use it as a toy.

Children should be taught all important safety instructions: use of pot holders, careful removal of food coverings; paying special attention to packaging (e.g. self-heating materials) designed to make food crisp, as they may be extra hot.

Other warnings



Never modify the oven in any way.

This oven is for home food preparation only and may only be used for cooking food. It is not suitable for commercial or laboratory use.

To promote trouble-free use of your oven and avoid damage

Never operate the oven when it is empty.

When using a browning dish or self-heating material, always place a heat-resistant insulator such as a porcelain plate under it to prevent damage to the turntable and turntable support due to heat stress. The preheating time specified in the dish's instructions must not be exceeded.

Do not use metal utensils, which reflect microwaves and may cause electrical arcing. Do not put cans in the oven.

Only use the turntable and the turntable support designed for this oven. Do not operate the oven without the turntable.

To prevent the turntable from breaking:

- a) Before cleaning the turntable with water, leave the turntable to cool.
- b) Do not put hot foods or hot utensils on a cold turntable.
- c) Do not put cold foods or cold utensils on a hot turntable.

Do not place anything on the outer cabinet during operation.

Important:

If you are unsure how to connect your oven, please consult an authorised, qualified electrician.

Neither the manufacturer nor the dealer can accept any liability for damage to the oven or personal injury resulting from failure to observe the correct electrical connection procedure. Water vapour or drops may occasionally form on the oven walls or around the door seals and sealing surfaces. This is a normal occurrence and is not an indication of microwave leakage or a malfunction.

APPLIANCE OVERVIEW

Microwave oven & accessories

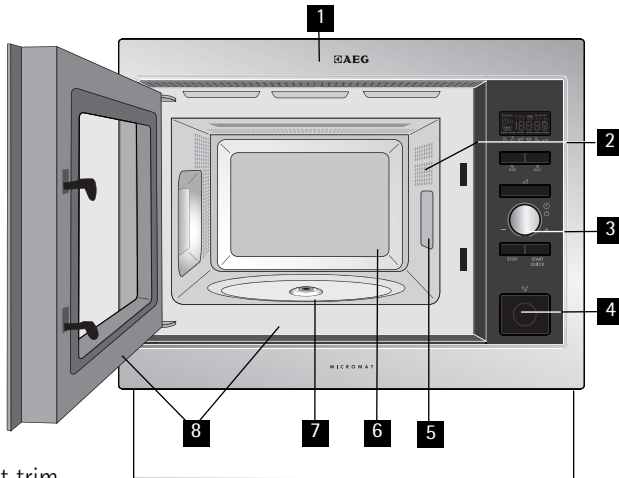

- 1 Front trim
- 2 Oven lamp
- 3 Control panel
- 4 Door opening button
- 5 Waveguide cover
- 6 Oven cavity
- 7 Seal packing
- 8 Door seals and sealing surfaces

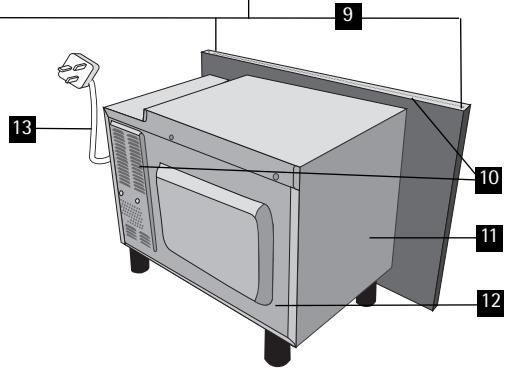

- 9 Fixing points (4 points)
- 10 Ventilation openings
- 11 Outer cover
- 12 Rear cabinet
- 13 Power supply cord

Check to make sure the following accessories are provided:

- 1 Turntable
- 2 Turntable support
- 3 4 fixing screws (not shown)

- Place the turntable support in the seal packing on the floor of the cavity.
- Then place the turntable on the turntable support.
- To avoid turntable damage, ensure dishes or containers are lifted clear of the turntable rim when removing them from the oven.

Important:

When you order accessories, please mention two items: part name and model name to your dealer or local Service Force Centre.

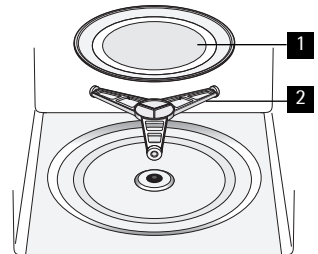

Control panel

1 Digital display indicators



Microwave



Auto defrost bread



Clock



Auto defrost



Cooking stages



Weight



Plus/Minus

2 AUTO COOK indicators

3 AUTO COOK button

4 AUTO DEFROST button

5 POWER LEVEL button

6 TIMER/WEIGHT knob

7 START/QUICK button

8 STOP button

9 DOOR OPENING button

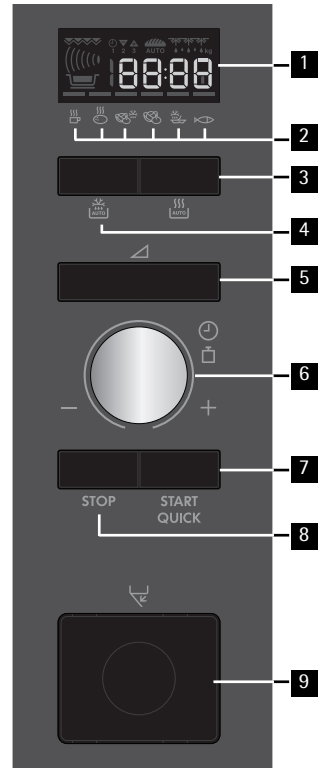

BEFORE FIRST USE

Setting the clock

The oven has a 12 and 24 hour clock.

Example: To set the clock to 11:30 (12 hour clock).

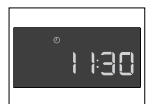

1. Plug in the oven.
2. The display will show:  .
3. Rotate the TIMER/WEIGHT knob to adjust the hour.
4. Press the START/QUICK button once then rotate the TIMER/WEIGHT knob to adjust the minutes.
5. Press the START/QUICK button.
6. Check the display:



Important:

1. You can rotate the TIMER/WEIGHT knob clockwise or anti-clockwise.
2. If you touch the stop key the time will be automatically set to  .

Example: To set the clock to 23:30 (24 hour clock).

1. Plug in the oven.
2. The display will show:  .
3. Press the START/QUICK button. The display will show:  .
4. Rotate the TIMER/WEIGHT knob to adjust the hour.
5. Press the START/QUICK button once then rotate the TIMER/WEIGHT knob to adjust the minutes.
6. Press the START/QUICK button.
7. Check the display:

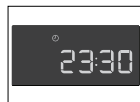

Important:

1. You can rotate the TIMER/WEIGHT knob clockwise or anti-clockwise.
2. If you touch the stop key the time will be automatically set to  .

Adjusting the time when the clock is set

Example: To set the clock to 11:45 (12 hour clock).

1. Open the door.
2. Press and hold the START/QUICK button for 5 seconds. The oven will beep. Rotate the TIMER/WEIGHT knob to adjust the hour.
3. Press the START/QUICK button once then rotate the TIMER/WEIGHT knob to adjust the minutes.
4. Press the START/QUICK button once.
5. Check the display:

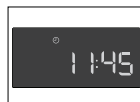

Example: To set the clock to 23:45 (24 hour clock).

1. Open the door.
2. Press and hold the START/QUICK button for 5 seconds. The oven will beep. Rotate the TIMER/WEIGHT knob to adjust the hour.
3. Press the START/QUICK button once then rotate the TIMER/WEIGHT knob to adjust the minutes.
4. Press the START/QUICK button once.
5. Check the display:



Example: To change the clock from 12H to 24 H or 24H to 12H.

1. Open the door. Press and hold the START/QUICK button for 5 seconds. The oven will beep. Press the START/QUICK button once then rotate the TIMER/WEIGHT knob to adjust the hour.

Using the STOP button

Use the STOP button to:

1. Erase a mistake during programming.
2. Stop the oven temporarily during cooking, press once.
3. Cancel a programme during cooking, touch twice.

Child safety lock

The oven has a safety feature which prevents the accidental running of the oven by a child. When the lock has been set, no part of the microwave will operate until the lock feature has been cancelled.

Example: To set the child safety lock.

1. Press and hold the stop button for 5 seconds.



The oven will beep twice and 'LOC' will be displayed:



Note:

- To cancel the child safety lock, press and hold the stop button for 5 seconds, the oven will beep twice and the time of day will be displayed.
- Child safety lock cannot be set if the clock is not set.

MICROWAVE COOKING ADVICE

Microwave cooking

To cook/defrost food in a microwave oven, the microwave energy must be able to pass through the container to penetrate the food. Therefore it is important to choose suitable cookware.

Round/oval dishes are preferable to square/oblong ones as the food in the corners tends to overcook.

It is important to turn, rearrange or stir food to ensure even heating.

Standing time is necessary after cooking as it enables the heat to disperse equally throughout the food.

Food characteristics	
Composition	Foods high in fat or sugar (e.g. Christmas pudding, mince pies) require less heating time. Care should be taken as overheating can lead to fire.
Density	Food density will affect the amount of cooking time needed. Light porous foods, such as cakes or bread, cook more quickly than heavy, dense foods, such as roasts and casseroles.
Quantity	The cooking time must be increased as the amount of food placed in the oven increases. E.g. four potatoes will take longer to cook than two.
Size	Small foods and small pieces cook faster than large ones, as microwaves can penetrate from all sides to the centre. For even cooking make all the pieces the same size.
Shape	Foods which are irregular in shape, such as chicken breasts or drumsticks, take longer to cook in the thicker parts. Round shapes cook more evenly than square shapes when microwave cooking.
Temperature of food	The initial temperature of food affects the amount of cooking time needed. Chilled foods will take longer to cook than food at room temperature. Cut into foods with fillings, e.g. jam doughnuts, to release heat or steam.

Cooking techniques	
Arrange	Place the thickest parts of food towards the outside of the dish. E.g. Chicken drumsticks.
Cover	Use vented microwave cling film or a suitable lid.
Pierce	Foods with a shell, skin or membrane must be pierced in several places before cooking or reheating as steam will build up and may cause food to explode, e.g. Potatoes, Fish, Chicken, Sausages. Important: Eggs should not be heated using microwave power as they may explode, even after cooking has ended, e.g. poached, hard boiled.
Stir, turn and rearrange	For even cooking it is essential to stir, turn and rearrange food during cooking. Always stir and rearrange from the outside towards the centre.
Stand	Standing time is necessary after cooking to enable the heat to disperse equally throughout the food.
Shield	Some areas of food being defrosted may become warm. Warm areas can be shielded with small pieces of foil, which reflect microwaves, e.g. legs and wings on a chicken.

Microwave safe cookware

Cookware	Microwave safe	Comments
Aluminium foil / foil containers	✓/✗	Small pieces of aluminium foil can be used to shield food from overheating. Keep foil at least 2 cm from the oven walls, as arcing may occur. Foil containers are not recommended unless specified by the manufacturer, e.g. Microfoil®, follow instructions carefully.
Browning dishes	✓	Always follow the manufacturers instructions. Do not exceed heating times given. Be very careful as these dishes become very hot.
China and ceramics	✓/✗	Porcelain, pottery, glazed earthenware and bone china are usually suitable, except for those with metallic decoration.
Glassware e.g. Pyrex®	✓	Care should be taken if using fine glassware as it can break or crack if heated suddenly.
Metal	✗	It is not recommended to use metal cookware when using microwave power as it will arc, which can lead to fire.
Plastic / polystyrene e.g. fast food containers	✓	Care must be taken as some containers warp, melt or discolour at high temperatures.
Cling film	✓	Should not touch the food and must be pierced to let the steam escape.
Freezer / roasting bags	✓	Must be pierced to let steam escape. Ensure bags are suitable for microwave use. Do not use plastic or metal ties, as they may melt or catch fire due to the metal arcing.
Paper - plates, cups and kitchen paper	✓	Only use for warming or to absorb moisture. Care must be taken as overheating may cause fire.
Straw and wooden containers	✓	Always attend the oven when using these materials as overheating may cause fire.
Recycled paper and newspaper	✗	May contain extracts of metal which will cause 'arcing' and may lead to fire.

MICROWAVE OPERATION

Microwave cooking

Your oven can be programmed for up to 90 minutes. The input unit of cooking time varies from 10 seconds to five minutes. It depends on the total length of cooking time as shown in the table.

Cooking time	Increasing unit
0-5 minutes	10 seconds
5-10 minutes	30 seconds
10-30 minutes	1 minute
30-90 minutes	5 minutes

Manual defrosting

For manual defrosting (without operating the Auto defrost feature), use 240 W. The defrost symbol appears in the window display whenever the power level is selected.

Microwave power levels

Your oven has 6 power levels:

Power setting	Suggested use
800 W/ HIGH	Used for fast cooking or reheating e.g. soup, casseroles, canned food, hot beverages, vegetables, fish, etc.
560 W	Used for longer cooking of dense foods such as roast joints, meat loaf and plated meals, also for sensitive dishes such as cheese sauce and sponge cakes. At this reduced setting, the sauce will not boil over and food will cook evenly without over cooking at the sides.
400 W	For dense foods which require a long cooking time when cooked conventionally, eg. beef dishes, it is advisable to use this power setting to ensure the meat will be tender.
240 W/ DEFROST	To defrost, select this power setting, to ensure that the dish defrosts evenly. This setting is also ideal for simmering rice, pasta, dumplings and cooking egg custard.
80 W	For gentle defrosting, eg. cream gateaux or pastry.
0 W	For standing/kitchen timer.

W = WATT

Example: To heat soup for 2 minutes and 30 seconds on 560 W microwave power.

1. Press the power level button twice.

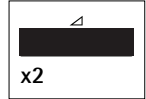

2. Enter the time by rotating the TIMER/WEIGHT knob clockwise/anti-clockwise until 2:30 is displayed.

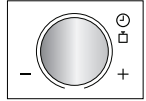

3. Press the START/QUICK button.



4. Check the display:

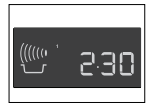

Important:

If the power level is not selected, HIGH/800 W is automatically set.

Note:

- When the door is opened during the cooking process, the cooking time on the digital display stops automatically. The cooking time starts to count down again when the door is closed and the START/QUICK button is pressed.
- If you wish to know the power level during cooking, press the power button once.
- You can increase or decrease the cooking time during cooking by rotating the TIMER/WEIGHT knob.
- You can change the power level during cooking by pressing the power button.
- To cancel a programme during cooking touch the STOP button twice.

Kitchen timer

Example: To set the kitchen timer for 7 minutes.

1. Press the power level button 7 times.

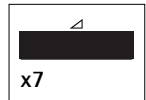

2. Enter the time by rotating the TIMER/WEIGHT knob clockwise/anti-clockwise until 7:00 is displayed.

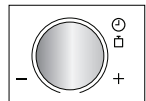

3. Press the START/QUICK button.

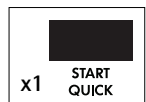

4. Check the display:



Note:

- To pause the timer, press the STOP button. To resume the timer press START/QUICK, to exit press STOP again.

Add 30 seconds

The START/QUICK button allows you to operate the two following functions:

1. Direct Start

You can directly start cooking on 800 W/HIGH microwave power level for 30 seconds by pressing the START/QUICK button.



2. Extend the cooking time

You can extend the cooking time for multiples of 30 seconds if the button is pressed while the oven is in operation.



Note:

- You cannot use this function during AUTO COOK or AUTO DEFROST.

Plus & minus

The PLUS \triangle and MINUS ∇ function enables you to decrease or increase the cooking time when using the automatic programmes.

If you prefer boiled potatoes which are cooked but still firm, use MINUS ∇ . Alternatively, if you prefer boiled potatoes softer, use PLUS \triangle .

Example: To cook 0.3 kg of boiled potatoes, well done.

- Select the menu required by pressing the AUTO COOK button twice.

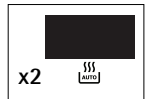

- Turn the TIMER/WEIGHT knob until 0.3 kg is displayed.

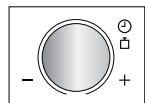

- Press the power button once to select the PLUS \triangle adjustment.

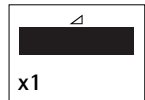

- Press the START/QUICK button.





- Check the display:



Note:

To cancel PLUS / MINUS, press the power level key 3 times.

If you select PLUS the display will show .

If you select MINUS, the display will show .

Multiple sequence cooking

A sequence of 3 stages (maximum) can be programmed using MICROWAVE.

Example: To cook:

5 minutes on 800 W power (Stage 1)

16 minutes on 240 W power (Stage 2)

Stage 1

1. Press the power button once.

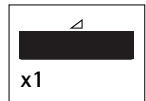

2. Enter the desired time by rotating the TIMER/WEIGHT knob clockwise until 5:00 is displayed.

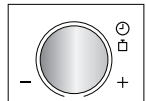

3. Check the display:



Stage 2

1. Press the power button 4 times.

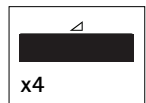

2. Enter the desired cooking time by rotating the TIMER/WEIGHT knob clockwise until 16:00 is displayed.

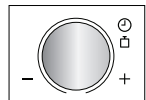

3. Press the START/QUICK button once to begin cooking.

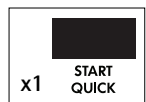

4. Check the display:

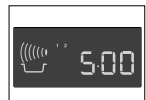







The oven will begin to cook for 5 minutes at 800 W, and then for 16 minutes on 240 W.

Auto cook & auto defrost operation

AUTO COOK and AUTO DEFROST automatically work out the correct cooking mode and cooking time. You can choose from 6 AUTO COOK and 2 AUTO DEFROST menus.

Auto Cook

Food	Symbol
Beverage	
Boiled Potatoes/ Jacket Potatoes	
Frozen Vegetables	
Fresh Vegetables	
Frozen Ready Meals	
Fish Fillet with Sauce	

Example: To cook 0.3 kg of boiled potatoes.

1. Select the menu required by pressing the AUTO COOK button twice.

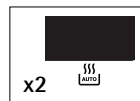

2. Turn the TIMER/WEIGHT knob until 0.3 kg is displayed.

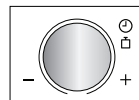

3. Press the START/QUICK button.

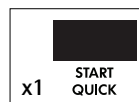



4. Check the display:



When action is required (e.g. to turn food over) the oven stops and the audible bell sounds, remaining cooking time and the indicator will flash on the display. To continue cooking, press the START/QUICK button. At the end of the Auto cook time, the programme will automatically stop. The audible bell sounds and the cooking symbol will flash. After 1 minute and a reminder beep, the time of day will be displayed.

Auto Defrost

Food	Symbol
Meat/Fish/Poultry	
Bread	

Example: To defrost 0.2 kg of bread.



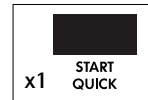
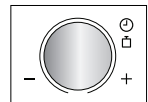









1. Select the menu required by pressing the AUTO DEFROST button twice.
2. Turn the TIMER/WEIGHT knob until 0.2 is displayed.
3. Press the START/QUICK button.
4. Check the display:









When action is required (e.g. to turn food over) the oven stops and the audible bell sounds, remaining cooking time and the indicator will flash on the display. To continue cooking, press the START/QUICK button. At the end of the Auto defrost time, the programme will automatically stop. The audible bell sounds and the cooking symbol will flash. After 1 minute and a reminder beep, the time of day will be displayed.

PROGRAMME CHARTS

Auto cook & auto defrost charts

Auto cook	Weight (increasing unit) / Utensils	Button	Procedure
Beverage (Tea/Coffee) 	1-4 cups 1 cup=200 ml	 x1	<ul style="list-style-type: none"> Place cup towards edge of turntable.
Boiled and jacket potatoes 	0,1 - 0,8 kg (100 g) Bowl and lid	 x2	<p>Boiled Potatoes: Peel the potatoes and cut them into similar sized pieces.</p> <p>Jacket Potatoes: Choose potatoes of similar size and wash them.</p> <ul style="list-style-type: none"> Put the boiled or jacket potatoes into a bowl. Add the required amount of water (per 100 g), approx. 2 tbsp and a little salt. Cover with a lid. When the audible bell sounds, stir and re-cover. After cooking, stand for approx. 2 min.
Frozen vegetables 	0,1 - 0,6 kg (100 g) Bowl and lid	 x3	<ul style="list-style-type: none"> Add 1 tsp water per 100 g and salt as desired. (For mushrooms no additional water is necessary) Cover with lid. When the audible bell sounds, stir and re-cover. After cooking, stand approx. 2 min. <p>Important: If frozen vegetables are compacted together, cook manually.</p>
Fresh vegetables 	0.1 - 0,6 kg (100 g) Bowl and lid	 x4	<ul style="list-style-type: none"> Cut into small pieces, e.g. strips, cubes or slices. Add 1 tbsp water per 100 g and salt as desired. (For mushrooms no additional water is necessary) Cover with a lid. When the audible bell sounds, stir and re-cover. After cooking, stand for approx. 2 min.
Frozen ready meals (stirrable) 	0,3 - 1,0 kg (100 g) Bowl and lid	 x5	<ul style="list-style-type: none"> Transfer meal to suitable microwave-proof dish. Add some liquid if recommended by the manufacturer. Cover with lid. Cook without cover if the manufacturer instructs. When the audible bell sounds, stir and re-cover. After cooking, stir and stand for approx. 2 min.
Fish fillet with sauce 	0,4 kg - 1,2 kg*(100 g) Gratin dish and microwave cling film	 x6	<ul style="list-style-type: none"> See recipes for "Fish fillet with sauce" on page 20. <p>* Total weight of ingredients.</p>

Important: Chilled foods are cooked from 5°C, frozen foods are cooked from -18°C.

Auto defrost	Weight (increasing unit) / Utensils	Button	Procedure
Meat, fish poultry  (Whole fish, fish steaks, fish fillets, chicken legs, chicken breast, minced meat, steak, chops, burgers, sausages)	0,2 - 0,8 kg (100 g) Flan dish	  x1	<ul style="list-style-type: none"> Place the food in a flan dish in the centre of the turntable. When the audible bell sounds, turn the food over, rearrange and separate. Shield thin parts and warm spots with aluminium foil. After defrosting, wrap in aluminium foil for 15-45 min, until thoroughly defrosted. Note: Not suitable for whole poultry. Minced meat: When the audible bell sounds, turn the food over. Remove the defrosted parts if possible.
Bread   AUTO	0,1 - 1,0 kg (100 g) Flan dish	  x2	<ul style="list-style-type: none"> Distribute in a flan dish in the centre of the turntable. For 1,0 kg distribute directly on the turntable. When the audible bell sounds, turn over, rearrange and remove defrosted slices. After defrosting cover in aluminium foil and stand for 5-15 min, until thoroughly defrosted.

Important: Chilled foods are cooked from 5°C, frozen foods are cooked from -18°C.

Note:

- Enter the weight of the food only. Do not include the weight of the container.
- For food weighing more or less than weights/quantities given in the Auto cook & defrost charts, use manual operation.
- The final temperature will vary according to the initial temperature. Check food is piping hot after cooking.
- When action is required (e.g. to turn food over) the oven stops and the audible bell sounds, remaining cooking time and the indicator will flash on the display. To continue cooking, press the START/QUICK button.
- After microwave mode the cooling fan may come on.

Note: Auto defrost

- Steaks and Chops should be frozen in one layer.
- Minced meat should be frozen in a thin shape.
- After turning over, shield the defrosted portions with small, flat pieces of aluminium foil.
- The poultry should be processed immediately after defrosting.

Recipes for auto cook

Fish fillet with piquant sauce

1. Mix ingredients for the sauce.
2. Place the fish fillet in a round gratin dish with the thin ends toward the centre and sprinkle with salt.
3. Spread the sauce on the fish fillet.
4. Cover with microwave cling film and cook on AUTO COOK, "Fish fillet with sauce".
5. After cooking, stand for approx. 2 min.

0,4 kg	0,8 kg	1,2 kg	
140 g	280 g	420 g	canned tomatoes (drained)
40 g	80 g	120 g	corn
4 g	8 g	12 g	chilli sauce
12 g	24 g	36 g	onion (finely chopped)
1 tbsp	1-2 tbsp	2-3 tbsp	red wine vinegar
			mustard, thyme and cayenne pepper
200 g	400 g	600 g	fish fillet
			salt

Fish fillet with curry sauce

1. Place the fish fillet in a round gratin dish with the thin ends toward the centre and sprinkle with salt.
2. Spread the banana and the ready made curry sauce on the fish fillet.
3. Cover with microwave cling film and cook on AUTO COOK, "Fish fillet with sauce".
4. After cooking, stand for approx. 2 min.

0,4 kg	0,8 kg	1,2 kg	
200 g	400 g	600 g	fish fillet
			salt
40 g	80 g	100 g	banana (sliced)
160 g	320 g	480 g	ready-made curry sauce

Cooking charts

Abbreviations used

tbsp = tablespoon	Cup = cupful	g = gram	ml = millilitre	min = minutes
tsp = teaspoon	KG = kilogram	l = litre	cm = centimetre	

Heating food & drink

Food/Drink	Quantity -g/ml-	Power -Level-	Time -Min-	Method
Milk 1 cup	150	800 W	approx. 1	do not cover
Water 1 cup 6 cups 1 dish	150	800 W	1-2	do not cover
	900	800 W	10-12	do not cover
	1000	800 W	11-13	do not cover
One plate meal (vegetables, meat and trimmings)	400	800 W	3-6	sprinkle some water onto the sauce, cover, stir halfway through heating
Soup / stew	200	800 W	1-2	cover, stir after heating

Food/ Drink	Quantity -g/ml-	Power -Level-	Time -Min-	Method
Vegetables	200	800 W	2-3	if necessary add some water, cover, stir halfway through heating
	500	800 W	4-5	
Meat, 1 slice*	200	800 W	3-4	thinly spread sauce over the top, cover
Fish fillet*	200	800 W	2-3	cover
Cake, 1 slice	150	400 W	1/2	place in a flan dish
Baby food, 1 jar	190	400 W	approx. 1	transfer into a suitable microwaveable container, after heating stir well and test the temperature
Melting margarine or butter*	50	800 W	1/2	cover
Melting chocolate	100	400 W	2-3	stir occasionally

* from chilled

Defrosting

Food	Quantity -g-	Power -Level-	Time -Min-	Method	Standing time -Min-
Goulash	500	240 W	8-12	stir halfway through defrosting	10-15
Cake, 1 slice	150	80 W	2-5	place in a flan dish	5
Fruit e.g. cherries strawberries, raspberries, plums	250	240 W	4-5	spread out evenly, turn over halfway through defrosting	5

The times shown in the table are guidelines which may vary according to freezing temperature, quality and weight of the foodstuffs.

Defrosting & cooking

Food	Quantity -g-	Power -Level-	Time -Min-	Method	Standing time -Min-
Fish fillet	300	800 W	10-12	cover	2
One plate meal	400	800 W	9-11	cover, stir after 6 minutes	2

Cooking meat & fish

Food	Quantity -g-	Power -Level-	Time -Min-	Method	Standing time -Min-
Roasts (pork, veal, lamb)	1000	800 W	19-21*	season to taste, place in a shallow flan dish, turn over after*	10
	1500	400 W	11-14		
Roast beef (medium)	1000	800 W	33-36*	season to taste, place in a flan dish, turn over after*	10
		400 W	13-17		
Fish fillet	200	800 W	9-11*	season to taste, place in a flan dish, cover	3

RECIPES

All the recipes in this book are calculated on the basis of 4 servings unless otherwise stated.

Adapting recipes for the microwave oven

If you would like to adapt your favourite recipes for the microwave, you should take note of the following: Shorten cooking times by a third to a half. Follow the example of the recipes in this book.

Foods which have a high moisture content such as meat, fish, poultry, vegetables, fruit, stews and soups can be prepared in your microwave without any difficulty.

Foods which have little moisture, such as platters of food, should have the surface moistened prior to heating or cooking.

The amount of liquid to be added to raw foods, which are to be braised, should be reduced to about two thirds of the quantity in the original recipe. If necessary, add more liquid during cooking.

The amount of fat to be added can be reduced considerably. A small amount of butter, margarine or oil is sufficient to flavour food. For this reason your microwave is excellent for preparing low-fat foods as part of a diet.

Mushroom soup

- Place the vegetables and the stock in the bowl, cover and cook.
8-9 min. 800 W
- Blend all the ingredients in the mixer.
- Mix the flour and butter to a paste and blend into the soup. Season with salt and pepper, cover and cook. Stir after cooking.
4-6 min. 800 W
- Mix the egg yolk with the cream, gradually stir into the soup. Heat for a short time, but do not let it boil!
1-2 min. 800 W
After cooking, stand for approx. 5 min.

Utensils	Bowl with lid (2 l capacity)
200 g	mushrooms, sliced
50 g	onion, finely chopped
300 ml	meat stock
300 ml	cream
25 g	flour
25 g	butter or margarine
	salt and pepper
1	egg
150 g	cream

Ratatouille

1. Place the olive oil and garlic in the bowl. Add the prepared vegetables, except the artichoke hearts, and season with pepper. Add the bouquet garni, cover and cook, stirring once.
19–21 min. 800 W
For the last 5 min, add the artichoke hearts and cook.
2. Season the ratatouille to taste with salt and pepper. Remove the bouquet garni before serving. After cooking, stand for approx. 2 min.

Utensils	Bowl with lid (2 l capacity)
5 tbsp	olive oil
1 clove	garlic, crushed
50 g	onion, sliced
250 g	aubergine, cubed
250 g	courgette, cubed
200 g	pepper, large cubes
75 g	fennel, large cubes
1	bouquet garni
200 g	tinned artichoke hearts, cut into quarters
	salt and pepper

Sole fillets

1. Wash the fish and pat them dry. Remove any bones.
2. Cut the lemon and the tomatoes into thin slices.
3. Grease the oven dish with butter. Place the fish fillets in the dish and drizzle with the vegetable oil.
4. Sprinkle parsley over the dish, place the tomato slices on top and season. Place the lemon slices on top of the tomatoes and pour the white wine over them.
5. Place small pats of butter on top of the lemon, cover and cook.
16–19 min. 800 W
After cooking, stand for approx. 2 min.

Utensils	Shallow oval oven dish with microwave cling film (approx. 26 cm long)
400 g	sole fillets
1	lemon, whole
150 g	tomatoes
10 g	butter
1 tbsp	vegetable oil
1 tbsp	parsley, chopped
	salt and pepper
4 tbsp	white wine
20 g	butter or margarine

Zürich veal stew

1. Cut the veal into strips.
2. Grease the dish with the butter. Put the meat and onion into the dish, cover and cook. Stir once during cooking. 7-10 min. 800 W
3. Add the white wine, gravy browning and cream, stir, cover and continue cooking. Stir occasionally. 4-5 min. 800 W
4. Stir the mixture after cooking, stand for approx. 5 min. Garnish with parsley.

Utensils	Dish with lid (2 l capacity)
600 g	veal fillet
10 g	butter or margarine
50 g	onion, finely chopped
100 ml	white wine
	seasoned gravy browning, for approx. 1/2 litre gravy
300 ml	cream
1 tsp	parsley, chopped

Stuffed ham

1. Mix the spinach with the cheese and fromage frais, season to taste.
2. Place a tablespoon of the filling on top of each slice of cooked ham, and roll up. Spear the ham with a wooden skewer to fasten it.
3. Make a béchamel sauce: to do this, pour the water and cream into a bowl and heat. 3-4 min. 800 W
Mix the flour and butter to make a roux, add to the liquid, and whisk until dissolved. Cover, cook until thick. 1 min. 800 W
Stir and taste.
4. Place the sauce into the greased dish, place the filled rolls of ham onto the sauce and cook with lid. 3-4 min. 800 W
After cooking, stand for approx. 5 min.

Utensils	Bowl with lid (2 l capacity) Oval gratin dish with lid (approx. 26 cm long)
125 g	leaf spinach, chopped
125 g	fromage frais, 20 % fat content
40 g	Emmental cheese, grated
	pepper and paprika
6 slices	cooked ham (300 g)
125 ml	water
125 ml	cream
20 g	flour
20 g	butter or margarine
10 g	butter or margarine to grease the dish

Lasagne

1. Chop the tomatoes, mix with the ham and onion, garlic, minced beef and tomato puree. Season, cover and cook 7-9 min. 800 W
2. Mix the crème fraiche with the milk, Parmesan cheese, herbs, oil and spices.
3. Grease the dish and cover the bottom with about $\frac{1}{3}$ of the pasta. Put half of the minced meat mixture on the pasta and pour on some sauce. Repeat and finish with the remaining pasta. Cover the pasta with sauce and sprinkle with Parmesan cheese. Cook with the lid on. 15-17 min. 560 W
After cooking, stand for approx. 5-10 min.

Utensils	Bowl with lid (2 l capacity) Shallow square gratin dish with lid (approx. 20 x 20 x 6 cm)
300 g	tinned tomatoes
50 g	ham, chopped
50 g	onion, finely chopped
1	clove of garlic, crushed
250 g	minced beef
2 tbsp	tomato puree
	salt and pepper
150 ml	crème fraiche
100 ml	milk
50 g	Parmesan cheese, grated
1 tsp	mixed chopped herbs
1 tsp	olive oil
1 tsp	vegetable oil to grease the dish
125 g	lasagne verde
1 tbsp	Parmesan cheese, grated

Fruit jelly with vanilla sauce

1. Put some of the fruit to one side for decoration. Purée the rest of the fruit with the white wine, put it into a dish, cover and heat. 7-9 min. 800 W
2. Stir in the sugar and the lemon juice.
3. Soak the gelatin in cold water for approx. 10 min, then take it out and squeeze dry. Stir the gelatin into the hot purée until it has dissolved. Place the jelly in the refrigerator and leave to set.
4. To make the vanilla sauce; put the milk into the other dish. Slit the vanilla pod and remove the insides, stir this into the milk with the sugar and the cornflour. Cover and cook, stir during cooking and again at the end. 3-4 min. 800 W
5. Turn out the jelly onto a plate and decorate with the remaining fruit. Pour the vanilla sauce over the jelly.

Utensils	Dish with lid (2 l capacity) Bowl with lid (1 l capacity)
150 g	redcurrants, washed and stalks removed
150 g	strawberries, washed and hulls removed
150 g	raspberries, washed and hulls removed
250 ml	white wine
100 g	sugar
50 ml	lemon juice
8	gelatin leaves
300 ml	milk
$\frac{1}{2}$	vanilla pod
30 g	sugar
15 g	cornflour

CARE & CLEANING

i CAUTION!

DO NOT USE COMMERCIAL OVEN CLEANERS, STEAM CLEANERS, ABRASIVE, HARSH CLEANERS, ANY THAT CONTAIN SODIUM HYDROXIDE OR SCOURING PADS ON ANY PART OF YOUR MICROWAVE OVEN.

CLEAN THE OVEN AT REGULAR INTERVALS AND REMOVE ANY FOOD DEPOSITS. Failure to maintain the oven in a clean condition could lead to a deterioration of the surface that could adversely affect the life of the appliance and possibly result in a hazardous situation.

Oven exterior

The outside of your oven can be cleaned easily with mild soap and water. Make sure the soap is wiped off with a moist cloth, and dry the exterior with a soft towel.

Control panel

Open the door before cleaning to de-activate the control panel. Care should be taken when cleaning the control panel. Using a cloth dampened with water only, gently wipe the panel until it becomes clean. Avoid using excessive amounts of water. Do not use any sort of chemical or abrasive cleaner.

Oven interior

1. For cleaning, wipe any splatters or spills with a soft damp cloth or sponge after each use while the oven is still warm. For heavier spills, use a mild soap and wipe several times with a damp cloth until all residues are removed. Do not remove the waveguide cover.
2. Make sure that mild soap or water does not penetrate the small vents in the walls which may cause damage to the oven.
3. Do not use spray type cleaners on the oven interior.

Turntable & turntable support

Remove the turntable and turntable support from the oven. Wash the turntable and turntable support in mild soapy water. Dry with a soft cloth. Both the turntable and the turntable support are dishwasher safe.

Door

To remove all trace of dirt, regularly clean both sides of the door, the door seals and sealing surfaces with a soft, damp cloth. Do not use harsh abrasive cleaners or sharp metal scrapers to clean the oven door glass since they can scratch the surface, which may result in shattering of the glass.

Important: A steam cleaner should not be used.

REDUCED POWER LEVEL

Important:

If you cook the food over the standard time with only 800 W, the power of the oven will lower automatically to avoid overheating. (The microwave power level will be reduced to 560 W.) After pausing for 90 seconds, 800 W can be reset.

Cooking mode	Standard time	Reduced power level
Microwave 800 W	20 minutes	Microwave - 560 W

WHAT TO DO IF . . .

Problem	Check if . . .
The microwave appliance is not working properly ?	<ul style="list-style-type: none"> • The fuses in the fuse box are working. • There has not been a power outage. • If the fuses continue to blow, please contact a qualified electrician.
The microwave mode is not working ?	<ul style="list-style-type: none"> • The door is properly closed. • The door seals and their surfaces are clean. • The START/QUICK-button has been pressed.
The turntable is not turning ?	<ul style="list-style-type: none"> • The turntable support is correctly connected to the drive. • The ovenware does not extend beyond the turntable. • Food does not extend beyond the edge of the turntable preventing it from rotating. • There is nothing in the well beneath the turntable.
The microwave will not switch off ?	<ul style="list-style-type: none"> • Isolate the appliance from the fuse box. • Contact your local Service Force Centre.
The interior light is not working ?	<ul style="list-style-type: none"> • Call your local Service Force Centre. The interior light bulb can be exchanged only by trained Service Force technicians.
The food is taking longer to heat through and cook than before ?	<ul style="list-style-type: none"> • Set a longer cooking time (double quantity = nearly double time) or, • If the food is colder than usual, rotate or turn from time to time or, • Set a higher power setting.

SPECIFICATIONS

AC Line Voltage		230 - 240 V, 50 Hz, single phase
AC Power required:	Microwave	1.2 kW
Output power:	Microwave	800 W (IEC 60705)
Microwave Frequency		2450 MHz * (Group 2 / Class B)
Outside Dimensions:	MC1753E	494 mm (W) x 371 mm (H) x 316 mm (D)
	MC1763E	594 mm (W) x 371 mm (H) x 316 mm (D)
Cavity Dimensions		285 mm (W) x 202 mm (H) x 298 mm (D) **
Oven Capacity		17 litres **
Turntable		∅ 272 mm, glass
Weight		approx. 16 kg
Oven lamp		25 W/240 - 250 V

* This Product fulfils the requirement of the European standard EN55011.

In conformity with this standard, this product is classified as group 2 class B equipment.

Group 2 means that the equipment intentionally generates radio-frequency energy in the form of electromagnetic radiation for the heat treatment of food.

Class B equipment means that the equipment is suitable to be used in domestic establishments.

** Internal capacity is calculated by measuring maximum width, depth and height.

Actual capacity for holding food is less.



This oven complies with the requirements of Directives 2004/108/EC, 2006/95/EC and 2005/32/EC.

SPECIFICATIONS ARE SUBJECT TO CHANGE WITHOUT NOTICE AS PART OF CONTINUOUS IMPROVEMENT



INSTALLATION

The microwave can be fitted in position A, B, C or D:

Position	Niche size		
	W	D	H
A	560	550	360
B+C	462	300	350
	462	300	360
	560	300	350
	560	300	360
D	462	500	350
	462	500	360
	560	500	350
	560	500	360

Measurements in (mm)

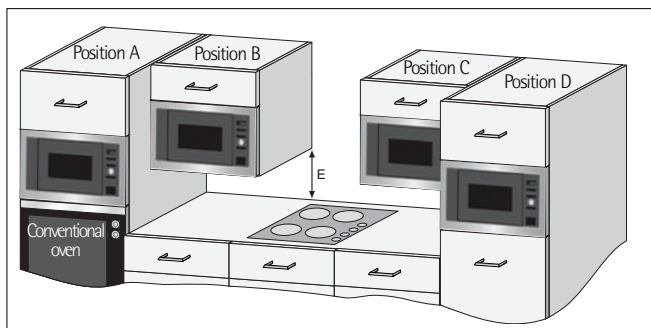

Installing the appliance

1. Remove all packaging and check carefully for any signs of damage.
2. This oven is designed to fit into a 360mm high cupboard as standard.
When fitting into a 350mm high cupboard:-
Unscrew and remove the 4 feet from the bottom of the oven. There are 3 tall feet and 1 short foot. Replace the 3 tall feet with those provided in the accessory pack. Do not replace the short foot.
3. Fit the appliance into the kitchen cupboard slowly, and without force, until the front frame of the oven seals against the front opening of the cupboard.
4. Ensure the appliance is stable and not leaning. Ensure that a 4mm gap is kept between the cupboard door above and the top of the frame (see diagram).



Fixing Option 1:

Fix the oven in position with the screws provided. The fixing points are located on the top and bottom corners of the oven.

Fixing Option 2:

Please see the template sheet supplied with this oven.

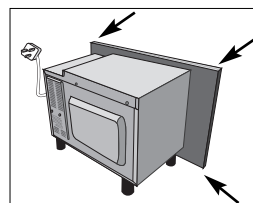

Safe use of the appliance

If fitting the microwave in position B or C (see diagram on page 28):

- The cupboard must be a minimum of 500mm (E) above the worktop & must not be installed **directly** above a hob.
- This appliance has been tested and approved for use near domestic gas, electric and induction hobs only.
- Sufficient space between hob and microwave should be allowed to prevent overheating of microwave oven, surrounding cupboard and accessories.
- Do not operate the hob without pans when the microwave oven is operating.
- Care should be taken when attending to the microwave oven while the hob is on.

Connecting the appliance to the power supply

- **The electrical outlet should be readily accessible so that the unit can be unplugged easily in an emergency. Or it should be possible to isolate the oven from the supply by incorporating a switch in the fixed wiring in accordance with the wiring rules.**
- **The socket should not be positioned behind the cupboard.**
- The best position is above the cupboard, see (A).
- Connect the appliance to a single phase 230 - 240 V/50 Hz alternating current via a correctly installed earth socket.
- **If the appliance is to be operated in a non-European country, the supply voltage, current type and frequency of the appliance indicated on the rating plate must correspond with the specification of your power supply. The rating plate can be found on the inside face of the control panel.**
- **The power supply cord may only be replaced by an electrician.**
- Before installing, tie a piece of string to the power supply cord to facilitate connection to point (A) when the appliance is being installed.
- When inserting the appliance into the high-sided cupboard, **DO NOT** crush the power supply cord.
- Do not immerse the power supply cord or plug in water or any other liquid.

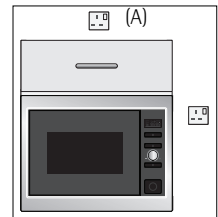

Electrical connections

**WARNING!****THIS APPLIANCE MUST BE EARTHED****The manufacturer declines any liability should this safety measure not be observed.**

- If the plug that is fitted to your appliance is not suitable for your socket outlet, it must be cut off and the appropriate plug fitted.
- Remove the fuse from the cut off plug. The cut off plug should then be disposed of to prevent the hazard of shocks in case it should be plugged into a 13 Amp socket in another part of your home.

IMPORTANT

The wires in the mains lead are coloured in accordance with the following code:

GREEN AND YELLOW	EARTH
BLUE	NEUTRAL
BROWN	LIVE

If you fit your own plug, the colours of the wires in the mains lead of your appliance may not correspond with the markings identifying the terminals in your plug, proceed as follows:

- Connect the green and yellow (earth) wire to the terminal in the plug which is marked with the letter "E" or the earth symbol (\perp) or coloured green and yellow.
- Connect the blue (neutral) wire to the terminal in the plug which is marked with the letter "N" or coloured black.
- Connect the brown (live) wire to the terminal in the plug which is marked with the letter "L" or coloured red.

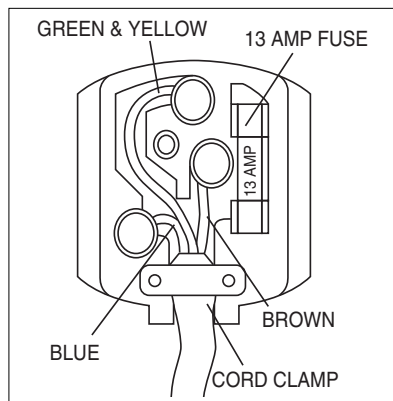

ENVIRONMENTAL INFORMATION

Ecologically responsible disposal of packaging materials and old appliances



Packaging materials

AEG microwave ovens require effective packaging to protect them during transportation. Only the minimum packaging necessary is used. Packaging materials (e.g. foil or styrofoam) can place children at risk.



Danger of suffocation. Keep packaging material away from children.



All packaging materials used are environment friendly and can be recycled. The cardboard is made from recycled paper and the wooden parts are untreated. Plastic items are marked as follows:

«PE» polyethylene eg packaging film

«PS» polystyrene eg packaging (CFC-free)

«PP» polypropylene eg packaging straps

By using and re-using the packaging, raw materials are saved and waste volume is reduced. Packaging should be taken to your nearest recycling centre. Contact your local council for information.



Disposal of old appliances

Old appliances should be made safe before disposal by removing the plug, and cutting off and disposing of the power cable.

It should then be taken to the nearest recycling centre. Check with your local Council or Environmental Health Office to see if there are facilities in your area for recycling the appliance.



The symbol  on the product or on its packaging indicates that this product may not be treated as household waste. Instead it should be taken to the appropriate collection point for the recycling of electrical and electronic equipment. By ensuring this product is disposed of correctly, you will help prevent potential negative consequences for the environment and human health, which could otherwise be caused by inappropriate waste handling of this product. For more detailed information about recycling of this product, please contact your local council, your household waste disposal service or the shop where you purchased the product.

SERVICE & SPARE PARTS

If you wish to purchase spare parts or require an engineer, contact your local AEG Service Force Centre by telephoning:

08445 616 616

Your telephone call will be automatically routed to the Service Force Centre covering your post code area.

For the address of your local Service Force Centre and further information about Service Force, please visit the website at:

www.serviceforce.co.uk

When you contact the Service Force Centre they will need the following information:

1. Your name & address, including post code.
2. Your telephone number.
3. Clear and concise details of the fault.
4. The model and serial number of the appliance (found on the rating plate).
5. The purchase date:
Please note that a valid purchase receipt or guarantee documentation is required for in-guarantee service calls.

CUSTOMER CARE

For general enquiries concerning your AEG appliance or for further information on AEG products please contact our Customer Care Department by letter or telephone at the address below or visit our website at:

www.aeg.co.uk

Customer Care Department
Major Appliances
Addington Way
Luton
Bedfordshire
LU4 9QQ

Tel. 08445 611 611 (*)

(*) Calls may be recorded for training purposes.

For Customer Service in Ireland please contact us at the address below:

AEG
Electrolux Group (Irl) Ltd
Long Mile Road
Dublin 12
Republic of Ireland

Tel: + 353 (0)1 4090754

Email: service.eid@electrolux.ie

GUARANTEE CONDITIONS

Standard guarantee conditions

We, AEG, undertake that if within 12 months of the date of the purchase this AEG appliance or any part thereof is proved to be defective by reason only of faulty workmanship or materials, we will, at our discretion repair or replace the same FREE OF CHARGE for labour, materials or carriage on condition that:

- The appliance has been correctly installed and used only on the electricity or gas supply stated on the rating plate.
- The appliance has been used for normal domestic purposes only, and in accordance with the manufacturer's operating and maintenance instructions.
- The appliance has not been serviced, maintained, repaired, taken apart or tampered with by any person not authorised by us.
- All service work under this guarantee must be undertaken by a Service Force Centre. Any appliance or defective part replaced shall become the Company's property.
- This guarantee is in addition to your statutory and other legal rights.
- Home visits are made between 8.30am and 5.30pm Monday to Friday. Visits may be available outside these hours in which case a premium will be charged.

Exclusions

This guarantee does not cover:

- Damage or calls resulting from transportation, improper use or neglect, the replacement of any light bulbs or removable parts of glass or plastic.
- Costs incurred for calls to put right an appliance which is improperly installed or calls to appliances outside the United Kingdom.
- Appliances found to be in use within a commercial environment, plus those which are subject to rental agreements.
- Products of AEG manufacture which are not marketed by AEG.

European Guarantee

If you should move to another country within Europe then your guarantee moves with you to your new home subject to the following qualifications:

- The guarantee starts from the date you first purchased your product.
- The guarantee is for the same period and to the same extent for labour and parts as exists in the new country of use for this brand or range of products.
- This guarantee relates to you and cannot be transferred to another user.
- Your new home is within the European Community (EC) or European Free Trade Area.
- The product is installed and used in accordance with our instructions and is only used domestically, i.e. a normal household.
- The product is installed taking into account regulations in your new country.

Before you move please contact your nearest Customer Care centre, listed below, to give them details of your new home. They will then ensure that the local Service Organisation is aware of your move and able to look after you and your appliances.

France	Senlis	+33 (0) 3 44 62 29 29
Germany	Nürnberg	+49 (0) 800 234 7378
Italy	Pordenone	+39 (0) 800 117511
Sweden	Stockholm	+46 (0) 8 672 5360
UK	Luton	+44 (0) 8445 611 611

www.electrolux.com

		
Albania	+35 5 4 261 450	Rr. Pjeter Bogdani Nr. 7 Tirane
Belgique/België/ Belgien	+32 2 363 04 44	Bergensesteenweg 719, 1502 Lembeek
Česká republika	+420 2 61 12 61 12	Budějovická 3, Praha 4, 140 21
Danmark	+45 70 11 74 00	Strevelinsvej 38-40, 7000 Fredericia
Deutschland	+49 180 32 26 622	Muggenhofer Str. 135, 90429 Nürnberg
Eesti	+37 2 66 50 030	Mustamäe tee 24, 10621 Tallinn
España	+34 902 11 63 88	Carretera M-300, Km. 29,900 Alcalá de Henares Madrid
France	www.electrolux.fr	
Great Britain	+44 8445 616 616	Addington Way, Luton, Bedfordshire LU4 9QQ
Hellas	+30 23 10 56 19 70	4, Limnou Str., 54627 Thessaloniki
Hrvatska	+385 1 63 23 338	Slavonska avenija 3, 10000 Zagreb
Ireland	+353 1 40 90 753	Longmile Road Dublin 12
Italia	+39 (0) 434 558500	Cso Lino Zanussi, 26 - 33080 Porcia (PN)
Latvija	+37 17 84 59 34	Kr. Barona iela 130/2, LV-1012, Riga
Lituania	+370 5 27 80 609	Verkiu 29, 09108 Vilnius, Lithuania
Luxembourg	+35 2 42 43 13 01	Rue de Bitbourg, 7, L-1273 Hamm
Magyarország	+36 1 252 1773	H-1142 Budapest XIV, Erzsébet királyné útja 87
Nederland	+31 17 24 68 300	Vennootsweg 1, 2404 CG - Alphen aan den Rijn
Norge	+47 81 5 30 222	Risløkkvn. 2 , 0508 Oslo
Österreich	+43 18 66 400	Herziggasse 9, 1230 Wien
Polska	+48 22 43 47 300	ul. Kolejowa 5/7, Warsaw
Portugal	+351 21 440 39 39	Quinta da Fonte - Edifício Gonçalves Zarco - Q 35 -2774-518 Paço de Arcos
Romania	+40 21 44 42 581	B-dul Timisoara 90, S6, Bucharest
Schweiz - Suisse - Svizzera	+41 62 88 99 111	Industriestrasse 10, CH-5506 Mägenwil
Slovenija	+38 61 24 25 731	Tržaška 132, 1000 Ljubljana
Slovensko	+421 2 43 33 43 22	Electrolux Slovakia s.r.o., Electrolux Domáce spotrebiče SK, Seberínho 1, 821 03 Bratislava
Suomi	www.electrolux.fi	
Sverige	+46 (0)771 76 76 76	Electrolux Service, S:t Göransgatan 143, S-105 45 Stockholm
Türkiye	+90 212 293 10 20	Tarlabası Caddesi No: 35 34435 Taksim İstanbul
Россия	+7 095 937 7837	129090 Москва, Олимпийский проспект, 16, Бц "Олимпик"

www.aeg-electrolux.com/shop



TINS-A610URRO

Subject to change without notice

