

SyncMaster 963UW / 2063UW

# LCD Monitor

## User Manual

---

# Introduction

## Package Contents



Please make sure the following items are included with your monitor.

If any items are missing, contact your dealer.

Contact a local dealer to buy optional items.

## Unpacking

Without stand



Monitor

With stand



Monitor

### Manuals

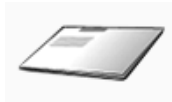

Quick Setup Guide



Warranty Card

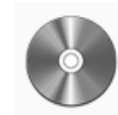

User's Guide

(Not available in all locations)

### Cables



D-Sub Cable



Power Cord



USB Cable

### Sold separately

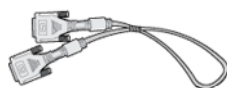

DVI Cable



HDMI Cable



Headphones

## Others



Cleaning Cloth



### Note

This is only provided for highly polished black products as a product feature.

## Your Monitor

### Initial Settings

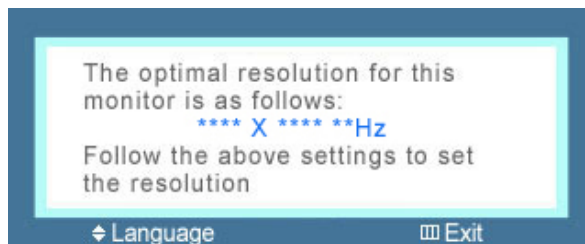

Select the language using the up or down key.

The displayed content will disappear after 40 seconds.

Turn the Power button off and on. It will be displayed again.

It can be displayed up to three (3) times. Make sure to adjust the resolution of your PC before reaching the maximum count.



### Note

The resolution displayed on the screen is the optimal resolution for this product.

Adjust your PC resolution so that it is the same as the optimal resolution for this product.

---

## Front

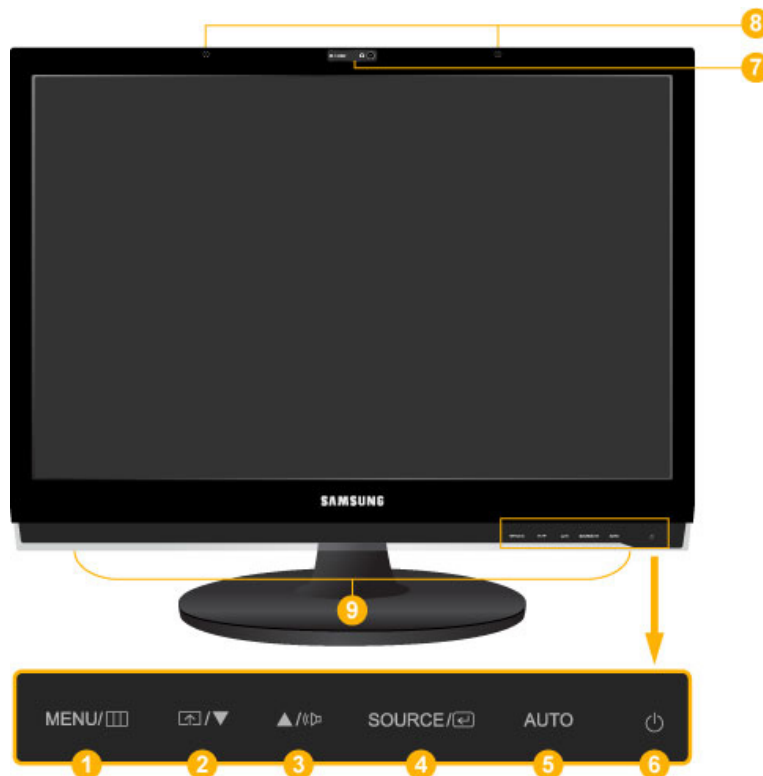

1 **MENU button** [MENU/□]

Opens the on-screen menu and exits from the menu. Also use to exit the OSD menu or return to the previous menu.

2 **Customized Key**

You can customize key assignment for the Custom button according to your preferences.



**Note**

You can configure the **Customized key** for a required function via **Setup > Customized Key**.

3 **Volume button**

When OSD is not on the screen, push the button to adjust volume.

>> Click here to see an animation clip

2,3 **Adjust buttons** [▼/▲]

Adjust items in the menu.

4 **SOURCE button / Enter button** [↵]

Push the 'SOURCE/↵', then selects the video signal while the OSD is off. (When the SOURCE/↵ button is pressed to change the input mode, a message appears in the upper left of the screen displaying the current mode -- analog or digital input signal.)

/ Activates a highlighted menu item.



**Note**

If you select the digital mode, you must connect your monitor to the graphic card's DVI port using the DVI cable.

>> Click here to see an animation clip

**5** *AUTO button*

Use this button for auto adjustment.

(Available in **Analog** mode only)

>> Click here to see an animation clip

**6** *Power button [⏻] / Power indicator*

Use this button for turning the monitor on and off.

/ This light glows blue during normal operation, and blinking blue once as the monitor saves your adjustments.

**7** *Camera*

Using this camera, you can view and send video for video chatting.

**8** *Mic*

Using this microphone, you can view and send audio for video chatting.

**9** *Speaker*

You can hear sound by connecting the soundcard of your PC to the monitor.

## Rear



**Note**

The configuration at the back of the monitor may vary from product to product.

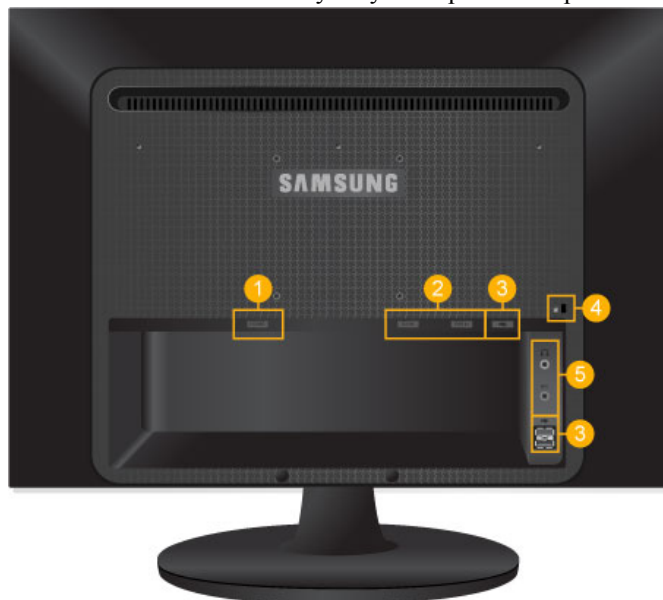

**1** *POWER*

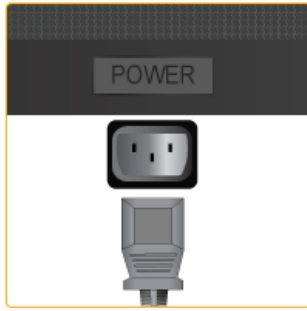

*POWER*

Connect the power cord for your monitor to the *POWER* port on the back of the monitor.

2 *DVI IN / RGB IN*

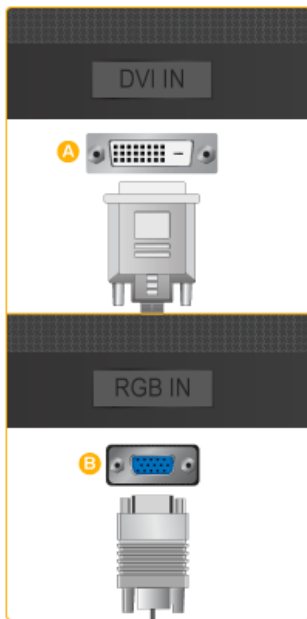

A *DVI IN*

Connect the DVI cable to the *DVI IN* port on the back of your monitor.

B *RGB IN*

Connect the *RGB IN* terminal at the back of your monitor to your computer.

3  *USB connection terminal (Option)*





A *UP* (USB upstream port)

Connect the  *UP* port of the monitor and the USB port of the computer with the USB cable.

B *DOWN* (USB downstream port)

Connect the  *DOWN* port of the USB monitor and a USB device with the USB cable.

 **Note**

To use  *DOWN* (Downstream Port), you have to connect the  *UP* (Upstream Cable) to the PC.

Make sure to use the USB cable supplied with this monitor to connect the monitor's  *UP* port and your computer's USB port.

#### 4 Kensington Lock

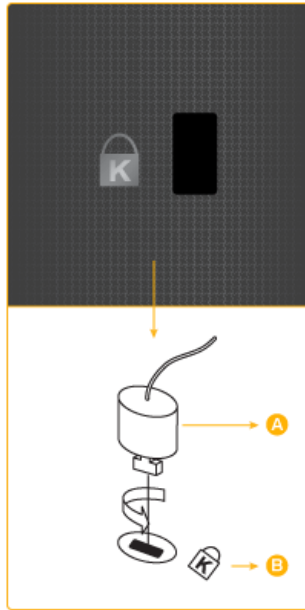

The Kensington Lock is a device used to physically fix the system when using it in a public place. The locking device has to be purchased separately. The appearance and locking method may differ from the illustration depending on the manufacturer. Refer to the manual provided with the Kensington Lock for proper use. The locking device has to be purchased separately.

#### Note

The location of the Kensington Lock may be different depending on its model.

#### Using the Anti-Theft Kensington Lock

1. Insert the locking device into the Kensington slot on the Monitor (**B**) and turn it in the locking direction (**A**).
2. Connect the Kensington Lock cable.
3. Fix the Kensington Lock to a desk or a heavy stationary object.

#### 5 / MIC

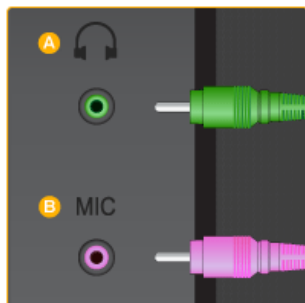

Headphone output terminal



Connect a microphone to the MIC terminal.

#### 6 Cable holding ring

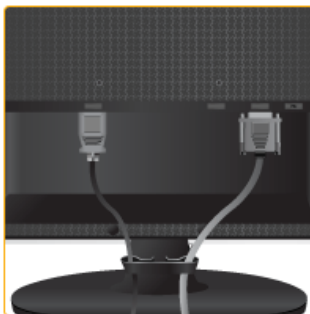

Fix the cables using the holding ring, as shown in the figure.



See

{963UW}

Connecting Cables for further information regarding cable connections.

---



---

# Connections

{963UW}

## Connecting Cables

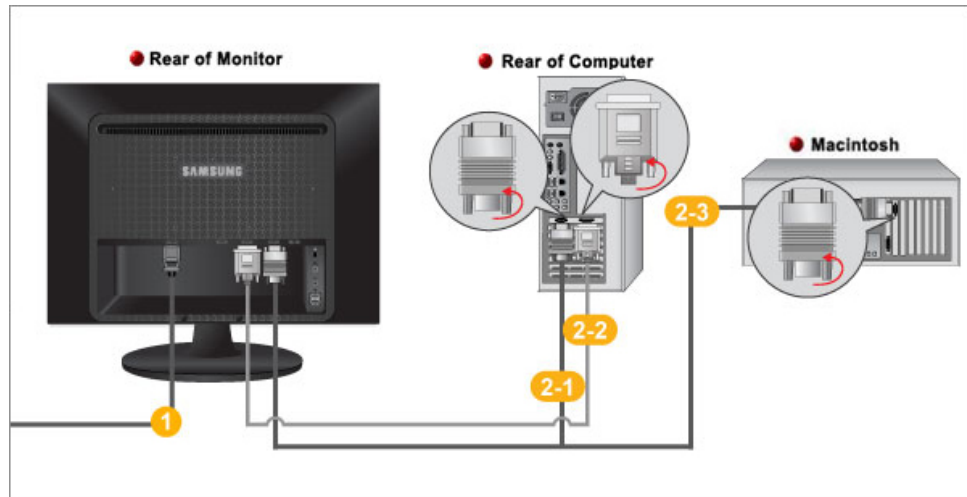

**1** Connect the power cord for your monitor to the power port on the back of the monitor.

Plug the power cord for the monitor into a nearby outlet.

**2** Use a connection appropriate for your computer.

**2-1** Using the D-sub (Analog) connector on the video card.

- Connect the signal cable to the 15-pin, D-sub port on the back of your monitor.



**2-2** Using the DVI (Digital) connector on the video card.

- Connect the DVI Cable to the DVI IN Port on the back of your Monitor.



**2-3** Connected to a Macintosh.

- Connect the monitor to the Macintosh computer using the D-sub connection cable.

 **Note**

If the monitor and the computer are connected, you can turn them on and use them.

---

{963UW}

Connecting USB



Note

You can use a USB device such as a mouse, keyboard, Memory Stick, or external hard disk drive by connecting them to the DOWN port of the monitor without connecting them to the PC.

The USB port of the monitor supports High-Speed Certified USB 2.0.

	High speed	Full speed	Low speed
Data Rate	480 Mbps	12 Mbps	1.5 Mbps
Power Consumption	2.5 W	2.5 W	2.5 W
	(Max., each port)	(Max., each port)	(Max., each port)

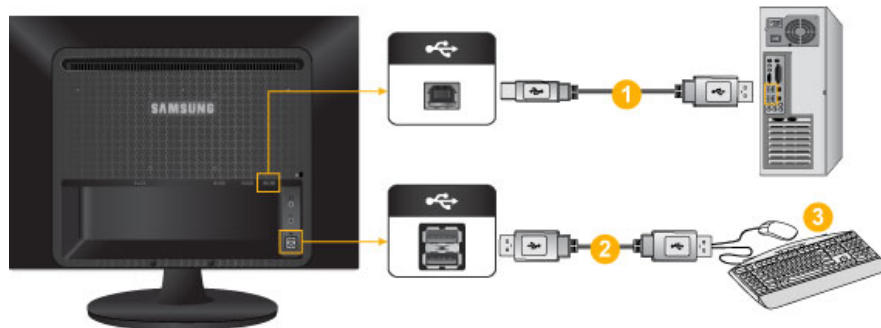

1. Connect the UP port of the monitor and the USB port of the computer with the USB cable.



Note

To use DOWN port, you have to connect the UP (Upstream Cable) to the PC.

Make sure to use the USB cable supplied with this monitor to connect the monitor's UP port and your computer's USB port.

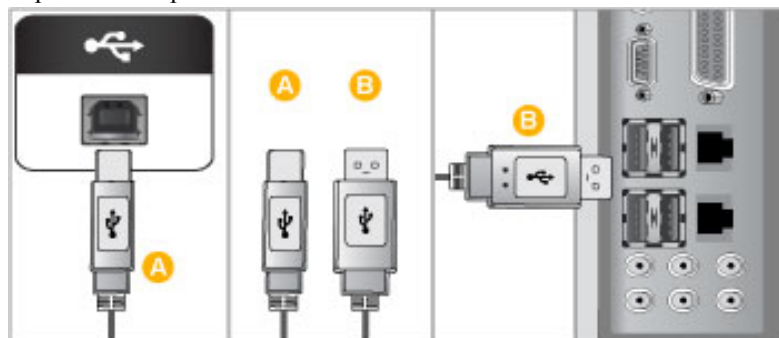

2. Connect the DOWN port of the USB monitor and a USB device with the USB cable.
3. The use procedures are as the same as those for using an external device connecting to the PC.

- You can connect and use a keyboard and mouse.
- You can play a file from a media device.

(Examples of media devices: MP3, digital camera, etc.)

- You can run, move, copy or delete the files on the storage device.

(Examples of storage devices: external memory, memory card, memory reader, HDD-type MP3 player, etc.)

- You can use other USB devices that can be connected to a computer.



When connecting a device to the  *DOWN* port of the monitor, connect the device using a cable appropriate to the device.

(For the purchase of the cable and external devices, ask the service center of the corresponding product.)

The company is not liable for problems or damages to an external device caused by using an unauthorized cable for the connection.

Some products do not follow the USB standard, and it may cause a malfunction of the device.

If the device malfunctions even if it is connected to the computer, contact the service center of the device/computer.

## {963UW}

### Connecting Headphone



You may connect your headphones to the monitor.



1. Connect your headphones to the Headphone connection terminal.

## {963UW}

### Connecting MIC



You may connect your microphone to the monitor.

---

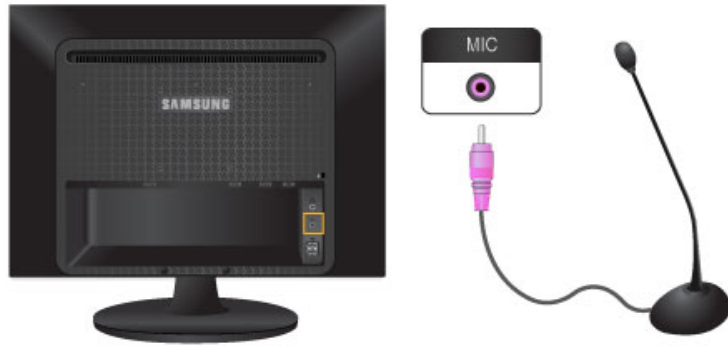

1. Connect the microphone cable to the MIC port on the monitor.

**{963UW}**

**Using the Stand**

**Monitor Assembly**



Simple Stand

Monitor and Bottom

---

## Tilt angle



Using (D), You can adjust the tilt angle within a range of  $-3^{\circ}$  forward to  $24^{\circ}$  backward for the most comfortable viewing angle.

## Attaching a Base

This monitor accepts a 75 mm x 75 mm VESA-compliant mounting interface pad.

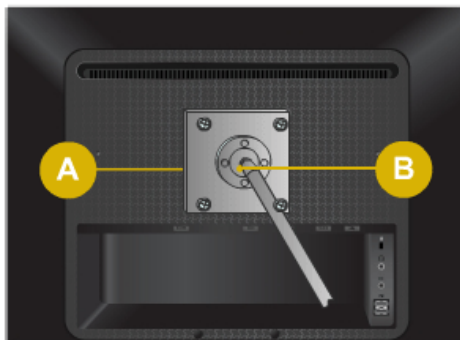

- (A) Monitor
- (B) Mounting interface pad (Sold separately)

1. Turn off your monitor and unplug its power cord.
2. Lay the LCD monitor face-down on a flat surface with a cushion beneath it to protect the screen.
3. Remove four screws and then remove the stand from the LCD monitor.
4. Align the mounting interface pad with the holes in the rear cover mounting pad and secure it with four screws that came with the arm-type base, wall mount hanger or other base.



- Do not use screws longer than the standard dimension, as they may damage the inside of the Monitor.

- For wall mounts that do not comply with VESA standard screw specifications, the length of the screws may differ depending on their specifications.
- Do not use screws that do not comply with the VESA standard screw specifications.

Do not fasten the screws too tightly, as this may damage the product or cause the product to fall, leading to personal injury.

Samsung is not liable for these kinds of accidents.

- Samsung is not liable for product damage or personal injury when a non-VESA or non-specified wall mount is used or the consumer fails to follow the product installation instructions.
-  To mount the monitor on a wall, you should purchase the wall mounting kit that allows you to mount the monitor at least 10 cm away from the wall surface.
- Contact the nearest Samsung Service Center for more information. Samsung Electronics will not be responsible for damages caused by using a base other than those specified.
- Please use Wall Mount according to the International standards.

## {2063UW}

### Connecting Cables

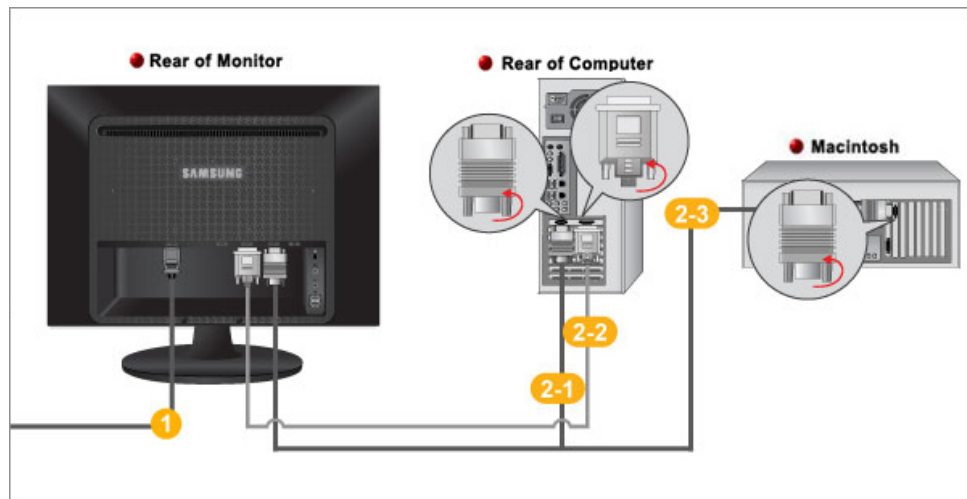

- 1 Connect the power cord for your monitor to the power port on the back of the monitor.

Plug the power cord for the monitor into a nearby outlet.

- 2 Use a connection appropriate for your computer.

- 2-1 Using the D-sub (Analog) connector on the video card.

- Connect the signal cable to the 15-pin, D-sub port on the back of your monitor.



- 2-2 Using the DVI (Digital) connector on the video card.

- Connect the DVI Cable to the DVI IN Port on the back of your Monitor.



**2-3** Connected to a Macintosh.

- Connect the monitor to the Macintosh computer using the D-sub connection cable.

**Note**

If the monitor and the computer are connected, you can turn them on and use them.

## {2063UW}

### Connecting USB

**Note**

You can use a USB device such as a mouse, keyboard, Memory Stick, or external hard disk drive by connecting them to the *DOWN* port of the monitor without connecting them to the PC.

The USB port of the monitor supports High-Speed Certified USB 2.0.

	High speed	Full speed	Low speed
Data Rate	480 Mbps	12 Mbps	1.5 Mbps
Power Consumption	2.5 W	2.5 W	2.5 W
	(Max., each port)	(Max., each port)	(Max., each port)

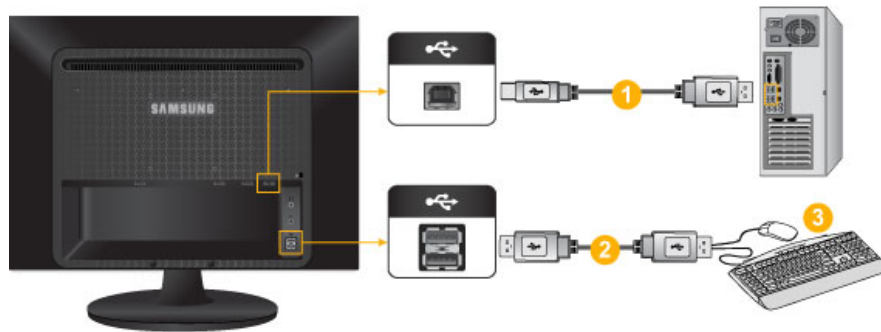



1. Connect the *UP* port of the monitor and the USB port of the computer with the USB cable.

**Note**

To use *DOWN* port, you have to connect the *UP* (Upstream Cable) to the PC.

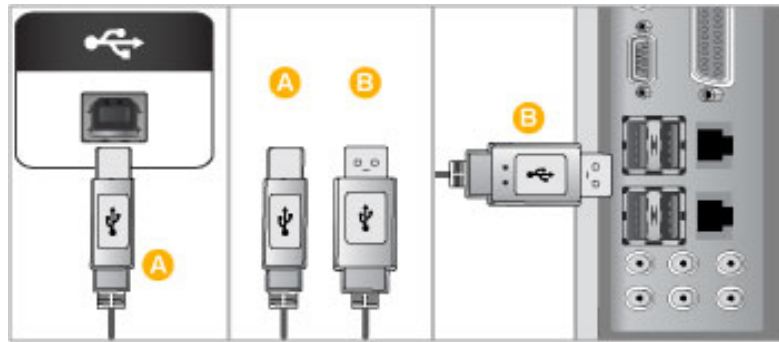
Make sure to use the USB cable supplied with this monitor to connect the monitor's *UP* port and your computer's USB port.



2. Connect the  *DOWN* port of the USB monitor and a USB device with the USB cable.
3. The use procedures are as the same as those for using an external device connecting to the PC.
  - You can connect and use a keyboard and mouse.
  - You can play a file from a media device.  
(Examples of media devices: MP3, digital camera, etc.)
  - You can run, move, copy or delete the files on the storage device.  
(Examples of storage devices: external memory, memory card, memory reader, HDD-type MP3 player, etc.)
  - You can use other USB devices that can be connected to a computer.



**Note**

When connecting a device to the  *DOWN* port of the monitor, connect the device using a cable appropriate to the device.

(For the purchase of the cable and external devices, ask the service center of the corresponding product.)

The company is not liable for problems or damages to an external device caused by using an unauthorized cable for the connection.

Some products do not follow the USB standard, and it may cause a malfunction of the device.

If the device malfunctions even if it is connected to the computer, contact the service center of the device/computer.

**{2063UW}**

### Connecting Headphone



**Note**

You may connect your headphones to the monitor.

---





1. Connect your headphones to the Headphone connection terminal.

**{2063UW}**

### Connecting MIC



Note

You may connect your microphone to the monitor.

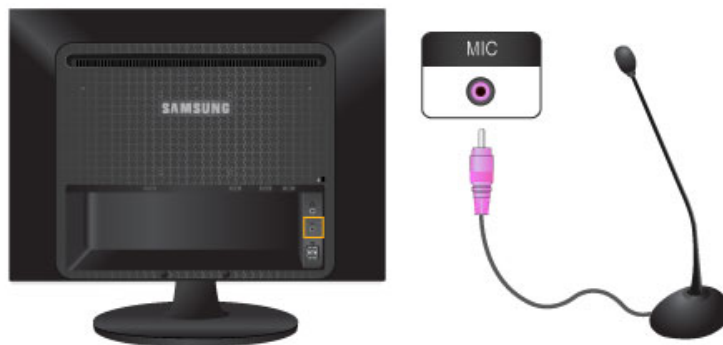

1. Connect the microphone cable to the MIC port on the monitor.

{2063UW}

## Using the Stand

### Monitor Assembly



Simple Stand

Monitor and Bottom

### Tilt angle



Using (D), You can adjust the tilt angle within a range of  $-3^{\circ}$  forward to  $24^{\circ}$  backward for the most comfortable viewing angle.

### Attaching a Base

This monitor accepts a 100 mm x 100 mm VESA-compliant mounting interface pad.

---

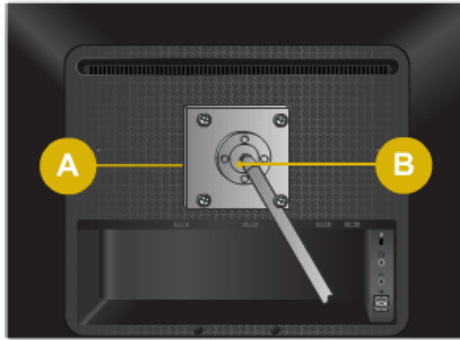

**A** Monitor

**B** Mounting interface pad (Sold separately)

1. Turn off your monitor and unplug its power cord.
2. Lay the LCD monitor face-down on a flat surface with a cushion beneath it to protect the screen.
3. Remove four screws and then remove the stand from the LCD monitor.
4. Align the mounting interface pad with the holes in the rear cover mounting pad and secure it with four screws that came with the arm-type base, wall mount hanger or other base.



- Do not use screws longer than the standard dimension, as they may damage the inside of the Monitor.
- For wall mounts that do not comply with VESA standard screw specifications, the length of the screws may differ depending on their specifications.
- Do not use screws that do not comply with the VESA standard screw specifications.

Do not fasten the screws too tightly, as this may damage the product or cause the product to fall, leading to personal injury.

Samsung is not liable for these kinds of accidents.



- Samsung is not liable for product damage or personal injury when a non-VESA or non-specified wall mount is used or the consumer fails to follow the product installation instructions.
- To mount the monitor on a wall, you should purchase the wall mounting kit that allows you to mount the monitor at least 10 cm away from the wall surface.
- Contact the nearest Samsung Service Center for more information. Samsung Electronics will not be responsible for damages caused by using a base other than those specified.
- Please use Wall Mount according to the International standards.

---

# Troubleshooting

{963UW}

## Self-Test Feature Check



Your monitor provides a self test feature that allows you to check whether your monitor is functioning properly.

## Self-Test Feature Check

1. Turn off both your computer and the monitor.
2. Unplug the video cable from the back of the computer.
3. Turn on the monitor.

If the monitor is functioning properly, you will see a box in the illustration below.

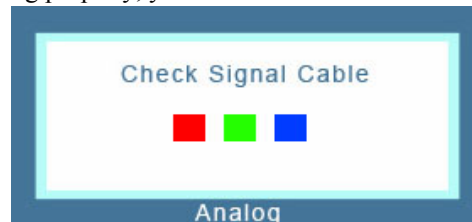

This box appears during normal operation if the video cable becomes disconnected or damaged.

4. Turn off your monitor and reconnect the video cable; then turn on both your computer and the monitor.

If your monitor screen remains blank after using the previous procedure, check your video controller and computer system; *your monitor is functioning properly.*

## Warning Messages

If there is something wrong with the input signal, a message appears on the screen or the screen goes blank although the power indicator LED is still on. The message may indicate that the monitor is out of scan range or that you need to check the signal cable.

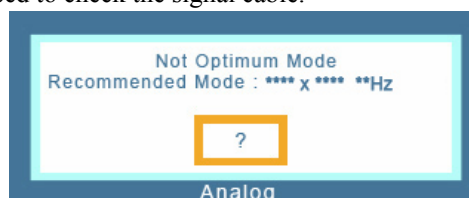

## Environment

The location and the position of the monitor may influence the quality and other features of the monitor.

If there are any sub woofer speakers near the monitor, unplug and relocate the woofer to another room.

Remove all electronic devices such as radios, fans, clocks and telephones that are within 3 feet (one meter) of the monitor.

---

## Useful Tips

A monitor recreates visual signals received from the computer. Therefore, if there is a problem with the computer or the video card, this can cause the monitor to become blank, have poor coloring, become noisy, and video mode not supported, etc. In this case, first check the source of the problem, and then contact the Service Center or your dealer.

Judging the monitor's working condition

If there is no image on the screen or a "**Not Optimum Mode**", "**Recommended Mode 1440 x 900 60 Hz**" message comes up, disconnect the cable from the computer while the monitor is still powered on.

If there is a message coming up on the screen or if the screen goes white, this means the monitor is in working condition.

In this case, check the computer for trouble.

## {963UW}

### Check List



#### Note

Before calling for assistance, check the information in this section to see if you can remedy any problems yourself. If you do need assistance, please call the phone number on the Information section or contact your dealer.

### No images on the screen. I cannot turn on the monitor.

Q: Is the power cord connected properly?

A: Check the power cord connection and supply.

Q: Can you see "**Check Signal Cable**" on the screen?

A: (Connected using the D-sub cable)

Check the signal cable connection.

(Connected using the DVI cable)

If you still see an error message on the screen when the monitor is connected properly, check to see if the monitor status is set to analog.

If you still see an (error) message on the screen when the monitor is connected properly, check to see if the monitor status is set to analog. Press 'SOURCE/' button to have the monitor double-check the input signal source.

Q: If the power is on, reboot the computer to see the initial screen (the login screen), which can be seen.

A: If the initial screen (the login screen) appears, boot the computer in the applicable mode (the safe mode for Windows ME/XP/2000) and then change the frequency of the video card.

(Refer to the Preset Timing Modes)

If the initial screen (the login screen) does not appear, contact the Service Center or your dealer.

Q: Can you see "**Not Optimum Mode**", "**Recommended Mode 1440 x 900 60 Hz**" on the screen?

---

A: You can see this message when the signal from the video card exceeds the maximum resolution and frequency that the monitor can handle properly.

A: Adjust the maximum resolution and frequency that the monitor can handle properly.

A: If the display exceeds WSXGA or 75 Hz, a "**Not Optimum Mode**", "**Recommended Mode 1440 x 900 60 Hz**" message is displayed. If the display exceeds 85 Hz, the display will work properly but the "**Not Optimum Mode**", "**Recommended Mode 1440 x 900 60 Hz**" message appears for one minute and then disappears.

Please change to the recommended mode during this one-minute period.

(The message is displayed again if the system is rebooted.)

Q: There is no image on the screen. Is the power indicator on the monitor blinking at 1 second intervals?

A: The monitor is in PowerSaver mode.

A: Press a key on the keyboard to activate the monitor and restore the image on the screen.

A: If there is still no image, press the 'SOURCE/⏏' button. Then press any key on the keyboard again to activate the monitor and restore the image on the screen.

Q: Connected using the DVI cable?

A: You may get a blank screen if you boot the system before you connect the DVI cable, or disconnect and then reconnect the DVI cable while the system is running as certain types of graphic cards do not send out video signals. Connect the DVI cable and then reboot the system.

### **I cannot see the On Screen Display.**

Q: Have you locked the On Screen Display (OSD) Menu to prevent changes?

A: Unlock the OSD by pressing the [MENU/⏏] button for at least 5 seconds.

### **The screen shows strange colors or just black and white.**

Q: Is the screen displaying only one color as if looking at the screen through a cellophane paper?

A: Check the signal cable connection.

A: Make sure the video card is fully inserted in its slot.

Q: Have the screen colors become strange after running a program or due to a crash between applications?

A: Reboot the computer.

Q: Has the video card been set properly?

A: Set the video card by referring to the video card manual.

### **The screen suddenly has become unbalanced.**

Q: Have you changed the video card or the driver?

A: Adjust screen image position and size using the OSD.

Q: Have you adjusted the resolution or frequency to the monitor?

---

A: Adjust the resolution and frequency at the video card.

(Refer to the Preset Timing Modes).

Q: The screen can be unbalanced due to the cycle of the video card signals. Readjust Position by referring to the OSD.

**The screen is out of focus or OSD cannot be adjusted.**

Q: Have you adjusted the resolution or frequency on the monitor?

A: Adjust the resolution and frequency of the video card.

(Refer to the Preset Timing Modes).

**LED is blinking but no images on the screen.**

Q: Is the frequency properly adjusted when checking the Display Timing on the menu?

A: Adjust the frequency properly by referring to the video card manual and the Preset Timing Modes.

(The maximum frequency per resolution may differ from product to product.)

**There are only 16 colors shown on the screen. The screen colors have changed after changing the video card.**

Q: Have the Windows colors been set properly?

A: Windows XP :

Set the resolution at the Control Panel → Appearance and Themes → Display → Settings.

A: Windows ME/2000 :

Set the resolution at the Control Panel → Display → Settings.

Q: Has the video card been set properly?

A: Set the video card by referring to the video card manual.

**There is a message that reads "Unrecognized monitor, Plug & Play (VESA DDC) monitor found".**

Q: Have you installed the monitor driver?

A: Install the monitor driver according to the Driver Installation Instructions.

Q: See the video card manual to see if the Plug & Play (VESA DDC) function can be supported.

A: Install the monitor driver according to the Driver Installation Instructions.

**Check when MagicTune™ does not function properly.**

Q: MagicTune™ feature is found only on PC (VGA) with Window OS that supports Plug and Play.

A: To check whether your PC is available for MagicTune™ feature, follow the steps below (When Windows is XP);

---

Control Panel → Performance and Maintenance → System → Hardware → Device Manager → Monitors → After deleting Plug and Play monitor, find 'Plug and Play monitor' by searching new Hardware.

- A: MagicTune™ is an additional software for the monitor. Some graphic cards may not support your monitor. When you have a problem with the graphic card, visit our website to check the compatible graphic card list provided.

<http://www.samsung.com/monitor/magictune>

### **MagicTune™ doesn't work properly.**

- Q: Have you changed your PC or video graphic card?

- A: Download the latest program. The program can be downloaded <http://www.samsung.com/monitor/magictune>

- Q: Did you install the program?

- A: Reboot the computer after installing the program for the first time. If a copy of the program is already installed, remove it, reboot the computer, and then install the program again. You need to reboot the computer for it to operate normally after installing or removing the program.



#### **Note**

Visit the MagicTune™ website and download the installation software for MagicTune™ MAC.

### **Check the following items if there is trouble with the monitor.**

Check if the power cord and the video cables are properly connected to the computer.

Check if the computer beeps more than 3 times when booting.

(If it does, request an a service for the main board of the computer.)

If you installed a new video card or if you assembled the PC, check if the installed the adapter(video) driver and the monitor driver.

Check if the scanning ratio of the video screen is set to between 56 Hz ~ 75 Hz.

(Do not exceed 75 Hz when using the maximum resolution.)

If you have problems in installing the adapter (video) driver, boot the computer in Safe Mode, remove the Display Adapter in the "Control Panel → System → Device Administrator" and then reboot the computer to reinstall the adapter (video) driver.



#### **Note**

If problems repeatedly occur, contact an authorized service center.

### **{963UW}**

#### **Q & A**

- Q: How can I change the frequency?

- A: The frequency can be changed by reconfiguring the video card.

- A: Note that video card support can vary, depending on the version of the driver used. (Refer to the computer or the video card manual for details.)
-



Q: How can I adjust the resolution?

A: Windows XP:

Set the resolution in the Control Panel → Appearance and Themes → Display → Settings.

A: Windows ME/2000:

Set the resolution in the Control Panel → Display → Settings.

\* Contact the video card manufacturer for details.

Q: How can I set the Power Saving function?

A: Windows XP:

Set the resolution in the Control Panel → Appearance and Themes → Display → Screen Saver.

Set the function in the BIOS-SETUP of the computer. (Refer to the Windows / Computer Manual).

A: Windows ME/2000:

Set the resolution at the Control Panel → Display → Screen Saver.

Set the function in the BIOS-SETUP of the computer. (Refer to the Windows / Computer Manual).

Q: How can I clean the outer case/LCD Panel?

A: Disconnect the power cord and then clean the monitor with a soft cloth, using either a cleaning solution or plain water.

Do not leave any detergent or scratches on the case. Do not let any water enter the monitor.



**Note**

Before calling for assistance, check the information in this section to see if you can remedy any problems yourself. If you do need assistance, please call the phone number on the Information section or contact your dealer.

## {2063UW}

### Self-Test Feature Check



**Note**

Your monitor provides a self test feature that allows you to check whether your monitor is functioning properly.

### Self-Test Feature Check

1. Turn off both your computer and the monitor.
2. Unplug the video cable from the back of the computer.
3. Turn on the monitor.

If the monitor is functioning properly, you will see a box in the illustration below.

---

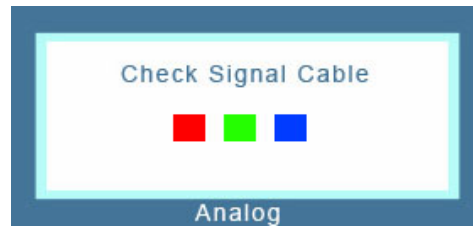

This box appears during normal operation if the video cable becomes disconnected or damaged.

4. Turn off your monitor and reconnect the video cable; then turn on both your computer and the monitor.

If your monitor screen remains blank after using the previous procedure, check your video controller and computer system; *your monitor is functioning properly.*

## Warning Messages

If there is something wrong with the input signal, a message appears on the screen or the screen goes blank although the power indicator LED is still on. The message may indicate that the monitor is out of scan range or that you need to check the signal cable.

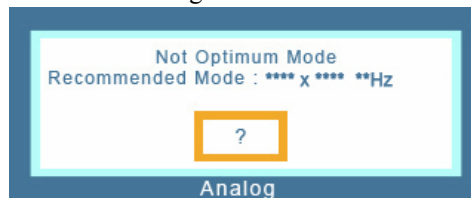

## Environment

The location and the position of the monitor may influence the quality and other features of the monitor.

If there are any sub woofer speakers near the monitor, unplug and relocate the woofer to another room.

Remove all electronic devices such as radios, fans, clocks and telephones that are within 3 feet (one meter) of the monitor.

## Useful Tips

A monitor recreates visual signals received from the computer. Therefore, if there is a problem with the computer or the video card, this can cause the monitor to become blank, have poor coloring, become noisy, and video mode not supported, etc. In this case, first check the source of the problem, and then contact the Service Center or your dealer.

Judging the monitor's working condition

If there is no image on the screen or a "**Not Optimum Mode**", "**Recommended Mode 1680 x 1050 60 Hz**" message comes up, disconnect the cable from the computer while the monitor is still powered on.

If there is a message coming up on the screen or if the screen goes white, this means the monitor is in working condition.

In this case, check the computer for trouble.

---

## {2063UW}

### Check List



Before calling for assistance, check the information in this section to see if you can remedy any problems yourself. If you do need assistance, please call the phone number on the Information section or contact your dealer.

### No images on the screen. I cannot turn on the monitor.

Q: Is the power cord connected properly?

A: Check the power cord connection and supply.

Q: Can you see "**Check Signal Cable**" on the screen?

A: (Connected using the D-sub cable)

Check the signal cable connection.

(Connected using the DVI cable)

If you still see an error message on the screen when the monitor is connected properly, check to see if the monitor status is set to analog.

If you still see an (error) message on the screen when the monitor is connected properly, check to see if the monitor status is set to analog. Press 'SOURCE/

Q: If the power is on, reboot the computer to see the initial screen (the login screen), which can be seen.

A: If the initial screen (the login screen) appears, boot the computer in the applicable mode (the safe mode for Windows ME/XP/2000) and then change the frequency of the video card.

(Refer to the Preset Timing Modes)

If the initial screen (the login screen) does not appear, contact the Service Center or your dealer.

Q: Can you see "**Not Optimum Mode**", "**Recommended Mode 1440 x 900 60 Hz**" on the screen?

A: You can see this message when the signal from the video card exceeds the maximum resolution and frequency that the monitor can handle properly.

A: Adjust the maximum resolution and frequency that the monitor can handle properly.

A: If the display exceeds WSXGA or 75 Hz, a "**Not Optimum Mode**", "**Recommended Mode 1440 x 900 60 Hz**" message is displayed. If the display exceeds 85 Hz, the display will work properly but the "**Not Optimum Mode**", "**Recommended Mode 1440 x 900 60 Hz**" message appears for one minute and then disappears.

Please change to the recommended mode during this one-minute period.

(The message is displayed again if the system is rebooted.)

Q: There is no image on the screen. Is the power indicator on the monitor blinking at 1 second intervals?

---

A: The monitor is in PowerSaver mode.

A: Press a key on the keyboard to activate the monitor and restore the image on the screen.

A: If there is still no image, press the 'SOURCE/[

Q: Connected using the DVI cable?

A: You may get a blank screen if you boot the system before you connect the DVI cable, or disconnect and then reconnect the DVI cable while the system is running as certain types of graphic cards do not send out video signals. Connect the DVI cable and then reboot the system.

### **I cannot see the On Screen Display.**

Q: Have you locked the On Screen Display (OSD) Menu to prevent changes?

A: Unlock the OSD by pressing the [MENU/ 

### **The screen shows strange colors or just black and white.**

Q: Is the screen displaying only one color as if looking at the screen through a cellophane paper?

A: Check the signal cable connection.

A: Make sure the video card is fully inserted in its slot.

Q: Have the screen colors become strange after running a program or due to a crash between applications?

A: Reboot the computer.

Q: Has the video card been set properly?

A: Set the video card by referring to the video card manual.

### **The screen suddenly has become unbalanced.**

Q: Have you changed the video card or the driver?

A: Adjust screen image position and size using the OSD.

Q: Have you adjusted the resolution or frequency to the monitor?

A: Adjust the resolution and frequency at the video card.

(Refer to the Preset Timing Modes).

Q: The screen can be unbalanced due to the cycle of the video card signals. Readjust Position by referring to the OSD.

### **The screen is out of focus or OSD cannot be adjusted.**

Q: Have you adjusted the resolution or frequency on the monitor?

A: Adjust the resolution and frequency of the video card.

(Refer to the Preset Timing Modes).

---

### **LED is blinking but no images on the screen.**

Q: Is the frequency properly adjusted when checking the Display Timing on the menu?

A: Adjust the frequency properly by referring to the video card manual and the Preset Timing Modes.

(The maximum frequency per resolution may differ from product to product.)

### **There are only 16 colors shown on the screen. The screen colors have changed after changing the video card.**

Q: Have the Windows colors been set properly?

A: Windows XP :

Set the resolution at the Control Panel → Appearance and Themes → Display → Settings.

A: Windows ME/2000 :

Set the resolution at the Control Panel → Display → Settings.

Q: Has the video card been set properly?

A: Set the video card by referring to the video card manual.

### **There is a message that reads "Unrecognized monitor, Plug & Play (VESA DDC) monitor found".**

Q: Have you installed the monitor driver?

A: Install the monitor driver according to the Driver Installation Instructions.

Q: See the video card manual to see if the Plug & Play (VESA DDC) function can be supported.

A: Install the monitor driver according to the Driver Installation Instructions.

### **Check when MagicTune™ does not function properly.**

Q: MagicTune™ feature is found only on PC (VGA) with Window OS that supports Plug and Play.

A: To check whether your PC is available for MagicTune™ feature, follow the steps below (When Windows is XP);

Control Panel → Performance and Maintenance → System → Hardware → Device Manager → Monitors → After deleting Plug and Play monitor, find 'Plug and Play monitor' by searching new Hardware.

A: MagicTune™ is an additional software for the monitor. Some graphic cards may not support your monitor. When you have a problem with the graphic card, visit our website to check the compatible graphic card list provided.

<http://www.samsung.com/monitor/magictune>

### **MagicTune™ doesn't work properly.**

Q: Have you changed your PC or video graphic card?

A: Download the latest program. The program can be downloaded <http://www.samsung.com/monitor/magictune>

---

Q: Did you install the program?

A: Reboot the computer after installing the program for the first time. If a copy of the program is already installed, remove it, reboot the computer, and then install the program again. You need to reboot the computer for it to operate normally after installing or removing the program.



**Note**

Visit the MagicTune™ website and download the installation software for MagicTune™ MAC.

**Check the following items if there is trouble with the monitor.**

Check if the power cord and the video cables are properly connected to the computer.

Check if the computer beeps more than 3 times when booting.

(If it does, request an a service for the main board of the computer.)

If you installed a new video card or if you assembled the PC, check if the installed the adapter(video) driver and the monitor driver.

Check if the scanning ratio of the video screen is set to between 56 Hz ~ 75 Hz.

(Do not exceed 75 Hz when using the maximum resolution.)

If you have problems in installing the adapter (video) driver, boot the computer in Safe Mode, remove the Display Adapter in the "Control Panel → System → Device Administrator" and then reboot the computer to reinstall the adapter (video) driver.



**Note**

If problems repeatedly occur, contact an authorized service center.

**{2063UW}**

**Q & A**

Q: How can I change the frequency?

A: The frequency can be changed by reconfiguring the video card.

A: Note that video card support can vary, depending on the version of the driver used. (Refer to the computer or the video card manual for details.)

Q: How can I adjust the resolution?

A: Windows XP:

Set the resolution in the Control Panel → Appearance and Themes → Display → Settings.

A: Windows ME/2000:

Set the resolution in the Control Panel → Display → Settings.

\* Contact the video card manufacturer for details.

Q: How can I set the Power Saving function?

A: Windows XP:

Set the resolution in the Control Panel → Appearance and Themes → Display → Screen Saver.

---

Set the function in the BIOS-SETUP of the computer. (Refer to the Windows / Computer Manual).

A: Windows ME/2000:

Set the resolution at the Control Panel → Display → Screen Saver.

Set the function in the BIOS-SETUP of the computer. (Refer to the Windows / Computer Manual).

Q: How can I clean the outer case/LCD Panel?

A: Disconnect the power cord and then clean the monitor with a soft cloth, using either a cleaning solution or plain water.

Do not leave any detergent or scratches on the case. Do not let any water enter the monitor.



**Note**

Before calling for assistance, check the information in this section to see if you can remedy any problems yourself. If you do need assistance, please call the phone number on the Information section or contact your dealer.

---