



ADDS 3153 ASCII Display Terminal

User's Guide





Before using this information and the product it supports, be sure to read the general information under "Notices."

It is the policy of Boundless Technologies, Inc. to improve products as new technology, components, software, and firmware become available. Boundless Technologies, therefore, reserves the right to change specifications without prior notice.

All features, functions, and operations described herein may not be marketed by Boundless Technologies in all parts of the world. In some instances, photographs are of equipment prototypes. Therefore, before using this document, consult your Boundless Technologies representative or Boundless Technologies office for information that is applicable and current.



Note that Boundless Technologies appreciates receiving suggestions and comments on its publications. After reading this guide, please comment and return the comment sheet that has been provided.

Copyright © Boundless Technologies, Inc. 1996.
Hauppauge, New York
All rights reserved.
Printed in USA

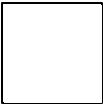

Contents

Preface	v
This guide.....	vi
How to Connect/Disconnect the Terminal.....	vii
Notices.....	viii
Trademarks and Service Marks.....	viii
Electronic Emission Notices.....	ix
Safety Notices.....	xi
Introduction	1
Features.....	2
Compatibility.....	2
Display.....	2
Character Sets.....	2
Communications.....	2
Keyboard.....	2
Desk Accessories.....	3
Communications.....	8
Receive Flow Control.....	8
Transmit Flow Control.....	9
Host/Printer Port 2.....	11
Parallel Printer Port.....	11
Terminal to Modem (DCE) or Host.....	12
Terminal to Host (DTE) or Printer.....	12
Bottom Status/Label Line Display.....	13
Viewports.....	13
Visual Effects of Screen and Page Lengths.....	14
Installation	17



STEP 1 – Know Your Devices	17
STEP 2 – Physical Connections.....	18
STEP 3 – Number of Sessions Selection.....	18
STEP 4 – Linking Ports to Sessions.....	18
STEP 5 – No Printer Option	19
STEP 6 – Know Your Serial Port(S) Protocol	19
STEP 7 – Communications Setup Selections	19
Connection A: Host DCE.....	20
Connection B: Host DTE.....	20
Connection C: RS-232 with Modem.....	20
Connection D: RS-232-C with Modem	20
Connection E: Printer.....	21
Connection F: RS-232-C Printer.....	21
Connections G and H: Parallel Printer.....	21
STEP 8 – Emulation Setup Selection.....	21
STEP 9 – Additional Setup Options.....	22
STEP 10 – Save Parameters.....	22
STEP 11 – Establish Communications.....	22
Common Setups.....	23
Host/Printer Connection Guide.....	24
User Settings.....	26

Setup 27

Overview	27
Saving Parameters.....	28
Movement Inside Menus.....	28
Action Fields.....	29
Dual Session Mode.....	29
Setup Map	30
QUICK: F1.....	32
GENERAL: F2.....	34
DISPLAY: F3.....	36
KEYBOARD: F4.....	38
KEYS: F5	40
PORTS: F6.....	43
HOST: F7	45
PRINT: F8	47
EMULATION: F9	48
ASCII Emulations.....	48
ANSI Emulations	50
IBM Emulation.....	51

TABS: F10.....	52
ANSWERBACK: F11.....	53
PROGRAM: F12.....	54
EXECUTE: Prnt Sc.....	56
Edit Fields.....	57
Glossary of Terms.....	58
Terminal Parameters.....	58
Session Parameters.....	59
Page Reset.....	59
Desk Accessories.....	61
Overview.....	61
Desk Accessory Menu.....	61
Direct Access.....	62
Exit Keystrokes.....	62
Inhibiting Access.....	62
Calendar.....	63
Clock.....	63
Calculator.....	64
ASCII Chart.....	66
Diagnostic Menu.....	67
Appendix.....	69
Local Keys.....	69
Page Configurations—Single and Dual Session.....	72

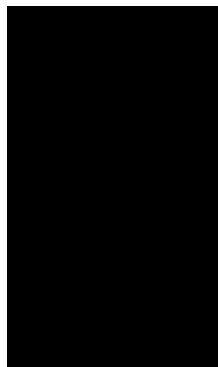

Preface

This product is in conformity with the protection requirements of EU Council Directive 89/336/EEC on the approximation of the laws of the Member States relating to electromagnetic compatibility.

Boundless Technologies cannot accept responsibility for any failure to satisfy the protection requirements resulting from a non-recommended modification of the product, including the fitting of non-Boundless Technologies option cards.

This guide...

is a user's manual and contains all of the information necessary to install, setup, and use the 260 product.

More detailed information on programming using control codes and escape sequences, default strings and character sets, international language support, etc. can be obtained by calling the **Boundless Technologies Hotline** at:

USA and Canada calls 1-800-231-5445

International calls 1-516-342-7400

At the options menu, press 2 for "Product Information," then press 2 for "Products or Program Information Mailed to You," and request the following:

ADD5 3153 Programmer's Reference Manual

Number: 598-0010707

This manual is offered to our customers at no additional charge. When calling to order, please have your terminal's serial number available.

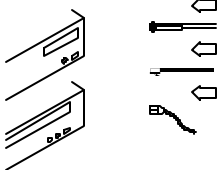
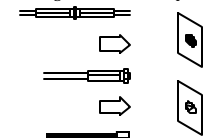
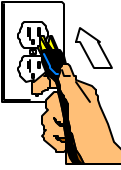
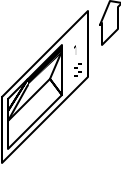

How to Connect/Disconnect the Terminal

To Connect:

<p>First, turn everything OFF.</p> 
<p>Attach all cables to devices.</p> 
<p>Attach signal cables to receptacles.</p> 
<p>Attach power cord to outlet.</p> 
<p>Turn device ON.</p> 

Note: In the UK, by law, the telephone cable must be connected after the power cord.

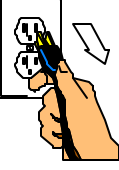
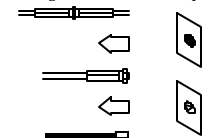
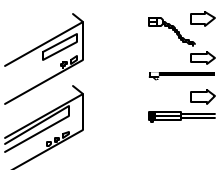
To Disconnect:

<p>First, turn everything OFF.</p> 
<p>Remove power cord from outlet.</p> 
<p>Remove signal cables from receptacles.</p> 
<p>Remove all cables from devices.</p> 
<p>You may now take it with you.</p> 

Note: In the UK, by law, the power cord must be disconnected after the telephone line cable.

Notices

References in this publication to Boundless Technologies products, programs, or services do not imply that Boundless Technologies intends to make these available to all countries in which Boundless Technologies operates. Any reference to a Boundless Technologies product, program, or service is not intended to state or imply that only Boundless Technologies' product, program, or service may be used. Any functionally equivalent product, program, or service that does not infringe any of Boundless Technologies' intellectual property rights may be used instead of Boundless Technologies' product, program, or service. Evaluation and verification of operation in conjunction with other products, except those expressly designated by Boundless Technologies, are the user's responsibility.

This publication could contain technical inaccuracies or typographical errors.

This publication may refer to products that are announced but are not currently available in your country. Boundless Technologies makes no commitment to make available any unannounced products referred to herein. The final decision to announce any product is based on Boundless Technologies' business and technical judgment.

The drawings and specifications contained herein shall not be reproduced in whole or in part without the written permission of Boundless Technologies.

Trademarks and Service Marks

The following terms, denoted by TM in this publication, are trademarks of these companies:

CSA	Canadian Standards Association
ADD5 Viewpoint	Boundless Technologies
SCO	Santa Cruz Operations
DEC VT-32/220/100	Digital Equipment Corporation
WYSE 50/60/120/150	Wyse Technology
TVI 925	TeleVideo Systems, Inc.
UL	Underwriters Laboratories Inc.

Electronic Emission Notices

Federal Communication Commission (FCC) Statement

Note: This equipment has been tested and found to comply with the limits for a Class A digital device, pursuant to Part 15 of the FCC Rules. These limits are designed to provide reasonable protection against harmful interference when the equipment is operated in a commercial environment. This equipment generates, uses, and can radiate radio frequency energy and, if not installed and used in accordance with the instruction manual, may cause harmful interference to radio communications. Operation of this equipment in a residential area is likely to cause harmful interference, in which case the user will be required to correct the interference at his own expense.

Properly shielded and grounded cables and connectors must be used in order to meet FCC emission limits. Boundless Technologies is not responsible for any radio or television interference caused by using other than recommended cables and connectors or by unauthorized changes or modifications to this equipment. Unauthorized changes or modifications could void the user's authority to operate the equipment.

This device complies with Part 15 of the FCC Rules. Operation is subject to the following two conditions: (1) this device may not cause harmful interference, and (2) this device must accept any interference received, including interference that may cause undesired operation.

Canadian Department of Communications Compliance Statement

This equipment does not exceed Class A limits per radio noise emissions for digital apparatus, set out in the Radio Interference Regulation of the Canadian Department of Communications.

Avis de conformité aux normes du ministère des Communications du Canada

Cet équipement ne dépasse pas les limites de Classe A d'émission de bruits radioélectriques pour les appareils numériques, telles que prescrites par le Règlement sur le brouillage radioélectrique établi par le ministère des Communications du Canada.

Japanese Voluntary Control Council for Interference (VCCI) Statement

This equipment is Class 1 Equipment (information equipment to be used in commercial and industrial districts) which is in conformance with the standard set by Voluntary Control for Interference by Data Processing Equipment and Electronic Office Machines (VCCI) with an aim to prevent radio interference in commercial and industrial districts.

This equipment could cause interference to radio and television receivers when used in and around residential districts.

Please handle the equipment properly according to the instruction manual.

Korean Government Ministry of Communication (MOC) Statement

Please note that this device has been approved for business purposes with regard to electromagnetic interference. If you find this is not suitable for your use, you may exchange it for a non-business purpose one.

Safety Notices

Danger Notices

A danger notice indicates a hazard that could possibly cause death or serious personal injury.

The following danger notices are used throughout this manual.



DANGER: To prevent a possible electrical shock when installing the device, ensure that the power cord for that device is unplugged before installing signal cables.



DANGER: To prevent a possible electrical shock when adding the device to a system, disconnect all power cords, if possible, from the existing system before connecting the signal cable to that device.



DANGER: To prevent a possible electrical shock during an electrical storm, do not connect or disconnect cables or station protectors for communication lines, display stations, printers, or telephones.



DANGER: To prevent a possible electrical shock from touching two surfaces with different electrical grounds, use one hand, when possible, to connect or disconnect signal cables.



DANGER: To avoid a shock hazard:

- The power cord must be connected to a properly wired and earthed receptacle.
- Any equipment to which this product will be attached must also be connected to properly wired receptacles.



DANGER: Electrical current from power, telephone, and communication cables is hazardous. To avoid shock hazard, connect and disconnect cables as shown on the following page when installing, moving, or opening the covers of this product or attached devices.



DANGER: The device's switch is not the main disconnect. The device's main power disconnect is the detachable line cord.

Caution Notice

A caution notice indicates a hazard that could possible cause minor personal injury.

CAUTION: This product contains a lithium battery. Do not attempt to exchange or charge the battery. Discard the product as instructed by local regulations for limited lithium batteries. Do not burn.

Warning Notice

A warning notice indicates the possibility of damage to a program, device, system, or data.

chapter

1

Introduction

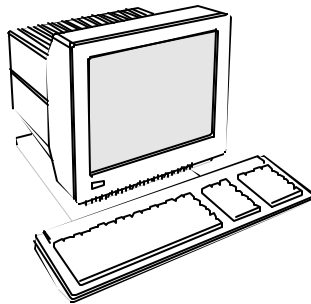

This terminal can emulate a number of ASCII and ANSI terminals, including IBM 3151, PC-Term and SCO™ Console. The keyboards supported by the terminal are the 101-key extended PC (EPC), the 106-key PC+, and the ANSI keyboards. The dual host capability of the terminal allows you to run two different applications simultaneously. A Setup option is available to view each "session" on the screen in a split or full screen display.

Clock, calendar, calculator, ASCII chart, and diagnostic desk accessories are provided. Another feature is the selectable overscan border which can provide bezel-to-bezel video.

This terminal also features an easy-to-use Setup menu that is configuration dependent; this means that only the options that are valid for a given emulation or hardware configuration are presented.

Setup also has a "Quick" menu that summarizes the options most critical to the operation of the terminal. Travel between menus is facilitated by function keys that are listed at the top every menu.



Split screen is not available if one of the sessions is selected as IBM 3151 emulation.

Features

Compatibility

- IBM™ 3151
- ADDS-Viewpoint™
- Wyse™ 60, Wyse 50/50+
- DEC™ VT-320, VT-220, VT-100

- PC Terminal
- SCO™-Console, AT386
- TVI™-925

Display

- Dual session available in full or split screens
- 100 Hz refresh rate (flicker-free)
- Selectable overscan borders
- Selectable screen saver
- 26, 30, 44 or 52 row display with top and bottom status lines
- 80 or 132 column display
- Double high/double wide display
- Up to 10 pages of memory
- Tilt and swivel base, small footprint

Character Sets

- Numerous standard, graphic, and supplemental character sets

Communications

- Serial RS-232-C host/printer port 1 operating from 110 to 134,400 baud
- Optional RS-422 host port 1 (EIA only)
- Serial RS-232-C host/printer port 2 operating from 110 to 38,400 baud
- Parallel IBM™/Centronics™ compatible printer port

Keyboard

- PC 104/105-key keyboard
- ANSI keyboard
- Up to 35 shiftable and programmable edit and function keys

Desk Accessories

- Calculator capable of transmitting results
- Monthly Calendar
- Clock with alarm settings
- ASCII and Diagnostic charts

Physical Features

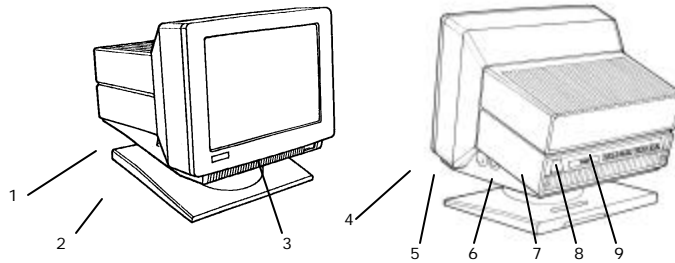

1. **Keyboard Connector** – Push in the keyboard connector here.
2. **Tilt and Swivel Base** – Use the tilt and swivel arrangement to adjust the viewing angle. Grasp the lower corners of the terminal and push up or down, or twist left or right.
3. **Power Switch** – “0” is off; “1” is on.



Leave the terminal's power switch in the off position “0” until power keyboard, and communication connections are made.

4. **Contrast Dial** – Adjust the contrast between characters of different intensities by rotating the dial.
5. **Brightness Dial** – Adjust the overall screen brightness by rotating the dial.
6. **Power Connection** – Plug the female end of the power cord into this connector and the male end of the cord into a properly grounded receptacle.



The Canadian Standards Association (CSA) recommends that the power outlet be near the terminal and easily accessible at all times.

7. **Parallel Printer Port** – Connect the cable from the IBM or Centronics compatible parallel printer to this port. See the “Installation” chapter for options.
8. **Host/Printer Port 2** – Connect the cable from a second host (dual-host mode) or serial printer here. See the “Installation” chapter for options.
9. **Host/Printer Port 1** – Connect the cable from the first host or serial printer here. See the “Installation” chapter for options.

Keyboards

The “PC-style” keyboards, the PC – US (104-key) and the PC – Int'l (105-key), are similar in style and feature a number of key groups.

The alphanumeric keypad is the main typewriter keypad, while the function key group lies along the top of the keyboard and can be programmed locally or downloaded from the host. The numeric keypad is the calculator-style set of keys on the right-hand side of the keyboard, used to enter numeric data.

The cursor and edit keypads, located to the left of the numeric keypad, allows users to edit text and move around in the document. The communication key group, above the edit keypad, is used to control communications with the host or printer.

The PC keyboard is configured as an IBM 3151 ASCII keyboard and is for use primarily with the 3151 emulation.

The ANSI keyboard varies from the PC-style keyboard styles mainly in that it features 20 function keys, a set of PF-keys, and a different style numeric keypad.

For each keyboard, there is a set of local "hot-keys." They perform a variety of terminal functions, such as "Print Screen" and "Enter Setup." (See the Appendix for a complete list of local functions.)

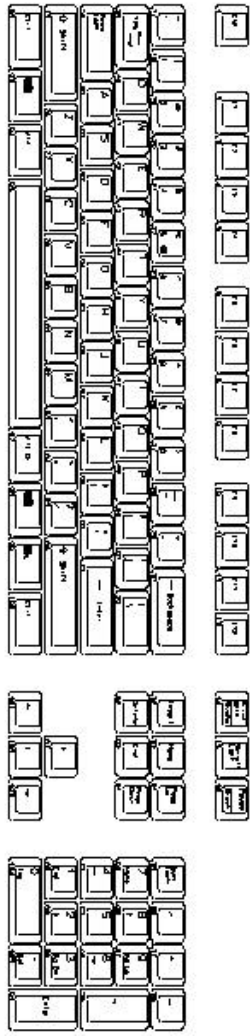



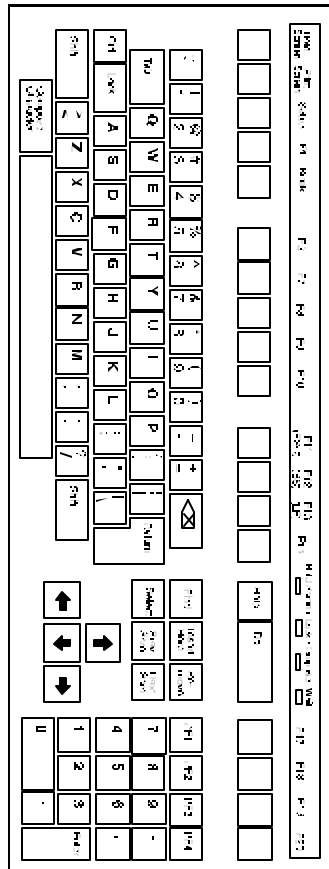





104-key PC Keyboard (US)



ANSI Keyboard

Usage Notes

The following notations and symbols are used in this manual:

- Ctrl-F1: the two keys, Ctrl and F1, are to be pressed simultaneously.
- Ctrl, F1: the two keys, Ctrl and F1, are to be pressed in succession.
- 1-num or 1-alph: specifies that the number must be generated either from the numeric or the alphanumeric keypad.
- 23h: the number 23 is represented in hexadecimal (hex) notation.
-  applies to ASCII emulations *only*: ADDS-VP, Wyse 50+, Wyse 60, PC Term, and TVI-925.
-  applies to ANSI emulations *only*: VT300/8, VT300/7, VT200/8, VT200/7, VT100, SCO Console, and AT386.
-  applies to SCO Console and AT386 emulations *only*.
-  applies to IBM 3151 emulation *only*.
-  applies to parallel attribute emulations *only* which includes all emulations *except* ADDS-VP and Wyse 50+ (which are field attribute emulations).
-  applies to ASCII key-mode *only*.
-  applies to Scan Code-key mode *only*.
-  applies to the PC-style keyboards (PC+ and EPC) only.
-  applies to the ANSI keyboard only.

Communications

This terminal is equipped with three ports. The two serial ports are intended for connection to either a host/modem or a serial printer. The remaining port is a Centronics-compatible printer port. The port you use as the printer port depends on whether you have a serial or a parallel interface to the printer. Another factor affecting your port selection is your choice of connecting the terminal to one or two host computers.

The first host/printer serial port (SES1-EIA) can communicate with your computer or printer at a baud rate of 110 to 134,400 baud (bits per second). The second host/printer serial port (SES2-AUX) can communicate at speeds from 110 baud to 38,400 baud. Either port can be used to connect to a host computer/modem or serial printer.

In single host mode, you have the choice to use the second serial port or to use the parallel printer port, as your printer interface. In dual host mode, the natural choice is to use the parallel port, although other options are available (See the "Installation" chapter). Refer to the following sections for further information on these ports.

Receive Flow Control

Because devices can receive data faster than they can process it, data flow control (selectable in the PORTS menu of Setup) should be used to prevent data loss. Software flow control relies on the Xon and Xoff characters ("g" and "e" characters in Scan Code Key mode) to indicate when the terminal is able or unable to store further data. The Xon signal transmits the DC1 character (11h) and the Xoff signal transmits DC3 (13h).

The terminal's receive buffer can store 1024 bytes (characters). When "EIA (or Aux) Rcv" in the Setup menu for PORTS is "Xon-Xoff," the terminal issues an Xoff character, indicating to the host that it should stop transmitting a. The terminal will then continue to process data until its receive buffer is empty. It will then issue an Xon character to the host, indicating that it can resume sending data to the terminal.



If the "EIA (or Aux) Rcv" is "No Protocol" in Setup, the terminal will continue to accept characters into its receive buffer until it is full. Additional characters will be lost. Xon-Xoff protocol must also be set on the host computer or printer for proper handshaking.

In addition to software "receive" flow control (Xon-Xoff), the serial host/printer ports support "receive" hardware flow control. The SES1-EIA port has an outgoing DTR (Data Terminal Ready) signal. If "EIA Rec" is "DT" in Setup, and the terminal's receive buffer fills to the level mentioned above, the terminal will set the DTR signal low to inform the (serial) host device to stop sending data. On the SES2-AUX port, the incoming DSR (Data Set Ready) signal serves to signal the host (serial) device that the terminal is not ready to receive more data, if "Aux Rcv" is "DSR" in Setup.

Transmit Flow Control

Likewise, the terminal will understand the Xon and Xoff requests from the host when it is transmitting data (provided the "EIA (or Aux) Xmt" is "Xon-Xoff" in Setup). This is referred to as "transmit" flow control.

This terminal will stop transmitting data to the host or printer when it receives an Xoff (DC3) code. If, however, the terminal needs to send a receive protocol character, it will transmit that character even if it has received an Xoff code. When the terminal stops transmitting, the data will be buffered in the transmit buffer (64 characters for the first host/printer port and 64 characters for the second host/printer port). Once the buffer is full, additional keyboard data will be lost. When an Xon (DC1) character is received, the terminal can again send data to the attached serial device.

In addition to software "transmit" flow control (Xon-Xoff), the serial host/printer ports support "transmit" hardware flow control, whereby DSR on the SES1-EIA port and DTR on the SES2-AUX port monitor serial devices to control the flow of data to them (provided EIA and AUX Xmit is "DSR" and "DTR" in Setup).

For parallel printers, this terminal monitors the BUSY and ERROR signals which are sent by the printer to determine when data transmission should be stopped or resumed.

Host/Printer Port 1 (RS-232-C or RS-422)

This port, labeled "SES1-EIA," is designed for connection to the host (computer or modem) or a serial printer via a 25-pin D-shell (DB25P) female connector. This port uses an RS-232-C communication interface, is configured as a DTE (Data Terminal Equipment) device, and can operate from 110 to 134,400 baud. The pins supported are shown below:

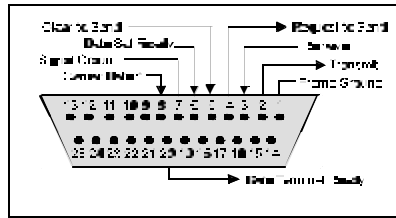

RS-232-C Host/Printer Port 1 Pin Assignments

This port also uses (if installed) an optional RS-422 communication interface and can also operate from 110 to 134,400 baud. The pins supported are shown below:

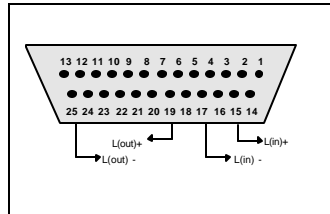

RS-422 Host/Printer Port 1 Pin Assignments

Host/Printer Port 2

This port, labeled "SES2-AUX," is designed to connect to a second host connection (computer or modem) or a serial printer, and can operate from 110 to 38,400 baud. This port uses an RS-232-C interface via a DB25P female connector, and is configured as a DCE (Data Communication Equipment) device. The pin assignments for this port are shown below:

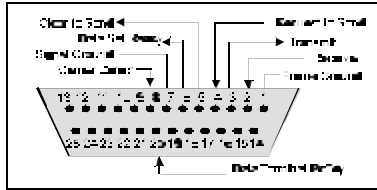

Host/Printer Port 2 Pin Assignments



Refer to the Installation chapter for details on the connection of all ports to serial devices (hosts, modems, or printers).

Parallel Printer Port

This port, labeled "PAR," is designed for connection to a parallel printer, which has a Centronics interface with a 25-pin D-shell female connector. This port, unlike the others, is a uni-directional device, which means that it only serves to output data to the printer, and cannot receive. The pins and signals supported are shown below:

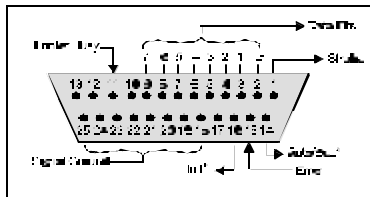

Parallel Port Pin Assignments

* These signals are held high, in an inactive state.



If you have opted to use a parallel printer, but it is not connected, an error message will appear on the status line when any PRINT operation is done. To clear the message, press Ctrl-Shift-Tab.

Terminal to Modem (DCE) or Host

Refer to the diagram below to understand why a null modem adapter may be needed when connecting the second serial port (SES2-AUX) to a modem or a DCE host. The first host will connect directly without a null modem since it is a DTE device.

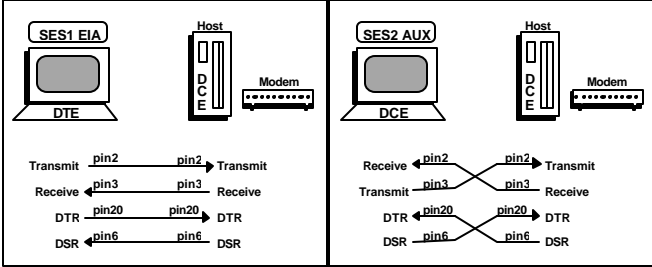

Terminal to Host (DTE) or Printer

Refer to the diagram below to understand why a null modem adapter may be needed when connecting the first serial port (SES1-EIA) to a host port without a modem (Most serial printers are DTE devices and most hosts are not). The second port (AUX) will connect directly without a null modem since it is a DCE device.

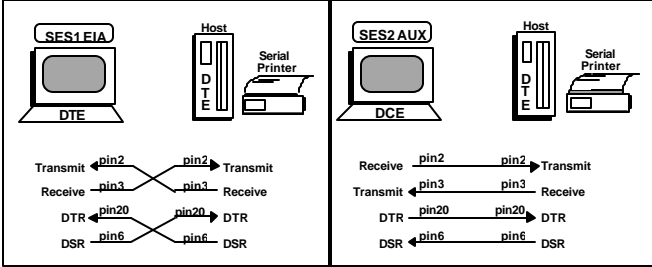

Screen Display and Pages

This terminal offers a variety of screen lengths including 26, 30, 44, or 52 lines. These numbers include the top and bottom status lines (or label line), as well as the lines used to display data. A "page" of terminal memory represents the total number of lines that can be accessed, whether or not they are all viewable on the screen at once. Refer to Appendix A for the number and lengths of pages available for your setup.

The page length is comprised of a base page length multiplied by 1, 2, 4, or 8. For instance, in certain modes, 24 (24x1), 48 (24x2), and 96 (24x4) are available, the same way that 25(25x1), 50 (25x2), and 100 (25x4) are. The base page length and the screen size determine whether a bottom status line or label line is displayed or not.

Bottom Status/Label Line Display

With a screen length of "26 lines," the page lengths that are multiples of 24 allow the bottom status/label line to be displayed, while those that are multiples of 25 do not. The same idea applies with the 44 line screen size. A page length with 42 lines as a base page size will display a label line, while the 43 line base page length will not. An exception to this rule is if the screen length is significantly larger than the that page size, then the label line will be displayed, such as if the screen is 44 lines and the page length is 25 lines.

Viewports



Up to three viewports can be selected on a page. Each viewport has its own character attribute, cursor position, field attribute propagation, tab stops and scrolling region. All of the viewports are displayed on the same screen and can be partitioned with a visual separator line. If the keyboard is associated with one viewport and the host is associated with another, it is possible to receive data in two viewports simultaneously.

The figure below represents the entire page memory of a 48 line page (24 base page length times a multiplier of 2) and the portion of the page that is viewable on the display screen, when "26 Lines" is selected. Notice that the label line is visible in this mode.

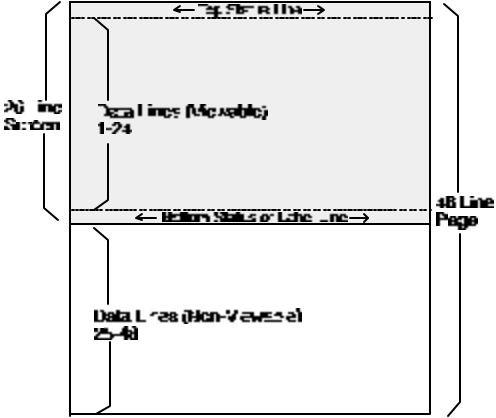

Visual Effects of Screen and Page Lengths

The combination of page and screen lengths influence the number of displayable data lines. For example, if the page length is "50" (25 x 2), and the screen length is 44 lines, the number of data lines that are visible at any one time is 43, with no label line. The other line is used for the top status line. On a 52 line screen, 50 of the 52 data lines are visible at one time, in single session mode.

If the page length is shorter than the screen length, then blank lines will be present below the data line or status/label line. If the page length is larger than the allowable number of data lines, this will cause some of the rows to be out of view. In order to bring them into view, "scrolling" or "panning" is used, as necessary.

Scrolling causes a new line to scroll into view when the cursor advances past the last row or first row on the page. If the cursor moves past the last row, the top row of text is lost, and past the first row, the bottom row of text is lost (if Auto Scroll is "on" in Setup). Text scrolled off of the screen is not recoverable.

If the current page or portion of the page is longer than the screen display or window in which it is displayed, then local keystrokes can be used to "pan" the window up or down (Ctrl-↑ and Ctrl-↓). As a window is panned up, the page appears to be moving down and the opposite is true when panning the window down. Text that is panned off the screen is out of view, but is not lost.

The figure below represents the display screen with a 48 line page length on a 44 line screen, after panning the window down 2 lines.

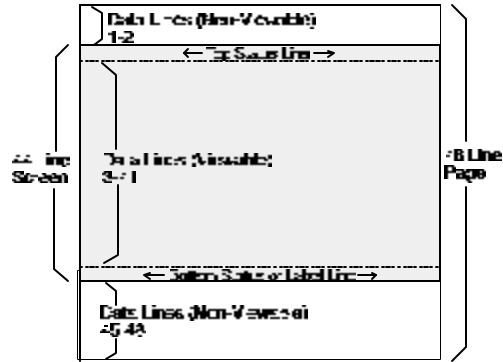



Installation

This section provides a “walk-through” approach to the installation of your terminal. This will enable you to physically connect the terminal to a printer and one or two host computer(s)/modem(s), as well as to configure the Setup menu to suit your requirements and preferences.

The terminal is designed to provide great flexibility in configuring the terminal. An example of the flexibility is apparent in the fact that either the EIA or Aux ports can be used to connect either to a host or a printer port. In addition, a physical port can be assigned as a host port in one session and as a printer port in the other session, if desired. In another case, data can potentially be “printed” from one session to the other.

The procedures described here are among the most common. Described here are conventional single and dual host setups, with or without a printer. These steps may need to be adjusted to meet your requirements.

STEP 1 – Know Your Devices

The first step in our installation process will be to determine what type of serial ports you are connecting to the terminal. The Communications section in the Introduction chapter describes the differences between a DTE and DCE serial device. Determine what type of devices you are using (a DTE host, a DCE modem, a DTE printer, a parallel printer, etc.).

STEP 2 – Physical Connections

Depending on the types of serial interfaces of your devices, you may need one or more “null modem” adapters to communicate properly.

First, refer to the Common Setups diagrams later in this chapter. If one of these setups matches your needs, then make the connections as shown in the diagrams by referring to the Host/Printer Connection. Each cable connection in the diagram (the lines with arrows on each end) has a letter next to it.

The letters correspond to the letters in the Host/Printer Connection Guide. If these set-ups don’t apply, then choose the connections in the Host/Printer Connection Guide that are appropriate.

Your physical connections are now complete.

STEP 3 – Number of Sessions Selection

This step requires setting a selection in the Setup menu to configure the terminal for single or dual session mode.

If you've connected two host cables (A or C AND B or D), and you wish to run in "dual session" mode, enter Setup and set "Sessions=Two" in the Quick (F1) menu. For single host operation, this setting should already be set at "One" since this is in the default state.



To access the Setup menu, press Ctrl-Scroll Lock on a PC-style keyboard or F3 on an ANSI keyboard.

STEP 4 – Linking Ports to Sessions

If you have selected "Sessions=One," then you can skip to Step 5. If you have selected "Sessions=Two," there are four designations to make. This step will be used later in Step 7.

First, you have to decide which serial port will be assigned to your first host in Session 1 (either EIA, Aux, or None). Now, decide which port will be used for your second host in Session 2 (EIA, Aux, or None). The same port should not be used as the host port for both sessions. Then, determine which port will be used as the printer port in Session 1 (EIA, Aux, Parallel, None). Do the same for the printer option in Session 2.

Note that it is not general practice to assign the host port in one session as the printer port in another session, but this can be done if desired.



If RS-422 daughter board is installed in the EIA port, it cannot be used with a printer.

STEP 5 – No Printer Option

If you did not opt to install a printer (did not complete E, F, G, or H), you must set the Printer portion of the Host/Printer selection in the Quick (F1) Setup menu to "None." Choose the combination of Host/Printer that properly represents which terminal port you are connecting the host to, and "None" as the printer. For example, if the EIA port is connected to the host or modem, the setting would be "EIA/None."

If you are running in dual session mode, press Ctrl-Enter (num). Now, set the Printer portion of Host/Printer to "None" in Session 2, preserving the current Host setting.

STEP 6 – Know Your Serial Port(S) Protocol

Consult your system administrator to find out the communication settings on all the serial devices you've connected to, including EIA (or Aux) baud, data bits, stop bits, parity, parity checking on/off, Xmt and Rcv flow control protocol. This could include one or two hosts/modems, or a serial printer. Record this information on the User Settings later in this chapter for reference in Step 7.

STEP 7 – Communications Setup Selections

To complete this step, you must recall the letters next to the connections that you made in Step 2. Also, you must be aware of the port/session designations made in Step 4 (see the Host/Printer Connection diagrams later in this chapter).

The procedures below correspond directly to the individual connections made. Notice that only certain connection procedures are to be followed, not all of them. For example, if you've made connections "C" and "F," to a modem and a serial printer, then follow connection procedures "C" and "F" below.



Only follow those steps that apply to your connections (A-H).



To access the Setup menu, press Ctrl-Scroll Lock on a PC-style keyboard or F3 on an ANSI keyboard.

Connection A: Host DCE

1. Enter the Setup menu. If the EIA port is to be assigned to Session 2, then switch sessions (Ctrl-Enter (num)). Remain in session 1, if it is to be assigned to that session.
2. In the Setup Quick (F1) menu, set the Host portion of the "Host/Printer" selection to "EIA" without changing the current Printer option ("EIA/xxxx"). The Printer will be set in another connection procedure if needed.
3. In the Ports (F6) menu, set the proper communications settings for the EIA Baud, EIA Data Format, EIA Parity Check, EIA Rcv, and EIA Xmt selections. See the Setup chapter for more information on the individual settings.

Connection B: Host DTE

1. Enter the Setup menu. If the Aux port is to be assigned to Session 2, then switch sessions (Ctrl-Enter (num)). Remain in session 1, if it is to be assigned to that session.
2. In the Setup Quick (F1) menu, set the Host portion of the "Host/Printer" selection to "Aux" without changing the current Printer option ("Aux/xxxx"). The Printer will be set in another connection procedure if needed.
3. In the Ports (F6) menu, set the proper communications settings for the Aux Baud, Aux Data Format, Aux Parity Check, Aux Recv, and Aux Xmt. See the Setup chapter for more information on the individual settings.

Connection C: RS-232 with Modem

1. Follow all procedures of Connection A, step 1 through step 3.
2. If you are connecting to a modem, in the Ports (F6) menu, set the "EIA Modem Control" parameter to "On".

Connection D: RS-232-C with Modem

1. Follow all procedures of Connection B, step 1 through step 3.
2. If you are connecting to a modem, in the Ports (F6) menu, set the "Aux Modem Control" parameter to "On".

Connection E: Printer

1. In the Setup Quick (F1) menu, set the Printer portion of the "Host/Printer" selection to "EIA" without changing the current Host option ("xxxx/EIA"). The Host will be set in another connection procedure if needed.
2. Follow procedure of Connection A, step 3.

Connection F: RS-232-C Printer

1. In the Setup Quick (F1) menu, set the Printer portion of the "Host/Printer" selection to "Aux" without changing the current Host option ("xxxx/Aux"). The Host will be set in another connection procedure if needed.
2. Follow procedure of Connection B, step 3.

Connections G and H: Parallel Printer

1. Enter the Setup menu. If the PARA port is to be assigned to Session 2, then switch sessions (Ctrl-Enter (num)). Remain in session 1, if it is to be assigned to that session.
2. In the Setup Quick (F1) menu, set the Printer portion of the "Host/Printer" selection to "Para" without changing the current Host option ("xxxx/ Para").
3. Repeat this procedure if the parallel port is going to be used to print from *both* sessions.



Only one session can access the parallel printer at one time. If a print mode (Aux on, etc.) is on in both sessions, an error message will appear. To disable a print mode in a session, press Shift-Scroll Lock on a PC-style keyboard or Shift-F3 on an ANSI keyboard.

STEP 8 – Emulation Setup Selection

This step requires setting a selection in the Setup menu to configure the “Emulation” for one or two sessions of the terminal. Determine which emulations your applications run with.

Enter the Setup menu and set the “Emulation” parameter, in the Quick (F1) menu, to match your requirements. If you are running in dual session mode, press Ctrl-Enter (num). Now, set the “Emulation” parameter in Session 2.

STEP 9 – Additional Setup Options

At this point, you should proceed to the Setup chapter and continue to set up your own selections for any other parameters such as those for the display, keyboard, function/edit keys, and tabs.

Remember to repeat this procedure for Session 2 if you are running in dual session mode. Use Ctrl-Enter (num) to access this set of parameters.

STEP 10 – Save Parameters

Finally, remember to save your Setup parameters in permanent memory, so that they can be recovered if the terminal is powered down. When you exit the Setup menu, the prompt “Save all? (Y/N)” flashes. To save parameters, press “Y”. Another way to save parameters is to perform a “Save Terminal” operation, while in the Exec (F13/Prnt Scrn) menu of Setup. Both methods will save the parameters in both sessions, as well as those that are common to both.



Remember to save your Setup settings after the entire installation process.

STEP 11 – Establish Communications

Your installation is now complete. By pressing the Return or Enter key, you should be able to communicate with the host computer(s). The printer should respond to the local print command, Shift-Ctrl-. (period on numeric keypad).

If for some reason, your installation was not successful, make sure your physical connections are secure, that the communications protocol settings match your devices and that the Setup selections are chosen to provide a proper interface between the terminal and your devices.

If you continue to have problems installing the terminal, call your local dealer for technical support.

Common Setups

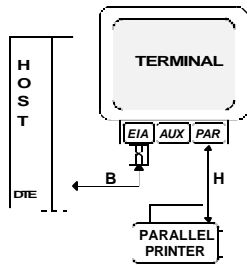

Sessions=One
 Host/Printer=EIA/Para
 EIA Baud, EIA Data Format, etc.
 matches the host

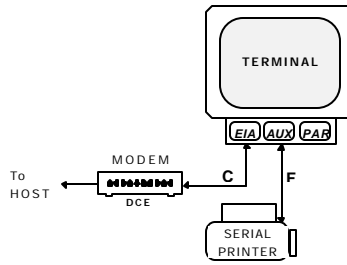

Sessions=One
 Host/Printer=EIA/Aux
 EIA/Baud, etc. matches the host
 Aux Baud, etc. matches the printer
 EIA Modem Control=On

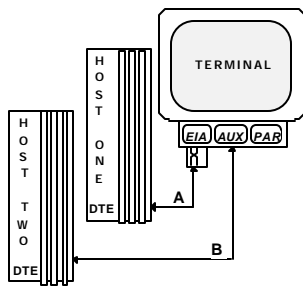



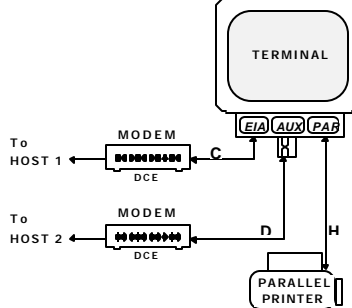

Sessions=Two
 Session1 Host/Printer=EIA/None
 Session2 Host/Printer=Aux/None
 EIA Baud, etc. matches host 1
 Aux Baud, etc. matches host 2



Sessions=Two
 Session1 Host/Printer=EIA/Para
 Session2 Host/Printer=Aux/Para
 EIA Baud, etc. matches host 1
 Aux Baud, etc. matches host 2
 EIA Modem Control=On
 Aux Modem Control=On



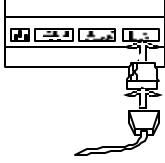
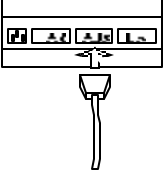

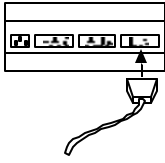
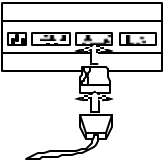
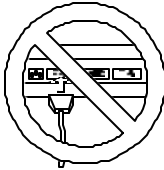
Host/Printer Connection Guide

 CAUTION: Do not (un)plug in electrical storm.

	SE1-EIA (DTE)	SES-AUX (DCE)	PA
<p>DTE Host*</p> 	 <p>Connection A: Connect a null modem adapter between the host cable and the EIA port.</p>	 <p>Connection B: Connect the host cable directly to the AUX port.</p>	 <p>Not applicable.</p>
<p>DCE Host or Modem</p> 	 <p>Connection C: Connect the host or modem cable directly to the EIA port.</p>	 <p>Connection D: Connect a null modem adapter between the host or modem cable and the AUX port.</p>	 <p>Not applicable.</p>

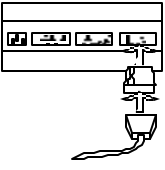
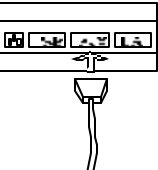
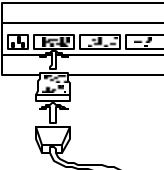

* Most host computers are configured as DTE devices. The ADDS Mentor® System is an example of a DCE host system. The above connections assume RS-232 configuration for the EIA port.

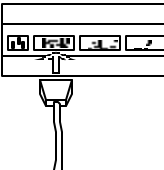
	SE: 1-EIA (DTE)	SES -AUX (DCE)	PAR
<p>DTE Serial Printer**</p> 	 <p>Connection E: Connect a null modem adapter between the serial printer cable and the EIA port.</p>	 <p>Connection F: Connect the serial printer cable directly to the AUX port.</p>	 <p>Connection G: This is an option if you connect a parallel-to-serial converter between the serial printer cable and the PAR port.</p>
<p>Parallel Printer (Centronics/IBM)</p> 	 <p>Not applicable.</p>	 <p>Not applicable.</p>	 <p>Connection H: Connect the parallel printer cable to the PAR port.</p>



** Most serial printers are configured as DTE devices. The above connections assume RS-232 configuration for the EIA port.

User Settings

Use the chart below to document your system and terminal settings:

Parameters	Examples:	Your Settings:
------------	-----------	----------------

Connections made Number of sessions Host/Printer (Session 1)* Host/Printer (Session 2)* Emulations (Session 1) Emulations (Session 2)	C, D and H 2 EIA/ ara Aux lone IBM :151 ADC : VP	
Host 1: Baud Data Bits Stop Bits Parity Parity Check Flow Control (In)** Flow Control (Out)*** Modem Control	9600 8 1 Non Off Xon :off Xon :off On	
(Dual Host mode only) Host 2: Baud Data Bits Stop Bits Parity Parity Check Flow Control (In)** Flow Control (Out)*** Modem Control	19200 7 2 Odd On DTF (or DSR) DTF (or DSR) Off	

* In most cases, these parameters should not be the same.
 ** Incoming flow control on the host should correspond to "EIA (or Aux) Rcv."
 *** Outgoing flow control on the host should correspond to "EIA (or Aux) Xmt."

chapter

3

Setup

The Setup menu is your control panel for this terminal. It permits you to configure the terminal to communicate with the host computer as well as to suit your personal preferences.

Overview

The Setup menus have been designed to allow maximum flexibility with a minimum investment of time. Thirteen menus provide you with the flexibility and the features below contribute to ease of use:

- The Quick menu is the first screen upon entry. It contains the parameters critical to the operation of the terminal with the host.
- Function keys permit easy access to any menu. The function keys are labeled at the top of every menu.
- Setup is "smart." That is, it provides only the options that are valid for the hardware and current emulation.
- Keystrokes and Help Messages are at the bottom of every menu.
- Valid choices for the selected parameter are displayed at the bottom of the menu.

Entry and Exit



PC-Style Keyboards: Press Ctrl-Scroll Lock to both enter and exit setup. Also, press Esc or Pause to exit.



IBM 3151 emulation: Press Ctrl-Setup to both enter and exit setup.



ANSI Keyboard: entry is dependent upon the Setup selections:

- When "F1 to F5 keys" = Local, press F3 to enter.
- When "F1 to F5 keys" = FKey, press Ctrl-F3 to enter.
- When "Key Mode" = Scan Code, press Ctrl-Select to enter.

Saving Parameters

Upon exiting setup mode, the prompt "Save All (Y/N)" blinks. Press Y or y to exit setup and save settings in permanent (nonvolatile) RAM. Press C or c to cancel the exit request. Press

N or n to exit Setup. The changes will take effect, but will be lost if the terminal is reset or powered off.



An exception to this is function/edit key and answerback message programming. Once edited in Setup, the changes are saved regardless of the way in which you exit Setup.

Movement Inside Menus

F1 through F12: Select the menu that corresponds to the function key. Access to the "EXEC" menu is available using either the Print (PC-style keyboards) or F13 (ANSI keyboard) key. The keys are labeled at the top of each menu.

Cursor Control Keys (↑ ← ↓ →): These keys control movement to parameters within the menu and is indicated by a highlighted selection bar. This selection bar will wrap to the other side of the menu at the top, bottom and side boundaries. For each parameter there are at least two choices. As the parameter is highlighted, the available choices appear in the area above the help bar.



Some parameters are action fields and have no choices. See the Action Fields section later in this chapter.

Enter and Shift-Enter: Cycle "up" or "down" through the choices for a given parameter.



The following keystrokes are also available but are not documented in the Setup help bar.

Tab and Shift-Tab: Move from menu to menu forward or backward without using function keys.

Space and Shift-Space: Cycle through the list of choices. Same as Enter and Shift-Enter.



Parameters that are changed are executed as soon as that field is exited. Page resets may occur when certain choices are made in Setup.



Action Fields



Certain parameters are not selections but action fields. When the action field is highlighted and then selected, the action is taken. A "WAIT" message may appear at the top right portion of the screen, and when the action is completed, a "DONE" message will appear. These messages are cleared when the selection bar is placed on another parameter.

Dual Session Mode

There are two "sets" of "session" setup parameters, if you are using the terminal in dual session mode. To toggle between sessions while in or out of setup mode, press Ctrl-Enter (num). For a complete explanation of session dependent and terminal dependent parameters, see the Glossary of Terms section at the end of this chapter.

Setup Map

Key	Menu	Parameters Available (Not all will display for a given emulation, keyboard, or video mode)		
F1	Quick	Emulation Enhanced EIA Data Format Aux Data Format	Comm Mode Language Host/Printer	EIA Baud Rate Aux Baud Rate Sessions
F2	General	Emulation Auto Font Load Monitor Mode Warning Bell Session Display	Enhanced Auto Page Screen Saver Cursor Dir Bell Length	Auto Wrap Auto Scroll Bell Volume Sessions Setup Language
F3	Display	Page Length Display Cursor Columns	Screen Video Scroll Width Change Clear	Cursor Overscan Borders Auto Adjust
	Cursor	Screen Length Refresh Rate Viewport 1 Bottom Row Viewport 2 Bottom Row	Speed Pages	Viewports
F4	Keyboard	Language Margin Bell Key Lock Num Lock	Key Repeat Key Mode Key Rate Code Page	Keyclick Char Set Caps Lock
F5	 Keys	Enter Key Alt Key Return Key Repeat UDKs Insert Character	Return Key Pound Key Desk Acc New Line	Backspace Local Leadin Disconnect Send Key
	 Keys	Enter Key Compose Key Return Key Repeat ,, and .. key UDKs	Return Key Pound Key F1 to F5 keys ' and ~	Del key Local Leadin Disconnect <> key
F6	Ports	EIA Baud Rate Aux Baud Rate EIA Xmt Aux Xmit	EIA Data Format Aux Data Format EIA Recv Aux Recv	EIA Parity Check Aux Parity Check EIA Xmt Pace Aux Xmt Pace

Key	Menu	Parameters Available		
		(Not all will display for a given emulation, keyboard, or video mode)		
F7	Host	Comm Mode Recv Send Block Term Null Suppress Line Control Send Null Suppress	Local Send ACK Send Region Alt Input Data Disconnect Ignore CTS	Recv <CR> Send Line Term Send End Break Turnaround Char Modem Control
F8	Print	Prnt Line Term Prnt Mode Indep Pass Thru	Prnt Block Term Secondary Recv	Prnt Region Print Chars
F9	Emulation 	Attribute Page Edit WPRT Underline Save Labels Enhanced Attributes Set Control	Bright Video WPRT Intensity WPRT Blink Char Set WP-Graphics	Fkey Speed WPRT Reverse Display NV Labels Status Line Force Insert
	Emulation 	Numeric Kpd Status Line WP-Graphics	Cursor Kpd ANSI-ID Function Key Lock	Send Data Char Set Feature Lock
	Emulation 	Char Set Force Insert	Status Lome Set Control	WP Graphics
F10	Tabs	Auto Init Tabs	Default Tabs	Tab
F11	Answerback	Answerback Mode	Answerback Conceal	
F12	Program	Key	Program	Key Dir
PrtSc	Execute	Save Terminal Save Session Reset Terminal Clear Screen	Recall Terminal Recall Session Reset Session Default Session UDks	Default Terminal Default Session Reset Ports
Pause or Ctrl-Setup	Exit Setup	Save all parameters? (Y/N)		

QUICK: F1

Quick	F2 Genrl	F3 Disp	F4 Kybd	F5 Keys	F6 Ports	F7 Host	F8 Print	F9 Emul	F10 Tabs	F11 AnsBk	F12 Prog	Print Exec
Parameters												
Emulation=IBM 3151			EIA Baud Rate=9600			EIA Data Format=8/1/N						
Enhance=On			Aux Baud Rate=9600			Aux Data Format=B/1/N						
Comm Mode=Full Duplex			Language=U.S.			Sessions=One						
Host/Printer=EIA/Para												
Choices												
ADDS VP		Wyse 60		Wyse 50+		PC Term		VT300/7	VT300/8	VT200/7		
VT200/8		VT100		SCO Console		IBM 3151	TVI 925	AT386				
Select												
↑ → ↓ ← : Parameter				Enter/S-Enter : Next/Prev Choice				Exit : Setup Key				

Emulation: [ADDS VP, Wyse 60, Wyse 50+, PC Term, VT300/8, VT300/7, VT200/8, VT200/7, VT100, IBM 3151, SCO Console, AT386, TVI 925]

Select the "personality" of the terminal (the way in which it responds to commands). Note that SCO Console and AT386 emulations are not available with the ANSI keyboard. If you are using PC-Term emulation, refer to the Local Leadin selection in the Keys: F5 section for access to local "hot keys."



All associated defaults are loaded when the emulation is changed. Default choices are in bold. Some defaults may vary depending on the selected emulation.

Comm Mode: [Full Duplex, Half Duplex, Full Block, Half Block]
Select the method of communication to match the host computer.

EIA Baud Rate: [110, 150, 300, 600, 1200, 1800, 2000, 2400, 4800, 9600, 19200, 38400, 57600, 76800, 115200, 134400]

Select the number of bits communicated per second to match the speed at which the primary host or printer expects to communicate.

Aux Baud Rate: [110, 134.5, 150, 300, 600, 1200, 1800, 2000, 2400, 4800, 9600, 19200, 38400]

The speed at which the secondary host or printer expects to communicate.

Enhanced: [On, Off]

Normally, the terminal responds to a set of commands that correspond to the emulation selected. When Enhanced mode is *on*, the set of commands is extended to those printed in boldface in the Programming chapter.

EIA Data Format: [7/1/N, 7/1/O, 7/1/E, 7/1/M, 7/1/S, 7/2/N, 7/2/O, 7/2/E, 7/2/M, 7/2/S, 8/1/N, 8/1/O, 8/1/E, 8/1/M, 8/1/S, 8/2/N, 8/2/O, 8/2/E, 8/2/M, 8/2/S]

Select a data bits/stop bits/parity combination which matches the data format of the primary host or printer. Parity abbreviations are: O = odd, E = even, S = space, M = mark, and N = none.

AUX Data Format: [7/1/O, 7/1/E, 7/1/M, 7/1/S, 7/2/N, 7/2/O, 7/2/E, 7/2/M, 7/2/S, 8/1/N, 8/1/O, 8/1/E, 8/1/M, 8/1/S, 8/2/N]

Select a data bits/parity bits/stop combination which matches the data format of the secondary host or printer. Parity abbreviations are: O = odd, E = even, S = space, M = mark, and N = none.



Language: [U.S., U.K., Danish, Finnish, French, German, Norwegian, Portuguese, Spanish, Brazilian, Swedish, Dutch, Belgian-Flemish, Fr-Canadian, Italian, Latin American, Swiss-French, Swiss-German, Turkish, Greek, Hungarian, Czech, Slovak, Polish, Rumanian, Slovenian, Croatian, Bosnian, Serbian Latin, Russian, Hebrew]

Select the language type which matches your keyboard's layout.



Language: [U.S., U.K., Danish, Dutch, Finnish, Belgian-Flemish, French, Fr-Canadian, German, Italian, Norwegian, Spanish, Swedish, Swiss-German, Swiss-French, Turkish]

Select the language type which matches your keyboard's layout.

Sessions: [One, Two]

Select the number of sessions that the terminal will run. One session is required per connection to a host. When two sessions are selected, the Setup menu will display the message "Press Ctrl-Enter (Kpd) to Toggle Sessions" at the bottom of the screen. The current session is displayed at the upper left corner of the status line (either by a SES1 or SES2 indicator). To change the active session, press Ctrl and Enter (on the numeric keypad) simultaneously.

Host/Printer: [EIA/Aux, EIA/Para, EIA/None, Aux/EIA, Aux/Para, Aux/None, None/EIA, None/Aux, None/Para, None/None]

The first part of the selection indicates the host (either the EIA port or the AUX port) and the second part of the selection indicates the printer port (if a serial printer is used, either the EIA or Aux port can be used to connect to the printer, but if a parallel printer is being used, the PAR port should be used.) The active session "drives" the printer. EIA/Para is the default for session 1, and Aux/None is the default for session 2.

GENERAL: F2



This chapter lists all possible parameters for each menu, and all possible choices for each parameter. Depending on the emulation selected, and the keyboard mode (ASCII or ScanCode), Setup will only present the valid set of parameters and choices in each menu.

Emulation: Select the “personality” of the terminal. See the Quick menu earlier in this chapter.

Enhanced: Choose whether the terminal can respond to commands beyond the limitations of the current emulation. See the Quick menu earlier in this chapter.

Auto Wrap: [On, Off]

Select whether the cursor drops to the next line when it reaches the right margin or continues to display characters at the right margin. In ANSI emulations, the default is *off*.

Auto Font Load: [On, Off]

Select whether the four font banks (0-3) should automatically be loaded when screen size or the emulation is changed.

Auto Page: [On, Off]

When the cursor is moved off the page using a command that includes scroll and Auto Page mode is *on*, the screen displays the new page. These pages are numbered from 0 to a maximum of 9. When *on*, Auto Page will track the page even if Auto Scroll is *off*. The up-arrow key does not have a scroll command embedded, so it cannot be used to view the previous page even when Auto Page is *on*.

Auto Scroll: [On, Off]

Choose whether the terminal updates the display when the cursor is moved beyond the boundaries of the currently viewed screen.

Monitor Mode: [On, Off]

Choose whether control codes will be displayed as their graphic representations or be acted upon as terminal/cursor commands.

Screen Saver: [Off, 2 min, 5 min, 15 min, 30 min]

Select whether the screen will go blank after lack of activity from the keyboard or the host of the selected period of time. The first key typed at the keyboard when the screen is blank will reactivate the display. The keycode will not be transmitted to the host. The Caps Lock LED (or Lock on the ANSI keyboard) will flash while Screen Saver is active.



Use screen saver to prevent “phosphor burn” on the screen when the display on the terminal is left unchanged for an extended time period.



20 minutes after the screen saver is activated, Energy Star, a power saving feature, is activated. The first key typed at the keyboard brings the energy level back up.

Bell Volume: [0, 1, 2, 3, 4, 5, 6, 7, 8, 9]

Select the bell volume from off [0] to high [9]. This will be the volume for alarm tones, warning bells, and keyclicks.

Warning Bell: [On, Off]

Select whether a warning bell is sounded when errors (such as an invalid compose sequence) are encountered.

Sessions: [One, Two]

Select the number of sessions (hosts) that the terminal will run. See the Quick menu earlier in this chapter.

Session Display: [Full, Split]

When two sessions are used, select whether each host’s data displays on a full screen or if both hosts share a split screen. In either case, the way to toggle between the hosts is by using Ctrl-Enter (num). Both hosts can receive and update data simultaneously. The purpose of toggling is so that keyboard entry can be directed to the selected host. In the

case of a full display, toggling also brings the entire display of the selected host into view.



The selection above is not available in the IBM 3151 emulation.

Bell Length: [140 ms, 350 ms, 570 ms, 780 ms]

Denotes duration of bell sound.

Setup Lang: [US, French, German, Italian, Spanish, Portuguese]

Affects display of setup and the status lines.

Cursor Dir: [right to left, left to right]

This feature affects the direction in which the text is entered (defaults to right to left when Hebrew language is chosen).

DISPLAY: F3

Page Length: [24, 25, 28, 29, 42, 43, 48, 50, 56, 58, 68, 84, 86, 96, 100, 112, 116, (168), (172), (192), (200), *24, *25, *28, *29, *42, *43]



For the IBM 3151 emulation, page length choices are 24, 25, 28, 42, 43, 48, 50.

Select the number of lines per page. As many as ten pages (0-9) may be available, but the number of pages in memory depends on the number of lines per page, the type of emulation, and whether 80-Only is selected for columns. The total lines used (Lines/Page x # of Pages) will not exceed 240. See Page Configurations in Appendix A.

Page lengths which are multiples of 24 or 25 and those that are multiples of 42 or 43 are displayed by default on a 26-line or 44-line screen, respectively. Page lengths which are multiples of 28 or 29 are displayed on a 30 line screen by default. The extra one or two lines on the screen can be used as status lines.

The selections shown in () are not available in dual session mode. If a page length which is preceded by an asterisk (*24, *25, *28, *29, *42, or *43) is selected, the total number of pages will be two, where the first page contains the number of lines in the selection (24, 25, 28, 29, 42, or 43) and the second page contains the remaining allowable lines. See Page Configurations in Appendix A.

Screen Length: [26 Lines, 30 Lines, 44 Lines, 52 Lines]

Select the number of lines that can be displayed on the screen at one time. The page length affects the default screen length.

Screen Video: [Normal, Reverse]

Choose between bright characters on a dark background (normal) and dark characters on a bright background (reverse). In reverse video mode only, the "Enhanced Attributes" parameter is available. See General:F2 section for more details.

Display Cursor: [On, Off]

Choose whether the cursor will be displayed.

Cursor: [Blink Block, Steady Block, Blink Line, Steady Line]

Choose the appearance of the cursor.

Auto Adjust Cursor: [On, Off]

Select whether the screen attempts to follow the cursor down the page by scrolling just enough to keep the cursor in view.

Columns: [80, 132, 80-Only]

Choose the number of columns that the screen can display. 80-Only provides more pages in memory for a given page length by disallowing changes to 132-column display.

Width Change Clear: [On, Off]

Select whether the screen is to be cleared when the number of columns on the screen is changed from 80 to 132 or vice versa.



Changing columns from/to 80-only forces the screen to clear independent of Width Change Clear.

Speed: [Fast, Normal]

Selecting "fast" improves the speed at which screen display occurs at the expense of minor, temporary distortion of text called "tearing."

Scroll: [Smooth 1, Smooth 2, Smooth 4, Smooth 8, Jump]

Choose whether the data on the screen scrolls smoothly or "jumps" to accommodate data at the rate it is received. Select the number of scan lines per second the page scrolls up when smooth scroll is selected. Smooth 1 is the slowest rate and Smooth 8 is the fastest.

Refresh Rate: [60 Hz, 71 Hz, 82 Hz, 100 Hz]

Select the rate (number of times per second) at which the image on your terminal's display is updated. This selection is only available in 26 line display mode.

Overscan Borders: [On, Off]

Choose whether the overscan borders are active. The borders extend video from one edge of the screen to the next. (To see the borders, select *reverse* for Screen Video.)

**Viewports:** [1 2 3]

Select number of viewports (up to 3 viewports can be selected on a page).

Viewport 1 Bottom Row [10]

1 through page length minus 1. This specifies the last row number of the first viewport.



This parameter displays in Setup when number of viewports is greater than 1.

Viewport 2 Bottom Row [20]

2 through page length minus 1. This specifies the last row number of the second viewport.



This parameter displays in Setup when number of viewports is greater than 2.

**Pages [1-8]**

Select the number of pages the user can access. The maximum number of pages is dependent on the page length. The number of pages is defaulted to 1 whenever the page length or columns is changed. The page selection will not display when viewports is greater than 1.

KEYBOARD: F4

Language: [U.S., U.K., Danish, Finnish, French, German, Norwegian, Portuguese, Spanish, Brazilian, Swedish, Dutch, Belgian-Flemish, Fr-Canadian, Italian, Latin American, Swiss-French, Swiss-German, Turkish, Greek, Hungarian, Czech, Slovak, Polish, Rumanian, Slovenian, Croatian, Bosnian, Serbian Latin, Russian, Hebrew]

Select the language type which matches your keyboard's layout.



Language: [U.S., U.K., Danish, Dutch, Finnish, Belgian-Flemish, French, Fr-Canadian, German, Italian, Norwegian, Spanish, Swedish, Swiss-German, Swiss-French, Turkish]

Select the language type which matches your keyboard's layout.

Char Set Mode: [PC, ANSI, ASCII]

Choose which NRC set to use. This selection is only available in National Mode and foreign languages. In VT emulations, the default is *ANSI*. To determine which sets are loaded for each mode, refer to the *3153 Programmer's Reference Guide*.

Key Mode: [ASCII, ScanCode]

Select whether keys transmit ASCII codes or the ScanCode. The ScanCode transmits a "make code" when a key is pressed and a "break code" upon its release. When ScanCode is selected, "Comm Mode" is forced to *Full Duplex* and "Character Set" is forced to *Multinational* (8-bit).

Keyclick: [On, Off]

Choose whether pressing a key results in a clicking sound. The default is *off* in SCO Console emulation and IBM 3151.

Key Repeat: [On, Off]

Choose whether keys, including function keys, will repeat when pressed for more than half a second. This setting does not affect the following keys on the PC-style keyboards: Caps Lock, Scroll Lock, Num Lock, Shift keys, Ctrl keys, Alt keys, Return, Print Screen, Pause. On the ANSI keyboard, the following keys are unaffected: Lock, F1-F5, Shift keys, Control, Compose, and Return.

Key Rate: [15 cps, 20 cps, 30 cps]

When "Key Repeat" is on, a key that is pressed for more than half a second will automatically repeat. This selection allows you to choose the number of characters that are generated per second when a key is auto repeating.

Keyboard Layout: [Q, F]

This selection is only available when Turkish keyboard is selected. Q and F refer to the two Turkish keyboard layouts available. Q and F correspond to the top left key on the alphanumeric keypad.

Margin Bell: [On, Off]

Choose whether a bell tone sounds when the cursor is nine positions away from the right margin.

Key Lock: [Caps, Reverse, Shift]

Affects the state of alphanumeric keys when Caps-Lock is engaged.

- Caps causes alphabetic keys to be uppercase regardless of the shift key.
- Reverse causes the shift key to generate lowercase alphabetic keys.
- Shift causes all alphanumeric keys to be generated as uppercase (or shifted, in the case of numbers). If the Shift key is pressed, while Shift is selected, Caps-Lock will be disengaged.

Caps Lock: [Toggle, Always On, Always Off]

This setting effects the state of the Caps Lock key. When set to always on or always off the key has no effect. When set to toggle, the terminal will power on in the off mode and pressing the key will alternate between the off mode and the on mode.

Num Lock: [Toggle, Always On, Always Off]

This setting effects the state of the Num Lock key. When set to always on or always off the key has no effect. When set to toggle, the terminal will power on in the off mode and pressing the key will alternate between the off mode and the on mode.

Code Page: [DEC Multi, PC 437, PC 850, PC 852, PC 857, PC 860, PC 861, PC 862, PC 863, PC 865, PC 866, PC 869, ISO-1, ISO-2, ISO-5, ISO-Hebrew, ISO-Cyrillic, ISO-Greek]

This selection is only available in 8-bit emulations in Multinational Mode. The default code page is based upon language and emulation selected. To determine which sets are loaded for each code page, refer to the *3153 Programmer's Reference Guide*.

KEYS: F5**Return Key:** [CR, CR-LF, TAB]

Select the code the return key on the main alphanumeric keypad transmits.

Enter Key: [CR, CR-LF, TAB]

Select the code the enter key in the numeric keypad transmits.

Alt Key (left): [Meta, Compose, Funct, Scroll-Lock, Alt Key]

Select the way in which the left ALT key (or the Compose key on the ANSI keyboard) behaves. The *Alt Key* selection refers to the right Alt key.

- Meta – sets the most significant bit for the next character and allows 8-bit data to be generated from the keyboard.
- Compose – precedes sequences of keys to create a character that is not on the keyboard but is available in the active character set.
- Scroll Lock – causes the Alt key to function as the Scroll Lock key, and is a toggle to hold/free data on the screen. It requires the use of flow control for the host port Rcv Prtcl.
- Funct – causes the Alt key to function as the Funct key on an ASCII keyboard.
- Alt Key – causes the left Alt key to behave identically to the right Alt key.

Pound Key: [U.S., British]

Choose the character transmitted for 23h—the US pound (#) or the British pound (£).

Return Key Repeat: [On, Off]

Select whether the Return key located on the alphanumeric keypad will repeat when held down for more than half a second (only selectable when "Key Repeat" = On).

**Return Key:** [Field, New Line]

When the Return Key = *New Line*, the functions specified in the New Line parameter are performed. When the Return Key = *Field*, the functions specified in the New Line parameter are performed unless the target line is within a protected field. The cursor will then move to the first character position of the next unprotected field.

**Enter Key:** [Send, Return]

The Enter Key can be defined to be either a Send or Return Key.

**New Line:** [<CR>, <CR><LF>]

This parameter specifies the codes generated when the return key is pressed.

**Send Key:** [Page, Line]

The contents of the current page is sent to the host when the Send Key is pressed and Send Key is selected for page. The Contents of the current line is sent to the host when the Send Key is pressed and Send Key is selected for line.

**Insert Character:** [Mode, Space]

- Mode – enters insert mode when the insert key is pressed.
- Space – a space character is inserted at the current cursor position when the insert key is pressed.

**Local Leadin:** [On, Off]

This parameter is only available when *Key Mode* (in the Kybd menu) is ScanCode. If Local Leadin is *off*, the only local function, shown in Appendix A, that is available is Ctrl-Scroll Lock (Ctrl-Select on the ANSI keyboard) to enter Setup. If Local Leadin is *on*, the Setup keystroke “introduces” the keystroke as local and then local functions can be generated using the keystrokes listed in Appendix A. For example, to enter Setup when ScanCode and Local Leadin are *on*, press Ctrl-Scroll Lock to introduce this as a local function (“LEAD” will appear in the status line), and then Ctrl-Scroll Lock (Ctrl-Select on the ANSI keyboard) to enter Setup.



Local Leadin will not work if Comm Mode is set to Half Block or Full Block.



The following selections apply to the PC-style keyboards:

Disconnect: [Disabled, Pause, Alt-Pause]

Select the keystroke that will generate a modem disconnect.

Backspace: [BS/DEL, DEL/BS, DEL/CAN, BS/BS]

Choose the codes sent by the backspace key in the normal/shifted positions.

Desk Acc: [Ctrl ←, Disabled]

Select how the Desk Accessories can be accessed. This selection does not appear when SCO Console emulation is selected. In SCO Console emulation, Ctrl ← is the only access method.

The default allows the desk accessories to be accessed through a menu which appears when Ctrl and the left arrow key are pressed simultaneously. This brings up a pop-up

window; selections for the specific accessory can be made from that menu by pressing F1-F5. The Sh-Ctrl-Fkeys option, when selected, allows direct access to desk accessories (bypassing the menu) by pressing Sh-Ctrl-F1 through Sh-Ctrl-F5. Selecting *Disabled* will inhibit entry to desk accessories. Once a desk accessory is displayed, any other desk accessory can be accessed by pressing only the function key associated with it (without pressing Sh-Ctrl).

UDKs: [Emul Dependent, User Dependent]

Choose whether the UDKs should get defaulted when the host changes the emulation.



The following selections apply only to the ANSI keyboard:

Disconnect: [Disabled, **Shift-F5**]

Choose to allow the keystroke that will generate a modem disconnect on the ANSI keyboard or to disable the Disconnect function. Note that if "F1 to F5 keys" is *Fkey* in Setup, the Disconnect function will be remapped to Ctrl-Shift-F5.

F1 to F5 keys: [Local, **Fkey**]

This selection determines whether the first five keys, labeled F1-F5, serve as local keystrokes (for example, F3 allows access to Setup) or will serve as function keys which are loaded with the default strings. (Only reprogrammed strings are visible in the text area for a given function or edit key; the default strings are not visible in Setup.)



If *Fkey* is selected, then the keystroke to enter Setup becomes Ctrl-F on the ANSI keyboard.

With the three remapping selections, keys which are available on a PC-style keyboard are now available on the ANSI style keyboard: [ESC] [^~], and .,.

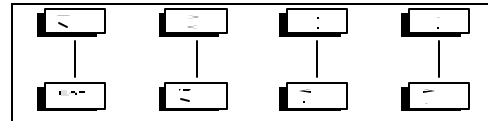

The three selections should either be kept in their defaults (as they appear on the keyboard), or all three should be changed to follow the mapping scheme described here.

^~ Key: [^ and ~ or ESC]

Select the characters sent by the tic/tilde key.

<> Key: [< and > or ^ and ~]

Select the characters sent by the triangle bracket key in the normal and shifted positions.

,, and ., Keys: [, and ., or ,< and .>]

Select the character sent by the comma and period keys in the normal and shifted mode.

Backspace: [BS/DEL, DEL/BS, DEL/CAN]

Choose the codes sent by the key in the normal/shifted positions.

Compose Key: [Meta, Compose, Funct, Scroll-Lock, **Alt Key**]

This selection indicates the role that the Compose key will play. The explanation of choices is the same as for the Alt Key (left) selection, which is discussed earlier in this section.

PORTS: F6

EIA Baud Rate: [110, 150, 300, 600, 1200, 1800, 2000, 2400, 4800, 9600, 19200, 38400, 57600, 768000, 115200, 134400]

See the **Quick** menu earlier in this chapter.

EIA Data Format: [7/1/N, 7/1/O, 7/1/E, 7/1/M, 7/1/S, 7/2/N, 7/2/O, 7/2/E, 7/2/M, 7/2/S, 8/1/N, 8/1/O, 8/1/E, 8/1/M, 8/1/S, 8/2/M, 8/2/N, 8/2/O, 8/2/E, 8/2/S]

See the **Quick** menu earlier in this chapter.

EIA (Aux) Parity Check: [On, Off]

Choose whether the parity bit will be checked. When parity check is on and the parity bit received is inconsistent with the data received, indicating an error in communications, an asterisk (*) 2Ah is displayed instead of the character.

Aux Baud Rate: [110, 134.5, 150, 300, 600, 1200, 1800, 2000, 2400, 4800, 9600, 19200, 38400]

See the **Quick** menu earlier in this chapter.

AUX Data Format: [7/1/O, 7/1/E, 7/1/M, 7/1/S, 7/2/N, 7/2/O, 7/2/E, 7/2/M, 7/2/S, 8/1/N, 8/1/O, 8/1/E, 8/1/M, 8/1/S, 8/2/N]

See the **Quick** menu earlier in this chapter.

EIA (Aux) Recv: [No Protocol Xon-Xoff (XPC), Xany-Xoff (XPC), DTR (DSR), Xany-Xoff/DTR (DSR)]

Choose the form of flow control for data received from the primary or secondary host. Software flow control uses *Xon-Xoff* DC1 (11h) and DC3 (13h). *xpc* is used by "Scan Code" mode because it uses DC1 and DC3 as data. *Xany-Xoff (XPC)* is similar to Xon-Xoff, except that any character transmitted to the host is treated as an Xon, so data from the terminal is buffered, rather than being sent to the host. *DTR (DSR for Aux)* relies on the hardware signal DTR or DSR (pin 20 or pin 6) from the device. *Xany-Xoff/DTR (DSR)* uses software and hardware flow control



Flow control is recommended to protect against data loss.

EIA (Aux) Xmit: [No Protocol, Xon-Xoff, DSR (DTR), Both]

This is similar to "EIA (Aux) Recv," except that it applies to the data transmitted from the terminal to the primary or secondary host or printer. DSR is the hardware signal for Data Set Ready (pin 6).



In ADDS™ VP emulation and WP Graphics mode DC1 and DC3 can be interpreted as data and should not be selected as a form of Protocol.

EIA (Aux) Xmt Pace: [Baud, 35 cps, 60 cps, 150 cps]

Define the maximum number of characters per second that the terminal can transmit. When a characters limit (35 cps, 60 cps, or 135 cps) is set, the delays are averaged between characters for the selected baud rate. This is also known as "pacing." The *Baud* option provides no pacing, allowing data to be transmitted at the specified baud rate.

HOST: F7

Break: [250 ms, 170 ms, 500 ms, Off]

Choose the duration of the break signal in milliseconds. This is an interruption in data flow, and can be disabled.

Modem Control: [On, Off]

If a modem is being used to communicate with the primary or secondary host, modem control should be on. To perform a disconnect, the terminal drops the DTR signal. In full duplex, the terminal keeps RTS high and checks for a CD signal before sending data to the modem. In half duplex, it raises RTS and awaits a clear-to-send (CTS) signal from the modem before sending data.

Disconnect: [2sec, 60ms]

Select the maximum time period that the modem can be disconnected (or the modem line be down) before the terminal performs a Modem Disconnect. This occurs if "EIA (Aux) Modem Control" is *on*.

Comm Mode: [Full Duplex, Half Duplex, Full Block, Half Block]

Select the communications mode.



Half-duplex is not available when KeyMode is *ScanCode*.

Receive <CR>: [<CR>, <CR><LF>]

Select the way in which carriage returns received will be interpreted.

Receive : [Ignore, Destruct <BS>]

Choose to ignore the DEL control code (7Fh) when received or to treat it as a Destructive Backspace code.

Send ACK: [Off, On]

Decide whether the terminal should respond to inquiry (05h) or when certain terminal functions are performed (configuring the EIA (Aux) ports, splitting screen, etc.) with the ACK (06h) character.

Null Suppress: [On, Off]

In the default mode, the host ignores all received nulls (00 hex). When *off* is selected, the terminal will accept all received nulls, and act upon them according to the selected emulation.

Send Line Term: [<US>, <CR><LF>]

Select which line terminator is sent. <US> is 1Fh and <CR><LF> is 0Dh 0Ah.

Local: [Off, On]

Select whether keyed data is interpreted locally by the terminal and not sent to the host. Data sent by the host is lost, if Local is *on*. The ability to print data is not affected by this mode.

Send Block Term: [<ETX>, <CR>]

Select which character will indicate the end of a block. The choices above are for ASCII emulations. ANSI emulations have the following choices: [None, FF].



Send End: [Cursor, Region]

Select whether the end is indicated by the scroll region or by the cursor location.



Send Region: [Screen, Scroll]

Choose whether the terminal sends data from the entire screen or from the scrolling region.

Ignore CTS: [Off, On]

Ignore CTS is not displayed in IBM 3151 emulations



Line Control: [CRTS, PRTS, IPRTS]

- PRTS* (permanent request to send) – PRTS handles the CTS and DSR signal as modem signals.
- IPRTS* (induced permanent request to send) – IPRTS handles the CTS and DSR signals as if the signals are always on.
- CRTS* (controlled request to send) – CRTS looks at the CTS, DSR and CD signals to determine when the terminal can send or receive data.



* PRTS and IPRTS require full duplex communication capabilities.
CRTS requires half duplex communication capabilities.



Turnaround Char: [<ETX>, <CR>, <EOT>, <DC3>]

The line turnaround character is attached to the end of a data stream when one of the read commands is received or one of the following keys is pressed:

Send	Send Line
Reset (if reset attn is enabled)	Clear
Print (if print key attn is enabled)	F1 thru F36
Print line (if print key attn is enabled)	PA1 thru PA3
Print Msg (if print key attn is enabled)	Sn Msg



Send Null Suppress: [Off, On]

- Off – Trailing null characters are converted to space characters when data is sent to the host system.
- On – Trailing null characters are removed when data is sent to the host system.

PRINT: F8



Print Mode: [Normal, Auto, Controller]

Select the way in which printing is controlled.

- **Normal** – indicates that printing is to occur when a print request (such as print screen) is received.
- **Auto** – prints a line when the terminal receives a LF, a FF, or a VT code, or when autowrap occurs.
- **Controller** – indicates that host data is sent to the printer (pass through mode). Printing is controlled by the host computer.

Print Block Term: [<ETX>, <CR>]

Select the character which indicates to the printer that the block of data to be printed has ended. The options above are for ASCII emulations. In ANSI emulations, the choices are [None, <FF>].



Print: [National, Line Drawing, Multinational]
Choose the set of characters used when printing.



Print Region: [Screen, Scroll]

Indicate the region of the screen that is to be printed: the entire screen or a certain section of it called the scrolling region. A scrolling region is a limited portion of the screen which applications (such as word processors) may designate to be the user's region.



Print Line Term: [<US>, <CR><LF>]

Indicate the character that <R> is to terminate a line of print.

Secondary Recv: [Off, On]

When "on," data received from the serial printer is routed to the port assigned for the host. This data is not displayed on the screen, and is transparent to the user. When "off," data received from the printer port is ignored.



Independent Pass Thru: [Off, On]

When independent pass-through printing is enabled, the host system can concurrently send data to the terminal and to the printer. When a low speed printer is attached to the terminal, it allows print operations to continue without suspending normal terminal operations.

EMULATION: F9

The parameters displayed in this menu depend upon the current emulation. This section is divided between parameters for ASCII and ANSI emulations.



ASCII Emulations

Page Edit: [Off, On]

When page edit is *on*, edit features such as insert act upon text to the end of the current page.

WPRT Intensity: [Dim, Normal, Suppress]

Choose the intensity of write protected characters. Suppress indicates that the character's foreground is the same as its background with the effect of "suppressing" output.

WPRT Underline: [Off, On]

Choose whether write-protected characters are underlined.

WPRT Blink: [Off, On]

Choose whether write-protected characters blink.

WPRT Reverse: [Off, On]

Choose whether write-protected characters display in reverse video.

Fkey Speed: [Fast, Normal]

Selects the speed at which function keys and labels are programmed by the host. Fast mode will increase the speed for Wyse 50 compatibility, but will limit the amount of space in each function key and answerback message to 8 bytes. Edit keys are not

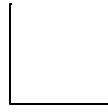
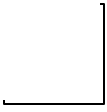

available for programming in fast mode. Changing this selection will default all function keys, edit keys, and function keys labels.

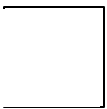

Save Labels: [Off, On]

When *on*, labels that are downloaded by the host will be saved in non-volatile memory. If this selection and Display NV Labels are *off*, labels written by the host would be lost upon entry and exit to Setup.

Attribute: [Char, Line, Page]

Choose the extent to which attributes are propagated. (The only parallel ASCII emulations are PC Term and Wyse 60.)

Display NV Labels: [On, Off]

Select whether the labels in non-volatile memory are displayed on the lowest line. When *off* is selected, any existing labels will remain on the screen, until *on* is selected, and they are re-displayed. On a 26-line screen, they are displayed below line 24. On a 44-line screen, labels are displayed below line 42, and on a 52-line screen, they are displayed below line 50. (The top line is the top status line and cannot be used for data.) If the page length used is a multiple of 25 (instead of 24) and the screen length is 26 lines, then the last data line is used for data and labels will not be displayed regardless of this setting. The same is true for a page length that is a multiple of 43 (instead of 42) with a screen length of 44 lines.

Status Line: [Standard, Extended, Off]

Select the type of the status line. In *standard*, cursor row and column, session indicator, print indicator, Caps Lock, and communications mode are displayed. In *extended*, only session indicator, Caps Lock, communications mode, protect and write protect are displayed.

Char Set: [National, Multinational]

Select whether the character set used is the 7-bit national chart or the 8-bit multinational chart when Language is not U.S. If U.S. is chosen, the character set is *multinational*.

Enhanced Attributes: [Off, On]

When set to *on*, gives a better display presentation in overscan and reverse video modes. The blink and dim video attributes will affect the foreground text instead of the background. This selection is only available in reverse video mode, on a per-session basis, and is disabled in a "split" display screen.

Bright Video: [Off, Mode 1, Mode 2]

Provides a brighter display when set to Mode 1 or Mode 2. In Mode 1, both normal and dim text are brighter than in the standard mode. In Mode 2, only normal text is brighter, resulting in a greater contrast between normal and dim text.



This parameter setting affects both sessions, but will not affect an AN SI emulation in the inactive session.

WP-Graphics: [Off, On]

Selects whether Word Perfect Graphics commands are processed or ignored.



ANSI Emulations

Numeric Kpd: [Numeric, Application]

Choose the set of strings sent by the numeric keypad.

Cursor Kpd: [Cursor, Application]

Choose the set of strings sent by the cursor control keypad.

Send Data: [All, Erasable]

Choose whether the data sent to the host is all data (erasable and selectively erasable) or only those characters tagged as erasable.

ANSI-ID: [VT100, VT101, VT102, VT220, VT320]

Select the terminal's identification.

Function Key Lock: [Off, On]

Select whether the function keys are locked or modifiable by the host.

Key Usage: [Typewriter, Data Process]

This selection is available for all language selections except U.S. It applies to keys that have two characters printed side-by-side to select which character is sent by that key. Typewriter selects the character printed on the left side while Data Process selects the character printed on the right side of the keycap.

Char Set: [Multinational, National]

Select whether the character set used is from the 7-bit national chart or the 8-bit multinational chart. The default is the 8-bit multinational character set except when the emulation is VT100.

Feature Lock: [Off, On]

When on, the host cannot change user features: key repeat, scroll speed, screen background, tab stops, and keyboard lock.

Status Line: [Off, Indicator, Host-Write, Both]

Specify the way in which the status line is to be used: for host messages [host-write], as a cursor position indicator [indicator], for [both] or off.



IBM Emulation

Forcing Insert: [Off, Line, Character, Both]

- **Off** – If there is no room to insert a character or line, the insert operation will not be performed.
- **Line** – If there is no room to insert a null line and an insert line operation is requested, the current line is replaced with a null line and the remaining lower

lines and the previous current line moves down one line. The bottom line is then discarded.

- **Character** – If there is no space to insert a character and an insert character operation is requested, a character can be inserted at the cursor position. However, the last character of the current line is discarded when the line wrap parameters is off, or the last character of the page (or field in a formatted page) is discarded when line wrap is on.
- **Both** – Enables the line and character functions

Set Control: [Temporary, Permanent]

- **Temporary** – Set Control commands do not replace the values stored in NVRAM. Only the working setup parameters are modified.
- **Permanent** – The Set Control commands update both the working setup parameters as well as the NV setup parameters.

Status Line: [Off, Indicator, Host-Write, Both]

Specify the way in which the status line is to be used: for host messages [host-write], as a cursor position indicator [indicator], for [both] or off.

Char Set: [Multinational, National]

Select whether the character set used is from the 7-bit national chart or the 8-bit multinational chart. The default is the 8-bit multinational character set except when the emulation is VT100.

WP-Graphics: [Off, On]

Selects whether Word Perfect Graphics commands are processed or ignored.

TABS: F10

F1	F2	F3	F4	F5	F6	F7	F8	F9	F10	F11	F12	Print
Quick	Genrl	Displ	Kybd	Keys	Ports	Host	Print	Emul	abs	AnsBk	Prog	Exec
Parameters												
Auto Init Tabs = Off				Default Tabs				Tab=Field				
10 20 30 40 50 60 70 80 90 100 110 120 130												
Choices												
Off On												
Select												
↑ → ↓ ← : Parameter				Enter/S-Enter : Next/Prev Choice				Exit : Setup Key				

Auto Init Tabs: [On, Off]

When on, tab settings will always be defaulted at power up.

Default Tabs: This action field sets tabs at every eighth column starting at column 9.

When the cursor is placed in the Tab Map, the keys below will appear in the Choices field:

- <Space> – clear the current tab setting.
- <Shift> <Backspace> – clear all tab settings.
- <T or t> – set a tab at the current location.
- < ↑ → ↓ ← > – move cursor on the Tab map or back to a Parameter field above the map.



Tab: [Field, Column]

- Field – On a formatted page, the tab stops are defined by the field attribute characters displayed on the screen.
- Column – The column tab stops are used while ignoring the field attribute characters.

ANSWERBACK: F11

F1	F2	F3	F4	F5	F6	F7	F8	F9	F10	F11	F12	Print
Quick	Genrl	Displ	Kybd	Keys	Ports	Host	Print	Emul	Tab	AnsBk	Prog	Exec
Parameters												
Answerback Mode = Off			Answerback Conceal									
Answerback Message: _____											Bytes Remaining: 0542	
Choices												
Off			On									
Select												
↑ → ↓ ← : Parameter				Enter/S-Enter : Next/Prev Choice				Exit: Setup Key				

Answerback Mode: [On, Off]

Choose whether the answerback message (which is sent to the host at terminal reset or power up) mode is on. This can be used to log-in to the system.

Answerback Conceal: This is an action parameter which displays "Concealed" at the answerback edit field. Once it is concealed, the message cannot be redisplayed. This is a security measure for those who use answerback to send their login names and passwords to the host.

Answerback Message: This is a 30-character field which can be edited. (See the Edit Fields section later in this chapter.)



When "Fkey Speed" is *Fast* in the Emul (F9) menu, the answerback edit field is limited to 8 bytes.

PROGRAM: F12

F1 Quick	F2 Genrl	F3 Displ	F4 Kybd	F5 Keys	F6 Ports	F7 Host	F8 Print	F9 Emul	F10 Tabs	F11 AnsBk	F12 Log	Print Exec
Parameters												
Keys = F1			Program = FKey				Key Dir = Host					
Text: _____												

Label: _____			Bytes Remaining: 0542									
Choices												
F1	F2	F3	F4	F5	F6	F7	F8	F9	F10	F11	F12	
Select												
↑ → ↓ ← : Parameter				Enter/S-Enter : Next/Prev Choice				Exit: Setup Key				

Program: [FKey, Sh-FKey, Ctrl-Fkey, Ctrl-Sh-Fkey, Edit Key, Sh-Edit Key]
Specify the type of key to be programmed—function or edit key in its normal or shifted state.



When Fkey Speed is *Fast* in the EMUL (F9) menu, the Program options are F/Key and Sh-F/Key.

Key Dir: [Comm Depend, Host, Printer, Printer & Host, Screen, Host & Screen, Printer & Screen, All]

Select the destination of the contents of the function or edit key. *Comm Dependent* will cause the direction of the key data to correspond to the "Comm Mode" of the current session. For example, if the "Comm Mode" is *Full Block*, the contents of the key will be channeled to the screen only. If it were *Full Duplex*, then the contents would be sent to the host only.

Text: An edit field which permits up to 255 characters. Once the overall text limit (up to 542 characters) is reached, the terminal will beep and accept no more text. If the text is deleted with the backspace key, the default code is no longer programmed. Shift-Backspace will restore the default. See the Edit Fields section or "Fkey Speed" in the Emulation section.

Label: A label of up to 7 characters can be entered for function keys in ASCII emulations only. See “Display NV Labels” in the Emulation section.

<Backspace> – delete
<Shift> <Back> – default field

Key: Select the key to be programmed. The keys that are listed as choices depend upon the Program parameter as shown below:

The following choices apply for non-SCO Console emulations:



When a PC-style keyboard is attached, the choices are:

When Program = *F/Key*, *Sh-F/Key*, *Ctrl-F/Key*, or *Ctrl-Sh-F/Key* the choices are [F1, F2, F3, F4, F5, F6, F7, F8, F9, F10, F11, F12].

When Program = *Edit Key* or *Sh-Edit Key*, the choices are

[Tab, Esc, Backspace, Delete, Return, Home, ↑, ↓, ←, →, EnterKpd, Insert, PageDown, PageUp, End, and Print].



When an ANSI keyboard is attached, the choices are:

When Program = *F/Key* or *Sh-F/Key*, the choices are [F1, F2, F3, F4, F5, F6, F7, F8, F9, F10, F11, F12, F13, F14, Help, Do, F17, F18, F19, F20].

When Program = *Edit Key* or *Sh-Edit key*, the choices are

[Tab, <X>, Select, Return, ↑, ↓, ←, →, Enter, Next Screen, Remove, PF1, PF2, PF3, PF4].



When Program = *Edit Key* or *Sh-Edit Key*, the choices are [Tab, Esc, Backspace, Return, Print, Enter Kpd, ↑, ↓, ←, →, Insert, Delete, Home, BackTab, Clear, and ErEOF.]



To program an ESC (escape) character into the key text, press Ctrl-[.

To program a DEL character into the text field, press Ctrl-Sh-8 (alpha numeric key).

To program a carriage return or line feed into the key text field, press :trl-M or Ctrl-J, respectively.

To program the “Print Screen” key to perform a local print screen (page) function:

In the key text field, press Ctrl-[and then P. Next, set the “Key Dir”=Screen option.

EXECUTE: Prnt Sc

F1 Quick	F2 Genrl	F3 Displ	F4 Kybd	F5 Keys	F6 Ports	F7 Host	F8 Print	F9 Emul	F10 Tabs	F11 AnsBk	F12 Prog	Print xec.
Parameters												
Save Terminal			Recall Terminal				Default Terminal					
Save Session			Recall Session				Default Session					
Reset Terminal			Reset Session				Reset Ports					
Clear Screen			Default Session UDKs									
Choices												
User Enter Key to Execute Action												
Select												
↑ → ↓ ← : Parameter				Enter/S-Enter : Next/Prev Choice				Exit : Setup Key				

All of the parameters in this menu are action parameters.

Terminal parameters affect all settings, including the emulation. Session choices affect only settings that relate to the chosen session. In dual session (host) mode, there are two independent sets of session parameters (Session 1 and Session 2). To toggle between sessions, use the Ctrl-Enter (Num) keystroke.

Save Terminal: Save all settings in non-volatile (permanent) memory, including those associated with the session selected.

Reset Terminal: All terminal parameters are initialized. It also performs reset pages and default modes.

Recall Terminal: Revert to all terminal and session settings that were saved in nonvolatile memory. A "Reset Terminal" is also performed. This is referred to as a hard reset and is equivalent to turning the terminal off and back on.

Default Terminal: Load all defaults for the terminal and session, including the emulation. A "Reset Terminal" is also performed.

Save Session: Save all the settings associated with the chosen session.

Reset Session: Initialize all session settings. This is also referred to as a "Soft-Reset." Perform page-resets and default modes. "Mode" specifies the parameters used by a session which are not selectable through Setup such as Insert-Mode, Split-Screen, and Graphics-Mode.

Recall Session: Load the previously saved settings associated with the chosen session. A "Reset Session" is also performed.

Default Session: Load all defaults associated with the session selected.

Reset Ports: Clear the transmit buffers for the host and printer port, and receive buffer for the host port. Unlocks the keyboard and clears its buffer data.

Clear Screen: Clear the screen and the entire page.

Default Session UDKS: Set the contents of all the function and edit keys associated with the chosen session to their factory default states.

Edit Fields

Setup uses overwrite mode in text editing fields. That is, the cursor keys cannot be used to move to a location in the text to insert characters. Upon entry to a text field, the cursor is placed at the last text location. Use the following keystrokes:

Backspace – Move cursor left by deleting that character.

Shift-Backspace – Reset the field to its default value.

Alphanumeric keys – enter text in the normal, shifted, or control state. To generate a control character (00h-1Fh) add 40h and use Ctrl with the character in the new position (40h-5Fh). For example, to insert CR-LF (0Dh, 0Ah) codes, press Ctrl-M, Ctrl-J (4Dh, 4Ah). The compose and meta functions can also be used to generate 8-bit characters.

Glossary of Terms

Some of the terms that are used in the Exec (PrtSc) menu are defined below.

Terminal Parameters

Terminal parameters includes session parameters (defined later) and non-session parameters that affect the terminal globally without regard to the session. The non-session parameters and their defaults are listed below:

Setup Parameters: Bell Volume (6), Screen Saver (5 min), Overscan Borders (on), Language (U.S.), Keyclick (on), EIA(Aux) Baud Rate (9600), EIA (Aux) Data Format (8/1/N), EIA (Aux) Parity Check (off), EIA(Aux) Rcv Prtcl (Xon-Xoff/XPC), EIA (Aux) Xmit Prtcl (none), EIA (Aux) Break (250 ms), EIA (Aux) Xmit Pace (baud), EIA (Aux) Disconnect (2 sec), EIA (Aux) Modem Control (off), Session Display (full), Screen Length (26 lines), Refresh Rate (70 Hz), Bright Video (off), Enhanced Attributes (on), Setup Lang (U.S.), Sessions (1), Caps Lock (Toggle), Num Lock (Toggle), Key Repeat (On), Speed (fast).

Desk Accessory Parameters: Clock Display (off), Clock Type (12 hour), Clock Location (column 48), Date, Time (not saved), Alarm Time (12 PM), Tone (alarm/hourly), Calculator (printer off, tape on), and the row and column in which each accessory is displayed.

Session Parameters

Session Parameters are parameters that are specific to the emulation selected in the current session. These include three types of parameters: Setup-Edit keys, Setup, and Modes.

Setup-Edit Keys: Function and Edit keys and the Answerback message.

Setup Parameters: All other Setup variables that are not included in Setup Parameters in Terminal Parameters (all global settings).

Mode Parameters: Variables that are used by a session's emulation, but are not selectable through Setup. Some examples are Protect Mode, Graphics Mode, Insert Mode, Aux Mode, Split-Screen, Transparent Mode, Character Set mappings, Setup Language, and Sessions.

Page Reset

Page resets are executed when the session or terminal is reset or defaulted. When a page reset is performed, it affects all pages, and the following events occur: the page is erased, the cursor is homed, and scrolling regions are defaulted. All line attributes (such as double-high/wide, locked lines) are reset to normal. Split screens are cleared to a normal, single screen and protect mode is turned off.

chapter
4

Desk Accessories

This terminal features five desk accessories, which can be accessed one at a time through pop-up windows.

Overview

Desk Accessory Menu

To display this pop-up window to choose any of the five desk accessories, press Ctrl-←.

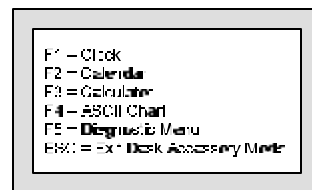

Function keys F1-F5 are used to display the clock, calendar, calculator, ASCII chart, and diagnostic menu, respectively.



To access this menu (with a PC keyboard), the selection "Desk Acc = ←" must be chosen in the KEYS (F5) Setup menu. This menu is always available with the ANSI keyboard.

Direct Access

To display any desk accessory directly, without the desk accessory menu, the following keystrokes are used:

- Clock – press Ctrl-Shift-F1
- Calendar – press Ctrl-Shift-F2
- Calculator – press Ctrl-Shift-F3
- ASCII Chart – press Ctrl-Shift-F4
- Diagnostic Menu – press Ctrl-Shift-F5

You may also use a function key (F1-F5) to enter another desk accessory window, once one is entered.



To use these keystrokes with a PC-style keyboard, the selection "Desk Acc = Sh-Ctrl-Fkeys" should be chosen in the KEYS (F5) Setup menu. If an ANSI keyboard is attached, the "F1 to F5 keys = Local" should be chosen in the KEYS (F5) Setup menu.

To reposition any window on your screen, hold down the Shift key while pressing a cursor control (arrow) key.

Exit Keystrokes

To exit any window and restore the original screen:



Press **ESC** on the PC-style keyboards



Press **F11** on the ANSI keyboard

Inhibiting Access



Access to desk accessories can be inhibited by selecting "Disabled" for "Desk Acc" in the Setup menu.

Calendar

This displays a calendar for any month from the years 1900 to 2099. The current date is displayed at the bottom. The keys below control the calendar that is displayed:

- Right- and left-arrow keys – Display an earlier or later month.
- Up- and down-arrow keys – Display the selected month in an earlier or later year.
- Esc – Exit calendar.

The specified calendar month will display as shown below:

JANUARY '95						
SUN	MON	TUES	WED	THUR	FRI	SAT
						1 2
3	4	5	6	7	8	9
10	11	12	13	14	15	16
17	18	19	20	21	22	23
24	25	26	27	28	29	30
T						
2000-01-01 12:00 PM						

Clock

The clock menu (shown below) contains seven lines which can be modified:

Date	Jan 1, 1995
Time	08:00:00 AM
Display	Off
Type	12
Column	48
Alarm Set	12:00 PM
Tone	Off

Use the following keys to make changes:

- Up- or down-arrow keys – Select a line. The line is highlighted.
- Left- or right-arrow keys – Select a field on the chosen line. The selected field is now highlighted.
- Spacebar – Move “up” through options available for this field.
- Shift-Spacebar – Move “down” the options.
- Enter (num) – Revert to the default setting for the current field.
- Esc – Exit clock and save settings.

Each of the seven fields is described below:

Date – Use the left or right arrow keys to highlight each field of the date (month, day, and year). Then use the Spacebar or Shift-Spacebar to cycle through the settings. The date can also be set by the host.

Time – Use the procedure described for *Date* above to set the hour, minutes, or seconds.



The clock is reset to 08:00 AM at power-up. Due to hardware limitations, the clock may drift by 15 seconds per day. We recommend setting the terminal's time as part of the system login process.

Display – Indicate whether only Time, only Date, or both the Time and the Date are displayed on the top status line. Display of Time/Date can also be turned Off. The date display can also be set by the host.

Type – Select whether the clock functions on a 12-hour or 24-hour basis.

Column – Set the column (36-99) in which the date/time will display (as enabled by *Display* above).

Alarm Set – Time at which an alarm (a 1-2 second bell tone) should sound.

Tone – How alarm tone(s) should be activated: every Hour, on the Alarm setting only, or both on the Alarm setting and Hourly. The alarm tone can also be turned Off.

Calculator

The numeric keypad located on the right side of your keyboard will serve as your calculator. See the figures below to relate the display to the keys on the numeric keypad that control it.

Note that the ANSI keyboard calculator display is identical to the ones shown below for the PC+ keyboard except that the controlling keys on the numeric keypad are different (the ANSI keyboard control keys include PF1-PF4 keys and function keys F16-F20).

The calculator can process up to 10 digits to the left of the decimal point, and up to 9 to the right. When a number or number operator is pressed, it is momentarily highlighted on the display.

Number operators are defined as follows:

- +, -, /, X – The respective operations of addition, subtraction, division, and multiplication.
- MS – stores the displayed value in memory.
- MR – displays the stored value
- M + – adds the displayed value to memory.
- +/- – make a number positive/negative.
- C/A – Displays 0.0 when pressed once. When pressed twice, clears memory.

The figures below represent the calculator display:

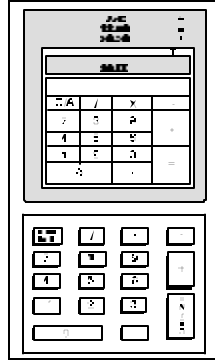

Calculator Display (EPC keyboard)

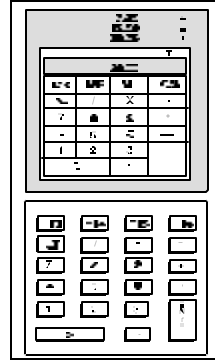

Calculator Display (PC+ keyboard)

In addition to the keys on the numeric keypad, you may use:

- T – Toggle “tape” on/off. Results scroll above the display.
- P – Toggle “printer” on/off. Results are transmitted onto the printer.



Use the printer option only when a printer is connected. Press Ctrl-Shift-Tab to clear a printer error.

- X – Exit the calculator, transmitting the final result to the current application. (Shift-X transmits the result with no leading or trailing spaces).
- Ctrl-(a number on the numeric keypad) – Specify the precision, where the number of decimal places that will be displayed is equal to the number pressed with the Ctrl key.
- Esc – Exit calculator.

ASCII Chart

The ASCII chart, upon entry to this desk accessory, is centered on the character on which your cursor was last placed, and that character is highlighted. The chart will display as shown below:

FONT BANK 0				
DEC	OCT	HEX	BINARY	CHAR
126	156	7E	01111110	.
127	177	7F	01111111	?
128	160	80	10000000	
129	161	81	10000001	
130	162	82	10000010	

Characters are also displayed in octal, hexadecimal, and binary number representations. The CHAR column contains the ASCII representation of the character.

Use the following keys to change the display of the ASCII chart:

- Up- or down-arrow – Scroll up or down the characters in the ASCII chart (0-127).
- Left- or right-arrow – Scroll through the available font banks. The characters will display from the selected font bank.
- Ctrl-↑, Ctrl-→, Ctrl-↓, Ctrl-← – Move the cursor on the screen up, right, down, or left. The ASCII chart will be redisplayed, and the chart will be centered on the character that the cursor now rests upon.



Upon exit, the cursor will be restored to its previous location at the time of entry to the desk accessory(ies).

- Esc – Exit the ASCII chart.

Diagnostic Menu

This desk accessory is used to display terminal configuration information such as the amount of memory (RAM) in the terminal, the style of keyboard that you are using, and the firmware revision level. An example of the diagnostic menu is shown below:

265		
Screen RAM		
Character	32K	P0000
Attribute	32K	P0000
CGEN RAM	8K	P0000
Scratch RAM	32K	P0000
NVRAM		P0000
Code ROM 3C10	256K	P0000
Keyboard Type	PC+	P0000
		000000
Video Timing		P0000
EIA port	RS-232	P0000
AUX port	RS-232	P0000
PARALLEL port		P0000
598-XXXXXX		000000

If you require technical support, this menu provides a means for our support team to quickly assess your terminal installed options.

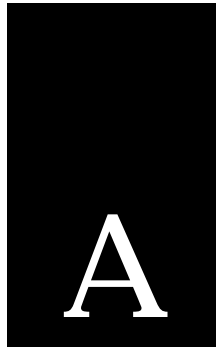

Appendix

Local Keys

Action	Scan Code Mode	PC Ke board	ANSI Ke board
Toggle Caps-Lock	No	Lock	Lock
Toggle Num-Lock	No	Num-Lock	
Toggle Scroll-Lock ¹	No	Scroll-Lock	F 1
Toggle Auto Print ²	Yes	Ctrl-Print-Screen	Ctrl-F2*
Toggle Block-Mode	Yes	Ctrl-Shift-Pause	F4*
Toggle Monitor Mode	Yes	Ctrl-Shift-1\End	Ctrl-Shift-1 (num)
Toggle Ins/Replace	No	Ctrl-Insert	Ctrl-PF4
Instant Screen Saver ³	Yes	Ctrl-Shift-*	Ctrl-Shift-PF3
Soft Reset ⁴	No	Shift-Scroll Lock	Shift-F3*
Hard Reset (Power On)	No	Ctrl-Shift-Scroll Lock	Ctrl- F3*
Break ⁵	Yes	Ctrl-Pause	F5*
Modem-Disconnect ⁶	No	Pause	Shift-F5*
Send-Answerback	No	Shift-Pause	Ctrl- F5*
Print-Page	Yes	Ctrl-Shift-Del.	Ctrl-Shift- . (num)

Continued

Continued

Action	Scan Code Mode	PC Ke board	ANSI Ke board
Increment Scroll Rate ⁷	Yes	Ctrl-Shift-↑	Ctrl-Shift-↑
Decrement Scroll Rate ⁷	Yes	Ctrl-Shift-↓	Ctrl-Shift-↓
Raise Split ⁸	Yes	Ctrl- - (num)	Ctrl- - (num)
Lower Split ⁸	Yes	Ctrl- , (num)	Ctrl- , (num)
Split-Full Toggle ⁸	Yes	Ctrl-Shift- - (num)	Ctrl-Shift- - (num)
Roll-Window-Up ⁸	Yes	Ctrl-↑	Ctrl-↑
Roll-Window-Down ⁸	Yes	Ctrl-↓	Ctrl-↓
Change Status Line ⁹	Yes	Ctrl-→	Ctrl-→
Home & Clear Page	Yes	Ctrl-Shift-Home	
Auto Adjust Window	Yes	Ctrl-Home	
Toggle Session	Yes	Ctrl-Enter (num)	Ctrl-Enter (num)
Enter Desk Accessory Mode	Yes	Ctrl-←	Ctrl-←
Enter Setup Mode ¹⁰	Yes	Ctrl-Scroll Lock	F3*
Exit Setup Mode ¹⁰	Yes	Pause	F14
Enter Clock ¹¹	Yes	Ctrl-Shift-F1	Ctrl-Shift-F1*
Enter Calendar ¹¹	Yes	Ctrl-Shift-F2	Ctrl-Shift-F2*
Enter Calculator ¹¹	Yes	Ctrl-Shift-F3	Ctrl-Shift-F3*
Enter ASCII Chart ¹¹	Yes	Ctrl-Shift-F4	Ctrl-Shift-F4*
Enter Diagnostics ¹¹	Yes	Ctrl-Shift-F5	Ctrl-Shift-F5*
Exit Any Desk Accessory	Yes	Esc	F11 (Esc)
Next Page ¹²	No	Ctrl-Page Down	Ctrl-Next Screen
Previous Page ¹²	No	Ctrl-Page Up	Ctrl-Prev Screen
Display Page 0 ¹³	No	Ctrl-0\Ins	Ctrl-0 (num)
Display Page 1 ¹³	No	Ctrl-1\End	Ctrl-1 (num)
Display Page 2 ¹³	No	Ctrl-2\↓	Ctrl-2 (num)
Display Page 3 ¹³	No	Ctrl-3\Page Down	Ctrl-3 (num)
Display Page 4 ¹³	No	Ctrl-4\←	Ctrl-4 (num)
Display Page 5 ¹³	No	Ctrl-5	Ctrl-5 (num)
Display Page 6 ¹³	No	Ctrl-6\→	Ctrl-6 (num)
Display Page 7 ¹³	No	Ctrl-7\Home	Ctrl-7 (num)
Display Page 8 ¹³	No	Ctrl-8\↑	Ctrl-8 (num)
Display Page 9 ¹³	No	Ctrl-9\Page Up	Ctrl-9 (num)
Program Banner	No	Ctrl-Tab	Ctrl-Tab
Local Block Copy	No	Alt-Home	Alt-Select**
Line Copy	No	Alt-Delete	Alt-Find**
Paste from Buffer	No	Alt-Insert	Alt-Insert Here**



In Scan Code Mode, this chart applies only when Local Leadin is on.

NOTES:

- 1 This function is operational only if EIA (Aux) Rcv-Prtcl = Xon-Xoff/XPC or DTR.
- 2 In ANSI emulations, this keystroke toggles in and out of Auto Print Mode.
- 3 This function is operational even if Screen Saver is set to *off*.
- 4 This function unlocks the keyboard, turns off all print modes and re-initializes the serial ports for setup parameters.
- 5 The length of the Break Signal is dependent on the setup parameter of "EIA (Aux) Break."
- 6 This keystroke is dependent on the "Disconnect" setting in the "Keys" (F5) setup menu.
- 7 The Increment Scroll Rate toggles the scroll rate to the fastest smooth scroll. This function also stops at the jump scroll. The Decrement Scroll Rate toggles from jump scroll to the fastest smooth scroll toward the slowest smooth scroll.
- 8 These functions are not available in ANSI emulations.
- 9 The Change Status Line function will toggle in the status line display from "Indicator" to "Host Write" to "Both" to "Off" in ANSI Emulations and "Standard" to "Extended" to "Off" on ASCII Emulations.
- 10 For other keystrokes for these functions, see the Setup chapter.
- 11 Keystrokes for these functions are only operational if the "Desk Acc= Sh-Ctrl-Fkeys" in the setup menu.
- 12 When a Split Screen is not enabled, these keys select the next or previous pages. Wrapping takes place from the last page to the first and vice versa.
- 13 These local functions are operational only if the selected page is available.

Page Configurations—Single and Dual Session

Lines per Page	Number of Pages			
	Single Session		Dual Session	
	80/132	80-only	80/132	80-only
24	8	10	4	4
48	4	5	2	2
96	2	2	1	1
192	1	1	-	-
*24	2 (24/176)	2 (24/216)	2 (24/76)	2 (24/96)
25	8	9	4	4
50	4	4	2	2
100	2	2	1	1
200	1	1	-	-
*25	2 (25/175)	2 (25/215)	2 (25/75)	2 (25/95)
42	5	5	2	2
84	2	2	1	1
168	1	1	-	-
*42	2 (42/158)	2 (42/198)	2 (42/58)	2 (42/78)
43	5	5	2	2
86	2	2	1	1
172	1	1	-	-
*43	2 (43/157)	2 (43/197)	2 (43/57)	2 (43/77)



When a page length (in the first column) is preceded by an asterisk (*), a total of two pages will be available. The first page contains the selected number of lines and the second page contains the remaining allowable lines in memory. The number of lines are listed on this chart as (first page/second page).

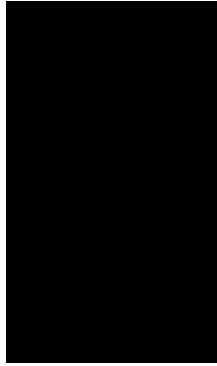

User's Notes





NOTE TO INSTALLER

This equipment complies with the FCC Regulation for Class A devices, Subpart J of Part 15. Shielded, grounded interface cables were used on all ports for FCC radiated emission testing.

The manufacturer is not responsible for any violation of the FCC Regulation for Class A devices that is caused by unauthorized modification of the equipment, or caused by equipment installation not in accordance with the instructions in this manual.

This equipment generates, uses, and can radiate radio frequency energy and may cause radio or television interference. All user equipment that interfaces with other products should be connected with shielded cables. (Contact a local dealer for more information on shielded cable assemblies and their availability.)

There is no guarantee that interference will not occur. If radio or television interference occurs (this can be determined by turning the equipment off and on while the radio or television is on), the user is solely responsible for correcting the interference and is encouraged to take one or more of these measures:

1. Reorient the receiving antenna.
2. Relocate the equipment, or move the equipment away from the receiver.
3. Plug the equipment into a different outlet so the unit and receiver are on different branch circuits.
4. Consult the dealer or an experienced radio/television technician.

It is also suggested that the user read the FCC booklet entitled How to Identify and Resolve Radio-TV Interference Problems. The booklet is available from the US Government Printing Office, Washington, DC 20402. (When ordering the booklet, specify stock number 04-000-00345-4.)

Site Preparation

The screen display geometry on terminal products is aligned using magnetic devices. External magnetic fields created by other types of electronic equipment, such as printers, in very close proximity to the terminal, may cause minor display distortion.

Examples of display distortion include:

- ▷ Shaky video
- ▷ Wavy lines
- ▷ Tilted display

This magnetic field interaction only occurs over a very short distance, normally less than twelve inches, and can be corrected by separating the equipment and/or slightly reorienting the display.





Technical Support

Questions about this product should be directed to the Technical Support Department of the distributor from which you obtained your Boundless Technologies equipment. When requesting assistance, please have all pertinent information available including any error messages that may have appeared either on the terminal or the host.

If your distributor fails to provide adequate support for your needs, please contact the Boundless Technologies Technical Support Department directly. You will be required to provide the name of your distributor, and a description of the problem as described above.

Please refer to the Boundless Technologies Guide to Support Services which was packaged with the terminal.

Boundless Technologies can be reached at:

Boundless Technologies, Inc.
Technical Support Department
100 Marcus Blvd.
Hauppauge, NY 11788

(800) 231-5445 ext. 7259 (voice)

(516) 342-7378 (fax)

Email: support@boundless.com

BBS: 407-333-8326 1200/14400 baud
8 data bits, 1 stop bit, no parity

ftp: [ftp.boundless.com](ftp://ftp.boundless.com)

Web site: <http://www.boundless.com>

