

use & care guide

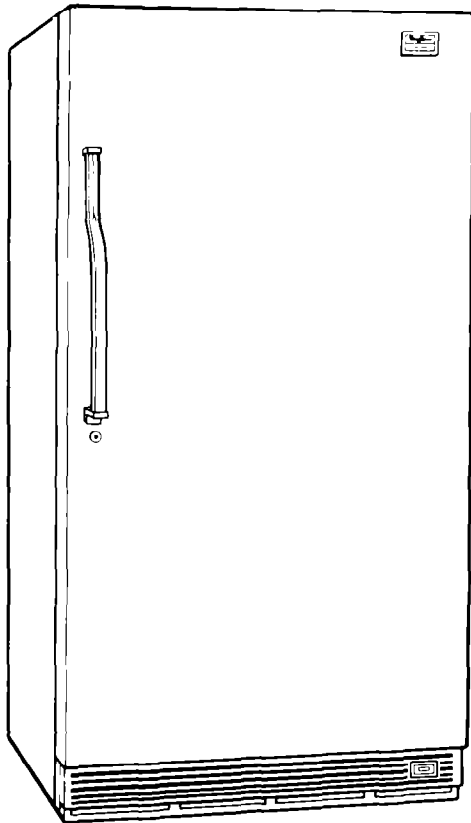

UPRIGHT FREEZER

Model EV20VS

rs. Freezers. Refrigerator-Freezers. Ice Makers. Dishwashers. Built-In Ovens and Surface Units. Ranges Microwave Ovens. Trash Compactors. Room Air Conditioners. Dehumidifi

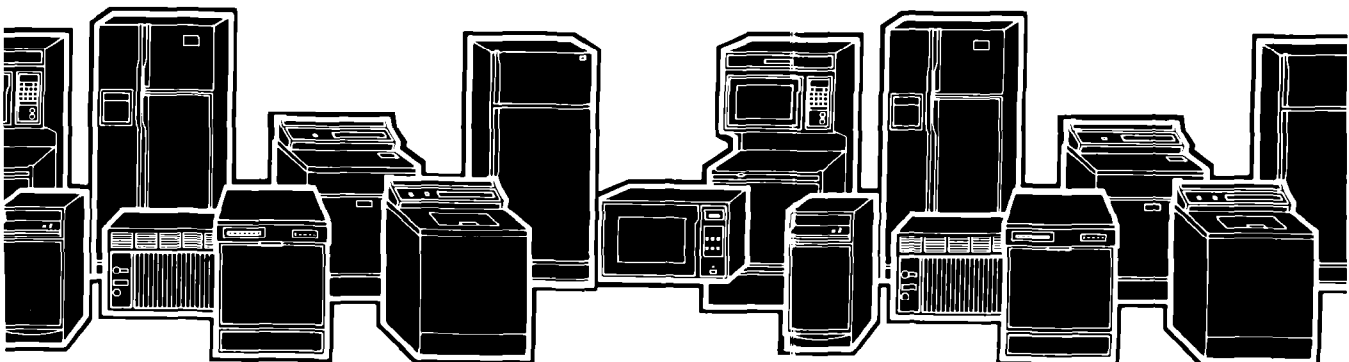

Please read this Use and Care Guide before you do anything else...

Your new freezer is designed to alert you to any abnormal conditions which may cause freezer air temperature to become too warm.

This booklet tells you how to start your freezer, defrost it, clean it and adjust controls.

Treat your new freezer with care. Use it only to do what home freezers are designed to do.

Parts and features

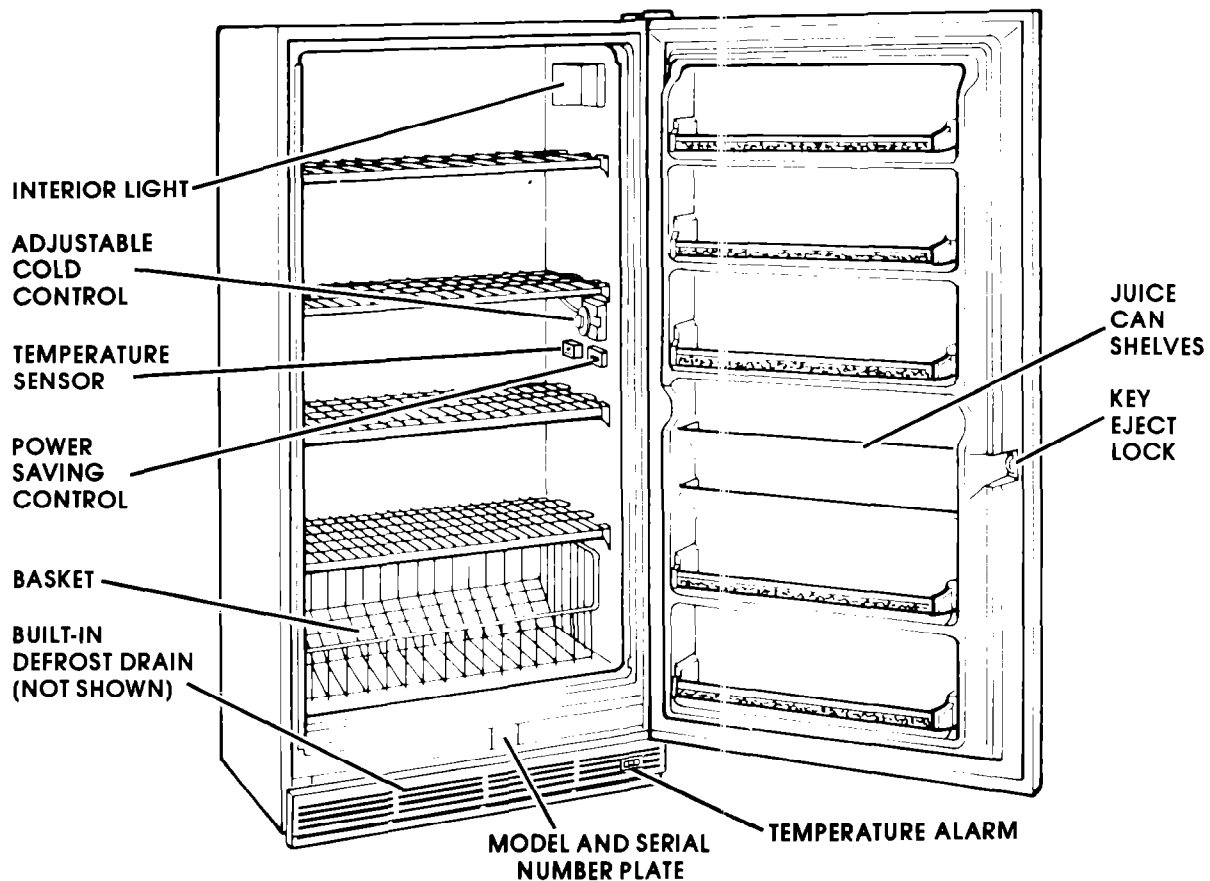

Copy your Model and Serial Numbers here...

When you need service, or call with a question, have this information ready:

1. **Complete** Model and Serial Numbers (from the plate just above base grille).
2. Purchase date from sales slip.

Copy this information in these spaces. Keep this book, your warranty and sales slip together in a handy place. There is no warranty registration to return. Proof-of-purchase is all that is required for in-warranty service.

Model Number

Serial Number

Purchase Date

Service Company and Telephone Number

Safety first

Child entrapment and suffocation are not things of the past. Junked or abandoned freezers are still dangerous...even if they will "just sit in the garage a few days."

If you are getting rid of your old freezer, do it safely. Please read the enclosed safety booklet from the Association of Home Appliance Manufacturers. Help prevent accidents.

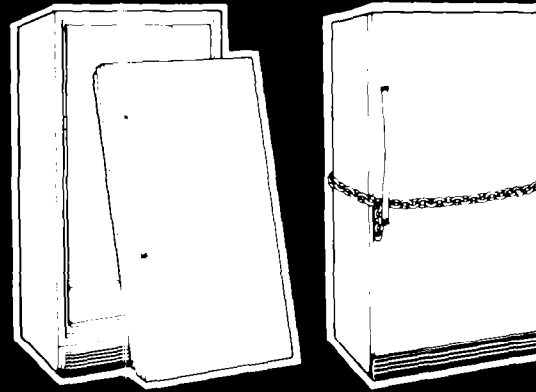

Contents

	Page
BEFORE YOU PLUG IT IN	3
Install Properly	4
Level Freezer	4
Remove Sales Labels	4
Clean It	4
Install the Battery	4
Plug It In	4
USING YOUR FREEZER	5
Setting the Cold Control	5
Adjusting Cold Control	5
Cooling Freezer First	5
Temperature Alarm	5
Installing or Replacing the Battery	6
The Battery	6
The Power Saving Control	6
The Key Eject Lock	6
Bottom Basket	7
Changing Light Bulb	7
CLEANING YOUR FREEZER	7
Removing the Base Grille	7
FREEZING FOOD IN YOUR FREEZER	9
Packaging and Sealing Food	9
To Wrap Foods	9
Loading	9
Storing Frozen Food	10
Energy Saving Tips	10
VACATION AND MOVING CARE	10
Vacations	10
Shutting Off and Moving	10
IF YOU NEED SERVICE OR ASSISTANCE	11
1. Before Calling for Assistance	11
2. If You Need Assistance	11
3. If You Need Service	11
4. If You Have a Problem	11

©1984 Whirlpool Corporation

Before you plug it in

IMPORTANT

- Before using your freezer, you are personally responsible for making sure that it...
- is installed and leveled on a floor that will hold the weight, and in an area suitable for its size and use.
 - is connected only to the right kind of outlet, with the right electrical supply and grounding. (Refer to your "Electrical Requirements and Grounding Instructions.")
 - is used only for jobs expected of home freezers.
 - is not near an oven, radiator or other heat source
 - is properly maintained.
 - is in a dry sheltered place.
 - is used in an area where the room temperature will not exceed 110° F (43.3 C).
 - is not run where there are explosive fumes.
 - is not used by children or others who may not understand how it should be used.
 - is not loaded with food before it has time to get properly cold.

Install properly...

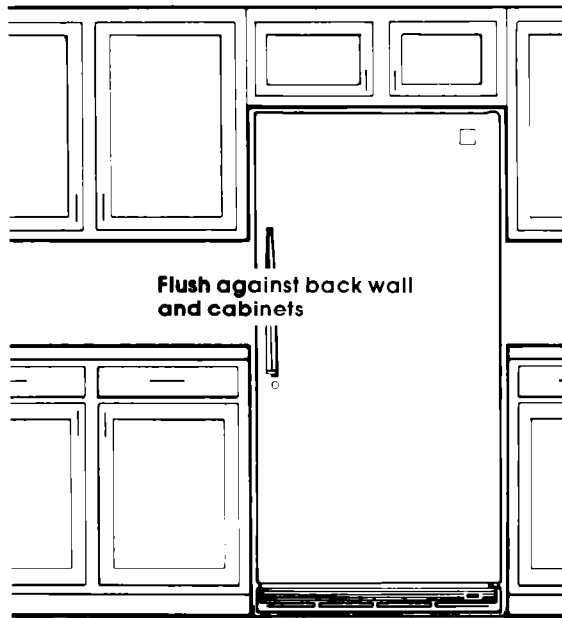

1. Check the strength of the floor. It should hold the weight of fully loaded freezer.
2. **Pick a safe place, indoors, away from inflammables such as gasoline.**
3. Allow ½" (.2 cm) space on each side and at top for ease of installation.

Level freezer...

so that door will stay open at any position.

1. Remove base grille (see page 7).

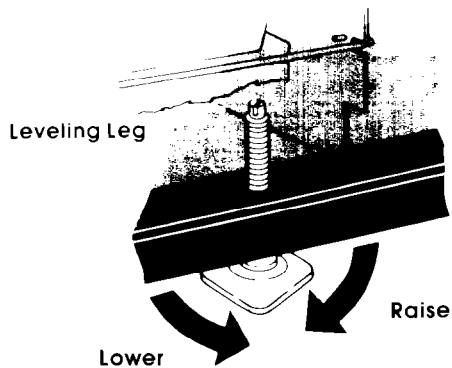

2. To raise front, turn each leg to the left.
3. To lower front, turn each leg to the right.
4. Check with level.
5. After freezer is fully loaded, recheck with level.

Remove sales labels...

Remove the Consumer Buy Guide label and any **inside** labels before using the freezer. Remove any left over glue with rubbing alcohol.

NOTE: DO NOT REMOVE the label just above the Temperature Alarm Switch or the Tech Sheet fastened behind the base grille.

Clean it...

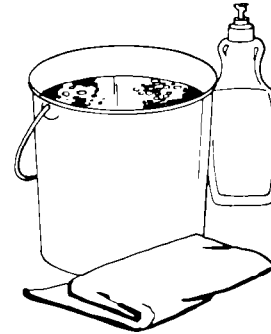

Clean your freezer before using it. See cleaning instructions on page 7.

Install the battery...

You will find the freezer key and a 9-volt alkaline battery packed inside the freezer. Install the battery by following instructions on page 6.

The Temperature Alarm will sound a continuous tone if the Temperature Alarm Switch is in the **ON** or **TEST** position. Move the switch to **OFF** until the freezer is cold. Then move it to **ON**.

Plug it in...

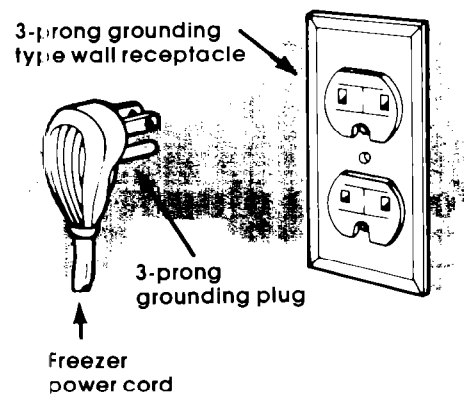

RECOMMENDED GROUNDING METHOD

A 115 volt, 60 Hz., AC only 15 or 20 ampere fused and properly grounded electrical supply is required. It is recommended that a separate circuit serving only this appliance be provided.

Do not use an extension cord. Use a receptacle which cannot be turned off with a switch or pull chain. See individual electrical requirements and grounding instruction sheet in your literature package.

Using your freezer

Setting the cold control...

To start, turn control to the middle of the dial. This setting is designed to maintain temperature at or near 0 F (- 17.8 C) under normal operating conditions.

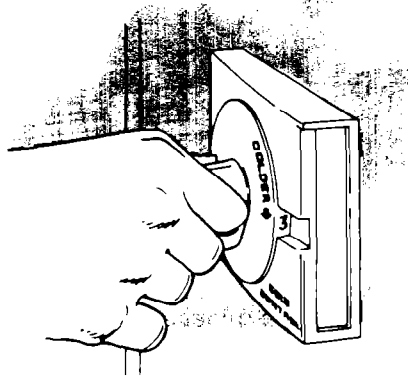

Adjusting cold control...

- Turn control to higher number for colder temperatures.
- Turn to lower number for less cold temperatures.

Cooling freezer first...

- Allow freezer to cool 6 to 8 hours before filling with **frozen food**.
- Let it cool overnight before adding large amount of **unfrozen food**.

Note: When freezer is first started the compressor will run constantly until the cabinet is cooled. It may take up to 6 to 8 hours or longer, depending on room temperature and the number of times the freezer door is opened.

After the cabinet is cooled the compressor will turn on and off as needed to keep freezer at proper temperature.

Temperature Alarm

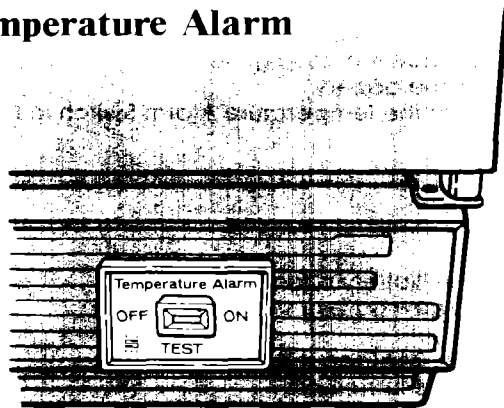

The Temperature Alarm (located on the right side of the base grille) works together with an electronic Temperature Sensor (located inside the freezer – sensing freezer air temperature) to alert the user to an abnormal condition which has caused freezer air temperature to rise to a level which may be unsafe for frozen food storage. It is designed to sound a continuous tone if the freezer becomes warm.

Freezer temperature may become too warm if...

- The door is not tightly closed.
- The door has been opened too many times, or has been left open too long.
- The Cold Control is not set correctly.
- A large food load has been added.
- The freezer is disconnected.
- There has been a power failure, or a circuit-breaker is tripped or a fuse blown.

When the Temperature Alarm switch is **ON**, the Temperature Sensor in the freezer senses freezer air temperature. If the temperature becomes too warm, the Temperature Alarm is designed to sound a continuous tone.



You will hear a **different sound** if the battery is about to wear out. The alarm is designed to beep (chirp) every 30 to 60 seconds to indicate a failing battery.

If the Temperature Alarm sounds a continuous tone and the Temperature Alarm switch is **ON**, move the switch to **OFF**.



Make sure you know **why** the freezer became too warm. If the problem is serious (power failure) and service or assistance is needed, see page 11. If the problem is simple (door open, freezer unplugged) correct it. Move the switch back to **ON** when the freezer is cold again.

The beeping that indicates a failing battery cannot be stopped by moving the Temperature Alarm Switch to **OFF**. It can be stopped only by removing the battery. Replace immediately with a 9-volt alkaline battery.

Check the battery often by moving the Temperature Alarm Switch to the **TEST** position. The alarm should sound a continuous tone, regardless of freezer air temperature. If the alarm doesn't sound a tone with the switch in the **TEST** position, replace the battery immediately.



Installing or replacing the battery

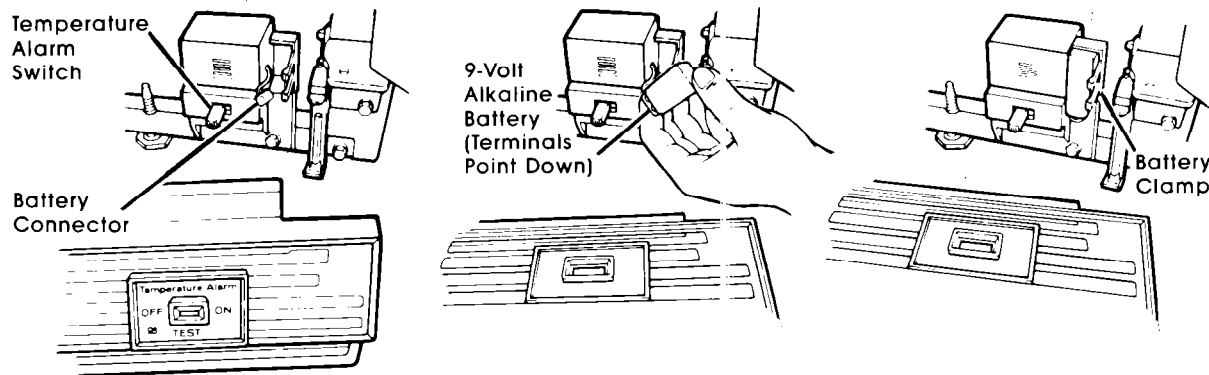

Installing:

1. Move the Temperature Alarm Switch to **OFF**.
2. Remove the base grille (see page 7).
3. Carefully position the battery connector.
4. Place the connected battery – with the terminals pointing down – between the Temperature Alarm and the battery clamp.
5. Replace the base grille.
6. Move the Temperature Alarm Switch to the **TEST** position. The alarm should sound.
7. Move the switch to **OFF** until the freezer is cold. Then move the switch to **ON**.

Replacing:

1. Remove the base grille (see page 7).
2. Carefully pull the battery forward out of the clamp.
3. Unplug the battery.
4. Install a new **9-volt alkaline battery**.
5. Replace the battery in the clamp with the terminals pointing down.
6. Replace the base grille.
7. Test the battery.
8. Move the Temperature Alarm Switch to **ON**.

The battery

- A new alkaline battery should last up to one year. Test the battery often.
- If the freezer air temperature should become too warm, a new battery should sound the alarm for up to 48 hours.
- The "low battery" beep (chirp) should last about 7 days. Replace the failing battery immediately. The beep (every 30 to 60 seconds) cannot be turned off.
- If you have been away from home for more than a day, always check your freezer and **TEST** the battery.

The Power Saving Control...

operates electric heaters. These heaters help prevent moisture from forming on the outside of the freezer when humidity is high.

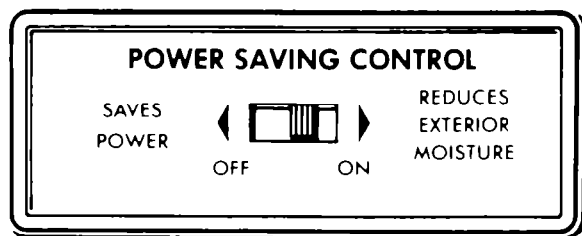

- Use the OFF setting when humidity is low.
- Use ON if moisture forms on outside of freezer

The key eject lock...

can help reduce the hazard of child entrapment.

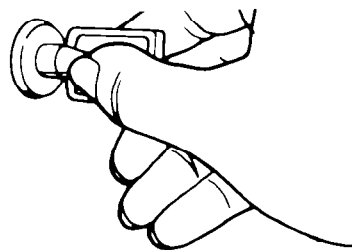

To lock or unlock the freezer you must hold the key in the lock while turning. The lock is spring loaded so the key cannot be left in the lock.

If the key is lost, contact your WHIRLPOOL dealer for a replacement. Always give the **complete** model and serial number of your freezer when requesting a replacement key.

Bottom basket...

To remove:

- Lift up, then pull out.

To replace:

- Insert into rear slides.
- Lower into place.
- Push basket into freezer.

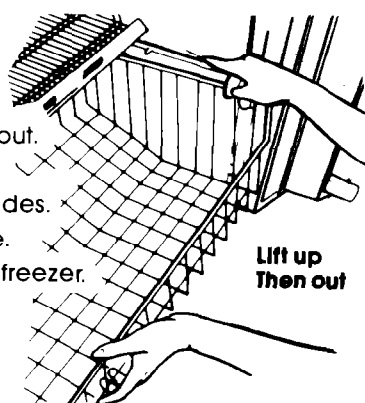

Changing light bulb...

Pull out

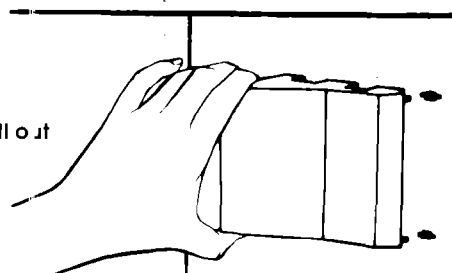

1. Unplug power cord.
2. Remove light shield by pulling away from the side wall.
3. Replace bulb with 40 watt appliance bulb.
4. To replace shield, insert tabs into slots in wall and press.
5. Plug power cord into outlet.

Cleaning your freezer

This freezer should be cleaned when frost has built up to about ¼ inch (6 mm) thickness. Complete defrosting and cleaning should be done at least once a year. In high humidity areas, a freezer may need more frequent defrosting.

To defrost and clean:

1. Turn Cold Control to OFF.
2. Unplug power cord.
3. Take out all food and removable parts.

Note: Wrap frozen foods and packages in several layers of newspaper and cover with a blanket. Food will stay frozen several hours.

4. Place pans of hot water inside freezer to speed melting of frost. Keep door open. Ice can be removed in large pieces as it melts. Direct air from electric fan into freezer to speed defrosting.
5. Remove base grille, see page 7.
6. Unclip hose and allow water to drain through hose into a flat pan.

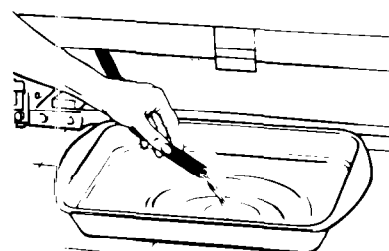

7. Clean freezer according to the following directions.

After defrosting:

1. Hook drain hose in place.
2. Replace base grille.
3. Plug in power cord.
4. See directions for "Setting the Cold Control," page 5.

Removing the base grille...

1. Open the door.

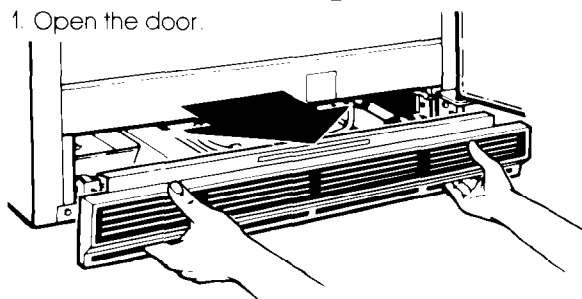

2. Pull grille outwards as shown.
3. **Do not remove Tech sheet** fastened behind grille.

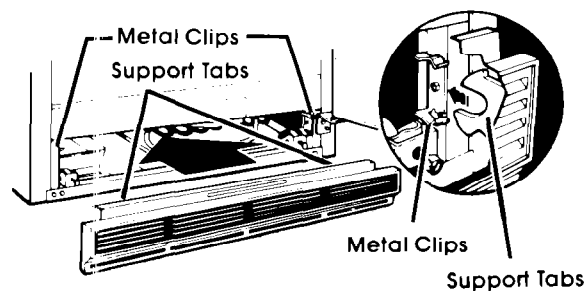

To replace:

1. Line up grille support tabs with metal clips.
2. Push firmly to snap into place.
3. Close the door.

Cleaning chart...

Part	What to use	How to clean
Removable parts (basket)	Mild detergent and warm water	<ul style="list-style-type: none"> • Wash with warm water and a mild detergent. • Rinse and dry.
Outside	Sponge, cloth or paper towel; mild detergent; appliance wax (or good auto paste wax).	<ul style="list-style-type: none"> • Wash with warm water and a mild detergent. Do not use abrasive or harsh cleaners. • Rinse and dry. • Wax painted metal surfaces at least twice a year with appliance wax or a good auto paste wax. Apply wax with a clean, soft cloth. Do not use wax on plastic parts.
Inside walls	Plastic scraper, pans of hot water, electric fan, sponge or towel, baking soda, warm water	<p>Waxing painted metal surfaces provides rust protection.</p> <ul style="list-style-type: none"> • Use plastic scraper to remove frost. • Place pans of hot water in freezer with door open to speed melting. Directing air from an electric fan into the freezer will also help. • Drain defrost water through drain hose into a flat pan. • Wash with solution of 2 tablespoons (26 g) baking soda to 1 quart (.95L) warm water. • Rinse and dry. <p>DO NOT USE an ice pick, knife or other sharp-pointed tool or any type of electric defroster to defrost freezer. They can cause damage to the liner and interior parts.</p>
Door liner and gasket	Sponge, soft cloth or paper towel; mild detergent, warm water	<ul style="list-style-type: none"> • Wash with mild detergent and warm water. • Rinse and dry. <p>DO NOT USE cleaning waxes, concentrated detergents, bleaches or cleansers containing petroleum on plastic parts.</p>
Condenser coil	Vacuum cleaner, using the extended narrow attachment	<ul style="list-style-type: none"> • Remove base grille. See page 7. • Clean dust and lint from condenser every 2 to 3 months. • Replace base grille.

Freezing food in your freezer



When freezer has cooled to a safe storage temperature, it may be loaded with **frozen food**.

When you plan to freeze **unfrozen food**, see the following chart for the amount to freeze at **one time**.

POUNDS OF FOOD TO FREEZE AT ONE TIME*

Size of Freezer	Meat or Fish	Vegetables or Fruit
20 cu. ft. (566L)	40 lbs. (18 Kg)	60 lbs. (27 Kg)

*These amounts are based on USDA recommendations. If too many packages of unfrozen food are packed at one time into the freezer, the rate of freezing is too slow. Poor quality products result.

Packaging and sealing food...

Airtight packaging is important in freezing foods. Containers and wrappings should be moisture and vapor-proof and packages should be sealed carefully to keep moisture in and air out.

Freezer burn can result if food is not properly wrapped. When this happens food dehydrates and is of poor quality.

To wrap foods



1. Cut sheet of wrapping material about one-third longer than distance around food to be wrapped. Place wrapping sheet on flat surface with food in center of sheet.

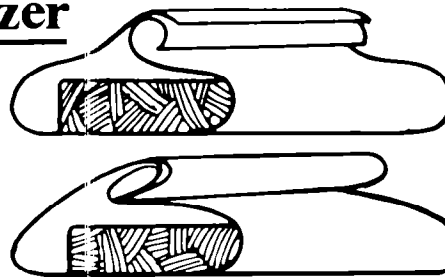

2. Bring front and back of wrapping together and fold in toward food, making at least two one-inch (2.5 cm) folds until food fits tightly against wrapping.

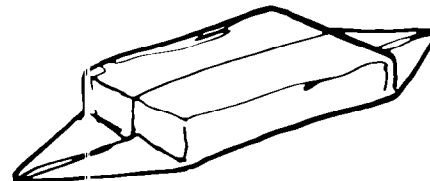

3. Crease ends close to food to eliminate air pockets.



4. Press all air from package. Fold each end over twice. Make sure fold is tight and fasten against end of package with freezer tape.

NOTE: When packaging meats that have not been boned, pad sharp edges with extra wrap or use stockinette to protect against tearing or puncturing.

Use heavy-duty aluminum freezer foil, kraft paper with cellophane bonded to it, special freezer bags, jars, cartons and freezer sealing tape for packaging your food items. You'll find them at the supermarket or freezer dealer.

See booklet, "How to Preserve Foods the Modern Way with Your WHIRLPOOL Freezer," for complete information and tips on home freezing.

Loading...

1. Before freezing large quantities of food, turn Cold Control to highest position and let freezer operate for several hours.
2. To speed freezing, lay packages in a single layer so each rests on the freezing surface of a shelf. Leave space between packages.

3. Add more unfrozen food after first load is frozen (approximately 18 to 24 hours).
4. After all food is frozen, return Cold Control to the usual setting.

Storing frozen food...

After food is frozen, stack packages anywhere in the freezer. Packages should not extend beyond the shelf edge or they may keep the door from closing and sealing properly.



Glide-out basket – Store heavy and bulky packages here. Basket should be in place at all times for proper air circulation.

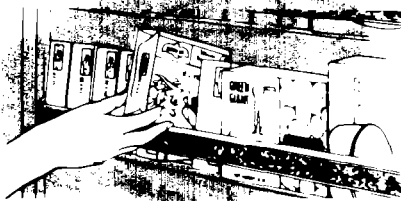

Door storage – Store packages on the door shelves behind the retaining bar.

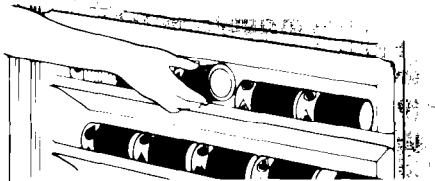

Juice can shelves – Store juice cans on door as shown.

Energy saving tips...

- Check door gasket and level freezer to assure a good door seal.
- Keep door openings to a minimum. Remove several items at one time. Keep contents organized to eliminate searching.
- Fill to capacity. Follow recommended procedures for freezing foods.
- Set Cold Control to provide temperatures around 0°F (-17.8°C). There is no need to store foods below 0°F.
- Keep door locked to insure door closure.
- Clean condenser coils frequently.
- Do not let frost build up to more than ¼ inch (6 mm) thick. Efficiency is reduced.
- Keep Power Saving Control on OFF when humidity is low.

Vacation and moving care

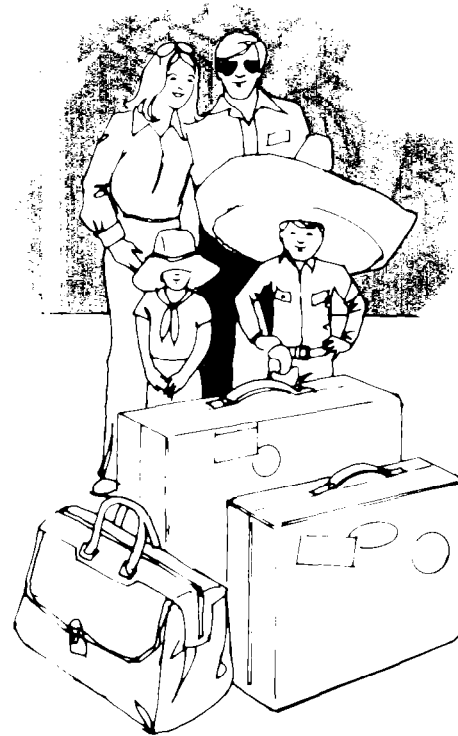

Vacations...

Arrange for someone to make regular checks of your freezer to make sure it is operating and electricity has not been interrupted.

Shutting off and moving...

If freezer is shut off for more than 24 hours:

1. Remove and store all food.
2. Unplug freezer.
3. Move the Temperature Alarm Switch to **OFF**.
4. Clean thoroughly. See "Cleaning your freezer," page 5.
5. Block door open for air circulation. Turn lock to locked position with door open. Place blocks between door and cabinet and tape in place with self-adhesive filament tape.

If you move the freezer:

- Remove shelves and basket.
- Do not place objects inside of cabinet.
- Level properly to insure good door seal.

CAUTION: To help prevent accidents, do not allow children near the freezer when the door is blocked open.

To restart freezer, see "Using your freezer," page 5.

If you need service or assistance, we suggest you follow these four steps:

1. Before calling for assistance...

Performance problems often result from little things you can find and fix yourself without tools of any kind.

If electricity goes off:

Learn how long power will be off by calling the power company.

- If service is to be interrupted 24 hours or less, keep freezer closed. Most food will stay frozen.
- If service is to be interrupted longer than 24 hours, do this:
 1. Remove all frozen food and store in a frozen food locker. Or...
 2. Place dry ice on top of food, using as large pieces as possible. Protect your hands with gloves when using dry ice.
 3. If neither food locker storage or dry ice is available, use or can perishable food at once.
- The length of time food will stay frozen depends on several factors. For instance: a full freezer will remain cold longer than a freezer only partially filled. And a freezer full of meat will stay cold longer than a freezer filled with baked goods. Also, if the food still contains ice crystals, it may be safely refrozen, although the quality and flavor may be affected. Use this food as soon as convenient. If the condition of the food is poor or is in any way questionable, it is wise to dispose of it.

If freezer stops running:

- Check to see if power cord is plugged into the outlet.
- Check fuse box or circuit breaker.
- Check electric company for a power failure.
- Be sure COLD CONTROL is turned on.

If compressor seems to run too long:

- Check to see that condenser, located on back of freezer, is free of dust and lint.
- On hot summer days or if room is hot, compressor will run longer to provide correct amount of cooling.
- If large amounts of unfrozen food have been put into the freezer, compressor will run longer.
- Check to see that there is enough air circulation space above and in back of freezer.

2. If you need assistance* ...

Call Whirlpool COOL-LINE® service assistance telephone number. Dial free from:
 Continental U.S. (800) 253-1301
 Michigan (800) 632-2243
 Alaska & Hawaii (800) 253-1121

and talk with one of our trained Consultants. The Consultant can instruct you in how to obtain satisfactory operation from your appliance or, if service is necessary, recommend a qualified service company in your area.

3. If you need service* ...

Whirlpool has a nationwide network of franchised TECH-CARE® Service Companies. TECH-CARE service technicians are trained to fulfill the product warranty and provide after-warranty service, anywhere in the United States. To locate



TECH-CARE service in your area, call our COOL-LINE service assistance telephone number (see Step 2) or look in your telephone directory Yellow Pages under:

APPLIANCES—HOUSEHOLD— MAJOR—SERVICE & REPAIR	OR	ELECTRICAL APPLIANCES— MAJOR—REPAIRING & PARTS
WHIRLPOOL APPLIANCES FRANCHISE TECH-CARE SERVICE		WHIRLPOOL APPLIANCES FRANCHISED TECH-CARE SERVICE
SERVICE COMPANIES		
XYZ SERVICE CO 123 Maple	999-9999	XYZ SERVICE CO 123 Maple 999-9999
OR		
WASHING MACHINES, DRYERS & IRONERS—SERVICING		
WHIRLPOOL APPLIANCES FRANCHISED TECH-CARE SERVICE		
SERVICE COMPANIES		
XYZ SERVICE CO 123 Maple	999-9999	

4. If you have a problem* ...

Call our COOL-LINE service assistance telephone number (see Step 2) and talk with one of our Consultants, or if you prefer, write to:

Mr. Robert F. Gunts, Vice President
 Whirlpool Corporation
 Administrative Center
 2000 U.S.-33 North
 Benton Harbor, MI 49022

*If you must call or write, please provide: model number, serial number, date of purchase, and a complete description of the problem. This information is needed in order to better respond to your request for assistance.



FSP is a registered trademark of Whirlpool Corporation for quality parts. Look for this symbol of quality whenever you need a replacement part for your Whirlpool appliance. FSP replacement parts will fit right and work right, because they are made to the same exacting specifications used to build every new Whirlpool appliance.



Making your world a little easier.

Part No. 942663 Rev. C
©1984 Whirlpool Corporation

Printed in U.S.A.

Ice Makers, Dishwashers, Built-In Ovens and Surface Units, Ranges, Microwave Ovens, Trash Compactors, Room Air Conditioners, Dehumidifiers, Automatic Washers, Clothes Dryers

