

Pioneer

COMPACT DISC RECORDER / MULTI-CD CHANGER

PDR-W739

Operating Instructions

COMPACT
disc
DIGITAL AUDIO
Recordable
ReWritable

IMPORTANT



The lightning flash with arrowhead symbol, within an equilateral triangle, is intended to alert the user to the presence of uninsulated "dangerous voltage" within the product's enclosure that may be of sufficient magnitude to constitute a risk of electric shock to persons.

CAUTION

**RISK OF ELECTRIC SHOCK
DO NOT OPEN**



CAUTION:
TO PREVENT THE RISK OF ELECTRIC SHOCK, DO NOT REMOVE COVER (OR BACK). NO USER-SERVICEABLE PARTS INSIDE. REFER SERVICING TO QUALIFIED SERVICE PERSONNEL.

The exclamation point within an equilateral triangle is intended to alert the user to the presence of important operating and maintenance (servicing) instructions in the literature accompanying the appliance.

IMPORTANT SAFETY INSTRUCTIONS

READ INSTRUCTIONS — All the safety and operating instructions should be read before the product is operated.

RETAIN INSTRUCTIONS — The safety and operating instructions should be retained for future reference.

HEED WARNINGS — All warnings on the product and in the operating instructions should be adhered to.

FOLLOW INSTRUCTIONS — All operating and use instructions should be followed.

CLEANING — Unplug this product from the wall outlet before cleaning. The product should be cleaned only with a polishing cloth or a soft dry cloth. Never clean with furniture wax, benzene, insecticides or other volatile liquids since they may corrode the cabinet.

ATTACHMENTS — Do not use attachments not recommended by the product manufacturer as they may cause hazards.

WATER AND MOISTURE — Do not use this product near water — for example, near a bathtub, wash bowl, kitchen sink, or laundry tub; in a wet basement; or near a swimming pool; and the like.

ACCESSORIES — Do not place this product on an unstable cart, stand, tripod, bracket, or table. The product may fall, causing serious injury to a child or adult, and serious damage to the product. Use only with a cart, stand, tripod, bracket, or table recommended by the

manufacturer, or sold with the product. Any mounting of the product should follow the manufacturer's instructions, and should use a mounting accessory recommended by the manufacturer.

CART — A product and cart combination should be moved with care. Quick stops, excessive force, and uneven surfaces may cause the product and cart combination to overturn.

VENTILATION — Slots and openings in the cabinet are provided for ventilation and to ensure reliable operation of the product and to protect it from overheating, and these openings must not be blocked or covered. The openings should never be blocked by placing the product on a bed, sofa, rug, or other similar surface. This product should not be placed in a built-in installation such as a bookcase or rack unless proper ventilation is provided or the manufacturer's instructions have been adhered to.

POWER SOURCES — This product should be operated only from the type of power source indicated on the marking label. If you are not sure of the type of power supply to your home, consult your product dealer or local power company.

LOCATION — The appliance should be installed in a stable location.

NONUSE PERIODS — The power cord of the appliance should be unplugged from the outlet when left un-used for a long period of time.

GROUNDING OR POLARIZATION

1 If this product is equipped with a polarized alternating current line plug (a plug having one blade wider than the other), it will fit into the outlet only one way. This is a safety feature. If you are unable to insert the plug fully into the outlet, try reversing the plug. If the plug should still fail to fit, contact your electrician to replace your

obsolete outlet. Do not defeat the safety purpose of the polarized plug.

POWER-CORD PROTECTION — Power-supply cords should be routed so that they are not likely to be walked on or pinched by items placed upon or against them, paying particular attention to cords at plugs, convenience receptacles, and the point where they exit from the product.

OUTDOOR ANTENNA GROUNDING — If an outside antenna or cable system is connected to the product, be sure the antenna or cable system is grounded so as to provide some protection against voltage surges and built-up static charges. Article 810 of the National Electrical Code, ANSI/NFPA 70, provides information with regard to proper grounding of the mast and supporting structure, grounding of the lead-in wire to an antenna discharge unit, size of grounding conductors, location of antenna-discharge unit, connection to grounding electrodes, and requirements for the grounding electrode. See Figure A.

LIGHTNING — For added protection for this product during a lightning storm, or when it is left unattended and unused for long periods of time, unplug it from the wall outlet and disconnect the antenna or cable system. This will prevent damage to the product due to lightning and power-line surges.

POWER LINES — An outside antenna system should not be located in the vicinity of overhead power lines or other electric light or power circuits, or where it can fall into such power lines or circuits. When installing an outside antenna system, extreme care should be taken to keep from touching such power lines or circuits as contact with them might be fatal.

OVERLOADING — Do not overload wall outlets, extension cords, or integral convenience receptacles as this can result in a risk of fire or electric shock.

OBJECT AND LIQUID ENTRY — Never push objects of any kind into this product through openings as they may touch dangerous voltage points or short-out parts that could result in a fire or electric shock. Never spill liquid of any kind on the product.

SERVICING — Do not attempt to service this product yourself as opening or removing covers may expose you to dangerous voltage or other hazards. Refer all servicing to qualified service personnel.

DAMAGE REQUIRING SERVICE — Unplug this product from the wall outlet and refer servicing to qualified service personnel under the following conditions:

- When the power-supply cord or plug is damaged.
- If liquid has been spilled, or objects have fallen into the product.
- If the product has been exposed to rain or water.
- If the product does not operate normally by following the operating instructions. Adjust only those controls that are covered by the operating instructions as an improper adjustment of other controls may result in damage and will often require extensive work by a qualified technician to restore the product to its normal operation.
- If the product has been dropped or damaged in any way.
- When the product exhibits a distinct change in performance — this indicates a need for service.

REPLACEMENT PARTS — When replacement parts are required, be sure the service technician has used replacement parts specified by the manufacturer or have the same characteristics as the original part. Unauthorized substitutions may result in fire, electric shock, or other hazards.

SAFETY CHECK — Upon completion of any service or repairs to this product, ask the service technician to perform safety checks to determine that the product is in proper operating condition.

WALL OR CEILING MOUNTING — The product should not be mounted to a wall or ceiling.

HEAT — The product should be situated away from heat sources such as radiators, heat registers, stoves, or other products (including amplifiers) that produce heat.

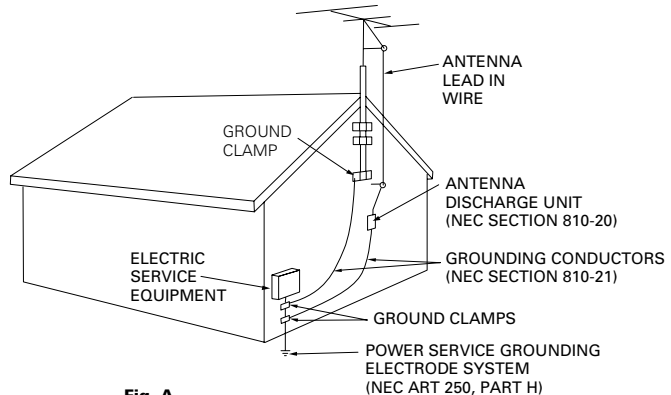

Fig. A

NEC — NATIONAL ELECTRICAL CODE

WARNING: TO PREVENT FIRE OR SHOCK HAZARD, DO NOT EXPOSE THIS APPLIANCE TO RAIN OR MOISTURE.

IMPORTANT NOTICE [For U.S. model]

The serial number for this equipment is located on the rear panel. Please write this serial number on your enclosed warranty card and keep it in a secure area. This is for your security.

[For Canadian model]

CAUTION: TO PREVENT ELECTRIC SHOCK DO NOT USE THIS (POLARIZED) PLUG WITH AN EXTENSION CORD, RECEPTACLE OR OTHER OUTLET UNLESS THE BLADES CAN BE FULLY INSERTED TO PREVENT BLADE EXPOSURE.

ATTENTION: POUR PREVENIR LES CHOCS ELECTRIQUES NE PAS UTILISER CETTE FICHE POLARISEE AVEC UN PROLONGATEUR, UNE PRISE DE COURANT OU UNE AUTRE SORTIE DE COURANT, SAUF SI LES LAMES PEUVENT ETRE INSEREES A FOND SANS EN LAISSER AUCUNE PARTIE A DECOUVERT.

[For Canadian model]

This Class B digital apparatus complies with Canadian ICES-003.

[Pour le modèle Canadien]

Cet appareil numérique de la classe B est conforme à la norme NMB-003 du Canada.

[For U.S. and Canadian models]

DANGER – LASER RADIATION WHEN OPEN. AVOID DIRECT EXPOSURE TO BEAM.

This caution can be found on the rear panel of the unit.

CAUTION:

- Use of controls or adjustments or performance of procedures other than those specified herein hazardous radiation exposure.
- The use of optical instruments with this product will increase eye hazard.

IMPORTANT

FOR USE IN THE UNITED KINGDOM

The wires in this mains lead are coloured in accordance with the following code:

Blue : Neutral
Brown : Live

If the plug provided is unsuitable for your socket outlets, the plug must be cut off and a suitable plug fitted.

The cutoff plug should be disposed of and must not be inserted into any 13 amp socket as this can result in

electric shock. The plug or adaptor of the distribution panel should be provided with a 5 amp fuse. As the colours of the wires in the mains lead of this appliance may not correspond with coloured markings identifying the terminals in your plug, proceed as follows:

The wire which is coloured blue must be connected to the terminal which is marked with the letter N or coloured black.

The wire which is coloured brown must be connected to the terminal which is marked with the letter L or coloured red.

Do not connect either wire to the earth terminal of a three-pin plug.

NOTE

After replacing or changing a fuse, the fuse cover in the plug must be replaced with a fuse cover which corresponds to the colour of the insert in the base of the plug or the word that is embossed on the base of the plug, and the appliance must not be used without a fuse cover. If lost, replacement fuse covers can be obtained from your dealer.

Only 5 A fuses approved by B.S.I. or A.S.T.A. to B.S. 1362 should be used.

[For U.S. model]

This equipment has been tested and found to comply with the limits for a Class B digital device, pursuant to Part 15 of the FCC Rules. These limits are designed to provide reasonable protection against harmful interference in a residential installation. This equipment generates, uses, and can radiate radio frequency energy and, if not installed and used in accordance with the instructions, may cause harmful interference to radio communications. However, there is no guarantee that interference will not occur in a particular installation. If this equipment does cause harmful interference to radio or television reception, which can be determined by turning the equipment off and on, the user is encouraged to try to correct the interference by one or more of the following measures:

- Reorient or relocate the receiving antenna.
- Increase the separation between the equipment and receiver.
- Connect the equipment into an outlet on a circuit different from that to which the receiver is connected.
- Consult the dealer or an experienced radio/TV technician for help.

[For U.K. model]

This product complies with the Low Voltage Directive (73/23/EEC), EMC Directives (89/336/EEC, 92/31/EEC) and CE Marking Directive (93/68/EEC).

INFRINGEMENT OF COPYRIGHT [For U.K. model]

Recording and playback of copyrighted material may require consent. See the Copyright Design and Patent Act 1988.

[For Compact Disc Recorder/Multi-CD Changer PDR-W739] [U.K. model]

CAUTION

This product contains a laser diode of higher class than 1. To ensure continued safety, do not remove any covers or attempt to gain access to the inside of the product.

Refer all servicing to qualified personnel.

The following caution label appears on the unit.

Location: Rear of the unit.



**CLASS 1
LASER PRODUCT**

[For U.S. model]

CAUTION:

This product satisfies FCC regulations when shielded cables and connectors are used to connect the unit to other equipment. To prevent electromagnetic interference with electric appliances such as radios and televisions, use shielded cables and connectors for connections.

Information to User

Alteration or modifications carried out without appropriate authorization may invalidate the user's right to operate the equipment.

Contents

1 Before You Start

Checking what's in the box	6
Using this manual	6
Putting the batteries in the remote	6
Hints on installation	6
Avoiding condensation problems	6
Maintaining your CD recorder	7
Moving the unit	7
CD lens cleaner	7
Power cord caution	7
About CD, CD-R and CD-RW Discs	7
Consumer-use discs	7
Recording copyright material	8
Recording and finalizing discs	8
Playing partially recorded discs	8

2 Connecting Up

Rear panel	9
Connecting optical cords	9
Connecting coaxial cords	9
Connecting stereo audio cords	9
Connecting the control cord	9
Plugging in	9

3 Controls and Displays

Front panel	10
Remote control	11
Display	12

4 Getting Started

Quick CD copying	13
Playing a CD	14
Playback modes	15
Starting playback with a timer	15

5 Copying CDs

Introduction	16
Copying CDs	16
Copying individual tracks	17
Copying a programmed selection	18
Changing the copying speed	19
Setting the recording level	19

6 Finalizing and Erasing

Finalizing a disc	20
Erasing a CD-RW disc	21
Marking recorded tracks to skip	23

7 Playback Functions

Programming a playlist (3-CD changer)	25
Programming a playlist (CD-R)	26
Using the repeat modes	27
Using the random mode	27
Fading in and fading out	28
Switching the display	29

8 Recording Other Sources

Introduction	31
Monitoring a source for recording	31
Digital synchro recording	32
Analog synchro recording	33
Manual recording (analog or digital)	34
Recording blank sections	35
Recording fades	35

9 Additional Information

Handling discs	36
Storing discs	36
Discs to avoid	36
Recording CDs	36
Digital and analog sources	36
Digital recording restrictions	37
Digital recording from DAT	37
Digital signal interruptions	37
Power interruptions	37
Miscellaneous information	37
Understanding display messages	38
Error messages	39
Messages relating to recording	40
Digital synchro recording troubleshooting	40
Troubleshooting	41
Specifications	43

1 Before You Start

Checking what's in the box

Thank you for buying this Pioneer product. Before starting to set up your new CD recorder, please check that you have received the following supplied accessories:

- Stereo audio cords (x2)
- AC power cord*
- Two 'AA' size R6P batteries
- Remote control unit
- Warranty card
- These operating instructions

* **UK only:** the AC power cord is located in the spacer box.

Using this manual

This manual is for the PDR-W739 Compact Disc Recorder/Multi-CD Changer. It is split into two sections; the first covers setting up, and the second, using the recorder. Set up, which starts here, shows you how to install and connect up the recorder to the rest of your system.

In the second section of the manual, starting on page 10, you'll learn how to use the various features of the recorder. The final part of the manual provides a list of display messages, a troubleshooting section, and technical specifications.

Putting the batteries in the remote

- 1 Turn over the remote control, then press and slide the battery compartment cover off.
- 2 Put in the batteries supplied, taking care to match the plus and minus ends of each battery with the markings inside the compartment.
- 3 Slide the cover back on, and your remote is ready for use.

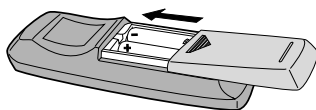
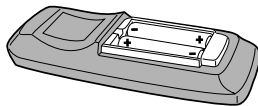
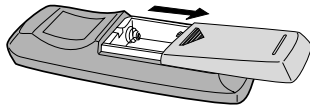

Caution!

Incorrect use of batteries can result in hazards such as leakage and bursting. Please observe the following:

- Don't mix new and old batteries together
- Don't use different kinds of battery together—although they may look similar, different batteries may have different voltages.
- Make sure that the plus and minus ends of each battery match the indications in the battery compartment.
- Remove batteries from equipment that isn't going to be used for a month or more.

Hints on installation

We want you to enjoy using this unit for years to come, so please bear in mind the following points when choosing a suitable location for it:

Do...

- ✓ Use in a well-ventilated room.
- ✓ Place on a solid, flat, level surface, such as a table, shelf or stereo rack.

Don't...

- ✗ Use in a place exposed to high temperatures or humidity, including near radiators and other heat-generating appliances.
- ✗ Place on a window sill or other place where the player will be exposed to direct sunlight.
- ✗ Use in an excessively dusty or damp environment.
- ✗ Place directly on top of an amplifier, or other component in your stereo system that becomes hot in use.
- ✗ Use near a television or monitor as you may experience interference—especially if the television uses an indoor antenna.
- ✗ Use in a kitchen or other room where the player may be exposed to smoke or steam.
- ✗ Use on a thick rug or carpet, or cover with cloth—this may prevent proper cooling of the unit.
- ✗ Place on an unstable surface, or one that is not large enough to support all four of the unit's feet.

Avoiding condensation problems

Condensation may form inside the player if it is brought into a warm room from outside, or if the temperature of the room rises quickly. Although the condensation won't damage the player, it may temporarily impair its performance. For this reason you should leave it to adjust to the warmer temperature for about an hour before switching on and using.

1 Before You Start

Maintaining your CD recorder

To clean the compact disc recorder, wipe with a soft, dry cloth. For stubborn dirt, wet a soft cloth with a mild detergent solution made by diluting one part detergent to 5 or 6 parts water, wring well, then wipe off the dirt. Use a dry cloth to wipe the surface dry. Do not use volatile liquids such as benzene and thinner which may damage the surfaces.

Moving the unit

Before moving this unit, remove all discs, switch the unit off once, then back on again. When all three disc marks have disappeared from the left side of the display, switch off again and unplug from the wall outlet. This procedure returns the unit to its shipping position.

Never lift or move the unit during playback or recording—discs rotate at a high speed and may be damaged.

CD lens cleaner

The compact disc recorder's pickup lens should not become dirty in normal use, but if for some reason it should malfunction due to dirt or dust, consult your nearest Pioneer authorized service center. Although lens cleaners for compact disc recorders are commercially available, we do not recommend using them since some may damage the lens.

Power cord caution

Handle the power cord by the plug part. Do not pull out the plug by tugging the cord, and never touch the power cord when your hands are wet, as this could cause a short circuit or electric shock. Do not place the unit, a piece of furniture, or other object on the power cord or pinch the cord in any other way. Never make a knot in the cord or tie it with other cords. The power cords should be routed so that they are not likely to be stepped on. A damaged power cord can cause a fire or give you an electric shock. Check the power cord once in a while. If you find it damaged, ask your nearest Pioneer authorized service center or your dealer for a replacement.

About CD, CD-R and CD-RW Discs

This unit is compatible with three different types of compact disc:

Playback-only CDs

This unit will playback any ordinary audio CDs carrying the Compact Disc Digital Audio mark shown right.



CD-Recordable discs

Recordable CDs, or CD-R, carry the mark shown right, and are 'write once'. This means that once something is recorded on the disc it is permanent—it can't be re-recorded or erased.



CD-Rewritable discs

Rewritable CDs, or CD-RW, carry the mark shown right. As the name indicates, you can erase and re-record material on these discs so that they can be used over and over again.



Consumer-use discs

This recorder is only compatible with special consumer-use CD-R and CD-RW discs. These are clearly marked **For Music Use Only**, **For Consumer**, or **For Consumer Use**. Other types of CD-R or CD-RW discs, such as those available for computer-based CD recorders, will not work with this recorder.

Pioneer has checked the following branded discs for compatibility with this recorder (as of November 1999):

- Eastman Kodak Company
- FUJI PHOTO FILM CO., LTD.
- Hitachi Maxell, Ltd.
- MITSUI CHEMICALS, INC.
- TAIYO YUDEN CO., LTD.
- TDK CORPORATION
- VERBATIM CORPORATION
- PIONEER CORPORATION

Sample discs from the following makers have also been checked for compatibility (as of November 1999), although at the time of writing discs branded under these names are not available.

- Mitsubishi Chemical Corporation
- RICOH COMPANY, LTD.

Note: Discs from any of the above makers may also be sold under different brand names.

1 Before You Start

Recording copyright material

The price of a consumer-use disc includes a copyright fee that has been paid to the copyright owner (in countries where the copyright fee collection system has been established based on their respective copyright laws). This means that you can use these discs to record music and other material for your personal use. If you want to use a disc for anything other than personal use, you must get permission from the copyright owner (note that copyright laws vary from country to country; check the copyright-related laws in your particular country for more information).

Broadcast programs, CDs, other recorded media (cassettes, vinyl records, etc.) and musical performances are all protected by copyright laws. You must get permission from the copyright owner if you sell, transfer, distribute or lease a disc recorded from the above mentioned sources, or if you use it as part of a business (such as for background music in a store).

Recording and finalizing discs

Unlike other recording media, recordable CDs have a number of distinct states, and what you can do with a disc depends on the current state of the disc. Figure 1. (right) shows the three states—blank, partially recorded, and finalized—and summarizes what's possible (✓) and impossible (✗) in each.

The process of finalization fixes the contents of a CD-R in place for good by creating a Table of Contents (TOC, for short) at the beginning of the disc. This tells a CD player exactly what's on the disc and where to find it. Once a CD-R is finalized, further recording and other changes become impossible. The CD recorder and other CD players treat a finalized disc as an ordinary playback-only CD. (See page 20 for more information on finalizing CD-Rs.)

CD-rewritable discs can be finalized in the same way as CD-R discs, but even after finalization, the disc can still be erased and used over again. Remember that CD-RW discs can only be played on players that are specifically designed to play CD-RW discs: most home CD players will not play these discs, even after the disc has been finalized. (See page 20 for more information on finalizing CD-RWs.)

fig 1. differences between recordable and rewritable discs.

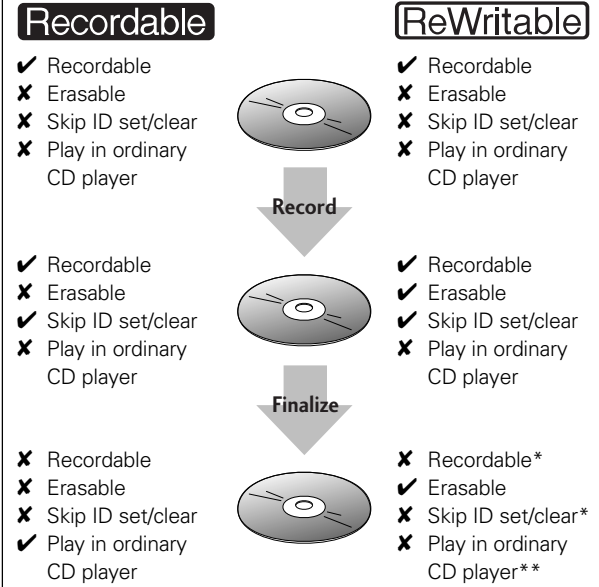

* Once the CD-RW has been erased, it becomes recordable again and skip IDs can be set and cleared.

** In general, current CD players cannot play CD-RW discs. However, this situation may change.

Playing partially recorded discs

Partially recorded discs (discs which contain recorded material but have not yet been finalized) can be played in the 3-CD changer of this unit with the following limitations:

- it will take longer than usual to read the disc when you load it and start playback.
- when the partially recorded disc is stopped, the display will not show any disc time information. During playback, only track elapsed time is displayed; you cannot switch to any other display mode.
- if you play a CD-RW from which tracks have been erased, you may still hear the erased tracks and the disc may not play correctly.
- it may not be possible to play an unfinalized disc if there is very little blank space left.

Rear panel

Important: Before making or changing any rear panel connections, make sure that all the components are switched off and unplugged from the power supply.

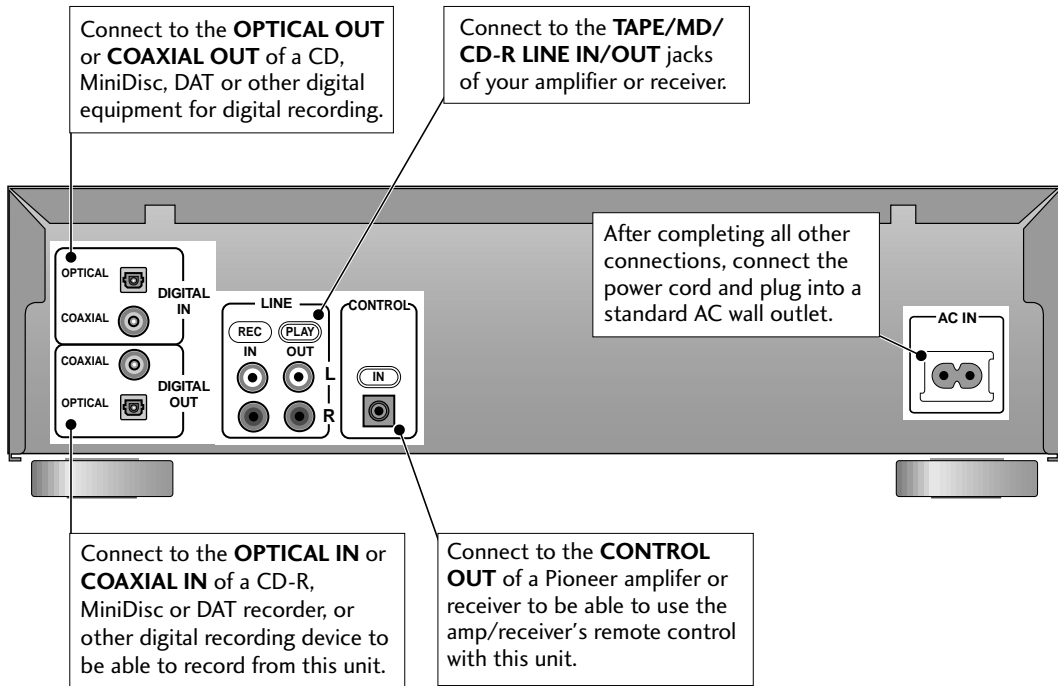

Connecting optical cords

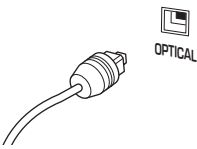

Before plugging in an optical cord, pull out the protective cover from the optical jack.

Optical interconnects only plug in one way, so make sure the plug is correctly lined up with the jack before inserting. You should hear it click into position when fully inserted.

Avoid using optical interconnects longer than 3 meters. Optical interconnects are available from any good audio dealer.

Connecting coaxial cords

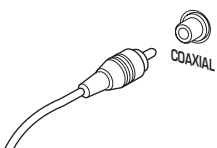

Use a regular interconnect with a pin-type (also called RCA or phono) plug on each end to connect components with digital coaxial-type jacks. These are available from any good audio dealer. Make sure that the plug is pushed fully home.

Connecting stereo audio cords

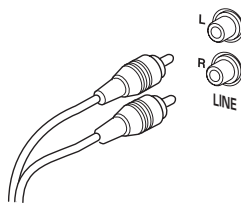

The two sets of stereo audio cords supplied connect this unit to your amplifier/receiver's analog line inputs/outputs. Be sure to fully insert each plug for the best connection. The plugs and jacks are color-coded to make connection easier.

Connecting the control cord

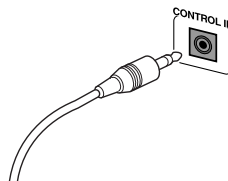

Use a stereo miniplug cord (not supplied) to connect the **CONTROL OUT** of your Pioneer amplifier or receiver to the **CONTROL IN** of this unit. If you plan to use this feature, you must also connect the analog audio **LINE IN/OUTS**.

Plugging in

After double-checking all the connections, connect the power cord to this unit and plug the other end into a standard wall outlet.

Congratulations! You're done setting up.

3 Controls and Displays

Front panel

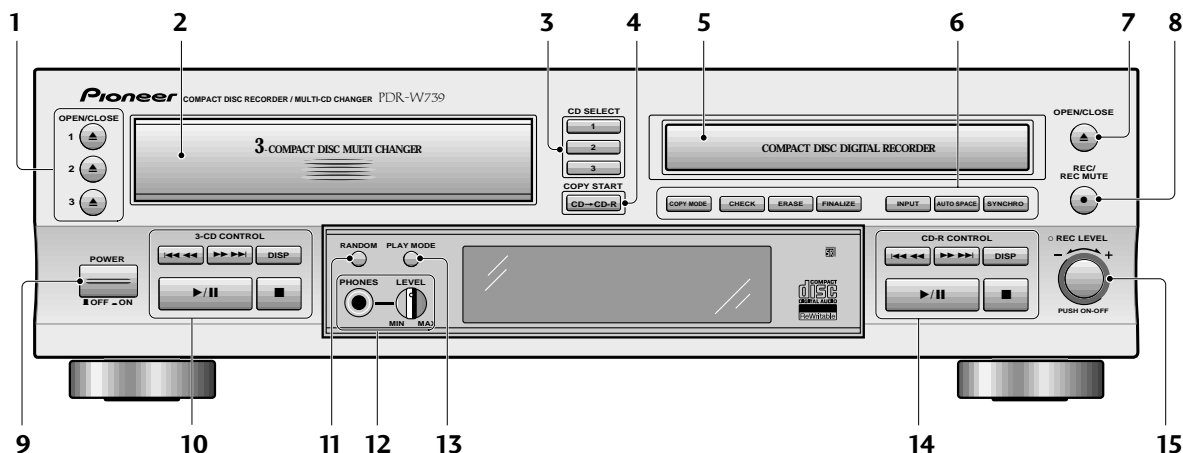

- 1 **OPEN/CLOSE** \triangle 1 / 2 / 3 – Press to open/close disc tray 1, 2 or 3 from the changer.
- 2 **Changer disc tray**
- 3 **CD SELECT** 1 / 2 / 3 – Press to select disc 1, 2 or 3 from the changer. (p.14)
- 4 **COPY START** CD \rightarrow CD-R – Press to start copying from disc(s)/tracks in the CD changer. (p.13, 16–18)
- 5 **CD-R disc tray**
- 6 **CD-R functions**
 - COPY MODE** – Use to select the copy mode: disc, track or program. (p.16–18)
 - CHECK** – Use to check the tracks of a playlist (p.25–26).
 - ERASE** – Use to select the erase mode: last track, multiple tracks, all tracks or TOC. (p.21)
 - FINALIZE** – Press to start finalizing a disc. (p.20)
 - INPUT** – Use to select the external input to use: optical, coaxial or analog line in. (p.31–34)
 - AUTO SPACE** – Press to switch on/off automatic track spacing when copying a programmed playlist. (p.18)
 - SYNCHRO** – Use to select the synchro recording mode when recording from an external component. (p.32–33)
- 7 **OPEN/CLOSE** \blacktriangle – Press to open/close the CD-R disc tray.
- 8 **REC / REC MUTE** \bullet – Press to put the recorder into record-pause mode ready for recording (p.34). Once recording, use to record blank sections onto a disc. (p.35)
- 9 **POWER** \square OFF / \blacktriangle ON – Press to switch the unit on or off.

- 10 **3-CD Controls**
 - $\blacktriangle\blacktriangle\blacktriangle\blacktriangle$ – Press for reverse track skip; press and hold for fast reverse playback. (p.14)
 - $\blacktriangleright\blacktriangleright\blacktriangleright\blacktriangleright$ – Press for forward track skip; press and hold for fast forward playback. (p.14)
 - DISPLAY** – Use to switch the CD display mode (p.29)
 - \blacktriangleright / \parallel – Press to play a disc or pause a disc that's already playing (press again to restart playback). (p.14)
 - \blacksquare – Press to stop playback. (p.14)
- 11 **RANDOM** – Start random track/disc playback. (p.27)
- 12 **PHONES / LEVEL** – Plug in a pair of headphones. Adjust the volume using the level control.
- 13 **PLAY MODE** – Set the play mode to play one disc, all discs in the changer, or all discs in both the changer and CD-R. (p.15)
- 14 **CD-R Controls**
 - $\blacktriangle\blacktriangle\blacktriangle\blacktriangle$ – Press for reverse track skip; press and hold for fast reverse playback. (p.14)
 - $\blacktriangleright\blacktriangleright\blacktriangleright\blacktriangleright$ – Press for forward track skip; press and hold for fast forward playback. (p.14)
 - DISPLAY** – Use to switch the CD-R display mode. (p.30)
 - \blacktriangleright / \parallel – Press to play a disc or pause a disc that's already playing (press again to restart playback). Also use when recording to start or pause recording. (p.34)
 - \blacksquare – Press to stop playback or recording.
- 15 \circ **REC LEVEL** – Turn to adjust the recording level. Push to switch between fixed (LED lit) and variable level recording in digital recording mode, and between automatic recording level (LED lit) and manual level control in analog recording mode. (p.19, 32–34)

Remote control

1 Disc select buttons

- DISC 1/2/3** – Select discs from the changer. (p.14)
- CD-R** – Switch to the CD recorder. (p.14)

2 Playback control buttons

- DISPLAY** – Switch the display mode. (p.29–30)
- – Stop playback or recording.
- ⏸ – Pause playback or recording.
- ▶ – Start or resume playback, or start recording from record-pause mode.
- ◀▶ – Press and hold for fast reverse/forward playback. (p.14)
- ⏮▶ – Skip back/forward tracks. (p.14)

3 Numeric and function buttons

- Number buttons** – Use to select track numbers. (p.14, 25–26)
- 10/0** – Use to input 10 or 0.
- >10** – Use to enter track numbers greater than 10.
- RANDOM** – Start random track/disc playback. (p.27)
- REPEAT** – Set the repeat mode. (p.27)
- FADER** – Fade in or out during playback or recording (CD-R only). (p.28, 35)
- PROGRAM** – Program the playback track order. (p.25–26)
- CHECK** – Check the tracks of a programmed playlist (p.25), and monitor the recording level (p.19)
- CLEAR** – Clear the last programmed track in program play mode. (p.25)

4 Function buttons

- SKIP** – Change the skip ID mode. (p.23–24)
- SKIP SET** – Set a track skip ID for the current track. (p.23)
- SKIP CLEAR** – Clear a skip ID for the current track. (p.24)
- PLAY MODE** – Set the play mode to play one disc, all discs in the 3-CD changer, or all discs in both the changer and CD-R. (p.15)

Keep in mind the following when using the remote control:

- Make sure that there are no obstacles between the remote and the remote sensor on the unit.
- Use within the operating range and angle, as shown right.
- Remote operation may become unreliable if strong sunlight or fluorescent light is shining on the unit's remote sensor.
- Remote controllers for different devices can interfere with each other. Avoid using remotes for other equipment located close to this unit.

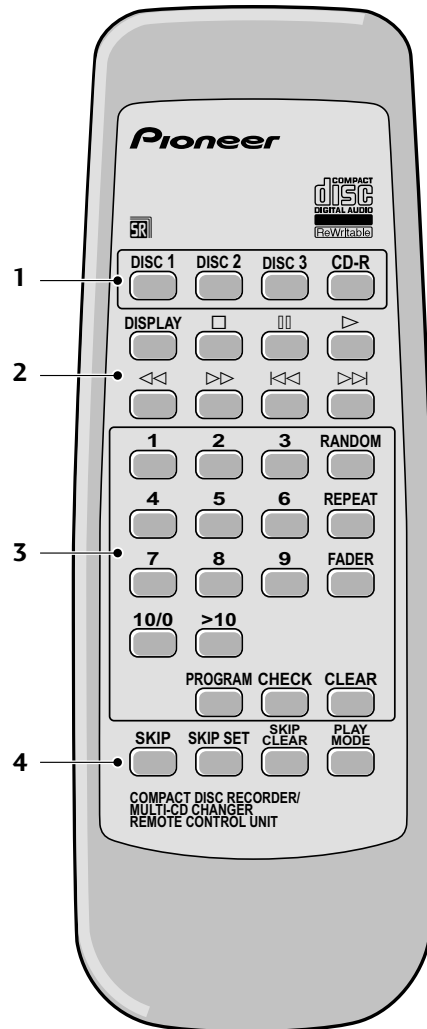

- Replace the batteries when you notice a fall off in the operating range of the remote.

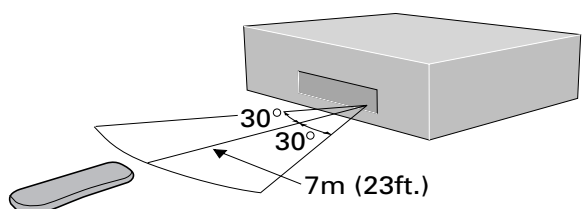

3 Controls and Displays

Display

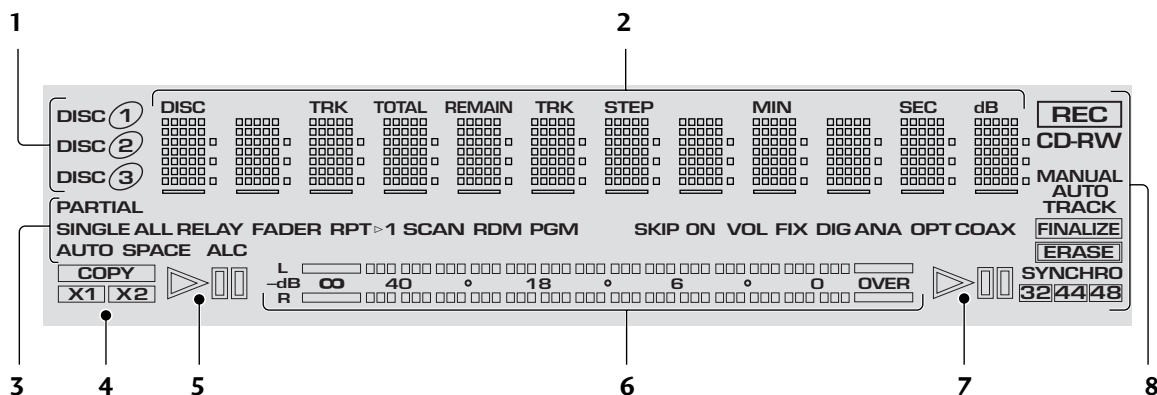

- | | |
|---|---|
| <p>1 DISC 1/2/3 – Indicates discs loaded.</p> <p>2 Message/time display</p> <p>3 Status indicators
 PARTIAL – Lights when a partially recorded CD-R or CD-RW is loaded into the 3 CD changer. Random and repeat play functions are not available when this is lit.
 SINGLE / ALL / RELAY – Indicates the play mode.
 FADER – Lights during fade in or fade out.
 RPT / RPT > 1 – Lights when disc repeat / track repeat is on.
 SCAN – Lights when the recorder is preparing to record.
 RDM – Lights in random-play mode.
 PGM – Lights in program-play mode.
 SKIP – Lights to indicate that a track's skip ID is set. Blinks when clearing a skip ID.
 VOL – Lights when the digital volume level is set to something other than 0dB.
 FIX – Lights when fixed recording level is on.
 DIG / ANA – Indicates whether internal recording is via a digital or analog link.
 ANA / OPT / COAX – Indicates the current input: analog, optical or coaxial.
 AUTO SPACE – Lights when automatic track spacing is on in program copy mode.
 ALC – Lights when automatic analog level control is on.</p> | <p>4 COPY X1 / X2 – Lights when copying disc(s)/tracks from the CD changer, and indicates whether single or double speed.</p> <p>5 ▷ – Lights when a disc in the changer is playing or paused.
 □□ – Lights when a disc in the changer is paused.</p> <p>6 Level meter</p> <p>7 ▷ – Lights when the recorder is playing, paused or recording.
 □□ – Lights when the recorder is paused.</p> <p>8 CD-R function indicators
 REC – Lights when in record or record-pause mode.
 CD / CD-R / CD-RW – Indicates the type of disc currently loaded in the recorder.
 MANUAL / AUTO TRACK – Indicates manual or automatic track numbering.
 FINALIZE – Blinks during auto-finalization recording; lights if a finalized CD-RW disc is loaded.
 ERASE – Lights when recorder is erasing a CD-RW disc.
 SYNCHRO – Lights during internal recording and during synchro recording from an external component.
 32 / 44 / 48 – Indicates the sampling rate of the incoming digital signal.</p> |
|---|---|

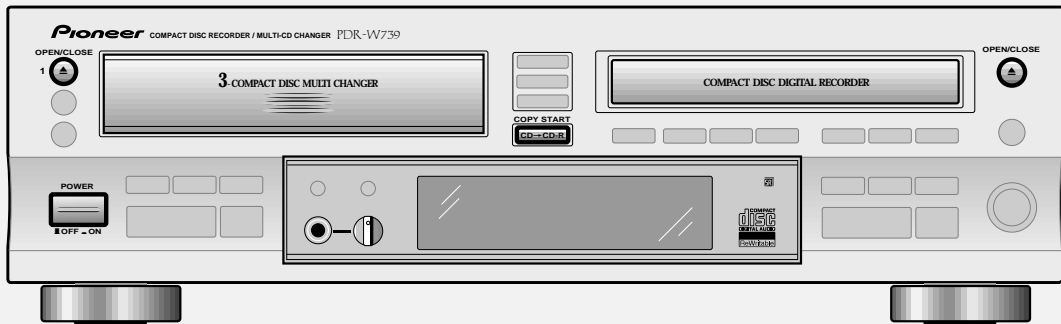

Quick CD copying

Although the PDR-W739 has many advanced recording features, duplicating a CD is pretty much a one-touch operation. Before starting, make sure that the recorder is connected to your amplifier and that everything is plugged in to a power outlet.

For detailed information on other recording features, see chapters 5, 6, 8, and 9.

1 Press the **POWER** button to switch on.

The display lights up.

2 Press **OPEN/CLOSE 1** to eject the **3-CD changer disc tray**.

Place the CD you want to copy, with the label face up, on to the disc tray, making sure that it is seated properly in the disc guide.

Note: Do not use an adapter with 8cm CD-singles. The disc tray has guides for both 12cm and 8cm discs.

3 Press **OPEN/CLOSE 1** to close the **disc tray**.

4 Press **OPEN/CLOSE** to eject the **CD-R disc tray**.

Place a blank CD-R or CD-RW disc, with the label/non-recording side face up, on to the disc tray. Again, make certain that it is seated correctly in the disc guide.

Be careful when handling CD-R and CD-RW discs not to leave fingerprints on the recording surface.

5 Press **OPEN/CLOSE** to close the **disc tray**.

The recorder reads the disc to see what you've loaded. After a few seconds it should tell you that you've loaded a **NEW DISC**.

6 Press **COPY START CD → CD-R**.

The recorder automatically copies at double speed, so if you're listening to the recording as it's being made it will sound a little strange!

After the CD in the changer has finished playing, the recorder will finalize the CD-R to make it playable on most ordinary CD players (for more information on this process, turn to page 8). This process takes just a few minutes after the CD has been copied.

Remove the disc from the recorder before switching off.

4 Getting Started

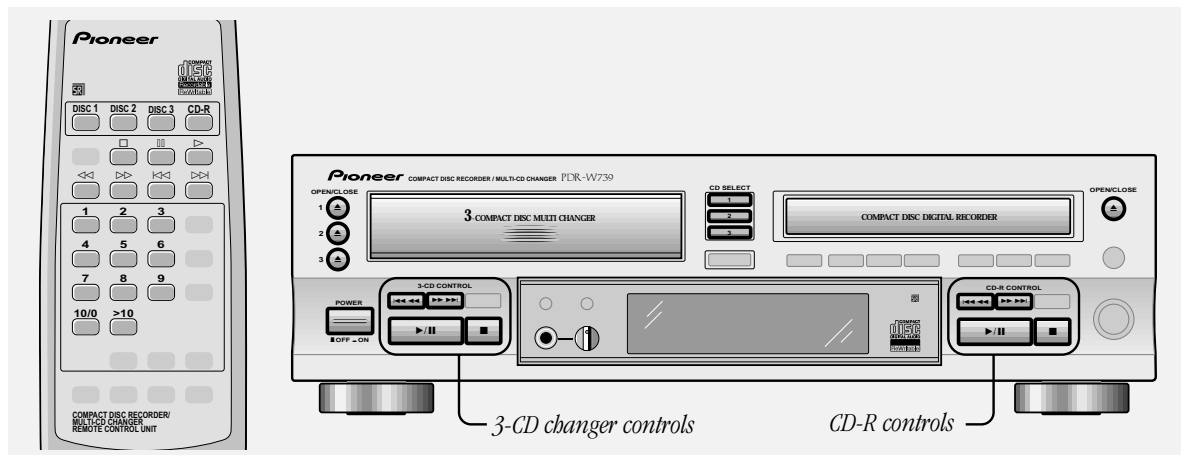

Playing a CD

This section takes you through using the basic playback controls of the CD changer and CD-R. The steps below describe playing a disc in tray 1 of the disc changer, but the playback controls for the CD-R and for other discs loaded into the changer work in exactly the same way.

- 1 If the recorder isn't already on, press POWER to switch on.**

The display lights up.

- 2 Press OPEN/CLOSE 1 ▲ (front panel only) to eject the CD changer disc tray.**

- To open the CD-R tray, press **OPEN/CLOSE ▲** on the right-hand side of the unit.

Place a CD, with the label face up, on to the disc tray, making sure that it is seated properly in the disc guide.

Note: Do not use an adapter when playing 8cm CD-singles. The disc tray has guides for both 12cm and 8cm discs.

- 3 Press OPEN/CLOSE 1 ▲ again to close the disc tray.**
- 4 Press DISC 1 (CD SELECT 1 on the front panel) to start playback.**
 - For CD-R playback, press **CD-R** on the remote control (▶/|| on the front panel).

- 5 To pause playback, press II (▶/|| on the front panel).**

To resume playback, press again.

- 6 To fast-reverse or fast-forward, press and hold ◀◀ or ▶▶ (◀◀◀◀ or ▶▶▶▶) on the front panel).**

Release to resume normal playback.

If you reach the end of the disc while pressing ▶▶ (▶▶▶▶), the display shows **END** and the recorder goes into play-pause mode (you can still reverse-search).

- 7 To skip back or forward to another track, press ◀◀ or ▶▶ (◀◀◀◀ or ▶▶▶▶) on the front panel).**

Pressing ▶▶ (▶▶▶▶) once skips to the start of the next track on the disc. Further presses take you to subsequent tracks.

Pressing ◀◀ (◀◀◀◀) once takes you to the beginning of the current track. Further presses skip to the start of previous tracks.

You can use the track skip buttons while the disc is paused or stopped, too. The track number changes while the disc remains paused/stopped.

- 8 To skip directly to another track, press the corresponding number button.**
 - For track numbers 1 to 10, use the corresponding number.
 - For track numbers over 10, press the >10 button, then enter the track number. For example, to select track 20 press >10, 2, then 10/0.
- 9 To stop playback, press ■.**

If the disc was paused, then the pause mode is canceled.

Remove the disc from the recorder before switching off.

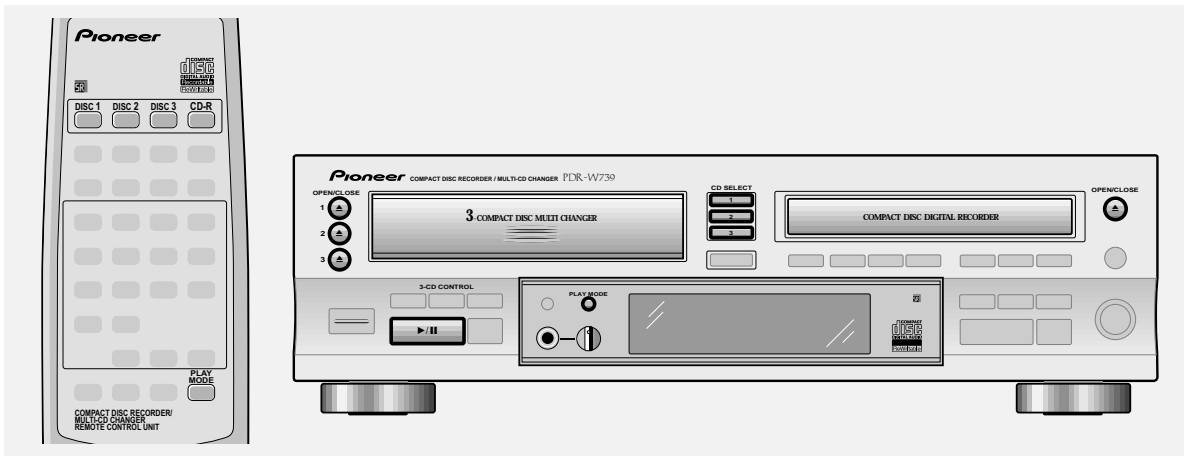

Playback modes

The different play modes let you play either a single disc, or up to four discs one after another for an uninterrupted playing time of up to five hours.

1 Load a disc into disc tray 1 of the changer.

2 Press OPEN/CLOSE 2 ▲.

Disc tray 1 closes and 2 opens. Load a disc into tray 2 of the changer, then close the disc tray.

3 Load discs into tray 3 and the CD-R as you like.

4 Press PLAY MODE to select the disc playback mode.

Press repeatedly to switch between the three play modes:

- **ALL** – all discs loaded in the changer play one after the other (default mode)
- **SINGLE** – a single disc from the changer plays, then stops
- **RELAY** – all discs in the changer, followed by the disc in the CD-R tray, play one after the other

The display shows the current play mode:



5 Press DISC 1 (CD SELECT 1 on the front panel) to start playback.

If you're in **SINGLE** mode, press the **DISC (CD SELECT)** button for the disc you want to play.

In **ALL** or **RELAY** modes, you can start playback from a disc other than 1. However, playback will still stop after disc 3 (**ALL** mode) or the disc in the CD-R tray (**RELAY** mode).

- You can also start playback using the ►/|| button on the 3-CD changer side. Playback will start from whichever **CD SELECT** button is lit.

Starting playback with a timer

You can use this unit with a standard audio timer to start playback at a set time. Simply load a disc (or discs) and set the timer. When power is restored to this unit by the timer, playback will start automatically in the default **ALL** mode.

- Before setting the timer, make sure that all discs loaded into the changer have been read by the unit (wait for the **TOC READ** message to disappear).

5 Copying CDs

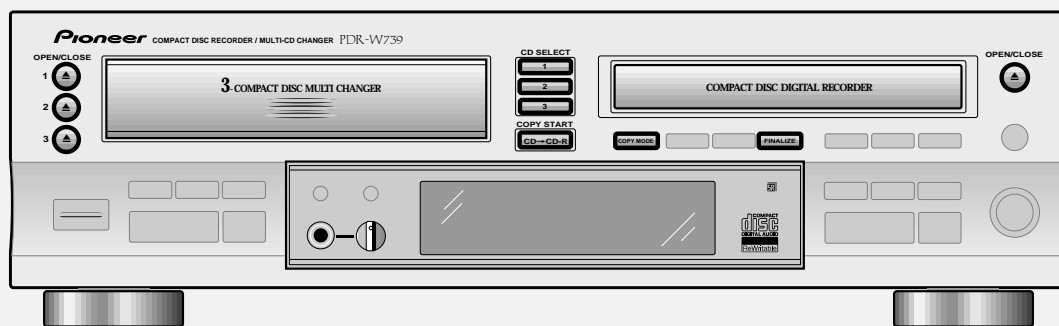

Introduction

Recording CDs from the disc changer has several advantages over recording from an external CD player.

- Double speed copying lets you record a disc in half the regular time.
- Automatic spacing when individual tracks are recorded.
- Automatic SCMS copying makes sure that, whenever possible, you'll get a digital copy. In the event of a disc preventing digital copying with SCMS, the link between the changer and the CD-R automatically switches to analog.

Copying CDs

If you want to duplicate a CD exactly as it is, the easiest way is to follow the steps in *Quick CD Copying* on page 13. The instructions here give you a little more control over the recording you make.

1 Load the CD you want to copy in to the CD changer.

You can use any of the three disc trays in the changer.

2 Load a CD-R or CD-RW into the CD-R tray.

If the disc isn't blank, make sure that there is enough space on the disc for what you want to record (see *Switching the Display* on page 30 for how to check this).

3 Press COPY MODE.

The display shows **Disc Copy**.

If you want to switch the copying speed, do so here. The default is 2x speed. See *Changing the copying speed* on page 19 for how to change it.

4 If you want the disc finalized after recording, press FINALIZE.

The **FINALIZE** indicator blinks.

Remember: Finalizing a CD-R fixes the tracks on the disc—you can't record anything else on to the disc, but it does become playable on most ordinary CD players.

5 Press the DISC (CD SELECT on the front panel) button for the disc you want to record.

If you want to adjust the recording level, do so here. The default is 0dB. See *Setting the recording level* on page 19 for how to adjust it.

6 Press COPY START CD → CD-R.

The recorder starts copying the disc. If **FINALIZE** is on, the recorder will finalize the disc after copying it.

Be careful: if there's a playlist programmed, the tracks appearing on the playlist will be recorded.

- If the button is blinking, there's not enough space on the disc for what you want to record. Press again to start recording anyway, or press ■ (CD-R side) to cancel.

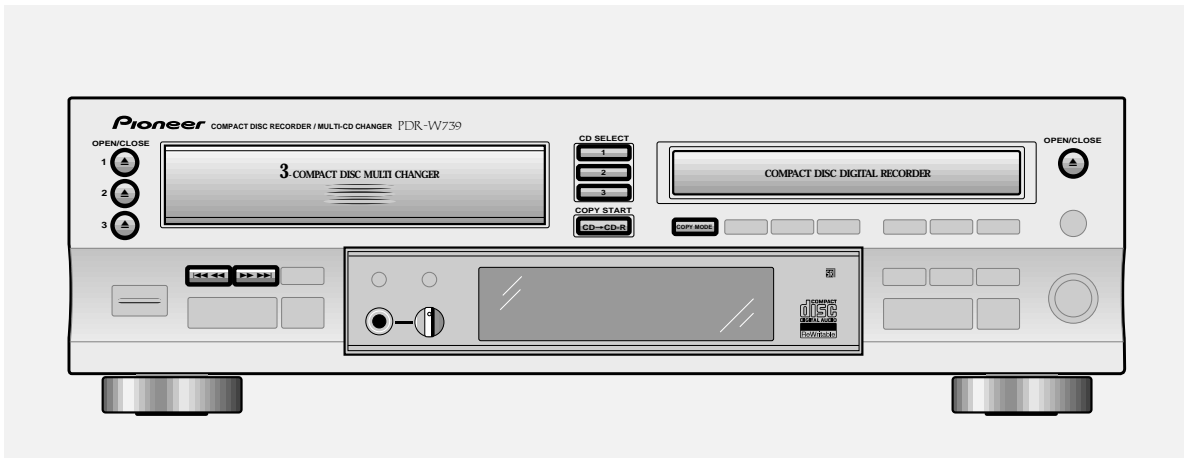

Copying individual tracks

Here's how to copy individual tracks from any disc in the changer:

1 Load the CD(s) you want to copy tracks from in to the CD changer.

You can use any of the three disc trays in the changer.

2 Load a CD-R or CD-RW into the CD-R tray.

If the disc isn't blank, make sure that there is enough space on the disc for what you want to record (see *Switching the Display* on page 30 for how to check this).

3 Press COPY MODE twice.

The display shows **Track Copy**.

If you want to switch the copying speed, do so here. The default is 2x speed. See *Changing the copying speed* on page 19 for how to change it.

4 Press the CD SELECT button for the disc you want to record.

On the remote, use the three **DISC** buttons.

5 Use ◀◀◀ and ▶▶▶ (CD changer side) to select the track you want to record.

On the remote, use the ◀◀ and ▶▶ buttons.

If you want to adjust the digital recording level, do so here. The default is 0dB. See *Setting the recording level* on page 19 for how to adjust it.

6 Press COPY START CD → CD-R.

The recorder starts copying the track and stops automatically when it's finished.

- If you want to now finalize the disc, turn to page 20.

5 Copying CDs

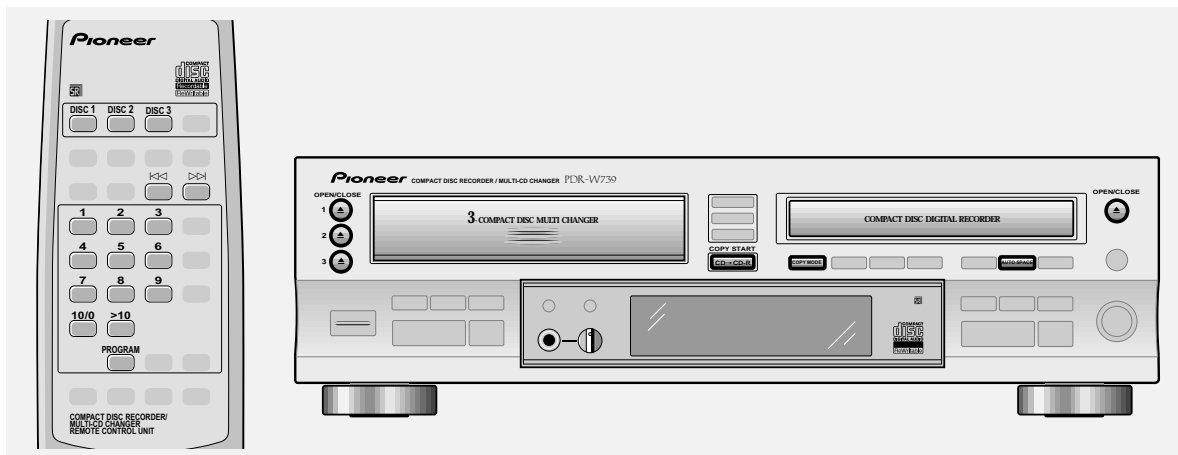

Copying a programmed selection

You can automate the process of making a mix CD by using the programming function of the disc changer.

1 Load the CD(s) you want to program tracks from in to the CD changer.

You can use any of the three disc trays in the changer.

2 Load a CD-R or CD-RW into the CD-R tray.

If the disc isn't blank, make sure that there is enough space on the disc for what you want to record (see *Switching the Display* on page 30 for how to check this).

3 Program a playlist of tracks you want to record.

For detailed instructions on programming a playlist see *Programming a playlist (3-CD changer)* on page 25.

4 Press COPY MODE.

The display shows **Program Copy**.

If you want to switch the copying speed, do so here. The default is 2x speed. See *Changing the copying speed* on page 19 for how to change it.

If you want to adjust the digital recording level, do so here. The default is 0dB. See *Setting the recording level* on page 19 for how to adjust it.

5 If you want to automatically space the tracks on the recording, press AUTO SPACE.

Switching on automatic spacing makes sure that there's a few seconds of silence between each recorded track.

6 Press COPY START CD → CD-R.

Recording stops automatically after the playlist has finished. If the playlist is longer than the recording time available on the CD-R/CD-RW, recording stops when the end of the disc is reached.

- If you want to now finalize the disc, turn to page 20.

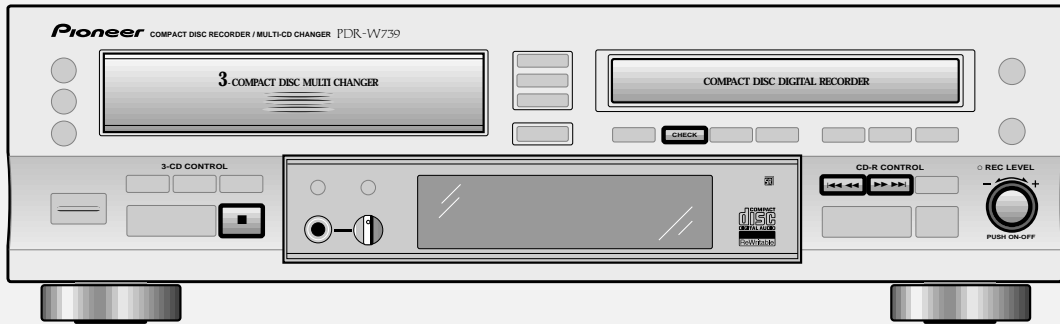

Changing the copying speed

The recorder defaults to double (**x2**) speed, but if you want to listen to the CD as it's recorded, single (**x1**) speed is better.

- 1 Press **⏮⏮⏮** or **⏭⏭⏭** (**CD-R side**) to switch the copying speed.

The **COPY** indicator shows the selected speed (**x1** or **x2**).

Note: when copying or recording at double speed, you can only monitor the recording through the analog outputs, or through a pair of headphones. No signal is output from the digital outputs.

Setting the recording level

When recording commercially produced CDs, the recording level has already been optimized and you don't need to change it. Boosting the level will generally result in distortion where there are peaks in the music. If you're recording a non-commercially produced CD that has been consistently under-recorded, you may need to boost the level.

If you're putting together a mix CD of tracks from different discs you might find that some tracks sound louder than others because average volumes vary. To even this out you may want to reduce the recording level of some tracks.

Note: when recording DTS or HDCD encoded CDs digitally, setting the recording level at anything other than **0dB** will produce a standard audio CD without the DTS/HDCD encoding.

- 1 Press **CHECK** to start the CD playing.

The track/disc to be recorded starts playing and the **SCAN** indicator starts blinking. <deleted>

- 2 Turn the **REC LEVEL** knob to adjust the recording level.

Use the level meter to gauge the best recording level (the loudest sounds in the source should reach no higher than the 0dB mark on the meter; the red segments in the level meter should not light at all).

To reset the level to the same as the source, press the **REC LEVEL** knob (the **FIX** indicator lights).

- 3 When you're satisfied with the recording level, press **CHECK** again.

6 Finalizing and Erasing

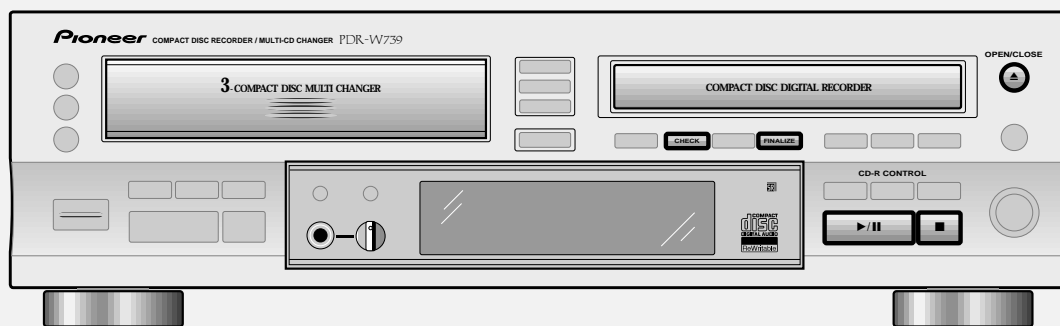

Finalizing a disc

Before you can play a CD-R on an ordinary CD player, the disc must go through a process called finalization. Once finalized, a CD-R disc is no longer recordable. Finalization is not reversible for CD-Rs so be absolutely sure that everything on the disc is the way you want it before you start.

CD-RW discs can also be finalized, although you can still erase the disc afterward and reuse it, so it's not anything like as final as it is with a CD-R disc. A finalized CD-RW disc can only be played on a CD player that is compatible with CD-RW discs (at present, there are very few of these).

Caution!

Finalization takes a few minutes. During this time never switch off the power to the unit—the disc may become unusable as a result. If there's a power failure or you do accidentally disconnect the power during finalization, the recorder will try and complete finalization once power is restored. Unfortunately, it may not be possible to complete the process successfully, and the disc may be damaged as a result.

1 Load the CD-R or CD-RW you want to finalize.

- Check that the disc is free from dust, dirt and scratches—if necessary, clean the disc following the guidelines on page 36.

2 Press FINALIZE.

The recorder goes into record-pause mode, then the display changes to:



- Press ■ (CD-R side) here to cancel finalization.

3 Press ►/II (CD-R side) to start finalization.

Finalization takes about 2 minutes; you'll see how long there is still to go in the display.

After finalization is complete:

If a CD-R is loaded, the CD-R indicator changes to CD.

If a CD-RW is loaded, the finalize indicator lights in the display.

- None of the controls on the player or the remote have any effect during finalization. If, however, the recorder hasn't managed to finalize the disc within 10 minutes, you can abort the operation by pressing ■. If you do this, the disc won't be playable on an ordinary CD player.

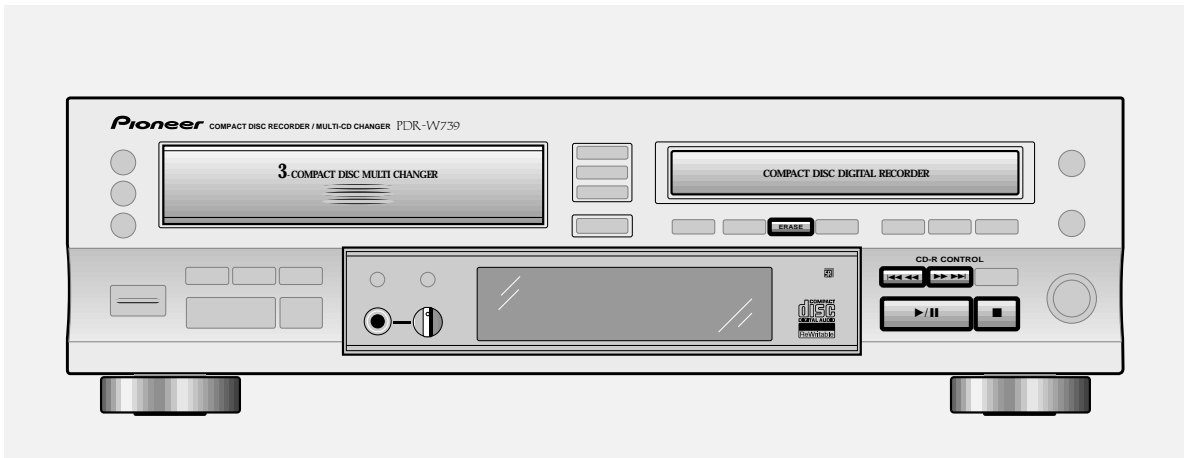

Erasing a CD-RW disc

Although more expensive than CD-R discs, the great advantage of CD-RW is that the discs can be erased and reused. Various erase options are available depending on whether or not the disc has been finalized.

A third, special option, erases (re-initializes) the whole disc. This process takes quite a long time to complete and should be used for recovering damaged discs, not for erasing tracks from a healthy disc.

Caution!

Never switch off the power during CD-RW erasing — your disc may become unusable. If there's a power failure or you do accidentally disconnect the power, the recorder will try and re-initialize the disc once power is restored. Unfortunately, it may not be possible to complete the process successfully, and the disc may be damaged as a result.

If the message **CHECK DISC** appears any time during any erase process, hit eject, take out the disc, clean it, then try the erase command again.

Be sure to remove the disc from the recorder before switching off the power, otherwise the erase operation will not be completed.

When a non-finalized disc is loaded:

1 Press ERASE.

2 Press **⏮** (or **⏭**) to change the erase option.

Switch between:

- Erase just the last track



- Erase all tracks



- Erase multiple tracks (erase from track ... to track ...)



Keep pressing **⏮** (or **⏭**) to change the 'erase from' track — the 'erase to' track is always the last track.

- Press **■** to cancel erase here.

3 Press **▶/II** (CD-R side).

6 Finalizing and Erasing

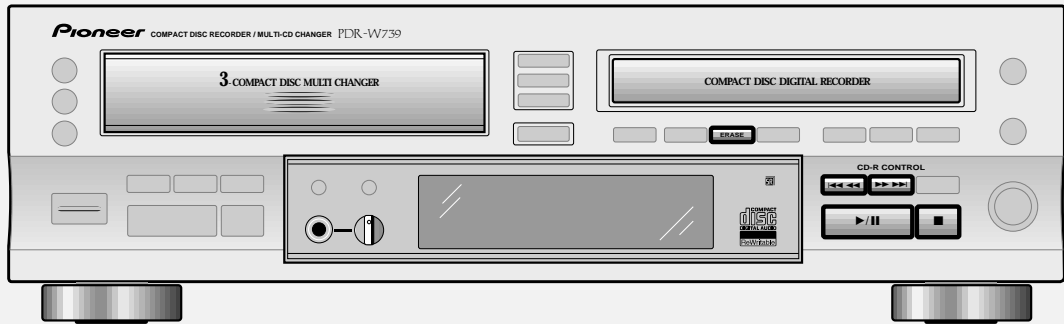

When a finalized disc is loaded:

- 1 Press **ERASE**.
- 2 Press **◀◀◀◀** or **▶▶▶▶** to change the erase option.

Switch between:

- Erase the TOC ('de-finalize' the disc so that further recording is possible)



- Erase all tracks



- Press **■** to cancel erase here.

- 3 Press **▶/II** (CD-R side).

The display shows the time remaining to completion.

- You can halt this erase process by holding down the **■** button for 10 seconds. Make sure, however, that you erase the disc completely at a later date since you can't use a partially erased disc.

Re-initializing a disc

- 1 Press and hold **ERASE** for about four seconds.

The display indicates all disc erase mode. After a short time, the unit goes into erase standby mode:



- Press **■** to cancel all disc erase here.

- 2 Press **▶/II** (CD-R side).

The process takes about half the length of the disc. The display shows the time left to completion.

- You can halt this erase process by holding down the **■** button for 10 seconds. Make sure, however, that you erase the disc completely at a later date since you can't use a partially erased disc.

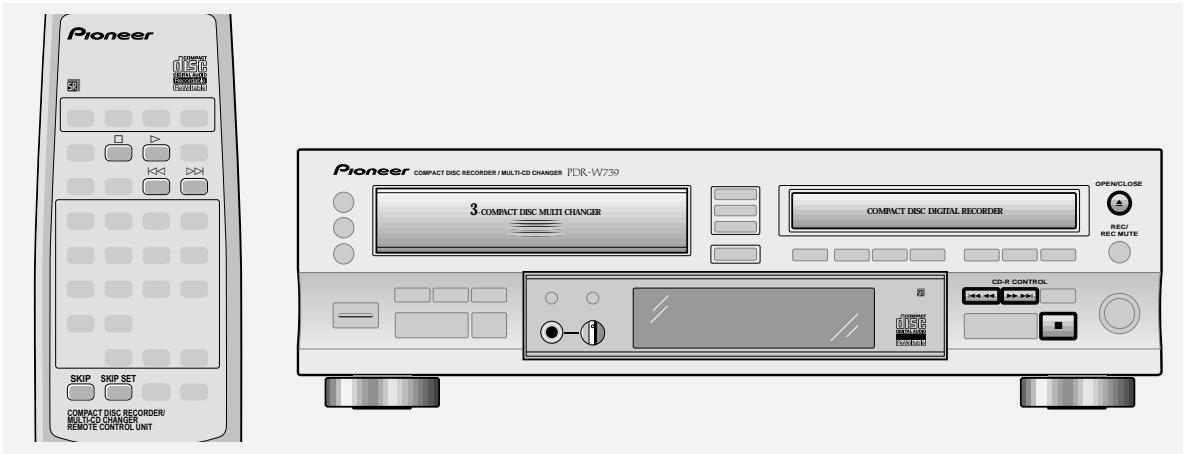

Marking recorded tracks to skip

Although you can't erase tracks on a CD-R disc, you can set what are called 'skip IDs'. These tell a CD player (though many do not recognize skip IDs) not to play a particular track, but to skip to the next one on the disc.

You can also set skip IDs on CD-RWs, although it's probably a less useful feature since you can always erase the last track.

Once a skip ID is set, you can clear it, but be careful: you can set up to 21 skip IDs per disc, but repeatedly setting and clearing skip IDs in different recording sessions will reduce this number.

Setting skip IDs:

1 With the recorder stopped, press **SKIP**.

The display indicates that you're in skip set/clear mode and playback starts.



2 Use the **◀◀** and **▶▶** buttons to select the track you want to skip.

The **SKIP** indicator lights if the track playing is already marked with a skip ID.

3 Press **SKIP SET**.

The **SKIP** indicator starts to blink.



- If the track you selected in step 2 above already had a skip ID set, playback jumps to the next track that doesn't have a skip ID set.
- Use the **◀◀** and **▶▶** buttons if you want to change the track again here.
- If there's no room left on the disc to record another skip ID, the display will show the message **SKIP FULL**.

4 Press **SKIP SET** again to set the skip ID for the track playing.

The **SKIP** indicator lights in the display once a skip ID has been set.

- To cancel, press **■**.

5 Set further skip IDs by repeating steps 2 to 4.

6 When you're finished, press **■** to stop the disc and press **▲** (CD-R side).

Until you eject the disc, the recorder stores the skip ID information in its memory. On pressing **▲**, the recorder writes the skip ID information onto the disc.

Be careful: don't switch off the unit before ejecting the disc—you'll lose this sessions skip ID changes!

6 Finalizing and Erasing

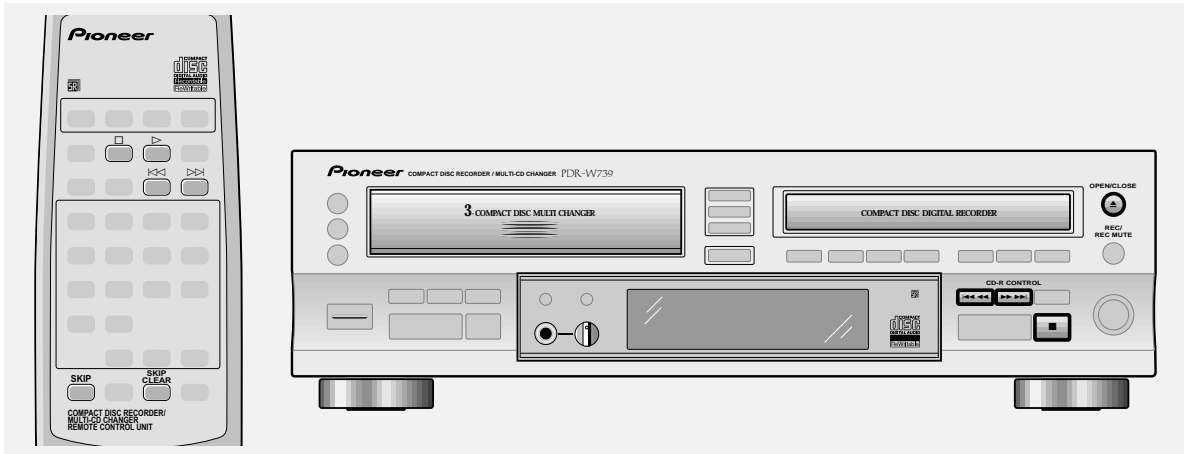

Clearing skip IDs:

- 1 **With the recorder stopped, press SKIP.**

The display indicates that you're in skip set/clear mode and playback starts.



- 2 **Use the ◀◀ and ▶▶ buttons to select the track you want to clear the skip ID for.**

The **SKIP** indicator lights if the track playing is marked with a skip ID.

- 3 **Press SKIP CLEAR.**

The **SKIP** indicator starts to blink.



- If the track you selected in step 2 above didn't have a skip ID set, playback jumps to the next track that does.
- Use the ◀◀ and ▶▶ buttons if you want to change the track again here.
- If there's no room left on the disc to clear a skip ID, the display will show the message **SKIP FULL**.

- 4 **Press SKIP CLEAR again to clear the skip ID for the track playing.**

The **SKIP** indicator disappears once the skip ID has been cleared.

- To cancel, press ■.

- 5 **Clear further skip IDs by repeating steps 2 to 4.**

- 6 **When you're finished, press ■ to stop the disc and press ▲ (CD-R side).**

Until you eject the disc, the recorder stores the skip ID information in its memory. On pressing ▲, the recorder writes the skip ID information onto the disc.

Be careful: don't switch off the unit before ejecting the disc—you'll lose this sessions skip ID changes!

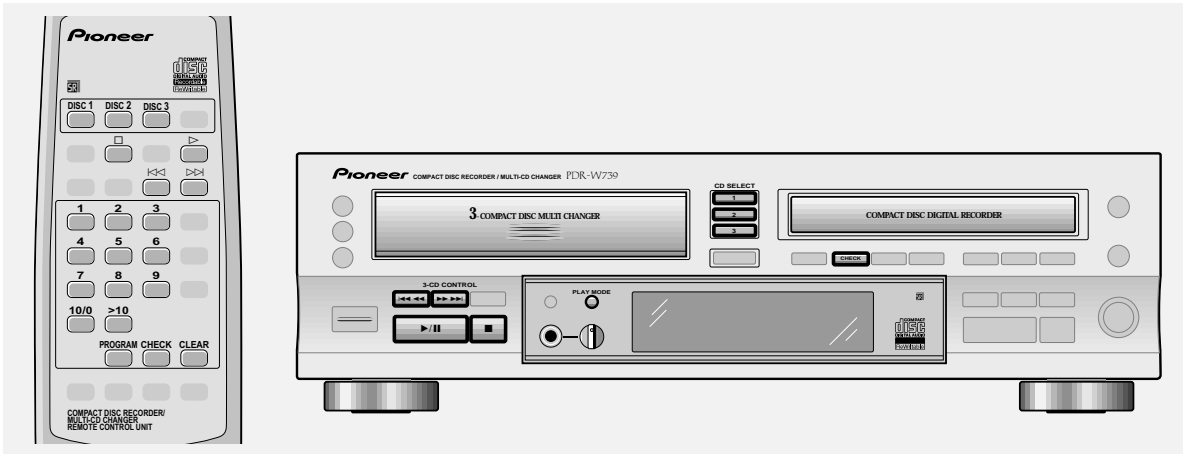

Programming a playlist (3-CD changer)

Programming a playlist means telling the player precisely which tracks, and in what order, you want played. You can program a sequence of up to 30 tracks, playing tracks from any of the discs loaded in the changer, and playing tracks more than once if you like.

1 With all discs stopped, press **PROGRAM**.

The **PGM** indicator lights and the display prompts you to enter the first disc/track in the playlist:



2 Enter the disc/track numbers in the order you want them played.

Use the **DISC** buttons to select the disc.

Use the number buttons to select tracks:

- For track numbers 1 to 10, use the corresponding number button.
- For track numbers over 10, press the **>10** button, then enter the track number. For example, to select track 20 press **>10, 2**, then **10/0**.
- You can also use the **◀◀** and **▶▶** buttons to select tracks, pressing **PROGRAM** after each to enter it into the playlist.

After adding a track to the playlist, the display shows the disc and track number and the total playing time of the playlist:



Note: the display will not show the total playing time of playlists that exceed 100 minutes.

4 Press **▶ (▶/||)** on the front panel) to start playback.

Clearing the playlist

Clear the playlist by either:

- pressing **■** while the disc is stopped.
- pressing **PLAY MODE**.
- playing a disc in the CD-R (playing a disc in the 3-CD changer clears a CD-R playlist).
- ejecting a disc in the changer (or the CD-R disc tray to clear a CD-R playlist).

Clearing a track from the playlist

With playback stopped, delete the last (most recently) programmed track by pressing **CLEAR**. Press repeatedly to clear several steps.

Checking what's in the playlist

When the disc is stopped you can check the contents of the playlist using the **CHECK** button. Each press steps through the playlist, showing the step number and the corresponding disc and track number.

Adding a track to the playlist

During playback, you can add the track currently playing to the playlist by pressing **PROGRAM** twice. If there is currently no playlist, then one is created.

7 Playback Functions

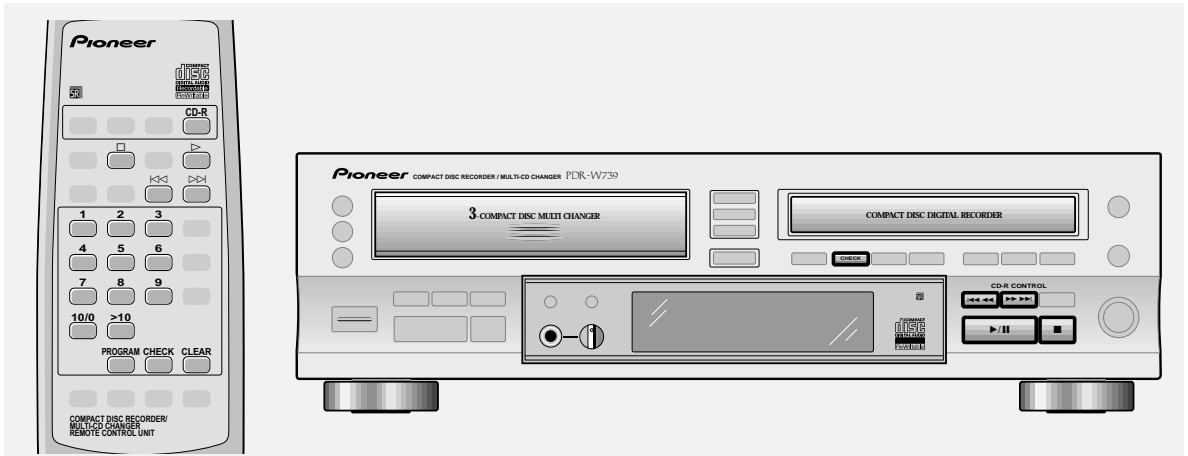

Programming a playlist (CD-R)

You can program a playlist for a disc that's in the CD-R disc tray. When you eject the disc, the playlist is lost.

1 Press CD-R then ■ to stop playback.

2 Press PROGRAM.

The **PGM** indicator lights and the display prompts you to enter the first track in the playlist:



3 Enter the track numbers in the order you want them played.

Use the number buttons to select tracks:

- For track numbers 1 to 10, use the corresponding number button.

- For track numbers over 10, press the **>10** button, then enter the track number. For example, to select track 20 press **>10**, **2**, then **10/0**.
- You can also use the **◀◀** and **▶▶** buttons to select tracks, pressing **PROGRAM** after each to enter it into the playlist. After adding a track to the playlist, the display shows the track number and the total playing time of the playlist:



Note: the display will not show the total playing time of playlists that exceed 100 minutes.

4 Press ▶ (▶/II on the front panel) to start playback.

Note: Clearing, checking and changing the playlist is the same as for the 3-CD disc changer.

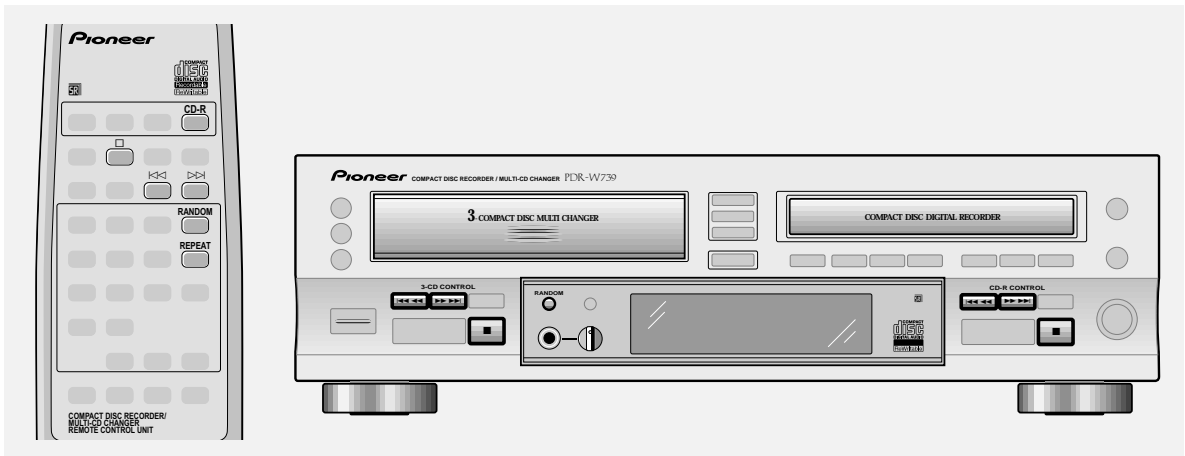

Using the repeat modes

Use the repeat function to repeat either the current track, an entire disc, or all discs loaded over and over. You can set the repeat mode in normal, random or program play modes.

Press REPEAT to select the repeat mode.

Keep pressing repeat to switch between the two repeat modes and repeat off:

- **1-track repeat** – the **RPT-1** indicator lights and the current track repeats. To start a new track repeating, select the track using the **◀◀** and **▶▶** buttons. Press **REPEAT** twice to cancel repeat playback.
- **All repeat** – the **RPT** indicator lights. In **SINGLE** mode, the current disc will repeat; in **ALL** mode, all discs in the 3-CD changer will repeat. Press **REPEAT** again to cancel repeat playback.

Note: You can't use repeat play in **RELAY** mode.

Switching to **RELAY** mode will cancel repeat play. (see page 15 for more on play modes).

Using the random mode

To have the recorder play tracks in a different order each time you play a disc, use the random play mode. Each track will play just once, but the order will be random. When all the tracks have been played, the disc stops.

You can use random playback together with program play—tracks from the playlist will play in a random order.

Press RANDOM to start random playback.

The **RDM** indicator lights and a track is chosen at random.

To select a new random track at any time, press **RANDOM**. Press **■** to cancel random play.

- You can't use random play in **RELAY** mode. Switching to **RELAY** mode will cancel random play. (see page 15 for more on play modes).
- For random play of a disc loaded into the CD-R tray, press **CD-R** on the remote first, then **RANDOM**.

7 Playback Functions

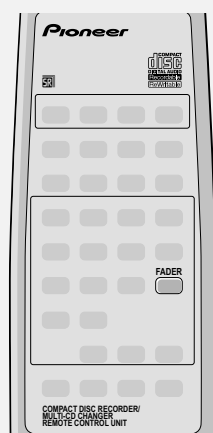

Fading in and fading out

CD-R side only

Use the fader feature to fade the volume down gradually and pause playback. You can also have the player fade in the volume when you resume playback.

Note: you can only hear the fades through the analog outputs.

Press FADER during playback to pause the disc.

The **FADER** indicator in the display blinks and the volume fades to silence over about five seconds. The unit then pauses playback.

Press FADER to resume playback of a paused disc.

The **FADER** indicator in the display blinks and the volume starts to fade in.

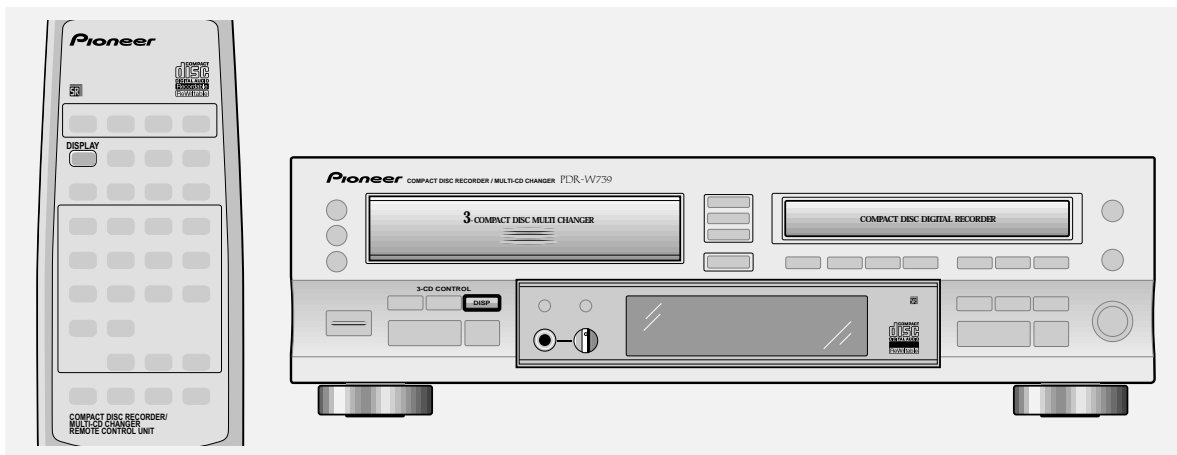

Switching the display

(CD changer side)

The recorder can display various kinds of disc and track information in both playback and copying modes. The information applies only to the currently playing disc. The display button switches between the different display modes.

When all discs are stopped, press **DISPLAY** to switch the display mode.

Press **DISPLAY** repeatedly to show the total playing time of each disc loaded in turn.

- Number of tracks / total disc time (CD-1)



- Number of tracks / total disc time (CD-2)



- Number of tracks / total disc time (CD-3)



During playback or play-pause, press **DISPLAY** to switch the display mode.

There are four different displays. Press **DISPLAY** repeatedly to switch between them:

- Track number / time elapsed



- Track number / time remaining



- Disc time remaining



- Number of tracks / total disc time



7 Playback Functions

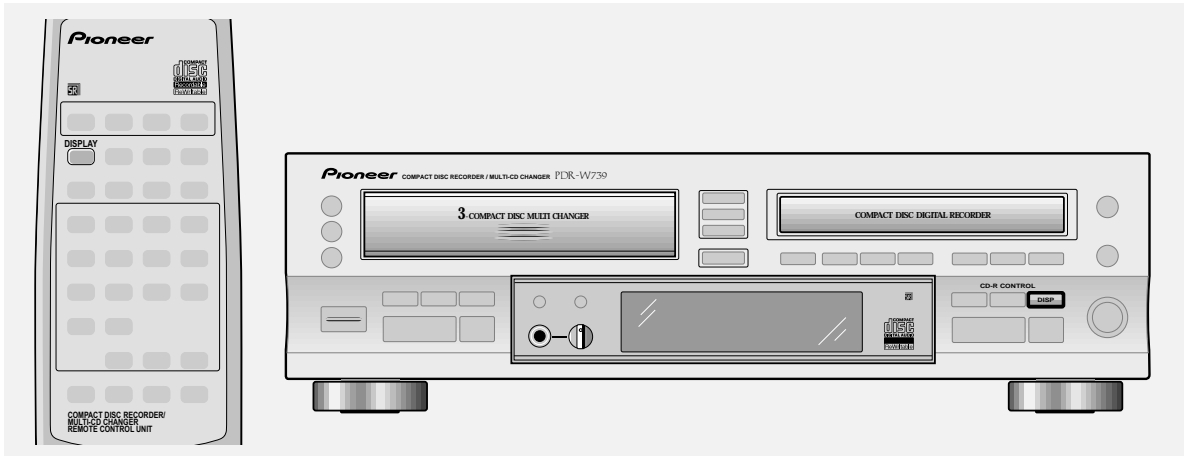

(CD-R side)

When the CD-R is stopped, press DISPLAY to switch the display mode.

There are four different displays. Press **DISPLAY** repeatedly to switch between them:

- Track number / time elapsed



- (Track number / time remaining)



- Recording time left on CD-R/CD-RW disc



- Number of tracks / total disc time



During playback or play-pause, press DISPLAY to switch the display mode.

There are four different displays. Press **DISPLAY** repeatedly to switch between them:

- Track number / time elapsed



- Track number / time remaining



- Disc time remaining



- Number of tracks / total disc time



During copying or recording, press DISPLAY to switch the display mode.

There are three different displays. Press **DISPLAY** repeatedly to switch between them:

- Track number / elapsed track recording time



- Recording time left on CD-R/CD-RW disc



- Total elapsed recording time



Note: Although compatible with 80 minute discs, the remaining recording time display will show 79:57 for blank 80 minute discs.

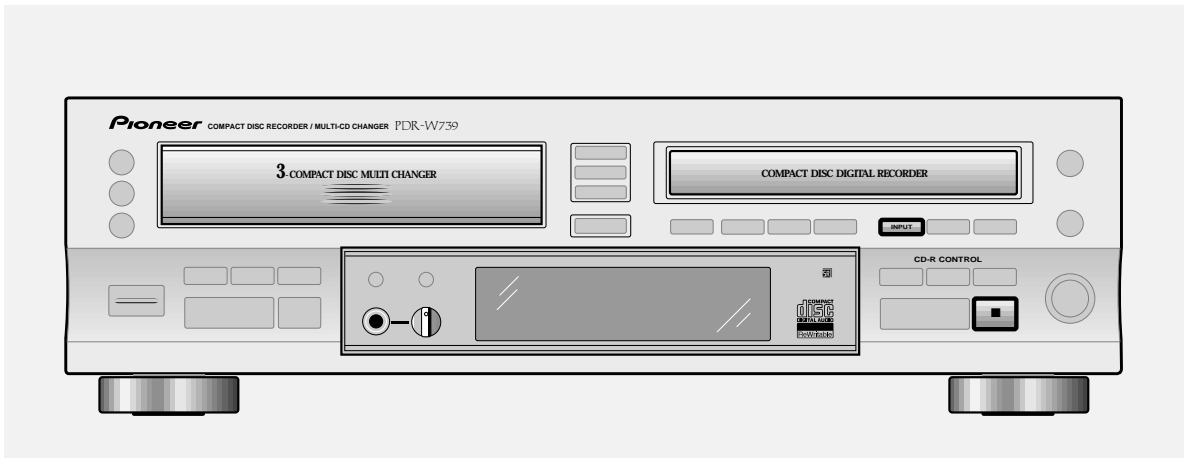

Introduction

Use the various recording modes described here when you're recording from a component connected to the recorder either directly via an optical or coaxial digital connection, or via your amplifier to the the analog line in jacks.

For most sources, both analog and digital, it's convenient to use one of the synchro recording modes: 1-track, all track or all track with finalize.

Should your particular recording application need it, there's also a manual recording mode.

When recording from external sources, bear in mind the following:

- Most CDs, MDs, DCCs and DATs are digital-copy protected, which generally means that you can make a copy of the original, but not a copy of a copy.
- When recording incompatible or copy-protected digital sources, use the analog inputs.
- When recording digitally from DAT, the start ID track markers on the tape may be after the start of the track. Check the tape you're planning to record and manually insert new start IDs before recording.

These points are covered in more detail in Additional Information on pages 36–37.

Monitoring a source for recording

Using the monitor facility you can listen to a source connected to the analog or digital inputs. This is especially useful for setting the recording level and/or checking the compatibility of a digital source connected to the optical or coaxial input.

- 1 Stop playback of any discs playing in this unit.**
- 2 Start playing the source.**
- 3 Press INPUT to select the input to be monitored.**

Pressing **INPUT** repeatedly switches the active input:
ANALOG – OPTICAL – COAXIAL

The recorder's display indicates the current input.
- 3 The display shows monitoring information.**

If the source is digital, the display indicates the type of source if it recognizes it (CD, MD, DVD, DAT, DCC) and the sampling rate (32kHz, 44kHz, 48kHz). If the digital signal is incompatible or copy-protected, the display shows **Can't copy**.

If the source is analog, the display shows **MONITOR**.

The level meter shows the recording level. Adjust using the **REC LEVEL** knob.
- 4 To stop monitoring, press ■ (CD-R side).**

8 Recording Other Sources

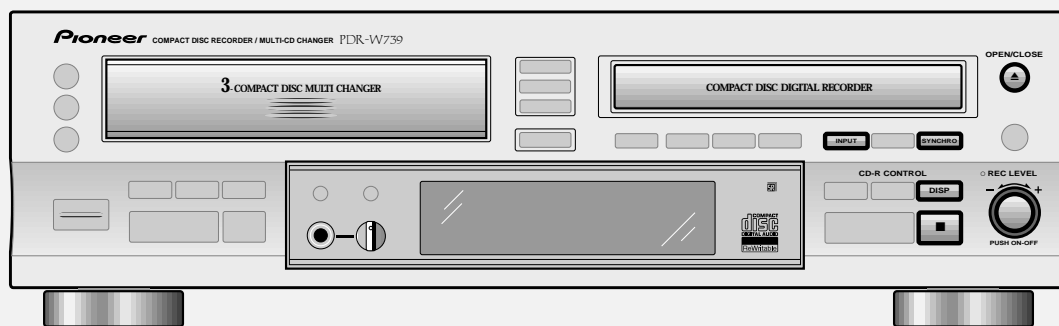

Digital synchro recording

If you have a CD, MD, DAT or DCC player connected to either of the digital inputs of this recorder, you can make digital recordings from it very simply using this mode.

Note that double speed recording is not possible in this mode.

1 Make sure that any discs loaded in the CD changer are stopped.

2 Load a CD-R or CD-RW disc.

If it's a blank disc, the display shows **NEW DISC**.

If the disc isn't blank, use the **DISPLAY** button to check that there's enough space on it for what you want to record.

3 Press **INPUT** to choose optical or coaxial input.

Pressing **INPUT** repeatedly switches the active input:

ANALOG – OPTICAL – COAXIAL

The recorder's display indicates the current input.

4 If you want to adjust the recording level:

Start playing a sample of the source material, then turn the **REC LEVEL** knob to adjust the recording level (clockwise to increase or anticlockwise to reduce). Use the level meter to gauge the the best recording level (the loudest sounds in the source should just reach 0dB on the meter; the red segments in the level meter should not light at all).

- Push the **REC LEVEL** knob to reset the recording level. This means that the recording level will be the same as the source.

5 Make sure that the source is not playing, then press **SYNCHRO**.

Digital synchro recording will not work if the source is already playing!

Pressing **SYNCHRO** repeatedly switches the synchro mode:

- **1-track synchro** – recorder stops recording when it encounters a new track number/start ID on the source or 5 seconds of silence.
- **all-track synchro** – recorder stops recording when it detects more than 5 seconds of silence in the source material.
- **all-track with finalize** – as all-track synchro, but the recorder automatically finalizes the disc after recording. The **SYNCHRO** indicator and play light will start to blink when the recorder is ready.

To cancel recording here, press ■.

6 Play the source.

The recorder starts recording automatically.

Press **DISPLAY** to switch displays during recording.

7 The recorder goes into record-pause after recording.

Be careful: In all-track synchro mode, if the recorder detects another signal, recording starts again.

- If you're using all-track synchro with finalize, the recorder will start finalizing the disc after a minute of silence.
- Press ■ to finish the recording before ejecting the disc.

If you find that digital synchro recording does not seem to work, see Digital synchro recording troubleshooting on page 40 for possible remedies.

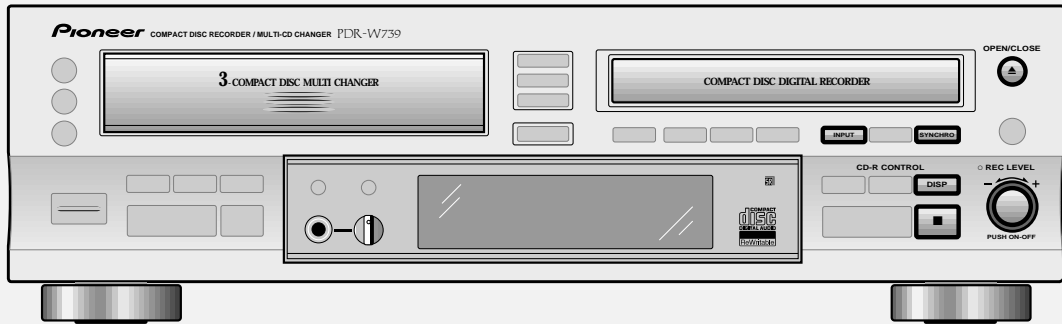

Analog synchro recording

Use the analog line inputs when recording from your turntable, cassette deck, or other analog audio source.

Note that double speed recording is not possible in this mode.

1 Make sure that any discs loaded in the CD changer are stopped.

2 Load a CD-R or CD-RW disc.

If it's a blank disc, the display shows **NEW DISC**.

If the disc isn't blank, use the **DISPLAY** button to check that there's enough space on it for what you want to record.

3 Press INPUT to choose the analog line inputs.

Pressing **INPUT** repeatedly switches the active input:

ANALOG – OPTICAL – COAXIAL

The recorder's display indicates the current input.

4 If you want to adjust the recording level:

Start playing a sample of the source material, then turn the **REC LEVEL** knob to adjust the recording level (clockwise to increase or anticlockwise to reduce). Use the level meter to gauge the the best recording level (the loudest sounds in the source should just reach 0dB on the meter; the red segments in the level meter should not light at all).

- Push the **REC LEVEL** knob to choose automatic recording level control (the **ALC** indicator lights) and let the recorder adjust the recording level automatically.

5 Make sure that the source is not playing, then press SYNCHRO.

Analog synchro recording will not work if the source is already playing!

Pressing **SYNCHRO** repeatedly switches the synchro mode:

- **1-track synchro** – recorder stops recording when it encounters more than 5 seconds of silence.
- **all-track synchro** – recorder starts a new track when it encounters another signal after more than 2 seconds of silence*. Recording stops when the recorder detects more than 5 seconds of continuous silence.

- **all-track with finalize** – as all-track synchro, but the recorder automatically finalizes the disc after recording.

The **SYNCHRO** indicator and play light will start to blink when the recorder is ready.

To cancel recording here, press ■.

6 Play the source.

The recorder starts recording automatically.

Use the **DISPLAY** button to switch displays during recording.

7 The recorder goes into record-pause after recording.

Be careful: In all-track synchro mode, if the recorder detects another signal, recording starts again.

- If you're using all-track synchro with finalize, the recorder will start finalizing the disc after a minute of silence.
- Press ■ to finish the recording before ejecting the disc.

* *Track numbering may not work reliably for some sources (such as those which are very noisy, or those which contain pauses or very quiet sections).*

8 Recording Other Sources

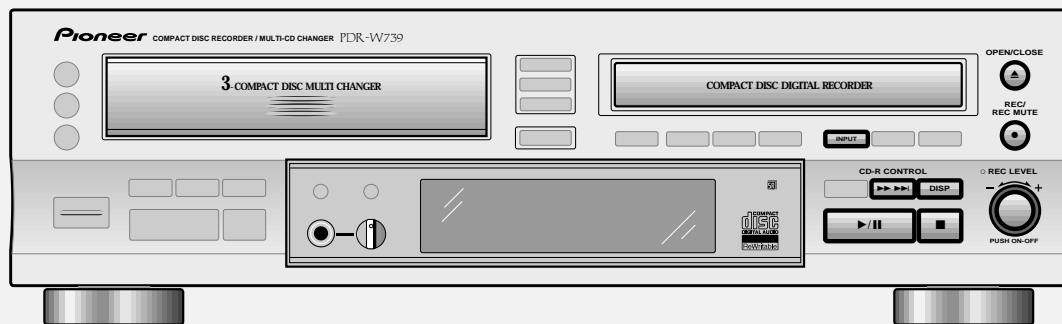

Manual recording (analog or digital)

The main use for manual recording mode is when there are no specific start and/or end points in the source material — when you're recording from a tuner or a satellite decoder, for example.

1 Make sure that any discs loaded in the CD changer are stopped.

2 Load a CD-R or CD-RW disc.

If it's a blank disc, the display shows **NEW DISC**.

If the disc isn't blank, use the **DISPLAY** button to check that there's enough space on it for what you want to record.

3 Press **INPUT** to choose the input to use.

Pressing **INPUT** repeatedly switches the active input:

ANALOG – OPTICAL – COAXIAL

The recorder's display indicates the current input.

4 Press **REC**.

The recorder indicates that it's in record-pause mode.

5 For digital sources, check that the signal is compatible.

Set the source playing (if it isn't already) and check the display. If you see the message **Can't rec** or **Can't copy** the digital signal is either a format that the recorder doesn't recognize, or the source is copy protected. Record through the analog line inputs if you see either message.

6 Adjust the recording level, if necessary:

- To adjust the recording level when using a digital input, see step 4 of *Digital synchro recording* on page 32.
- To adjust the analog recording level when using the analog inputs, see step 4 of *Analog synchro recording* on page 33.

7 Press **▶/II** (CD-R side) to start recording.

8 Start the source playing.

During recording, press **▶▶▶▶|** (CD-R side) anywhere you want a new track to start.

9 When you're finished, press **■** to stop recording.

If you want to finalize the disc after recording, see page 20.

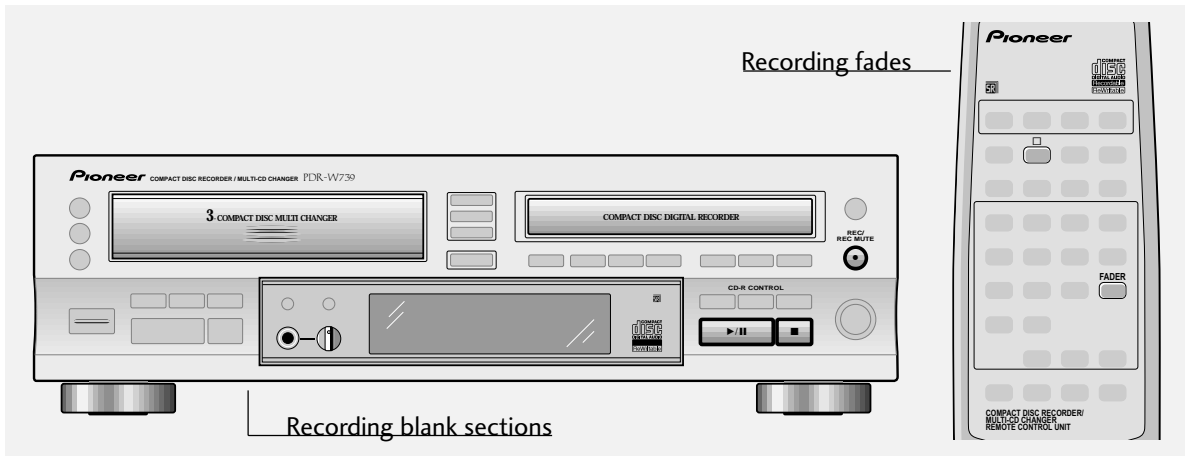

Recording blank sections

This feature is useful when you want to put some space at the end of a recording session so that the next recording doesn't start after the last too closely, but use it wherever you need some blank space recorded on the disc. Note that you can't start a recording with a muted section; only after the recording has started, or at the end of a recording.

1 While recording, or in record-pause mode, press ●.

The **REC** indicator starts blinking and a blank space of about four seconds is recorded. The recorder then goes into record-pause. If you start recording again, a new track is started.

- If you press and hold ●, you can record a blank for as long as you hold down the button.
- Pressing ●, (without holding) in record-pause mode records four seconds of silence from the current position. Use this to create spaces between tracks when recording in 1-track synchro mode, for example.

2 To finish the recording session here, press ■.

- To restart recording, press ►/||.

Recording fades

When recording a radio or satellite broadcast, or just an excerpt from a recorded piece of music, you may want to fade in the recording at the start, then fade out again to finish.

Note: fade in recording is only possible in the manual recording mode (see page 35). Fade outs are possible in any of the synchro recording modes (see pages 33–34) or the manual recording mode.

With the source playing, press FADER in record-pause mode to fade in.

Recording starts with a gradual fade in.

Press FADER during recording to fade out.

After recording the fade out, the recorder goes into record-pause. To finish the recording session here, press ■.

If you record a fade out during all-track synchro recording, the synchro mode is cancelled after the fade out.

9 Additional Information

Handling discs

When holding CDs of any type, take care not to leave fingerprints, dirt or scratches on the disc surface. Hold the disc by its edge or by the center hole and edge. Damaged or dirty discs can affect playback and/or recording performance. Take care also not to scratch the label side of the disc. Although not as fragile as the recording side, scratches can still result in a disc becoming unusable.



Should a disc become marked with fingerprints, dust, etc., clean using a soft, dry cloth, wiping the disc lightly from the center to the outside edge as shown in the diagram below. If necessary, use a cloth soaked in alcohol, or a commercially available CD cleaning kit to clean a disc more thoroughly. Never use benzine, thinner or other cleaning agents, including products designed for cleaning vinyl records.



Wipe lightly from the center of the disc using straight strokes.



Don't wipe the disc surface using circular strokes.

Storing discs

Although CD, CD-R and CD-RW discs are more durable than vinyl records, you should still take care to handle and store discs correctly. When you're not using a disc, return it to its case and store upright. Avoid leaving discs in excessively cold, humid, or hot environments (including under direct sunlight).

When labeling discs, use a felt-tip pen sold for marking CDs. Don't glue paper or put stickers onto the disc, or use a pencil, ball-point pen or other sharp-tipped writing instrument. These could all damage the disc.

For more detailed care information see the instructions that come with discs.

Discs to avoid

CDs spin at high speed inside the recorder during playback and recording. If you can see that a disc is cracked, chipped, warped, or otherwise damaged, don't risk using it in your CD recorder—you could end up damaging the unit.

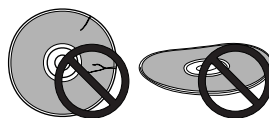

This recorder is designed for use with conventional, fully circular CDs only. Use of shaped CDs is not recommended for this product. Pioneer disclaims all liability arising in connection with the use of shaped CDs.

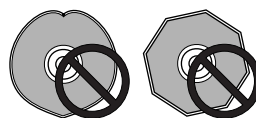

Recording CDs

This recorder is designed to let you make extremely high quality digital recordings onto recordable compact discs. For flexibility, you can use either rewritable discs (CD-RW) or write-once discs (CD-R). For more general information on the discs you can and can't use with this recorder, see *About CD, CD-R and CD-RW Discs* on page 7. The overview on these pages gives you an idea of what's possible, and also provides guidance on what to avoid and things to be careful of when recording.

Digital and analog sources

This recorder has both an optical and a coaxial digital input, as well as a pair of analog inputs. Use a digital input when:

- recording from a CD/MD/DAT/DCC player or digital satellite with a digital output.

Use the analog inputs when:

- recording from a digital component that does not have a digital output (such as some portable equipment).
- recording from an incompatible digital source (such as a high sampling-rate DAT tape).
- recording a digital copy-protected source (see below).
- recording from any analog source (radio broadcasts, vinyl records, cassette tapes, etc.).

9 Additional Information

Digital recording restrictions

This unit has been designed exclusively for recording and playback of audio discs — you can't record other CD formats, such as computer CD-ROMs or Dolby Digital (AC-3). If you record from a disc format such as CD+Graphics, Video CD, or other format that includes both digital audio and video or text, you will only be able to record the audio part of the disc.

In addition to standard audio CDs, this recorder will record DTS encoded audio CDs and HDCD format CDs. However, the recording level must be set to 0dB.

Almost all commercial digital source material is protected by copyright laws. For this reason, this recorder uses special consumer-use blank CD-R and CD-RW discs on which a copyright fee has already been paid. A further restriction is SCMS (Serial Copy Management System). This generally allows just one generation of digital recording. In other words, you can make a digital recording from an original source (such as a commercial CD), but you can't then make further digital recordings from that copy. Most digital recording equipment uses the SCMS system, including CD-R and MD recorders, and DAT decks. You may also find that you can't record certain DVD discs as the digital output of the DVD player can be disabled by the disc.

If you do encounter SCMS or other digital-copy restrictions, you can always record through the analog inputs.

Digital recording from DAT

If you're recording a DAT tape that was recorded using the DAT machine's auto ID function, the IDs on the tape are slightly after the beginning of the actual recording. This can cause problems for the CD recorder:

- The start of the track may not be recorded.
- The track number will be recorded on the disc after the start of the track
- The beginning of the next track on the DAT is unintentionally recorded

To avoid these problems, we recommend recording start IDs on the DAT manually, if possible. Refer to the instructions for your DAT recorder for more information.

You might also encounter problems if you try to synchro-record all tracks from a DAT that is set to program play. If you want to record a DAT in program play mode, use the 1-track synchro recording mode — see page 33 for how to do this.

Digital signal interruptions

Sources of signal interruption include power or source component failure, accidental disconnection of the interconnect cord, and interruption of digital satellite broadcasts. In all these cases, if the signal resumes within about five seconds, the result will just be a blank section on the disc. If the interruption is longer than five seconds, the recorder displays the error message: **Can't rec** and recording is paused.

Power interruptions

Never switch off this recorder while it's copying, recording, finalizing, or while the display shows **PMA REC** (Program Memory Area Recording). If there's a power failure, or you accidentally disconnect the power from the wall outlet while recording is in process, you'll lose at least part of the recording. When power is restored, the recorder attempt to record the PMA. After recording, always remove the disc from the recorder before switching the power off. Failure to do this could result in you losing some of the recorded material on the disc.

Miscellaneous information

- The minimum recordable time is four seconds. Even if you try and record something shorter than this, the track that the recorder creates will be four seconds.
- The maximum number of tracks on a disc is 99.

9 Additional Information

Understanding display messages

Below is a list of messages you'll see during normal operation with a brief explanation of what they mean. If you need more information, turn to the page indicated.

Message	Description	Page
OPEN	The disc tray is open.	
CLOSE	The disc tray is closing.	
NEW DISC	A blank disc is loaded.	
NO DISC	An attempt is made to start playback without a disc loaded.	
SET UP	The unit is setting up for recording. Wait for the message to disappear.	
TOC READ	The recorder is reading the disc's TOC (Table of Contents). Wait for the message to disappear.	
SYNC-1	The unit is in 1-track synchro recording mode. Recording starts when the recorder detects a source input signal.	p.32-33
SYNC-ALL	The unit is in all-track synchro recording mode. Recording starts when the recorder detects a source input signal.	p.32-33
MONITOR	The recorder is monitoring the input selected with the INPUT button.	p.31
CD (MD, DAT, DVD, DCC)	The recorder displays the source it is monitoring (CD, MD, DAT DVD, or DCC) during record setup.	p.31-33
PMA REC	The recorder is writing TOC data to the disc's PMA (Program Memory Area). Never turn off the power while this display is showing.	
SKIP SET ?	Confirm that you want to set a skip ID by pressing the SKIP SET button.	p.23
SKIP CLR ?	Confirm that you want to clear a skip ID by pressing the SKIP CLEAR button.	p.24
ERASE TOC ?	Confirm that you want to erase the TOC of a finalized CD-RW disc to return it to a non-finalized state. After doing this, you can record more material on the disc.	p.22
ERASE ALL ?	Confirm that you want to erase all tracks recorded on a CD-RW disc by pressing ▶/■ .	p.21-22
ALL / DISC / ERASE ?	Confirm that you want to re-initialize the CD-RW disc by pressing ▶/■ .	p.22
ERASE LAST ?	Confirm that you want to delete the last track on a CD-RW disc by pressing ▶/■ .	p.21
OPTICAL (COAXIAL, ANALOG)	The recorder shows the current input mode—digital or analog. Switch using the INPUT button.	p.31-34

Error messages

Below is a list of error messages you may see during playback or recording, with possible causes and remedies. If you need more information, turn to the page indicated.

Message	Cause	Remedy	Page
CHECK DISC	The disc is damaged or dirty. The disc is loaded upside down.	Take out the disc and check for dust, dirt, scratches, etc. Clean as necessary. Take out the disc and reload it label-side up. If the same message is displayed again after the disc is reloaded, unplug the power cord and plug it in again. If the message is still displayed, please contact a Pioneer authorized service center.	p.36
CHECK (blinking display)	A system error occurred, perhaps due to noise or static electricity.	Unplug the power cord and plug it in again. If the same message is displayed again, please contact a Pioneer authorized service center.	
RESUME	Power to the unit was interrupted during recording. When power is restored, this message appears.	The recorder is trying to repair the disc. Wait until the message disappears.	
E1	The disc was not loaded properly.	Open the disc tray and reload the disc. Make sure that it is seated properly in the disc guide.	
E2	The disc mechanism is not working properly.	Open the disc tray and make sure that nothing is obstructing it. If the problem persists, contact a Pioneer authorized service center.	

9 Additional Information

Messages relating to recording

Message	Cause	Remedy	Page
Can't COPY	The input signal is digital-copy protected with SCMS.	Record the source through the analog inputs.	p.33–34
Can't REC	The digital source was interrupted. The source is not audio, or is an incompatible format (e.g. a CD-ROM).	Check that the digital input cable is connected properly and that the power of the source player is on. Check that the source is a regular music source.	p.9
Can't SYNC	The digital source is not recognized as CD, MD, DVD, DAT, or DCC.	If recording from a source other than CD, MD, DVD, DAT or DCC, try using the manual digital recording mode.	p.34
CHECK INPUT (CD) ?	The source player was already playing when the SYNCHRO button was pressed.	Stop the source player. After a short time, SYNC-1 or SYNC-ALL is displayed, and the recorder goes into synchro-record-pause mode.	p.33–34
REPAIR	The recorder was switched off/unplugged after recording without ejecting the disc. The recorder could not write essential recording information onto the disc.	While REPAIR is displayed, the recorder automatically examines the recorded area of the disc and updates the track numbers and recording time data. This process takes about 40 minutes for a fully recorded disc. Finalization or further recording is possible once the REPAIR message disappears.	
REC FULL	No more recording is possible because the available recording time of the disc has been used up, or 99 tracks have already been recorded on the disc.	Use another disc, or erase the CD-RW disc.	
Pro DISC	The loaded disc is a CD-R or CD-RW disc for professional use without the Consumer Use designation.	Load a CD-R or CD-RW disc that is designated as being for consumer use.	p.7

Digital synchro recording troubleshooting

If digital synchro-recording fails to operate correctly, check the following:

1 Pause playback of the source, then press the digital synchro button again.

If you're recording from a portable CD player, etc., make sure that the shock-protection feature is switched off.

2 Start playback of the source component once you see the SYNCHRO indicator start to blink.

3 If none of the above solves the problem, use manual digital recording to record.

- Digital synchro-recording uses a digital sub-signal contained in the source player's digital output. Some CD/MD/DAT/DVD players are not compatible with synchro recording.

Troubleshooting

Power does not come on

- Check that the unit is plugged into a standard AC power outlet.
- If the unit is connected to another component's power output, check that the other component is switched on.

No sound when playing a disc

- Check that all connections to the amplifier are correct and that all interconnects are firmly connected.

Can't record

- Check that all connections to the amplifier and any other components are correct and that all interconnects are firmly connected.
- Check that the disc you're trying to record onto hasn't already been finalized. If it has, use another disc, or erase the TOC (CD-RW only) – page 22.
- Check that you've selected the correct input. Use the **INPUT** button to switch inputs.
- Check that the recording level is not set too low – pages 33–34.

Recorded sound is distorted

- Check that all connections to the amplifier and any other components are correct and that all interconnects are firmly connected.
- There may be interference from a nearby TV. Switch the TV off during recording, or move the unit further away.
- Check that the recording level is not set too high. Use the fixed/automatic level function if you're unsure – pages 32–33.
- Some analog sources output a very high level signal that may distort the recording. In this case, turn down the recording level – page 33.
- Check that the disc is not warped, damaged or dirty – page 36

Can't operate using the remote control

- Check that the batteries in the remote are not exhausted.
- Check that there are no obstacles between the remote and the remote sensor.
- Check that no bright lights (including sunlight) are shining onto the remote control sensor on the main unit.
- Check that you're operating the remote within its operating range – page 11.

Some tracks are skipped without being played

- The disc loaded contains skip IDs – pages 23–24.

A recorded CD-R disc won't play on other CD players

- Check that the disc has been finalized – page 20.
- Most ordinary CD players will not play CD-RW discs.

9 Additional Information

Specifications

1. General

Model	Compact disc audio system
Applicable discs	CDs, CD-Rs and CD-RWs
Power supply	AC 120 V, 60 Hz (U.S./Canadian models) AC 230 V, 50/60 Hz (U.K. model)
Power consumption	28 W (U.S./Canadian models) 26 W (U.K. model)
Operating temperature	+5 °C to +35 °C (+41 °F to +95 °F)
Weight (without package)	7.0 kg (15 lb, 7 oz)
Max. dimensions	420 (W) x 128 (H) x 385 (D) mm 16-9/16 (W) x 5-1/16 (H) x 15-3/16 (D) in.

2. Audio unit

Frequency characteristics	2 Hz to 20 kHz
Playback S/N	102 dB (EIAJ) (U.S./Canadian models) 105 dB (EIAJ) (U.K. model)
Playback dynamic range	95 dB (EIAJ) (U.S./Canadian models) 96 dB (EIAJ) (U.K. model)
Playback total harmonic distortion	0.0035 % (EIAJ) (U.S./Canadian models) 0.003 % (EIAJ) (U.K. model)
Playback channel separation	96 dB (EIAJ)
Recording S/N	90 dB (EIAJ)
Recording dynamic range	90 dB (EIAJ)
Recording total harmonic distortion	0.005 %
Output voltage	2.0 V
Wow-flutter	Less than measurement limit (±0.001 % W.PEAK) (EIAJ))
Number of channels	2 channels (stereo)
Coaxial output	0.5 V _{pp} ±20 % (75 Ω)
Optical output	-15 to -21 dBm (wavelength: 660 nm)
	Frequency deflection: Level 2 (standard mode)

*Recording specification values are for the LINE input (analog)

3. Input jacks

Optical digital input jack
Coaxial digital input jack
Audio LINE input jacks
Control IN jack

4. Output jacks

Optical digital output jack
Coaxial digital output jack
Audio LINE output jack

5. Accessories

Remote control unit	1
Size AA/R6P dry cell batteries	2
Stereo audio cord	2
AC power cord	1
Operating instructions	1
Warranty card	1

NOTE:

The specifications and design of this product are subject to change without notice, due to improvements.

Published by Pioneer Corporation.
Copyright © 1999 Pioneer Corporation.
All rights reserved.

PIONEER CORPORATION 4-1, Meguro 1-Chome, Meguro-ku, Tokyo 153-8654, Japan
PIONEER ELECTRONICS [USA] INC. P.O. BOX 1540, Long Beach, California 90801-1540, U.S.A.
PIONEER ELECTRONICS OF CANADA, INC. 300 Allstate Parkway, Markham, Ontario L3R OP2, Canada
PIONEER ELECTRONIC [EUROPE] N.V. Haven 1087, Keetberglaan 1, 9120 Melsele, Belgium
TEL: 03/570.05.11
PIONEER ELECTRONICS AUSTRALIA PTY. LTD. 178-184 Boundary Road, Braeside, Victoria 3195, Australia,
TEL: [03] 9586-6300
PIONEER ELECTRONICS DE MEXICO S.A. DE C.V. ... San Lorenzo Num 1009 3er piso Desp. 302 Col. Del Valle,
Mexico D.F. C.P. 03100 TEL: 5-688-52-90