

INSTALLATION INSTRUCTIONS

WARNINGS AND CAUTIONS:

- To be installed and/or used in accordance with appropriate electrical codes and regulations.
- If you are unsure about any part of these instructions, consult a qualified electrician.
- Vizia™ electronic switches are not compatible with standard 3-way or 4-way switches. They must be used with compatible Vizia™ on/off remotes.
- Recommended minimum wall box depth is 2-1/2".

WARNINGS AND CAUTIONS:

- Use only one (1) Vizia™ electronic switch in a multi-location circuit with up to 9 coordinating remotes without LEDs or up to 4 matching remotes with LEDs.
- Maximum wire length from dimmer to all installed remotes cannot exceed 300 ft (90 m).
- Disconnect power at circuit breaker or fuse when servicing, installing or removing fixture.
- Use this device only with copper or copper clad wire. With aluminum wire use only devices marked CO/ALR or CU/AL.

Tools needed to install your Switch:

Slotted/Phillips Screwdriver Electrical Tape Pliers
Pencil Cutters Ruler

Changing the color of your Switch:

Your switch includes three color options. The switch ships with the White frame attached. To change color of frame, proceed as follows:

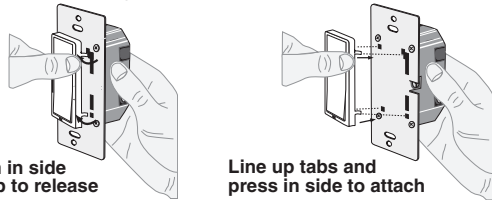

IMPORTANT : For 3-Way applications, note that one of the screw terminals from the old switch being removed will usually be a different color (Black) or labeled Common. Tag that wire with electrical tape and identify as the common (Line or Load) in both the switch wall box and remote wall box.

Step 3 Preparing and connecting wires:

This switch can be wired using side wire terminal screws or through backwire openings. Choose appropriate wire stripping specifications accordingly.

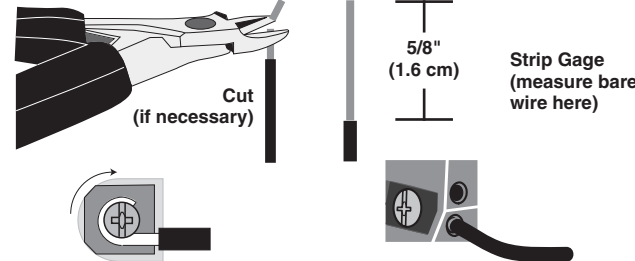

Side Wire Connection

Side wire terminals accept #14 AWG solid wire copper only.

Back Wire (either hole may be used)

Back wire openings use #14-12 AWG solid wire copper only.

- Make sure that the ends of the wires from the wall box are **straight (cut if necessary)**.
- Remove insulation from each wire in the wall box as shown.
- For **Single-Pole Application**, go to Step 4a.
- For **3-Way Coordinating Remote (no LEDs) Application**, go to Step 4b.
- For **3-Way Matching Remote (with LEDs) Application**, go to Step 4c.

Step 4a Single Pole Wiring Application:

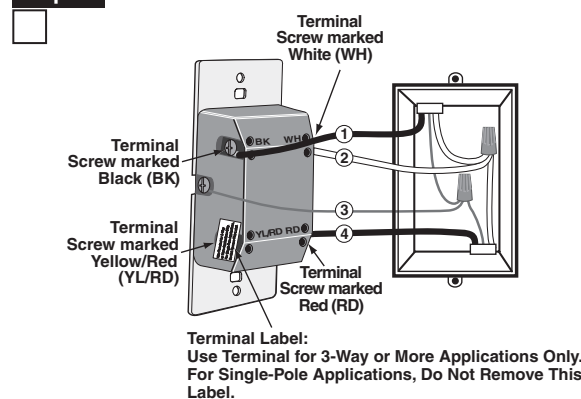

Step 4a cont'd

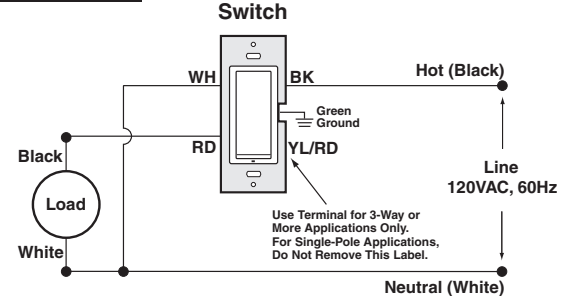

WIRING SWITCH:

Connect wires per **WIRING DIAGRAM** as follows:

- Green or bare copper wire in wall box to Green terminal screw.
- Line Hot wall box wire to terminal screw marked "BK".
- Load wall box wire to terminal screw marked "RD".
- Line Neutral wall box wire to terminal screw marked "WH".
- Switch terminal screw marked "YL/RD" should have Red insulating label affixed.
- NOTE:** If insulating label is not affixed to terminal screw marked "YL/RD", use electrical tape to cover.
- Proceed to Step 5.**

Step 4b 3-Way Wiring with Coordinating Remote (no LED) Application:

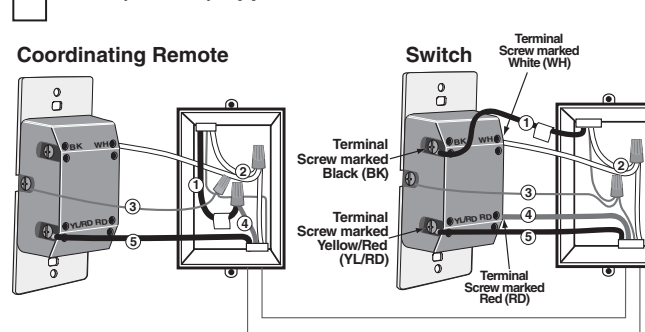

Step 4b cont'd

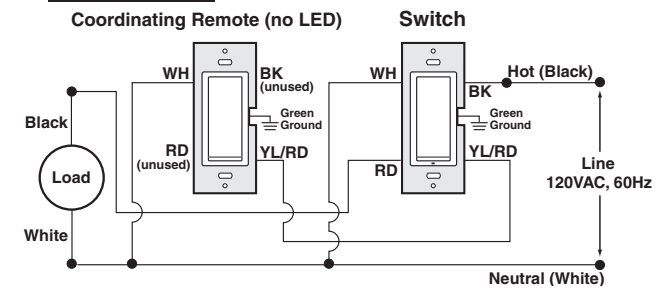

WIRING SWITCH:

Connect wires per **WIRING DIAGRAM** as follows:

- NOTE:** The switch must be installed in a wall box that has a Line Hot connection.
- NOTE:** Maximum wire length from switch to all installed remotes cannot exceed 300 ft (90 m).
- Green or bare copper wire in wall box to Green terminal screw.
- Line Hot (common) wall box wire identified (tagged) when removing old switch to terminal screw marked "BK".
- First Traveler wall box wire to terminal screw marked "RD" (**note wire color**).
- Remove Red insulating label from terminal screw marked "YL/RD".
- Second Traveler wall box wire to terminal screw marked "YL/RD" (**note wire color**). This traveler from the switch must go to the terminal screw on the remote marked "YL/RD".
- Line Neutral wall box wire to terminal screw marked "WH".

WIRING COORDINATING REMOTE:

Connect wires per **WIRING DIAGRAM** as follows:

- NOTE:** "BK" and "RD" terminals on coordinating remote are unused. Tighten both screws.
- NOTE:** Maximum wire length from switch to last remote is 300 ft (90 m).
- Green or bare copper wire in wall box to Green terminal screw.
- Load wall box wire identified (tagged) when removing old switch to First Traveler (**note color as above**).
- Second Traveler wall box wire (**note color as above**) to terminal screw marked "YL/RD". This traveler from the remote must go to the terminal screw on the switch marked "YL/RD".
- Remove White insulating label from terminal screw marked "WH".
- Line Neutral wall box wire to terminal screw marked "WH".
- Proceed to Step 5.**

INSTALLING YOUR SWITCH

NOTE: Use check boxes when Steps are completed.

Step 1 WARNING: TO AVOID FIRE SHOCK OR DEATH; TURN OFF POWER at circuit breaker or fuse and test that power is off before wiring!

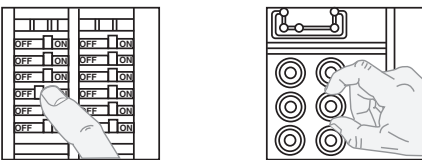

Step 2 Identifying your wiring application (most common):

NOTE: If the wiring in your wall box does not resemble any of these configurations, consult a qualified electrician.

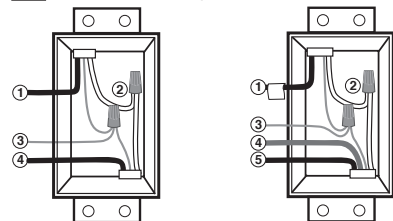

Single Pole

- Line (Hot)
- Neutral
- Ground
- Load

3-Way

- Line or Load (see important instruction below)
- Neutral
- Ground
- First Traveler – note color
- Second Traveler – note color. **NOTE:** For matching remote w/LEDs installation, the **First Traveler** becomes Line Hot.

Step 4c 3-Way Wiring with Matching Remote (w/LED) Application:

Matching Remote

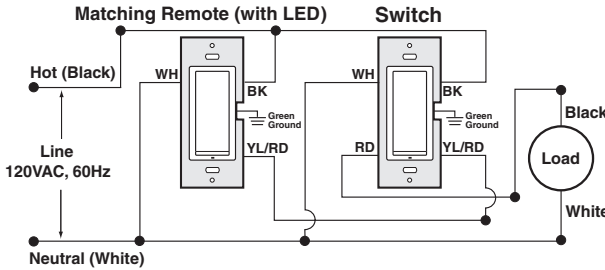
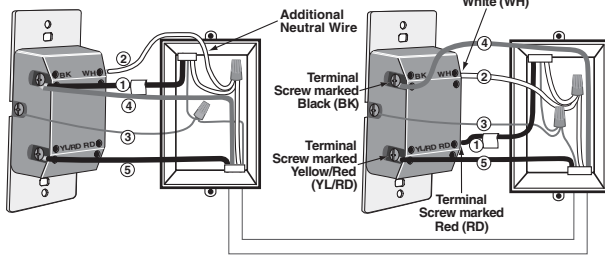

NOTE: The switch **must** be installed in a wall box that has a Load connection. The matching remote **must** be installed in a wall box with a Line Hot connection and a Neutral connection. A Neutral wire to the matching remote needs to be added as shown.

If you are unsure about any part of these instructions, consult a qualified electrician.

NOTE: Maximum wire length from dimmer to all installed remotes cannot exceed 300 ft (90 m).

WIRING MATCHING REMOTE (wall box with Line Hot connection):

- Connect wires per WIRING DIAGRAM as follows:**
- Green or bare copper wire in wall box to Green terminal screw.
 - Line Hot (common) wall box wire identified (tagged) when removing old switch and First Traveler to switch terminal screw marked "BK".
 - Second Traveler wall box wire from switch to remote terminal screw marked "YL/RD" (**note wire color**). This traveler from the remote must go to the terminal screw on the switch marked "YL/RD".
 - Line Neutral wall box wire to remote terminal screw marked "WH".

WIRING SWITCH (wall box with Load connection):

- Connect wires per WIRING DIAGRAM as follows:**
- Green or bare copper wire in wall box to Green terminal screw.
 - Load wall box wire identified (tagged) when removing old switch to terminal screw marked "RD".
 - First Traveler Line Hot to terminal screw marked "BK".
 - Remove Red insulating label from terminal screw marked "YL/RD".
 - Second Traveler wall box wire (**note color as above**) to terminal screw marked "YL/RD". This traveler from the switch must go to the terminal screw on the remote marked "YL/RD".
 - Line Neutral wall box wire to remote terminal screw marked "WH".
- Proceed to Step 5.**

Step 5 Testing your Switch prior to mounting in wall box:

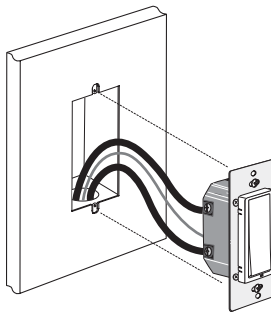

NOTE: Dress wires with a bend as shown in diagram in order to relieve stress when mounting device.

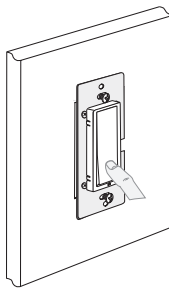

- Position all wires to provide room in outlet wall box for device.
- Ensure that the word "TOP" is facing up on device strap.
- Partially screw in mounting screws in wall box mounting holes.

- Restore power at circuit breaker or fuse.
 - Press pad until locator light is OFF. Lights should turn ON.
- If lights do not turn ON, refer to the TROUBLESHOOTING section.**

Step 6 Switch Mounting: TURN OFF POWER AT CIRCUIT BREAKER OR FUSE.

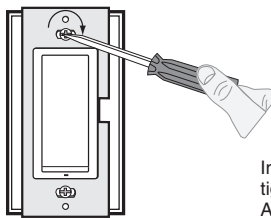

Installation may now be completed by tightening mounting screws into wall box. Attach wallplate.

Step 7 Restore Power: Restore power at circuit breaker or fuse. Installation is complete.

OPERATION

NOTE: The locator light will illuminate when the load is in the OFF position to facilitate access in the dark.

Push Pad (Default settings)

Turn ON from OFF position:
Tap – Lights turn ON.

Turn OFF from ON position:
Tap – Lights turn OFF.

If there is a power outage, when the power is restored, the lights will return to the last setting before the power interruption.

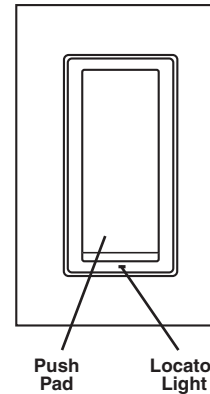

Cleaning: Clean with a damp cloth. **DO NOT** use chemical cleaners.

TROUBLESHOOTING

- **Lights Flickering**
 - Lamp has a bad connection.
 - Wires not secured firmly under terminal screws of switch and/or remote.
- **Light does not turn ON and Locator LED does not turn ON**
 - Circuit breaker or fuse has tripped.
 - Lamp is burned out.
 - Lamp Neutral connection is not wired.
- **Remote does not operate lights**
 - Ensure that total wire length does not exceed 300 ft (90 m).

For additional information, contact Leviton's Techline at 1-800-824-3005 or visit Leviton's website at www.leviton.com

U.S. & Foreign Patents Pending
Copyright© 2006 Leviton Manufacturing Co., Inc.
All Rights Including Trade Dress Rights Reserved

FCC COMPLIANCE STATEMENT

This equipment has been tested and found to comply with the limits for a Class B Digital Device, pursuant to Part 15 of the FCC Rules. These limits are designed to provide reasonable protection against harmful interference in a residential installation. This equipment generates, uses, and can radiate radio frequency energy and, if not installed and used in accordance with the instructions, may cause harmful interference to radio communications. However, there is no guarantee that interference will not occur in a particular installation. If this equipment does cause harmful interference to radio or television reception, which can be determined by turning the equipment OFF and ON, the user is encouraged to try to correct the interference by one or more of the following measures:

- Reorient or relocate the receiving Antenna.
- Increase the separation between the equipment and the receiver.
- Connect the equipment into an outlet on a circuit different from that to which the receiver is connected.
- Consult the dealer or an experienced radio/tv technician for help.

LIMITED 5 YEAR WARRANTY AND EXCLUSIONS

Leviton warrants to the original consumer purchaser and not for the benefit of anyone else that this product at the time of its sale by Leviton is free of defects in materials and workmanship under normal and proper use for five years from the purchase date. Leviton's only obligation is to correct such defects by repair or replacement, at its option, if within such five year period the product is returned prepaid, with proof of purchase date, and a description of the problem to **Leviton Manufacturing Co., Inc., Att: Quality Assurance Department, 59-25 Little Neck Parkway, Little Neck, New York 11362-2591**. This warranty excludes and there is disclaimed liability for labor for removal of this product or reinstallation. This warranty is void if this product is installed improperly or in an improper environment, overloaded, misused, opened, abused, or altered in any manner, or is not used under normal operating conditions or not in accordance with any labels or instructions. **There are no other or implied warranties of any kind, including merchantability and fitness for a particular purpose**, but if any implied warranty is required by the applicable jurisdiction, the duration of any such implied warranty, including merchantability and fitness for a particular purpose, is limited to five years. **Leviton is not liable for incidental, indirect, special, or consequential damages, including without limitation, damage to, or loss of use of, any equipment, lost sales or profits or delay or failure to perform this warranty obligation.** The remedies provided herein are the exclusive remedies under this warranty, whether based on contract, tort or otherwise.