

SHARP®

OPERATION MANUAL



MODEL
XG-NV5XE

LCD PROJECTOR

Notevision
SLIM & COMPACT LCD PROJECTOR



This equipment complies with the requirements of Directives 89/336/EEC and 73/23/EEC as amended by 93/68/EEC.

Dieses Gerät entspricht den Anforderungen der EG-Richtlinien 89/336/EWG und 73/23/EWG mit Änderung 93/68/EWG.

Ce matériel répond aux exigences contenues dans les directives 89/336/CEE et 73/23/CEE modifiées par la directive 93/68/CEE.

Dit apparaat voldoet aan de eisen van de richtlijnen 89/336/EEG en 73/23/EEG, gewijzigd door 93/68/EEG.

Dette udstyr overholder kravene i direktiv nr. 89/336/EEC og 73/23/EEC med tillæg nr. 93/68/EEC.

Quest' apparecchio è conforme ai requisiti delle direttive 89/336/EEC e 73/23/EEC, come emendata dalla direttiva 93/68/EEC.

Η εγκατάσταση αυτή ανταποκρίνεται στις απαιτήσεις των οδηγιών της Ευρωπαϊκής Ένωσης 89/336/ΕΟΚ και 73/23/ΕΟΚ, όπως οι κανονισμοί αυτοί συμπληρώθηκαν από την οδηγία 93/68/ΕΟΚ.

Este equipamento obedece às exigências das directivas 89/336/CEE e 73/23/CEE, na sua versão corrigida pela directiva 93/68/CEE.



Este aparato satisface las exigencias de las Directivas 89/336/CEE y 73/23/CEE, modificadas por medio de la 93/68/CEE.

Denna utrustning uppfyller kraven enligt riktlinjerna 89/336/EEC och 73/23/EEC så som kompletteras av 93/68/EEC.

Dette produktet oppfyller betingelsene i direktivene 89/336/EEC og 73/23/EEC i endringen 93/68/EEC.

Tämä laite täyttää direktiivien 89/336/EEC ja 73/23/EEC vaatimukset, joita on muutettu direktiivillä 93/68/EEC.

SPECIAL NOTE FOR USERS IN THE U.K.

The mains lead of this product is fitted with a non-rewireable (moulded) plug incorporating a 13A fuse. Should the fuse need to be replaced, a BSI or ASTA approved BS 1362 fuse marked  or  and of the same rating as above, which is also indicated on the pin face of the plug, must be used.

Always refit the fuse cover after replacing the fuse. Never use the plug without the fuse cover fitted.

In the unlikely event of the socket outlet in your home not being compatible with the plug supplied, cut off the mains plug and fit an appropriate type.

DANGER:

The fuse from the cut-off plug should be removed and the cut-off plug destroyed immediately and disposed of in a safe manner.

Under no circumstances should the cut-off plug be inserted elsewhere into a 13A socket outlet, as a serious electric shock may occur.

To fit an appropriate plug to the mains lead, follow the instructions below:

IMPORTANT:

The wires in the mains lead are coloured in accordance with the following code:

Blue: Neutral

Brown: Live

As the colours of the wires in the mains lead of this product may not correspond with the coloured markings identifying the terminals in your plug, proceed as follows:

- The wire which is coloured blue must be connected to the plug terminal which is marked N or coloured black.
- The wire which is coloured brown must be connected to the plug terminal which is marked L or coloured red.

Ensure that neither the brown nor the blue wire is connected to the earth terminal in your three-pin plug.

Before replacing the plug cover make sure that:

- If the new fitted plug contains a fuse, its value is the same as that removed from the cut-off plug.
- The cord grip is clamped over the sheath of the mains lead, and not simply over the lead wires.

IF YOU HAVE ANY DOUBT, CONSULT A QUALIFIED ELECTRICIAN.

The supplied CD-ROM contains operation instructions in English, German, French, Swedish, Spanish, Italian, and Dutch. Carefully read through the operation instructions before operating the LCD projector.

Die mitgelieferte CD-ROM enthält Bedienungsanleitungen in Englisch, Deutsch, Französisch, Schwedisch, Spanisch, Italienisch und Niederländisch. Bitte lesen Sie die Bedienungsanleitung vor der Verwendung des LCD-Projektors sorgfältig durch.

Le CD-ROM fourni contient les instructions de fonctionnement en anglais, allemand, français, suédois, espagnol, italien et néerlandais. Veuillez lire attentivement ces instructions avant de faire fonctionner le projecteur LCD.

Den medföljande CD-ROM-skivan innehåller bruksanvisningar på engelska, tyska, franska, svenska, spanska, italienska och holländska. Läs noggrant igenom bruksanvisningen innan du börjar använda LCD-projektorn.

El CD-ROM suministrado contiene instrucciones de operación en inglés, alemán, francés, sueco, español, italiano y holandés. Lea cuidadosamente las instrucciones de operación antes de utilizar el proyector.

Il CD-ROM in dotazione contiene istruzioni per l'uso in inglese, tedesco, francese, svedese, spagnolo, italiano e olandese. Leggere attentamente le istruzioni per l'uso prima di usare il proiettore LCD.

De meegeleverde CD-ROM bevat handleidingen in het Engels, Duits, Frans, Zweeds, Spaans, Italiaans en in het Nederlands. Lees de handleiding zorgvuldig door voor u de LCD projector in gebruik neemt.

Before using the LCD projector, please read this operation manual carefully.

OPERATION MANUAL

ENGLISH

IMPORTANT

For your assistance in reporting the loss or theft of your Colour LCD Projector, please record the Serial Number located on the bottom of the projector and retain this information. Before recycling the packaging, please be sure that you have checked the contents of the carton thoroughly against the list of "Supplied Accessories" on page 7.

Model No.: XG-NV5XE

Serial No.:

WARNING:

Intense light source. Do not look into the beam or view it directly. Be especially careful that children do not look directly into the beam.

WARNING:

To reduce the risk of fire or electric shock, do not expose this appliance to liquids.

CAUTION:

To reduce the risk of electric shock, do not remove cabinet. No user-serviceable parts are inside. Refer servicing to qualified service personnel.

Contents

Important Information

Important Safeguards	3
Usage Guidelines	4
Outstanding Features	5
How to Access the PDF Operation Manuals (for Windows and Macintosh)	6
Supplied Accessories	7
Part Names	8
Remote Control/Mouse Receiver Positioning	10
Operating the Wireless Mouse from the "Power" Remote Control	11

Setup & Connections

Setting Up the Projector and Screen	12
Standard Setup (Front Projection)	12
Reversed Image Setup	12
Ceiling-mount Setup	13
Adjusting the Height of the Image	13
Height of Image	13
Using the Adjustment Foot	14
Digital Keystone Correction	14
Connecting the Projector	15
Connecting the Projector to a Computer	15
"Plug and Play" Function	17
Using the Remote Mouse Receiver and RS-232C Port	17

Operation

Basic Operations	18
Connect the Power Cord	18
Turn on the Main Power	18
Turn on the Lamp Power	18
Adjusting Focus	18
Adjusting Zoom	18
Selecting and Checking the Input Mode	19
Adjusting the Volume	19
Turning off the Power	19
Using the GUI (Graphical User Interface) Menu Screen	20
Using IrCOM for Wireless Presentations	22
Selecting the On-screen Display Language ...	23
Picture Adjustments	24
Audio Adjustments	24
Computer Image Adjustments	25
Auto Sync Adjustment	26
Auto Sync Display Function	26
Saving and Selecting Adjustment Settings ...	27
Mode Adjustment	27

Useful Features

Digital Image Magnification and Reduction ...	28
Freeze Function	28
Black Screen Function	29
On-screen Display Override Function	29
Fit to Screen Function	30
Checking the Input Signal and Lamp Usage Time	30
Setting a Background Image	31
Selecting a Startup Image	31
Reverse/Invert Image Function	32
Using the Presentation Tools	33
Checking the Adjustment Status	34
Automatic Power Shutoff Function	34

Maintenance & Troubleshooting

Air Filter Maintenance	35
Lamp/Maintenance Indicators	36
Using the Kensington Lock	37
Troubleshooting	37

Appendix

Transporting the Projector	38
Connection Pin Assignments	39
RS-232C Port Specifications	39
Input Signals (Recommended Timing)	41
Specifications	42
Dimensions	43
Guide to Effective Presentations	44
Glossary	48
Index	49





Important Safeguards

ATTENTION: Please read all of these instructions before you operate your LCD Projector for the first time. Save these instructions for future reference.

For your own protection and prolonged operation of your LCD Projector, be sure to read the following "Important Safeguards" carefully, before use.

This projector has been engineered and manufactured to ensure your personal safety. But IMPROPER USE CAN RESULT IN POTENTIAL ELECTRICAL SHOCK OR FIRE HAZARDS. In order not to defeat the safeguards incorporated into this LCD Projector, observe the following basic rules for its installation, use and servicing.

1. Unplug the LCD Projector from the wall outlet before cleaning.
2. Do not use liquid cleaners or aerosol cleaners. Use a damp cloth for cleaning.
3. Do not use attachments not recommended by the LCD Projector manufacturer, as they may cause hazards.
4. Do not use the LCD Projector near water; for example, near a bathtub, washbowl, kitchen sink, laundry tub, in a wet basement, near a swimming pool, etc. Never spill liquid into the projector.
5. Do not place the LCD Projector on an unstable cart, stand, or table. The LCD Projector may fall, which may cause serious injury to a child or an adult, and/or serious damage to the unit.
6. Wall or Ceiling Mounting—The product should be mounted to a wall or ceiling only as recommended by the manufacturer.
7. LCD Projector equipment and cart combinations should be moved with care. Quick stops, excessive force, and uneven surfaces may cause the equipment and cart combination to overturn.
8. Slots and openings in the cabinet back and bottom are provided for ventilation. To ensure reliable operation of the LCD Projector and to protect it from overheating, these openings must not be blocked or covered. The openings should never be covered with cloth or other material.
9. This LCD Projector should never be placed near or over a radiator or heating vent. The LCD Projector should not be placed in a built-in installation such as a bookcase unless proper ventilation is provided.
10. The LCD Projector should be operated only from the type of power source indicated on the back of the projector or in the specifications. If you are not sure of the type of power supplied to your home, consult your LCD Projector dealer or local power company.
11. Do not place the LCD Projector where the cord will be abused by persons walking on it.
12. Follow all warnings and instructions marked on the LCD Projector.
13. To prevent damage to the projector due to lightning and power-line surges, unplug the projector from the power outlet, when not in use.
14. Do not overload wall outlets and extension cords with too many products, because this can result in fire or electric shock.
15. Never push objects of any kind into the LCD Projector through the cabinet slots as they may touch high-voltage points or cause a short circuit. This could result in a fire or electric shock.
16. Do not attempt to service the LCD Projector yourself. Opening or removing covers may expose you to dangerous voltage or other hazards. Refer all servicing to qualified service personnel.
17. Unplug the LCD Projector equipment from the wall outlet and refer servicing to qualified service personnel under the following conditions:
 - a. When the power cord or plug is damaged or frayed.
 - b. If liquid has been spilled into the LCD Projector.
 - c. If the LCD Projector has been exposed to rain or water.
 - d. If the LCD Projector does not operate normally when you follow the operating instructions. Adjust only those controls that are covered by the operating instructions, as improper adjustment of other controls may cause damage and will often require extensive work by a qualified technician to restore the LCD Projector to normal operation.
 - e. If the LCD Projector has been dropped or the cabinet has been damaged.
 - f. When the LCD Projector exhibits a distinct change in performance—this indicates a need for service.
18. When replacement parts are required, be sure the service technician has used replacement parts specified by the manufacturer that have the same characteristics as the original parts. Unauthorised substitutions may result in fire, electric shock, or other hazards.





Usage Guidelines



LASER RADIATION DO NOT STARE INTO BEAM CLASS 2 LASER PRODUCT	RADIACION LASER NO MIRE AL RAYO PRODUCTO LASER CLASE 2
RAYONNEMENT LASER NE PAS REGARDER DANS LE FAISCEAU APPAREIL À LASER DE CLASSE 2	
LASERSTRAHLUNG NICHT IN DEN STRAHL DER LASERVORRICHTUNG DER KLASSE II BLICKEN	LASERSTRÄLAR TITTA INTE IN I LASERSTRÄLEN KLASS 2 LASER PRODUKT.
LASERSÄTEILYÄ ÄLÄKÄTSÖ SOURAAAN SÄTEESEEN LUOKAN 2 LASERTUOTE	LASEROVÉ ZIARENIE NEPOZERAJTE SA DO LÚČA LASEROVÝ VÝROBEK TRIEDY 2
LASEROVÉ ZÁŘENÍ NEHLED'TE DO PAPRSKU LASEROVÝ VÝROBEK TRIDY 2	

Cautions Concerning the Laser Pointer

The laser pointer on the "Power" remote control emits a laser beam from the laser pointer window. This is a Class II laser which may impair your sight if directed into the eyes. The two marks shown on the left are caution labels for the laser beam.

- Do not look into the laser pointer window or shine the laser beam on yourself or others. (The laser beam used in this product is harmless when directed onto the skin. However, be careful not to project the beam directly into the eyes.)
- Always use the laser pointer at temperatures between +5°C and +40°C.
- Use of controls or adjustments, or performance of procedures other than those specified herein may result in hazardous radiation exposure.

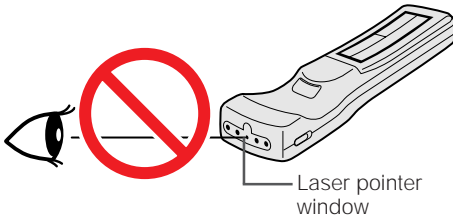
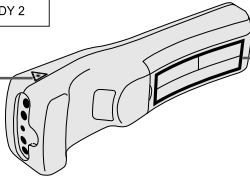

CAUTION

- This product contains a low power laser device. To ensure continued safety, do not remove any cover or attempt to gain access to the inside of the product. Refer all servicing to qualified personnel.

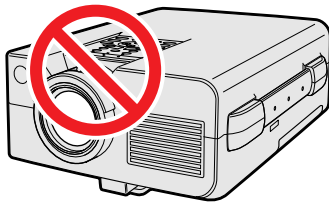
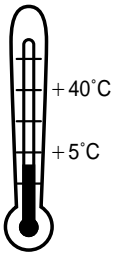

Cautions Concerning the Setup of the Projector

For minimal servicing and to maintain high image quality, SHARP recommends that this projector be installed in an area free from humidity, dust and cigarette smoke. If the projector is used in these environments, the lens and filter will need to be cleaned (or the filter replaced) more often, and internal cleaning may become necessary. As long as the projector is regularly cleaned, use in these environments will not reduce the overall operation life of the unit. Internal cleaning should only be performed by a Sharp Authorised LCD Projector Dealer or Service Centre.

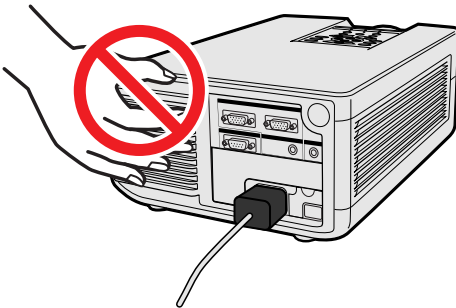

Notes on Operation

- The exhaust vent, the lamp cage cover and adjacent areas may be extremely hot during projector operation. To prevent injury, do not touch these areas until they have sufficiently cooled.
- Allow at least 10 cm of space between the cooling fan (exhaust vent) and the nearest wall or obstruction.
- If the cooling fan becomes obstructed, a protection device will automatically turn off the projector lamp. This does not indicate a malfunction. Remove the projector power cord from the wall outlet and wait at least 10 minutes. Then turn on the power by plugging the power cord back in. This will return the projector to the normal operating condition.

Temperature Monitor Function

If the projector starts to overheat due to setup problems or a dirty air filter, "TEMP." and  will flash in the lower-left corner of the picture. If the temperature continues to rise, the lamp will turn off, the TEMPERATURE WARNING indicator on the projector will flash, and after a 90-second cooling-off period the power will shut off. Refer to "Lamp/Maintenance Indicators" on page 36, for details.



NOTE

- The cooling fan regulates the internal temperature, and its performance is automatically controlled. The sound of the fan may change during projector operation due to changes in the fan speed.



Lamp Monitor Function

When the projector is turned on after the lamp has been used for 1,900 hours, "LAMP" and  will flash in the lower-left corner of the picture to advise you to replace the lamp. At this point, take the projector to your nearest Sharp Authorised LCD Projector Dealer or Service Centre to have the lamp replaced. If the lamp has been used for 2,000 hours, the projector power will automatically turn off and the projector will enter standby mode. Refer to "Lamp/Maintenance Indicators" on page 36, for details.



Outstanding Features

1. WIRELESS PRESENTATIONS WITH IrCOM

The IrCOM function allows for wireless transmission of digital images via infrared communication, from a PC, handheld PC or digital camera to the projector.

2. ADVANCED COMPATIBILITY WITH HIGH-END WORKSTATIONS AND PCS

Compatible with up to 100 Hz vertical refresh rate, Sync on Green and Composite Sync signals for use with a wide variety of high-end PCs and Workstations.

3. XGA RESOLUTION FOR HIGH RESOLUTION PRESENTATIONS

With XGA (1,024 × 768) resolution, this projector can display very detailed presentation information.

4. INTELLIGENT COMPRESSION AND EXPANSION

By using intelligent resizing technology, this projector can display higher and lower resolution images in detail without compromising quality.

5. UXGA COMPATIBLE

UXGA (1,600 × 1,200) resolution images are resized to 1,024 × 800. Since the resolution of the projector is 1,024 × 768, you can use the arrow keys (▲/▼) to scroll and view the entire image.

6. DIGITAL KEYSTONE CORRECTION

Digitally adjusts an image that is projected at an angle while maintaining image quality and brightness.

7. EASY-TO-USE GRAPHIC USER INTERFACE

A multi-colour, icon based menu system allows for simple image adjustments.

8. AUTO SYNC TECHNOLOGY FOR AUTOMATIC IMAGE PERFECTION

Automatically makes any necessary adjustments for perfectly synced computer images.

9. BUILT-IN PRESENTATION TOOLS

A variety of helpful presentation utilities are incorporated to enhance presentations. These include "Stamp" functions, "Break Timer", and "Digital Enlarge".

10. USER-FRIENDLY DESIGN

The two-colour design along with an intuitive User Interface makes this projector very easy to set up and adjust.

11. CUSTOMISABLE STARTUP SCREEN

Allows you to load a custom startup image (i.e. your company logo) to be displayed while the projector is warming up.



How to Access the PDF Operation Manuals (for Windows and Macintosh)



PDF operation manuals in all languages are included in the CD-ROM. To utilise these manuals, you need to install Adobe Acrobat Reader on your PC (Windows or Macintosh). If you have not installed Acrobat Reader yet, you can download it from the Internet (<http://www.adobe.com>) or install it from the CD-ROM.

To Install Acrobat Reader (English version) from the CD-ROM

For Windows:

- ① Insert the CD-ROM in the CD-ROM drive.
- ② Double click on the "My Computer" icon.
- ③ Double click on the "CD-ROM" drive.
- ④ Double click on the "manual" folder.
- ⑤ Double click on the "acrobat" folder.
- ⑥ Double click on the "windows" folder.
- ⑦ Double click on the installation programme and follow the instructions on the screen.

For Macintosh:

- ① Insert the CD-ROM in the CD-ROM drive.
- ② Double click on the "CD-ROM" icon.
- ③ Double click on the "manual" folder.
- ④ Double click on the "acrobat" folder.
- ⑤ Double click on the "mac" folder.
- ⑥ Double click on the installation programme and follow the instructions on the screen.

For other operating systems:

Please download Acrobat Reader from the Internet (<http://www.adobe.com>).

For other languages:

If you prefer using Acrobat Reader for other languages, please download the appropriate version from the Internet. (Please note that you do not have to have Acrobat Reader in your own language. You can read any pdf file using the English version of Acrobat Reader.)

Accessing the PDF Manuals

For Windows:

- ① Insert the CD-ROM in the CD-ROM drive.
- ② Double click on the "My Computer" icon.
- ③ Double click on the "CD-ROM" drive.
- ④ Double click on the "manual" folder.
- ⑤ Double click on the "xg-nv5xe" folder to access the projector manuals.
Double click on the "saps" folder to access the Sharp Advanced Presentation Software manual.
- ⑥ Double click on the language (name of the folder) that you want to view.
- ⑦ Double click on the pdf file.

For Macintosh:

- ① Insert the CD-ROM in the CD-ROM drive.
- ② Double click on the "CD-ROM" icon.
- ③ Double click on the "manual" folder.
- ④ Double click on the "xg-nv5xe" folder to access the projector manuals.
Double click on the "saps" folder to access the Sharp Advanced Presentation Software manual.
- ⑤ Double click on the language (name of the folder) that you want to view.
- ⑥ Double click on the pdf file.

NOTE

- If the desired pdf file cannot be opened by double clicking the mouse, please start Acrobat Reader first, then specify the desired file using the "File", "Open" menu.







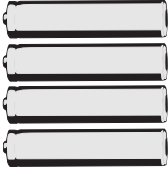

CD-ROM Structure

Root	First folder	Second folder/programmes	Third folder	PDF files
CD-ROM	manual	acrobat	mac	Acrobat Reader (English) installation programme
			windows	Acrobat Reader (English) installation programme
		xg-nv5xe	english	e_en.pdf
			german	e_g.pdf
			french	e_f.pdf
			swedish	e_sw.pdf
			spanish	e_sp.pdf
			italian	e_i.pdf
			dutch	e_d.pdf
			saps	english
		german		saps1g.pdf
		french		saps1f.pdf
		swedish		saps1sw.pdf
		spanish		saps1sp.pdf
		italian		saps1i.pdf
		dutch	saps1d.pdf	
	saps			SAPS installation programme
sharpir	win 98		IrDA installation programme for the Sharp "ACTIUS" PC using Windows 98	

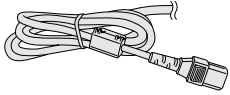
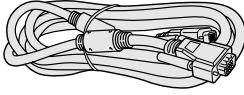
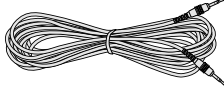
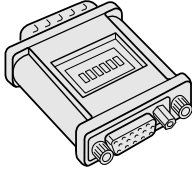
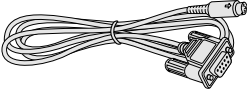

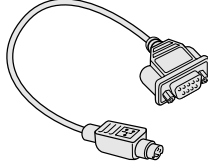
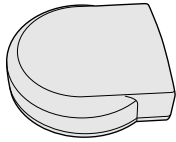
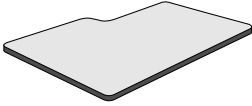
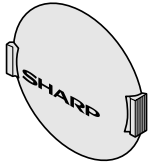
Supplied Accessories

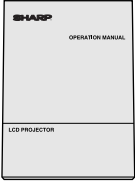
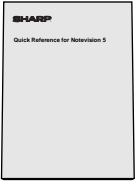

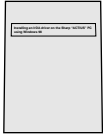
 <p>"Power" remote control RRMCG1471CESA</p>	 <p>Four AA size batteries UBATU0025GEZZ</p>	 <p>Simple presentation remote control RRMCG1480CESA</p>	 <p>Two AAA size batteries UBATU0026GEZZ</p>
 <p>Power cord</p>	 <p>Computer cable QCNW-5108CEZZ</p>	 <p>Computer audio cable QCNW-4870CEZZ</p>	 <p>Macintosh adaptor QPLGJ1512CEZZ</p>
 <p>Mouse control serial cable QCNW-5112CEZZ</p>	 <p>Mouse control cable for IBM PS/2 QCNW-5113CEZZ</p>	 <p>Mouse control cable for Mac QCNW-5114CEZZ</p>	 <p>Remote mouse receiver RUNTK0648CEN1</p>
 <p>Extra air filter PFILD0076CEZZ</p>	 <p>Lens cap GCOVH1307CESA</p>	 <p>Carrying bag GCASN0001CESA</p>	 <p>CD-ROM UDSKA0002CE01</p>
 <p>LCD projector operation manual TINS-6584CEZZ</p>	 <p>LCD projector quick reference TINS-6645CEZZ</p>	 <p>Sharp Advanced Presentation Software operation manual TINS-6725CEZZ</p>	 <p>Sharp Advanced Presentation Software quick reference TINS-6688CEZZ</p>
 <p>IrDA driver installation instruction sheet TCAUZ3039CEZZ</p>			



Part Names

Projector

Front View

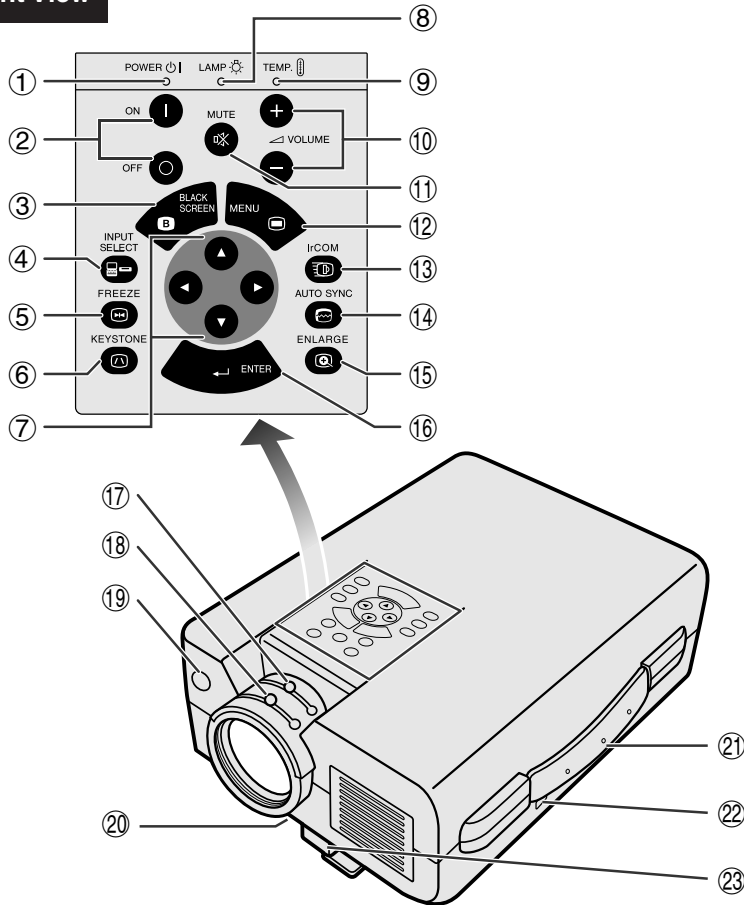

Side and Rear View

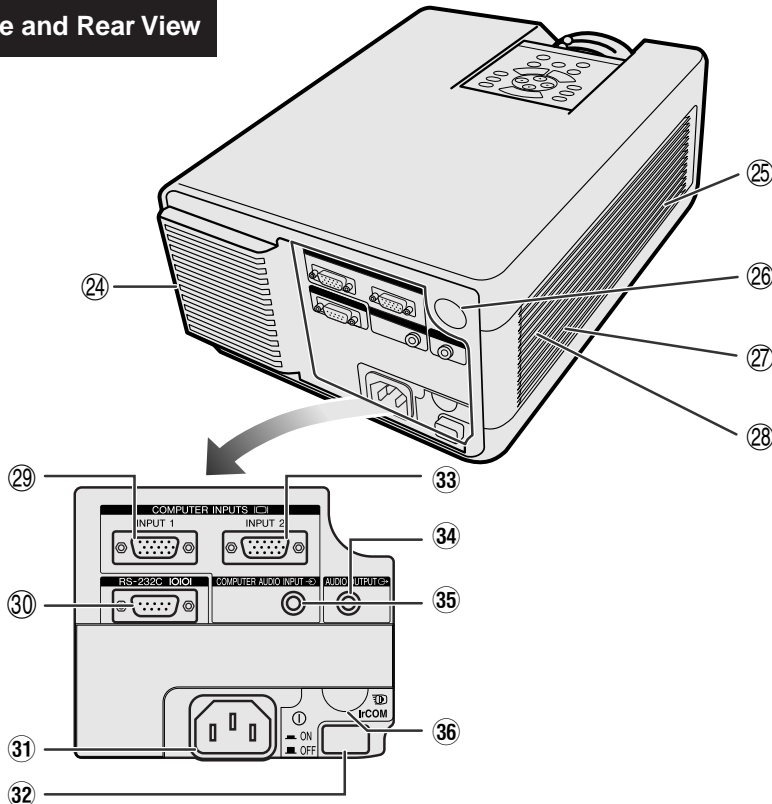

- ① POWER indicator [pp. 18, 19, 36]
- ② POWER buttons (ON/OFF) [pp. 18, 19, 36]
- ③ BLACK SCREEN button [p. 29]
- ④ INPUT SELECT button [pp. 19, 22, 25]
- ⑤ FREEZE button [p. 28]
- ⑥ KEYSTONE button [p. 14]
- ⑦ ADJUSTMENT buttons (▲/▼/◀/▶) [pp. 14, 20, 21, 23–34]
- ⑧ LAMP REPLACEMENT indicator [pp. 18, 19, 36]
- ⑨ TEMPERATURE WARNING indicator [pp. 4, 36]
- ⑩ VOLUME buttons (+/-) [p. 19]
- ⑪ MUTE button [p. 19]
- ⑫ MENU button [pp. 20, 23–27, 29–34]
- ⑬ IrCOM button [p. 22]
- ⑭ AUTO SYNC button [pp. 25, 26]
- ⑮ ENLARGE button [p. 28]
- ⑯ ENTER button [pp. 14, 20, 23–34]
- ⑰ Zoom knob [p. 18]
- ⑱ Focus knob [p. 18]
- ⑲ Remote control sensor [p. 10]
- ⑳ Air filter [p. 35]/Cooling fan (Intake vent)
- ㉑ Carrying handle [p. 38]
- ㉒ Kensington Security Standard connector [p. 37]
- ㉓ Foot release [p. 14]
- ㉔ Cooling fan (Exhaust vent)
- ㉕ Speaker
- ㉖ Remote control sensor [p. 10]
- ㉗ Cooling fan (Intake vent)
- ㉘ Air filter [p. 35]
- ㉙ COMPUTER INPUT 1 port (HD-15) [pp. 15, 16, 39]
- ㉚ RS-232C port (9-pin D-sub) [pp. 15, 17, 39, 40]
- ㉛ AC socket
- ㉜ MAIN POWER switch [pp. 18, 35]
- ㉝ COMPUTER INPUT 2 port (HD-15) [pp. 15, 16, 39]
- ㉞ AUDIO OUTPUT terminal (3.5 mm stereo minijack)
- ㉟ COMPUTER AUDIO INPUT terminal (3.5 mm stereo minijack) [p. 15]
- ㊱ IrCOM sensor [p. 22]





“Power” Remote Control

Front View

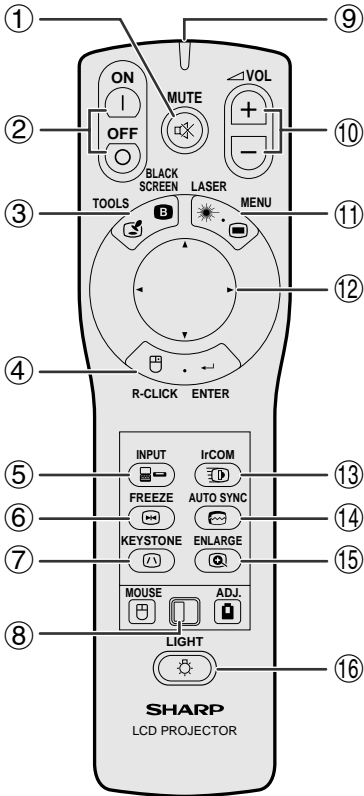

Side View

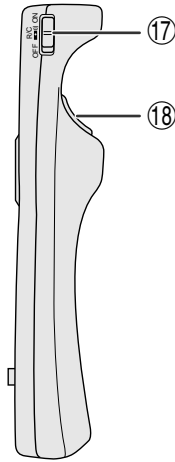

Top View

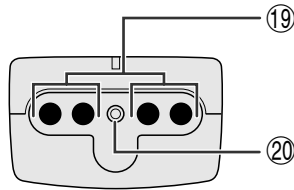

- ① MUTE button [p. 19]
- ② POWER buttons (ON/OFF) [pp. 18, 19, 36]
- ③ BLACK SCREEN/TOOLS button [pp. 29, 33]
- ④ RIGHT-CLICK/ENTER button [pp. 11, 14, 20, 23–34]
- ⑤ INPUT button [pp. 19, 22, 25]
- ⑥ FREEZE button [p. 28]
- ⑦ KEYSTONE button [p. 14]
- ⑧ MOUSE/ADJUSTMENT switch [pp. 11, 14, 20, 22–34]
- ⑨ TRANSMISSION indicator
- ⑩ VOLUME buttons (+/-) [p. 19]
- ⑪ LASER POINTER/MENU button [pp. 11, 20, 23–27, 29–32, 34]
- ⑫ MOUSE/ADJUSTMENT buttons (▲/▼/◀/▶) [pp. 14, 20, 21, 23–34]
- ⑬ IrCOM button [p. 22]
- ⑭ AUTO SYNC button [pp. 25, 26]
- ⑮ ENLARGE button [p. 28]
- ⑯ BACKLIGHT button [p. 11]
- ⑰ MAIN POWER switch [p. 11]
- ⑱ LEFT-CLICK (BACK) button [pp. 11, 14, 20, 28, 33]
- ⑲ Remote control signal transmitter
- ⑳ Laser pointer window [p. 4]
- ㉑ MOUSE button [p. 11]
- ㉒ RIGHT-CLICK button [p. 11]
- ㉓ LEFT-CLICK button [p. 11]

Simple Presentation Remote Control

Front View

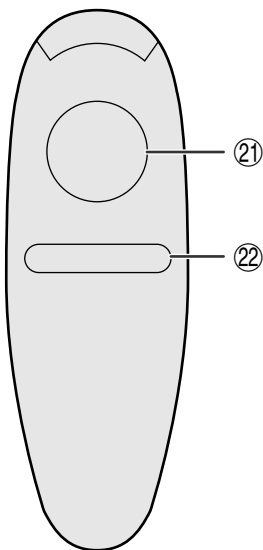

Side View

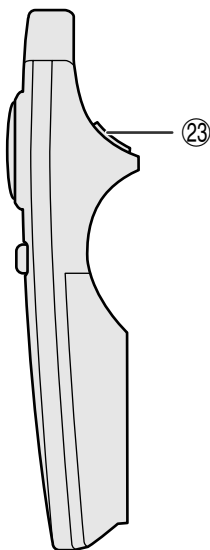

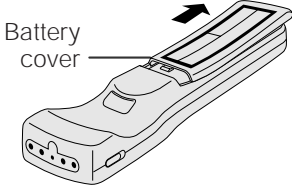
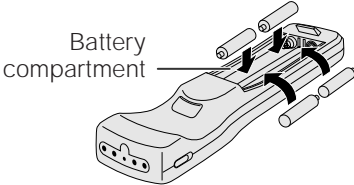
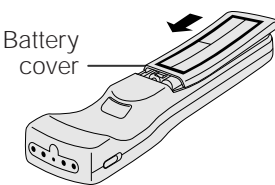
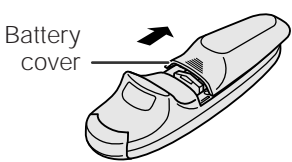
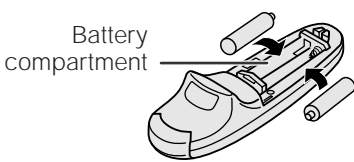
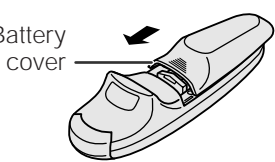

Inserting the batteries

<p>1 Press in and downward on the arrow to remove the battery cover.</p>	<p>2 Insert four AA size batteries for the "Power" remote control and two AAA size batteries for the simple presentation remote control making sure their polarities match the + and - marks inside the battery compartment.</p>	<p>3 Insert the side tabs of the battery cover into their slots and press the cover in until it is properly seated.</p>
 <p>Battery cover</p>	 <p>Battery compartment</p>	 <p>Battery cover</p>
 <p>Battery cover</p>	 <p>Battery compartment</p>	 <p>Battery cover</p>



Remote Control/Mouse Receiver Positioning

- The "Power" remote control can be used to control the projector within the ranges shown below.
- The remote mouse receiver can be used with the "Power" remote control or the simple presentation remote control to control the mouse functions of a connected computer within the ranges shown below. (See page 15 for details.)

NOTE

- The signal from the remote controls can be reflected off a screen for easy operation. However, the effective distance of the signal may differ due to the screen material.

Controlling the Projector

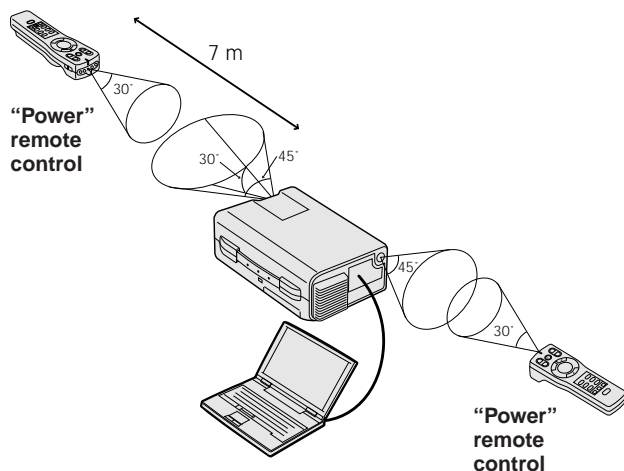

Using the Wireless Mouse

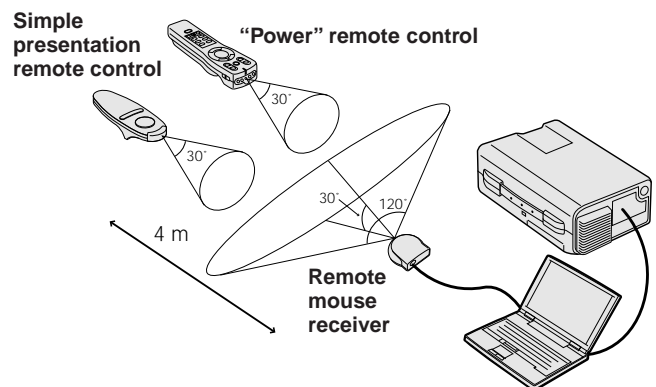



Operating the Wireless Mouse from the "Power" Remote Control

When operating the projector controls

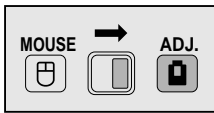

When operating the wireless mouse or using the laser pointer

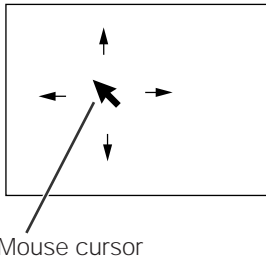
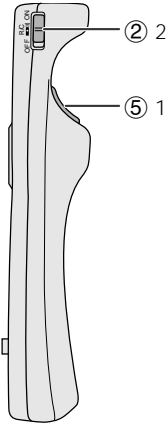
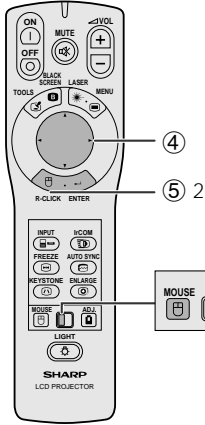
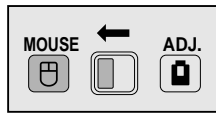

The "Power" remote control has the following three functions:

- Operation of projector controls
- Operation of wireless mouse
- Use of laser pointer

Slide the **MOUSE/ADJUSTMENT** switch to the **MOUSE** or **ADJ.** position for use of the function.

① **Connect the projector to a computer**

See pages 15 and 16 for details.

② **Wireless mouse operation**

1. After connecting the projector and the computer, turn the projector on first. The computer should always be turned on last.
2. Slide the **MAIN POWER** switch on the "Power" remote control to ON.

③ **Selecting the operation mode**

To use the "Power" remote control as a wireless mouse, slide the **MOUSE/ADJUSTMENT** switch to the **MOUSE** position.

NOTE

- To use the "Power" remote control to operate the projector, slide the **MOUSE/ADJUSTMENT** switch to the **ADJ.** position.
- The wireless mouse or RS-232C function may not operate if your computer serial port is not correctly set up. Please refer to the computer's operation manual for details on setting up/installing the correct mouse driver.

④ **Moving the mouse cursor**

Press **▲/▼/◀/▶** on the "Power" remote control to move the mouse cursor around the screen.

NOTE

- The supplied simple presentation remote control can also be used for wireless mouse operation.

⑤ **Using the mouse buttons for two-button mouse systems**

The wireless mouse is configured to be used as a standard two-button mouse (desktop mouse).

1. Use **LEFT-CLICK** on the back of the "Power" remote control as the "Left Click" of a standard desktop mouse.
2. Use **RIGHT-CLICK** on the front of the "Power" remote control as the "Right Click" of a standard desktop mouse.

NOTE

- For one-button mouse systems, use either the **LEFT-CLICK** or **RIGHT-CLICK** button.

Using the laser pointer

Slide the **MOUSE/ADJUSTMENT** switch to the **MOUSE** position, and then press **LASER POINTER** (★) to activate the laser pointer. When the button is released, the light automatically goes off.

NOTE

- For safety reasons, the laser pointer automatically goes off after 1 minute of continuous use. To turn it on again, press **LASER POINTER** (★) one more time.

Using the "Power" remote control in a dark room

The "Power" remote control has a backlight function. When **BACKLIGHT** is pressed, the remote buttons light up. Green light refers to mouse operations, and red light to projector adjustments.

NOTE

- If the **MAIN POWER** switch on the "Power" remote control is left on for more than 10 minutes without operation, the power will automatically turn off. To turn the power back on, press any button on the remote control for more than one second.

Button name	Position of MOUSE/ADJUSTMENT switch	
	MOUSE (M)	ADJ. (A)
LASER POINTER/MENU	LASER POINTER (GREEN)	MENU (RED)
BLACK SCREEN/TOOLS	BLACK SCREEN (GREEN)	TOOLS (RED)
RIGHT-CLICK/ENTER	RIGHT-CLICK (GREEN)	ENTER (RED)
MOUSE/ADJUSTMENT	MOUSE (NOT LIT)	ADJUSTMENT (NOT LIT)
LEFT-CLICK/BACK	LEFT-CLICK (NOT LIT)	BACK (NOT LIT)
POWER ON/OFF	ON (RED)	
VOLUME +/-		
MUTE		
INPUT		
IrCOM		
FREEZE		
AUTO SYNCHRONIZATION		
KEystone		
ENLARGE		

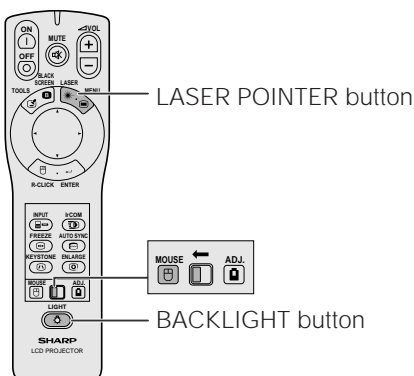



Setting Up the Projector and Screen

Position the projector perpendicular to the screen with all feet flat and level to achieve optimal image. Move the projector forward or backward if the edges of the image are distorted.

NOTE

- The projector lens should be centred in the middle of the screen. If the lens centre is not perpendicular to the screen, the image will be distorted, making viewing difficult.
- Position the screen so that it is not in direct sunlight or room light. Light falling directly onto the screen washes out colours, making viewing difficult. Close the curtains and dim the lights when setting up the screen in a sunny or bright room.
- A polarising screen cannot be used with this projector.

Standard Setup (Front Projection)

Place the projector at the required distance from the screen according to the desired picture size (see the table below).

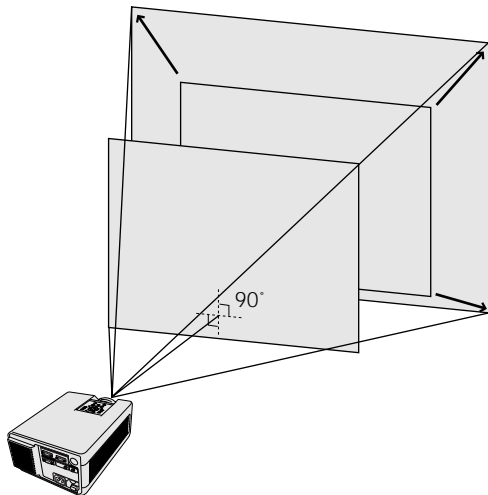

Picture size (diag.)	Projection distance	
	Maximum	Minimum
762 cm (300")	18.1 m	12.1 m
508 cm (200")	12.0 m	8.1 m
381 cm (150")	9.0 m	6.0 m
254 cm (100")	6.0 m	4.0 m
203 cm (80")	4.8 m	3.2 m
152 cm (60")	3.6 m	2.4 m
102 cm (40")	2.4 m	1.6 m

Reversed Image Setup

Rear projection

- Place a translucent screen between the projector and the audience.
- Use the projector's menu system to reverse the projected image. (See page 32 for use of this function.)

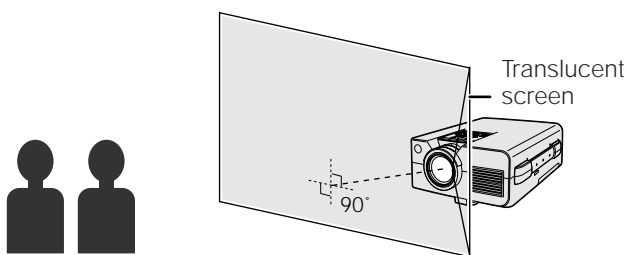

Projection using a mirror

- Place a mirror (normal flat type) in front of the lens.
- Use the projector's menu system to reverse the projected image. (See page 32 for use of this function.)
- The image reflected from the mirror is projected onto the screen.

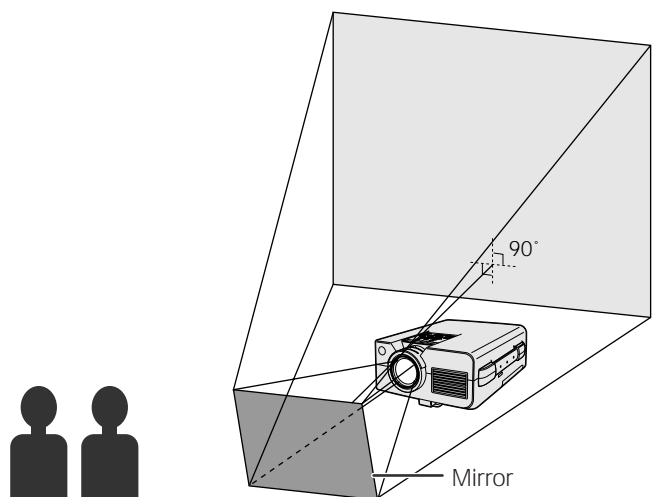

CAUTION

- When using a mirror, be sure to carefully position both the projector and the mirror so the light does not shine into the eyes of the audience.



Ceiling-mount Setup

- Use the optional Sharp ceiling-mount bracket for this installation.
- Before mounting the projector, contact your nearest Sharp Authorised LCD Projector Dealer or Service Centre to obtain the recommended ceiling-mount bracket (sold separately). (AN-NV4T ceiling-mount bracket, AN-TK201/AN-TK202 extension tube for AN-NV4T.)
- When the projector is in the inverted position, use the upper edge of the screen as the base line.
- Use the projector's menu system to select the appropriate projection mode. (See page 32 for use of this function.)

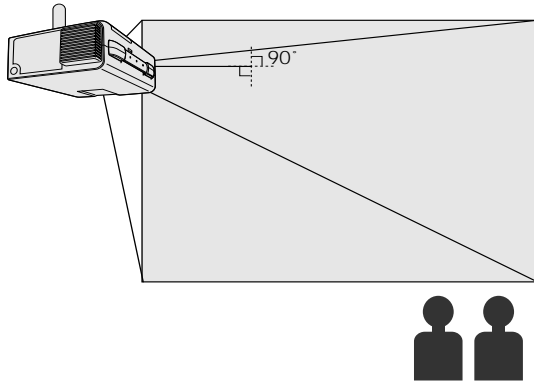

Adjusting the Height of the Image

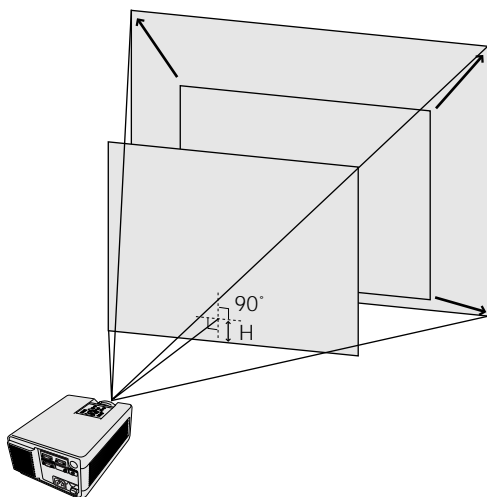

Height of Image

See the table below for exact distances from the lens centre to the bottom of the image.

Picture size (diag.)	Distance from the lens centre to the bottom of the image (H)
762 cm (300")	45.8 cm
508 cm (200")	30.5 cm
381 cm (150")	22.9 cm
254 cm (100")	15.3 cm
203 cm (80")	12.2 cm
152 cm (60")	9.2 cm
102 cm (40")	6.1 cm



Using the Adjustment Foot

You can adjust the height of the image by raising the projector with the foot release.

- 1 Press the foot release and lift the projector to the desired angle.
- 2 Remove your hand from the foot release. Once the adjustment foot has locked in position, release the projector.

Returning the projector to its original position

While holding the projector, press the foot release and slowly lower the projector to its original position.

NOTE

- The projector is adjustable up to approximately 5° from the standard position.
- When an adjustment is made, the image may become distorted (keystoned), depending on the relative positions of the projector and the screen.

CAUTION

- Do not press the foot release when the adjustment foot is extended without firmly holding the projector.
- Do not hold the lens when lifting or lowering the projector.
- When lowering the projector, be careful not to get your fingers caught in the area between the adjustment foot and the projector.

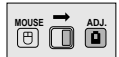

Digital Keystone Correction

When the image is distorted due to the projection angle, the Digital Keystone Correction function allows you to correct it.

(For use with the "Power" remote control, slide the **MOUSE/ADJUSTMENT** switch to the **ADJ.** position.)

- 1 Press **KEYSTONE**.
- 2 Press **▲** to compress the upper part of the image. Press **▼** to compress the lower part of the image.
- 3 Press **ENTER** to display a test pattern.
- 4 Press **ENTER** to clear the test pattern.
- 5 To exit, press **KEYSTONE**.
- 6 To reset, press **LEFT-CLICK**.

NOTE

- Straight lines or the edges of the displayed image may become jagged.

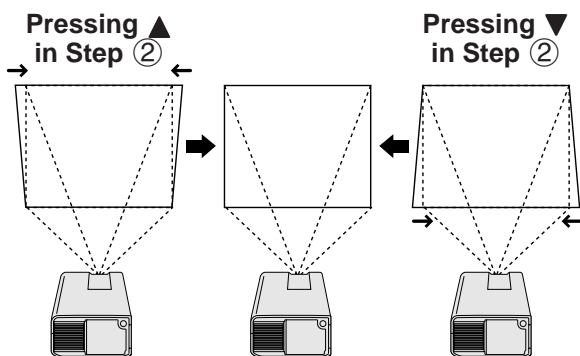
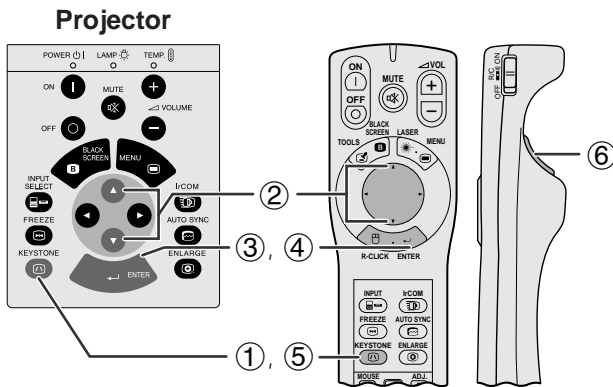

On-screen Display

3 Test Pattern

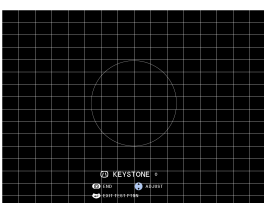

4





Connecting the Projector

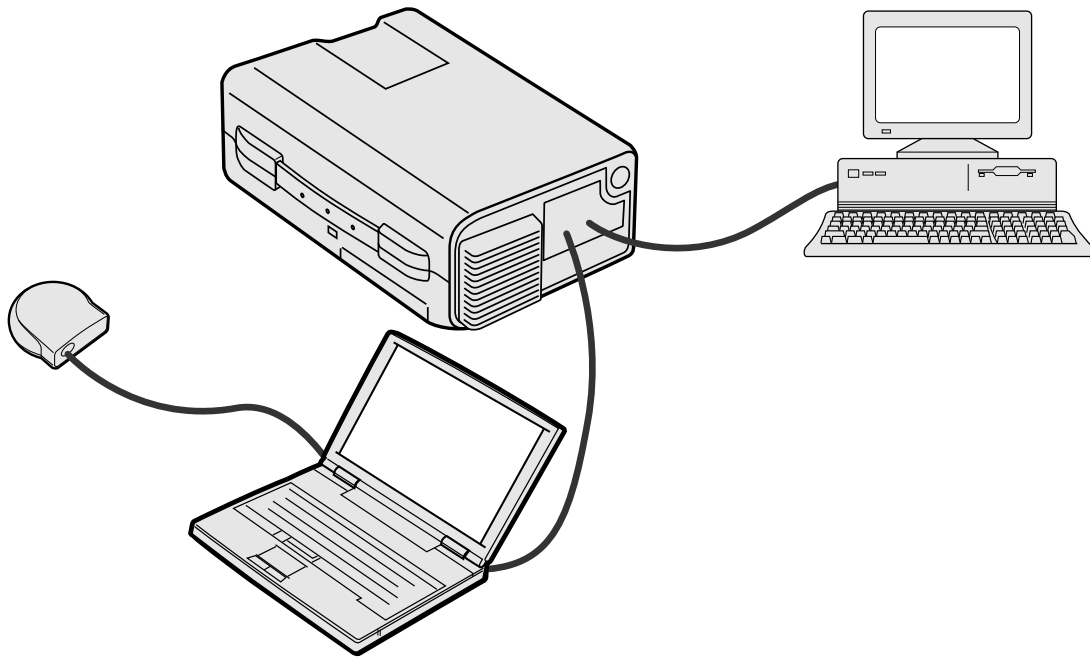

Connecting the Projector to a Computer

You can connect your projector to a computer for projection of full colour computer images. See the next page for details on the connections.

CAUTION

- Before connecting, be sure to turn both the projector and the computer off. After making all connections, turn the projector on first. The computer should always be turned on last.

NOTE

- Please read the computer's operation manual carefully.
- Refer to page 41 "Input Signals (Recommended Timing)" for a list of computer signals compatible with the projector. Use with computer signals other than those listed may cause some of the functions not to work.

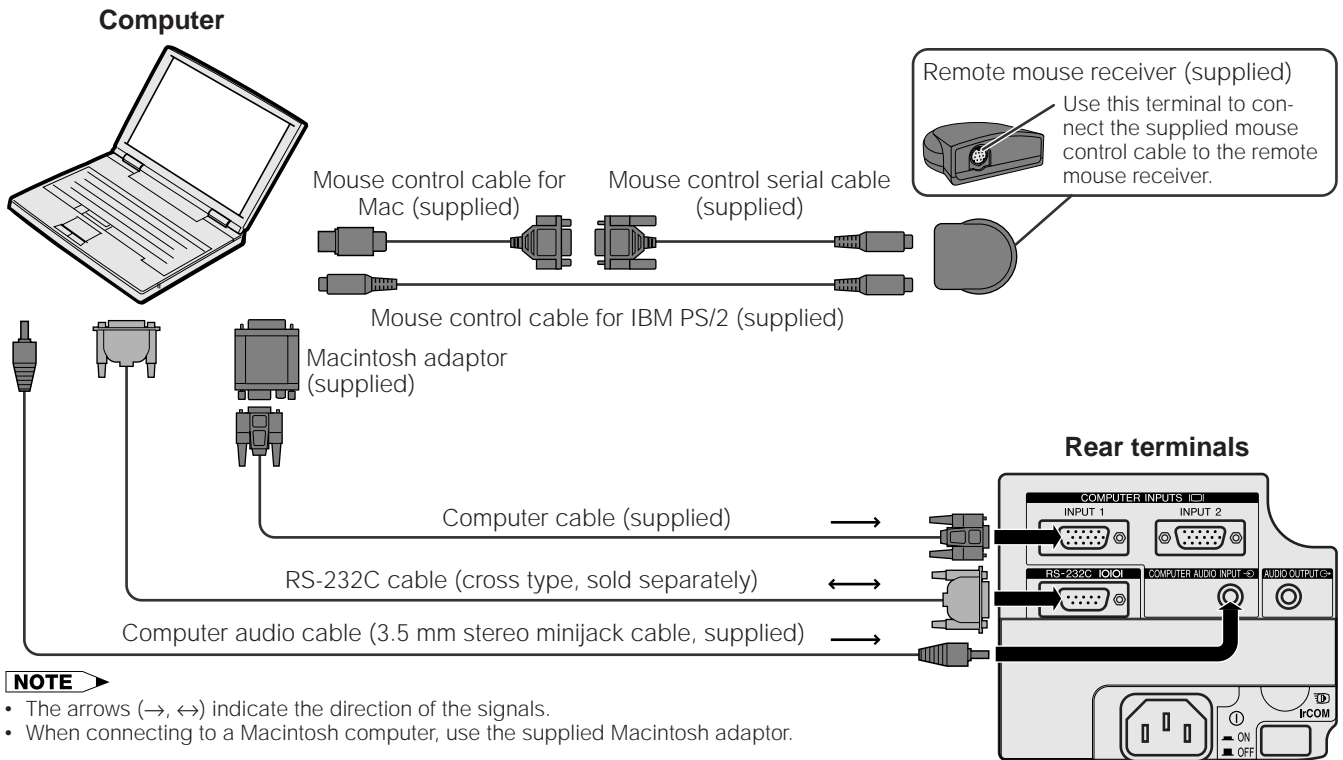



Connecting the Projector

Connect your projector to a computer for projection of full-colour computer images.

①

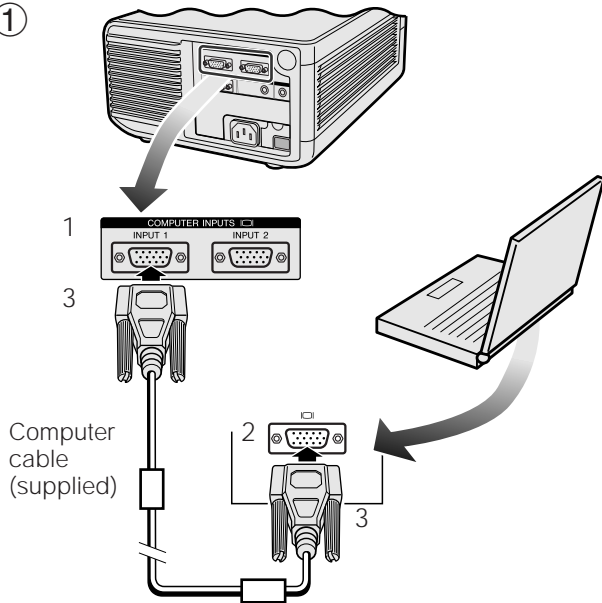

②

Macintosh adaptor (supplied)

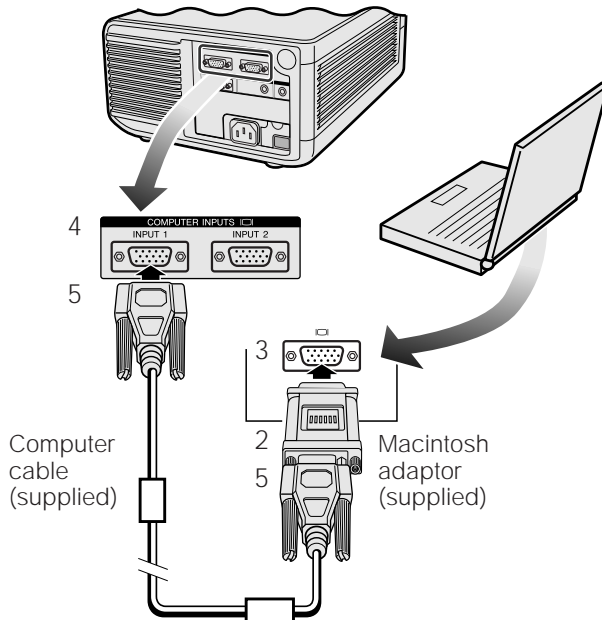
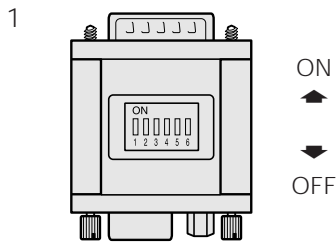

① Connecting an IBM-PC

1. Plug one end of the supplied computer cable into the COMPUTER INPUT port on the projector.
2. Plug the other end into the Monitor output port on the computer.
3. Secure the plugs by tightening the thumb screws.

② Connecting a Macintosh computer

1. Set the proper switches on the supplied Macintosh adaptor to the desired resolution. Some examples are as follows:
 - For 640 × 480 resolution, set switches 1 and 2 to "ON" and 3, 4, 5 and 6 to "OFF".
 - For 832 × 624 resolution, set switches 2 and 4 to "ON" and 1, 3, 5 and 6 to "OFF".
 - For 1,024 × 768 resolution, set switches 2 and 3 to "ON" and 1, 4, 5 and 6 to "OFF".
2. Connect the supplied Macintosh adaptor to the supplied computer cable.
3. Connect the other end of the Macintosh adaptor to the Monitor output port on your Macintosh computer.
4. Plug the other end of the supplied computer cable into the COMPUTER INPUT port on the projector.
5. Secure the plugs by tightening the thumb screws.

NOTE

- Once the adaptor is connected to a computer and the computer is turned on, the display mode cannot be changed even if the switches on the adaptor are reset.
- The supplied Macintosh adaptor is only for use with H-SYNC and V-SYNC output. When connecting a Macintosh computer that only outputs C-SYNC, use a C-SYNC output adaptor (sold separately).

③ Connecting other compatible computers

When connecting the projector to a compatible computer other than an IBM-PC (VGA/SVGA/XGA/SXGA/UXGA) or Macintosh (i.e. Workstation), a separate cable may be needed. Please contact your dealer for more information.

NOTE

- Connecting computers other than the recommended types may result in damage to the projector, the computer, or both.

④ Turning on the power of the projector and the computer

Once the connections are made, first turn on the projector (see page 18), then your computer.





“Plug and Play” Function

This projector is compatible with VESA-standard DDC 1/DDC 2B. The projector and a VESA DDC compatible computer will communicate their setting requirements, allowing for quick and easy setup.

NOTE

- The DDC, Plug and Play function of this projector operates only when used in conjunction with a VESA DDC compatible computer.

Using the Remote Mouse Receiver and RS-232C Port

- The remote mouse receiver can be used with the “Power” remote control or the simple presentation remote control to operate the computer’s mouse. Plug the supplied mouse control cable from the remote mouse receiver to the computer. (See page 16.)
- When the RS-232C port on the projector is connected to a computer with an RS-232C cable (cross type, sold separately), the computer can be used to control the projector and check the status of the projector. See pages 39 and 40 for details.

CAUTION

- Do not connect or remove the mouse control cables or RS-232C cable to or from the computer while it is on. This may damage your computer.

NOTE

- The wireless mouse functions can operate computers compatible with IBM PS/2, serial (RS-232C) or Apple ADB type mouse systems.
- The wireless mouse or RS-232C function may not operate if your computer port is not correctly set up. Please refer to the operation manual of the computer for details on setting up/installing the correct mouse driver.





Basic Operations

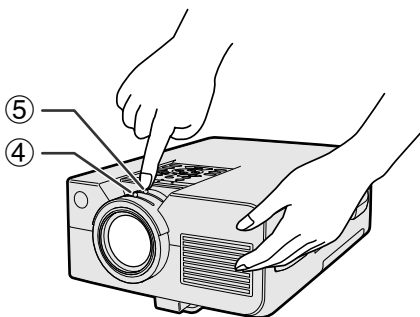
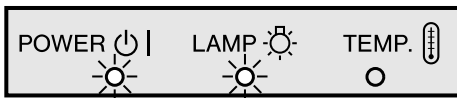
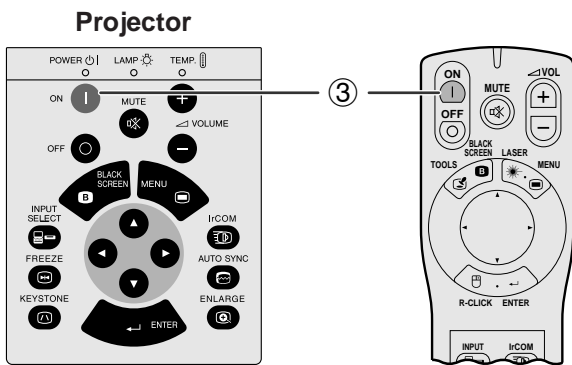
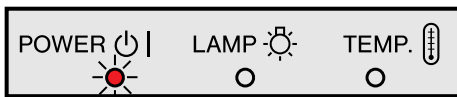
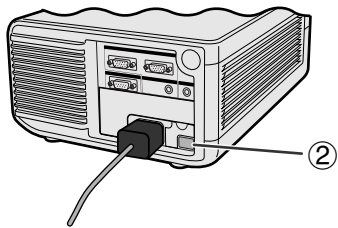
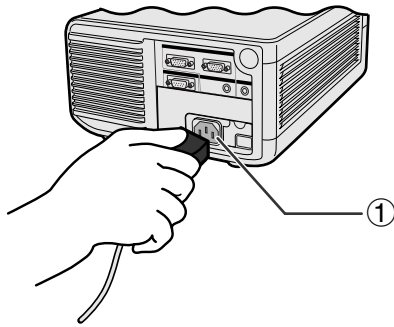

① Connect the Power Cord

Plug the supplied power cord into the AC socket on the back of the projector.

② Turn on the Main Power

Press the **MAIN POWER** switch on the back of the projector. The POWER indicator lights up red and the projector enters standby mode.

NOTE

- If the bottom filter cover is not securely installed, the POWER indicator flashes.
- When the main power is not on, the "Power" remote control cannot be used.

When the main power is on, the POWER indicator lights up red.

③ Turn on the Lamp Power

Press **POWER ON** on the projector or the "Power" remote control.

NOTE

- The flashing green LAMP REPLACEMENT indicator shows that the lamp is warming up. Wait until the indicator stops flashing before operating the projector.
- If the power is turned off and then immediately turned on again, it may take a short while before the lamp turns on.
- After the projector is unpacked and turned on for the first time, a slight odour may be emitted from the exhaust vent. This odour will soon disappear with use.

When the power is on, the LAMP REPLACEMENT indicator lights indicating the status of the lamp.

- Green:** Lamp is ready.
- Flashing green:** Warming up.
- Red:** Change the lamp.

④ Adjusting Focus

Slide the focus knob until the image on the screen becomes clear.

⑤ Adjusting Zoom

Slide the zoom knob. The image can be adjusted to the desired size within the zoom range.





Projector

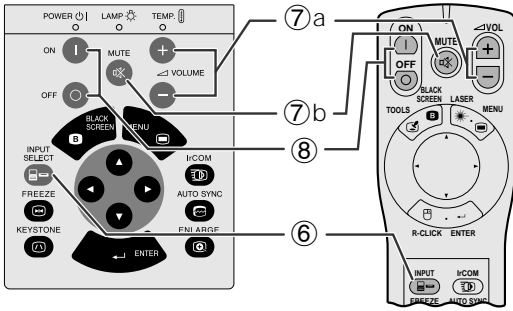

On-screen Display

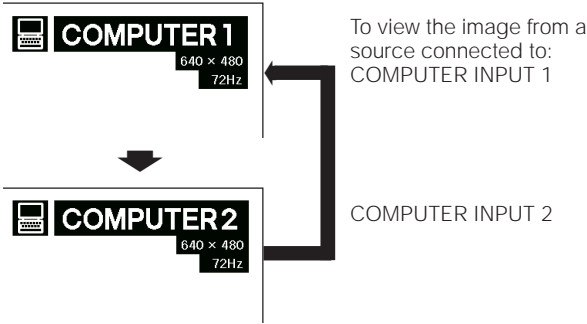

To view the image from a source connected to: **COMPUTER INPUT 1**

COMPUTER INPUT 2

7a

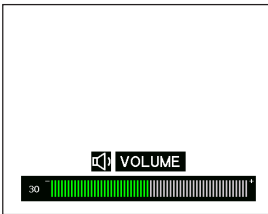

7b

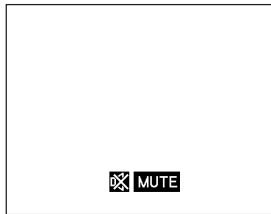

8

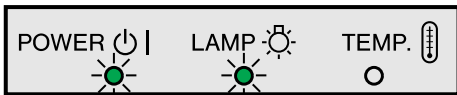
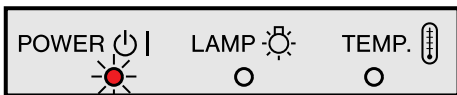
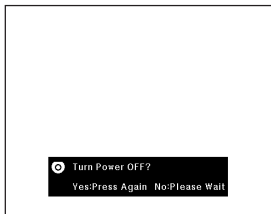

6 Selecting and Checking the Input Mode

Press **INPUT SELECT** on the projector or **INPUT** on the "Power" remote control to select the desired input mode. Press it again to change the mode as shown on the left.

NOTE

- When no signal is being received, "No Signal" will be displayed. When a signal that the projector is not preset to receive is being received, "Not Reg." will be displayed.

7 Adjusting the Volume

- Press **VOLUME +/VOLUME -** on the projector or the "Power" remote control to adjust the volume.
- Press **MUTE** on the projector or the "Power" remote control to temporarily turn off the sound. Press **MUTE** again to turn the sound back on.

8 Turning off the Power

- Press **POWER OFF** on the projector or the "Power" remote control. The screen on the left will appear.
- Press **POWER OFF** again while the screen is displayed.

NOTE

- If you accidentally pressed **POWER OFF** and do not want to turn off the power, wait until the power off screen shown on the left disappears.

When **POWER OFF** is pressed twice, the **POWER** indicator will light up red and the cooling fan will run for about 90 seconds. The projector will then enter standby mode.

The power can be turned on again by pressing **POWER ON** on the projector or the "Power" remote control. When the power is turned on, the **POWER** indicator and the **LAMP REPLACEMENT** indicator light green.

NOTE

- The **POWER** indicator flashes if the bottom filter cover is not securely installed.



Using the GUI (Graphical User Interface) Menu Screen

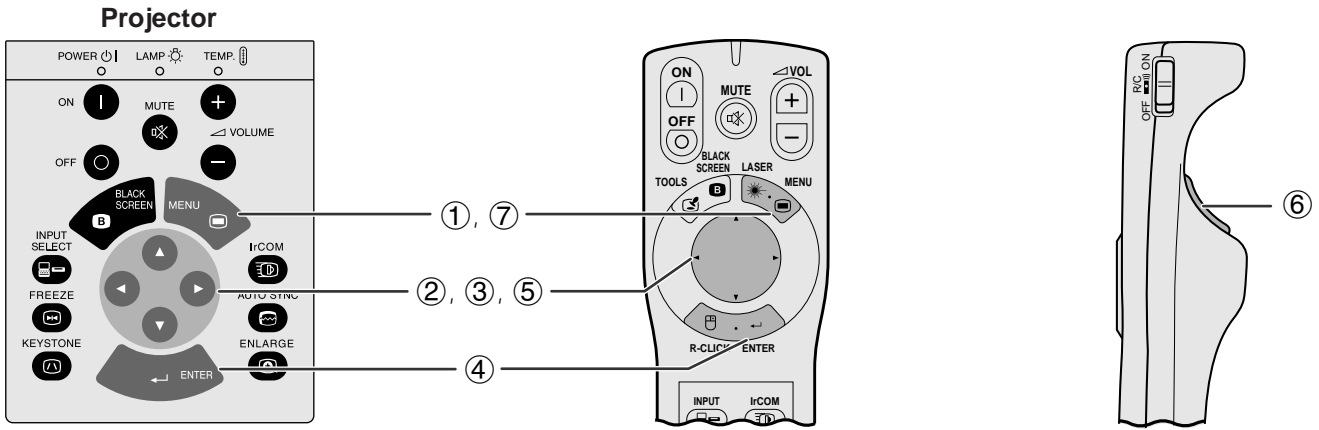
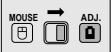

This projector has a menu screen that allows you to adjust the image and various projector settings. The menu screen can be operated from the projector or the "Power" remote control with the following buttons.

(GUI) On-screen Display

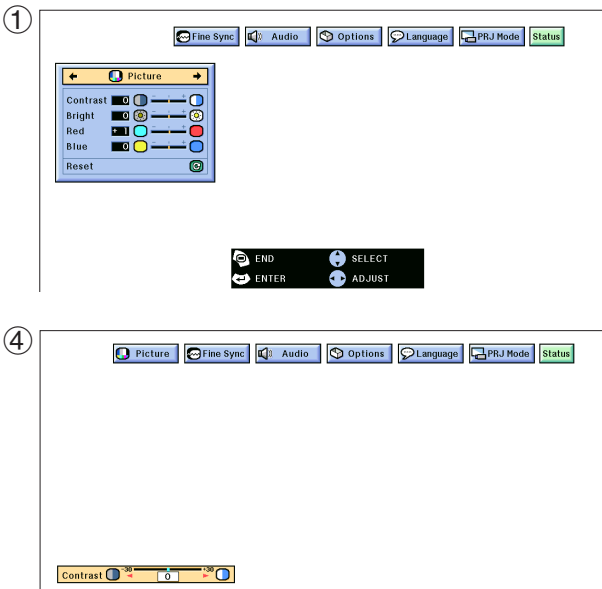

(For use with the "Power" remote control, slide the **MOUSE/ADJUSTMENT** switch to the ADJ. position.)

- ① Press **MENU** to display the menu bar.
- ② Press ◀/▶ to select an adjustment menu on the menu bar.
- ③ Press ▲/▼ to select a specific adjustment item.
- ④ To display only the adjustment item, press **ENTER** after selecting the item. Only the menu bar and the selected adjustment item will appear.
- ⑤ Press ◀/▶ to adjust the item.
- ⑥ Press **LEFT-CLICK** to return to the previous screen.
- ⑦ Press **MENU** to exit from the GUI.

NOTE

- For details on items on the menu screen, see the tree chart on the next page.





Items on the COMPUTER1 or COMPUTER2 Mode Menu Bar

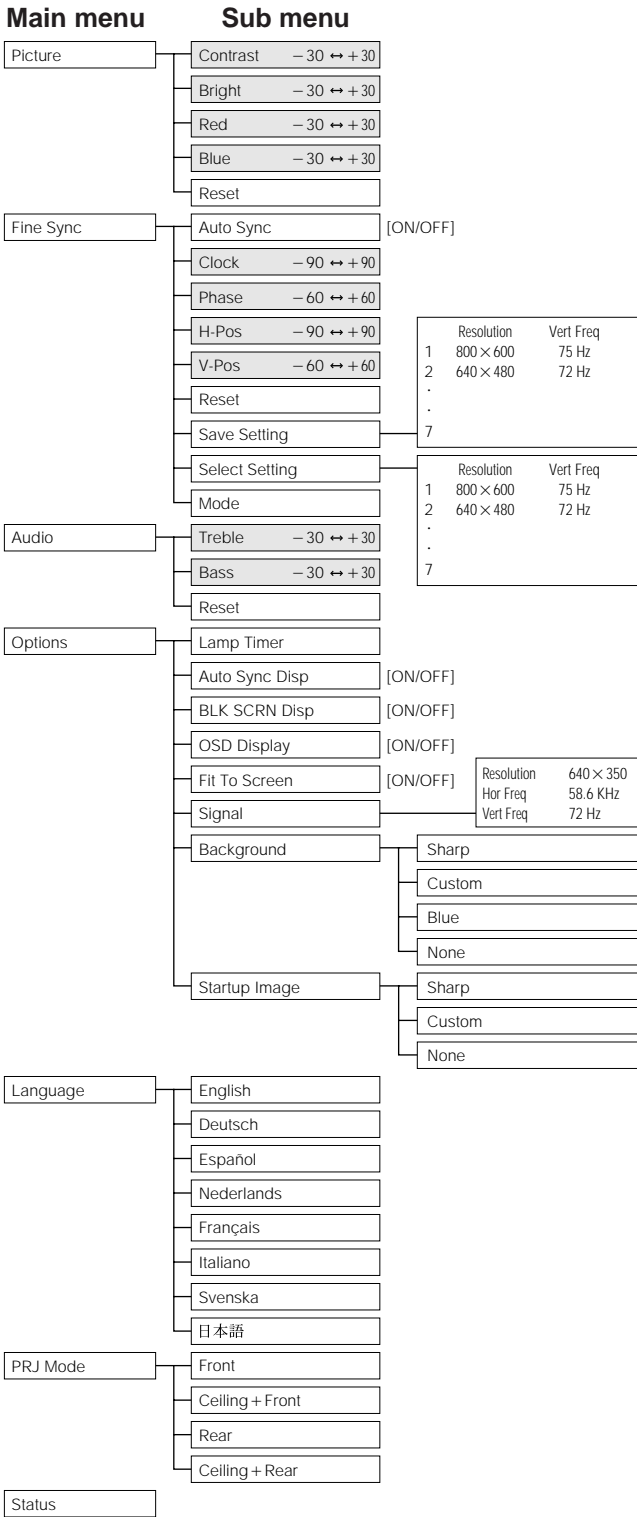

NOTE

- Only the items highlighted in the tree chart above can be adjusted.
- To adjust the items under the sub menu, press ► after entering the sub menu.



Using IrCOM for Wireless Presentations

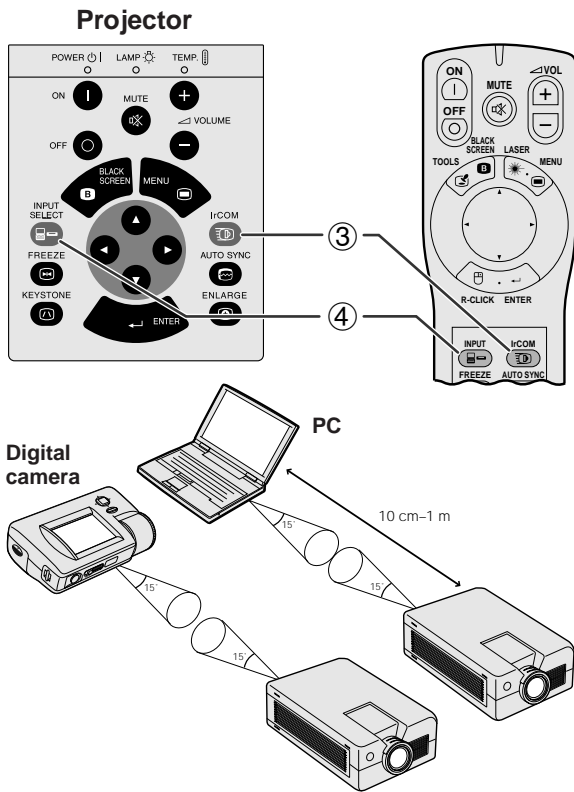
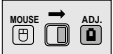

- The IrCOM function can be used to wirelessly transfer still images from a computer, handheld P/C or digital camera to the projector via infrared communication. This function is used with the supplied Sharp Advanced Presentation Software. See the operation manual of the software for installation and operating instructions.
- Position the projector and the IrCOM transmitting device within the range shown on the left.

NOTE

- To avoid transmission errors or changes in the image, ensure the following when setting up the projector and transmitting device.
 - The IrCOM sensors on both the projector and transmitting device are protected from direct sunlight or strong ambient light.
 - The transmitting device has sufficient battery power.
 - The projector and transmitting device are positioned within the designated operating range.
 - The IrCOM sensors on the projector and transmitting device are correctly aligned.

- ① Before setting up the projector and computer, install the Sharp Advanced Presentation Software in the supplied CD-ROM on the computer. See the operation manual of the software for installation details.

NOTE

- The distance between the projector and transmitting device may have to be less than 10 cm depending on the transmitting device.
- When using the digital still camera, set it to the image transmission mode and set the computer to the image reception mode.

- ② Align the projector and transmitting device at the same height and angle at a distance of 10 cm to 1 meter with an unobstructed line of view.
- ③ Press **IrCOM** on the projector or the "Power" remote control to enter the IrCOM mode. The On-screen Display changes as shown on the left.

NOTE

- To use the "Power" remote control to operate this function, slide the **MOUSE/ADJUSTMENT** switch to the ADJ. position before pressing **IrCOM**.
- If the On-screen Display does not change as shown on the left, the projector may not be within the reception range from the IrCOM transmitting device.

- ④ Press **INPUT SELECT** on the projector or **INPUT** on the "Power" remote control to exit the IrCOM mode.

NOTE

- If the projector is unable to receive images from the IrCOM transmitting device, the On-screen display on the left will appear.

IrCOM stand by



IrCOM stand by
Waiting for Data

Transmission Failed





Selecting the On-screen Display Language

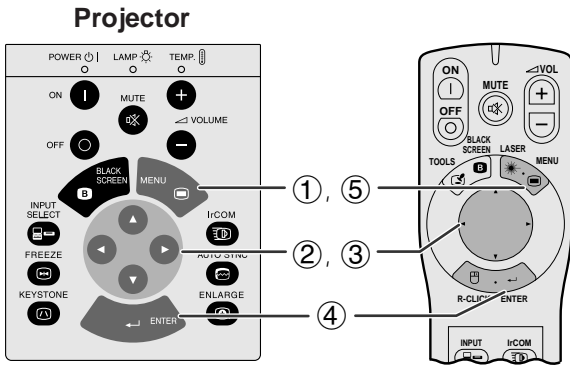
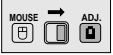

English is the preset language for the On-screen Display. It can be changed to English, German, Spanish, Dutch, French, Italian, Swedish or Japanese.

(For use with the "Power" remote control, slide the **MOUSE/ADJUSTMENT** switch to the ADJ. position.)

- ① Press **MENU**.
- ② Press **◀/▶** to select "Language".
- ③ Press **▲/▼** to select the desired language .
- ④ Press **ENTER** to save the setting. The On-screen Display is now programmed to display in the language selected.
- ⑤ To exit from the GUI, press **MENU**.

(GUI) On-screen Display

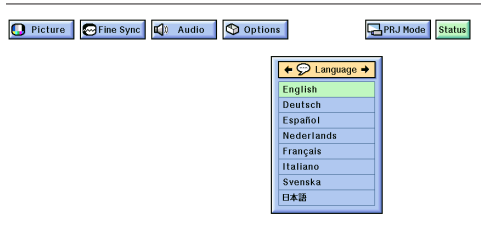

Picture Adjustments



Projector

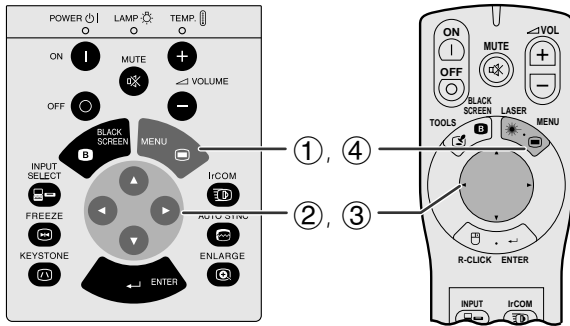

(GUI) On-screen Display

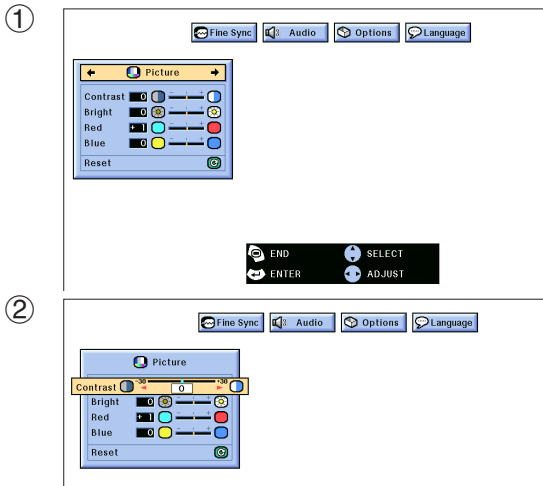

You can adjust the projector's picture to your preferences with the following picture settings.

Description of Adjustment Items

Selected item	◀ button	▶ button
Contrast	For less contrast	For more contrast
Bright	For less brightness	For more brightness
Red	For weaker red	For stronger red
Blue	For weaker blue	For stronger blue
Reset	All picture adjustment items are returned to the factory preset settings.	

(For use with the "Power" remote control, slide the **MOUSE/ADJUSTMENT** switch to the ADJ. position.)

- Press **MENU**. Menu bar and "Picture" menu screen appears. GUI Operation guide is also displayed.
- Press ▲/▼ to select a specific adjustment item.
- Press ◀/▶ to move the ◐ mark of the selected adjustment item to the desired setting.
- To exit from the GUI, press **MENU**.

NOTE

- To reset all adjustment items, select "Reset" on the "Picture" menu screen and press **ENTER**.
- The adjustments can be stored separately in the "COMPUTER1" and "COMPUTER2" modes.



Audio Adjustments

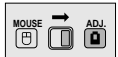

Projector

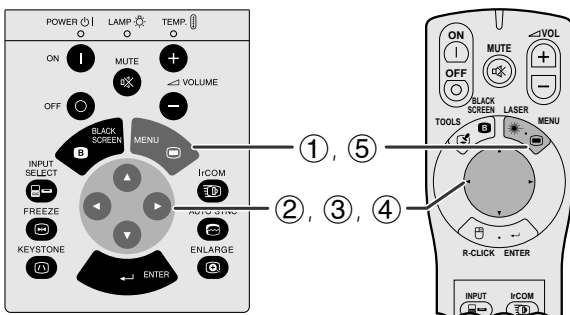

(GUI) On-screen Display

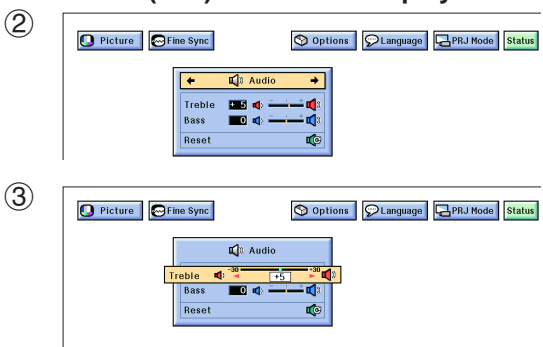

This projector's audio is factory preset to standard settings. However, you can adjust it to suit your own preferences by adjusting the following audio settings.

Description of Adjustment Items

Selected item	◀ button	▶ button
Treble	For weaker treble	For stronger treble
Bass	For weaker bass	For stronger bass
Reset	All audio adjustment items are returned to the factory preset settings.	

(For use with the "Power" remote control, slide the **MOUSE/ADJUSTMENT** switch to the ADJ. position.)

- Press **MENU**. Menu bar and "Picture" menu screen appears. GUI Operation guide is also displayed.
- Press ◀/▶ to select "Audio".
- Press ▲/▼ to select a specific adjustment item.
- Press ◀/▶ to move the ◐ mark of the selected adjustment item to the desired setting.
- To exit from the GUI, press **MENU**.

NOTE

- To reset all adjustment items, select "Reset" on the "Audio" menu screen and press **ENTER**.



Computer Image Adjustments



Projector

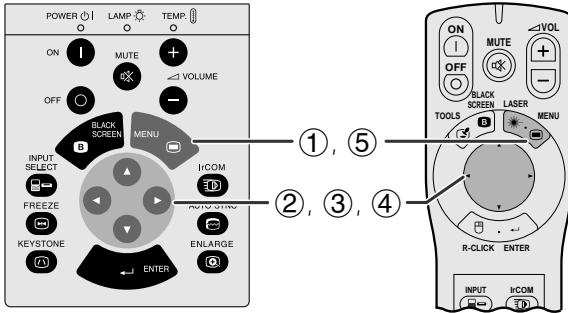

When displaying computer patterns which are very detailed (tiling, vertical stripes, etc.), interference may occur between the LCD pixels, causing flickering, vertical stripes, or contrast irregularities in portions of the screen. Should this occur, adjust "Clock", "Phase", "H-Pos" and "V-Pos" for optimum computer image.

Description of Adjustment Items

Selected item	Description
Clock	Adjusts vertical noise.
Phase	Adjusts horizontal noise (similar to tracking on your VCR).
H-Pos	Centres the on-screen image by moving it to the left or right.
V-Pos	Centres the on-screen image by moving it up or down.

NOTE

- Computer image adjustment can be made easily by pressing **AUTO SYNC** (🔄) on the projector or the "Power" remote control. See the next page for details.

(GUI) On-Screen Display

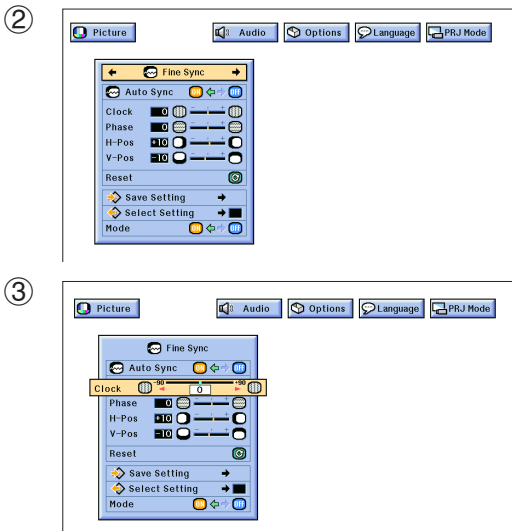

(Select the desired computer input mode with **INPUT SELECT** on the projector or **INPUT** on the "Power" remote control.)

(For use with the "Power" remote control, slide the **MOUSE/ADJUSTMENT** switch to the ADJ. position.)

- 1 Press **MENU**. Menu bar and "Picture" menu screen appears. GUI Operation guide is also displayed.
- 2 Press **◀/▶** to select "Fine Sync".
- 3 Press **▲/▼** to select a specific adjustment item.
- 4 Press **◀/▶** to move the **●** mark of the selected adjustment item to the desired setting.
- 5 To exit from the GUI, press **MENU**.

NOTE

- To reset all adjustment items, select "Reset" on the "Fine Sync" menu screen and press **ENTER**.





Projector

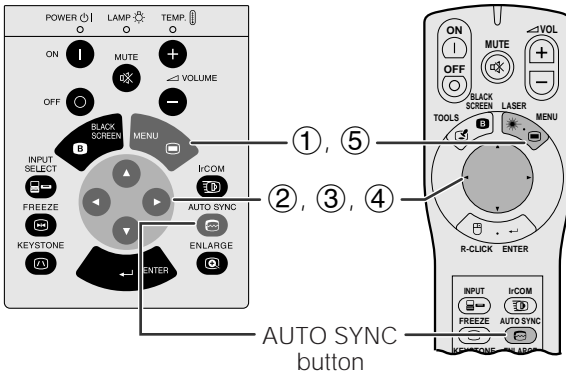

Auto Sync Adjustment

- Used to automatically adjust a computer image.
- Auto Sync adjustment can be made manually by pressing **AUTO SYNC** on the projector or the "Power" remote control, or automatically by setting "Auto Sync" to "ON" in the projector's GUI menu.

When "Auto Sync" is set to "ON":

- The sync adjustment is automatically made each time the projector is turned on while connected to a computer or the input selection is changed.
- The Auto Sync adjustment setting previously made is cleared when the projector's setting is changed.

(For use with the "Power" remote control, slide the **MOUSE/ADJUSTMENT** switch to the ADJ. position.)

- 1 Press **MENU**.
- 2 Press **◀/▶** to select "Fine Sync".
- 3 Press **▲/▼** to select "Auto Sync".
- 4 Press **◀/▶** to select "ON".
- 5 To exit from the GUI, press **MENU**.

(GUI) On-screen Display

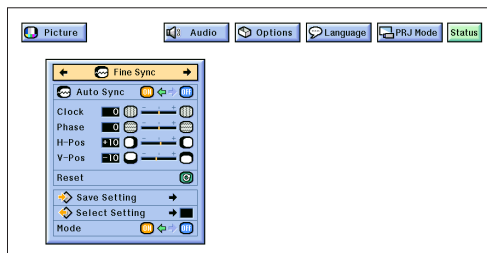

NOTE

- Automatic adjustments can be made by pressing **AUTO SYNC** on the projector or the "Power" remote control.
- When the optimum image cannot be achieved with Auto Sync adjustment, use manual adjustments. (See the previous page.)

On-screen Display



During Auto Sync adjustment, the On-screen Display changes as shown on the left.

NOTE

- Auto Sync adjustment may take some time to complete, depending on the image of the computer connected to the projector.

Auto Sync Display Function

Normally, an image is not superimposed during Auto Sync adjustment. You can, however, choose to superimpose a Sharp image during Auto Sync adjustment.

(For use with the "Power" remote control, slide the **MOUSE/ADJUSTMENT** switch to the ADJ. position.)

- 1 Press **MENU**.
- 2 Press **◀/▶** to select "Options".
- 3 Press **▲/▼** to select "Auto Sync Disp".
- 4 Press **◀/▶** to select "□" to superimpose a Sharp image or "⊞" to remove the Sharp image during Auto Sync adjustment.
- 5 To exit from the GUI, press **MENU**.

(GUI) On-screen Display

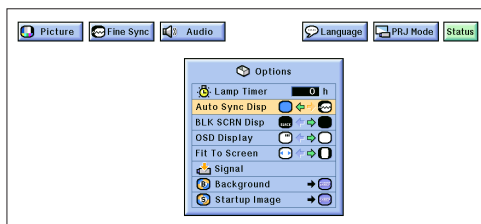

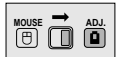

Projector

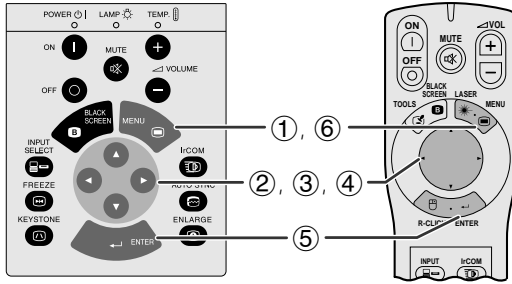

(GUI) On-screen Display

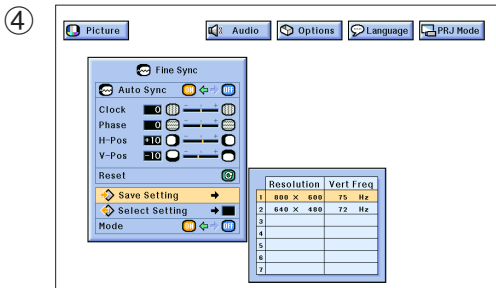
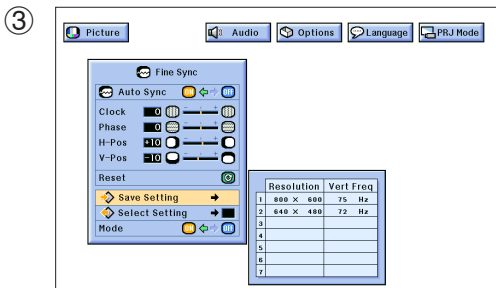
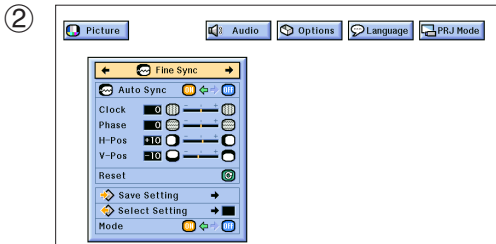

Mode Adjustment

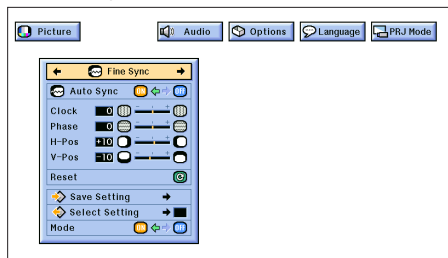

Saving and Selecting Adjustment Settings

This projector allows you to store up to seven adjustment settings for use with various computers. Once these settings are stored, they can be easily selected each time you connect the computer to the projector.

Saving the adjustment setting

(For use with the "Power" remote control, slide the **MOUSE/ADJUSTMENT** switch to the ADJ. position.)

- ① Press **MENU**.
- ② Press ◀▶ to select "Fine Sync".
- ③ Press ▲▼ to select "Save Setting", and then press ▶.
- ④ Press ▲▼ to select the desired memory location of the setting.
- ⑤ Press **ENTER** to save the setting.
- ⑥ To exit from the GUI, press **MENU**.

Selecting a saved setting

(For use with the "Power" remote control, slide the **MOUSE/ADJUSTMENT** switch to the ADJ. position.)

- ① Press **MENU**.
- ② Press ◀▶ to select "Fine Sync".
- ③ Press ▲▼ to select "Select Setting", and then press ▶.
- ④ Press ▲▼ to select the desired memory setting.
- ⑤ Press **ENTER** to select the setting.
- ⑥ To exit from the GUI, press **MENU**.

NOTE

- If the memory position has not been set, the resolution and frequency will not be displayed.
- When selecting the stored adjustment setting with "Select Setting", the computer system should match the stored setting.

Mode Adjustment

Used to display image in the text and graphic modes.

CONNECTING TO IBM-PC COMPUTERS

- Ordinarily, the type of input signal is detected and the correct resolution mode (Text or Graphics) is automatically selected. However, for the following signals, set "Mode" on the "Fine Sync" menu screen to "ON" or "OFF" to select the projector's resolution mode to match the computer display mode properly.

(For use with the "Power" remote control, slide the **MOUSE/ADJUSTMENT** switch to the ADJ. position.)

- ① Press **MENU**.
- ② Press ◀▶ to select "Fine Sync".
- ③ Press ▲▼ to select "Mode".
- ④ Press ◀▶ to select "ON" for graphic mode (640 dots × 350 lines, 640 dots × 400 lines or 1,152 dots × 864 lines, 60 Hz) or "OFF" for text mode (720 dots × 350 lines, 720 dots × 400 lines or 1,024 dots × 864 lines, 60 Hz). (For IBM-PC) Press ◀▶ to select "ON" when connecting to a Macintosh II with 35 kHz dot frequency or "OFF" when connecting to a Macintosh LC Series computer with 34.79 kHz dot frequency. (For Macintosh LC Series)
- ⑤ Press **ENTER** to save the setting.
- ⑥ To exit from the GUI, press **MENU**.

NOTE

- When connecting third party video board and other Macintosh computers, set "Mode" on the "Fine Sync" menu screen to "ON" or "OFF" to select the correct display mode.
- When the input signal is automatically detected or when there is no input signal, "Mode (---)" appears on the screen and the display mode cannot be changed.
- Avoid displaying computer patterns which repeat every other line (horizontal stripes). (Flickering may occur, making the image hard to see.)



Digital Image Magnification and Reduction

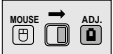

Projector

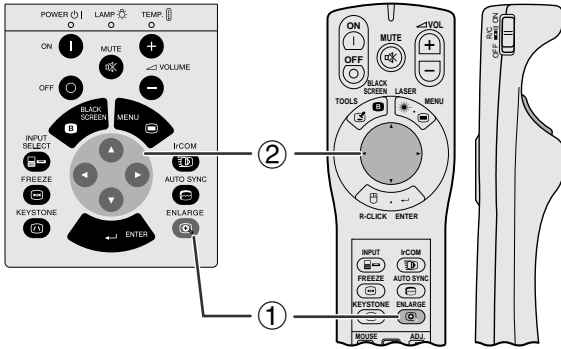

On-screen Display

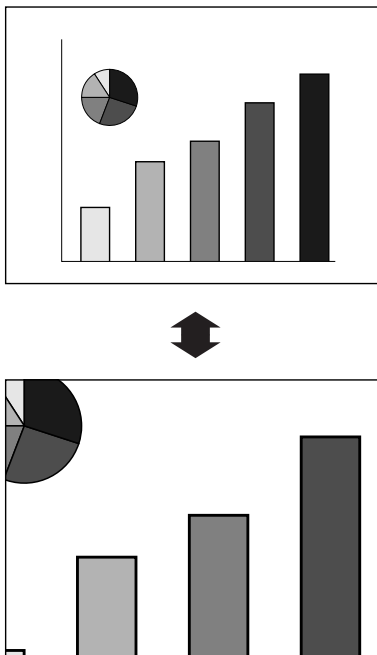

This function allows you to magnify a specific portion of an image. This is useful when you want to display a detailed portion of the image or display it in its native resolution.

(To use the "Power" remote control to operate this function, slide the **MOUSE/ADJUSTMENT** switch to the ADJ. position before pressing **ENLARGE**.)

- ① Press **ENLARGE**. Each time **ENLARGE** is pressed, the image will be magnified.
- ② When the image is magnified, you can pan and scan around the image by using **▲/▼/◀/▶**.

NOTE

• Each time **ENLARGE** is pressed, image magnification toggles as shown below.

1. When the input resolution is smaller than XGA (VGA, SVGA)

×1 → ×2 → ×4 → ×8 → **Dot by dot**

2. When the input resolution is XGA

→ ×1 → ×2 → ×4 → ×8

3. When the input resolution is bigger than XGA (SXGA, UXGA)

×1 → **Dot by dot** → ×2 → ×4 → ×8

• If the input signal is changed during digital image magnification, the image will return to ×1. The input signal is changed (a) when **INPUT SELECT** is pressed, (b) when there is no input signal, or (c) when the input resolution and refresh rate changes.

Dot by dot mode display

This mode displays images in their native resolution and not expanded to fit the LCD resolution. See the steps and the note above to display an image in dot by dot mode.



Freeze Function

Projector

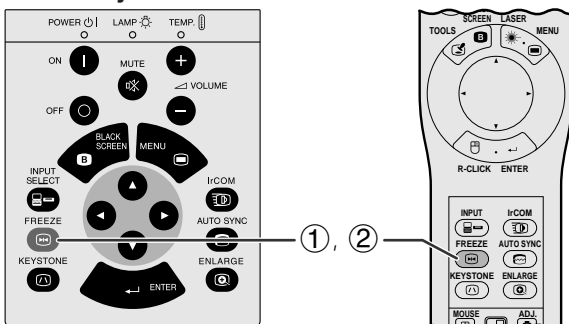

On-screen Display



This function allows you to instantly freeze a moving image. This is useful when you want to display a still image of a computer, giving you more time to explain the image to the audience.

- ① Press **FREEZE** to freeze the image.
- ② Press **FREEZE** again to return to the moving image.



Black Screen Function

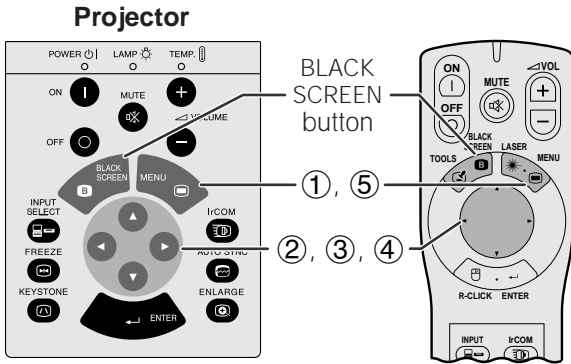
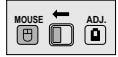

This function can be used to superimpose a black screen over the projected image.

Blacking out the Projected Image

Press **BLACK SCREEN**. "BLACK SCREEN" is displayed on the screen. To return to the original projected image, press **BLACK SCREEN** again.

NOTE

- To use the "Power" remote control to operate this function, slide the **MOUSE/ADJUSTMENT** switch to the **MOUSE** position before pressing **BLACK SCREEN**.



Turning off the On-screen Display

The On-screen Display ("BLACK SCREEN") that appears during black screen can be turned off. When "BLK SCR N Disp" is set to "OFF" in the projector's GUI menu, "BLACK SCREEN" will not be displayed during function.

(For use with the "Power" remote control, slide the **MOUSE/ADJUSTMENT** switch to the **ADJ.** position.)

- Press **MENU**.
- Press **◀/▶** to select "Options".
- Press **▲/▼** to select "BLK SCR N Disp".
- Press **◀/▶** to select "OFF" to turn on or "ON" to turn off the function.
- To exit from the GUI, press **MENU**.

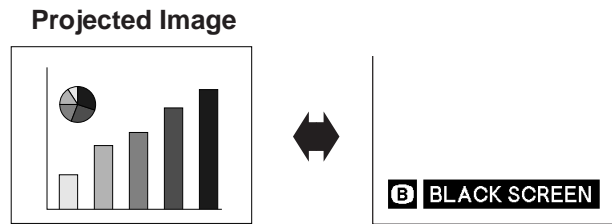

(GUI) On-screen Display

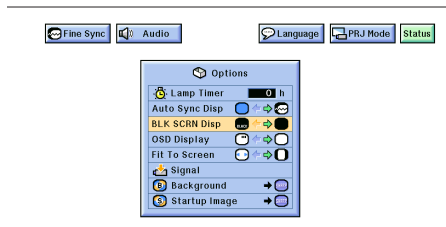

On-screen Display Override Function

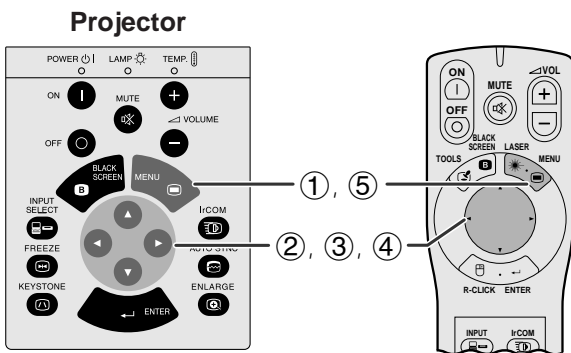

This function allows you to turn off the on-screen messages that appear during "input select" and the "IrCOM" function. Once "OSD Display" is set to "OFF" in the projector's GUI menu, the on-screen messages will not appear when **INPUT** and **IrCOM** on the projector or the "Power" remote control are pressed.

(For use with the "Power" remote control, slide the **MOUSE/ADJUSTMENT** switch to the **ADJ.** position.)

- Press **MENU**.
- Press **◀/▶** to select "Options".
- Press **▲/▼** to select "OSD Display".
- Press **◀/▶** to select "OFF" to turn on or "ON" to turn off the On-screen Display.
- To exit from the GUI, press **MENU**.

(GUI) On-screen Display

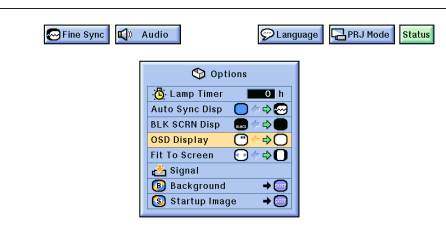

Fit to Screen Function

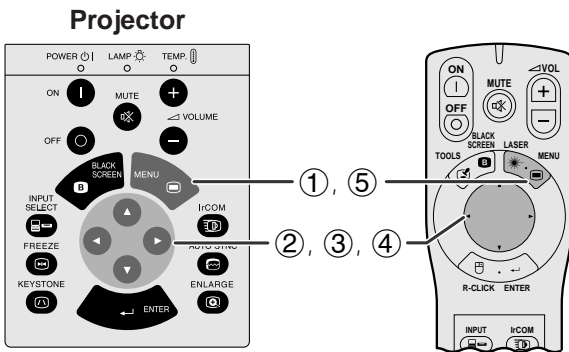
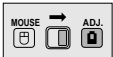

This function can be used to expand or compress images which are not native 4:3 aspect ratio (i.e. 1,280 × 1,024 resolution).

(For use with the "Power" remote control, slide the **MOUSE/ADJUSTMENT** switch to the ADJ. position.)

- ① Press **MENU**.
- ② Press **◀/▶** to select "Options".
- ③ Press **▲/▼** to select "Fit To Screen".
- ④ Press **◀/▶** to select "0" to display the image in its native resolution or "◻" to expand the image, to fill the screen.
- ⑤ To exit from the GUI, press **MENU**.

(GUI) On-screen Display

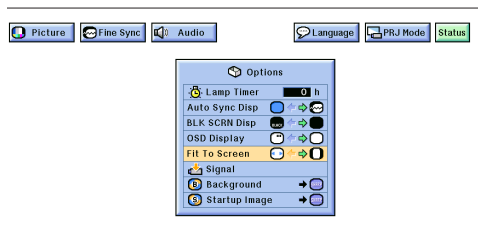

Checking the Input Signal and Lamp Usage Time

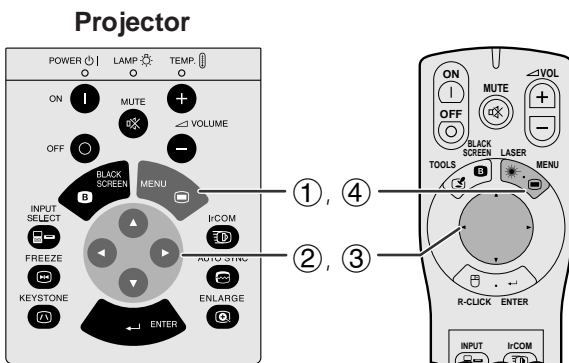
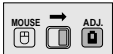

This function allows you to check the current input signal information and accumulated lamp usage time.

(For use with the "Power" remote control, slide the **MOUSE/ADJUSTMENT** switch to the ADJ. position.)

- ① Press **MENU**.
- ② Press **◀/▶** to select "Options". The lamp usage time will be displayed.
- ③ Press **▲/▼** to select "Signal" to display the current input signal.
- ④ To exit from the GUI, press **MENU**.

(GUI) On-screen Display

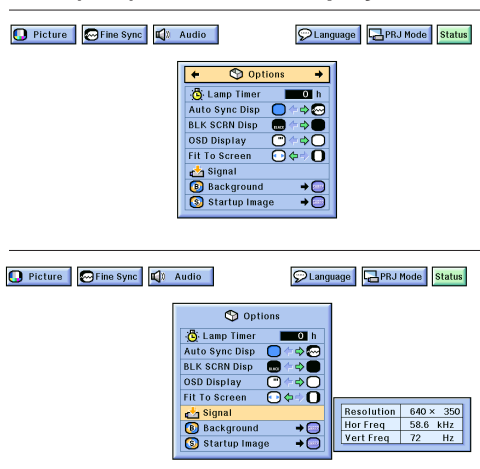

NOTE

- It is recommended that the lamp be replaced after 1,900 hours of usage. At this point, take the projector to your nearest Sharp Authorised LCD Projector Dealer or Service Centre to have the lamp replaced. See page 36 for details.





Setting a Background Image

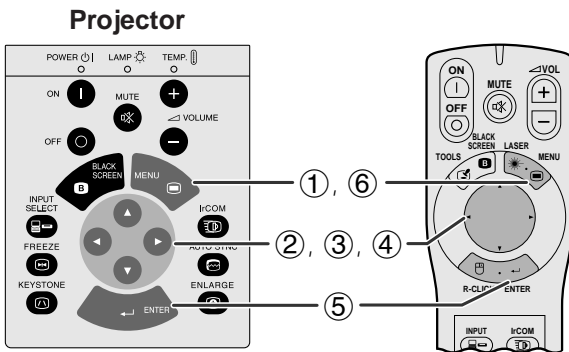
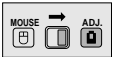

(GUI) On-screen Display

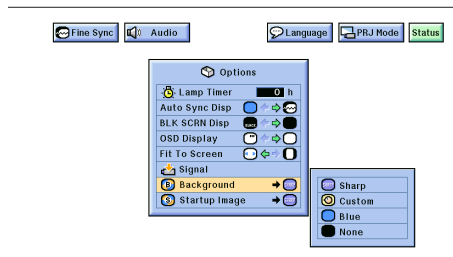

This function allows you to select the image displayed when no signal is being sent to the projector.

Description of Background Images

Selected item	Background image
Sharp	SHARP default image
Custom	User customised image (i.e. company logo)
Blue	Blue screen
None	Black screen

(For use with the "Power" remote control, slide the **MOUSE/ADJUSTMENT** switch to the ADJ. position.)

- ① Press **MENU**.
- ② Press **◀/▶** to select "Options".
- ③ Press **▲/▼** to select "Background", and then press **▶**.
- ④ Press **▲/▼** to select the background image you want to display on the screen.
- ⑤ Press **ENTER** to save the setting.
- ⑥ To exit from the GUI, press **MENU**.

NOTE

- By selecting "Custom", the projector can display a custom image (i.e. your company logo) as the background image. Custom image must be 256 colour BMP. Please see the Sharp Advanced Presentation Software's operation manual for how to save (or change) a custom image.



Selecting a Startup Image

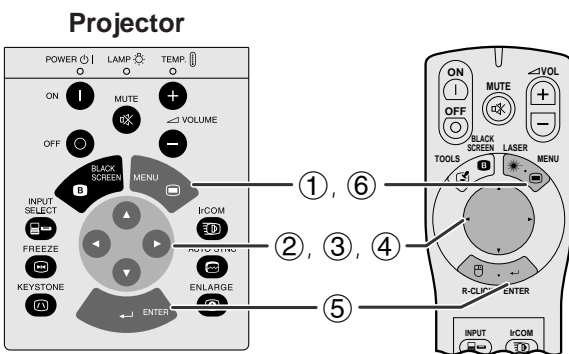
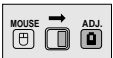

(GUI) On-screen Display

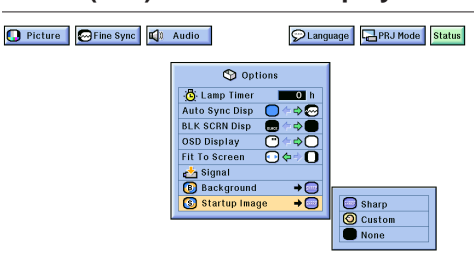

- This function allows you to specify the image to be displayed upon the projector's startup.
- A custom image (i.e. your company logo) can be loaded on the projector via IrCOM or an RS-232C cable. See pages 15 and 22 in this operation manual, and also the supplied Sharp Advanced Presentation Software's operation manual for detailed instructions.

Description of Startup Images

Selected item	Startup image
Sharp	SHARP default image
Custom	User customised image (i.e. company logo)
None	Black screen

(For use with the "Power" remote control, slide the **MOUSE/ADJUSTMENT** switch to the ADJ. position.)

- ① Press **MENU**.
- ② Press **◀/▶** to select "Options".
- ③ Press **▲/▼** to select "Startup Image", and then press **▶**.
- ④ Press **▲/▼** to select the startup image you want to display on the screen.
- ⑤ Press **ENTER** to save the setting.
- ⑥ To exit from the GUI, press **MENU**.

NOTE

- By selecting "Custom", the projector can display a custom image (i.e. your company logo) as the startup image. Custom image must be 256 colour BMP. Please see the Sharp Advanced Presentation Software's operation manual for how to save (or change) a custom image.



Reverse/Invert Image Function

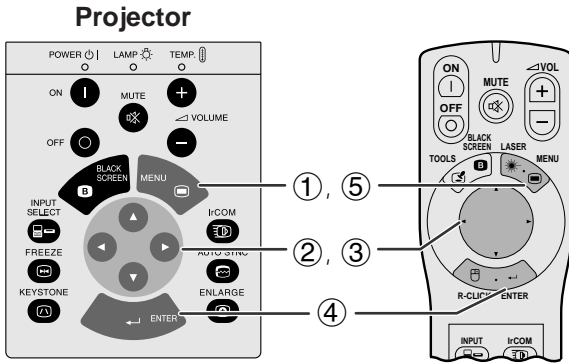
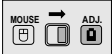

This projector is equipped with a reverse/invert image function which allows you to reverse or invert the projected image for various applications.

Description of Projected Images

Selected item	Projected image
FRONT	Normal image
CEILING + FRONT	Inverted image
REAR	Reversed image
CEILING + REAR	Reversed and inverted image

(GUI) On-screen Display

When Selecting "Front"

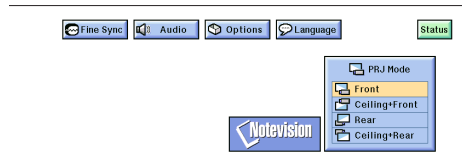

When Selecting "Ceiling + Front"

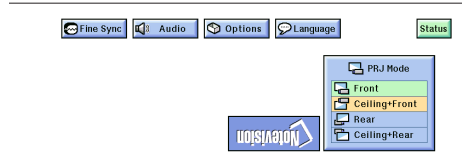

When Selecting "Rear"

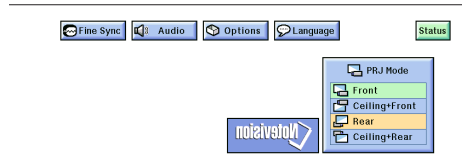

When Selecting "Ceiling + Rear"

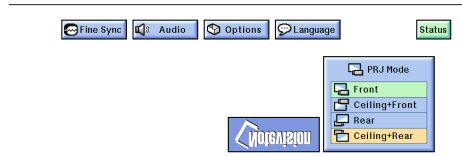

(For use with the "Power" remote control, slide the **MOUSE/ADJUSTMENT** switch to the ADJ. position.)

- 1 Press **MENU**.
- 2 Press **◀/▶** to select "PRJ Mode".
- 3 Press **▲/▼** to select the desired projection mode.
- 4 Press **ENTER** to save the setting.
- 5 To exit from the GUI, press **MENU**.

NOTE

- This function is used for the reversed image and ceiling-mount setups. See pages 12 and 13 for these setups.





Using the Presentation Tools

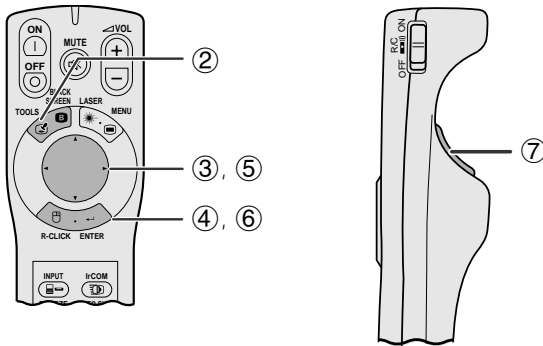
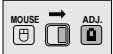

This projector is equipped with presentation tools, which can be accessed from the "Power" remote control. These will help you emphasise keypoints within your presentation.

On-screen Display



Menu Window

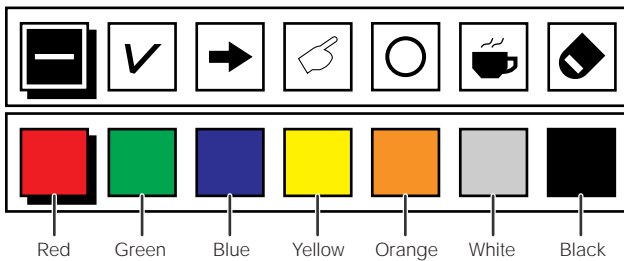

- ① Slide the **MOUSE/ADJUSTMENT** switch to the ADJ. position.
- ② Press **TOOLS** to display the presentation tools menu window on the screen.
- ③ Press **▲/▼/◀/▶** to select the desired tool and colour.
- ④ Press **ENTER** to select it.
- ⑤ Once the tool is displayed on the screen, press **▲/▼/◀/▶** to move it around the screen.
- ⑥ Press **ENTER** to stamp the tool on the screen.
- ⑦ Use **LEFT-CLICK** to individually delete tools stamped on the screen.

NOTE

- You can stamp each tool as many times as you want on the screen.
- To clear all the stamped presentation tools on the screen, press **▲/▼/◀/▶** to select "☕" and **ENTER**.

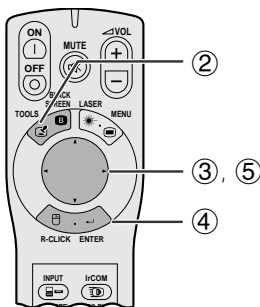

Displaying the break time

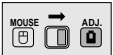

- ① Slide the **MOUSE/ADJUSTMENT** switch to the ADJ. position.
- ② Press **TOOLS** to display the presentation tools menu window on the screen.
- ③ Press **▲/▼/◀/▶** to select "☕" in the menu window.
- ④ Press **ENTER** to start counting down the break time.
- ⑤ Press **▲** to increase or **▼** to decrease the break time.

NOTE

- The break time is displayed against the background image selected in "Selecting a Startup Image". (See page 31.)

When selecting Sharp default image





Checking the Adjustment Status

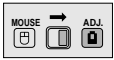

Projector

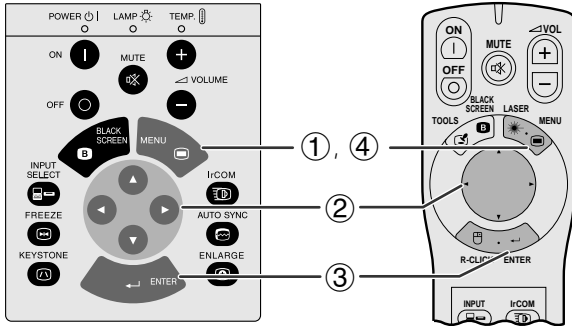

This function can be used to display all the adjusted settings on the screen simultaneously.

(For use with the "Power" remote control, slide the **MOUSE/ADJUSTMENT** switch to the ADJ. position.)

- 1 Press **MENU**.
- 2 Press **◀/▶** to select "Status".
- 3 Press **ENTER** to display all the adjusted settings.
- 4 To exit from the GUI, press **MENU**.

(GUI) On-screen Display

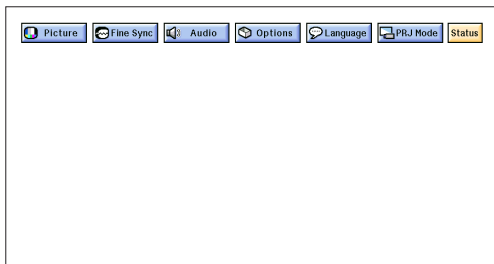

Picture	Fine Sync	Audio	Options	Language
Contrast 0	Auto Sync	Treble + 5	Auto Sync Disp	English
Bright 0	Clock 0	Bass 0	BLK SCR M Disp	Language Front
Red + 1	Phase 0		OSD Display	
Blue 0	H-Pos +10		Fit To Screen	
	V-Pos -10		Background	
	Select Setting		Startup Image	
	Mode			



Automatic Power Shutoff Function

On-screen Display



When no input signal is detected for more than 15 minutes, the projector will automatically shut down. The on-screen message on the left will appear five minutes before the power is automatically turned off.

NOTE

- When "None" is selected in the "Background" setting, the Automatic Power Shutoff function does not operate.





Air Filter Maintenance

- This projector is equipped with three air filters to ensure the optimal operating condition of the projector.
- The air filters should be cleaned every 100 hours of use. Clean the filters more often when the projector is used in a dusty or smoky location.
- Have your nearest Sharp Authorised LCD Projector Dealer or Service Centre exchange the filter (PFILD0076CEZZ) when it is no longer possible to clean it.

Bottom View

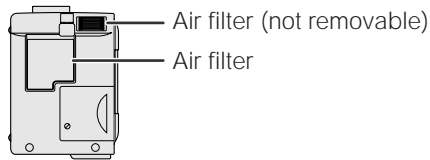

Side and Rear View



Cleaning and replacing the bottom air filter

<p>1 Turn off the main power.</p> <p>Turn off the MAIN POWER switch. Then unplug the power cord.</p>	<p>2 Remove the bottom filter cover.</p> <p>Turn over the projector. Press the tab and lift open the filter cover in the direction of the arrow.</p>	<p>3 Remove the air filter.</p> <p>Grasp the air filter between your fingers and lift it out of the filter cover.</p>
<p>4 Clean the air filter.</p> <p>Clean the dust off the air filter and cover with a vacuum cleaner extension hose.</p>	<p>5 Replace the air filter.</p> <p>Place the air filter underneath the tabs on the filter frame.</p>	<p>6 Replace the filter cover.</p> <p>Insert the tab on the end of the filter cover into the filter cover opening and press the filter cover into position.</p>

NOTE

- Be sure the filter cover is securely installed. The power will not turn on unless it is correctly installed.

Cleaning the side and bottom air filters (not removable)

If dust or dirt has collected inside the air filters, clean the filters with a vacuum cleaner extension hose.

NOTE

- The side and bottom air filters cannot be removed.





Lamp/Maintenance Indicators

Maintenance Indicators

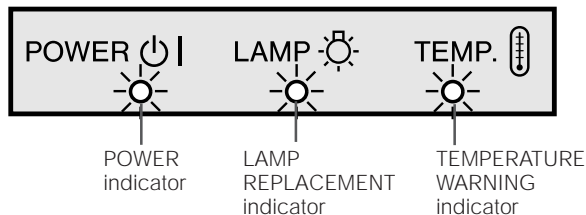

- The warning lights on the projector indicate problems inside the projector.
- There are two warning lights: a TEMPERATURE WARNING indicator which warns that the projector is too hot, and a LAMP REPLACEMENT indicator which lets you know when to change the lamp.
- If a problem occurs, either the TEMPERATURE WARNING indicator or the LAMP REPLACEMENT indicator will light up red, and the power will shut off. After turning off the power, follow the procedures given below.

Maintenance Indicator	Condition	Problem	Possible Solution
TEMPERATURE WARNING indicator	The internal temperature is abnormally high.	• Blocked air intake.	• Relocate the projector to an area with proper ventilation.
		• Clogged air filter.	• Clean the filter. (See page 35.)
		• Cooling fan breakdown. • Internal circuit failure.	• Take the projector to your nearest Sharp Authorised LCD Projector Dealer or Service Centre for repair.
LAMP REPLACEMENT indicator	The lamp does not light up.	• Burnt-out lamp. • Lamp circuit failure.	• Take the projector to your nearest Sharp Authorised LCD Projector Dealer or Service Centre for repair.
	The lamp requires replacement.	• Lamp has been used for over 1,900 hours.	
POWER indicator	The POWER indicator flashes in red when POWER ON is pressed.	• The bottom filter cover is open.	• Securely install the bottom filter cover.

NOTE

- If the TEMPERATURE WARNING indicator lights up, follow the above possible solutions and then wait until the projector has cooled down completely before turning the power back on. (At least 5 minutes.)
- If the power is turned off and then turned on again, as during a brief rest, the LAMP REPLACEMENT indicator may be triggered, preventing the power from going on. Should this occur, take the power cord out of the wall outlet and put it back in again.

Lamp

The lamp in this projector operates for approximately 2,000 cumulative hours, depending on the usage environment. It is recommended that the lamp be replaced after 1,900 cumulative hours of use or when you notice a significant deterioration of the picture and colour quality. At this point, take the projector to your nearest Sharp Authorised LCD Projector Dealer or Service Centre to have the lamp replaced.

CAUTION

- Intense light hazard. Do not attempt to look into the aperture and lens while the projector is operating.

NOTE

- The lamp usage time can be checked with the On-screen Display (see page 30).
- As the usage environment can vary significantly, the projector lamp may not operate for 2,000 hours.

Condition	Problem	Possible Solution
The LAMP REPLACEMENT indicator lights up red, and "LAMP" and "LAMP" will flash in yellow in the lower-left corner of the picture.	• Lamp has been used for over 1,900 hours.	• Take the projector to your nearest Sharp Authorised LCD Projector Dealer or Service Centre to have the lamp replaced.
A significant deterioration of the picture and colour quality occurs.		
The power will automatically turn off and the projector will enter standby mode.	• Lamp has been used for over 2,000 hours.	
"LAMP" and "LAMP" will flash in red in the lower-left corner of the picture, and the power will turn off.		





Using the Kensington Lock

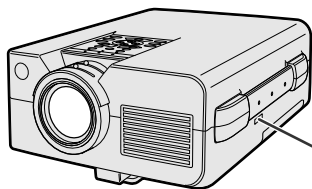

Kensington Security Standard connector

This projector has a Kensington Security Standard connector for use with a Kensington MicroSaver Security System. Refer to the information that came with the system for instructions on how to use it to secure the projector.



Troubleshooting

Problem	Check
No picture and no sound.	<ul style="list-style-type: none"> • Projector power cord is not plugged into the wall outlet. • MAIN POWER switch is not on. • The bottom filter cover is not securely installed. • Input is wrong. (See pages 19.) • Cables improperly connected to rear panel of the projector. (See pages 15, 16 and 17.) • "Power" remote control batteries have run down. (See page 10.) • Main power of the "Power" remote control is not turned on. • "Power" remote control's MOUSE/ADJUSTMENT switch is set to MOUSE.
Sound is heard but no picture appears.	<ul style="list-style-type: none"> • Cables improperly connected to rear panel of the projector. (See pages 15, 16 and 17.) • "Contrast" and "Bright" adjustments are set to minimum position. (See page 24.) • On-screen Display ("BLACK SCREEN") is turned off and Black Screen function is turned on, creating a black image. (See page 29.)
Picture is blurred.	<ul style="list-style-type: none"> • Adjust the focus. (See page 18.) • Projection distance is too long or too short to allow for proper focus. (See page 12.)
Picture appears but no sound is heard.	<ul style="list-style-type: none"> • Cables improperly connected to rear panel of the projector. (See pages 15, 16 and 17.) • Volume is set to minimum. (See page 19.)
An unusual sound is occasionally heard from the cabinet.	<ul style="list-style-type: none"> • If the picture is normal, the sound is due to cabinet shrinkage caused by temperature changes. This will not affect operation or performance.
Maintenance indicator lights up.	<ul style="list-style-type: none"> • Refer to "Lamp/Maintenance Indicators" on page 36.
Data cannot be received via IrCOM.	<ul style="list-style-type: none"> • Distance and angle between the projector and transmitting device are out of the designated range. (See page 22.) • Refer to the operation manual of the transmitting device. • Refer to the section "Troubleshooting" in the operation manual of the supplied software.





Transporting the Projector

When transporting the projector, carry it by the carrying handle on the side. A soft-side carrying bag is also provided to transport the projector.

Using the Carrying Handle

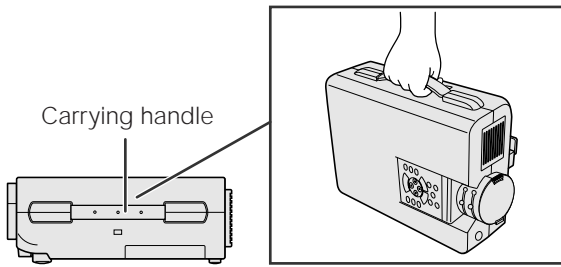

CAUTION

- Always put on the lens cap to prevent damage to the lens when transporting the projector.
- Do not lift or carry the projector by the lens or the lens cap as this may damage the lens.

Using the Carrying Bag

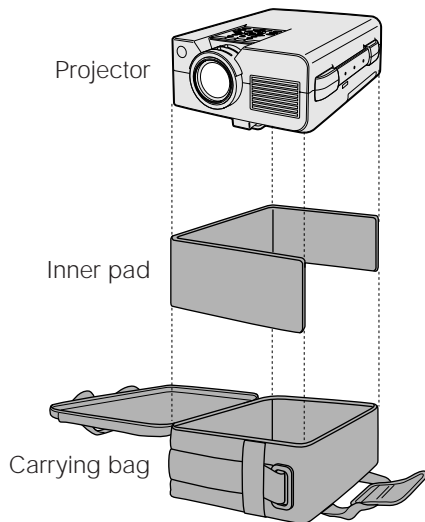

Before placing the projector into the carrying bag, set up the inner pad inside the bag as shown.

CAUTION

- The supplied carrying bag is made exclusively for the projector and its supplied accessories. Do not place other items into the carrying bag with the projector or use the bag to transport items other than the projector and its accessories.
- This bag is provided merely to transport the projector and its accessories, not to protect these products from damage as a result of rough handling. Do not expose these products to shocks or impact when transported in the carrying bag.
- Wait until the projector has sufficiently cooled before placing it into the carrying bag. If the projector is placed into the bag while it is still hot, the heat may damage the bag lining.

Attaching the shoulder strap to the carrying bag



1 Take the shoulder strap out.

The shoulder strap is stored in the pocket located in front of the carrying bag.

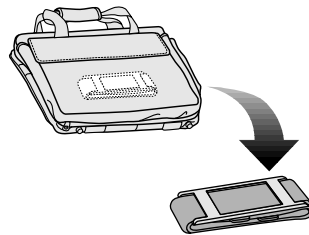

2 Fasten the shoulder strap to the carrying bag.

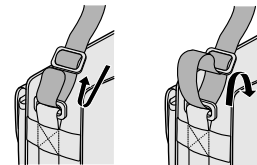

The strap should extend at least 6 cm from the buckle.

Follow the same procedure for the other end of the strap.





Connection Pin Assignments

Analog Computer 1 and 2 Signal Input

Ports: 15-pin mini D-sub female connector

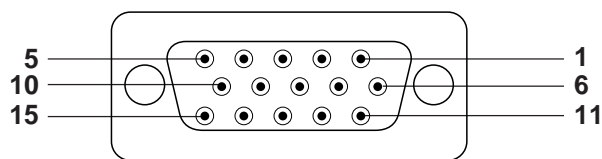

Computer Input

Analog

- | | |
|--------------------------------------|----------------------------|
| 1. Video input (red) | 9. Not connected |
| 2. Video input (green/sync on green) | 10. GND |
| 3. Video input (blue) | 11. GND |
| 4. Reserve input 1 | 12. Bi-directional data |
| 5. Composite sync | 13. Horizontal sync signal |
| 6. Earth (red) | 14. Vertical sync signal |
| 7. Earth (green/sync on green) | 15. Data clock |
| 8. Earth (blue) | |

RS-232C Port: 9-pin D-sub male connector

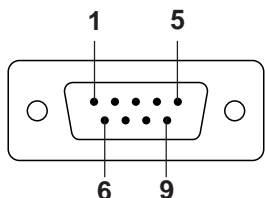

Pin No.	Signal	Name	I/O	Reference
1	CD			Not connected
2	RD	Receive Data	Input	Connected to internal circuit
3	SD	Send Data	Output	Connected to internal circuit
4	ER			Not connected
5	SG	Signal Ground		Connected to internal circuit
6	DR	Data Set Ready	Output	Not connected
7	RS	Request to Send	Output	Connected to internal circuit
8	CS			Not connected
9	CI			Not connected



RS-232C Port Specifications

PC control

A computer can be used to control the projector by connecting an RS-232C cable (cross type, sold separately) to the projector. (See page 15 for connection.)

Communication conditions

Set the serial port settings of the computer to match that of the table on the next page.

Signal format: Conforms to RS-232C standard.

Baud rate: 9,600 bps

Data length: 8 bits

Parity bit: NON

Stop bit: 1 bit

Flow control: None

Basic format

Commands from the computer are sent in the following order: command, parameter, and return code. After the projector processes the command from the computer, it sends a response code to the computer.

Command format

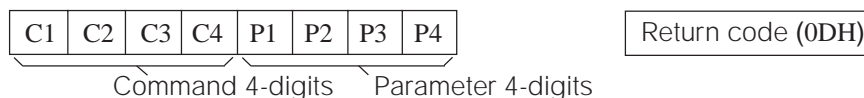

Response code format

Normal response



Problem response (communication error or incorrect command)



When more than one code is being sent, send each command only after the OK response code for the previous command from the projector is verified.

NOTE

- When using the computer control function of the projector, the projector operating status cannot be read to the computer. Therefore, confirm the status by transmitting the display commands for each adjustment menu and checking the status with the On-screen Display. If the projector receives a command other than a menu display command, it will execute the command without displaying the On-screen Display.





RS-232C Port Specifications

Commands

EXAMPLE

- When "Bright" of COMPUTER 1 IMAGE ADJUSTMENT is set to -10.

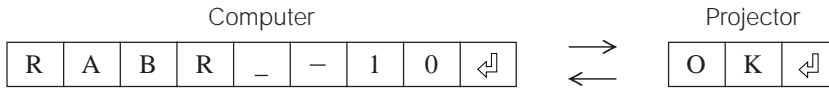

CONTROL ITEM	COMMAND				PARAMETER				CONTROL CONTENTS
	C1	C2	C3	C4	P1	P2	P3	P4	
POWER SETTING	P	O	W	R	_	_	_	0	POWER OFF
	P	O	W	R	_	_	_	1	POWER ON
INPUT SWITCHING	I	R	G	B	_	_	_	1	COMPUTER 1
	I	R	G	B	_	_	_	2	COMPUTER 2
	I	C	O	M	_	_	_	1	IrCOM
INPUT CHECK	I	C	H	K	_	_	_	0	INPUT CHECK
KEYSTONE ADJUSTMENT	K	E	Y	S	*	*	*	*	KEYSTONE
LANGUAGE SELECTION	M	E	L	A	_	_	_	1	ENGLISH
	M	E	L	A	_	_	_	2	DEUTSCH
	M	E	L	A	_	_	_	3	ESPAÑOL
	M	E	L	A	_	_	_	4	NEDERLANDS
	M	E	L	A	_	_	_	5	FRANÇAIS
	M	E	L	A	_	_	_	6	ITALIANO
	M	E	L	A	_	_	_	7	SVENSKA
	M	E	L	A	_	_	_	8	JAPANESE
BACKGROUND SELECTION	I	M	B	G	_	_	_	1	SHARP IMAGE
	I	M	B	G	_	_	_	2	CUSTOM IMAGE
	I	M	B	G	_	_	_	3	BLUE BACK
	I	M	B	G	_	_	_	4	NONE
STARTUP IMAGE SELECTION	I	M	S	I	_	_	_	1	SHARP IMAGE
	I	M	S	I	_	_	_	2	CUSTOM IMAGE
	I	M	S	I	_	_	_	3	NONE
VOLUME ADJUSTMENT	V	O	L	A	_	_	*	*	VOLUME (00 - 60)
	M	U	T	E	_	_	_	0	MUTE OFF
	M	U	T	E	_	_	_	1	MUTE ON
AUDIO ADJUSTMENT	A	A	T	E	_	*	*	*	TREBLE (-30 - +30)
	A	A	B	A	_	*	*	*	BASS (-30 - +30)
	A	A	R	E	_	_	_	0	AUDIO DISPLAY
	A	A	R	E	_	_	_	1	RESET

CONTROL ITEM	COMMAND				PARAMETER				CONTROL CONTENTS
	C1	C2	C3	C4	P1	P2	P3	P4	
COMPUTER 1 IMAGE ADJUSTMENT	R	A	P	I	_	*	*	*	CONTRAST (-30 - +30)
	R	A	B	R	_	*	*	*	BRIGHT (-30 - +30)
	R	A	R	D	_	*	*	*	RED (-30 - +30)
	R	A	B	E	_	*	*	*	BLUE (-30 - +30)
	R	A	R	E	_	_	_	0	COMPUTER 1 DISPLAY
COMPUTER 2 IMAGE ADJUSTMENT	R	B	P	I	_	*	*	*	CONTRAST (-30 - +30)
	R	B	B	R	_	*	*	*	BRIGHT (-30 - +30)
	R	B	R	D	_	*	*	*	RED (-30 - +30)
	R	B	B	E	_	*	*	*	BLUE (-30 - +30)
	R	B	R	E	_	_	_	0	COMPUTER 2 DISPLAY
COMPUTER INPUT AUTO SYNCHRONIZATION	A	A	D	J	_	_	_	0	AUTO SYNC OFF
	A	A	D	J	_	_	_	1	AUTO SYNC ON
	A	D	J	S	_	_	_	1	AUTO SYNC START
COMPUTER INPUT ADJUSTMENT	I	N	C	L	_	*	*	*	CLOCK (-90 - +90)
	I	N	P	H	_	*	*	*	PHASE (-60 - +60)
	I	A	H	P	_	*	*	*	H-POS (-90 - +90)
	I	A	V	P	_	*	*	*	V-POS (-60 - +60)
	I	A	R	E	_	_	_	0	COMPUTER INPUT DISPLAY
SCREEN SETTING	I	A	R	E	_	_	_	1	RESET
	I	M	F	S	_	_	_	0	FIT TO SCREEN OFF
	I	M	F	S	_	_	_	1	FIT TO SCREEN ON
	I	M	D	I	_	_	_	0	OSD DISPLAY OFF
	I	M	D	I	_	_	_	1	OSD DISPLAY ON
	I	M	R	E	_	_	_	0	REVERSE OFF
	I	M	R	E	_	_	_	1	REVERSE ON
	I	M	I	N	_	_	_	0	INVERT OFF
	I	M	I	N	_	_	_	1	INVERT ON
	I	M	A	S	_	_	_	0	AUTO SYNC DISPLAY OFF
BLACK SCREEN	I	M	A	S	_	_	_	1	AUTO SYNC DISPLAY ON
	I	M	B	K	_	_	_	0	BLACK SCREEN OFF
	I	M	B	K	_	_	_	1	BLACK SCREEN ON
	I	M	B	O	_	_	_	0	BLACK SCREEN DISPLAY OFF
SCREEN MODE MEMORY	I	M	B	O	_	_	_	1	BLACK SCREEN DISPLAY ON
	M	E	M	S	_	_	_	*	SAVE SETTING (1-7)
	M	E	M	L	_	_	_	*	SELECT SETTING (1-7)

NOTE

- If a dash (_) appears in the parameter column, enter a space. If an asterisk (*) appears, enter a value in the range indicated in brackets under CONTROL CONTENTS.
- COMPUTER INPUT ADJUSTMENT can only be set in the displayed computer mode.





Input Signals (Recommended Timing)

The computer output signal timing of different types of computer signals are shown below for reference.

For IBM and compatibles

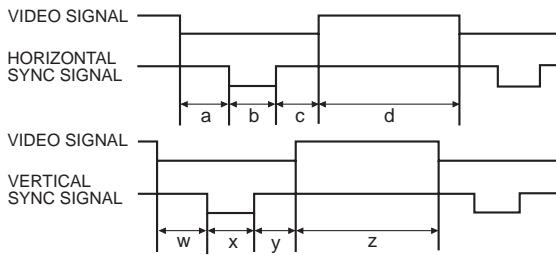

For Macintosh Series

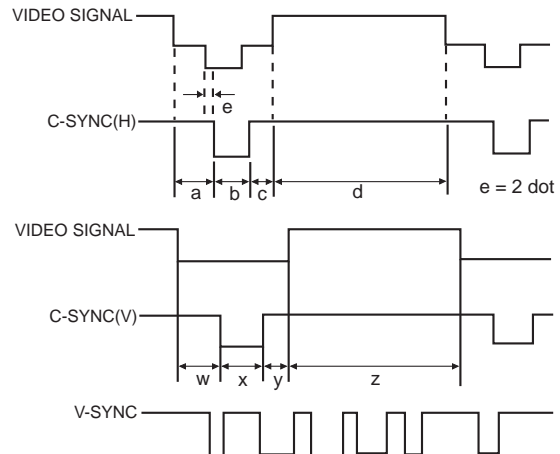

The following is a list of compatible VESA standards. Please note that this projector also accepts signals outside of the VESA standards.

NOTE

- Depending on the mode selected, the projector may clearly display images under 100 Hz.

	MODE	VIDEO		HSYNC										VSYNC												
				FRONT PORCH	SYNC	BACK PORCH	VIDEO PERIOD	1H (a+b+c+d)		1dot	1/H	1/dot	LEVEL	SYNC POLARITY	FRONT PORCH	SYNC	BACK PORCH	VIDEO PERIOD	1V (w+x+y+z)		1/V	LEVEL	SYNC POLARITY			
				a	b	c	d	dot	μs	ns	kHz	MHz		+/-	w	x	y	z	H	ms	Hz		+/-			
IBM	VGA	VESA Standard	640	350	0.7 Vp-p 75 Ω load	R · G · B	32	64	96	640	832	26.413	31.7	37.861	31.500	TTL	+	32	3	60	350	445	11.754	85.080	-	
			640	400			32	64	96	640	832	26.413	31.7	37.861	31.500		-	1	3	41	400	445	11.754	85.080	+	
		720	400	36			72	108	720	936	26.366	28.2	37.927	35.500	-		1	3	42	400	446	11.759	85.039	+		
		Industry Standard	640	480			8	96	40	640	800	31.778	39.7	31.469	25.175		-	2	2	25	480	525	16.683	59.940	-	
			640	480			16	40	120	640	832	26.413	31.7	37.861	31.500		-	1	3	20	480	520	13.735	72.809	-	
		VESA Standard	640	480			16	64	120	640	840	26.667	31.7	37.500	31.500		-	1	3	16	480	500	13.333	75.000	-	
	SVGA	VESA Guidelines	800	600			24	72	128	800	1,024	28.444	27.8	35.156	36.000		+	1	2	22	600	625	17.778	56.250	+	
			800	600			40	128	88	800	1,056	26.400	25.0	37.879	40.000		+	1	4	23	600	628	16.579	60.317	+	
		VESA Standard	800	600			56	120	64	800	1,040	20.800	20.0	48.077	50.000		+	37	6	23	600	666	13.853	72.188	+	
			800	600			16	80	160	800	1,056	21.333	20.2	46.875	49.500		+	1	3	21	600	625	13.333	75.000	+	
		Industry Standard	800	600			32	64	152	800	1,048	18.631	17.8	53.674	56.250		+	1	3	27	600	631	11.756	85.061	+	
		XGA	VESA Guidelines	1,024			768	8	176	56	1,024	1,264	28.151	22.3	35.522		44.900	+	0	4	20	768	817	23.000	43.479	+
				1,024			768	24	136	160	1,024	1,344	20.677	15.4	48.363		65.000	-	3	6	29	768	806	16.666	60.004	-
			VESA Standard	1,024			768	24	136	144	1,024	1,328	17.707	13.3	56.476		75.000	-	3	6	29	768	806	14.272	70.069	-
				1,024			768	16	96	176	1,024	1,312	16.660	12.7	60.023		78.750	+	1	3	28	768	800	13.328	75.029	+
				1,024			768	48	96	208	1,024	1,376	14.561	10.6	68.677		94.500	+	1	3	36	768	808	11.765	84.997	+
	1,152			864			64	128	256	1,152	1,600	14.815	9.3	67.500	108.000		+	1	3	32	864	900	13.333	75.000	+	
	SXGA	VESA Standard	1,280	960			96	112	312	1,280	1,800	16.667	9.3	60.000	108.000		+	1	3	36	960	1,000	16.667	60.000	+	
			1,280	1,024			48	112	248	1,280	1,688	15.630	9.3	63.981	108.000		+	1	3	38	1,024	1,066	16.661	60.020	+	
			1,280	1,024			16	144	248	1,280	1,688	12.504	7.4	79.976	135.000		+	1	3	38	1,024	1,066	13.329	75.025	+	
1,600			1,200	64	192	304	1,600	2,160	13.333	6.2	75.000	162.000	+	1	3	46	1,200	1,250	16.667	60.000	+					
APPLE	Macintosh™ IIfx	640	480	1 Vp-p max. 75 Ω load	R · G · B C.SYNC	64	64	96	640	864	28.5714	33.0688	35.0000	30.2400	TTL	-	3	3	39	480	525	15.00	66.67	-		
		640	480	78		62	116	640	896	28.595	31.914063	34.971149	31.334149	-		3	3	39	480	525	15.00	66.67	-			
	16" Monitor	832	624	0.7 Vp-p max. 75 Ω load		31	65	224	832	1,152	20.124	17.468	49.693	57.246		-	1	3	39	624	667	13.423	74.502	-		
	19" Monitor	1,024	768	35		96	173	1,024	1,328	16.650	12.538	60.0	79.76	-		3	3	30	768	804	13.387	74.70	-			
	21" Monitor	1,152	870	0.7 Vp-p 75 Ω load		R · G · B H.V.C.SYNC	36	128	140	1,152	1,456	14.5165	9.9701	68.8874		100.300	-	3	3	39	870	915	13.2826	75.2867	-	

NOTE

- This projector may not be able to display images from notebook computers in simultaneous (CRT/LCD) mode. Should this occur, turn off the LCD display on the notebook computer and output the display data in "CRT only" mode. Details on how to change display modes can be found in your notebook computer's operation manual.



Specifications

Product type	LCD Projector
Model	XG-NV5XE
Display method	LCD panel × 3, RGB optical shutter method
LCD panel	Panel size: 22.9 mm (0.9") (13.9 [H] × 18.5 [W] mm) Display method: Translucent TN liquid crystal panel Drive method: TFT (Thin Film Transistor) Active Matrix panel No. of dots: 786,432 dots (1,024 [H] × 768 [V])
Lens	1–1.5 × zoom lens, F2.0–2.6, f = 37–55.5 mm
Projection lamp	AC 150 W lamp
Brightness (ANSI lumen)	600 ANSI lumens
Contrast ratio	200:1
Audio output	2 W (monaural)
Computer RGB input signal	<i>Video signal</i> 15-PIN MINI D-SUB CONNECTOR (Computer Input Port 1, 2): RGB separate/composite sync/sync on green type analog input: 0–0.7 Vp-p, positive, 75 Ω terminated STEREO MINIJACK: AUDIO, 0.5 Vrms, more than 22 kΩ (stereo) HORIZONTAL SYNC. SIGNAL: TTL level (positive/negative) or composite sync (Apple only) VERTICAL SYNC. SIGNAL: Same as above
Computer control signal	9-pin D-sub male connector (RS-232C Input Port)
Speaker system	3 3/32" (8 cm) round
Rated voltage	AC 110–120/220–240 V
Input current	2.3 A/1.2 A
Rated frequency	50/60 Hz
Power consumption	255 W
Operating temperature	+5°C to +40°C
Storage temperature	–20°C to +60°C
Cabinet	Plastic
I/R carrier frequency	40 kHz
Laser pointer of "Power" remote control	<i>Wave length: 670 nm</i> <i>Max. output: 1 mW</i> Class II Laser Product
Dimensions (approx.)	229 × 121 × 310 mm (W × H × D) (main body only) 243.5 × 128 × 337 mm (W × H × D) (including an adjustment foot and projecting parts)
Weight (approx.)	4.8 kg
Supplied accessories	"Power" remote control, Simple presentation remote control, Four AA size batteries, Two AAA size batteries, Power cord (3 m), Computer cable (3 m), Computer audio cable (3 m), Macintosh adaptor, Mouse control serial cable (1 m), Mouse control cable for IBM PS/2 (1 m), Mouse control cable for Mac (17 cm), Remote mouse receiver, Extra air filter, Lens cap (attached), Carrying bag, CD-ROM, LCD projector operation manual, LCD projector quick reference, Sharp Advanced Presentation Software operation manual, Sharp Advanced Presentation Software quick reference, IrDA driver installation instruction sheet
Replacement parts	"Power" remote control (RRMCG1471CESA), Simple presentation remote control (RRMCG1480CESA), AA size batteries (UBATU0025GEZZ), AAA size batteries (UBATU0026GEZZ), Power cord, Computer cable (QCNW-5108CEZZ), Computer audio cable (QCNW-4870CEZZ), Macintosh adaptor (QPLGJ1512CEZZ), Mouse control serial cable (QCNW-5112CEZZ), Mouse control cable for IBM PS/2 (QCNW-5113CEZZ), Mouse control cable for Mac (QCNW-5114CEZZ), Remote mouse receiver (RUNTK0648CEN1), Air filter (PFILD0076CEZZ), Lens cap (GCOVH1307CESA), Carrying bag (GCASN0001CESA), CD-ROM (UDSKA-0002CE01), LCD projector operation manual (TINS-6584CEZZ), LCD projector quick reference (TINS-6645CEZZ), Sharp Advanced Presentation Software operation manual (TINS-6725CEZZ), Sharp Advanced Presentation quick reference (TINS-6688CEZZ), IrDA driver installation instruction sheet (TCAUZ3039CEZZ)

This SHARP projector uses LCD (Liquid Crystal Display) panels. These very sophisticated panels contain 786,432 pixels (× RGB) TFTs (Thin Film Transistors). As with any high technology electronic equipment such as large screen TVs, video systems and video cameras, there are certain acceptable tolerances that the equipment must conform to.

This unit has some inactive TFTs within acceptable tolerances which may result in illuminated or inactive dots on the picture screen. This will not affect the picture quality or the life expectancy of the unit.

Specifications are subject to change without notice.





Dimensions

Rear View

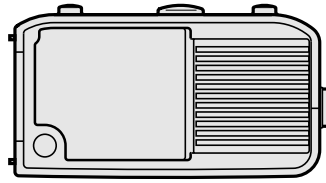

Top View

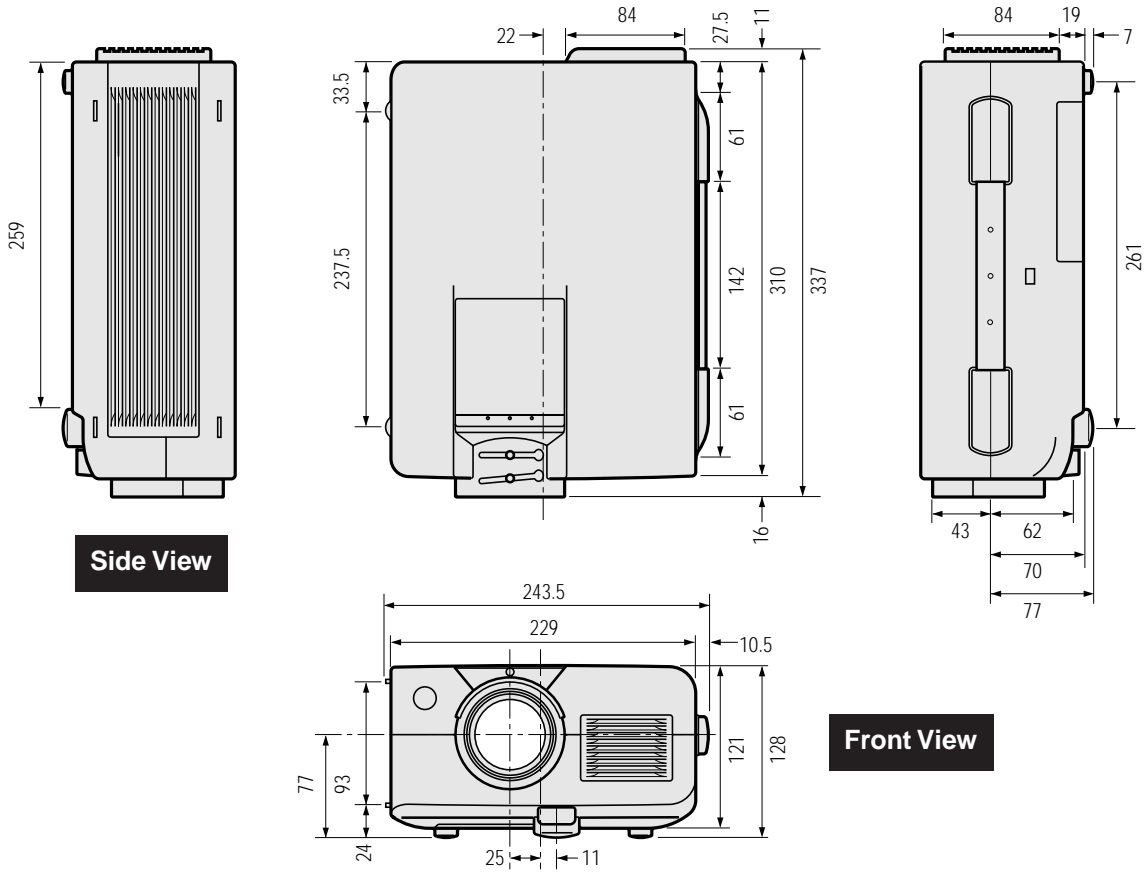

Side View

Front View

Bottom View

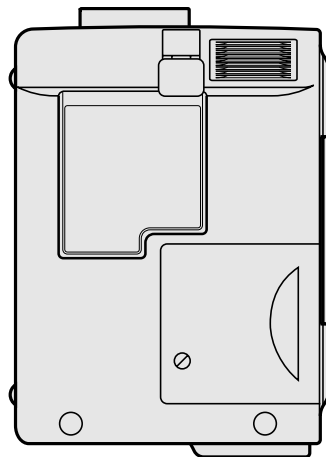

Units: mm





Guide to Effective Presentations

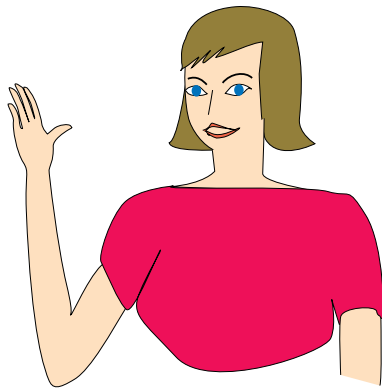

Electronic presentations are one of the most effective tools presenters can use to persuade an audience. There are several ways to enhance your presentation and maximise your effectiveness. The following are guidelines to help you create and deliver a dynamic presentation.

a. Types of Presentations

Computer Presentations

- To present basic information such as graphs, spreadsheets, documents and images, use word processing and spreadsheet applications.
- To convey more complex information and create more dynamic presentations which allow you to control the pace of your delivery, utilise software such as Astound®, Freelance®, Persuasion® or PowerPoint®.
- For high-end multimedia and interactive presentations, use software such as Macromedia Director®.

NOTE

- Astound®, Freelance®, Persuasion®, PowerPoint® and Macromedia Director® are trademarks of their respective companies.

Digital Cameras and Personal Digital Assistants (PDAs)

For highly compact and portable presentations, still cameras, digital video cameras, document cameras and PDAs are ideal for transferring data without cumbersome conversions.

Multimedia Presentations

You can integrate all of the above methods for a full multimedia presentation including computer applications and World Wide Web information.

Wireless Presentations

Use any IrDA/IrTranP compatible source such as a laptop, digital camera or PDA to project still images quickly and effortlessly without the use of cables.

b. Creative Presentations

Oftentimes presenters do not take advantage of the many subtle ways they can manipulate their electronic slides to more effectively persuade the audience.

Colour has a great effect on the audience during a presentation. When used correctly and legibly, studies show that background & foreground colours establish an emotional tone for a presentation, help viewers understand and retain information, and influence an audience to take a desired course of action.

Colour Considerations

- Choose legible colours.
- Text and graphics colours need sufficient contrast.
- Use darker colours for the background since a lighter background can create uncomfortable glare. (Yellow on black creates an ideal contrast.)

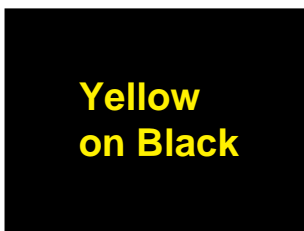
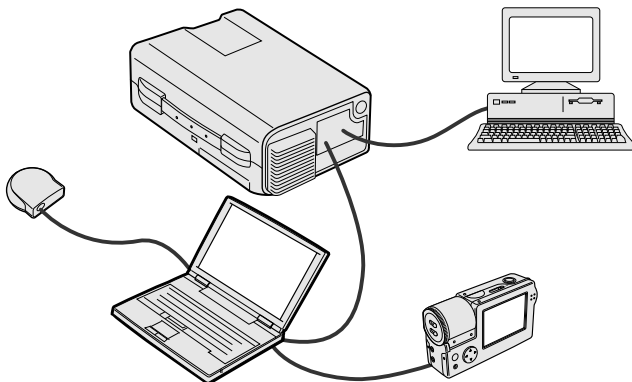
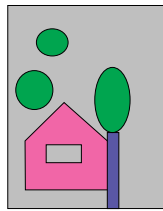
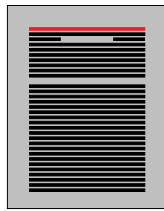
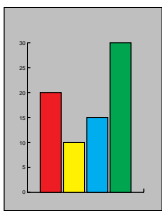

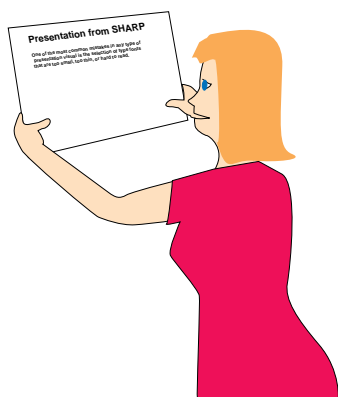
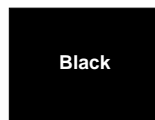
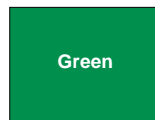
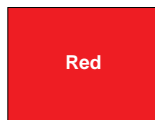

- Background colours can subconsciously affect the audience:

Red—increases viewers' pulse and breathing and encourages risk taking but can also be associated with financial loss.

Blue—has a calming and conservative affect on the audience but can also create boredom among corporate audiences that are often inundated with this background colour.

Green—stimulates interaction.

Black—conveys finality and certainty. Use it as a transitional colour between slides when moving from one idea to another.

- Foreground colours create a major impact on how well an audience understands and remembers a message.
 - Use one or two bright colours for emphasis.
 - Highlight important messages.
- The eye has a difficult time reading certain coloured text on certain coloured backgrounds. For example, text and background colours in red and green, and blue and black make for difficult viewing.
- Colourblind individuals may find it difficult to distinguish between red and green, brown and green, and purple and blue. Avoid using these colours together.

Fonts

- One of the most common mistakes in any type of presentation visual is the selection of type fonts that are too small, too thin, or too difficult to read.
- If you are not sure how well a given font will read on a screen at various sizes, try this: Draw a 15 cm × 20 cm box on a piece of paper and print out several lines of text inside the box with your computer printer at 300 or 600 dpi resolution. Vary the sizes of text to simulate headline, body and text call-outs for any charts or graphs. Hold the printout at arm's length. This is how your text will look on a 1.2 meters-wide screen at 3 meters, on a 2.3 meters-wide screen at 6.1 meters and a 3.7 meters-wide screen at 9.1 meters. If you cannot read the text easily, you should put less copy on your visuals or use larger typefaces.
- Design your visuals so that they are visible by the viewer in the last row.
- Nothing will ruin your presentation faster than misspelled words. Take the time to proofread and edit your work before your visuals become a permanent part of your presentation.
- Mixed case text is easier to read than text which is displayed in capital letters.
- Another important attribute of fonts is whether any particular face is serif or sans-serif. Serifs are small, usually horizontal cross strokes that are added to the end of a letter's main strokes. Because of their ability to coax the eye along the line of type, fonts with serifs are generally acknowledged to be more readable.

Sans-serif
Serif



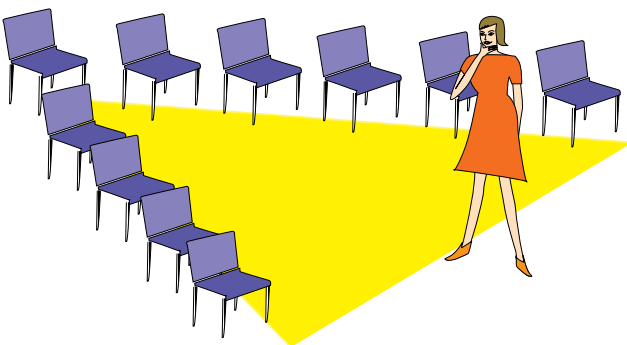
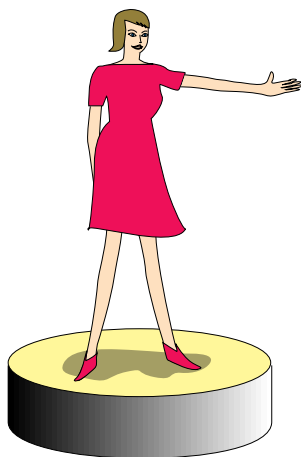
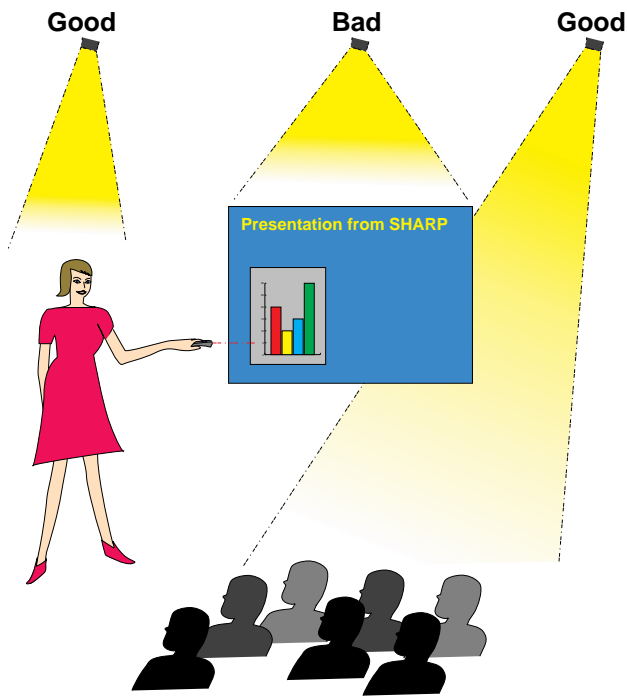

c. Set-Up

When giving a presentation, you need to set the stage both figuratively and literally for success. The way you set up a presentation room will have a great impact on the audience's perception of you and your message. By manipulating the placement and use of the following tools, you will improve the impact of your presentation.

Lighting—Good lighting is an important component of a successful presentation. You should strive to create an unequal distribution of light. An audience should always see as much of the presenter's face as possible, so most of the light should be focused on you. Because it is important for you to be able to read the audience's faces and body language, some light should be shed upon them. However, no light should shine on the screen.

Stage—When presenting on the same level surface that your audience is on, most people can only see the top one-third of your body. Therefore, it is recommended that when giving a presentation to an audience of 25 or more, you stand on a stage or platform. As more of your body is visible, the easier it is to communicate with an audience.

Podiums—The best presenters avoid podiums because they hide 75% of the body and restrict movement. However, many people feel more comfortable with a podium to hold their notes and hide their discomfort. If you must use a podium, angle it at 45 degrees to the audience so that you are not completely hidden.

Visuals—It is imperative that you make sure your visuals are large enough and projected far enough for the audience to see. Eight times the height of an image is the optimal viewing distance to read 24 point type. The bottom of a screen should be at least 1.8 meters above the floor.

Screen—The screen should always be in the centre of the room so that all audience members can see it. Because people read from left to right, you should always stand to the audience's left when discussing visuals.

Seating—Arrange seating according to the dynamics of your presentation. If the presentation is more than half-a-day, use classroom style seating—a chair and a desk. If you would like to encourage audience interaction, use chevron seating, angling the chairs into a "V" shape. When you have a very small audience, a "U" shaped arrangement will increase interchange.





d. Rehearsing & Delivery

- The best time to rehearse is the day or evening before, not a couple of hours before, and the best place to rehearse is in the actual room. Rehearsing a speech in a small office is not the same as standing up in front of 100 people in a hotel ballroom or classroom.
- Due to varying processor speeds of computers, practice your slide transitions for proper timing.
- Whenever possible, set up your equipment well in advance to allow adequate time to resolve any unexpected issues such as lighting, power, seating and audio.
- Thoroughly check every piece of equipment you bring along. Make sure you have fresh batteries in your remote controls and laptop computer. Fully charge your computer's battery before the presentation and connect your AC adaptor for added safety.
- Make sure you are completely familiar with the control panel on your projector and remote controls.
- If you are using a microphone, check it out before hand and walk around to see where you might have problems with feedback. Avoid standing in these problem areas during your presentation.

e. Presentation Tips

- Before beginning, visualise yourself delivering an outstanding presentation.
- Know your speech, memorising at least the first three minutes of your presentation will allow you to focus on your rhythm and pacing.
- Speak to early arrivals to help you build a rapport with the audience and make you feel more comfortable.
- Do not be overly dependent on your visuals by reciting what your audience is already reading. Know your material well enough to be able to deliver the presentation with ease. Use your visuals to emphasise keypoints.
- Be sure to project your voice clearly and use eye contact to maintain audience attention.
- Do not wait until half way through your presentation to get your point across. If you wait and try to create a "build-up", you may lose some of your audience along the way.
- Keep your audience's attention. As most people only focus for 15 to 20 minutes during a one hour presentation, it is important to recapture their attention periodically. Use phrases like, "This is critical to my point" or "This is absolutely fundamental" to remind them you are saying something they need to hear.

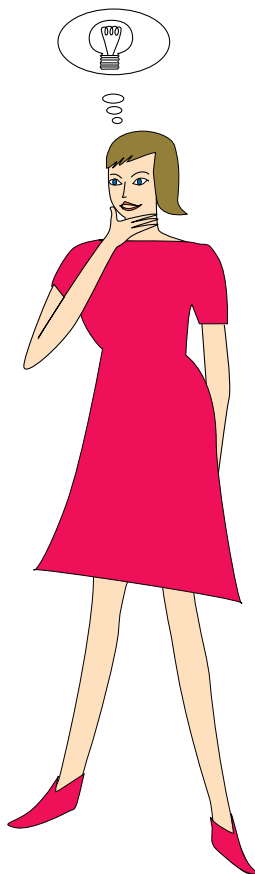



Glossary

Aspect ratio

Width and height ratio of an image. The normal aspect ratio of a computer image is 4 : 3. There are also wide images with an aspect ratio of 16 : 9 and 21 : 9.

ANSI lumen

Brightness unit established by the American National Standards Institute.

Auto sync

Optimises projected computer images by automatically adjusting certain characteristics.

Background

Initial setting image projected when no signal is being input.

Clock

Clock adjustment is used to adjust vertical noise when clock level is incorrect.

Compatibility

Ability to use with various image signal modes.

Composite sync

Signal combining horizontal and vertical sync pulses.

Digital keystone correction

Function to digitally correct a distorted image when the projector is set up at an angle.

Dot by dot mode

Mode that projects images in their native resolution.

Enlarge

Digitally zooms in on a portion of an image.

Fit to screen

Function to adjust an image without keeping a native aspect ratio other than 4 : 3, and project it in a 4 : 3 ratio.

Freeze

Function to freeze a moving image.

GUI

Graphical User Interface. User interface with graphics that allow easier operation.

Intelligent compression

High quality resizing of lower and higher resolution images to fit the projector's native resolution.

IrCOM

Function to transmit still images from a computer, hand-held PC or digital still camera via infrared communication for "Wireless Presentations".

IrDA

Standard protocol for wireless communication.

IrTranP

Standard format (protocol) for transmission of images.

PDF

Portable Document Format. Documentation format used to transfer text and images from the CD-ROM.

Phase

Phase shift is a timing shift between isomorphic signals with the same resolution. When phase level is incorrect, the projected image typically displays horizontal flicker.

Presentation tools

Helpful tools used to emphasise keypoints throughout a presentation.

RS-232C

Function to control the projector from the computer by using the RS-232C ports on the projector and computer.

Startup image

The image displayed when the projector is turned on.

Status function

Displays the settings of each adjustment item.

Sync

Synchronises the resolution and phase shift of two signals. When receiving an image with a resolution different from that of the computer, the projected image may be distorted.

Sync on green

Video signal mode of a computer which overlaps horizontal and vertical sync signal to green colour signal pin.

Wireless mouse control

Function to operate the mouse control of the computer with the supplied remote control.

XGA resolution

The resolution with 1,024 × 768 pixels that uses the signal of an IBM/AT compatible (DOS/V) computer.





Index

A	
AA size batteries	10
AC socket	18
ADJUSTMENT buttons	20
Air filter	35
ANSI lumen	42
Aspect ratio saving	30
Audio adjustment	24
Auto sync adjustment	26
AUTO SYNC button	26
Automatic power shutoff when receiving no signals	34
B	
Background selection	31
BACKLIGHT button	11
BLACK SCREEN button	29
C	
Carrying bag	38
Carrying handle	38
Ceiling-mount	13
Ceiling + Rear	32
Clock	25
Computer audio cable	15
COMPUTER AUDIO INPUT terminal	15
Computer cable	15
COMPUTER INPUT 1 port	15
COMPUTER INPUT 2 port	15
Cooling fan (Exhaust vent)	4
Cooling fan (Intake vent)	4
D	
Digital keystone correction	14
Dot by dot	28
E	
ENLARGE button	28
ENTER button	20
Extra air filter	35
F	
Fit to screen	30
Focus knob	18
Foot release	14
FREEZE button	28
G	
GUI	20
I	
Image memory	27
Image transmission software	22
INPUT SELECT button	19
Input signal confirmation	19
Intelligent compression	5
IrCOM	22
IrDA	6
IrTranP	44
K	
Kensington Security Standard connector	37
KEYSTONE button	14
L	
LAMP REPLACEMENT indicator	36
Language selection	23
LASER POINTER button	11
LEFT-CLICK button	11
Lens cap	38
M	
Macintosh adaptor	16
MAIN POWER switch	18
MENU button	20
MOUSE/ADJUSTMENT switch	11
Mouse control cable for IBM PS/2	15
Mouse control cable for Mac	15
Mouse control serial cable	15
MUTE button	19
O	
Opening image	31
P	
PDF	6
Phase	25
Picture adjustment	24
POWER buttons	18
Power cord	18
POWER indicator	18
Presentation tools	33
R	
Rear projection	12
Remote control	11
Remote control sensor	10
Remote mouse receiver	10
RIGHT-CLICK button	11
RS-232C port	17
S	
Speaker	8
Startup image	31
Status confirmation	34
Sync	26
Sync on green	39
T	
TEMPERATURE WARNING indicator	36
TOOLS button	33
V	
VOLUME buttons	19
W	
Wireless mouse control	10
X	
XGA resolution	5
Z	
Zoom knob	18



SHARP CORPORATION

Osaka, Japan

SHARP ELECTRONICS (EUROPE) GmbH

Sonninstraße 3, 20097 Hamburg, Germany

SHARP ELECTRONICS (U.K.) LTD.

Manchester, U.K.