

MIDI KEYBOARD CONTROLLER

PC-50

Owner's Manual

Thank you for purchasing the MIDI keyboard controller PC-50.

Before using this unit, carefully read the sections entitled: "USING THE UNIT SAFELY" and "IMPORTANT NOTES" (OWNER'S MANUAL pp. 2-4). These sections provide important information concerning the proper operation of the unit. Additionally, in order to feel assured that you have gained a good grasp of every feature provided by your new unit, Owner's manual should be read in its entirety. The manual should be saved and kept on hand as a convenient reference.

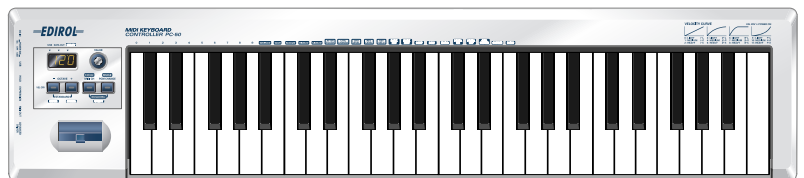

Copyright © 2005 ROLAND CORPORATION

All rights reserved. No part of this publication may be reproduced in any form without the written permission of ROLAND CORPORATION.

USING THE UNIT SAFELY

INSTRUCTIONS FOR THE PREVENTION OF FIRE, ELECTRIC SHOCK, OR INJURY TO PERSONS

About ⚠ WARNING and ⚠ CAUTION Notices

⚠ WARNING	Used for instructions intended to alert the user to the risk of death or severe injury should the unit be used improperly.
⚠ CAUTION	Used for instructions intended to alert the user to the risk of injury or material damage should the unit be used improperly. * Material damage refers to damage or other adverse effects caused with respect to the home and all its furnishings, as well to domestic animals or pets.

About the Symbols

	The ⚠ symbol alerts the user to important instructions or warnings. The specific meaning of the symbol is determined by the design contained within the triangle. In the case of the symbol at left, it is used for general cautions, warnings, or alerts to danger.
	The ⚡ symbol alerts the user to items that must never be carried out (are forbidden). The specific thing that must not be done is indicated by the design contained within the circle. In the case of the symbol at left, it means that the unit must never be disassembled.
	The ● symbol alerts the user to things that must be carried out. The specific thing that must be done is indicated by the design contained within the circle. In the case of the symbol at left, it means that the power-cord plug must be unplugged from the outlet.

ALWAYS OBSERVE THE FOLLOWING

⚠ WARNING

- Before using this unit, make sure to read the instructions below, and the Owner's Manual.

- Do not open (or modify in any way) the unit or its AC adaptor.

- Do not attempt to repair the unit, or replace parts within it (except when this manual provides specific instructions directing you to do so). Refer all servicing to your retailer, the nearest Roland Service Center, or an authorized Roland distributor, as listed on the "Information" page.

- Never use or store the unit in places that are:
 - Subject to temperature extremes (e.g., direct sunlight in an enclosed vehicle, near a heating duct, on top of heat-generating equipment); or are
 - Damp (e.g., baths, washrooms, on wet floors); or are
 - Humid; or are
 - Exposed to rain; or are
 - Dusty; or are
 - Subject to high levels of vibration.

- Make sure you always have the unit placed so it is level and sure to remain stable. Never place it on stands that could wobble, or on inclined surfaces.

- Do not excessively twist or bend the power cord, nor place heavy objects on it. Doing so can damage the cord, producing severed elements and short circuits. Damaged cords are fire and shock hazards!

⚠ WARNING

- Use only the specified AC adaptor, and make sure the line voltage at the installation matches the input voltage specified on the AC adaptor's body. Other AC adaptors may use a different polarity, or be designed for a different voltage, so their use could result in damage, malfunction, or electric shock.





- Do not allow any objects (e.g., flammable material, coins, pins); or liquids of any kind (water, soft drinks, etc.) to penetrate the unit.

- Immediately turn the power off, remove the AC adaptor from the outlet, and request servicing by your retailer, the nearest Roland Service Center, or an authorized Roland distributor, as listed on the "Information" page when:
 - The AC adaptor or the power-supply cord has been damaged; or
 - If smoke or unusual odor occurs
 - Objects have fallen into, or liquid has been spilled onto the unit; or
 - The unit has been exposed to rain (or otherwise has become wet); or
 - The unit does not appear to operate normally or exhibits a marked change in performance.





- In households with small children, an adult should provide supervision until the child is capable of following all the rules essential for the safe operation of the unit.

- Protect the unit from strong impact. (Do not drop it!)









WARNING

- Do not force the unit's power-supply cord to share an outlet with an unreasonable number of other devices. Be especially careful when using extension cords—the total power used by all devices you have connected to the extension cord's outlet must never exceed the power rating (watts/amperes) for the extension cord. Excessive loads can cause the insulation on the cord to heat up and eventually melt through. 
- Before using the unit in a foreign country, consult with your retailer, the nearest Roland Service Center, or an authorized Roland distributor, as listed on the "Information" page. 
- Batteries must never be recharged, heated, taken apart, or thrown into fire or water. 

- DO NOT play a CD-ROM disc on a conventional audio CD player. The resulting sound may be of a level that could cause permanent hearing loss. Damage to speakers or other system components may result. 

CAUTION

- The unit and the AC adaptor should be located so their location or position does not interfere with their proper ventilation. 
- Always grasp only the output plug or the body of the AC adaptor when plugging into, or unplugging from, this unit or an outlet. 
- At regular intervals, you should unplug the AC adaptor and clean it by using a dry cloth to wipe all dust and other accumulations away from its prongs. Also, disconnect the power plug from the power outlet whenever the unit is to remain unused for an extended period of time. Any accumulation of dust between the power plug and the power outlet can result in poor insulation and lead to fire. 
- Try to prevent cords and cables from becoming entangled. Also, all cords and cables should be placed so they are out of the reach of children. 
- Never climb on top of, nor place heavy objects on the unit. 

CAUTION

- Never handle the AC adaptor body, or its output plugs, with wet hands when plugging into, or unplugging from, an outlet or this unit. 
- Before moving the unit, disconnect the AC adaptor and all cords coming from external devices. 
- Before cleaning the unit, turn off the power and unplug the AC adaptor from the outlet. 
- Whenever you suspect the possibility of lightning in your area, disconnect the AC adaptor from the outlet. 
- If used improperly, batteries may explode or leak and cause damage or injury. In the interest of safety, please read and observe the following precautions. 

 - Carefully follow the installation instructions for batteries, and make sure you observe the correct polarity. 
 - Avoid using new batteries together with used ones. In addition, avoid mixing different types of batteries.
 - Remove the batteries whenever the unit is to remain unused for an extended period of time.
 - If a battery has leaked, use a soft piece of cloth or paper towel to wipe all remnants of the discharge from the battery compartment. Then install new batteries. To avoid inflammation of the skin, make sure that none of the battery discharge gets onto your hands or skin. Exercise the utmost caution so that none of the discharge gets near your eyes. Immediately rinse the affected area with running water if any of the discharge has entered the eyes.
 - Never keep batteries together with metallic objects such as ballpoint pens, necklaces, hairpins, etc.
- Used batteries must be disposed of in compliance with whatever regulations for their safe disposal that may be observed in the region in which you live. 

Important Notes

In addition to the items listed under “USING THE UNIT SAFELY” on page 2-3, please read and observe the following:

Power Supply

- Do not connect this unit to same electrical outlet that is being used by an electrical appliance that is controlled by an inverter (such as a refrigerator, washing machine, microwave oven, or air conditioner), or that contains a motor. Depending on the way in which the electrical appliance is used, power supply noise may cause this unit to malfunction or may produce audible noise. If it is not practical to use a separate electrical outlet, connect a power supply noise filter between this unit and the electrical outlet.
- The AC adaptor will begin to generate heat after long hours of consecutive use. This is normal, and is not a cause for concern.
- The use of an AC adaptor is recommended as the unit’s power consumption is relatively high. Should you prefer to use batteries, please use the alkaline type.
- When installing or replacing batteries, always turn off the power on this unit and disconnect any other devices you may have connected. This way, you can prevent malfunction and/or damage to speakers or other devices.
- Before connecting this unit to other devices, turn off the power to all units. This will help prevent malfunctions and/or damage to speakers or other devices.

Placement

- This device may interfere with radio and television reception. Do not use this device in the vicinity of such receivers.
- Noise may be produced if wireless communications devices, such as cell phones, are operated in the vicinity of this unit. Such noise could occur when receiving or initiating a call, or while conversing. Should you experience such problems, you should relocate such wireless devices so they are at a greater distance from this unit, or switch them off.
- Do not expose the unit to direct sunlight, place it near devices that radiate heat, leave it inside an enclosed vehicle, or otherwise subject it to temperature extremes. Excessive heat can deform or discolor the unit.
- When moved from one location to another where the temperature and/or humidity is very different, water droplets (condensation) may form inside the unit. Damage or malfunction may result if you attempt to use the unit in this condition. Therefore, before using the unit, you must allow it to stand for several hours, until the condensation has completely evaporated.
- Do not allow objects to remain on top of the keyboard. This can be the cause of malfunction, such as keys ceasing to produce sound.

Maintenance

- For everyday cleaning wipe the unit with a soft, dry cloth or one that has been slightly dampened with water. To remove stubborn dirt, use a cloth impregnated with a mild, non-abrasive detergent. Afterwards, be sure to wipe the unit thoroughly with a soft, dry cloth.
- Never use benzine, thinners, alcohol or solvents of any kind, to avoid the possibility of discoloration and/or deformation.

Repairs and Data

- Please be aware that all data contained in the unit’s memory may be lost when the unit is sent for repairs. Important data should always be written down on paper. During repairs, due care is taken to avoid the loss of data. However, in certain cases (such as when circuitry related to memory itself is out of order), we regret that it may not be possible to restore the data, and Roland assumes no liability concerning such loss of data.

Additional Precautions

- Please be aware that the contents of memory can be irretrievably lost as a result of a malfunction, or the improper operation of the unit. To protect yourself against the risk of losing important data, we recommend that you periodically write down important data you have stored in the unit's memory on paper.
- Unfortunately, it may be impossible to restore the contents of data that was stored in the unit's memory once it has been lost. Roland Corporation assumes no liability concerning such loss of data.
- Use a reasonable amount of care when using the unit's buttons, sliders, or other controls; and when using its jacks and connectors. Rough handling can lead to malfunctions.
- When connecting / disconnecting all cables, grasp the connector itself—never pull on the cable. This way you will avoid causing shorts, or damage to the cable's internal elements.
- To avoid disturbing your neighbors, try to keep the unit's volume at reasonable levels (especially when it is late at night).
- When you need to transport the unit, package it in the box (including padding) that it came in, if possible. Otherwise, you will need to use equivalent packaging materials.
- Use only the specified expression pedal (EV-5; sold separately). By connecting any other expression pedals, you risk causing malfunction and/or damage to the unit.

Handling CD-ROMs

- Avoid touching or scratching the shiny underside (encoded surface) of the disc. Damaged or dirty CD-ROM discs may not be read properly. Keep your discs clean using a commercially available CD cleaner.
- * Microsoft and Windows are registered trademarks of Microsoft Corporation.
 - * The screen shots in this document are used in compliance with the guidelines of the Microsoft Corporation.
 - * Windows[®] is known officially as: "Microsoft[®] Windows[®] operating system."
 - * Apple and Macintosh are registered trademarks of Apple Computer, Inc.
 - * Mac OS is a trademark of Apple Computer, Inc.
 - * Pentium is a registered trademark of Intel Corporation.
 - * All product names mentioned in this document are trademarks or registered trademarks of their respective owners.
 - * OMS is a registered trademark of Opcode Systems, Inc.
 - * FreeMIDI is a trademark of Mark of the Unicorn, Inc.

Contents

Contents of the package	8
Quick page reference table	9
Names of things and what they do	10
Panel	10
Side Panel.....	11
Inserting batteries	12

Setup **13**

Getting Connected and Installing Drivers (Windows).....	14
Installing the driver	14
Windows XP users	14
Windows 2000 users	19
Windows Me/98 users	23
Setting the driver—Specifying the MIDI output destination.....	24
Windows XP users	24
Windows 2000 / Me users	25
Windows 98 users	26
Getting Connected and Installing Drivers (Macintosh).....	27
Mac OS X users	27
Installing the driver.....	27
Setting the driver	28
Mac OS 9 users	30
Setting the PC-50 to OS 9 mode	30
Installing the driver.....	31
Setting the driver	32
Input / output devices.....	36

Operation **37**

Basic connections and MIDI flow	38
USB connections with your computer—Transmitting MIDI messages to your software....	38
Basic connections.....	38
MIDI flow	38
USB connections with your computer—Using the PC-50 as a MIDI interface.....	39
Basic connections.....	39
MIDI flow	39
When using a MIDI connection—Transmitting MIDI messages to an external MIDI sound module, etc. ...	40
Basic connections.....	40
MIDI flow	40

Use MIDI functionality 41

How to switch modes	41
PLAY mode	41
UTILITY mode	42
Play	43
Features Useful When Playing	44
Setting the MIDI Transmit Channel	45
Selecting Sounds on a Sound Module—Transmitting Program Change / Bank Select Messages	46
Transmitting a program change message	47
Transmitting a bank select LSB message	48
Transmitting a bank select MSB message	49
Starting/stopping playback—Transmitting start/stop messages	50
Starting playback—Transmitting a start message	51
Stopping playback—Transmitting a stop message	52
Continuing playback from the current location—Transmitting a continue message	53
Transmitting messages to an external MIDI sound module	54
Transmitting a poly mode on message	54
Transmitting a mono mode on message	55
Transmitting a portamento on message	56
Transmitting a portamento off message	57
Transmitting a GM2 system on message	58
Transmitting a reset message	59
Transmitting the value of a specific parameter	60

System settings 61

Set the system settings	61
F8 CLOCK ON / OFF	62
F8 CLOCK DEFAULT TEMPO	62
VELOCITY CURVE	63
KEY VELOCITY	64
MIDI I/F MODE	65
VALUE ENCODER	66
FACTORY RESET	68
Set the ADVANCED DRIVER	69

Appendices 71**Troubleshooting 72**

Problems related to the USB driver	72
Problems when using the PC-50	77

MIDI implementation..... 79**Main specifications..... 83****INDEX..... 84**

Contents of the package

The PC-50 includes the following items. When you open the package, first make sure that all items are included. If any are missing, contact the dealer where you purchased the PC-50.

- **MIDI Keyboard Controller**

- PC-50**

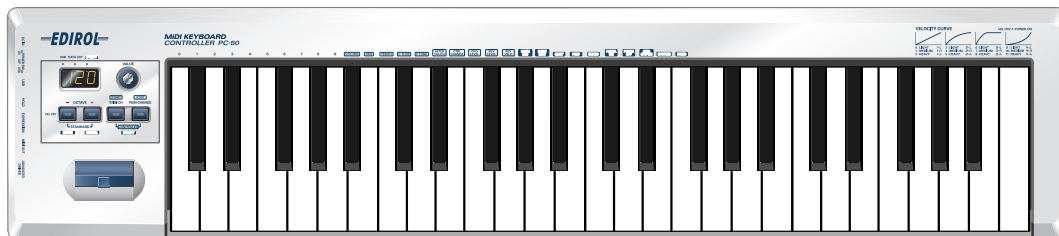

- **USB cable**

- Use this to connect the USB connector of your computer with the USB connector of the PC-50. For details on connections and driver installation, refer to Setup. (**Windows**→p. 14/**Macintosh**→p. 27)

- * Please use only the included USB cable. If you require a replacement due to loss or damage, please contact a "EDIROL/Roland Service Center" listed in the "Information" section at the end of this manual.*

- **CD-ROM**

- This contains drivers for use with the PC-50.

- **Owner's Manual**

- This is the manual you are reading. Please keep it on hand for reference.

Quick page reference table

Before you begin	Names of things and what they do	p. 10
	Driver Installation	p. 14, p. 27
	Input/output device settings	p. 36
	Basic connections and MIDI flow	p. 38
	System settings	p. 61
Using the MIDI functionality	Explanation of the PC-50's operating modes	p. 41
	Play	p. 43
	Features Useful When Playing	p. 44
	Pitch Bend	p. 44
	Modulation	p. 44
	Hold	p. 44
	Expression	p. 44
	Octave Shift	p. 44
	Setting the MIDI Transmit Channel	p. 45
	Selecting Sounds on a Sound Module	p. 46
	Transmitting a program change message	p. 47
	Transmitting a bank select LSB message	p. 48
	Transmitting a bank select MSB message	p. 49
	Starting/stopping playback of the performance data of a sequencer or other device	p. 50
	Starting playback—Transmitting a start message	p. 51
	Stopping playback—Transmitting a stop message	p. 52
	Continuing playback from the current location—Transmitting a continue message	p. 53
Transmitting messages to an external MIDI sound module.	p. 54	
Transmitting a poly mode on message	p. 54	
Transmitting a mono mode on message	p. 55	
Transmitting a portamento on message	p. 56	
Transmitting a portamento off message	p. 57	
Transmitting a GM2 system on message	p. 58	
Transmitting a reset message	p. 59	
Transmitting the value of a specific parameter	p. 60	
Making system settings	F8 CLOCK	p. 62
	VELOCITY CURVE	p. 63
	KEY VELOCITY	p. 64
	MIDI I/F MODE	p. 65
	VALUE ENCODER	p. 66
	FACTORY RESET	p. 68
	ADVANCED DRIVER	p. 69
Trouble Shooting	Problems related to the USB driver	p. 72
	Problems when using the PC-50	p. 77

Names of things and what they do

Panel

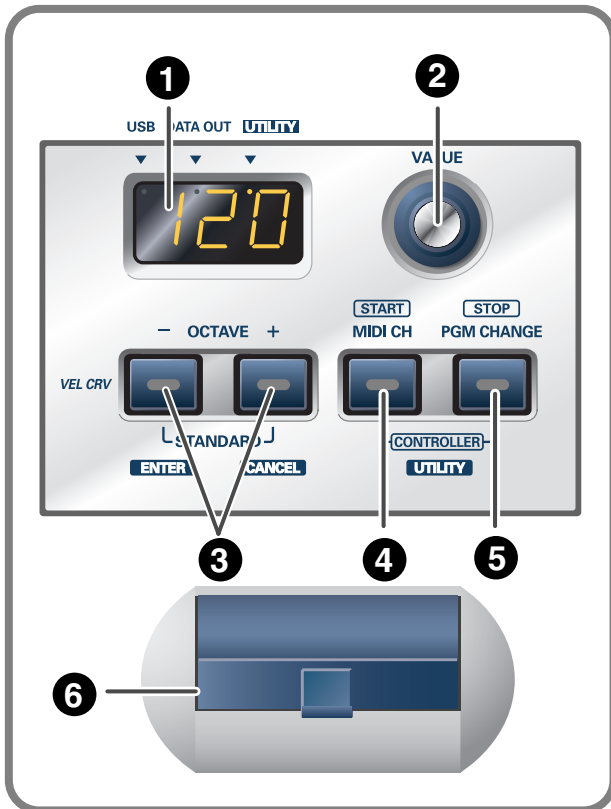

* If you do not operate or play the PC-50 for a certain length of time, the display and buttons will automatically dim.

1 Display

Indicates the current status and various other information.

Number	Operating a controller will cause its current value to appear in the display for a time.
USB	Lights if the PC-50 is connected to your computer via USB.
DATA OUT	This will blink when MIDI messages are transmitted via USB or MIDI OUT.
UTILITY	This will blink in UTILITY mode (p. 42).

2 VALUE Encoder Knob

Use this knob to specify the MIDI transmit channel or the program change number. In **CONTROLLER mode** (p. 50), this knob controls the parameter you specify (p. 60). Turning the encoder specifies the value.

3 OCTAVE -/+ Button

Press [**OCTAVE -/+**] button to shift the pitch of the keyboard up or down in steps of an octave. When not in **PLAY mode** (p. 41), use these buttons to return to confirm setting item (the [**ENTER**] button) or to cancel the setting and return to **PLAY mode** (the [**CANCEL**] button).

4 MIDI CH Button

Specifies the transmission channel (**Current channel** (p. 45)) for the keyboard and bender. In **CONTROLLER mode** (p. 50) this transmits a Start message (FAh).

5 PGM CHANGE Button

Transmits program change messages on the current channel. In **CONTROLLER mode** (p. 50) this transmits a Stop message (FCh).

6 Pitch Bend/Modulation Lever

This lever can be used to modify the pitch or apply vibrato.

Side Panel

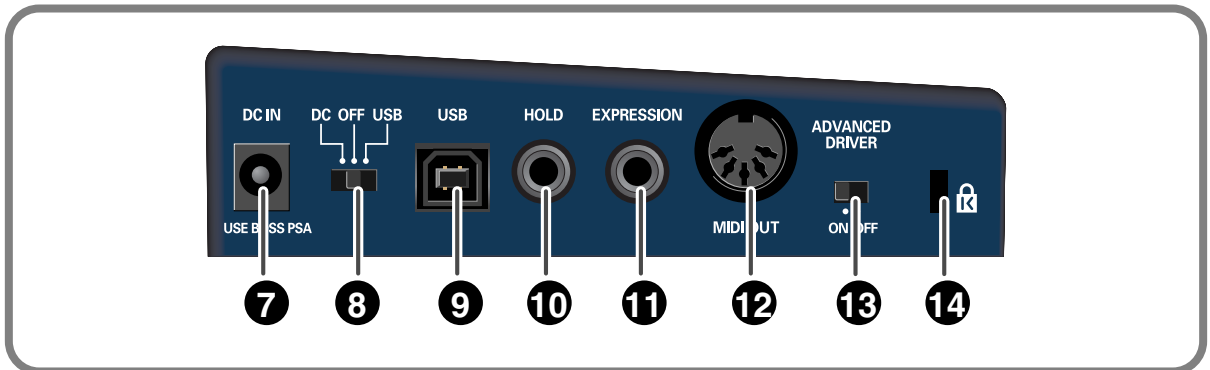

7 AC Adaptor Jack

Connect the AC adaptor (PSA series; sold separately) to this jack. Insert the plug firmly so it won't get unplugged accidentally.

8 Power Switch

DC	Power-on status when using the AC adaptor or batteries * If the AC adaptor is connected and batteries are inserted, the power supplied by the AC adaptor is used. If you disconnect the AC adaptor, the power supplied by the batteries is used.
OFF	Power is off
USB	Power on using a USB cable (when not using the AC adaptor) * USB(=BUS power) can be used when the PC-50 is connected to your computer via a USB cable. In this case, the power will be supplied from your computer via the USB cable. To use the PC-50 with bus power, set the power switch to USB. * For some computers, the PC-50 may not operate if bus power is used. In this case, use the AC adaptor (sold separately) or batteries.

9 USB Connector

Use this when connecting the PC-50 to your computer via a USB cable.

10 Hold Jack

Connect a pedal switch to this jack and use it as a hold pedal.

11 Expression Jack

Connect an expression pedal to this jack and use it to control tone or volume in real time.

12 MIDI OUT Connector

These can be connected to the MIDI connectors of other MIDI devices to transmit MIDI messages.

13 ADVANCED DRIVER Switch

This switches the driver operation mode. Normally, you will leave this **ON**.

In MAC OS X, you can also use the PC-50 with the ADVANCED DRIVER switch OFF.

(→Set the **ADVANCED DRIVER** (p. 69))

14 Security Slot

<http://www.kensington.com/>

Inserting batteries

- 1 Make sure that the power switch is turned off.
- 2 Remove the battery cover located on the rear panel of the PC-50.
 - * When turning the unit upside-down, get a bunch of newspapers or magazines, and place them under the four corners or at both ends to prevent damage to the buttons and controls. Also, you should try to orient the unit so no buttons or controls get damaged.
 - * When turning the unit upside-down, handle with care to avoid dropping it, or allowing it to fall or tip over.
- 3 Insert four AA batteries into the battery compartment, making sure to observe the correct polarity (+/-).
 - * Use alkaline batteries.
 - * Do not mix new batteries with partially used batteries, and do not mix batteries of differing types.
- 4 Close the battery cover.

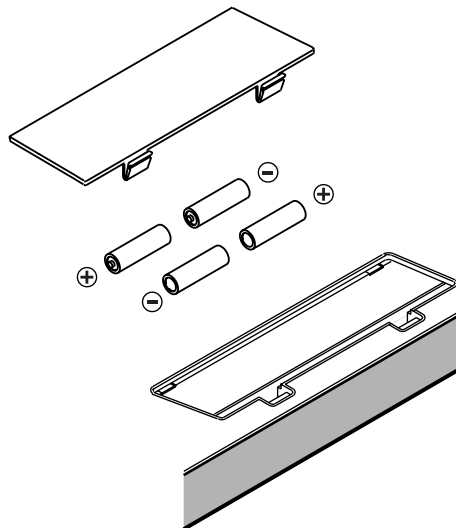

When the batteries run low, the display will indicate "Lo." When this message appears, replace the batteries as soon as possible.

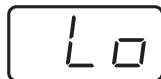

Setup

This section explains how to install the drivers needed for connecting the PC-50 to a computer, and make the necessary settings.

Getting Connected and Installing Drivers (Windows)	(p. 14)
Getting Connected and Installing Drivers (Macintosh)	(p. 27)

What is a driver?

A “**driver**” is software that transfers data between the PC-50 and application software running on your computer, when your computer and the PC-50 are connected by a USB cable. The driver sends data from your application to the PC-50, and from the PC-50 to your application.

Getting Connected and Installing Drivers (Windows)

Installing the driver

The installation procedure will differ depending on your system. Please proceed to one of the following sections, depending on the system you use.

- Windows XP users (p. 14)
- Windows 2000 users (p. 19)
- Windows Me/98 users (p. 23)

Windows XP users

- 1 Disconnect all USB cables except for a USB keyboard and USB mouse (if used).
- 2 Open the **System Properties** dialog box.
 1. Click the Windows **start** menu, and from the menu, select **Control Panel**.
 2. In “Pick a category,” click “Performance and Maintenance.”
 3. In “or pick a Control Panel icon,” click the **System** icon.
- 3 Click the **Hardware** tab, and then click [**Driver Signing**].
Open the **Driver Signing Options** dialog box.



- 4 Make sure that “What action do you want Windows to take?” is set to “Ignore.”
If it is set to “Ignore,” simply click [**OK**].
If it is not set to “Ignore,” make a note of the current setting (“Warn” or “Block”). Then change the setting to “Ignore” and click [**OK**].

NOTE

You must log on using a user name with an administrative account type (e.g., Administrator). For details on user accounts, please consult the system administrator of your computer.

MEMO

Depending on how your system is set up, the **System** icon may be displayed directly in the **Control Panel** (the Classic view). In this case, double-click the **System** icon.

MEMO

What you actually see on your computer screen may be different, depending on your computing environment and the operating system you’re using.

MEMO

If you changed “What action do you want Windows to take?” you must restore the previous setting after you have installed the driver. (→If you changed “What action do you want Windows to take?” (p. 17))

5 Click **[OK]** to close the **System Properties** dialog box.

6 Exit all currently running software.

Also close any open windows. If you are using virus checking or similar software, be sure to exit it as well.

7 Prepare the CD-ROM.

Insert the CD-ROM into the CD-ROM drive of your computer.

8 Click the Windows **start** button. From the menu that appears, select **“Run...”**

The **“Run...”** dialog box will appear.

9 Specify the name of the file you want to execute.

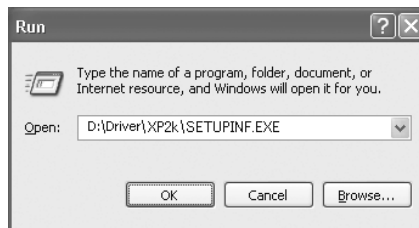

Enter the following into the **“Open”** field, and click **[OK]**.

(drive name): \Driver\XP2k\SETUPINF.EXE

** In the explanatory example shown here, the drive name is given as **“D:.”** The drive name **“D:”** may be different for your system. Specify the drive name of your CD-ROM drive.*

The **SetupInf** dialog box will appear.

You are now ready to install the driver.

10 Set the PC-50's **ADVANCED DRIVER Switch** to the **ON** position.

** Installation cannot proceed as described below if the switch is turned OFF.*

11 Use the USB cable to connect the PC-50 to your computer.

1. Set the PC-50's power switch to the **OFF** position.

2. Use the USB cable to connect the PC-50 to your computer.

MEMO

If the screen indicates **“Windows can perform the same action each time you insert a disk or connect a device with this kind of file,”** click **[Cancel]**.

MEMO

To check the drive name
Click the **Start** button, and choose **My Computer** from the menu that appears. In the window that appears, check the drive name of the CD-ROM drive  into which you inserted the CD-ROM in step 7. The drive name is the (D:) or (E:) displayed by the CD-ROM drive.

NOTE

Once the connections have been completed, turn on power to your various devices in the order specified. By turning on devices in the wrong order, you risk causing malfunction and/or damage to speakers and other devices.

- 12 Set the PC-50's **power switch** to the **USB** position.

Near the task bar, your computer will indicate **“Found New Hardware.”**
Please wait.

- 13 The **Found New Hardware Wizard** will appear.

Select **“Install from a list or specific location (Advanced),”** and click **[Next]**.

- 14 The screen will indicate **“Please choose your search and installation options.”**

Select **“Don't search. I will choose the driver to install,”** and click **[Next]**.

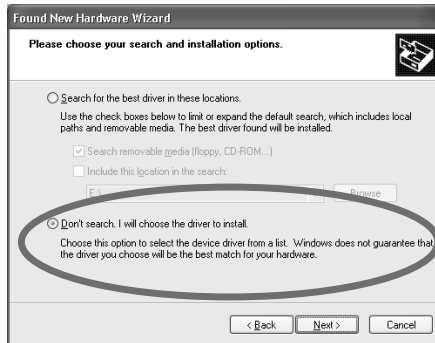

- 15 Make sure that the **“Model”** field indicates **“EDIROL PC-50,”** and click **[Next]**.

Driver installation will begin.

MEMO

This unit is equipped with a protection circuit. A brief interval (a few seconds) after power up is required before the unit will operate normally.

MEMO

If the **Found New Hardware Wizard** asks you whether you want to connect to Windows Update, choose **“No”** and then click **[Next]**.

If the **“What action do you want Windows to take?”** (Step 4) (p. 14) setting was not set to **“Ignore,”** a **“Hardware Installation”** dialog box will appear.

A dialog box with a “!” symbol will appear.

1. Click **[Continue Anyway]**.
2. Continue the installation.

A dialog box with a “x” symbol will appear.

1. Click **[OK]**.
2. When the **“Found New Hardware Wizard”** appears, click **[Finish]**.
3. Return to **step 1** (p. 14) and re-install the driver from the beginning of the procedure.

- 16 The **Insert Disk** dialog box will appear.

Click **[OK]**.

- 17 The **Files Needed** dialog box will appear.

Input the following into the **“Copy files from”** field, and click **[OK]**.

(drive name):\Driver\XP2k.

MEMO

The **Insert Disk** dialog may not appear. In that case, proceed to the next step.

MEMO

Specify the drive name of your CD-ROM drive.

If the “**What action do you want Windows to take?**” (Step 4) (p. 14) setting was not set to “**Ignore,**” a “**Hardware Installation**” dialog box will appear.

A dialog box with a “!” symbol will appear.

1. Click [**Continue Anyway**].
2. Continue the installation.

18 The screen will indicate “**Completing the Found New Hardware Wizard.**” Make sure that the “**Model**” field indicates “**EDIROL PC-50,**” click [**Finish**]. Wait until “**Found New Hardware**” appears near the taskbar.

19 When driver installation has been completed, the **System Settings Change** dialog box will appear. Click [**Yes**]. Windows will restart automatically.

MEMO

If the **System Settings Change** dialog box does not appear, restart Windows from the **Start** menu.

■ If you changed “What action do you want Windows to take?”

If you changed the **Driver Signing Options** (p. 14), restore the original setting after Windows restarts.

1. Log on to Windows using the user name of an administrative account (e.g., Administrator).
2. Click the Windows **start** menu, and from the menu that appears, select **Control Panel**.
3. In “**Pick a category,**” click “**Performance and Maintenance.**”
4. In “**or pick a Control Panel icon,**” click the **System** icon. The **System Properties** dialog box will appear.
5. Click the **Hardware** tab, and then click [**Driver Signing**]. The **Driver Signing Options** dialog box will appear.
6. Return the **What action do you want Windows to take?** setting to the original setting (either “**Warn**” or “**Block**”), and click [**OK**].
7. Click [**OK**]. The **System properties** dialog box will close.

MEMO

Depending on how your system is set up, the **System** icon may be displayed directly in the **Control Panel** (classic view). In this case, double-click the **System** icon.

This completes installation of the driver.

Next, we recommend that you give priority to background services on your computer, so MIDI processing will be as smooth as possible. (→“**Giving priority to background services**” (p. 18))

■ Giving priority to background services

In Windows XP, make settings to give priority to background services. To ensure that MIDI processing occurs smoothly, use the following procedure to make settings.

- 1 ▶ Open the **System Properties** dialog box.
 1. Click the Windows **start** menu, and from the menu, select **Control Panel**.
 2. In “Pick a category,” click “**Performance and Maintenance**.”
 3. In “or pick a Control Panel icon,” click the **System** icon.
- 2 ▶ Click the **Advanced** tab.
- 3 ▶ At the right of the **Performance** field, click [**Settings**].
The **Performance Options** dialog box will appear.
- 4 ▶ Click the **Advanced** tab.
- 5 ▶ In the **Processor Scheduling** field, select “**Background services**,” and click [**OK**].

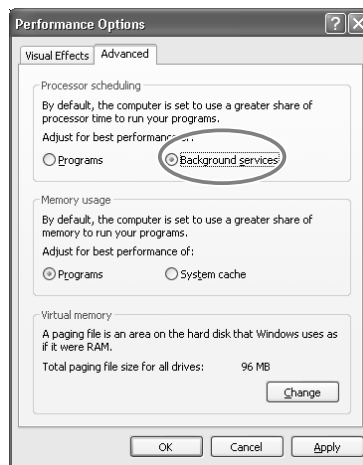

- 6 ▶ In the **System Properties** dialog box, click [**OK**].
The **System Properties** dialog box will close.

Next, make device settings.

(→ “Setting the driver—Specifying the MIDI output destination” (p. 24))

MEMO

Depending on how your system is set up, the **System** icon may be displayed directly in the **Control Panel** (the Classic view). In this case, double-click the **System** icon.

Windows 2000 users

- 1 Disconnect all USB cables except for a USB keyboard and USB mouse (if used).
- 2 Open the **System Properties** dialog box.
 1. Click the Windows **Start** menu, and from the menu that appears, select **Settings | Control Panel**.
 2. In **Control Panel**, double-click the **System** icon.

- 3 Click the **Hardware** tab, and then click [**Driver Signing**].

The **Driver Signing Options** dialog box will appear.

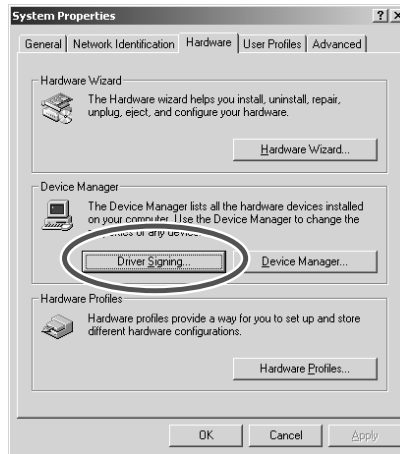

- 4 Make sure that “**File signature verification**” is set to “**Ignore.**”
If it is set to “**Ignore,**” simply click [**OK**].
If it is not set to “**Ignore,**” make a note of the current setting (“Warn” or “Block”). Then change the setting to “**Ignore**” and click [**OK**].
- 5 Click [**OK**] to close the **System Properties** dialog box.
- 6 Exit all currently running software.
Also close any open windows. If you are using virus checking or similar software, be sure to exit it as well.
- 7 Prepare the CD-ROM.
Insert the CD-ROM into the CD-ROM drive of your computer.
- 8 Click the Windows **Start** menu. From the menu that appears, select “**Run...**”
The “**Run...**” dialog box will appear.

MEMO

Log on to Windows as a user with administrative privileges (such as Administrator).

MEMO

If you changed “**File signature verification,**” you must restore the previous setting after you have installed the driver. (→“**If you changed “File signature verification”**” (p. 21))

- 9 In the dialog box that appears, input the following into the “Open” field, and click [OK].

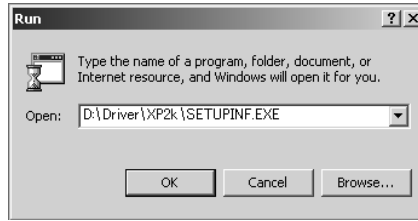

(drive name):\Driver\XP2k\SETUPINF.EXE

* In the explanatory example shown here, the drive name is given as “D:.” The drive name “D:” may be different for your system. Specify the drive name of your CD-ROM drive.

The **SetupInf** dialog box will appear.
You are now ready to install the driver.

- 10 Set the PC-50’s **ADVANCED DRIVER Switch** to the **ON** position.

* Installation cannot proceed as described below if the switch is turned OFF.

- 11 Use the USB cable to connect the PC-50 to your computer.

1. Set the PC-50’s power switch to the **OFF** position.
2. Use the USB cable to connect the PC-50 to your computer.

- 12 Set the PC-50’s **power switch** to the **USB** position.

Near the task bar, your computer will indicate “**Found New Hardware.**” Please wait.

If the “**File signature verification**” (Step 4) (p. 19) setting was not set to “**Ignore,**” a “**Digital Signature Not Found**” dialog box will appear.

If “File signature verification” is set to “Warn”

1. Click [Yes].
2. Continue the installation.

If “File signature verification” is set to “Block”

1. Click [OK].
2. When the “**Found New Hardware Wizard**” appears, click [Finish].
3. Return to **step 1** (p. 19) and re-install the driver from the beginning of the procedure.

- 13 The **Insert Disk** dialog box will appear.

Click [OK].

MEMO

To check the drive name

In the Windows desktop, double-click the **My Computer** icon. In the window that appears, check the drive name of the CD-ROM drive into which you inserted the CD-ROM in step 7.

The drive name is the (D:) or (E:) displayed by the CD-ROM drive .

NOTE

Once the connections have been completed, turn on power to your various devices in the order specified. By turning on devices in the wrong order, you risk causing malfunction and/or damage to speakers and other devices.

MEMO

This unit is equipped with a protection circuit. A brief interval (a few seconds) after power up is required before the unit will operate normally.

MEMO

If the **Insert Disk** dialog box does not appear, proceed to the next step.

14 The **Files Needed** dialog box will appear.

Input the following into the “**Copy files from**” field, and click [OK].

(drive name): \Driver\XP2K

MEMO

Specify the drive name of your CD-ROM drive.

If the “**File signature verification**” (Step 4) (p. 19) setting was not set to “**Ignore**,” a “**Digital Signature Not Found**” dialog box will appear.

1. Click [Yes].
2. Continue the installation.

15 The screen will indicate “**Completing the Found New Hardware Wizard.**”

Make sure that the “**Model**” field indicates “**EDIROL PC-50**,” click [Finish].

16 The **System Settings Change** dialog box may appear.

Click [Yes]. Windows will restart automatically.

MEMO

If the **System Settings Change** dialog box does not appear, restart Windows from the **Start** menu.

■ **If you changed “File signature verification”**

If you changed the “**File signature verification**” (p. 19) setting, restore the original setting after Windows restarts.

1. After Windows restarts, log in to Windows as a user with **administrative privileges**, (such as **Administrator**).
2. In the Windows desktop, right-click the **My Computer** icon, and from the menu that appears, select **Properties**. The **System Properties** dialog box will appear.
3. Click the **Hardware** tab, and then click [Driver Signing]. The **Driver Signing Options** dialog box will appear.
4. Return the “**File signature verification**” setting to the original setting (either “Warn” or “Block”), and click [OK].
5. Click [OK]. The **System Properties** dialog box will close.

This completes installation of the driver.

Next, we recommend that you give priority to background services on your computer, so MIDI processing will be as smooth as possible.(→**Giving priority to background services** (p. 22))

■ Giving priority to background services

In Windows 2000, make settings to give priority to background services. To ensure that MIDI processing occurs smoothly, use the following procedure to make settings.

- 1 Click the Windows **Start** menu, and from the menu that appears, select **Settings** | **Control Panel**. In **Control Panel**, double-click the **System** icon.
- 2 Click the **Advanced** tab.
- 3 At the right of the **Performance** field, click [**Performance Options**].
The **Performance Options** dialog box will appear.

- 4 In the **Application response** field, choose “**Background services**” and click [**OK**].

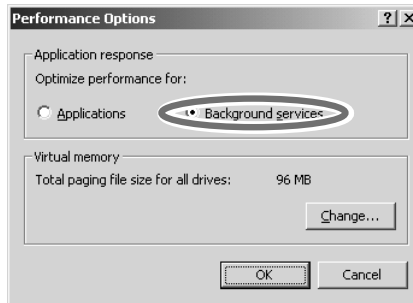

- 5 Click [**OK**] to close the **System Properties** dialog box.

Next, make device settings.

(→“**Setting the driver—Specifying the MIDI output destination**” (p. 24))

Windows Me/98 users

- 1 With the PC-50 disconnected, start up Windows.
Disconnect all USB cables except for a USB keyboard and USB mouse (if used).
- 2 Exit all currently running software.
Also close any open windows. If you are using virus checking or similar software, be sure to exit it as well.
- 3 Prepare the CD-ROM.
Insert the CD-ROM into the CD-ROM drive of your computer.
- 4 Click the Windows **Start** menu. From the menu that appears, select **Run....**
The “**Run...**” dialog box will appear.

- 5 In the dialog box that appears, input the following into the “**Open**” field, and click [**OK**].

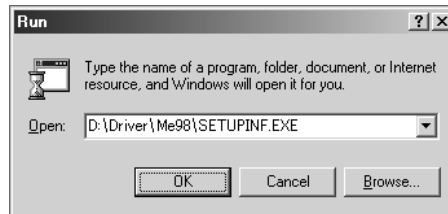

(drive name): \Driver\Me98\SETUPINF.EXE

* In the explanatory example shown here, the drive name is given as “**D:**.” The drive name “**D:**” may be different for your system. Specify the drive name of your CD-ROM drive.

The **SetupInf** dialog box will appear.
You are now ready to install the driver.

- 6 Set the PC-50’s **ADVANCED DRIVER Switch** to the **ON** position.
* Installation cannot proceed as described below if the switch is turned **OFF**.
- 7 Use the USB cable to connect the PC-50 to your computer.
 1. Set the PC-50’s power switch to the **OFF** position.
 2. Use the USB cable to connect the PC-50 to your computer.
- 8 Set the PC-50’s **power switch** to the **USB** position.
- 9 In the **SetupInf** dialog box, click [**OK**].

Next, make device settings.

(→“**Setting the driver—Specifying the MIDI output destination**” (p. 24))

MEMO

To check the drive name

In the Windows desktop, double-click the **My Computer** icon. In the window that appears, check the drive name of the CD-ROM drive into which you inserted the CD-ROM in step 3. The drive name is the (D:) or (E:) displayed by the CD-ROM drive .

NOTE

Once the connections have been completed, turn on power to your various devices in the order specified. By turning on devices in the wrong order, you risk causing malfunction and/or damage to speakers and other devices.

MEMO

This unit is equipped with a protection circuit. A brief interval (a few seconds) after power up is required before the unit will operate normally.

MEMO

If a message recommends that you restart Windows, restart Windows as directed.

Setting the driver—Specifying the MIDI output destination

Windows XP users

Make the following settings so that you can use the MIDI functionality of the PC-50. For details on connections, refer to “**Basic connections and MIDI flow**” (p. 38).

- 1 Open **Control Panel**.

Click the Windows **start** menu, and from the menu that appears, select **Control Panel**.

- 2 Open the **Sounds and Audio Devices Properties** dialog box.

In “**Pick a category**” click “**Sound, Speech, and Audio Devices.**” Next, in “**or pick a Control Panel icon,**” click the **sounds and Audio Devices** icon.

- 3 Click the **Audio** tab.

- 4 For **MIDI music playback**, click the ▼ located at the right of [**Default device**], and select the MIDI device from the list that appears.

If you want to use Media Player to play a sound module connected to the PC-50’s MIDI OUT connector, select **EDIROL PC-50 MIDI OUT**.

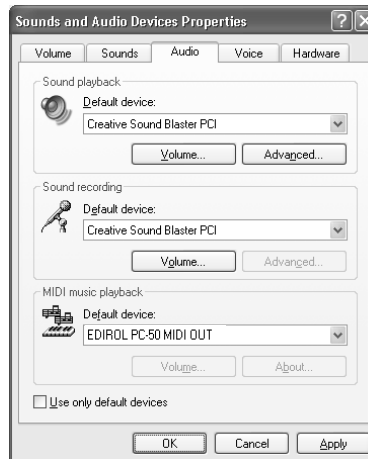

- 5 Close the **Sounds and Audio Devices Properties** dialog box.
Click [**OK**] to complete the settings.

MEMO

Depending on how your system is set up, the **Sounds and Audio Devices** icon may be displayed directly in the **Control Panel** (the Classic view). In this case, double-click the **Sounds and Audio Devices** icon.

MEMO

Select the appropriate MIDI device for your system. You do not necessarily have to select **EDIROL PC-50 MIDI OUT**.

MEMO

For details on the PC-50’s output devices, refer to “**Input / output devices**” (p. 36).

This completes settings for using the PC-50 with an software that uses the standard Windows device settings, such as Media Player.

For details on how to make these settings, refer to the owner’s manual for your software.

For details on the PC-50’s output devices, refer to “**Input / output devices**” (p. 36).

Windows 2000 / Me users

Make the following settings so that you can use the MIDI functionality of the PC-50. For details on connections, refer to “**Basic connections and MIDI flow**” (p. 38).

- 1 Open **Control Panel**.
Click the Windows **Start** menu, and from the menu that appears, select **Settings | Control Panel**.
- 2 Open the **Sounds and Multimedia Properties**.
In **Control Panel**, double-click the **Sounds and Multimedia** icon to open the **Sounds and Multimedia Properties** dialog box.
- 3 Click the **AUDIO** tab.
- 4 For **MIDI music playback**, click the ▼ located at the right of [**Preferred device**], and select the MIDI device from the list that appears.

If you want to use Media Player to play a sound module connected to the PC-50's MIDI OUT connector, select **EDIROL PC-50 MIDI OUT**.

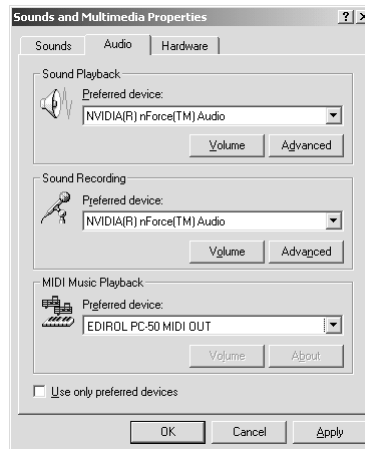

- 5 Close the **Sounds and Multimedia Properties** dialog box.
Click [**OK**] to complete the settings.

This completes settings for using the PC-50 with an software that uses the standard Windows device settings, such as Media Player.

For details on how to make these settings, refer to the owner's manual for your software.

For details on the PC-50's output devices, refer to “**Input / output devices**” (p. 36).

MEMO

If the **Sound and Multimedia** icon is not displayed, click “**Show all control panel options**” in the frame at the left.

MEMO

Select the appropriate MIDI device for your system. You do not necessarily have to select **EDIROL PC-50 MIDI OUT**.

MEMO

For details on the PC-50's output devices, refer to “**Input / output devices**” (p. 36).

Windows 98 users

Make the following settings so that you can use the MIDI functionality of the PC-50. For details on connections, refer to “**Basic connections and MIDI flow**” (p. 38).

- 1 Open **Control Panel**.
Click the Windows **Start** menu, and from the menu that appears, select **Settings | Control Panel**.
- 2 Open the **Multimedia Properties** dialog box.
In **Control Panel**, double-click the **Multimedia** icon to open the “**Multimedia Properties**” dialog box.
- 3 Click the **MIDI** tab.

- 4 Set “**MIDI output.**”
Select [**Single instrument**], and select the MIDI device from the list that appears, and click [**Apply**].

If you want to use Media Player to play a sound module connected to the PC-50’s MIDI OUT connector, select **EDIROL PC-50 MIDI OUT**.

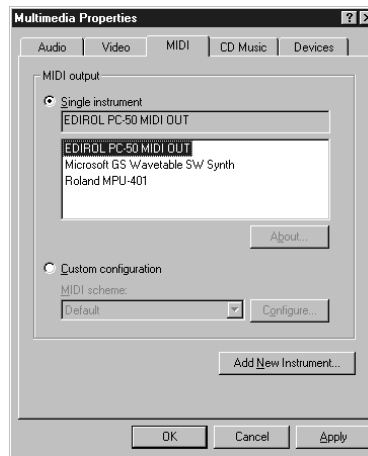

- 5 Close the **Multimedia Properties** dialog box.
Click [**OK**] to complete the settings.

MEMO

Select the appropriate MIDI device for your system. You do not necessarily have to select **EDIROL PC-50 MIDI OUT**.

MEMO

For details on the PC-50’s output devices, refer to “**Input / output devices**” (p. 36).

This completes settings for using the PC-50 with an software that uses the standard Windows device settings, such as Media Player.

For details on how to make these settings, refer to the owner’s manual for your software.

For details on the PC-50’s output devices, refer to “**Input / output devices**” (p. 36).

Getting Connected and Installing Drivers (Macintosh)

The installation procedure will differ depending on your system. Please proceed to one of the following sections, depending on the system you use.

- Mac OS X users..... (p. 27)
- Mac OS 9 users (p. 30)

Mac OS X users

Installing the driver



If the **“Authenticate”** dialog box appears during the installation, input the password and click **“OK.”**

- 1 Disconnect all USB cables other than those for your keyboard and mouse, and restart your Macintosh.
- 2 Prepare the CD-ROM.
Insert the CD-ROM into the CD-ROM drive of your computer.
- 3 In the **Driver (Mac OS X)** folder of the CD-ROM, double-click **PC50USBDriver.pkg.**
** A message such as **“This Installer package needs to...”** may appear.
Click **“Continue.”***
- 4 The display will indicate **“Welcome to the EDIROL PC-50 Driver Installer.”** Click **[Continue].**
- 5 The display will indicate **“Select a Destination.”**
Click the drive in which the operating system is installed to select it, and then click **[Continue].**
- 6 The display will indicate **“Easy Install.”**
Click **[Install]** or **[Upgrade].**
- 7 The display will indicate **“Installing this software requires you to restart your computer when the installation is done.”**
Click **[Continue Installation].**
- 8 The display will indicate **“The software was successfully installed.”**
Click **[Restart]** to restart your computer.
This completes installation of the PC-50 driver.
Next, make MIDI device settings. (→ **Setting the driver** (p. 28))



What you actually see on your computer screen may be different, depending on your computing environment and the operating system you're using.



Select your startup disk as the drive.

Setting the driver

Mac OS settings

Make the following settings so that you can use the MIDI functionality of the PC-50. For details on connections, refer to **“Basic connections and MIDI flow”** (p. 38).

- 1 Set the PC-50’s **ADVANCED DRIVER Switch** to the **ON** position.
* *Installation cannot proceed as described below if the switch is turned OFF.*
- 2 Use the USB cable to connect the PC-50 to your computer.
 1. Set the PC-50’s power switch to the **OFF** position.
 2. Use the USB cable to connect the PC-50 to your computer.
- 3 Set the PC-50’s **power switch** to the **USB** position.
- 4 Open the **Applications** folder of your Macintosh hard disk. In the **Utilities** folder, double-click **Audio MIDI Setup** to open the **Audio MIDI Setup**.

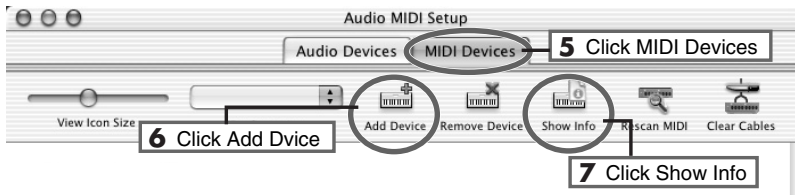

- 5 Click the **MIDI Devices** tab.
- 6 Click **“Add Device”** twice.
Two **new external MIDI devices** will appear.
- 7 Specify a name for each **new external device**.
 1. Click **Show Info**.
 2. Enter the name in the **Device Name** field. Enter the following for each **new external device**.

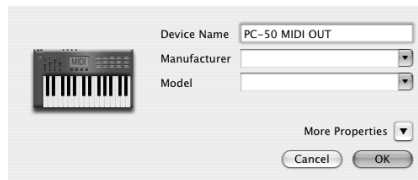

	First	Second
Device Name	PC-50 MIDI OUT	PC-50

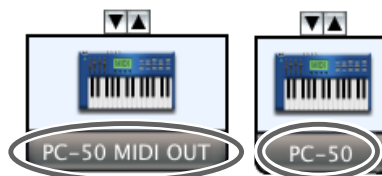

NOTE

Once the connections have been completed, turn on power to your various devices in the order specified. By turning on devices in the wrong order, you risk causing malfunction and/or damage to speakers and other devices.

NOTE

Connect the cable to the USB connector of the Macintosh itself, not to the USB connector of the keyboard.

MEMO

Mac OS X v10.2 was used in producing the screen shot shown at left.

MEMO

This unit is equipped with a protection circuit. A brief interval (a few seconds) after power up is required before the unit will operate normally.

MEMO

For details on MIDI device settings, refer to the owner’s manual for the software you are using.

MEMO

Mac OS X v10.2 was used in producing the screen shot shown at left.

- 8 Connect the ▼ and ▲ symbols (which signify the outputs and inputs) of the **EDIROL PC-50** icon to those of the **New External Device** icon by using the mouse to drag between them.

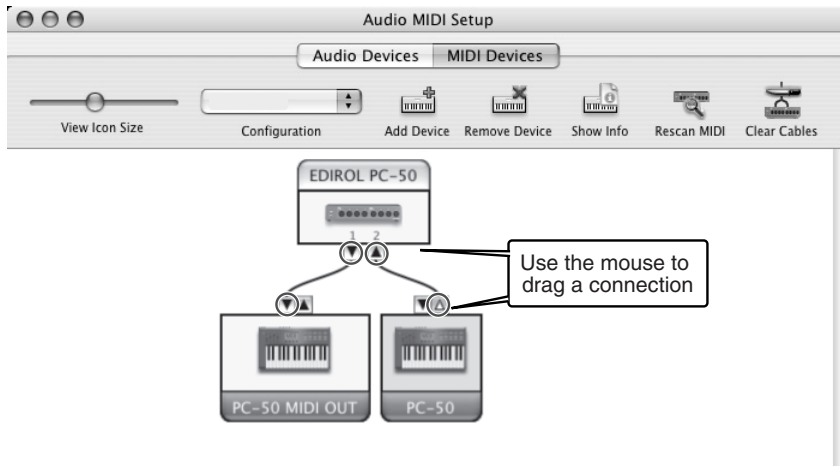

MEMO

Mac OS X v10.2 was used in producing the screen shot shown at left.

- 9 Close the **Audio MIDI Setup**.

Next, make software settings.

■ Software settings

- 1 Make MIDI device settings on your sequencer software.
For details on the PC-50's output devices, refer to "**Input / output devices**" (p. 36).

MEMO

For details on MIDI device settings, refer to the owner's manual for the software you are using.

■ When using the PC-50 with your software

Before using the PC-50 with your software, please note the following points.

- Use the USB cable to connect the PC-50 to your computer before you start up your software.
- Do not disconnect the USB cable from the PC-50 while your software is running.
- Quit your software before you disconnect the USB cable from the PC-50.
- Turn off the Sleep function of your Macintosh.
- The PC-50 will not operate in the Mac OS X Classic environment. Use the PC-50 when the Classic environment is not running.

Mac OS 9 users

Setting the PC-50 to OS 9 mode

If you're using the PC-50 with Mac OS 9, you must set the PC-50 to OS 9 mode, you must use the following procedure to set the PC-50 to OS 9 mode.

* You must make this setting before you install the driver.

- 1 Slide the PC-50's **power switch** to the **OFF** position.
- 2 Switch **ON** the **ADVANCED DRIVER switch** (located on the side panel).

- 3 While holding down the **[PGM CHANGE]** button, slide the **power switch** to the **USB** position.

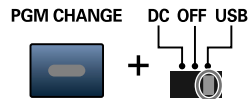

- 4 The display will indicate "**PC-50**" and then "**OS9.**"



The PC-50 is now set to OS 9 mode.

MEMO

If the screen indicates: "Software needed for the USB device "EDIROL PC-50" is not available. Would you like to look for the software on the Internet?" → click [Cancel].

■ Canceling the OS 9 mode setting

Before you use the PC-50 with an operating system other than Mac OS 9 (i.e., Windows or Mac OS X), you must use the following procedure to cancel the OS 9 mode setting.

1. Slide the PC-50's **power switch** to the **OFF** position.
2. Switch **ON** the **ADVANCED DRIVER switch** (located on the side panel).

3. While holding down the **[MIDI CH]** button, slide the **power switch** to the **USB** position.

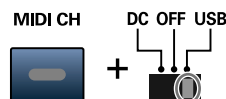

4. The display will indicate "**PC-50.**" (The "OS9" indication will not appear.)

The OS 9 mode setting has been cancelled.

Installing the driver

Use either OMS or FreeMIDI as the MIDI driver.

The included **PC-50 driver** is an add-on module for using the PC-50 with OMS or FreeMIDI.

* Either **OMS** or **FreeMIDI** must be installed in your Macintosh, as appropriate for the sequencer software you are using.

If a PC-50 is already connected to your Macintosh when you install the driver, a message like the following will appear when the Macintosh is started up. Perform the steps described below as appropriate for the message that is displayed.

If the screen indicates:

“Software needed for the USB device “EDIROL PC-50” is not available. Would you like to look for the software on the Internet?” → click **[Cancel]**.

If the screen indicates:

“The software needed to use the USB device “PC-50” cannot be found. Please refer to the device documentation to install the necessary software.” → click **[OK]**.

Use the following procedure to install the PC-50 driver.

- 1 Exit all currently running software.
If you are using a virus checker or similar software, be sure to exit this as well.
- 2 Prepare the CD-ROM. Insert the CD-ROM into the CD-ROM drive.
- 3 Double-click the **PC-50 Driver-E Installer** icon (found in the **Driver E (Mac OS 9,8)** folder of the CD-ROM) to start up the installer.
- 4 Verify the **Install Location**, and click **[Install]**.
- 5 If a message like the following is displayed, click **[Continue]**.
The other currently running softwares will exit, and installation will continue.
- 6 A dialog box will indicate **Installation was successful**.
Click **[Restart]** to restart your Macintosh.

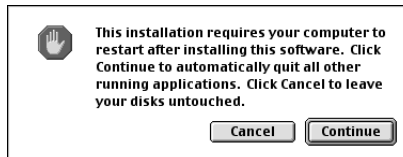

MEMO

OMS can be found in the **OMS 2.3.8 E** folder within the **OMS (Mac OS 9,8)** folder of the CD-ROM. If you would like to know more about OMS, refer to **OMS_2.3_Mac.pdf** which can be found in the same folder.

MEMO

If you install OMS or FreeMIDI after installing the PC-50 driver, you must install the PC-50 driver once again.

MEMO

Disconnect the PC-50 from the Macintosh before you perform the installation.

NOTE

The installation location will be shown differently depending on your system. Make sure that you have selected the startup disk for the system you are currently using.

Setting the driver

If you are using FreeMIDI, proceed to “**FreeMIDI settings**” (p. 34).

■ OMS settings

- 1 Set the PC-50's **ADVANCED DRIVER Switch** to the **ON** position.
** Installation cannot proceed as described below if the switch is turned OFF.*

- 2 Use the USB cable to connect the PC-50 to your computer.
 1. Set the PC-50's power switch to the **OFF** position.
 2. Use the USB cable to connect the PC-50 to your computer.

- 3 Set the PC-50's **power switch** to the **USB** position.

** Connect the cable to the USB connector of the Macintosh itself, not to the USB connector of the keyboard.*

- 4 From the CD-ROM, drag the **Driver E (Mac OS 9,8) - OMS Setting** folder into the **Opcode - OMS Applications** folder on the hard disk of your Macintosh to copy it there.



- 5 In the **Opcode - OMS Applications** folder where you installed OMS, double-click **OMS Setup** to start it up.



- 6 If a dialog box like the one shown here appears, click **[Turn It Off]**. A **confirmation** dialog box will then appear, so click **[OK]**.

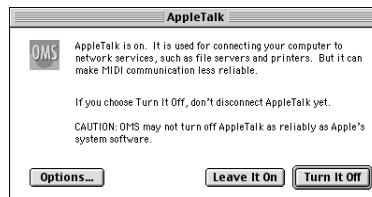

- 7 The **Create a New Studio Setup** dialog box will appear. Click **[Cancel]**.
 If you accidentally clicked **[OK]**, click **[Cancel]** in the next screen.



NOTE

Once the connections have been completed, turn on power to your various devices in the order specified. By turning on devices in the wrong order, you risk causing malfunction and/or damage to speakers and other devices.

MEMO

This unit is equipped with a protection circuit. A brief interval (a few seconds) after power up is required before the unit will operate normally.

MEMO

If you are using the PC-50 in conjunction with other MIDI devices, make settings as described in **Readme_E.htm** located in the **Driver E (Mac OS 9,8)** folder of the CD-ROM.

MEMO

We recommend that you turn off **AppleTalk**, by selecting Chooser from the Apple menu.

- 8 Choose “**Open**” from the **File** menu.

From the **OMS Setting** folder that you copied in **step 4**, select the **PC-50** file, and click [**Open**].

A screen like the one shown here will appear.

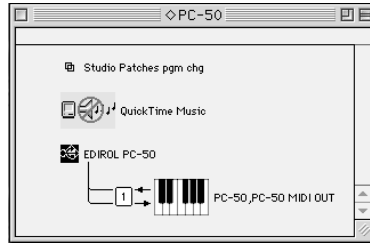

- 9 From the **Edit** menu, select **OMS MIDI Setup**.

In the **OMS MIDI Setup** dialog box that appears, check **Run MIDI in background**, and click [**OK**].

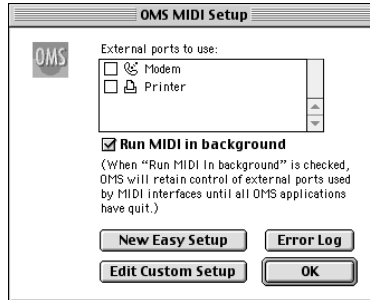

- 10 From the **File** menu, choose **Make Current**.

* *If you are unable to select **Make Current**, it has already been applied, and you may continue to the next step.*

A diamond mark (<>) indicated the settings are enabled.

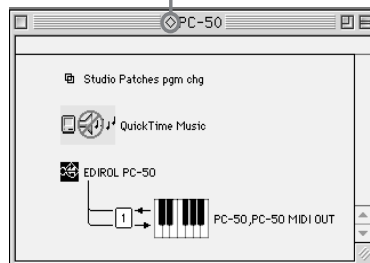

- 11 Verify that MIDI transmission and reception can be performed correctly. From the **Studio** menu, choose **Test Studio**.

- 12 Try playing the keyboard of the PC-50. If the arrow beside number **1** in the diagram at right blinks, the settings have been made correctly.

When you move the mouse cursor near the MIDI connector icon, the cursor will change to a  shape. If a MIDI sound module is connected to the PC-50's MIDI OUT connector, click the MIDI connector icon shown in the diagram at the right. If you hear sound, the settings have been made correctly.

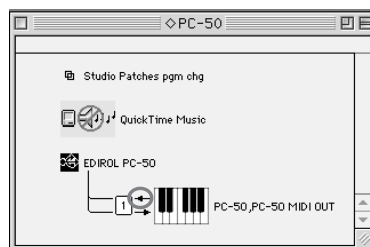

MEMO

For details on the PC-50's output devices, refer to “**Input / output devices**” (p. 36).

13 Exit **OMS Setup**.

From the **File** menu, choose **[Exit]**. If the **AppleTalk confirmation** dialog box appears, click **[OK]** to close the dialog box.

This completes installation of the driver.

Next, make MIDI device settings in your sequencer or other software.

For details on how to make these settings, refer to the owner's manual for your software.

For details on the PC-50's input / output devices, refer to "**Input / output devices**" (p. 36).

■ FreeMIDI settings

- 1** Set the PC-50's **ADVANCED DRIVER Switch** to the **ON** position.

* *Installation cannot proceed as described below if the switch is turned OFF.*

- 2** Use the USB cable to connect the PC-50 to your computer.

1. Set the PC-50's power switch to the **OFF** position.
2. Use the USB cable to connect the PC-50 to your computer.

- 3** Set the PC-50's **power switch** to the **USB** position.

* *Connect the cable to the USB connector of the Macintosh itself, not to the USB connector of the keyboard.*

- 4** From the CD-ROM, drag the **Driver E (Mac OS 9,8) - FreeMIDI Setting** folder into the **FreeMIDI Applications** folder on the hard disk of your Macintosh to copy it there.

- 5** Open the **FreeMIDI Applications** folder from the location into which you installed **FreeMIDI**, and double-click the **FreeMIDI Setup** icon to start it up.

- 6** The first time you start up, use the following procedure.

1. A dialog box saying "**Welcome to FreeMIDI!**" will appear. Click **[Continue]**.
2. The **FreeMIDI Preferences** dialog box will appear. Click **[Cancel]**.
3. The **About Quick Setup** dialog box will appear. Click **[Cancel]**.

NOTE

Once the connections have been completed, turn on power to your various devices in the order specified. By turning on devices in the wrong order, you risk causing malfunction and/or damage to speakers and other devices.

MEMO

This unit is equipped with a protection circuit. A brief interval (a few seconds) after power up is required before the unit will operate normally.



MEMO

If you are using the PC-50 in conjunction with other MIDI devices, make settings as described in **Readme_E.htm** located in the **Driver E (Mac OS 9,8)** folder of the CD-ROM.

MEMO

When "**OMS is installed on this computer...**" appears, click **[FreeMIDI]**.

- 7 From the **File** menu, choose **Open**.
- 8 Select **PC-50** from the **FreeMIDI Setting** folder you copied in **step 3**, and click [**Open**].
- 9 Verify that MIDI transmission and reception occur correctly.
From the **MIDI** menu, choose **Check Connections**.

- 10 Try playing the keyboard of the PC-50. If  in the diagram at right changes to a , the settings have been made correctly.

If a MIDI sound module is connected to the PC-50's MIDI OUT connector, click the **PC-50 MIDI OUT** icon shown in the diagram at the right. If you hear sound, the settings have been made correctly.

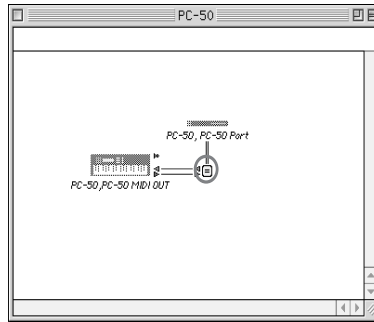

- 11 Once again choose the **MIDI** menu command **Check Connections** to end the test.
- 12 From the **File** menu, choose **Quit** to exit **FreeMIDI Setup**.

MEMO

If you are unable to select **Open**, make settings as follows.

1. From the **File** menu, choose **FreeMIDI Preference**.
2. Uncheck "**Use OMS when available.**"
3. Close FreeMIDI.

Return to step 4 and continue the procedure.

MEMO

For details on the PC-50's output devices, refer to "**Input / output devices**" (p. 36).

This completes installation of the driver.

Next, make MIDI device settings in your sequencer or other software.

For details on how to make these settings, refer to the owner's manual for your software.

For details on the PC-50's output devices, refer to "**Input / output devices**" (p. 36).

Input / output devices

In order to obtain the best performance from your software, you must make the appropriate input/output device settings.

For details on these settings, refer to the owner's manual for your software.

* *If you are unable to select the PC-50 in the device settings for your software, it is possible that the driver was not installed correctly. Please reinstall the driver.*

MIDI OUT DEVICE PC-50 MIDI OUT	If you specify PC-50 MIDI OUT as the output port for your sequencer software, messages will be transmitted from the MIDI OUT connector of the PC-50 itself. * Turn MIDI I/F MODE ON as described in "MIDI I/F MODE" (p. 65).
MIDI IN DEVICE PC-50	This port receives messages from the keyboard, Pitch Bend/Modulation Lever, and VALUE encoder. The port assignment determines how the keyboard, Pitch Bend/Modulation Lever, and VALUE encoder are mapped to PC-50.

MIDI I/F MODE ON

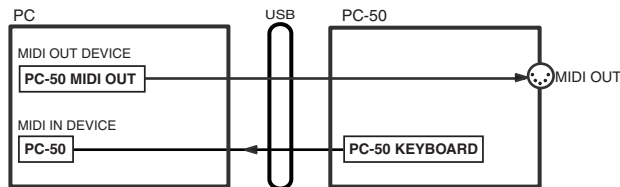

MIDI I/F MODE OFF

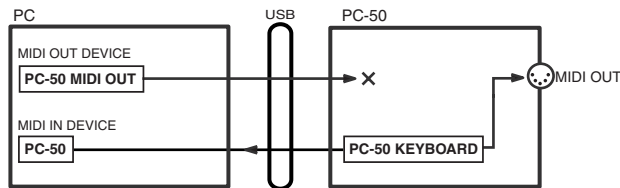

Operation

The PC-50 is a controller that transmits MIDI messages. You cannot perform using only the PC-50 by itself. You will need to connect it to a sound module or computer.

Basic connections and MIDI flow

USB connections with your computer—Transmitting MIDI messages to your software

Basic connections

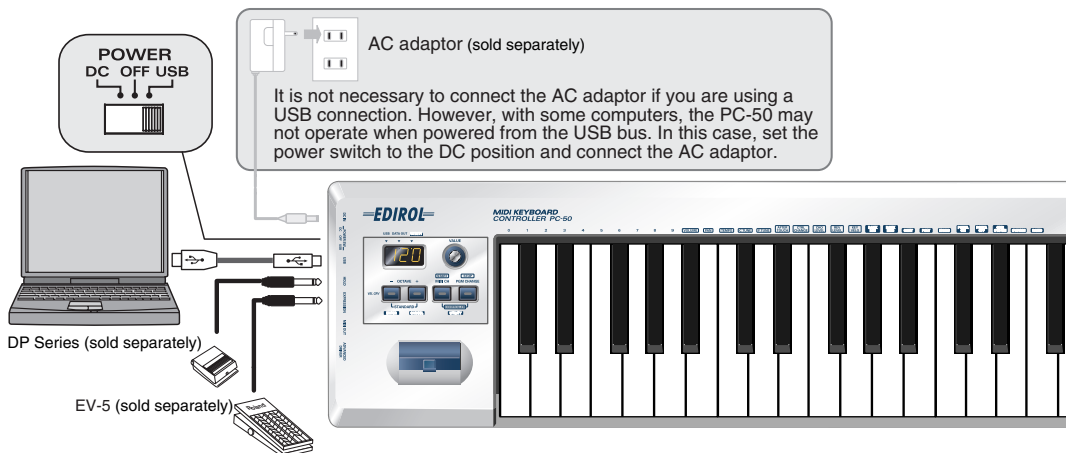

- * To prevent malfunction and/or damage to speakers or other devices, always turn down the volume, and turn off the power on all devices before making any connections.
- * Use only the specified expression pedal (EV-5; sold separately). By connecting any other expression pedals, you risk causing malfunction and/or damage to the unit.

MIDI flow

- * Turn MIDI I/F MODE OFF as described in “MIDI I/F MODE” (p. 65).

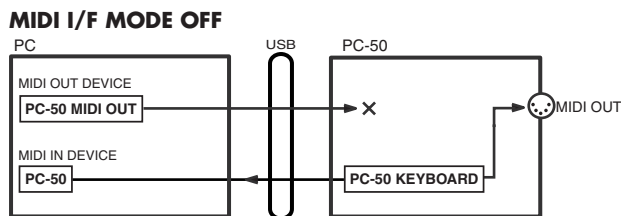

MIDI IN DEVICE PC-50	This port receives messages from the keyboard, Pitch Bend/Modulation Lever, and VALUE encoder. The port assignment determines how the keyboard, Pitch Bend/Modulation Lever, and VALUE encoder are mapped to PC-50.
PC-50 KEYBOARD	The messages of the keyboard, Pitch Bend/Modulation Lever, and VALUE encoder will be transmitted from here.

USB connections with your computer—Using the PC-50 as a MIDI interface

* If you want to use Media Player to play a sound module connected to the PC-50's MIDI OUT connector, make driver settings. (**Windows:** p. 24 / **Macintosh:** p. 28, p. 32).

Basic connections

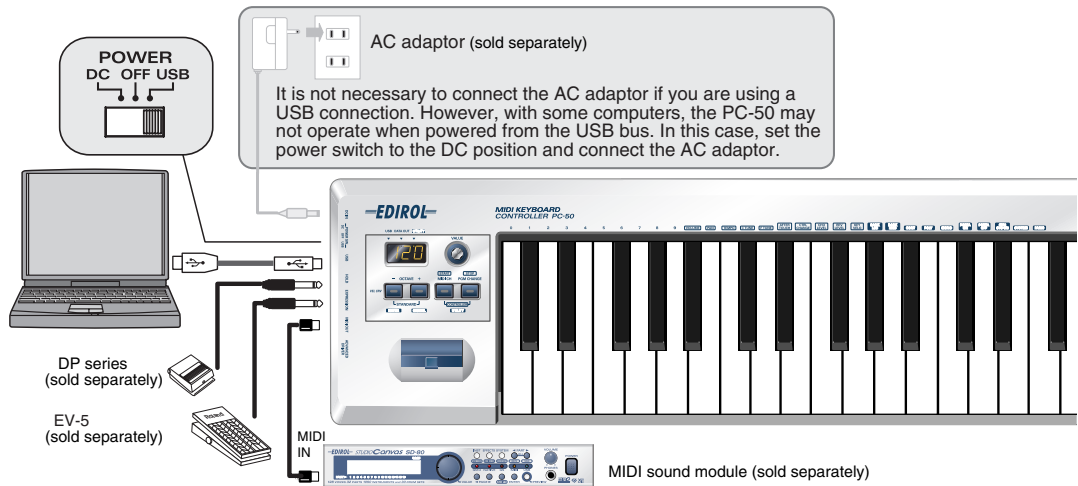

- * To prevent malfunction and/or damage to speakers or other devices, always turn down the volume, and turn off the power on all devices before making any connections.
- * Use only the specified expression pedal (EV-5; sold separately). By connecting any other expression pedals, you risk causing malfunction and/or damage to the unit.

MIDI flow

* Turn MIDI I/F MODE ON as described in **"MIDI I/F MODE"** (p. 65).

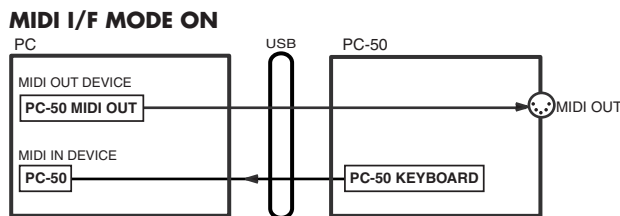

MIDI OUT DEVICE PC-50 MIDI OUT	If you specify PC-50 MIDI OUT as the output port for your sequencer software, messages will be transmitted from the MIDI OUT connector of the PC-50 itself. * Turn MIDI I/F MODE ON as described in "MIDI I/F MODE" (p. 65).
MIDI IN DEVICE PC-50	This port receives messages from the keyboard, Pitch Bend/Modulation Lever, and VALUE encoder. The port assignment determines how the keyboard, Pitch Bend/Modulation Lever, and VALUE encoder are mapped to PC-50.
PC-50 KEYBOARD	The messages of the keyboard, Pitch Bend/Modulation Lever, and VALUE encoder will be transmitted from here.

When using a MIDI connection—Transmitting MIDI messages to an external MIDI sound module, etc.

Basic connections

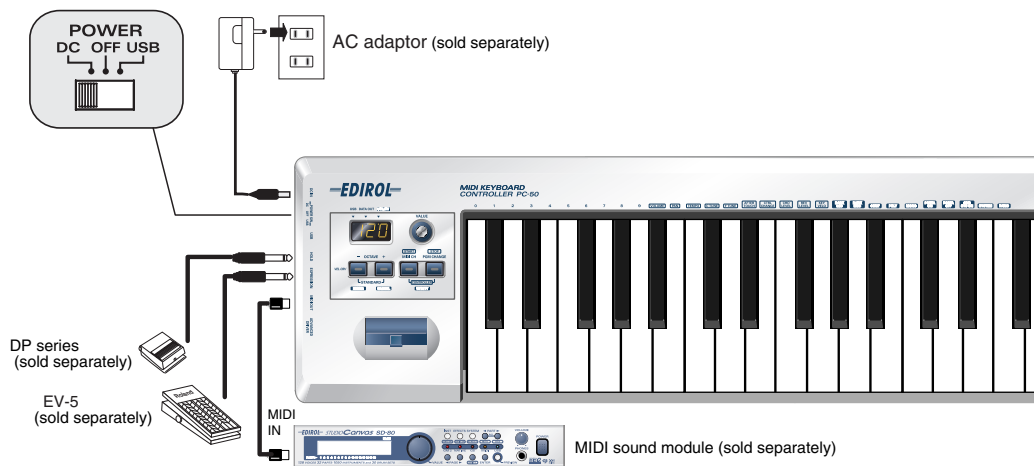

* Use only the specified expression pedal (EV-5; sold separately). By connecting any other expression pedals, you risk causing malfunction and/or damage to the unit.

MIDI flow

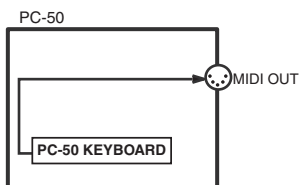

PC-50 KEYBOARD

The messages of the keyboard, Pitch Bend/Modulation Lever, and VALUE encoder will be transmitted from here.

Use MIDI functionality

How to switch modes

PLAY mode

PLAY

■ What is PLAY mode?

This is the mode in which you play the PC-50.

In PLAY mode, playing the keyboard will transmit note messages to play the MIDI device.

In PLAY mode, you can play the keyboard to produce sound on a connected sound module, and also use various other functions, such as operating the Pitch Bend/Modulation Lever to change the pitch of the currently sounding note (Pitch Bend), adding vibrato (Modulation), or switching the octave (Octave Shift).

In this mode you can also specify the MIDI transmit channel, and transmit program changes, parameters, or start/stop messages.

■ To switch the PC-50 to PLAY mode...





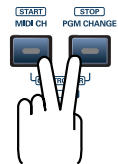







When you turn on the power, the PC-50 will start up in PLAY mode.

To switch the PC-50 to PLAY mode from UTILITY mode (p. 42), simultaneously hold the **[MIDI CH]** button and **[PGM CHANGE]** button down or press the **[CANCEL]** button.



- You are returned to PLAY mode once a setting or a process has been completed within the UTILITY mode.
- You will also return to PLAY mode if you cancel an operation within UTILITY mode. In this case, the setting you had been making will be discarded.

■ Functions in PLAY mode

Play	Transmit MIDI messages by playing the keyboard or operating the Pitch Bend/Modulation Lever, VALUE encoder, hold pedal and expression pedal.		p. 43
Specify the MIDI transmit channel	Set the transmit channel for the keyboard, Pitch Bend/Modulation Lever, VALUE encoder, hold pedal and expression pedal.		p. 45
Transmit a Program Change message	Transmit program change messages by operating the VALUE encoder.  For details on transmitting Bank Select, refer to p. 48 and p. 49.		p. 47
Start playback	If you're in CONTROLLER mode (p. 50), pressing [MIDI CH] will transmit a Start (FAh) message.	  +  <small>(CONTROLLER)</small>	p. 51
Stop playback	If you're in CONTROLLER mode (p. 50), pressing [PGM CHANGE] will transmit a Stop (FCh) message.	  +  <small>(CONTROLLER)</small>	p. 52
Transmit the value of a specific parameter	If you're in CONTROLLER mode (p. 50), operating the VALUE encoder will transmit the value of a specific parameter.	  +  <small>(CONTROLLER)</small>	p. 60

UTILITY mode

UTILITY

■ What is UTILITY mode?

This is the mode in which you assign the control messages you want to use, and make settings for the PC-50 itself.

In UTILITY mode, you use the keyboard to choose the function you want to set. In UTILITY mode, playing the keyboard will not transmit notes.

■ To switch the PC-50 to UTILITY mode...

To switch the PC-50 to UTILITY mode from PLAY mode, simultaneously hold the **[MIDI CH]** button and **[PGM CHANGE]** button down.

The display will indicate "UTL," and the PC-50 enters UTILITY mode.

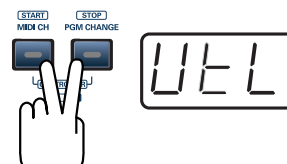

■ Functions in UTILITY mode

Transmit a Bank Select LSB message	This switches the bank. Transmit bank select LSB (CC#32) message.	BANK LSB	p. 48
Transmit a Bank Select MSB message	This switches the bank. Transmit bank select MSB (CC#00) message.	BANK MSB	p. 49
Continue playback from the current location	This transmits a Continue message (FBh); playback that had been paused will continue from the current location.	CONT	p. 53
Transmit a Poly Mode On message	Sets the voice mode to Poly mode.	POLY	p. 54
Transmit a Mono Mode On message	Sets the voice mode to Mono mode.	MONO	p. 55
Transmit a Portamento On message	Turns on the portamento function that creates a smooth pitch change from one note to the next (Portamento On).	PORTA ON	p. 56
Transmit a Portamento Off message	Turns the portamento function off.	PORTA OFF	p. 57
Transmit a GM2 System On message	Transmit a GM2 System On message.	GM2 SYS ON	p. 58
Transmit a Reset message	Stop "stuck" notes or other problems with the sound on a connected MIDI sound module.	PANIC	p. 59
Make system settings	You can make system settings for the PC-50 itself.	SYSTEM	p. 61

Play

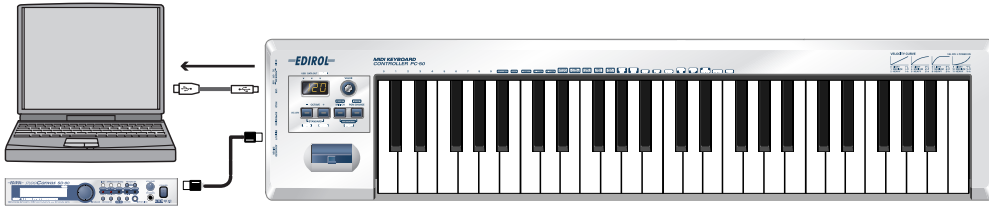
PLAY

When you turn on the power, the PC-50 will start up in **PLAY mode**.

 **What is PLAY mode?** (p. 41)

In **PLAY mode**, playing the keyboard will transmit note messages to play the connected MIDI device.

In order to transmit MIDI messages from the PC-50, perform the following steps.

- 1 Set the MIDI channel the PC-50 will use to transmit to the same channel on the sound module (software) is using to receive on.

Use MIDI Channel mode to set the **MIDI transmit channel**.

(→ **Setting the MIDI Transmit Channel** (p. 45)).

- 2 Select a **sound** on your **MIDI sound module**.

(→ **Selecting Sounds on a Sound Module** (p. 46)).

- 3 Once you have finished making settings, try playing the keyboard.

When you play the keyboard in **PLAY mode**, MIDI messages are sent to the sound module (software).

* *Since the PC-50 does not contain a sound generator, you cannot play MIDI data using the PC-50 alone.*

Features Useful When Playing

Applying Pitch Changes to Notes (Pitch Bend)	Move the Pitch Bend/Modulation Lever (left or right) to transmit Pitch Bend messages, and apply subtle pitch changes to notes. * The amount of pitch change (“bend range”) depends on the settings of your sound module.
Modifying the Sound of Notes (Modulation)	Push the Pitch Bend/Modulation Lever away from you to transmit Modulation messages (CC#01), changing the sound in real time (usually by adding a vibrato effect). * The type of change this produces in the sound depends on the settings of your sound module.
Adding a Sustain Effect to Notes (Hold)	If a pedal switch or foot switch (one from the DP series or BOSS FS-5U; sold separately) is connected to the rear panel HOLD jack, you can press the foot switch to make notes continue sounding even after you remove your hand from the keyboard (the Hold function). This will transmit the MIDI message Hold 1 (CC#64). The Hold On message (data 127) is transmitted when you press the pedal, and Hold Off (data 0) when you release the pedal.
Controlling the Volume or Timbre of the Sound (Expression)	If an expression pedal (EV-5; sold separately) is connected to the rear panel EXPRESSION jack, you can use the pedal to control the volume or tone.
Changing Octaves (Octave Shift)	You can press [OCTAVE -] or [OCTAVE +] to raise or lower the pitch range of the keyboard (the Octave Shift function). Press [OCTAVE -] once to lower the pitch range one octave. Press it once again to lower the range an additional octave. Permissible settings for this range from -4 to 5 octaves. [OCTAVE -] or [OCTAVE +] will light according to the current Octave Shift setting. If you simultaneously press [OCTAVE -] and [OCTAVE +] , the Octave Shift setting will be reset to 0, restoring the normal pitch range of the keyboard.

MEMO

While playing the keyboard, move the Pitch Bend/Modulation Lever to the left to lower the pitch of the currently selected patch, or to the right to raise its pitch. This is known as **pitch bend**.

You can also apply vibrato by gently pressing the Modulation Controller. This is known as **modulation**.

If you push the lever away from you and the same time move it to the right or left, you can apply both effects at once.

* The amount of pitch change (“bend range”) depends on the settings of your sound module.

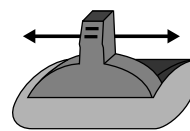

Pitch Bend

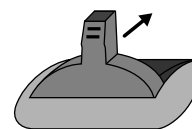

Modulation

Setting the MIDI Transmit Channel

PLAY

To control your sound module, set the PC-50's **current channel** to the **MIDI receive channel** that's selected on your sound module.

■ Current channel

The **current channel** is the **transmit channel** for the keyboard, Pitch Bend/Modulation Lever, VALUE encoder, hold pedal and expression pedal.

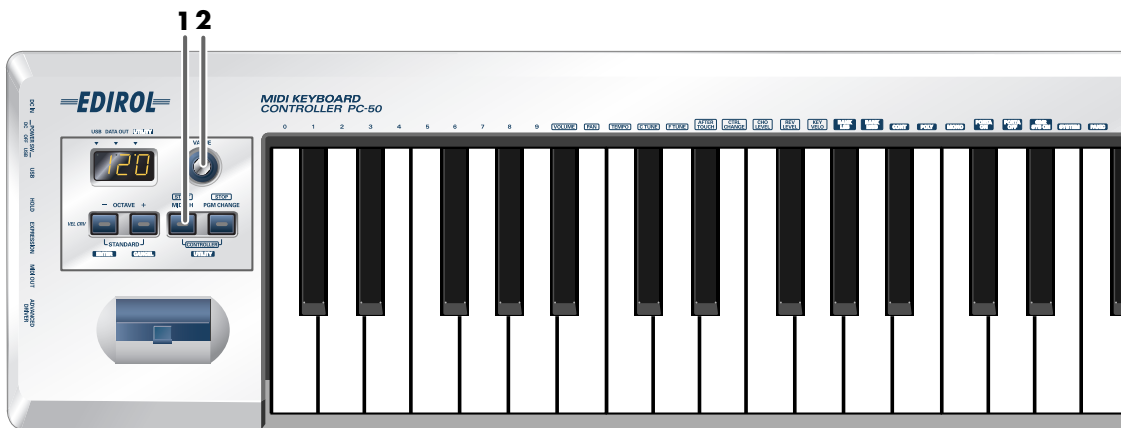

- 1 Press the **[MIDI CH]** button.
The **[MIDI CH]** button will light. The display will show the **current channel** setting.
- 2 Use the **VALUE encoder** to specify the desired channel number.

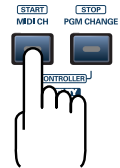

Value range	1-16
-------------	------

The **current channel** has now been set.

HINT

In **CONTROLLER mode** (p. 50), pressing the **[MIDI CH]** button will transmit a Start message (FAh).

Selecting Sounds on a Sound Module

—Transmitting Program Change / Bank Select Messages

To select a sound on your MIDI sound module, transmit a Program Change.

To select a sound from a different bank, first transmit a Bank Select message that switches the bank.

Then transmit a program change.

* *You must transmit the Bank Select message before transmitting the Program Change message.*

■ What is a bank?

MIDI sound modules organize their numerous sounds in various groups according to the category of sound. These groups are called “banks.”

Program Change messages can only select sounds within the same bank, but by using these in conjunction with Bank Select messages, you can select different variations of sound.

* *The way in which sounds are organized will differ for each sound module. For details, refer to the owner’s manual of the sound module you are using.*

- **Transmitting a program change message**..... (p. 47)
- **Transmitting a bank select LSB message** (p. 48)
- **Transmitting a bank select MSB message** (p. 49)

Transmitting a program change message

PLAY

This lets you transmit a **program change message** on the **Current channel** (p. 45).

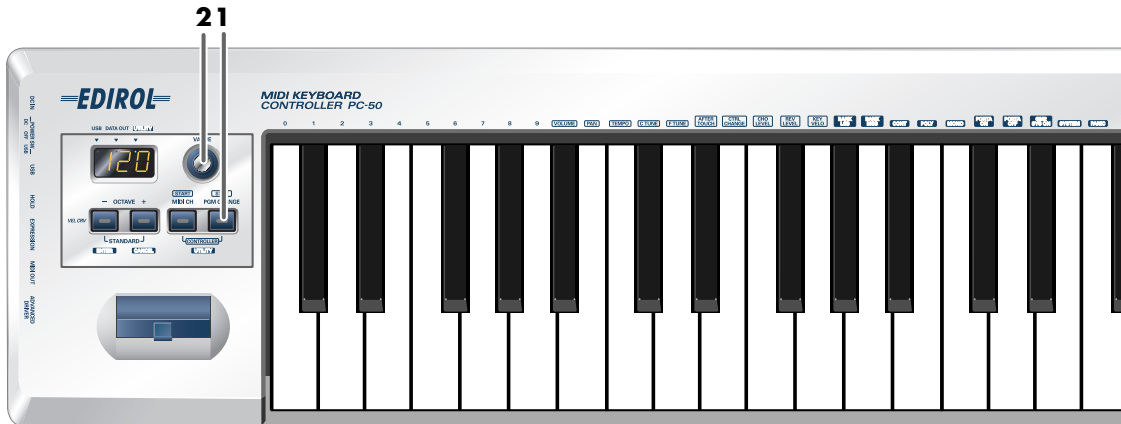

- 1 Press the **[PGM CHANGE]** button.

The **[PGM CHANGE]** button will light. The display will indicate the program change that was transmitted most recently.

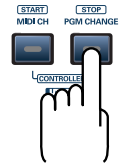

- 2 Use the **VALUE encoder** to specify the program change you want to transmit.

Value range	1-128
-------------	-------

The **program change message** has now been transmitted.

HINT

In **CONTROLLER mode** (p. 50), pressing the **[PGM CHANGE]** button will transmit a Stop message (FCh).

Transmitting a bank select LSB message

UTILITY

Here's how to transmit a **bank select LSB (#CC32) message** on the **Current channel** (p. 45). The **bank select MSB** and **program change message** you most recently transmitted (specified) as described in "Transmitting a bank select MSB message" (p. 49) and "Transmitting a program change message" (p. 47) will also be transmitted.

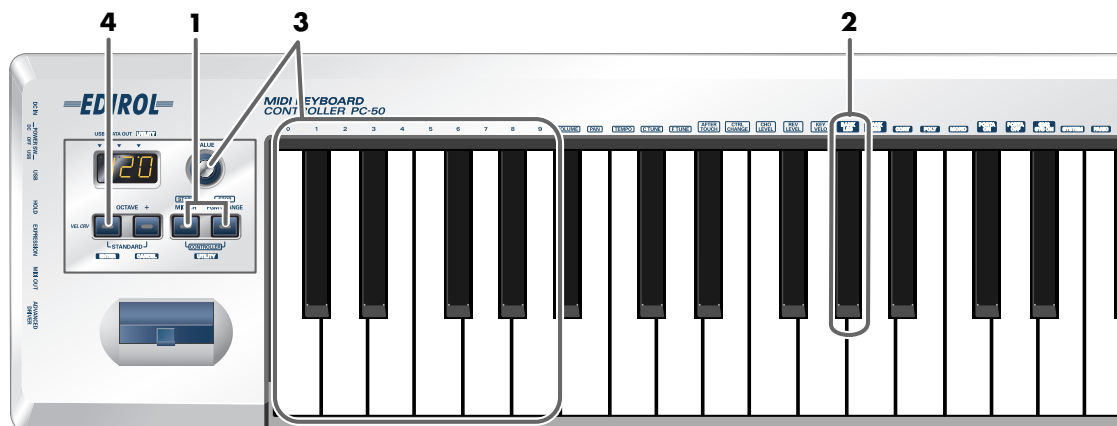

- 1 Simultaneously hold the **[MIDI CH]** button and **[PGM CHANGE]** button down.

The display will indicate "UTL," and the PC-50 enters UTILITY mode.

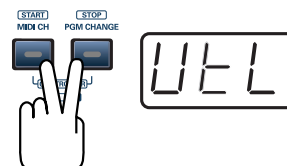

- 2 Press **[BANK LSB]** key.

- 3 Use the **VALUE encoder** or the **[0]–[9]** keys of the keyboard to specify the bank select LSB that you want to transmit.

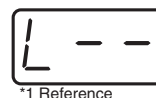

*1 Reference

- 4 Press the **[ENTER]** button.

* The setting will be cancelled if you press another button instead of the **[ENTER]** button.

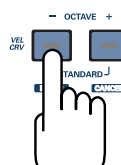

The **bank select LSB message** has now been transmitted.

Transmitting a bank select MSB message

UTILITY

Here's how to transmit a **bank select MSB (#CC00) message** on the **Current channel** (p. 45). The **bank select LSB** and **program change message** you most recently transmitted (specified) as described in "Transmitting a bank select LSB message" (p. 48) and "Transmitting a program change message" (p. 47) will also be transmitted.

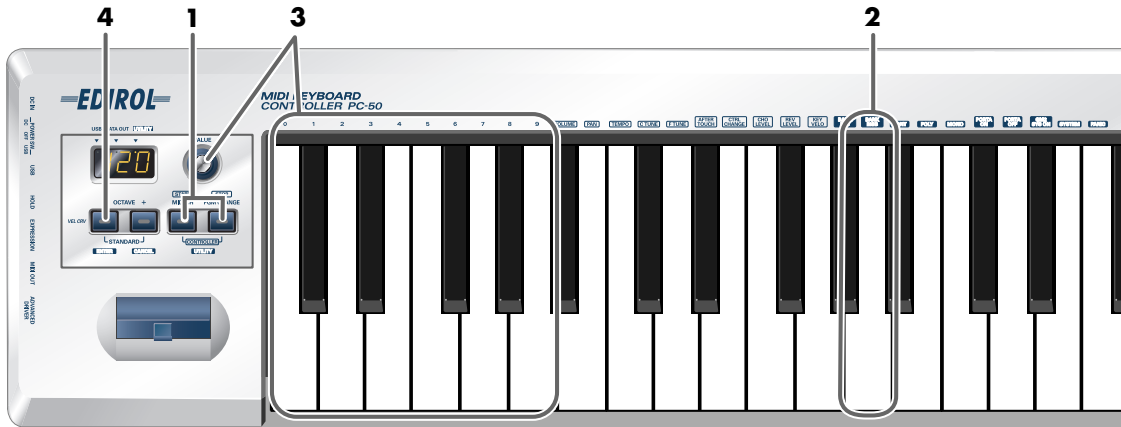

- 1 Simultaneously hold the **[MIDI CH]** button and **[PGM CHANGE]** button down.

The display will indicate "UTL," and the PC-50 enters UTILITY mode.

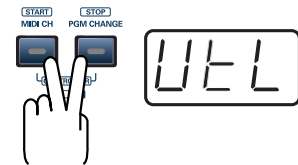

- 2 Press **[BANK MSB]** key.

- 3 Use the **VALUE encoder** or the **[0]–[9]** keys of the keyboard to specify the bank select MSB that you want to transmit.



*1 Reference

- 4 Press the **[ENTER]** button.

* The setting will be cancelled if you press another button instead of the **[ENTER]** button.

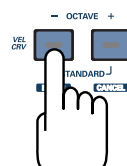

The **bank select MSB message** has now been transmitted.

*1 The -- area displays the currently set value. If it has not been set, the default setting will be displayed. Even if you change the type or mode of the MIDI message that is assigned, the default setting will be displayed. This will be lit if the value is the same as the currently set value, or will blink if the value is different.

Starting/stopping playback—Transmitting start/stop messages

By transmitting a **start** message (FAh) or **stop** message (FCh) to your sequencer or similar device, you can start or stop playback on the sequencer.

By transmitting a **continue** message (FBh), you can resume playback from the point where it was last stopped.

Use **CONTROLLER mode** to transmit **start/stop** messages.

■ What is CONTROLLER mode?

In this mode, the **[MIDI CH]** button, **[PGM CHANGE]** button, and **VALUE encoder** are assigned different functions than in the normal PLAY mode.

	[MIDI CH] button	[PGM CHANGE] button	VALUE encoder
CONTROLLER mode	Transmit a Start message	Transmit a Stop message	Transmit the specified parameter
Normal PLAY mode	Specify the MIDI transmit channel	Specify a program change	Specify a MIDI transmit channel or transmit a program change number

■ To switch the PC-50 to CONTROLLER mode...

If you simultaneously press the **[MIDI CH]** button and the **[PGM CHANGE]** button, the **[MIDI CH]** button and **[PGM CHANGE]** button will light, and the PC-50 will be in CONTROLLER mode.

If you again press the **[MIDI CH]** button and **[PGM CHANGE]** button simultaneously, the **[MIDI CH]** button and **[PGM CHANGE]** button will go dark, and the PC-50 will be in Normal PLAY mode.

* *CONTROLLER mode works only in PLAY mode. It is not available in UTILITY mode.*

Use **UTILITY mode** (p. 42) to transmit a **continue message**.

Starting playback—Transmitting a start message

PLAY **CONTROLLER**

A **start message** (FAh) will be transmitted, and playback or recording will begin.

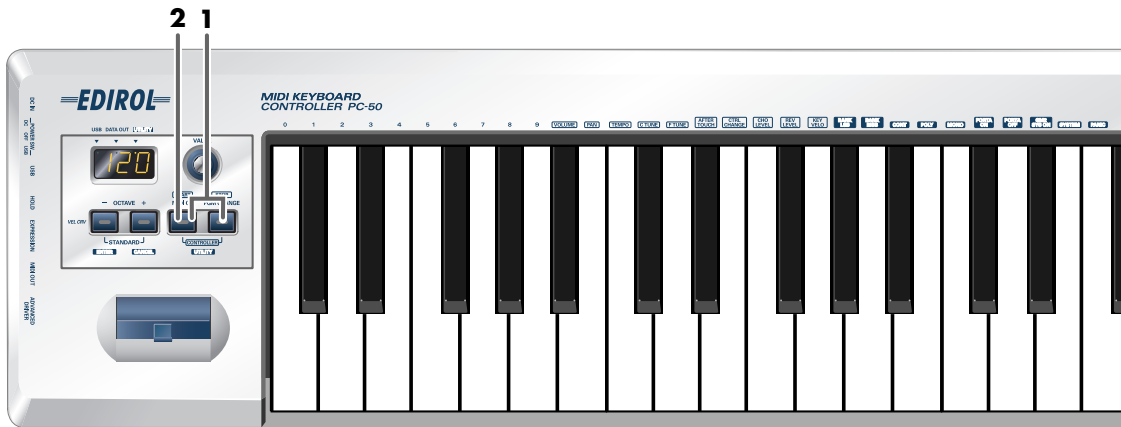

- 1 If you simultaneously press the **[MIDI CH]** button and the **[PGM CHANGE]** button, the **[MIDI CH]** button and **[PGM CHANGE]** button will light, and the PC-50 will be in **CONTROLLER** mode.

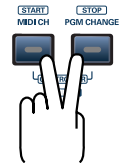

- 2 Press the **[MIDI CH]** button.

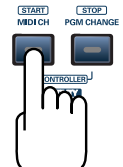

The **start message** has now been transmitted.

Stopping playback—Transmitting a stop message

PLAY **CONTROLLER**

A **stop message** (FCh) will be transmitted, and playback or recording will stop.

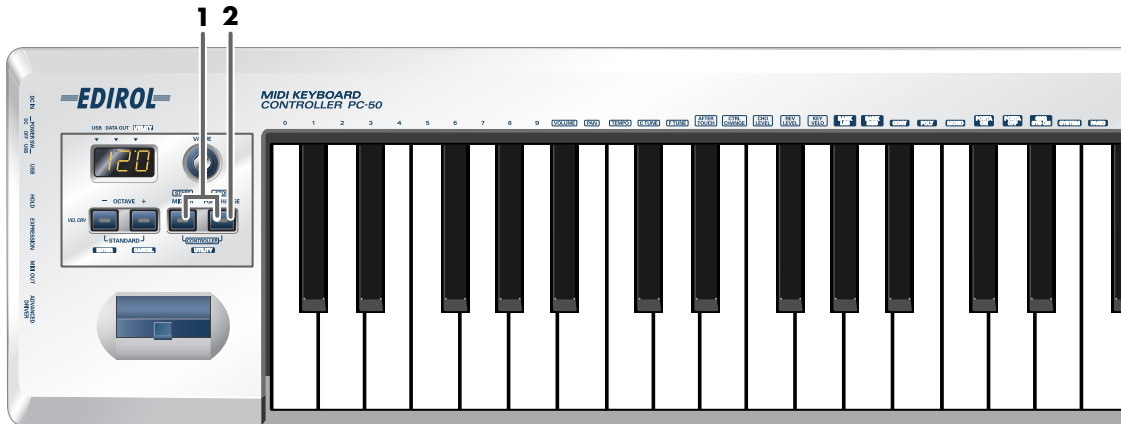

1 If you simultaneously press the **[MIDI CH]** button and the **[PGM CHANGE]** button, the **[MIDI CH]** button and **[PGM CHANGE]** button will light, and the PC-50 will be in **CONTROLLER** mode.

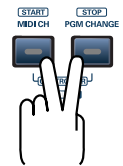

2 Press the **[PGM CHANGE]** button.

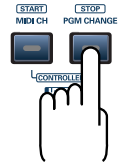

The **stop message** has now been transmitted.

Continuing playback from the current location—Transmitting a continue message UTILITY

This transmits a **continue message** (FBh); playback that had been paused will continue from the current location.

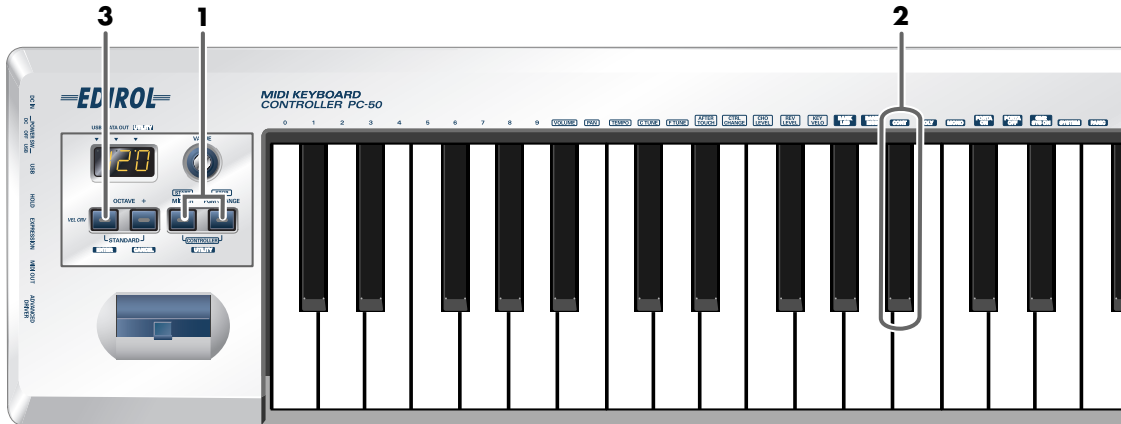

- 1** Simultaneously hold the **[MIDI CH]** button and **[PGM CHANGE]** button down.

The display will indicate “UTL,” and the PC-50 enters UTILITY mode.

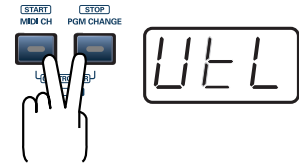

- 2** Press the **[CONT]** key.

The display will indicate “CNT” and blink.

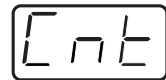

- 3** Press the **[ENTER]** button.

* The setting will be cancelled if you press another button instead of the **[ENTER]** button.

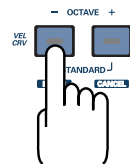

The **continue message** has now been transmitted.

Transmitting messages to an external MIDI sound module

You can transmit messages from the PC-50 to an external MIDI sound module in order to control it.

Messages	Description
POLY MODE ON	p. 54
MONO MODE ON	p. 55
PORTAMENTO ON	p. 56
PORTAMENTO OFF	p. 57
GM2 SYSTEM ON	p. 58
RESET	p. 59

Use **UTILITY mode** (p. 42) to transmit these messages to an external MIDI sound module.

Transmitting a poly mode on message

UTILITY

Here's how to set the voice mode of your connected MIDI sound module to Poly mode. Poly mode allows you to play multiple notes (chords) simultaneously.

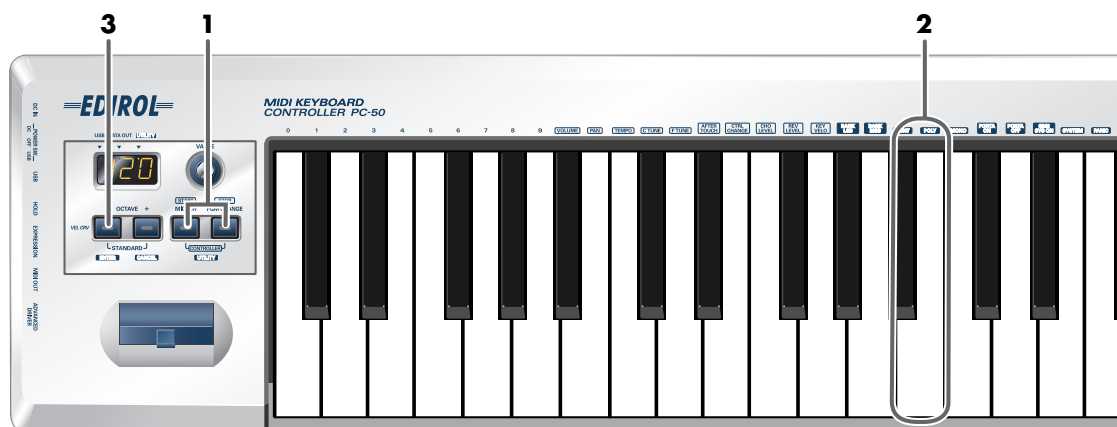

- 1 Simultaneously hold the **[MIDI CH]** button and **[PGM CHANGE]** button down.

The display will indicate "UTL," and the PC-50 enters UTILITY mode.



- 2 Press the **[POLY]** key.

The display will indicate "PLY" and blink.

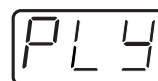

- 3 Press the **[ENTER]** button.

* The setting will be cancelled if you press another button instead of the **[ENTER]** button.

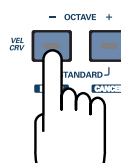

The **poly mode on message** has now been transmitted.

Transmitting a mono mode on message

UTILITY

Here's how to set the voice mode of your connected MIDI sound module to Mono mode. Mono mode allows you to play only single notes at a time.

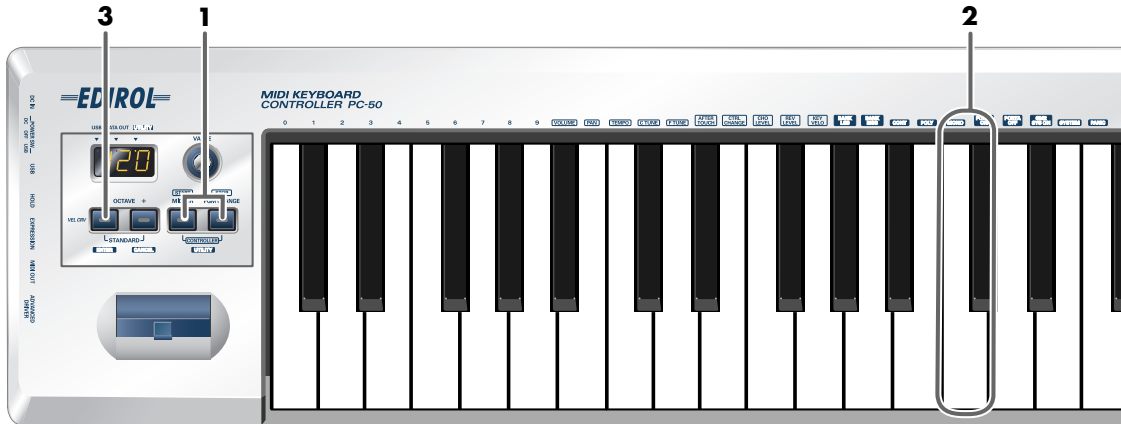

- 1 Simultaneously hold the **[MIDI CH]** button and **[PGM CHANGE]** button down.

The display will indicate "UTL," and the PC-50 enters UTILITY mode.

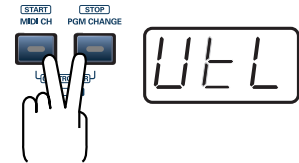

- 2 Press the **[MONO]** key.

The display will indicate "MNO" and blink.



- 3 Press the **[ENTER]** button.

* The setting will be cancelled if you press another button instead of the **[ENTER]** button.

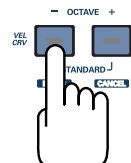

The **mono mode on message** has now been transmitted.

Transmitting a portamento on message

UTILITY

Turns on the portamento function that creates a smooth pitch change from one note to the next (Portamento On).

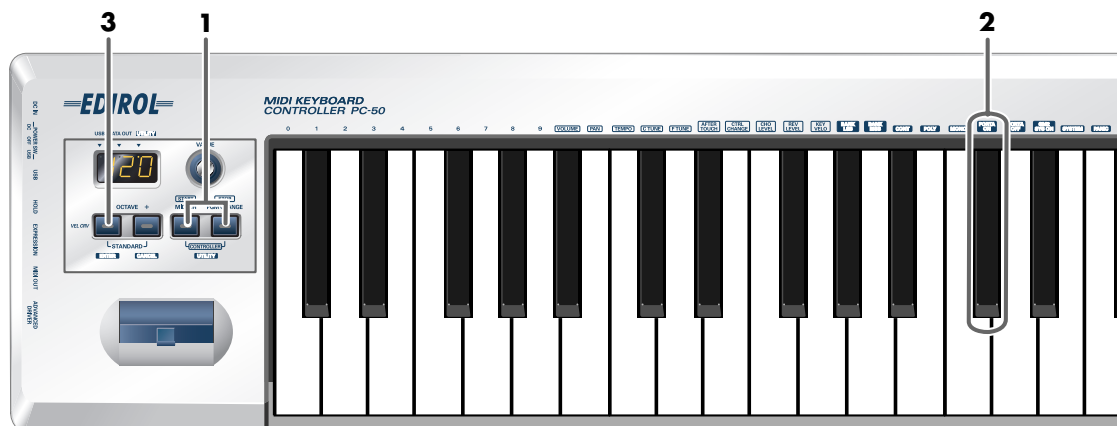

- 1 Simultaneously hold the **[MIDI CH]** button and **[PGM CHANGE]** button down.

The display will indicate “UTL,” and the PC-50 enters UTILITY mode.

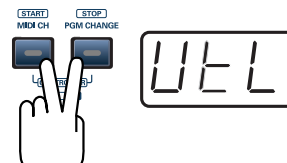

- 2 Press the **[PORTA ON]** key.

The display will indicate “PON” and blink.



- 3 Press the **[ENTER]** button.

* The setting will be cancelled if you press another button instead of the **[ENTER]** button.

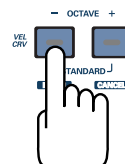

The **portamento on message** has now been transmitted.

Transmitting a portamento off message

UTILITY

Turns the portamento function off.

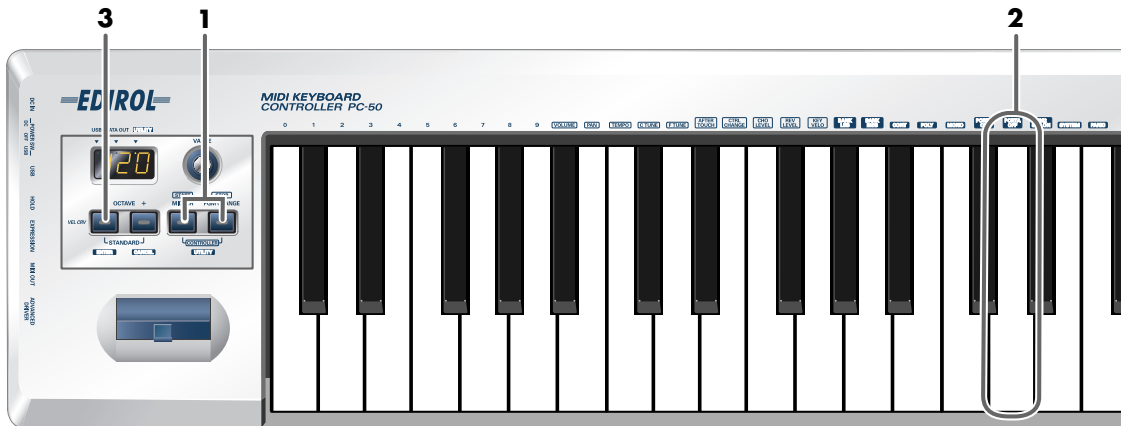

- 1 Simultaneously hold the **[MIDI CH]** button and **[PGM CHANGE]** button down.

The display will indicate “UTL,” and the PC-50 enters UTILITY mode.

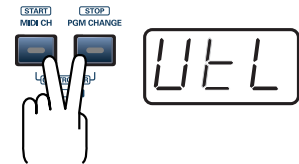

Press the **[PORTA OFF]** key.

The display will indicate “POF” and blink.



- 2 Press the **[ENTER]** button.

* The setting will be cancelled if you press another button instead of the **[ENTER]** button.

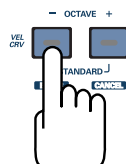

The **portamento off message** has now been transmitted.

Transmitting a GM2 system on message

UTILITY

This lets you transmit a **GM2 system on message**.

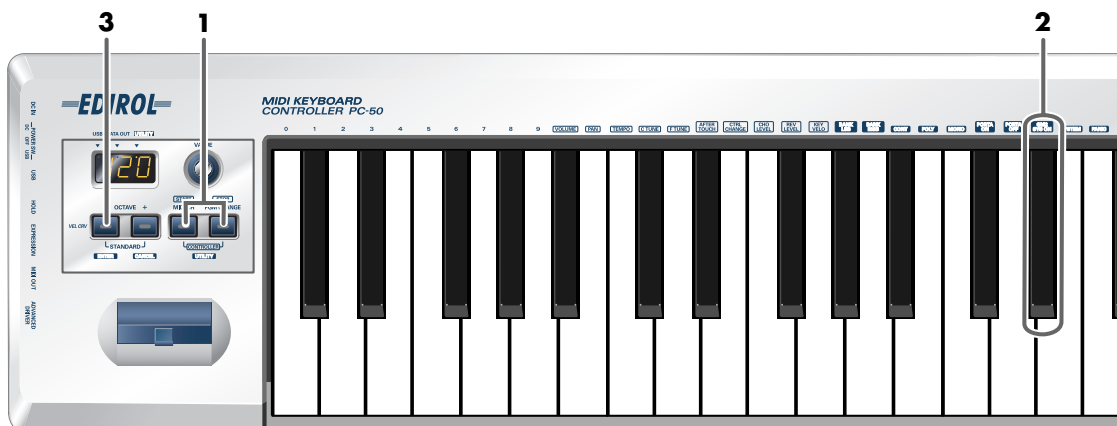

- 1 Simultaneously hold the **[MIDI CH]** button and **[PGM CHANGE]** button down.

The display will indicate "UTL," and the PC-50 enters UTILITY mode.

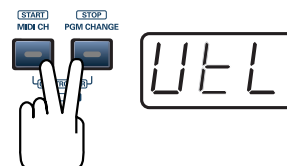

- 2 Press the **[GM2 SYS ON]** key.

The display will indicate "GM2" and blink.



- 3 Press the **[ENTER]** button.

* The setting will be cancelled if you press another button instead of the **[ENTER]** button.

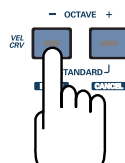

The **GM2 system on message** has now been transmitted.

Transmitting a reset message

UTILITY

If notes on a connected MIDI sound module become “stuck,” or if there is something wrong with the sound, you can execute the Panic function to solve the problem.

When you execute the Panic function, **All sounds off**, **All notes off**, and **Reset all controllers** messages will be transmitted on all channels.

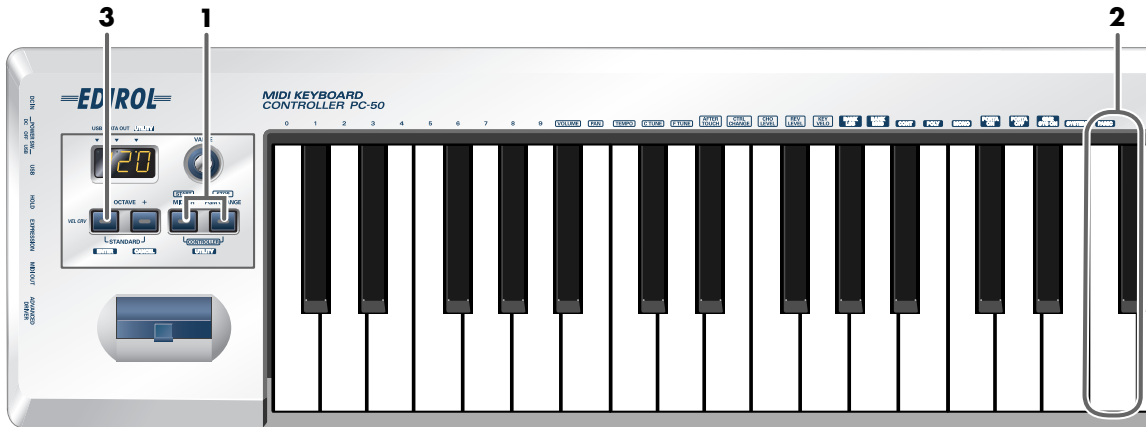

- 1 Simultaneously hold the **[MIDI CH]** button and **[PGM CHANGE]** button down.

The display will indicate “UTL,” and the PC-50 enters UTILITY mode.

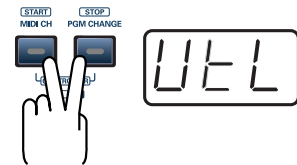

- 2 Press the **[PANIC]** key.

The display will indicate “PnC” and blink.



- 3 Press the **[ENTER]** button.

* The setting will be cancelled if you press another button instead of the **[ENTER]** button.

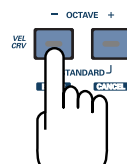

The **reset message** has now been transmitted.

Transmitting the value of a specific parameter PLAY CONTROLLER

■ Specified parameters

The PC-50 lets you assign a specific parameter to the VALUE encoder so that the value of that parameter will be transmitted when you operate the VALUE encoder.

■ To assign a parameter

In **UTILITY** mode **System settings**, specify the parameter you want to assign to the VALUE encoder.

 **System settings** (p. 61)

If you're in **CONTROLLER mode** (p. 50), operating the VALUE encoder will transmit the value of a specific parameter.

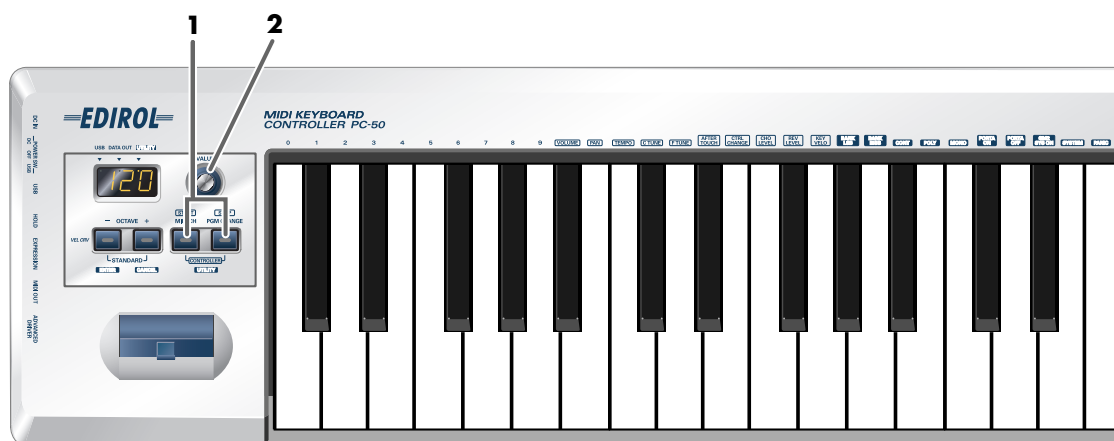

- 1 If you simultaneously press the **[MIDI CH]** button and the **[PGM CHANGE]** button, the **[MIDI CH]** button and **[PGM CHANGE]** button will light, and the PC-50 will be in **CONTROLLER** mode.



- 2 Operate the **VALUE encoder**.
The value of the parameter you assigned will be transmitted.



System settings

Set the system settings

UTILITY

Use **UTILITY mode** (p. 42) to make various system settings for the PC-50.

- 1 Simultaneously hold the **[MIDI CH]** button and **[PGM CHANGE]** button down.

The display will indicate “UTL,” and the PC-50 enters UTILITY mode.

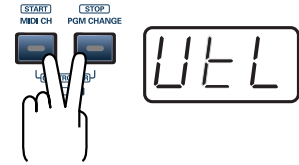

- 2 Press the **[SYSTEM]** key.

The display will indicate “SY0” and blink.

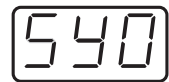

- 3 Use the **VALUE encoder** or the **[0]–[9]** keys to specify the System setting that you want to set, and then press the **[ENTER]** button.

* The setting will be cancelled if you press another button instead of the **[ENTER]** button.

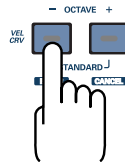

Confirm what’s indicated and use the appropriate method to make the setting.

Display	Mode	Key-board	Content of the setting	Default	Setting method
	F8 CLOCK ON/OFF	0	Specify whether F8 Clock is to be transmitted.	OFF	p. 62
	F8 CLOCK DEFAULT TEMPO	1	If “F8 CLOCK ON/OFF” is ON, specify the default value of the F8 Clock. After the power is turned on, this tempo will continue to be output until you move a controller to which TEMPO is assigned.	120	p. 62
	VELOCITY CURVE	2	When you play the keyboard of the PC-50, note messages will be transmitted with a velocity value that corresponds to your playing strength. By setting the VELOCITY CURVE, you can modify the keyboard’s sensitivity and the curve that is followed when the velocity value changes.	1-MEDIUM	p. 63
	KEY VELOCITY	3	Specify whether the transmitted velocity value will vary according to the keyboard sensitivity and curve you selected in “VELOCITY CURVE”, or will always be transmitted at a fixed value.	TOUCH	p. 64
	MIDI I/F MODE	4	Specify whether the PC-50 will function as a MIDI interface using its MIDI connectors.	ON	p. 65
	VALUE ENCODER	5	Select the parameter that is transmitted by the VALUE encoder.	VOLUME	p. 66
	FACTORY RESET	6	Restore all settings of the PC-50 to their factory-set condition.	-	p. 68

F8 CLOCK ON / OFF (Keyboard: 0)

Perform steps 1–3 (p. 61).

- 4 Use the **VALUE encoder** or the **[0]** or **[1]** keys to switch F8 CLOCK ON / OFF.

Keyboard	Setting
0	OFF
1	ON

The display will indicate either “ON” or “OFF.”

- 5 Press the **[ENTER]** button.

F8 CLOCK DEFAULT TEMPO (Keyboard: 1)

Perform steps 1–3 (p. 61).

- 4 Use the **VALUE encoder** or the **[0]–[9]** keys to specify F8 CLOCK DEFAULT TEMPO. (Value range 20–250)

The specified value will indicate in the display.

- 5 Press the **[ENTER]** button.

VELOCITY CURVE (Keyboard: 2)

Perform steps 1–3 (p. 61).

- 4 Use the **VALUE encoder** or the **keyboard** to specify the keyboard sensitivity and curve.

Keyboard	Display	Setting	Curve	Keyboard's sensitivity	
0		1-LIGHT	The standard setting. The volume will change in a natural way according to your playing strength.	High velocity values will be produced even if you play the keyboard softly.	
1		1-MEDIUM			The keyboard sensitivity will be normal.
2		1-HEAVY		High velocity values will be produced only if you play the keyboard strongly.	
3		2-LIGHT	Compared to curve 1, the volume will change more significantly for softly played notes.	High velocity values will be produced even if you play the keyboard softly.	
4		2-MEDIUM			The keyboard sensitivity will be normal.
5		2-HEAVY		High velocity values will be produced only if you play the keyboard strongly.	
6		3-LIGHT	Variations in your playing strength will produce natural-sounding changes in volume.	High velocity values will be produced even if you play the keyboard softly.	
7		3-MEDIUM			The keyboard sensitivity will be normal.
8		3-HEAVY		High velocity values will be produced only if you play the keyboard strongly.	
9		4-LIGHT	Compared to curve 1, the volume will change more significantly for the strongly played notes.	High velocity values will be produced even if you play the keyboard softly.	
		4-MEDIUM			The keyboard sensitivity will be normal.
		4-HEAVY		High velocity values will be produced only if you play the keyboard strongly.	

- 5 Press the **[ENTER]** button.

■ VELOCITY CURVE setting

VEL CRV



You can also access the VELOCITY CURVE setting screen by holding down the **[VELCRV]** button while you turn on the power.

KEY VELOCITY (Keyboard: 3)

Key Velocity mode lets you specify whether the transmitted velocity value will vary according to your keyboard playing strength and the specified “**VELOCITY CURVE**” (p. 63), or will always be transmitted at a fixed value.

The PC-50 detects the strength with which you play a key, and transmits the velocity value accordingly. However, if you set Key Velocity mode to a fixed value, the velocity will be transmitted at this fixed value regardless of how strongly you play the keys. You can use the Key Velocity mode to specify a fixed value if you don’t want your playing dynamics to have an effect.

Perform steps 1–3 (p. 61).

- 4 Use the **VALUE encoder** or the **keyboard** to specify the Key Velocity mode.



Key-board	Display	Mode	Description
0		TOUCH	Velocity values will be transmitted according to the keyboard sensitivity and curve you selected in “ VELOCITY CURVE ” (p. 63).
	1–127	Fixed value	Velocity will be transmitted at the specified value regardless of how strongly you play the keyboard.

- 5 Press the **[ENTER]** button.

MIDI I/F MODE (Keyboard: 4)

Perform steps 1–3 (p. 61).

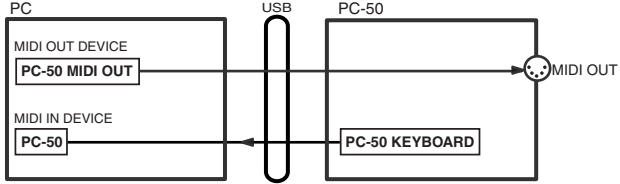
- 4 Use the **VALUE encoder** or the **[0]–[1]** keys to specify MIDI I/F MODE.

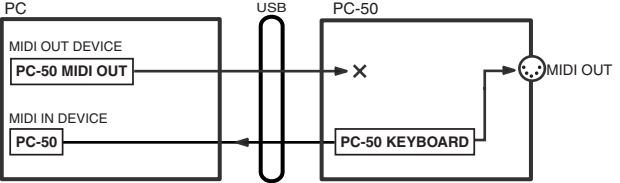
Key-board	Display	Mode	Description
0		MIDI I/F MODE ON	<p>The MIDI connectors on the PC-50 will function as a MIDI interface. MIDI messages from a computer connected via USB to the PC-50 will be sent to the MIDI device connected to the PC-50's MIDI OUT connector.</p> <p>MIDI I/F MODE ON</p> 
1		MIDI I/F MODE OFF	<p>MIDI messages received by the PC-50 are not output from the PC-50. MIDI messages from the PC-50 will be sent to your computer or external MIDI device.</p> <p>MIDI I/F MODE OFF</p> 

- 5 Press the **[ENTER]** button.

VALUE ENCODER (Keyboard: 5)

You can assign a specific parameter to the VALUE encoder.

■ Specified parameters

The PC-50 lets you assign a specific parameter to the VALUE encoder so that the value of that parameter will be transmitted when you operate the VALUE encoder.

■ To transmit the value of a specific parameter

If you're in **CONTROLLER mode** (p. 50), operating the VALUE encoder will transmit the value of a specific parameter.



Transmitting the value of a specific parameter (p. 60)

* *The VALUE encoder setting is valid only in the CONTROLLER mode of **PLAY mode** (p. 41).*

Perform steps 1–3 (p. 61).

4. Use the **VALUE encoder** or the **keyboard** to specify VALUE ENCODER.

■ List of parameters that can be assigned

Keyboard	Display	Parameter	Description
VOLUME		VOLUME	Assigns the VOLUME parameter to the VALUE encoder. VOLUME: 0–127
PAN		PANPOT	Assigns the PANPOT parameter to the VALUE encoder. PANPOT: 0–127
TEMPO		TEMPO	Assigns the tempo of the F8 Clock messages to the VALUE encoder. TEMPO: 20–250
CTUNE		COARSE TUNING	Assigns the COARSE TUNING parameter to the VALUE encoder. COARSE TUNING: 0–127
FTUNE		FINE TUNING	Assigns the FINE TUNING parameter to the VALUE encoder. FINE TUNING: 0–127
AFTER TOUCH		AFTERTOUCH	Assigns the AFTERTOUCH parameter to the VALUE encoder. AFTERTOUCH: 0–127
CTRL CHANGE		CONTROL CHANGE	Assigns the CONTROL CHANGE parameter to the VALUE encoder. CONTROL CHANGE: 0–127
CHO LEVEL		CHORUS LEVEL	Assigns the CHORUS LEVEL parameter to the VALUE encoder. CHORUS LEVEL: 0–127
REV LEVEL		REVERB LEVEL	Assigns the REVERB LEVEL parameter to the VALUE encoder. REVERB LEVEL: 0–127
KEY VELO		KEY VELOCITY	Assigns the KEY VELOCITY parameter to the VALUE encoder. In KEY VELOCITY MODE, the velocity value is fixed. The PC-50 transmits velocity values that correspond to the force with which you play the keyboard, but if KEY VELOCITY is assigned to the VALUE encoder, the fixed velocity value you specify using the VALUE encoder will be transmitted regardless of how you actually play the keyboard. Use KEY VELOCITY MODE if you don't want the velocity values to be affected by how you play the keyboard. KEY VELOCITY: tch, 1–127 * If you use the VALUE encoder to set the value to “tch”, the transmitted velocity will correspond to the force with which you actually play the keyboard.

5 Press the **[ENTER]** button.

● If you've selected “Control Change” as the parameter

6 Use the **VALUE encoder** or the **keyboard** to specify the control change number.

7 Press the **[ENTER]** button.

FACTORY RESET (Keyboard: 6)

Perform steps 1–3 (p. 61).

- 4 The display will indicate “RST.”



- 5 Press the **[ENTER]** button.
The display will blink “YES” and blink.



Set the **ADVANCED DRIVER**

Use the **ADVANCED DRIVER Switch** (p. 11) to switch ADVANCED DRIVER ON / OFF.

Normally, we recommend that you use **ON**.

On Mac OS X, you can also use this with the ADVANCED DRIVER OFF setting.

ON	This is the operating mode when the ADVANCED DRIVER switch is ON. *FPT technology is used to perform high-speed MIDI transfer. Normally, we recommend that you use this mode.
OFF	This is the operating mode when the ADVANCED DRIVER switch is OFF. Select this if you are using the standard MIDI driver provided by your operating system. On Mac OS X, you can also use this with the ADVANCED DRIVER OFF setting.

* **FPT = Fast Processing Technology for MIDI Transmission:**

Effective use is made of the USB bandwidth according to the amount of MIDI data to be transmitted, ensuring that MIDI data processing will always occur optimally.



In order for the setting of the ADVANCED DRIVER switch to take effect, you must exit all sequencer software and other softwares that use the PC-50, and turn the PC-50's power off, then switch it on again.

MEMO

Appendices

Troubleshooting	p. 72
MIDI implementation	p. 79
Main specifications	p. 83

Troubleshooting



Problems common to Windows and Macintosh



Problems occurring only in Windows



Problems occurring only in Macintosh

Trouble shooting is organized according to different operating systems. Refer to the icon(s) at the left of the title to find your items you need.

**For details on operating your Windows or Macintosh computer, refer to the owner's manual of the computer and operating system you are using.*

Problems related to the USB driver



Cannot install the driver correctly

Did you make the correct connections and settings for installation? Check each one of the following items.

- **Is the PC-50 connected correctly?**
Make sure that the USB connector of your computer is connected to the PC-50 by a USB cable.
- **Could any other USB device be connected?**
Before you install, disconnect all USB devices except for your mouse and keyboard.
- **Could other softwares or resident software (such as antivirus programs) be running?**
Installation may not be successful if other programs are running.
Be sure to close all other programs before installation.
- **Is the CD-ROM correctly inserted into your CD-ROM drive?**
Installation is not possible unless the CD-ROM included with the PC-50 is inserted in your CD-ROM drive. Make sure that the CD-ROM is correctly inserted into your CD-ROM drive.
- **Are you installing the software from a networked CD-ROM drive?**
The software cannot be installed from a networked CD-ROM drive.
Be sure to close all other programs before installation.
- **Is the CD-ROM or the lens of the CD-ROM dirty?**
If the CD-ROM or the lens of the CD-ROM drive is dirty, the installer may not work correctly.
Clean the disc and/or lens using a commercially-available CD cleaner or lens cleaner.
- **Is your computer's power-conservation mode turned off?**
If power-conservation settings are enabled on your computer, please disable any such settings.
(For the procedure, refer to the owner's manual of your computer.)
- **Is there sufficient free space on your hard disk?**
Delete unneeded files to increase the amount of free space. After deleting the unneeded files, empty the recycling bin.



In the Device Manager, do you see “Other device,” “Unknown device,” or a device for which “?”, “!” or “x” is displayed?

If the driver installation could not be successfully completed, the installed driver may remain in an incomplete state. Make sure to install the driver over again.

(→“**Getting Connected and Installing Drivers (Windows)**” (p. 14)).



You attempted to install using the procedure in “Installing the driver,” but the installation was not successful.

Install the PC-50 driver once again as described in **Getting Connected and Installing Drivers (Windows)** (p. 14). Then, set the PC-50’s **ADVANCED DRIVER Switch** (p. 11) to **ON** (p. 69), power up the PC-50, and install the driver again.



Is OMS or FreeMIDI installed? (Mac OS 9)

The PC-50 driver cannot be installed unless OMS or FreeMIDI are installed. Please install OMS or FreeMIDI.



“Find new hardware wizard” does not execute automatically



“Find new hardware wizard” ends before the process is completed



“Found unknown device” appears even though you installed the driver



The “Insert Disk” dialog box does not appear

- **Is the USB cable connected correctly?**

Make sure that the PC-50 and your computer are correctly connected via a USB cable.

- **Does your computer or USB hub have sufficient power supply capacity?**

The PC-50 cannot be connected if insufficient power is supplied to it. Check whether one of the following cases apply.

- If you are using the PC-50 with a notebook computer that is running on its battery, operation may be unreliable with some models of computer. If this is the case, connect the AC adaptor to your notebook computer.
- The power conservation mode of your computer may limit the power that is supplied to USB. Check the settings of your computer.
- In some cases, the PC-50 cannot be used with a bus-powered hub (a hub that does not contain a power supply). Please use a self-powered hub (a hub that contains a power supply).

- **Is USB enabled on your computer?**

Refer to the operation manual for your computer, and make sure that USB is enabled.

- **Does your computer meet the USB specifications?**

If you are using a computer that does not fulfill the electrical requirements of the USB specifications, operation may be unstable. In this case, you may be able to solve the problem by connecting a USB hub.

If the above actions do not solve the problem, it is possible that the PC-50 has been incorrectly detected by the computer. Please reinstall the driver from the beginning of the procedure.

- **It has been found that in some cases, not all of the Windows 98 files required to support audio via USB are installed when a computer is shipped.**

Please contact the manufacturer of your computer.



Device Manager shows “?”, “!,” or “USB Composite Device”



The “Insert Disk” dialog box does not appear

- **It is possible that the computer has detected the PC-50 incorrectly.**

Re-install the driver. (→“Getting Connected and Installing Drivers (Windows)” (p. 14))



Can't install/delete/use the driver in Windows XP/2000

- **Did you log on to Windows as a user with administrative privileges?**

In order to install/delete/re-install the driver in Windows XP/2000, you must be logged into Windows as a user with administrative privileges, such as Administrator. For details, please contact the system administrator for your computer system.

- **Did you make “Driver Signing Options”?**

In order to install/re-install the driver, you must make “Driver Signing Options.”

(→**Windows XP** (p. 14), **Windows 2000** (p. 19))



Windows XP/2000 displays a “Hardware Installation” or “Digital Signature Not Found” dialog box

- **Did you make “Driver Signing Options”?**

In order to install/re-install the driver, you must make the settings described in “Driver Signing Options.”(→**Windows XP** (p. 14), **Windows 2000** (p. 19))



“Found unknown device” appears even though you installed the driver

- **Did you connect the PC-50 to a different USB connector than the one you used when installing the driver?**

If your computer or USB hub has two or more USB connectors, and you connect the PC-50 to a USB connector to which the PC-50 has never been connected before, the “Unknown device” dialog box may appear even on a computer onto which you have already installed the driver. Refer to “**Installing the driver**” (p. 14), and install the driver once again. This is not a malfunction.

If the “Found unknown device” dialog box appears even though the PC-50 is connected to the same USB connector as before, it is possible that the computer has detected the PC-50 incorrectly. Please reinstall the driver from the beginning of the procedure. (→“**Getting Connected and Installing Drivers (Windows)**” (p. 14).



PC-50 is not detected when making OMS or FreeMIDI settings (Mac OS 9 users)

- **Is the PC-50 detected?**

- Turn the PC-50's power off, then switch it on again.
- Reconnect the USB cable.
- If other USB devices are connected, connect only the PC-50.
- It is possible that the Macintosh did not correctly detect and initialize the PC-50. Leave the PC-50's USB cable connected, and restart your Macintosh. If it is still not detected, shut down your Macintosh, and then restart it.
- In some cases, the PC-50 will not be detected if you have connected it to the USB connector located on the keyboard of the Macintosh. Please connect it to a USB connector on the Macintosh itself.

Deleting the driver

If you were unable to install the driver according to the procedure given, the PC-50 may not be recognized correctly by the computer. In this case, use the following procedure to delete the driver, and then follow the procedure to install the driver once again.

■ Windows users

Here's how to uninstall the dedicated driver.

1. Start up Windows with the PC-50 disconnected.
Disconnect all USB cables other than a USB keyboard or USB mouse.
* *If you are using Windows XP Professional/2000, log on as a user that has administrative privileges (e.g., Administrator).*
2. Insert the CD-ROM into the CD-ROM drive of your computer.
3. From the Windows Start menu, choose "Run...."
In the Run dialog box, input the following into the Open field, and click [OK].
Windows XP/2000 users: D:\Driver\XP2k\Uninstall.EXE
Windows Me/98 users: D:\Driver\Me98\Uninstall.EXE
* *The drive name **D:** may be different on your system. Use the drive name for your CD-ROM drive.*
4. Follow the on-screen instructions to uninstall the driver.

■ Macintosh (Mac OS X) users

1. Start up Macintosh with the PC-50 disconnected.
Disconnect all USB cables other than a USB keyboard or USB mouse.
2. Double-click "PC50_Uninstaller."
3. The display will indicate "This uninstalls EDIROL PC-50 driver from this Macintosh."; click [Uninstall].
* *If any other message appears, proceed as directed by that message.*
4. The display will indicate "Are you sure to uninstall the driver?"; click [OK].
5. The "Authenticate" dialog box will appear; enter the password and click [OK].
6. The display will indicate "Uninstillation is completed."; click [Restart]. Your computer will then restart.

■ Macintosh (Mac OS 9) users

1. Turn off the power of the PC-50.
Also disconnect the USB cable (by which the PC-50 is connected) from your Macintosh.
2. From the system extensions folder, drag "USB PC-50 Driver" into the trash to delete it.
3. Delete PC-50 from the OMS Folder inside the System folder, or drag PC-50 Driver from the FreeMIDI Folder inside the System folder to the trash.
4. Restart the Macintosh.

Problems when using the PC-50



Sound is interrupted during MIDI playback

- **In Windows, did you make the setting described in “Giving priority to background services”?**

In order to ensure that MIDI processing occurs smoothly, make the setting described in “Giving priority to background services.”(→**Windows XP**(p. 18), **Windows 2000**(p. 22))



Can't play back / record MIDI

- **Did you plug in the USB cable, or unplug it while an software was running?**
Exit all softwares that are using the PC-50, and exit all softwares that are using the PC-50, and turn the PC-50's power off, then switch it on again.
- **Is your computer in Suspend or Sleep mode?**
If so, get your computer to resume normal operation, then exit all softwares that are using the PC-50. Next, turn the PC-50's power off, then switch it on again.
- **Have you specified the MIDI data output destination in your playback software?**
For some software, you may need to specify the PC-50 as the output destination for MIDI data. For details on making this setting, refer to the owner's manual of the software you are using.
- **Was the driver installed correctly?**
In order for you to play back audio data via the PC-50, the driver must be installed. For installation and settings, refer to “**Getting Connected and Installing Drivers**” (**Windows**: p. 14/ **Macintosh**: p. 27).
- **Are you running multiple softwares?**
If multiple softwares are running simultaneously, an error message may appear. If this occurs, click **[OK]** and exit the other softwares.
Even if an software window is closed, it is still running if it appears in the taskbar. Be sure to exit unneeded softwares displayed.



Playback or recording halts midway through, and then becomes impossible

- **Was a heavy processing load experienced while using the PC-50, such as accessing the CD-ROM drive or a network?**
If an operation involving a heavy processing load is performed while the PC-50 is in use, it may not operate correctly. If this occurs, stop playback/recording, and then try resuming playback/recording. If you are still unable to play back/record, exit all softwares that use the PC-50, switch off the PC-50, then turn it on again.



Operating system becomes unstable

- **Operation becomes unstable when the computer is started up with the PC-50 already connected**

Please start up your computer with the PC-50 disconnected, and then connect the PC-50. On a computer that uses a USB keyboard, starting up the computer with the PC-50 already connected may cause operation to become unstable. In this case, start up the computer with the PC-50 disconnected, and then connect the PC-50.



The display indicates “Lo.”

When the batteries run low, the display will indicate “Lo.” If this message appears, replace the batteries as soon as possible.

Replacing the batteries will not erase the contents of SYSTEM settings.

MIDI implementation

Model: PC-50 Version 1.002005.04.1

1. Transmit data

■ Channel voice messages

● Note off

Status	2nd byte	3rd byte
9nH	kkH	00H

n = MIDI channel number: 0H – FH (Ch.1 – 16)
kk = note number: 00H – 7FH (0 – 127)

* Transmitted when you release a key in Play mode.

● Note on

Status	2nd byte	3rd byte
9nH	kkH	vvH

n = MIDI channel number: 0H – FH (Ch.1 – 16)
kk = note number: 00H – 7FH (0 – 127)
vv = note on velocity: 01H – 7FH (1 – 127)

* Transmitted when you push a key in Play mode.

● Control change

Status	2nd byte	3rd byte
BnH	ccH	vvH

n = MIDI channel number: 0H – FH (Ch.1 – 16)
cc = controller number: 00H – 7FH
vv = control value: 00H – 7FH

○ Bank Select (Controller number 0, 32)

Status	2nd byte	3rd byte
BnH	00H	mmH
BnH	20H	llH

n = MIDI channel number: 0H – FH (Ch.1 – 16)
mm = Bank number MSB: 00H – 7FH
ll = Bank number LSB: 00H – 7FH

○ Modulation (Controller number 1)

Status	2nd byte	3rd byte
BnH	01H	vvH

n = MIDI channel number: 0H – FH (Ch.1 – 16)
vv = Modulation depth: 00H – 7FH (0 – 127)

* Transmitted when you press the Modulation Controller in Play mode.

○ RPN MSB/LSB (Controller number 100, 101)

Status	2nd byte	3rd byte
BBnH	65H	mmH
BnH	64H	llH

n = MIDI channel number: 0H – FH (Ch.1 – 16)
mm = upper byte of parameter number specified by RPN
ll = lower byte of parameter number specified by RPN

RPN		Data entry		Explanation
MSB	LSB	MSB	LSB	
00H	01H	mmH		Master Fine Tuning mm: 00H-7FH
00H	02H	mmH		Master Coarse Tuning mm: 00H-7FH

● Program change

Status	2nd byte
CnH	ppH

n = MIDI channel number: 0H – FH (Ch.1 – 16)
pp = Program number: 00H – 7FH (prog. 1 – prog. 128)

● Channel pressure

Status	2nd byte
DnH	vvH

n = MIDI channel number: 0H – FH (Ch.1 – 16)
vv = Channel pressure: 00H – 7FH (0 – 127)

● Pitch bend change

Status	2nd byte	3rd byte
EnH	llH	mmH

n = MIDI channel number: 0H – FH (Ch.1 – 16)
mm, ll = Pitch Bend value: 00 00H – 40 00H – 7FH 7FH
(-8192 – 0 – +8191)

* Transmitted by rightward/leftward operation of the PITCH Bender in Play mode.

■ Channel mode messages

In addition to the channel mode messages that can be transmitted in Panic, the PC-50 lets you assign any channel voice message to the VALUE encoder and transmit it.

● Channel mode messages

Status	2nd byte	3rd byte
BnH	ccH	vvH

n = MIDI channel number: 0H – FH (Ch.1 – 16)

cc = controller number: 78H – 7FH

vv = control value: 00H – 7FH

○ All sounds off (Controller number 120)

Status	2nd byte	3rd byte
BnH	78H	00H

n = MIDI channel number: 0H – FH (Ch.1 – 16)

* Transmitted in Panic.

○ Reset all controllers (Controller number 121)

Status	2nd byte	3rd byte
BnH	79H	00H

n = MIDI channel number: 0H – FH (Ch.1 – 16)

* Transmitted in Panic.

○ All notes off (Controller number 123)

Status	2nd byte	3rd byte
BnH	7BH	00H

n = MIDI channel number: 0H – FH (Ch.1 – 16)

* Transmitted in Panic.

■ System realtime message

In addition to the Active Sensing messages that are transmitted constantly, the PC-50 allows you to assign the following system realtime messages (other than Active Sensing) to any controller and transmit them.

● Timing Clock

Status
F8H

* Transmitted if the System setting F8 CLOCK is ON.

● Start

Status
FAH

● Continue

Status
FBH

● Stop

Status
FCH

● Active sensing

Status
FEH

* Transmitted at intervals of approximately 250 ms.

● System reset

Status
FFH

2. Supplementary material

●Decimal and Hexadecimal table

(An "H" is appended to the end of numbers in hexadecimal notation.)

In MIDI documentation, data values and addresses/sizes of Exclusive messages, etc. are expressed as hexadecimal values for each 7 bits.

The following table shows how these correspond to decimal numbers.

Dec.	Hex.	Dec.	Hex.	Dec.	Hex.	Dec.	Hex.
0	00H	32	20H	64	40H	96	60H
1	01H	33	21H	65	41H	97	61H
2	02H	34	22H	66	42H	98	62H
3	03H	35	23H	67	43H	99	63H
4	04H	36	24H	68	44H	100	64H
5	05H	37	25H	69	45H	101	65H
6	06H	38	26H	70	46H	102	66H
7	07H	39	27H	71	47H	103	67H
8	08H	40	28H	72	48H	104	68H
9	09H	41	29H	73	49H	105	69H
10	0AH	42	2AH	74	4AH	106	6AH
11	0BH	43	2BH	75	4BH	107	6BH
12	0CH	44	2CH	76	4CH	108	6CH
13	0DH	45	2DH	77	4DH	109	6DH
14	0EH	46	2EH	78	4EH	110	6EH
15	0FH	47	2FH	79	4FH	111	6FH
16	10H	48	30H	80	50H	112	70H
17	11H	49	31H	81	51H	113	71H
18	12H	50	32H	82	52H	114	72H
19	13H	51	33H	83	53H	115	73H
20	14H	52	34H	84	54H	116	74H
21	15H	53	35H	85	55H	117	75H
22	16H	54	36H	86	56H	118	76H
23	17H	55	37H	87	57H	119	77H
24	18H	56	38H	88	58H	120	78H
25	19H	57	39H	89	59H	121	79H
26	1AH	58	3AH	90	5AH	122	7AH
27	1BH	59	3BH	91	5BH	123	7BH
28	1CH	60	3CH	92	5CH	124	7CH
29	1DH	61	3DH	93	5DH	125	7DH
30	1EH	62	3EH	94	5EH	126	7EH
31	1FH	63	3FH	95	5FH	127	7FH

* The decimal expression of the MIDI channel, program change, etc., is one greater than the decimal value shown in the table above.

* The hexadecimal expression for each 7 bits allows a maximum of 128 steps (0-127) to be expressed by one byte of data. Multiple bytes are used if the data requires greater resolution than this. For example, a value expressed by two 7-bit bytes "aa" and "bbH" would be $aa \times 128 + bb$.

* In the case of signed (+/-) data, 00H = -64, 40H = +/-0, and 7FH = +63; i.e., a value 64 less than the decimal value shown in the above table is used. In the case of a two-byte value, 00 00H = -8192, 40 00 = +/-0, and 7F 7F = +8191. For example, a value of "aa" and "bbH" would have a decimal expression of $aa \times 128 + bb - 64 \times 128$.

* In the case of data indicated as "use nibble data," hexadecimal expression in 4-bit units is used. A nibble-expressed value of the two bytes 0a and 0bH would have a value of $a \times 16 + b$.

<Example1>

What is the decimal expression of 5AH?

From the preceding table, 5AH = 90.

<Example2>

What is the decimal expression of the 7-bit hexadecimal value 12 34H?

From the preceding table, 12H = 18, and 34H = 52.

Thus, this is $18 \times 128 + 52 = 2356$

<Example3>

What is the decimal expression of the nibble-expressed value 0A 03 09 0D?

From the preceding table, 0AH = 10, 03H = 3, 09H = 9, and 0DH = 13.

Thus, this is $((10 \times 16 + 3) \times 16 + 9) \times 16 + 13 = 41885$

<Example4> What is the nibble-expressed value of decimal 1258?

$1258 \div 16 = 78$ (quotient) ... 10 (remainder)

$78 \div 16 = 4$ (quotient) ... 14 (remainder)

$4 \div 16 = 0$ (quotient) ... 4 (remainder)

From the preceding table, 0 = 00H, 4 = 04H, 14 = 0EH, 10 = 0AH.

Thus, the nibble-expressed value is 00 04 0E 0AH

MIDI KEYBOARD CONTROLLER

Date :Apr. 01, 2005

Model PC-50

MIDI Implementation Chart

Version : 1.00

Function...	Transmitted	Recognized	Remarks
Basic Channel Default Changed	1 1-16	X X	
Mode Default Messages Altered	Mode 3 OMNI ON, MONO, POLY *****	X X X	
Note Number : True Voice	0-127 *****	X X	
Velocity Note On Note Off	O (9n v=1-127) O (9n v=0)	X X	
After Touch Key's Channel's	X O	X X	
Pitch Bend	O	X	
Control Change 0-119	O	X	
Program Change : True Number	O (0-127) *****	X X	
System Exclusive	O *1	X	
System Common : : Song Position : Song Select : Tune Request	X X X	X X X	
System Real Time : : Clock : Commands	O O	X X	
Aux Messages : : All Sound Off : Reset All Controllers : Local On/Off : All Notes Off : Active Sensing : System Reset	O *2 (120) O *2 (121) X O *2 (123) O O	X X X X X X	
Notes	* 1 GM2 SYSTEM ON only. * 2 When PANIC is transmitted.		

Mode 1 : OMNI ON, POLY
Mode 3 : OMNI OFF, POLYMode 2 : OMNI ON, MONO
Mode 4 : OMNI OFF, MONOO : Yes
X : No

Main specifications

■ PC-50: MIDI KEYBOARD CONTROLLER

● Keyboard

49 keys (with velocity)

● Controllers

MIDI Channel Button

Program Change Button

Octave Shift Buttons (+/-)

Pitch Bend/Modulation Lever

VALUE Encoder Knob

● Display

7 segments, 3 characters (LED)

● Side Panel

Power Switch (USB BUS/OFF/DC IN)

ADVANCED DRIVER Switch (ON/OFF)

● Connectors

Hold Pedal Jack

Expression Pedal Jack

MIDI OUT Connector

USB Connector

DC IN Jack

● Power Supply

DC 9 V (AC Adaptor), USB Bus Power,
Dry battery LR6 (AA) type (alkaline) x 4

● Current Draw

150 mA

Expected battery life under continuous use:
Alkaline: 10 hours

* *This figure will vary depending on the actual conditions of use.*

● Dimensions

833 (W) x 183.8 (D) x 84 (H) mm

32-13/16 (W) x 7-1/4 (D) x 3-5/16 (H) inches

● Weight

2.7 kg / 6 lbs

● Accessories

CD-ROM

USB Cable

Owner's Manual

● Options

AC Adaptor: BOSS PSA series

Pedal Switch: DP series

Expression Pedal: EV-5

* *In the interest of product improvement, the specifications and/or appearance of this unit are subject to change without prior notice.*

INDEX

A

AC Adaptor Jack	11
Active Sensing	80
ADVANCED DRIVER switch	11, 69
AFTERTOUCH	67
All Notes Off	59, 80
All Sounds Off	59, 80
AppleTalk	31, 33
Audio MIDI Setup	28

B

Bank	
Bank Select	49, 79
LSB	48
MSB	49
Transmitting a Bank Select message	48–49
What is a bank?	46
Batteries	12
BUS Power	11, 74

C

C TUNE	67
Cancel Button	10
Channel Mode Messages	80
Channel Pressre	79
Channel Voice Messages	79
CHO	67
Chorus Level	67
CNT	53
Coarse Tuning	67
Cont	53
Continue	53, 80
Continue playback from the current location	53
Control Change	67, 79
CONTROLLER Mode	
Starting Playback	41, 51
Stopping Playback	41, 52
To switch the PC-50 to CONTROLLER mode... ..	50
Transmitting the value of a specific parameter	41, 60
What is CONTROLLER mode?	50
Current Channel	45

D

Data Out	10
DC	11
Device	
Device Settings	36
Preferred Device	25
Unknown Device	73, 75
Digital Signature	20–21
Display	10
Driver	
Driver Signing	14, 17, 19, 21
Getting Connected and Installing Drivers	13
What is a driver	13

E

Enter Button	10
Expression	44
Expression Jack	11

F

F TUNE	67
F8 Clock	
F8 Clock Dfault Tempo	61–62
F8 Clock On/Off	61–62
Factory Reset	61, 68
FAh	51
FBh	53
Features Useful When Playing	
Applying Pitch Changes to Notes	44
Changing Octaves	44
Modifying the Sound of Notes	44
Fine Tunung	67
Foot Switch	44
FPT	69
FreeMIDI	30, 34

G

GM2	58
GM2 Sys On	58
GM2 System On	
Transmitting a GM2 System On message	58

H

Heavy	63
Hold	44
Hold Jack	11

I

Input / Output Devices 36
 Insert Disk 16, 20

K

Key Velocity 61, 64, 67
 Keyboard Sensitivity 63

L

Light 63
 Lo 12
 LSB 48

M

Medium 63
 MIDI
 MIDI CH 45
 MIDI CH Button 10
 MIDI Device 24–26, 28
 MIDI flow 38–40
 MIDI I/F Mode 38–39, 61, 65
 MIDI In Device 36, 38–39
 MIDI Interface 39, 61
 MIDI Out Connector 11
 MIDI Out Device 36, 39
 Selecting Sounds on a Sound Module 46
 Setting the MIDI Transmit Channel 45
 Use MIDI functionality 41
 MNO 55
 Modulation 41, 44, 79
 MONO 55
 Mono Mode
 Transmitting a Mono Mode On message 55
 MSB 49
 Multimedia Properties 25–26

N

Note off 79
 Note on 79

O

Octave 10
 Octave -/+ Button 10
 Octave Shift 44
 OFF 11
 OMS 30–31

P

PAN 67
 PANIC 59
 Panpot 67
 Pedal Switch 44
 Pitch 10, 44
 Pitch Bend 41, 44
 Pitch Bend Change 79
 Pitch Bend/Modulation Lever 10
 PLAY Mode
 Functions in PLAY mode 41
 Play 41, 43
 Setting the MIDI Transmit Channel 41, 45
 Starting Playback 41, 51
 Stopping Playback 41, 52
 To switch the PC-50 to PLAY mode 41
 Transmitting a Program Change message 41, 47
 Transmitting the value of a specific parameter 41, 60
 What is PLAY mode? 41
 PLY 54
 PNC 59
 POF 57
 POLY 54
 Poly Mode
 Transmitting a Poly Mode On message 54
 PON 56
 PORTA OFF 57
 PORTA ON 56
 Portamento
 Transmitting a Portamento Off message 57
 Transmitting a Portamento On message 56
 Power Switch 11
 Preferred Device 25
 Program Change 46, 79
 Program Change Button 10
 Transmit a Program Change message 47

R

Reset
 Transmitting a Reset message 59
 Reset All Controllers 59, 80
 Reverb Level 67
 RPN 79
 RST 68

S

Security Slot	11
Setting the MIDI Transmit Channel	45
Sounds and Audio Devices Properties	24
Sounds and Multimedia Properties	25
Start	51, 80
Stop	52, 80
SY0	61
System Realtime Message	80
System Reset	80
System Settings	
Advanced Driver setting	69
F8 Clock Default Tempo	61–62
F8 Clock On/Off	61–62
Factory Reset	61, 68
Key Velocity	61, 64
MIDI I/F Mode	61, 65
Value Encoder	61, 66
Velocity Curve	61, 63

T

TCH	64, 67
Tempo	61, 67
Timing Clock	80
TOUCH	64
Transmit Channel	45
Transmit Data	79

U

Unknown Device	73, 75
USB	10–11
USB Cable	8
USB connections with your computer	38–39
USB Connector	11
UTILITY Mode	54, 56
Continue playback from the current location	42, 53
Functions in UTILITY mode	42
Make System Settings	42
To switch the PC-50 to UTILITY mode	42
Transmitting a Bank Select LSB message	42, 48
Transmitting a Bank Select MSB message	42, 49
Transmitting a GM2 System On message	42, 58
Transmitting a Mono Mode On message	42, 55
Transmitting a Poly Mode On message	42
Transmitting a Portamento Off message	42, 57
Transmitting a Portamento On message	42
Transmitting a Reset message	42, 59
What is UTILITY mode?	42

V

VALUE ENCODER	10, 60–61, 66
Velocity Curve	61, 63
Vibrato	10, 41, 44
Volume	67



For EU Countries

This product complies with the requirements of European Directive 89/336/EEC.

For the USA

FEDERAL COMMUNICATIONS COMMISSION RADIO FREQUENCY INTERFERENCE STATEMENT

This equipment has been tested and found to comply with the limits for a Class B digital device, pursuant to Part 15 of the FCC Rules. These limits are designed to provide reasonable protection against harmful interference in a residential installation. This equipment generates, uses, and can radiate radio frequency energy and, if not installed and used in accordance with the instructions, may cause harmful interference to radio communications. However, there is no guarantee that interference will not occur in a particular installation. If this equipment does cause harmful interference to radio or television reception, which can be determined by turning the equipment off and on, the user is encouraged to try to correct the interference by one or more of the following measures:

- Reorient or relocate the receiving antenna.
- Increase the separation between the equipment and receiver.
- Connect the equipment into an outlet on a circuit different from that to which the receiver is connected.
- Consult the dealer or an experienced radio/TV technician for help.

This device complies with Part 15 of the FCC Rules. Operation is subject to the following two conditions:

- (1) This device may not cause harmful interference, and
- (2) This device must accept any interference received, including interference that may cause undesired operation.

Unauthorized changes or modification to this system can void the users authority to operate this equipment.
This equipment requires shielded interface cables in order to meet FCC class B Limit.

For Canada

NOTICE

This Class B digital apparatus meets all requirements of the Canadian Interference-Causing Equipment Regulations.

AVIS

Cet appareil numérique de la classe B respecte toutes les exigences du Règlement sur le matériel brouilleur du Canada.

For the USA

DECLARATION OF CONFORMITY Compliance Information Statement

Model Name : PC-50
Type of Equipment : MIDI KEYBOARD CONTROLLER
Responsible Party : Roland Corporation U.S.
Address : 5100 S. Eastern Avenue, Los Angeles, CA 90040-2938
Telephone : (323) 890 3700

