

***All-Alert System Clock Radio
With Dual Alarms, Digital Tuning
And Specific Area Message Encoding***



OWNER'S MANUAL

CKW2000



Visit our web site at www.emersonradio.com





CAUTION

TO PREVENT FIRE OR SHOCK HAZARD, DO NOT USE THIS PLUG WITH AN EXTENSION CORD, RECEPTACLE OR OTHER OUTLET UNLESS THE BLADES CAN BE FULLY INSERTED TO PREVENT BLADE EXPOSURE. TO PREVENT FIRE OR SHOCK HAZARD, DO NOT EXPOSE THIS APPLIANCE TO RAIN OR MOISTURE.

 <p>The lightning flash with arrow-head symbol, within an equilateral triangle is intended to alert the user to the presence of uninsulated 'dangerous voltage' within the product's enclosure that may be of sufficient magnitude to constitute a risk of electric shock to persons.</p>	<p style="text-align: center;">CAUTION RISK OF ELECTRIC SHOCK DO NOT OPEN</p> <p>WARNING: TO REDUCE THE RISK OF ELECTRIC SHOCK DO NOT REMOVE COVER (OR BACK), NO USER SERVICEABLE PARTS INSIDE REFER SERVICING TO QUALIFIED SERVICE PERSONNEL.</p>	 <p>The exclamation point within an equilateral triangle is intended to alert the user to the presence of important operating and maintenance (servicing) instructions in the literature accompanying the appliance.</p>
--	--	---

The Caution Marking maybe located at the bottom enclosure of the apparatus.

IMPORTANT SAFETY INSTRUCTIONS

- 1.) Read these instructions. Keep these instructions. Follow all instructions. Heed all warnings.
- 2.) Do not use this apparatus near water.
- 3.) Clean only with dry cloth.
- 4.) Do not block any ventilation openings. Install in accordance with the manufacturer's instructions.
- 5.) Do not install near any heat sources such as radiators, heat registers, stoves, or other apparatus (including amplifiers) that produce heat.
- 6.) Do not defeat the safety purpose of the polarized or grounding-type plug. A polarized plug has two blades with one wider than the other. A grounding type plug has two blades and a third grounding prong. The wide blade or the third prong is provided for your safety. If the provided plug does not fit into your outlet, consult an electrician for replacement of the obsolete outlet.
- 7.) Protect the power cord from being walked on or pinched particularly at plugs, convenience receptacles, and the point where they exit from the apparatus.
- 8.) Only use attachments / accessories specified by the manufacturer.
- 9.) Unplug this apparatus during lightning storms or when unused for long periods of time.
- 10.) Refer all servicing to qualified service personnel. Servicing is required when the apparatus has been damaged in any way, such as power-supply cord or plug is damaged, liquid has been spilled or objects have fallen into the apparatus, the apparatus has been exposed to rain or moisture, does not operate normally, or has been dropped.
- 11.) This appliance shall not be exposed to dripping or splashing water and no object filled with liquids such as vases shall be placed on the apparatus.
- 12.) Use only with the cart, stand, tripod, bracket, or table specified by the manufacturer, or sold with the apparatus. When a cart is used, use caution when moving the cart/apparatus combination to avoid injury from tip-over.
- 13.) Do not overload wall outlet. Use only power source as indicated.
- 14.) Use replacement parts as specified by the manufacturer.
- 15.) The product may be mounted to a wall only if recommended by the manufacturer.
- 16.) Upon completion of any service or repairs to this product, ask the service technician to perform safety checks.



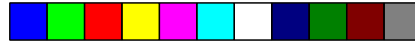

Thank you for purchasing this All-Alert Clock Radio from Emerson Research.

This model incorporates the All-Alert messaging system that will be used by the National Oceanic and Atmospheric Administration of the U.S. Government to alert the public about weather emergencies and a whole range of other emergency situations that may occur in your area. In addition, this model includes the Specific Area Message Encoding (SAME) system that will prevent you from receiving messages that do not apply to your specific geographic area.

The CKW2000 also includes a digital tuning AM/FM clock radio with dual alarms to keep you on time and entertained as well as informed.

This is a high technology product with many more features than usually found in a typical clock radio. It is absolutely essential that you read and understand this instruction manual in order to operate this product correctly, and to get the maximum benefit out of all the features we have included in this model.

If after reading this manual you are still having problems with the set-up and operation of this model, please do not return it to the retail store. Please call the Emerson Research Customer Service Hot-Line, toll free, at 800-898-9020, between the hours of 9:00 AM and 5:00 PM, Central Time, Monday through Friday. One of our technicians will try to trouble shoot and solve your problems by phone.

Once again, thank you for purchasing this All-Alert Clock Radio from Emerson Research.

The serial number of your unit is located on a label on the bottom cabinet. Please take a moment now to locate the number and to write the number in the space provided on the warranty page of this manual. This number provides information regarding the date of manufacture of your unit. You may be asked to provide this number when calling for customer service.

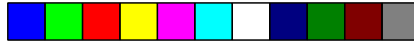

IMPORTANT NOTES

- Avoid installing this unit in places exposed to direct sunlight or close to heat radiating appliances such as electric heaters, on top of other stereo equipment that radiates too much heat, places lacking ventilation or dusty areas, places subject to constant vibration and/or humid or moist areas.
- Operate controls and switches as described in the manual.
- Before turning on the power, make certain that the AC power cord is properly installed.
- When moving the set, be sure to first disconnect the AC power cord.

FCC Information

This equipment has been tested and found to comply with the limits for a Class B digital device, pursuant to Part 15 of the FCC Rules. These limits are designed to provide reasonable protection against harmful interference in a residential installation. This equipment generates, uses, and can radiate radio frequency energy and, if not installed and used in accordance with the instructions, may cause harmful interference to radio communications. However, there is no guarantee that interference will not occur in a particular installation. If this equipment does cause harmful interference to radio or television reception, which can be determined by turning the equipment off and on, the user is encouraged to try to correct the interference by one or more of the following measures:

- Reorient or relocate the receiving antenna.
- Increase the separation between the equipment and receiver.
- Connect the equipment into an outlet on a circuit different from that to which the receiver is connected.
- Consult the dealer or an experienced radio/TV technician for help.

This device complies with Part 15 of the FCC Rules. Operation is subject to the following two conditions:

- (1) This device may not cause harmful interference, and
- (2) This device must accept any interference received, including interference that may cause undesired operation.

Changes or modifications not expressly approved by the party responsible for compliance could void the user's authority to operate the equipment.



PREPARATION FOR USE

Unpacking and Set Up

- The display carton contains the clock radio, the AC adapter, and the external antenna wire. Please make sure that all of the components are removed from the carton before disposal. We recommend that you retain the carton and packing materials, if possible, in the event that your unit ever needs to be returned for service. Using the original carton and packing materials is the only way to properly protect your unit from damage in transit. If you do dispose of the carton and packing materials, please do so properly. Emerson cares about our environment.
- Place the clock radio on a stable, level surface such as a table, desk, shelf or stand, convenient to an AC outlet, out of direct sunlight, and away from sources of excess heat, dust, moisture, or strong magnetic fields.

Protect Your Furniture

This model is equipped with non-skid rubber 'feet' to prevent the product from moving when you operate the controls. These 'feet' are made from non-migrating rubber material specially formulated to avoid leaving any marks or stains on your furniture. However certain types of oil based furniture polishes, wood preservatives, or cleaning sprays may cause the rubber 'feet' to soften, and leave marks or a rubber residue on the furniture. To prevent any damage to your furniture we strongly recommend that you purchase small self-adhesive felt pads, available at hardware stores and home improvement centers everywhere, and apply these pads to the bottom of the rubber 'feet' before you place the product on fine wooden furniture.



Installing The Back-Up Batteries – IMPORTANT!

Although this clock radio operates primarily on normal 120V AC 60Hz house current with the included AC adapter, it is extremely important that you install 4 “AA” batteries in the back up battery compartment located on the bottom cabinet. The back up batteries not only maintain the time and alarm settings in the event of a power interruption, but they also maintain your radio preset memory stations, and they insure that you will still receive NOAA emergency alert warnings even if the electrical power service to your home has been interrupted.

- Remove the battery compartment cover by pressing down on the ‘arrow’ symbol and sliding the cover in the direction of the arrow.

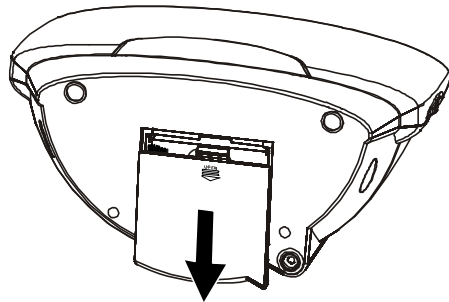

- Insert 4 “AA” batteries, not included, into the back up battery compartment, as shown. We recommend that you use a well-known brand of Alkaline batteries for longest life and best performance. Be sure to install the batteries correctly according to the polarity markings engraved in the battery compartment. If the batteries are inserted incorrectly the battery back up system will not work.

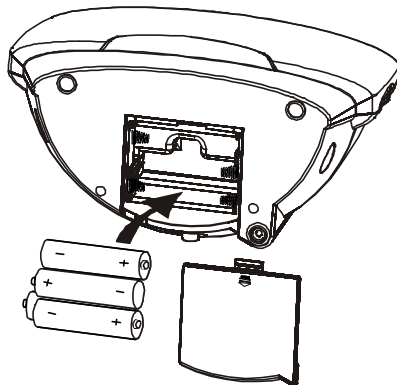

- Replace the battery compartment cover.

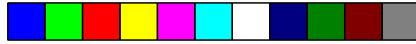

After installing the batteries the LCD panel will show the Time and Date display. The LCD panel backlighting will remain on for 5 seconds and then shut off automatically to preserve the battery life.

Remember that if the back up batteries are not installed, or are installed incorrectly, the clock and alarm time memory, and all of the preset radio station memories, will have to be reset after every power interruption.

Replacing The Back-Up Batteries

When the back-up batteries need to be replaced a “Low Battery Warning” Indicator will begin to flash in the LCD panel.



When you see this indicator you should replace all 4 batteries with 4 fresh batteries. Do not mix old and new batteries, and do not mix different types of batteries such as Heavy-Duty, Alkaline, and Lithium together.

If weak or exhausted batteries are left in the radio for an extended period of time they may eventually leak and cause corrosion or other damage to your radio, and such corrosion damage from leaking batteries is not covered by your warranty.

Battery Precautions

- Replacement of batteries must be done by an adult.
- Do not mix old and new batteries.
- Do not mix alkaline, standard (carbon-zinc) or rechargeable (nickel-cadmium) batteries.
- The supply terminals are not to be short-circuited.
- Non-rechargeable batteries are not to be recharged.
- Exhausted batteries are to be removed.
- Only batteries of the equivalent type are to be used.
- Batteries are to be inserted with the correct polarity.
- Dispose of batteries properly. Do not dispose of batteries in fire. The batteries may explode or leak.



Installing The AC Adapter – IMPORTANT!

The wire of the AC adapter also functions as the FM antenna of this model. Please be sure to fully unwind the AC adapter cord and make sure the cord is extended to its full length for best FM reception.

Connect the small female plug of the AC adapter to the “DC 6V” jack on the back cabinet of the radio.

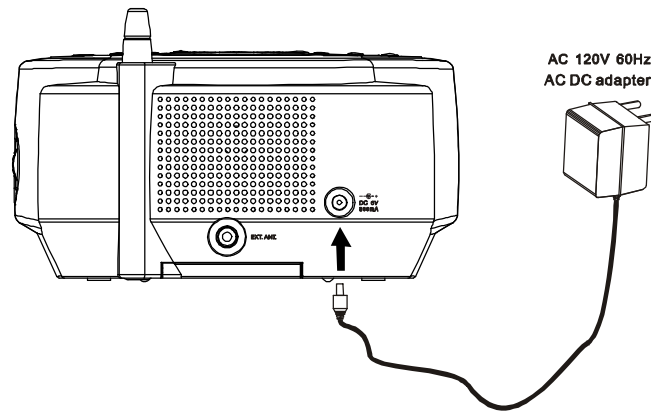

Connect the AC adapter block to your 120V AC 60Hz household outlet.

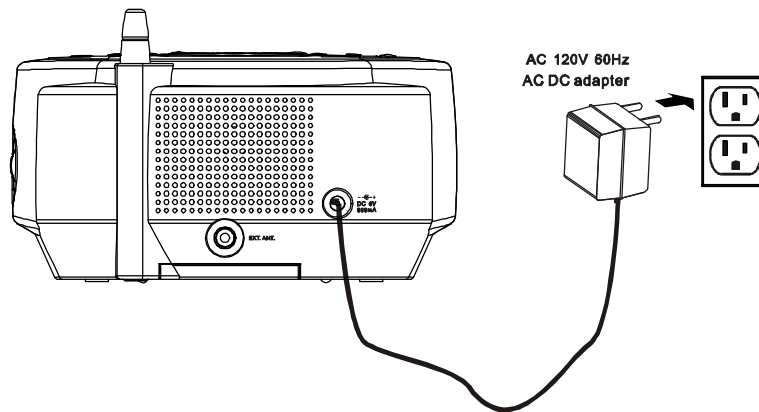

Warning: Do not connect or disconnect the AC adapter from the AC outlet while your hands are wet. The AC adapter may become warm during operation of the radio. This is normal and not an indication of any problem with your unit.

CAUTION: *This adapter is designed for connection to 120V AC 60Hz household outlets only. Connecting this adapter to any other power source may cause damage to the adapter and may also constitute a fire hazard.*

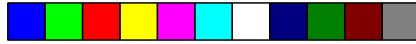

LOCATION OF CONTROLS AND INDICATORS

Front Panel

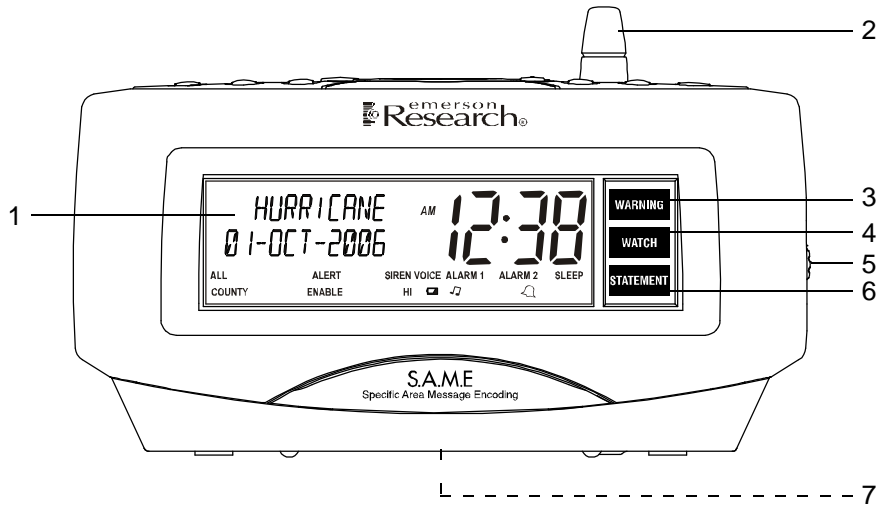

Top Panel

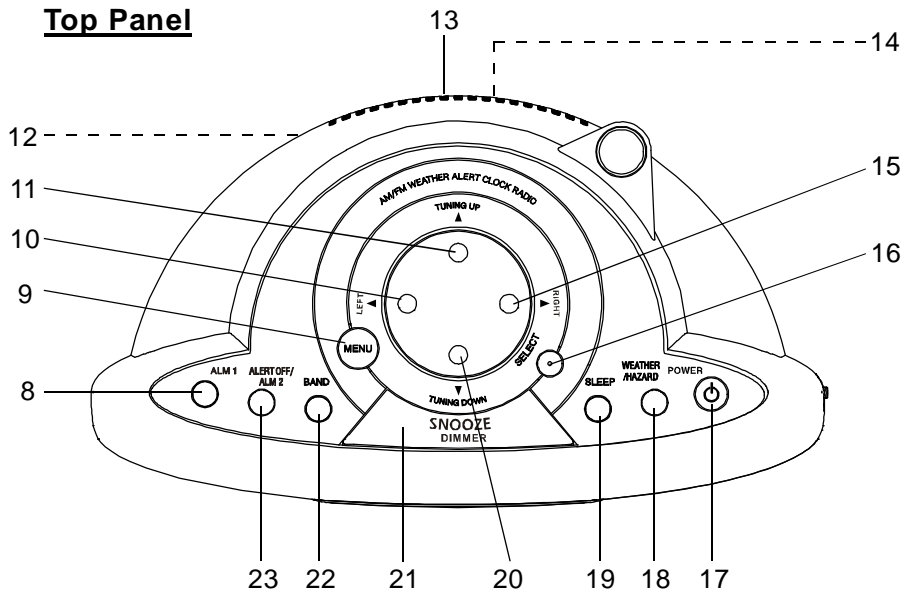



- 1.) Multi-Function LCD Display.
- 2.) Weather Band Telescopic Antenna.
- 3.) **WARNING** Indicator.
- 4.) **WATCH** Indicator.
- 5.) **VOLUME** Control.
- 6.) **STATEMENT** Indicator.
- 7.) Battery Compartment (Bottom Cabinet).
- 8.) **ALM** (Alarm) **1** Button.
- 9.) **MENU** Button.
- 10.) **◀ LEFT** Button.
- 11.) **▲ TUNING UP** Button.
- 12.) **DC 6V 300mA** Input Jack.
- 13.) Speaker.
- 14.) **Ext. ANT.** Jack.
- 15.) **▶ RIGHT** Button.
- 16.) **SELECT** Button.
- 17.) **⏻ POWER** (On/Off) Button.
- 18.) **WEATHER/HAZARD** Button.
- 19.) **SLEEP** Button.
- 20.) **▼ TUNING DOWN** Button.
- 21.) **SNOOZE / DIMMER** Button.
- 22.) **BAND** Button.
- 23.) **ALERT OFF/ALM 2** Button.



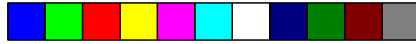

OPERATING INSTRUCTIONS

OPERATING INSTRUCTIONS FOR CLOCK AND RADIO

- Make sure that you have installed the back up batteries.
- Make sure that you have connected the AC adapter to the back of this unit and to your AC outlet.
- Make sure that the cord of the AC adapter is fully unwound and extended to its full length.

BASIC OPERATION / EXPLANATION OF CONTROLS

In order to minimize the number of controls on the top panel of this radio we have designed this radio with a **MENU** button, a **SELECT** button and four NAVIGATION buttons (▲/▼/◀/▶) similar to the navigation controls that you probably already use on your cell phone, PDA, or home computer. Most of the adjustments and changes in settings will be made with these three controls.

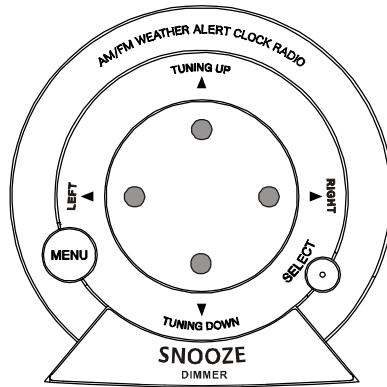



MENU Button

Press the **MENU** button to enter the Menu mode. Press again to exit the Menu mode and return to the normal Time and Date display. After 30 seconds with no user input the LCD will return to the normal Time and Date mode automatically.

NAVIGATION Buttons (**▲/▼/◀/▶**)

After pressing the **MENU** button once the display will show "**SETUP TIME**" which is the first menu option.

Pressing the **TUNING UP ▲** or **TUNING DOWN ▼** buttons allows you to scroll through the various menu options in the following order:

SETUP TIME

SETUP DATE

SETUP WEATHER CHANNEL

Input **COUNTY CODE (ALL / SINGLE / MULTIPLE) CODE #**

Select **ALERT MODE (SIREN / VOICE)**

DEFEAT SIREN

Select **ALERT VOLUME (SIREN HIGH / SIREN LOW)**

Select **BACKLIGHT** Operation Mode (**CONTINUOUS / NORMAL**)

ADD ALERT

SIREN TEST

SELECT Button

When the desired Menu appears on the display press the **SELECT** button to select that specific menu and then use the NAVIGATION buttons (**▲/▼/◀/▶**) to change that Menu's settings as desired.

The options and adjustments for each of these menus will be discussed in detail in separate sections of this manual.

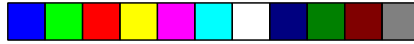

LCD Panel Backlighting (NORMAL Mode / CONTINUOUS Mode)

When you install the 4 back-up batteries in this unit the display backlighting automatically switches to the **NORMAL** mode to extend the battery life. In the **NORMAL** mode the backlighting will come 'on' when you press any one of the top panel control buttons and will go 'off' after 5 seconds with no further control input.

After you connect the AC adapter the display mode setting changes to **CONTINUOUS** automatically so that the display backlighting remains 'on' continuously.

NOTE: If the AC power supply is interrupted the backlighting will default to the **NORMAL** mode and the backlighting will go 'off' until any button is pressed. Then the backlighting will remain 'on' for 5 seconds and shut 'off' again to extend the battery life.

LCD Panel Brightness Control (SNOOZE/DIMMER Button)

Press the **SNOOZE/DIMMER** button repeatedly to switch the LCD backlighting between the Bright and Dim settings if necessary.

LCD Panel Viewing Angle – IMPORTANT

The LCD panel in this clock radio is designed to be the clearest and most visible when viewed from 'head-on' or when you are looking down on the display from above. If you are looking up at the display from below – for example, if you are lying in bed and the clock radio is on a nightstand or table that is higher than the bed – the numbers on the display may seem to fade or may be completely invisible.

This is a common characteristic of all liquid crystal displays and is not an indication of any problem with your unit. The display in this model was designed to be clearest when viewed from head-on or from above.

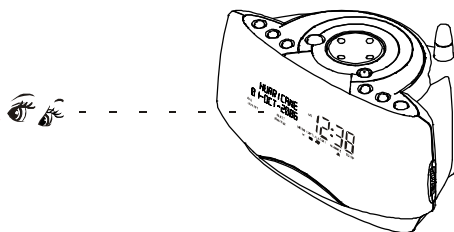

Correct View Angle

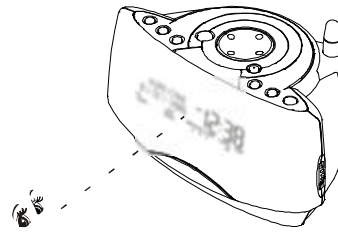

Incorrect View Angle

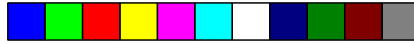

Setting The Time

When you install the 4 back up batteries the display comes 'on' and shows the initial default time and date setting:

"SUNDAY, 01 – JAN – 2006, 12:00".



Set the display to the correct time as follows:

1.) Press the **MENU** button once. The display shows "**SETUP TIME**"



2.) Press the **SELECT** button once. The Hour digits begin flashing.



3.) Press the ▲ or ▼ Navigation buttons to set the display to the correct hour.
Example: **2:00** PM.

Be sure to observe the **AM** indicator to confirm that you have set the hour correctly. If the **AM** indicator is 'on' the time displayed is AM. If the AM indicator is 'off' the time displayed is PM.



4.) When the correct hour is flashing, press ► navigation button. The hour digits stop flashing and the minute digits begin to flash.



5.) Press the ▲ or ▼ Navigation buttons to set the display to the correct minute.
Example: **2:30** PM.



6.) When the correct minute is flashing on the display press the **MENU** button once more to exit the SETUP TIME mode and return to the Time and Date display.



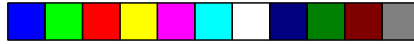

Setting The Date

- 1.) Press the **MENU** button once. The display shows "**SETUP TIME**".
- 2.) Press the **▲ (TUNING UP)** Navigation button. The display shows "**SETUP DATE**". The first time you enter the Setup Date mode the display will show "**01 – JAN – 2006**", which is the initial default date.
- 3.) Press the **SELECT** button once. The Date indicator begins flashing.
- 4.) Press the **▲** or **▼** Navigation buttons to set the display to the correct date.
Example: "**15**".
- 5.) Press **▶ (RIGHT)** Navigation button. The Month indicator begins flashing.
- 6.) Press the **▲** or **▼** Navigation buttons to set the display to the correct month.
Example: "**March**".
- 7.) Press **▶ (RIGHT)** Navigation button. The last two digits of the Year indicator begin flashing.
- 8.) Press the **▲ (TUNING UP)** Navigation button to set the display to the correct Year.
Example: "**2007**".
9. When the correct Date, Month, and Year appear in the display press the **MENU** button to exit the Setup mode. The correct Day will appear in the display corresponding to the Date you selected.



NOTE: After you press the **MENU**, (**▲/▼/◀/▶**), and **SELECT** buttons to enter the Time or Date Setup modes you must make your adjustments within 30 seconds. If no adjustments are made within 30 seconds the LCD will exit the Setup mode and return to the normal Time and Date display.



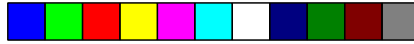

Setting The Alarm Times

This model has two alarms that can be set and used independently. You may set both alarms for Radio or Buzzer operation, or set one alarm for Radio and the other for Buzzer.

Setting The Alarm 1 Wake Up Time

- 1.) Depress and hold the **ALM 1** button for approximately 1 second.

The **"SET ALARM 1"** indicator appears and the Hour digits begin flashing.

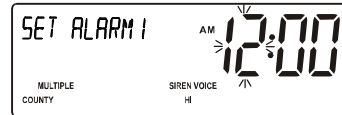
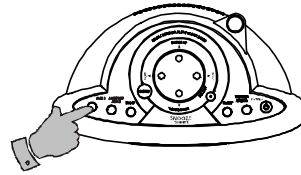

- 2.) Press the ▲ or ▼ Navigation buttons to set the display to the correct Alarm 1 wake up hour.

Example: **6:00 AM**

Be sure to observe the **AM** indicator to confirm that you have set the hour correctly. If the **AM** indicator appears the hour displayed is AM. If the **AM** indicator does not appear the hour displayed is PM.



- 3.) Press ► (**RIGHT**) Navigation button. The Minute digits begin flashing.

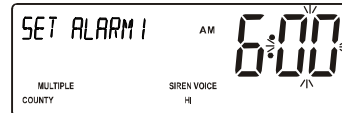

- 4.) Press the ▲ or ▼ Navigation buttons to set the display to the correct wake up minute.

Example: **6:30 AM**

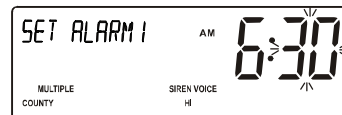

- 5.) When the LCD is showing the correct Alarm 1 Wake-Up Time press the **MENU** button or the **SELECT** button to return to the correct time and date display.



Setting The Alarm 2 Wake Up Time

- 1.) Depress and hold the **ALM 2** button for approximately 1 second.

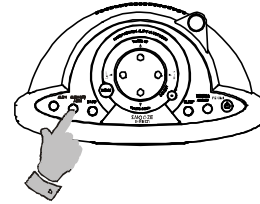

The “**SET ALARM 2**” indicator appears and the Hour digits begin flashing.



- 2.) Press the ▲ or ▼ Navigation buttons to set the display to the correct Alarm 2 wake up hour.

Example: **9:00 AM**

Be sure to observe the **AM** indicator to confirm that you have set the hour correctly. If the **AM** indicator appears the hour displayed is AM. If the **AM** indicator does not appear the hour displayed is PM.

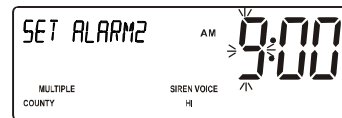

- 3.) Press ► (**RIGHT**) Navigation button. The Minute digits begin flashing.

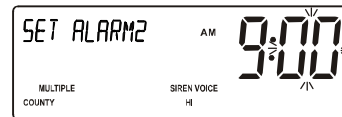

- 4.) Press the ▲ or ▼ Navigation buttons to set the display to the correct wake up minute.
Example: **9:15 AM**.

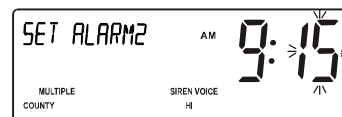

- 5.) When the LCD is showing the correct Alarm 2 Wake-Up Time press the **MENU** button or the **SELECT** button to return to the correct time and date display.





Selecting The Alarm Mode (Radio, Buzzer, or Off)

- 1.) Press the **ALM 1** button once.

The display shows the Alarm 1 Wake Up Time.

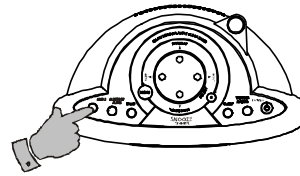

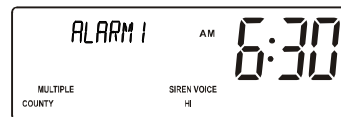

- 2.) Press the **ALM 1** button again. The **ALARM 1** indicator below the time display begins to flash.

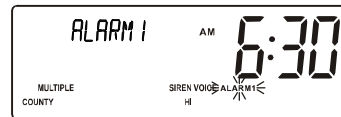

- 3.) Press the ▲ or ▼ Navigation buttons repeatedly to select the alarm mode.

If the 'Bell' symbol  flashes, the Alarm Mode is Buzzer.



If the 'Musical Notes' symbol  flashes, the Alarm Mode is Radio.

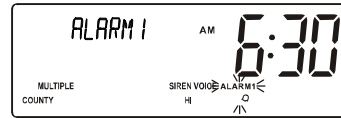

If no symbol is flashing below the **ALARM 1** indicator, the Alarm Mode is 'Off'.



- 4.) When the desired symbol is flashing together with the **ALARM 1** indicator, press the **ALM 1** button once more.

The LCD returns to the correct Time and Date display but the **ALARM 1** indicator and the Buzzer or Radio symbols remain in the display to confirm that the alarm is set.



The alarm will turn on every day at the selected time. It will continue for one hour and then shut off automatically.

- 5.) To cancel the alarm, repeat Steps 1, 2 and 3 above until no symbol is flashing below the **ALARM 1** indicator, then press the **ALM 1** button once more. The LCD returns to the correct Time and Date display but the **ALARM 1** indicator disappears.



To select the Alarm Mode for Alarm 2, repeat the procedure above using the **ALM 2** button instead of the **ALM 1** button.

Snooze Operation

When the Radio or Buzzer alarm turns 'on' in the morning you may press the **SNOOZE/DIMMER** button for a few minutes more sleep.

The **SNOOZE** indicator appears on the display.

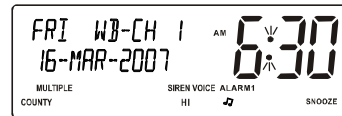

The alarm will stop for 9 minutes and then turn 'on' again. The Snooze operation may be repeated several times within one hour, but after one hour the alarm will reset itself for the following day and will not turn 'on' again.



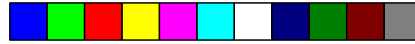

Listening To The Radio

This clock radio features a digital tuning AM/FM receiver that allows you to tune to the exact frequency of your desired station for the best possible reception. You may also store up to 10 of you favorite FM stations and 10 of your favorite AM stations in the preset memories for immediate and easy recall.

- 1.) Press the **POWER**  button to turn the radio 'On'.

The first time you turn the radio on the display will show "CH 01 WB-CH 01 FM 87.5 MHZ".



To switch between FM and AM bands, press the **BAND** button repeatedly.



- 2.) Press the **▲ TUNING UP** or **▼ TUNING DOWN** Navigation buttons to tune to the exact frequency of the desired station as follows:

- **Automatic Tuning**

Depress and hold the **▲** or **▼** Navigation button until the frequency display begins to move, then release the buttons. The receiver will scan until it finds the next strong frequency and stop on that frequency. Repeat this procedure until the display stops on the frequency of your desired station.

- **Manual Tuning**

Repeatedly press the **▲** or **▼** Navigation buttons to manually advance the frequency display up or down to your desired frequency.

NOTE: Use the Manual Tuning method to tune to weaker stations that may be bypassed by the Automatic Tuning method.

- 3.) Adjust the **VOLUME** control to the desired level.

- 4.) When you are finished listening press the **POWER**  button to turn the radio 'Off'. The LCD returns to the correct Time and Date display.



Antenna Information

AM

The AM bar antenna is inside the cabinet. If AM reception is unsatisfactory try rotating or repositioning the radio until you find the position that provides the best AM reception.

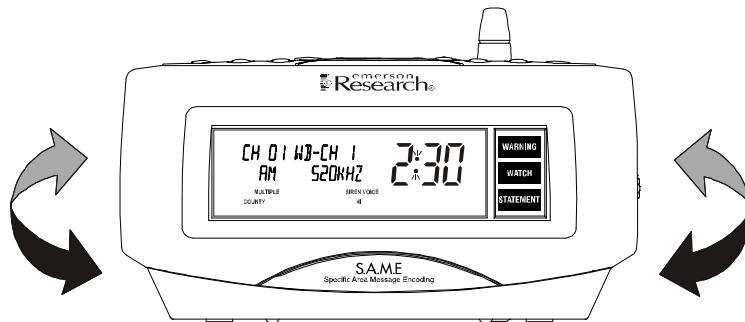

FM

The AC adapter wire serves as the FM antenna. Make sure that the adapter wire is completely unwound and extended to its full length. You may have to change the position or direction of this wire to find the position that provides the best FM reception.

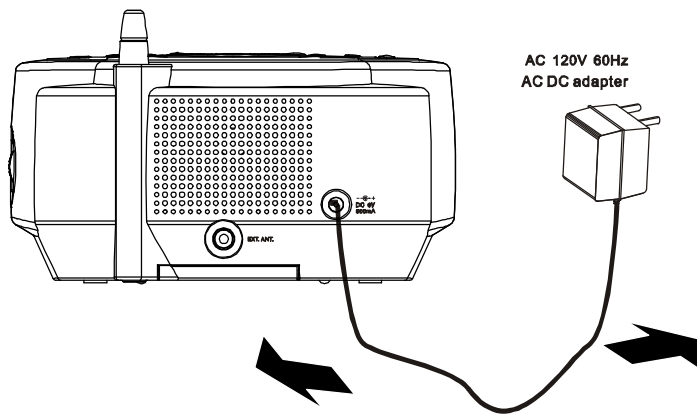

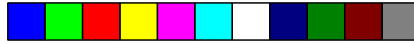

Presetting Stations In the Tuner Memory

- 1.) Follow steps 1 and 2 of “Listening To The Radio”, on page 19, to tune to the first station you wish to memorize.

Example: **FM 88.3 MHZ.**



- 2.) Press the **MENU** button once.

The **CH 01** indicator “**01**” begins to flash indicating that you can store the station in Preset Memory Channel 01.



- 3.) Press the **SELECT** button to store the selected station in Preset Memory Channel 01.

The “**01**” indicator stops flashing to confirm that the station is stored.



- 4.) Tune to the next station you wish to memorize.
Example: **FM 93.1 MHZ.**

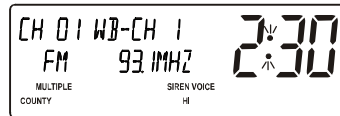

- 5.) Press the **MENU** button. The “**01**” Indicator will flash.

Press the **▲ TUNING UP** Navigation button once to advance the Preset Memory Channel Number from “CH 01” to “**CH 02**”.



- 6.) When the “**02**” indicator is flashing press the **SELECT** button to store the selected station in Preset Memory Channel 02.

The “**02**” indicator stops flashing and remains ‘on’ to confirm that the station is stored.



- 7.) Repeat Steps 4, 5 and 6, selecting a different Preset Channel Memory Number each time until you have stored up to 10 FM stations in the tuner memory.

- 8.) Press the **BAND** button to switch to the **AM** band and repeat the above procedure to store up to 10 AM stations in the tuner memory.



Recalling Preset Memory Stations

- Turn the Radio 'On' and press the **BAND** button to select the desired band.
- Press the ◀ or ▶ Navigation buttons to move to lower or higher numbered Preset Station Memory Numbers.

Changing Preset Station Memories

- Tune to the new station that you wish to memorize and press the **MENU** button.

The Preset Memory Channel Number flashes.



- Press the ▲ or ▼ Navigation buttons to select the Preset Memory Channel Number that you wish to change.
- When the desired Preset Memory Channel Number is flashing, press the **SELECT** button. The new station will be entered into the memory and the previously stored station will be deleted.

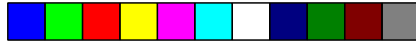

Sleep To Music Timer

The Sleep To Music Timer can be programmed to play the radio for up to 90 minutes and then shut 'off' automatically. The Sleep Timer can be activated while the radio is 'on' or 'off'.

- Tune to the desired station and set the **VOLUME** control to the desired level. Remember that the radio station and the volume level you select for the Sleep Timer is the same station and volume level that you will hear in the morning if you are using the Wake To Radio alarm mode.

- Press the **SLEEP** button. The LCD will show: "SET SLEEP TIME – 90 MIN" and the number "90" will flash for several seconds.



The radio will play for 90 minutes and then shut off automatically.

- To reduce the amount of Sleep Timer operation continue pressing the **SLEEP** button.

The display will count down from **90 > 60 > 30 > 15 > 00** as you continue to press the **SLEEP** button.

Release the **SLEEP** button when the display shows the desired amount of minutes.

The radio will play until the timer counts down to "00" and then shut off automatically.



- To shut the radio off before the Sleep Timer counts down to "00" press the **POWER**  button at any time.

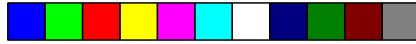

WEATHER BAND AND HAZARD ALERT OPERATION

Instant Weather Band Reception

The National Weather Service (**NWS**) currently operates 940 transmitters around the country to provide continuous 24-hour weather reports for all 50 states and surrounding coastal waters. These broadcasts are transmitted on seven different channels with the following frequencies:

<u>Channel #</u>	<u>Frequency</u>
1.	162.400 MHz
2.	162.425 MHz
3.	162.450 MHz
4.	162.475 MHz
5.	162.500 MHz
6.	162.525 MHz
7.	162.550 MHz



Your Emerson All-Alert Clock Radio receives all 7 of these frequencies clearly, and thanks to the sensitive digital tuner there is no cumbersome 'fine-tuning' required.

You must select the weather channel that provides coverage for your geographic area. This set-up is only done once and then your radio will automatically tune to the correct frequency whenever you press the **WEATHER/HAZARD** button.





To set up the radio to receive your local weather station:

- 1.) Fully extend the telescoping rod antenna. This antenna is only for the weather channel reception.

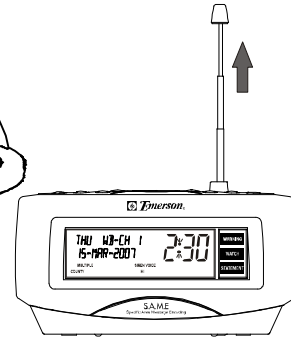
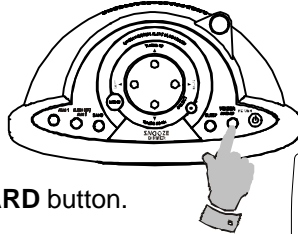

- 2.) Press the **WEATHER/HAZARD** button.

The LCD will show the Time and Date display and "**WB – CH 1**" indicating that the radio is receiving weather channel #1.

If you are receiving a strong, clear signal on channel #1, there is nothing else to do.



Every time you press the **WEATHER/HAZARD** button your radio will tune to weather channel #1. If you are listening to an AM or FM station when you press the **WEATHER/HAZARD** button the radio will automatically switch to the weather channel.

- 3.) If you receive a weak signal or no signal on channel #1, press the **MENU** button to access the Menu mode and then press the ▲ Navigation button two (2) times until the display shows "**SETUP WEATHER CH 1**"



- 4.) Press the **SELECT** button once. The CH "1" indicator begins flashing.



- 5.) Press the ▲ Navigation button slowly to advance the weather channel from #1 to #2 to #3 and so on. When you hear the clearest, strongest broadcast you have found the station that is covering your geographic area.

Press the **SELECT** button again to make that your default station. Once this is done whenever you press the **WEATHER/HAZARD** button your radio will automatically tune to that station.



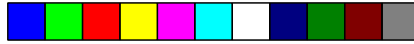

Notes:

- It may be necessary to change the direction of the rod antenna to receive the strongest signal. If you live in an area of poor reception and the rod antenna does not provide satisfactory reception we have included an external wire antenna to improve reception. Lower the rod antenna and connect the external antenna to the **EXT. ANT.** jack on the back panel and make sure the external antenna wire is fully unwound and extended.

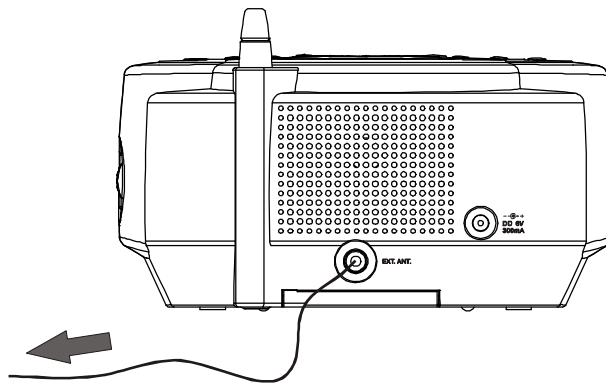

- If you are using this clock radio on a bedside table and you find that extending the rod antenna is not convenient, you may use the external antenna instead.

To listen to NOAA weather broadcasts at any time, press the **WEATHER/HAZARD** button once. If the radio was 'Off' it will turn 'On' to your local NOAA weather station.

If you were listening to an AM or FM station, the radio will switch to your local NOAA station. When you are finished listening press the **WEATHER/HAZARD** button again. The radio will shut 'Off' or will switch back to your AM or FM broadcast.

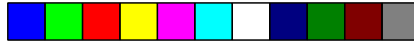

NWR All Hazards Emergency Messages

NOAA Weather Radio All Hazards (**NWR**) is an all-hazards public warning system, operated by the National Weather Service (**NWS**), broadcasting weather forecasts, warnings, and emergency information 24 hours a day directly to the public.

During an emergency, **NWS** forecasters interrupt routine broadcasts and send a special tone signal to activate local weather radios. Weather radios equipped with a special alarm tone feature, such as this **Emerson Research** model **CKW2000**, sound an alert to give you immediate information about a life-threatening situation. **NWR** broadcasts warnings and post-event information for all types of hazards:

- **Weather** (e.g., tornadoes, floods),
- **Natural** (e.g., earthquakes, forest fires and volcanic activity),
- **Technological** (e.g., chemical releases, oil spills, nuclear power plant emergencies, etc.), and...
- **National emergencies** (e.g., terrorist attacks).

Working with other Federal agencies and the Federal Communications Commission's (**FCC**) Emergency Alert System (**EAS**), **NWR** is an all-hazards radio network, making it the most comprehensive weather and emergency information available to the public.

Specific Area Message Encoding (S.A.M.E.)

Each **NRW** transmitter has a range of approximately 40 miles and may cover several counties in some cases. A normal weather alert radio without the **SAME** system will be activated by every alert signal from the nearest transmitter. As a result you could be receiving alert signals intended for people up to 80 miles away that do not apply to your area at all. The **SAME** system was developed to help eliminate these false alarms. The **Emerson Research** model **CKW2000** with **SAME** technology can be programmed to receive only the alerts that apply to the specific county in which you live. When programmed correctly you will no longer be awakened or disturbed by alerts that do not apply to you. Your **CKW2000** will then alert you only of weather and other emergencies for your specific county.

When an **NWS** office broadcasts a warning, watch or non-weather emergency message, it also broadcasts a digital **SAME** code that contains information about the type of message, the county(s) affected, and the message expiration time.

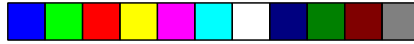

The **CKW2000** will turn on for that message, and you will hear a warning alarm tone as an attention signal, and an indicator light on the front panel will tell you if the alert is a '**WARNING**', a '**WATCH**', or a '**STATEMENT**' (Advisory). The type of alert will appear in the LCD display, followed by the broadcast message.

At the end of the broadcast message, you may hear a brief digital end-of-message static burst followed by a resumption of the **NWR** broadcast cycle.

Programming Your County Code In the CKW2000

To program your **CKW2000** with the proper county(s) and/or marine area(s) of choice, you need to know the 6-digit **SAME** code number(s) for that county(s). The number is available two ways:

Online at: <http://www.weather.gov/nwr/indexnw.htm#sametable>

On this web page you will first select the state in which you live and then you will see an alphabetical list of all the counties in that state with the **SAME#** for each county. This is the number that you must enter in the **CKW2000** to ensure that you only receive the alerts that apply to your county.

By telephone at **1-888-NWR-SAME (1-888-697-7263)**.

Follow the voice prompts asking for your state and county of residence and the computer will tell you the correct **SAME#** in your area.

For residents of Canada you may obtain your **SAME#** by visiting the Meteorological Service of Canada website at: <http://www.msc-smc.ec.gc.ca/msb/>

NOTE: Although the **SAME** encoding system allows you to eliminate alerts that do not apply to your specific area, the **CKW2000** still gives you the option to receive alerts for **MULTIPLE** counties (maximum 20), or to receive **ALL** alerts broadcast from the **NWR** transmitter serving your area.

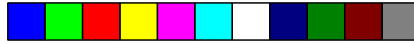

Once you have obtained your county's **SAME#** from the website or by phone, enter that number, or numbers, in the **CKW2000** as follows:

- 1.) If the radio is 'On', press the **POWER**  button to turn the radio 'Off'.
- 2.) Press the **MENU** button to enter the Menu mode.
- 3.) Press the **▲** Navigation button three (3) times

until the LCD is showing:

"COUNTY CODE – MULTIPLE"

The Multiple county mode is the factory default setting.



- 4.) Press the **SELECT** button. The **"MULTIPLE"** indicator begins 'flashing'.

Press the **▲** Navigation button to change the selection from **MULTIPLE > ALL > SINGLE > MULTIPLE**, etc.



- 5.) When the **SINGLE** indicator is flashing, press the **SELECT** button again to confirm that you want to program just one Single SAME code for your specific county.

The display will show **"CODE 01 000000"** and the **"01"** indicator will be flashing.



- 6.) Press the **▶ RIGHT** Navigation button to move the cursor to the first **"0"**. The **"0"** begins flashing. Press the **▲** or **▼** Navigation buttons to select the first digit of your SAME#.



- 7.) When the desired number is flashing press the **▶ RIGHT** Navigation button to move the cursor to the second **"0"**, then press the **▲** or **▼** Navigation buttons to select the second digit of your SAME#.

- 8.) Repeat Step 7 until you have entered all 6 digits of the desired SAME#, then press the **MENU** button to confirm your selection and return to the correct TIME and DATE display. A **SINGLE COUNTY** indicator will remain in the bottom of the display window.



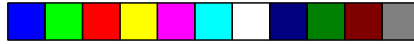

NOTES:

- If you selected “**MULTIPLE**” in Step 4 above, after you have entered all 6 digits of the first SAME#, the CODE “01” indicator begins flashing again. Press the ▲ Navigation button to advance the CODE number to “02” and then enter the second SAME# as described above.

The **MULTIPLE COUNTY** indicator will remain in the display.



- If you selected “**ALL**” in Step 4 above you will not be asked to enter any SAME#. Your radio will be activated by every alert signal broadcast by the **NWR** transmitter serving your area.

The **ALL COUNTY** indicator will remain in the display.



Once your radio is programmed with the SAME# for your specific county, it will only be activated by alert signals that apply to that specific county.

Other Settings and Adjustments

After you have selected the weather channel (1 –7) for your area and entered the correct SAME county code or codes, there are a few other adjustments that you can make to customize the operation of your **CKW2000**.

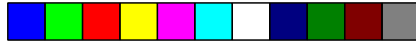

Select Alert Mode (Siren or Siren/Voice)

When the **SIREN** mode is selected and an alert is received, the Siren will continue for approximately 5 minutes and then shut off automatically. To stop the Siren sooner, press the **ALERT OFF/ALM 2** button.

When the **VOICE** mode is selected and an alert is received the Siren will sound for about 8 seconds and then the weather broadcast will turn on and continue for about 5 minutes.

To change the Alert Mode, make sure the radio is "Off", and then:

- Press the **MENU** button and then press the ▲ or ▼ Navigation buttons until the LCD is showing "**ALERT MODE**" and the current setting.
- Press the **SELECT** button. The current setting flashes. Then press the ▲ or ▼ Navigation buttons to switch between **SIREN** and **VOICE** settings.



When the desired setting is flashing press the **MENU** button to confirm the setting and exit the menu mode.

The LCD returns to the Time and Date display but the indicator for the selected setting remains at the bottom of the display.



NOTE: If you selected **VOICE** alert mode both the **SIREN** and **VOICE** indicators remain 'On'.



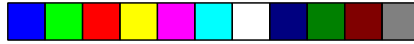

Defeat Siren Mode

You have the option of shutting off the Siren or Voice Alert warning for some of the alert messages that your radio may receive. If you select the Defeat Siren mode for a specific message type, when your radio receives that type of message the **WARNING**, **WATCH**, or **STATEMENT** lights will turn 'On' as usual and the alert message will appear in the display, but there will be no audible warning.



To Defeat the Siren for certain alerts, make sure the radio is "Off", and then:

- 1.) Press the **MENU** button; press the ▲ or ▼ Navigation buttons until the LCD is showing "DEFEAT SIREN", then press the **SELECT** button.



The alert messages will scroll across the display in alphabetical order beginning with "ADMINISTRATIVE MESSAGE" which is currently the first message on the list. The **ALERT DISABLE** indicator will appear at the bottom of the display indicating that for this specific message the default Siren Mode is 'Off'.



- 2.) If you wish to change the default Siren Mode for that specific alert, press the ◀ or ▶ Navigation buttons.

The words "ALERT ENABLE" will appear at the bottom of the display indicating that the Siren Mode is now 'On'.



Use the ◀ or ▶ Navigation buttons to switch back and forth between the **ALERT DISABLE** and **ALERT ENABLE** siren modes.

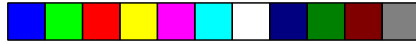

3.) Press the ▲ or ▼ Navigation buttons to select the next alert (currently “**AVALANCHE WATCH**”) then press the ◀ or ▶ Navigation buttons to change the Siren Mode setting for that alert if desired. **ALERT ENABLE** indicates that the siren mode is ‘on’. **ALERT DISABLE** indicates that the siren mode is ‘off’.



4.) Repeat Step 3 to select among all of the current alert messages and either Enable or Disable the siren mode for each message.



5.) When you are finished selecting the Siren Mode settings press the **MENU** button to return to the correct Time and Date display.



NOTE: Some alerts do not allow the option to defeat the audible warning. Please refer to the separate table listing all of the alert messages that this radio can receive. If the description in the Alert Sound column is followed by an asterisk (*), the audible warning can be switched ‘off’ for that type message.

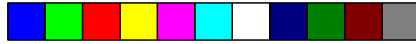

Select Siren Volume

You can select between a High or Low volume siren level.

- With the radio 'off', press the **MENU** button, then press the ▲ or ▼ Navigation buttons until the display shows "**ALERT VOLUME**" and the current setting.



Press the **SELECT** button and the current setting starts flashing.



- Press the ▲ or ▼ Navigation buttons to switch between the High and Low siren levels. You will hear two 'beeps' at either High or Low volume to confirm your selection, and the "**HI**" or "**LO**" indicator will remain in the bottom of the display.



NOTE: This adjustment only applies to the Siren Alert. The level of the Voice Alert is adjusted by the radio **VOLUME** control.

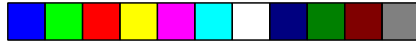

Backlight Operation (Normal / Continuous)

If the AC adapter is properly connected to your 120V AC outlet and to the “DC 6V” jack on the back of this radio, the display backlight defaults to the **CONTINUOUS** mode and is ‘On’ continuously.

If the AC power is interrupted and the radio is running on the 4 “AA” back-up batteries, the display backlight defaults to the **NORMAL** mode and shuts off to conserve the battery power.

In the **NORMAL** mode, pressing any button will switch the display backlight ‘on’ for 5 seconds, and then it goes ‘off’ again.

When AC power is restored the backlighting changes back to the **CONTINUOUS** mode automatically.

You may change the backlight from **CONTINUOUS** to **NORMAL** if you wish.

- With the radio ‘off’ press the **MENU** button, press the ▲ or ▼ Navigation buttons until the display is showing “**BACKLIGHT**” and the current setting.



- Press the **SELECT** button. The current setting flashes.

Press the ▲ or ▼ Navigation buttons to switch to the desired setting, then press the **MENU** button to exit the Menu mode and return to the Time and Date display.



NOTE: The Continuous mode cannot be selected if there is no AC power to the radio.

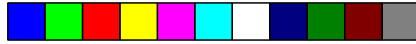

Add New Alert

NOTE: This feature is provided in the event that the National Weather Service and the authorities decide to add any new alert messages in the future. However at this moment your CKW2000 is capable of receiving all of the current **NWR** alerts.

If future alerts are established, you may contact Emerson Radio Customer Service for detailed instructions for adding new alerts to this radio.

Siren Test

To confirm that the siren in your CKW2000 is working properly:

- With the radio 'off' press the **MENU** button, then press the ▼ Navigation button once.

The display shows "**SIREN TEST**".



- Press the **SELECT** button to activate the siren and confirm that it is working properly.
- Press the **MENU** button to cancel the siren test and return to the Time and Date display.



Receiving NOAA Hazard Alert Messages

When the **NWR** transmitter covering your area sends out an alert message that applies to your county, your **CKW2000** will react as follows:

- One of the 3 indicators on the front panel will turn on depending on whether the message is considered a “**WARNING**”, a “**WATCH**”, or a “**STATEMENT**” (Advisory).
- Depending on the Siren Alert Mode that you selected, the siren will sound for 5 minutes, or the siren will sound for 8 seconds and then you will hear the actual alert announcement from the **NWR** transmitter for approximately 5 minutes.

You can stop the siren sooner by pressing the **ALERT OFF/ALM 2** or **POWER**  button. To stop the announcement you must press the **WEATHER/HAZARD** button.

- The actual message text will scroll across the top line of the LCD display. The second line of the display will show the ending time of the current alert.

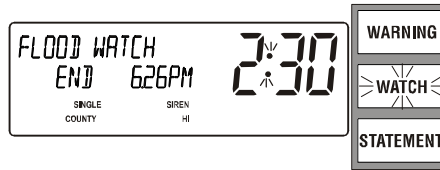

The message will continue to scroll across the display until the alert is over, or until you cancel the message by pressing the **ALERT OFF/ALM 2** or **POWER**  button.

Receiving/Storing Overlapping Alerts

In certain instances you may receive a new alert message while the first message is still in effect. The CKW2000 can store up to 15 different alert messages with overlapping effective times. When the new message is received it immediately appears on the display and the previous message is stored in the memory.

To review the last 15 alert messages stored in the memory, make sure the radio is ‘Off’ and then press the **▲** Navigation button to scroll through the last 15 received messages. If any of the stored messages has already expired, the word “**EXPIRATION**” appears in the display below the scrolling message text.

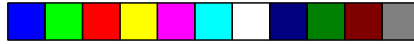

Test Alert Signals

In most of the USA the National Weather Service (**NWS**) broadcasts a test alert signal every Wednesday between 11:00 AM and 1:00 PM. To find out the exact test schedule in your area you can call your local **NOAA** or **NWS** office.

You can find the telephone numbers in you local telephone directory under "US Government, Department of Commerce".

When the test alert signal is received your radio will 'beep' and you will see a message such as:

REQUIRED WEEKLY TEST

REQUIRED MONTHLY TEST

SYSTEM DEMO

NATIONAL PERIODIC TEST

As the NWS adds new alert capabilities your CKW2000 is set to receive them and alert you automatically with no modifications.

Additional Information

For additional info about the **NOAA**, the **NWS**, and All Hazards Radio please visit the following websites:

www.noaa.gov

www.weather.gov/nwr/

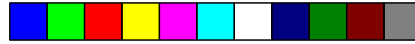

CARE AND MAINTENANCE

There are no user serviceable parts inside this radio.

Please refer all service problems to a qualified service facility.

Care Of Cabinet

If the cabinet becomes dusty, wipe the exterior with a soft dust cloth only.

Never use dusting sprays or polishes on the cabinet.

If the cabinet becomes dirty or smudged with fingerprints it may be wiped with a soft cloth that has been slightly dampened with a mild soap and water solution.

Always disconnect the AC/DC adapter from the AC outlet before cleaning, and never allow any liquid to get inside the cabinet.

	TO FIND THE LOCATION AND PHONE NUMBER OF YOUR NEAREST SERVICE CENTER PERMITTED TO PERFORM WARRANTY...
CALL TOLL FREE: 1-800-695-0098	
FOR ADDITIONAL SET-UP OR OPERATING ASSISTANCE PLEASE CALL: 1-800-898-9020	
FOR CUSTOMER SERVICE, PLEASE WRITE TO: Emerson Radio Corp., Consumer Affairs Dept., 5101 Statesman Drive, Irving, TX 75063.	

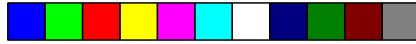

LIMITED WARRANTY

Emerson Radio Corp. warrants manufacturing defects in original material, including original parts and workmanship, under normal use and conditions, for a period of ninety (90) days from the date of original purchase in the U.S. With your dated proof of purchase, we will provide repair service at no charge for labor and parts at an authorized Depot Repair Facility, or replace the product in our discretion. For repair or replacement, pack your unit in a padded box, enclose your check or money order payable to Emerson Radio Corp. in the amount of \$9.00 (not required by California residents) to cover shipping and handling costs, and enclose a copy of your proof of purchase. Send your unit to:

Emerson Radio Corp.,
5101 Statesman Drive,
Irving, TX 75063.

This warranty does not cover damage from negligence, misuse, abuse, accident, failure to follow operating instructions, commercial use, rental, repairs by an unauthorized facility, or products purchased, used, serviced or damaged outside of the United States.

THIS WARRANTY GIVES YOU SPECIFIC LEGAL RIGHTS, AND YOU MAY ALSO HAVE OTHER RIGHTS WHICH VARY FROM STATE TO STATE.

AU898M

The Serial Number can be found on the bottom cabinet. We suggest that you record the Serial Number of your unit in the space below for future reference.

Model Number: CKW2000

Serial Number: _____





 **emerson**
Research®



CKW2000-041207-02

Printed in China



CKW2000_041207.p65

41



12/4/2007, 11:56

