



ELMO

CCD COLOR VIDEO CAMERA

TSN400A · TSN401A · TSN402A

INSTRUCTION MANUAL

	CAUTION RISK OF ELECTRIC SHOCK DO NOT OPEN	
CAUTION : TO REDUCE THE RISK OF ELECTRIC SHOCK. DO NOT REMOVE COVER (OR BACK). NO USER SERVICEABLE PARTS INSIDE. REFER SERVICING TO QUALIFIED SERVICE PERSONNEL.		

* The CAUTION label, shown on the left, is attached on the top of camera.



The lightning flash with arrowhead symbol, within an equilateral triangle, is intended to alert the user to the presence of uninsulated "dangerous voltage" within the product's enclosure that may be of sufficient magnitude to constitute a risk of electric shock to persons.



The exclamation point within an equilateral triangle is intended to alert the user to the presence of important operating and maintenance (servicing) instructions in the literature accompanying the appliance.

CAUTION

- Do not use any power supply other than specified.

WARNING:

TO REDUCE THE RISK OF FIRE OR ELECTRIC SHOCK, DO NOT EXPOSE THIS APPLIANCE TO RAIN OR MOISTURE.

INFORMATION

This equipment has been tested and found to comply with the limits for Class A digital device, pursuant to Part 15 of the FCC Rules. These limits are designed to provide reasonable protection against harmful interference when the equipment is operated in a commercial environment. This equipment generates, uses, and can radiate radio frequency energy and, if not installed and used in accordance with the instruction manual, may cause harmful interference to radio communications. Operation of this equipment in a residential area is likely to cause harmful interference in which case the user will be required to correct the interference at his own expense.

USER-INSTALLER CAUTION: Your authority to operate this FCC verified equipment could be voided if you make changes or modifications not expressly approved by the party responsible for compliance to Part of the FCC Rules.

IMPORTANT SAFEGUARDS

1. Read Instructions

All the safety and operating instructions should be read before the appliance is operated.

2. Retain Instructions

The safety instructions and instruction manual should be retained for future reference.

3. Heed Warnings

All warnings on the appliance and in the instruction manual should be adhered to.

4. Follow Instructions

All operating and use instructions should be followed.

5. Cleaning

Disconnect this video product from the power supply before cleaning.

6. Attachments

Do not use attachments not recommended by the video product manufacturer as they may cause hazards.

7. Water and Moisture

Do not use this video product near water — for example, near a bath tub, wash bowl, kitchen sink, or laundry tub, in a wet basement, or near a swimming pool and the like.

8. Accessories

Do not place this video product on an unstable cart, stand, tripod, bracket, or table. The video product may fall, causing serious injury to a child or adult, and serious damage to the appliance. Use only with stand, tripod bracket, or table recommended by the manufacturer, or sold with the video product. Any mounting of the appliance should follow the manufacturer's instructions, and should use a mounting accessory recommended by the manufacturer.

9. Ventilation

This video product should never be placed near or over a radiator or heat register. This video product should not be placed in a built-in installation such as a bookcase or rack unless proper ventilation is provided or the manufacturer's instructions have been adhered to.

10. Power Sources

This video product should be operated only from the type of power source indicated on the marking label. If you are not sure of the type of power supply to your location, consult your appliance dealer or local power company.

11. Power-Cord Protection

Power-supply cords should be routed so that they are not likely to be walked on or pinched by items placed upon or against them, paying particular attention to cords at plugs, screws, and the point where they exit from the appliance.

12. Lightning

For added protection for this video product during a lightning storm, or when it is left unattended and unused for long periods of time, unplug it from the wall outlet and disconnect the power supply and cable system. This will prevent damage to the video product due to lightning and power-line surges.

13. Overloading

Do not overload power supply and extension cords as this can result in a risk of fire or electric shock.

14. Object and Liquid Entry

Never push objects of any kind into this video product through openings as they may touch dangerous voltage points or short-out parts that could result in a fire or electrical shock. Never spill liquid of kind on the video product.

15. Servicing

Do not attempt to service this video product yourself as opening or removing covers may expose you to dangerous voltage or other hazards. Refer all servicing to qualified service personnel.

16. Damage Requiring Service

Disconnect this video product from the power supply and refer servicing to qualified service personnel under the following conditions.

- When the power-supply cord or plug is damaged.
- If liquid has been spilled, or objects have fallen into the video product.
- If the video product has been exposed to rain or water.
- If the video product does not operate normally by following the operating instructions in the instruction manual. Adjust only those controls that are covered by the instruction manual as an improper adjustment of other controls may result in damage and will often require extensive work by a qualified technician to restore the video product to its normal operation.
- If the video product has been dropped or the cabinet has been damaged.
- When the video product exhibits a distinct change in performance — this indicates a need for service.

17. Replacement Parts

When replacement parts are required, be sure the service technician has used replacement parts specified by the manufacturer or that have the same characteristics as the original part. Unauthorized substitutions may result in fire, electric shock or other hazards.

18. Safety Check

Upon completion of any service or repairs to this video product ask the service technician to perform safety checks to determine that the video product is in proper operating condition.

PART NAMES AND FUNCTIONS

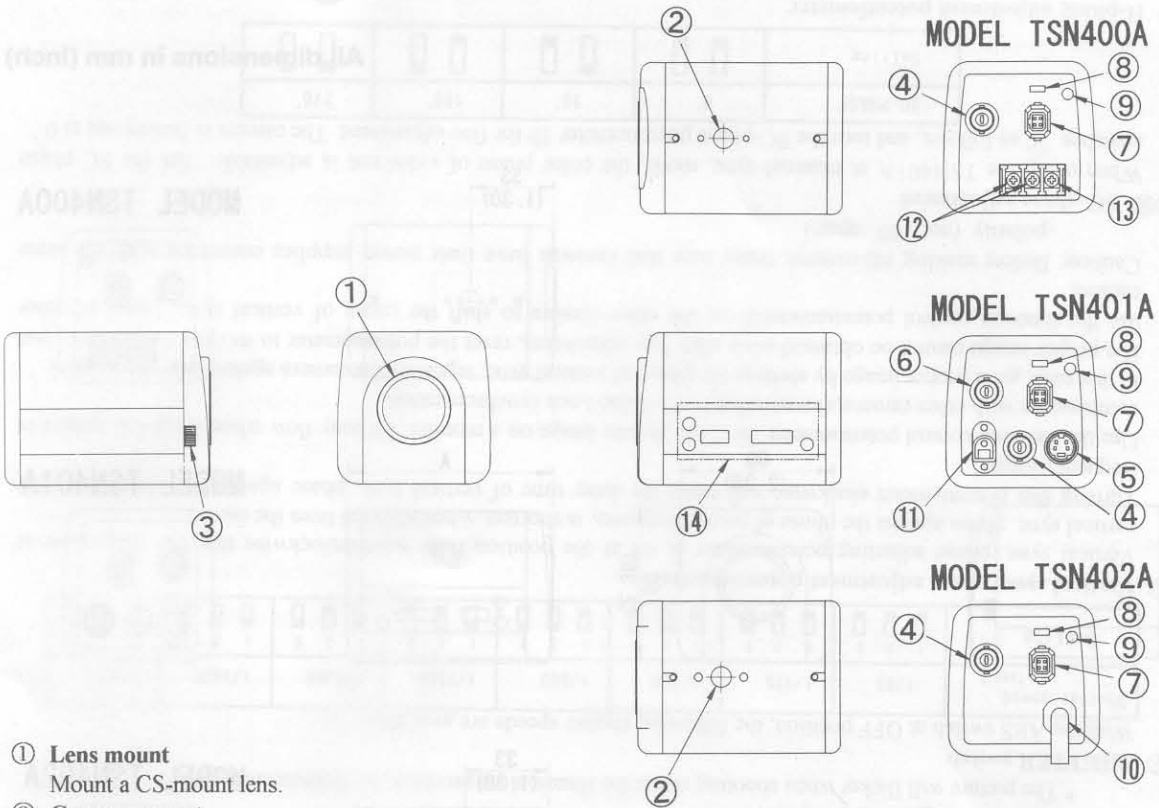

- ① **Lens mount**
Mount a CS-mount lens.
- ② **Camera mount**
For mounting a camera on wall, housing, etc.
- ③ **Focusing knob**
For fine-adjustment of the lens back-focus.
- ④ **VIDEO OUT terminal**
Connect this to a monitor TV, etc. (BNC connector)
- ⑤ **S-VIDEO OUT terminal**
Connect to a VCR with S-video terminal. (Mini DIN4P jack)
- ⑥ **EXT. SYNC. terminal**
For controlling the camera with external sync. (BNC connector)
- ⑦ **IRIS terminal**
Connect when an automatic iris lens is used.
- ⑧ **AUTO IRIS switch**
When a DC driven type auto iris lens is used, set this switch to DC position.
When a video feedback type auto iris lens is used, set this switch to VIDEO position.
- ⑨ **ALC LEVEL**
Adjust video output level, when AUTO IRIS switch is DC position.
- ⑩ **Power cord**
Connect this to AC 120V power supply.
- ⑪ **DC power terminal**
Connect this to DC 12V Class 2 power supply.
- ⑫ **AC power terminal**
Connect this to AC 24V Class 2 power supply.
- ⑬ **Ground terminal**
Connect this to the ground wire of the power supply cord.
- ⑭ **Camera control switches**
Refer to "CAMERA CONTROLS." on page 5.

HOW TO CONNECT

1. Before connection, make sure that power of all units are OFF and cords are unplugged.
2. Mount a lens onto the camera. Refer to "HOW TO USE" for usable lens.
3. Connect video terminal of the camera and the video input terminal of a monitor TV, etc. with a 75 Ω coaxial cable.
4. Connect the power terminal of the camera to a power supply.

Caution: Installation should be made by a qualified service personnel and should conform to all local codes.
Lens, coaxial cable for video signal and power supply are not supplied with a camera.

HOW TO USE

1. **TSN400A** : Turn on the unit by connecting the power cord of AC 24V power supply.
TSN401A : Turn on the unit by connecting the power cord of DC 12V power supply.
TSN402A : Connect the power cord to AC 120V and turn the power ON.
2. Adjust the iris and focus of the lens so that optimum image may be obtained.

* Usable lenses

CS-mount lenses, whose length "L" (in the illustration) from the bearing surface of the mount is 5mm or less if protruded, shall be used.

* Using the zoom lens (adjustment of the back focus)

The camera is set at the standard back focus position when shipped from factory. Depending on types of zoom lenses, however, slight readjustment may be necessary.

Adjust the lens back-focus by turning the focusing knob in either direction as per the illustration, referring to the following instructions.

- ① Place an object at any fixed distance and set the focus ring of the zoom lens to be used with.
- ② Set the zoom lens to fully TELE position and obtain the best focus position by turning the focus ring of the zoom lens.
- ③ Then set the zoom lens to fully WIDE position and obtain the best focus position by turning the focusing knob as well.
- ④ Repeat the procedures② and③ until focus remains in constant among the zooming range.

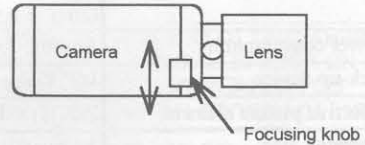
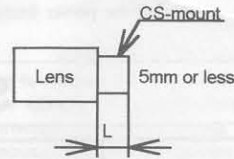

Note: When weight of the lens is more than 1kg (2.2lbs), the camera should be supported on the lens rather than to rely on camera mounting screw.

Adjust the back-focus only in case of necessity.

* Using an auto iris lens

When a DC driven type auto iris lens is used, set AUTO IRIS switch to DC position, and connect the plug of the lens (for iris terminal) to the IRIS terminal on the back of the camera.

When a video feedback type auto iris lens is used, set AUTO IRIS switch to VIDEO position, and connect the plug of the lens (for iris terminal) to the IRIS terminal on the back of the camera.

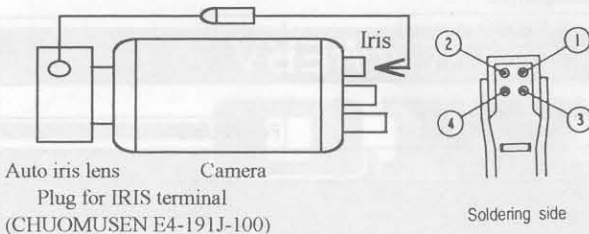

IRIS terminal

	DC position	VIDEO position
1	Control -	+9V iris power (50mA Max.)
2	Control +	GND
3	Drive +	0.8Vp-p auto iris video signal
4	Drive - (GND)	GND

3. Before your use of the camera at AES (Automatic Electronic Shutter) mode.

* When using an auto-iris lens, set the AES switch at OFF.
(The AES switch is set at OFF when shipped from factory.)

* The AES mode may increase smears on monitors, which is caused by characteristics of CCD and is not defect.
Set the AES switch at OFF in case smears appear excessively.

LINE-LOCK CONTROL (TSN400A/TSN402A)

Matching the vertical synchronization with the power frequency is called the line-lock.

When two or more cameras are switched by the video switcher for monitoring a monitor TV, the vertical sync. phase can be locked with the power frequency, and a stable vertical sync. is obtained without being disturbed at the time of switching

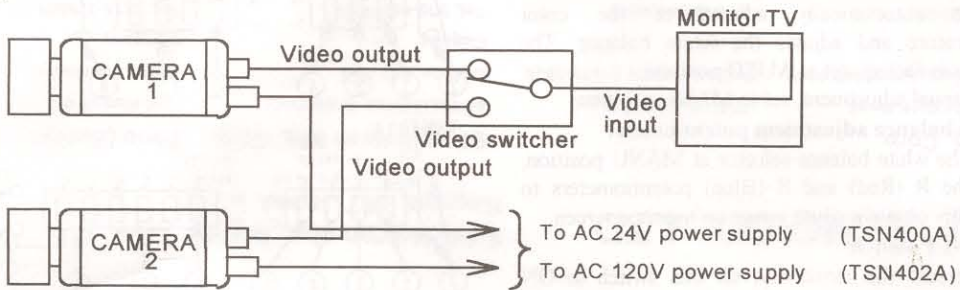

Caution:

1. The camera is synchronized to the power frequency of $60\text{Hz} \pm 0.5\text{Hz}$ covering a normal fluctuation of the power frequency. The camera may not compensate for large fluctuation caused from the power generated by an engine generator, etc.
2. It takes about 10 seconds or more to obtain a stable synchronization after the power is turned on. This is necessary to stabilize the camera against the power noise.

INT./EXT. SYNCHRONOUS CONTROL (TSN401A)

TSN401A is capable of internal/external synchronous controls with automatic change-over.

(a) Internal Synchronous Control

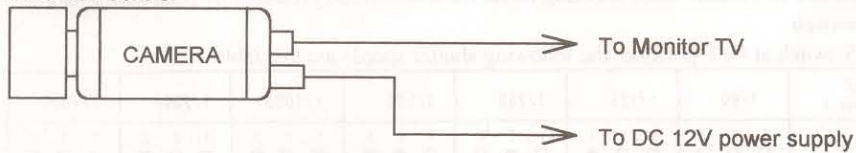

(b) External Synchronous Control by VBS

The internal sync. mode automatically changes to the external sync. mode when the VBS signal from an external control unit is input to 'EXT SYNC' BNC terminal on the back of the camera.

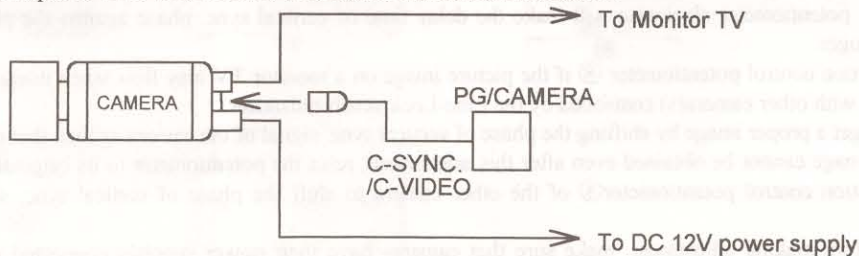

***Conditions for the input of external synchronization**

VBS (75 Ω unbalanced) SYNC 0.3Vp-p \pm 0.1Vp-p
 BURST 0.3Vp-p \pm 0.1Vp-p

Limits of frequency deviation Within $\pm 50\text{ppm}$ against the NTSC standard system.
 (Horizontal frequency approx. 15.7335kHz~15.7350kHz)

In case of synchronous use of more than two cameras, Horizontal phase and Sub-carrier(SC) phase can be adjusted to match the images from respective cameras, if necessary.

CAMERA CONTROLS

By adjusting the switches/potentiometers provided on the side panel, the control functions are available.

① White balance selector

Manual or Automatic white balance modes are selectable. With the setting at AUTO position, the camera automatically adjusts to the color temperature and adjusts the white balance. The camera is factory-set at AUTO position.

For manual adjustment, set to MANU position.

② White balance adjustment potentiometer

With the white balance selector at MANU position, turn the R (Red) and B (Blue) potentiometers to manually obtain a white image on monitor screen.

③ SENS-UP switch

To increase the sensitivity, set this switch to ON position.

④ BLC (Back Light Control) switch

In case the back lighting is too bright to shoot the main object clearly, set this switch to ON position.

⑤ AGC switch (TSN401A only)

In case of necessity, set the AGC switch to ON position.

⑥ AES switch

[Electronic shutter] The camera is factory-set at the AES switch OFF and 1/60 sec. shutter speed.

For shooting fast-moving objects, the various electronic shutter speeds are available by changing per the table mentioned below.

[AES (Automatic Electronic Shutter)] By setting the AES switch to ON, the Automatic Electronic Shutter mode (1/60 ~ 1/10,000 sec) is available.

Note: In electronic shutter mode;

* Sufficient brightness is required.

* The picture will flicker when shooting under the illumination produced by fluorescent lamp.

⑦ SHUTTER switch

With the AES switch at OFF position, the following shutter speeds are available.

Shutter speed (sec.)	1/60	1/125	1/250	1/500	1/1000	1/2000	1/4000	1/10000
Setting	1 2 3 □ □ □	1 2 3 □ □ □	1 2 3 □ □ □	1 2 3 □ □ □	1 2 3 □ □ □	1 2 3 □ □ □	1 2 3 □ □ □	1 2 3 □ □ □

⑧ Vertical sync. phase adjustment potentiometer

Vertical sync. phase adjusting potentiometer is set at the position fully counterclockwise that the delay time of vertical sync. phase against the phase of power frequency is shortest, when shipped from the factory.

Turning this potentiometer clockwise will make the delay time of vertical sync. phase against the phase of power frequency longer.

Use the function control potentiometer ⑧ if the picture image on a monitor TV may flow when using the camera in combination with other camera(s) controlled by the Line-Lock synchronization.

In this case, get a proper image by shifting the phase of vertical sync. signal of the camera against that of the other.

If a proper image cannot be obtained even after this adjustment, reset the potentiometer to its original position, and use the function control potentiometer ⑧ of the other camera to shift the phase of vertical sync. signal of other camera.

Caution: Before making adjustment, make sure that cameras have their power supplies connected with the same polarity. (not 180° apart)

⑨⑩ SC-phase adjustment

When using the TSN401A at external sync. mode, the color phase of video out is adjustable. Set the SC-phase switches ⑨ as follows, and turn the SC-phase potentiometer ⑩ for fine adjustment. The camera is factory-set at 0°.

SC-PHASE	0°	90°	180°	270°
Setting	□ □	□ □	□ □	□ □

⑪ H-phase adjustment potentiometer

When using the TSN401A at external sync. mode, adjust the H-phase by turning the potentiometer ⑪, observing the waveforms of external sync. signal and camera output video signal.

TSN400A, TSN402A

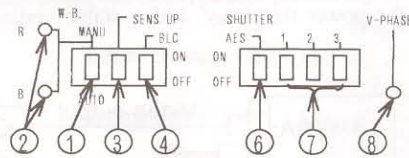

TSN401A

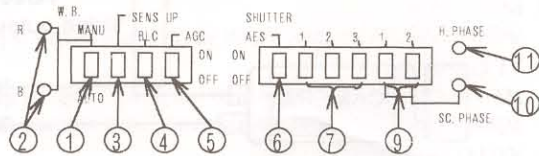

PRECAUTIONS FOR USE AND INSTALLATION

*Never aim the camera at the sun.

Never aim or point the camera at the sun even if you are not shooting.

*Do not shoot intense light.

Strong light such as a spot light on the image plane will cause blooming or smear. When strong light comes into the image plane, vertical stripes may appear on it. However, this does not mean that the camera is defect.

*Take precautions when handling a camera.

Do not drop your camera, or give it a strong shock or vibration, or it will incur a malfunction.

*Do not touch internal parts.

Be sure not to touch the internal parts. That will be cause of accident.

*Do not let the camera get wet.

Install the camera at the place where it will not get wet.

Should it gets wet, turn off the power immediately and contact your dealer.

*Install your camera where no video noise appears.

When camera cables have been laid near electric wires or television receivers, a noise may interfere the image.

If that happened, relocate cables or reinstall equipment.

*Check the ambient temperature and humidity.

Picture quality will be deteriorated or parts inside will become defective in the temperature hotter or colder than that indicates in the specifications.

Therefore avoid using the camera in such circumstances. Precautions shall also be taken when using it in a high humidity.

*Should you notice any trouble.

If any trouble occurs while you are using the camera, turn off the camera and contact your dealer.

If you continue to use the camera when there is something wrong with it, the trouble may become much worse.

*The socket-outlet shall be installed near the equipment and shall be easily accessible.

SPECIFICATIONS

Model	TSN400A	TSN401A	TSN402A
Power source	AC24V ± 10% 60Hz ± 0.5Hz	DC12V (DC11V—16V)	AC120V ± 10% 60Hz ± 0.5Hz
Power consumption	Approx. 5.0W	Approx. 4.3W	Approx. 5.8W
Pick-up device	1/3" Color interline-transfer CCD		
Effective picture element	768(H) × 494(V)		
Scanning area	4.88mm(H) × 3.66mm(V)		
Scanning system	2:1 interlaced		
Scanning frequency (H) (V)	15.75kHz 60Hz	15.734kHz 59.94Hz	15.75kHz 60Hz
Sync. system	Line-lock	Internal/External (automatic change-over)	Line-lock
Resolution	470 TV lines (Horizontal) 350 TV lines (Vertical)		
S/N ratio	More than 48dB		
Recommended illumination	110 lx (F1.2 under incandescent lamp)		
Minimum illumination	2.2 lx (F1.2 under incandescent lamp, w/Sens-up ON)		
AGC	Built into camera circuitry (TSN401A: ON/OFF switch provided. Factory-set at OFF.)		
Sens-up	Provided (Factory-set at OFF)		
White balance	Auto/Manual (Factory-set at AUTO)		
Backlight control	Provided (Factory-set at OFF)		
AES (Automatic Electronic Shutter)	Provided (Factory-set at OFF)		
Electronic shutter	1/60, 1/125, 1/250, 1/500, 1/1000, 1/2000, 1/4000, 1/10000 sec.		
Output signal	VBS 1.0 Vp-p, 75 Ω, NTSC compatible		
Y/C signal	—	S-VIDEO terminal	—
External sync. terminal	—	BNC VBS 1.0Vp-p 75 Ω	—
Auto-iris terminal	4P (DC/Video)		
Power terminal	3P terminal	Coaxial DC jack	Power cord
Lens mount	CS		
Ambient temperature	-10 ° C ~ +50 ° C (14 ° F ~ 122 ° F)		
Ambient humidity	30% ~ 90%		
Dimensions	60(W) × 60(H) × 80(D)mm (2.4 × 2.4 × 3.1 inches)	60(W) × 60(H) × 80(D)mm (2.4 × 2.4 × 3.1 inches)	60(W) × 60(H) × 140(D)mm (2.4 × 2.4 × 5.5 inches)
Weight	300 gm (0.66 lbs)	300 gm (0.66 lbs)	700 gm (1.54 lbs)

Note: Weight and dimensions are approximate.

Design and specifications are subject to change without prior notice.

PROFILE

All dimensions in mm (inch)

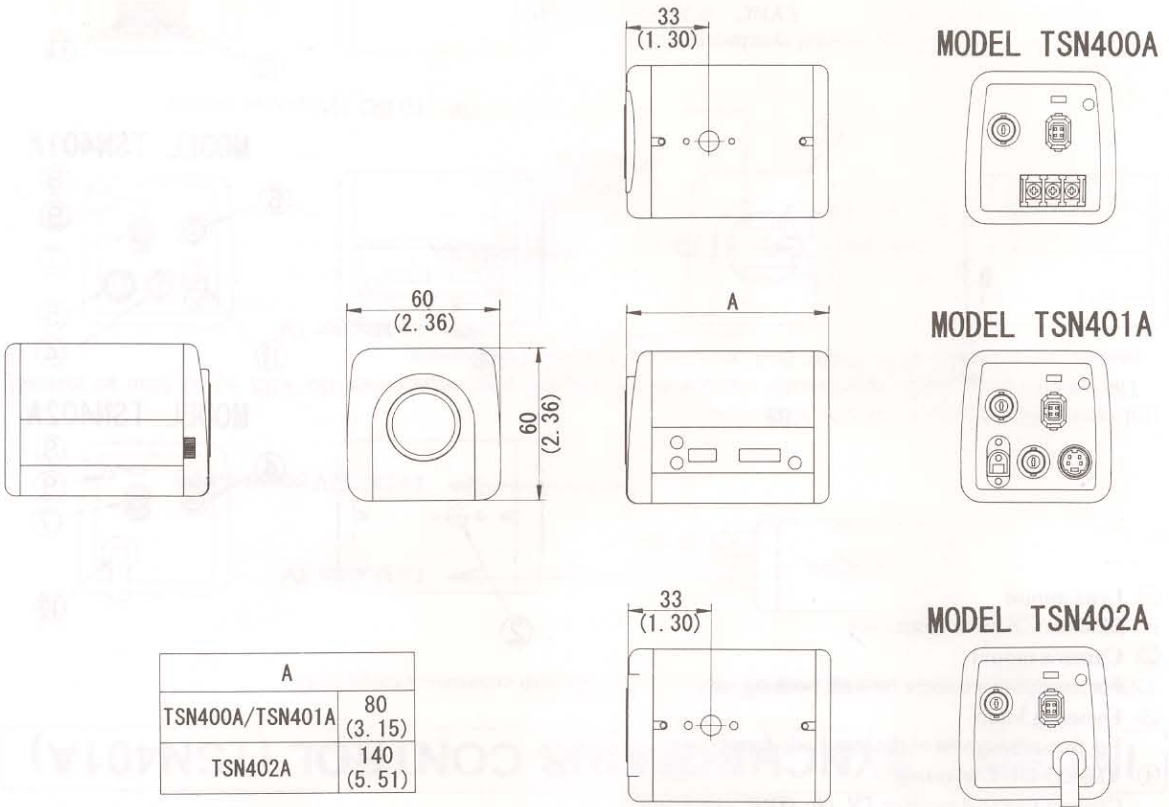

A	
TSN400A/TSN401A	80 (3.15)
TSN402A	140 (5.51)

ELMO ELMO CO., LTD.

6-14, Meizen-cho, Mizuho-ku,
Nagoya, 467 Japan

Elmo Mfg. Corp.

70 New Hyde Park Road,
New Hyde Park, NY 11040-9980,
U.S.A.

Tel. 516-775-3200
Fax. 516-775-3297

21720 Nordhoff St.,
Chatsworth, CA 91311-5826,
U.S.A.

Tel. 818-346-4500
Fax. 818-998-4186

Elmo Canada Mfg. Corp.

44 West Drive Brampton,
Ontario, L6T 3T6,
Canada

Tel. 905-453-7880
Fax. 905-453-2391

Elmo (Europe) G.m.b.H.

Karl-Rudolf-Str. 178
40215 Dusseldorf,
Germany

Tel. 0211-376051-53
Fax. 0211-376630

6X1NFKA02 D

Printed in Japan (A)