

Panasonic

1億人のファクス

おたくす

Facsimile with Cordless Phone

KX-PW11CLH

KX-PW11CLK

Model No. **KX-PW21CL**



Quick Reference Guide

- The digital speaker phone (main unit) allows hands free conversations.
- Automatic dialing (Up to 99 phone numbers can be stored with names.)
- Digital answering machine with flash memory
- Auto cutter
- Hand scanner (for KX-PW21CL only)

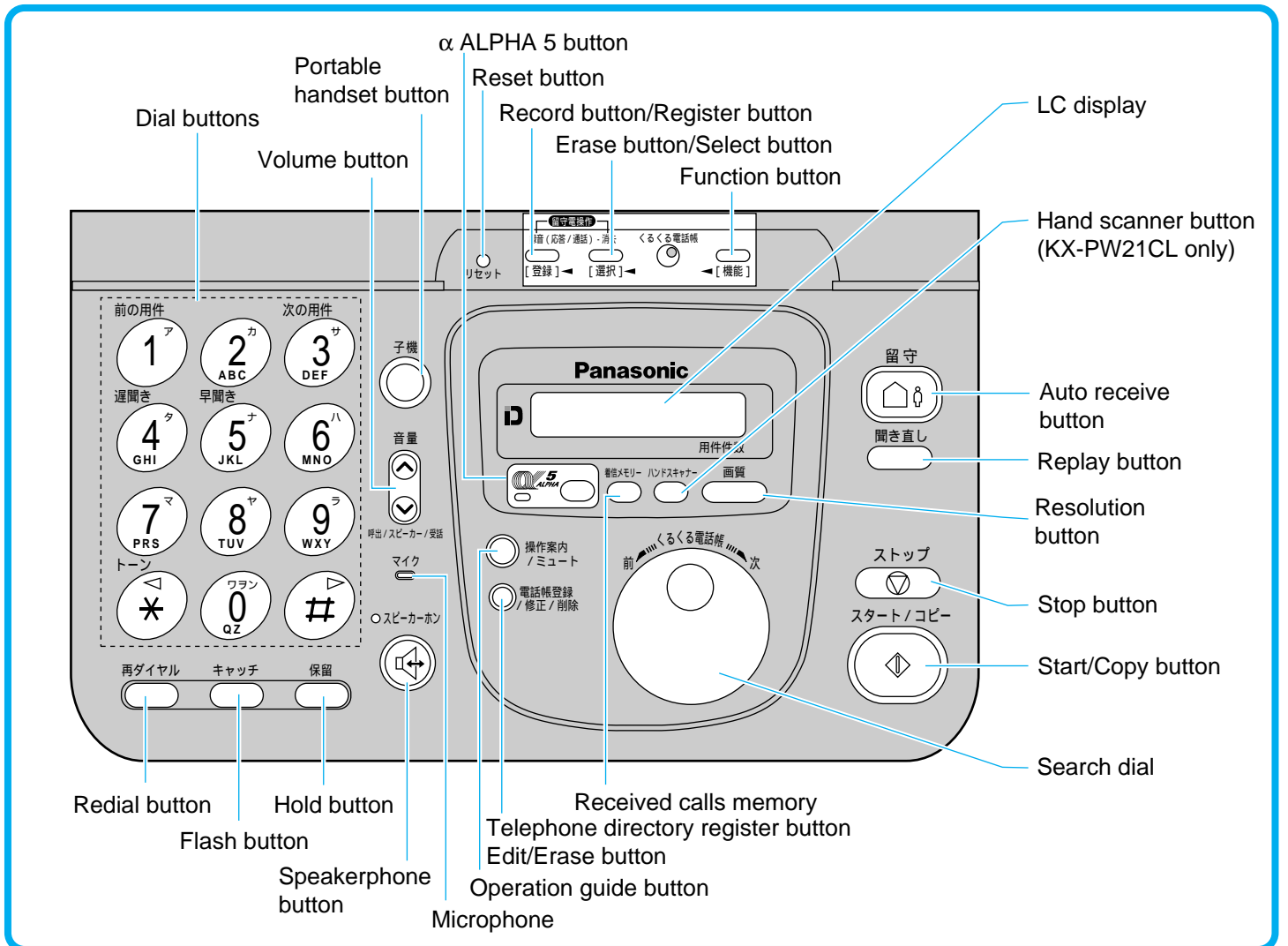

Preparations

1 Installing the recording paper and stacker

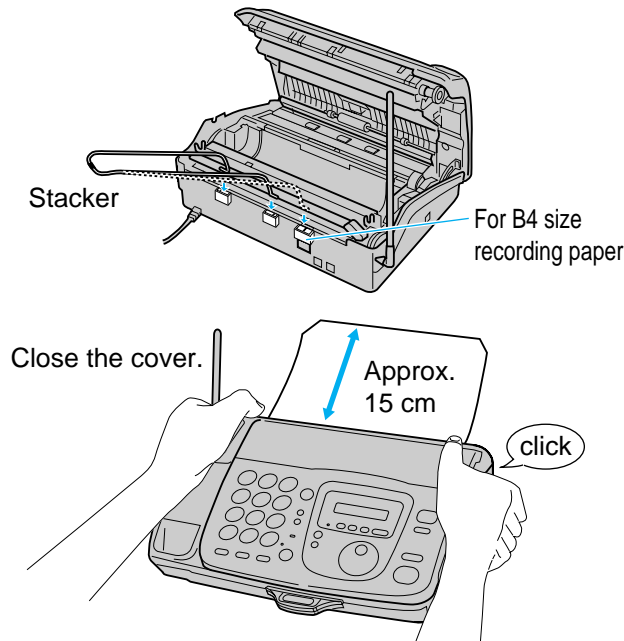
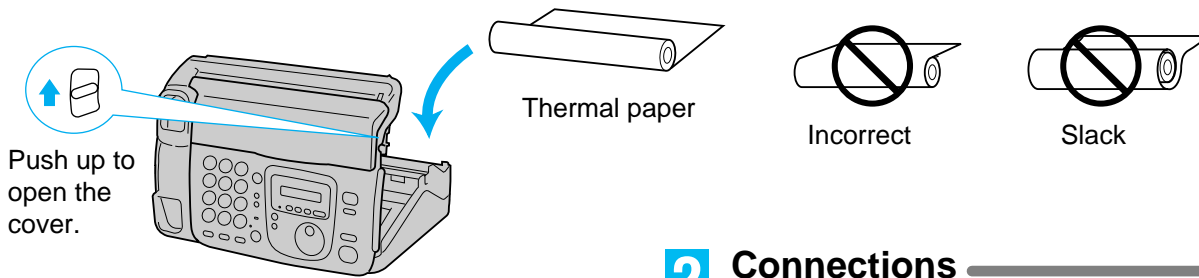

2 Connections

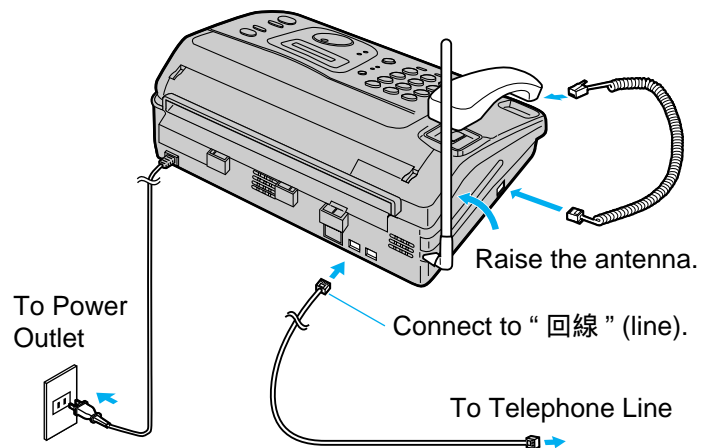

3 Automatic dial mode setting

When the power cord and the telephone line cord are connected, the unit will start detecting the dial mode (tone or pulse). If you cannot dial and “カイセン チェック エラー-U61” is displayed, change the dial mode setting.

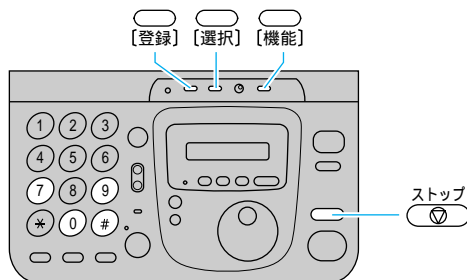

Changing the dial mode

1. Press [機能] (function).
2. Press # 0 7 9.
3. Press [選択] (select) to select the dial mode (カイセン シュヘツ).
4. Press [登録] (register).
5. Press [ストップ] (stop).

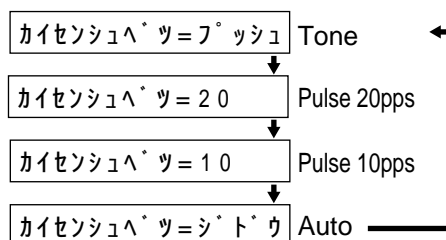

Confirming the dial mode

1. Set the dial mode to “20”.
(See “Changing the dial mode” shown on the left.)
2. Dial ①①⑦ (time signal).
If you cannot dial, change to “10”.
If you cannot dial after changing to “10”, set to “フッシュ” (tone).

Note:

If this unit is connected to a PBX or used as an extension, dial the access code (ex. ⑩) before the time signal.

Setting the Date, Time, Facsimile Telephone Number and Logo

Before using your unit, program the correct date, time, facsimile telephone number and logo. These will be printed on the top of each page transmitted from your unit.

1 Setting the date and time

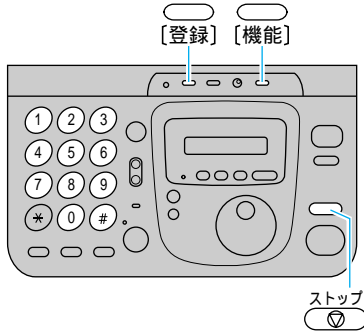

1. Press **[機能]** (function).
2. Press **# 0 0 1**.
3. Enter the correct year/month/day/hour/minute by selecting each 2 digits.
Example: Aug. 10, 1998 3:05PM
Press **9 8 0 8 1 0 1 5 0 5**.
4. Press **[登録]** (register).
5. Press **[ストップ]** (stop).

2 Setting your facsimile telephone number

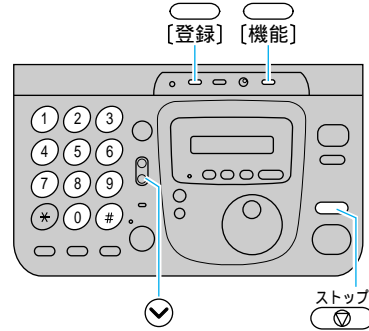

1. Press **[機能]** (function).
2. Press **# 0 0 4**.
3. Enter your facsimile telephone number up to 20 digits.
Example: 098-765-4321
Press **0 9 8 [] 7 6 5 [] 4 3 2 1**.
4. Press **[登録]** (register).
5. Press **[ストップ]** (stop).

3 Setting your logo

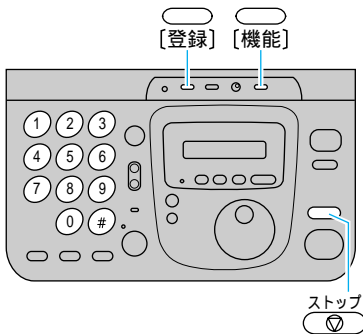

1. Press **[機能]** (function).
2. Press **# 0 0 2**.
3. Enter your logo up to 30 characters. Refer to the character list.
4. Press **[登録]** (register).
5. Press **[ストップ]** (stop).

Character List

	Number of times																	
	1	2	3	4	5	6	7	8	9	10	11	12	13	14	15	16	17	18
①	ア	イ	ウ	エ	オ	ア	イ	ウ	エ	オ	1							
②	カ	キ	ク	ケ	コ	A	B	C	a	b	c	2						
③	サ	シ	ス	セ	ソ	D	E	F	d	e	f	3						
④	タ	チ	ツ	テ	ト	ッ	G	H	I	g	h	i	4					
⑤	ナ	ニ	ヌ	ネ	ノ	J	K	L	j	k	l	5						
⑥	ハ	ヒ	フ	ヘ	ホ	M	N	O	m	n	o	6						
⑦	マ	ミ	ム	メ	モ	P	R	S	p	r	s	7						
⑧	ヤ	ユ	ヨ	ャ	ュ	ョ	T	U	V	t	u	v	8					
⑨	ラ	リ	ル	レ	ロ	W	X	Y	w	x	y	9						
⑩	ワ	ヲ	ン	〃	°	Q	Z	q	z	0	()	,	-	.	:	_	.	

Example: Bill

Press **②** 7 times.

† † † I = B

Press **④** 12 times.

† † † I = B i

Press **⑤** 11 times.

† † † I = B i l

Press **#** 1 time.

† † † I = B i l

Press **⑤** 11 times.

† † † I = B i l

***** : To move the cursor to the left

: To move the cursor to the right

^ : To delete one character



✓ : To insert a space

Telephone Operations

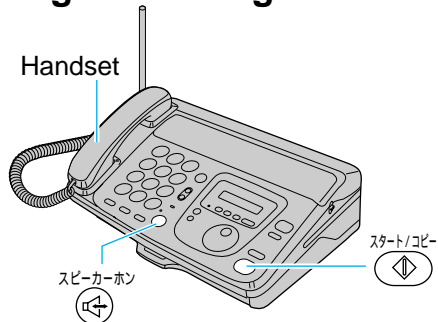

1 Making/Answering voice calls



Making calls

1. Lift the handset or press  (speakerphone).
2. Dial the telephone number.
3. Talk to the other party.
4. When finished, replace the handset or press  (speakerphone).

Answering calls



1. When the phone rings, lift the handset or press  (speakerphone).
2. Talk to the other party.
3. When finished, replace the handset or press  (speakerphone).

Note:

When a slow beep or no sound is heard, press  (start/copy) and replace the handset. The unit will start fax receiving.

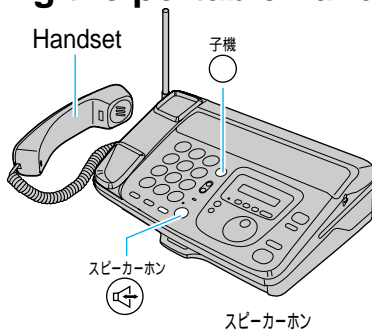
2 Paging the portable handset



1. Lift the handset or press  (speakerphone).
2. Press  (portable handset).
3. Talk to the portable handset user.
4. When finished, replace the handset or press  (speakerphone).

Transferring calls to the portable handset

1. Press  (portable handset) while you are talking to an outside party.
 - The portable handset is paged.
2. When the portable handset user answers, tell them a call is being transferred, then hang up.
 - The portable handset user can talk to the outside party.



Note:

When the portable handset user does not answer, press  (portable handset) again. You can talk to the outside party.

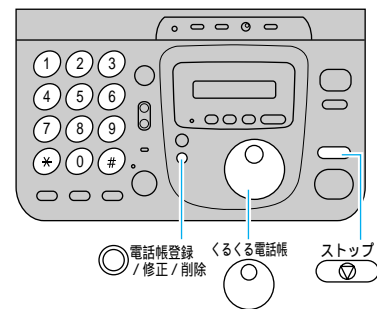



3 Automatic dialing



Automatic dialing





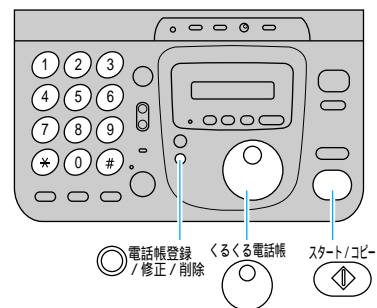

1. Rotate  (search dial) until the name you want to dial appears on the display.
2. Lift the handset or press  (speakerphone).
3. Talk to the other party.
4. When finished, replace the handset or press  (speakerphone).

Storing a phone number

1. Press  (telephone directory register/edit/erase).
2. Enter the station name using the dialing buttons, up to 12 characters. (See "Setting your logo" on page 2.)
3. Press  (telephone directory register/edit/erase).
4. Enter the phone number up to 30 digits.
5. Press  (telephone directory register/edit/erase).
 - To program other stations, repeat from step 2.
6. Press  (stop) when finished.



Changing the stored name or number

1. Rotate  (search dial) until the name you want to change appears on the display.
2. Press  (telephone directory register/edit/erase).
3. Press .
4. Press  or  to move the cursor to the incorrect character, then make the correction.
5. Press  (telephone directory register/edit/erase).
6. Enter the correct phone number.
7. Press  (telephone directory register/edit/erase).

Erasing the stored name and number

Press  in step 3 above.

Facsimile Operations

1 Transmitting documents

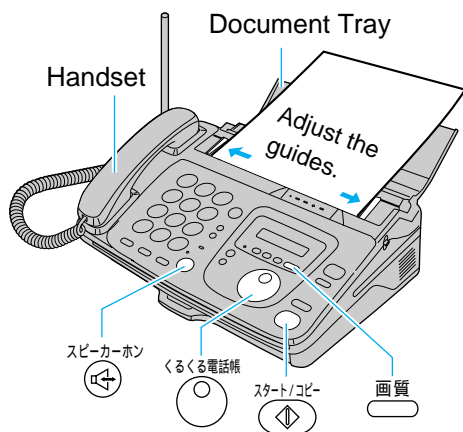

Transmitting documents manually

1. Open the document tray and adjust the guides.
2. Insert the document FACE DOWN until a beep is heard. (up to 5 sheets at a time)
3. Press (resolution) to select the resolution.
4. Lift the handset or press (speakerphone).
5. Dial the phone number.
6. When a fax tone is heard, press (start/copy).
7. Replace the handset.
 - The unit will start fax transmission.

Selecting the resolution

Press (resolution).

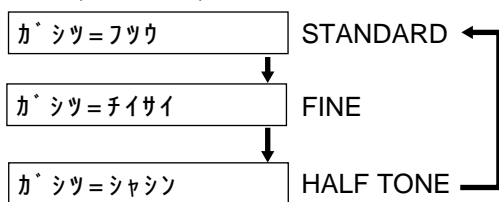

Transmitting documents using automatic dialing

1. Open the document tray and adjust the guides.
2. Insert the document FACE DOWN until a beep is heard. (up to 5 sheets at a time)
3. Press (resolution) to select the resolution.
4. Dial the phone number using the dial keys or select the name using (search dial).
5. Press (start/copy).
 - The unit will start fax transmission.

2 Receiving documents

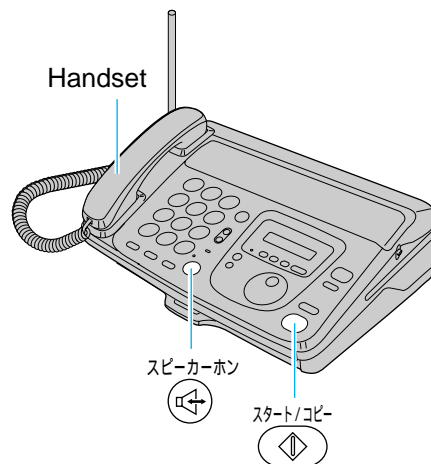

Receiving documents manually

1. When the unit rings, lift the handset or press (speakerphone) to answer the call.
2. When:
 - document reception is required,
 - a slow beep is heard, or
 - no sound is heard,
 press (start/copy).
3. Replace the handset if using it.
 - The unit will start fax receiving.

Portable Handset Operations

1 Connection

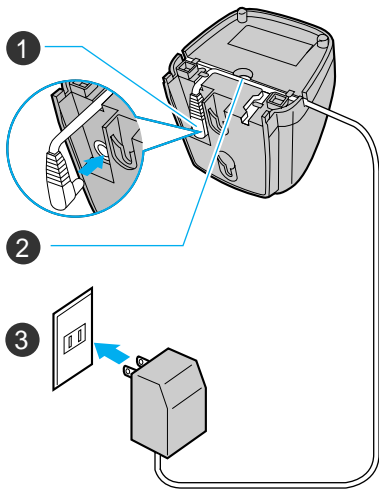

2 Battery installation

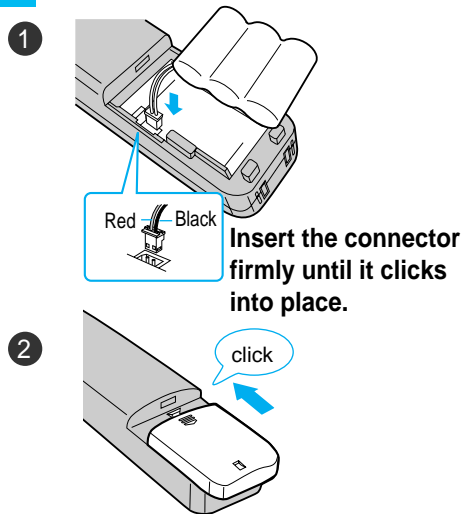

3 Battery charge

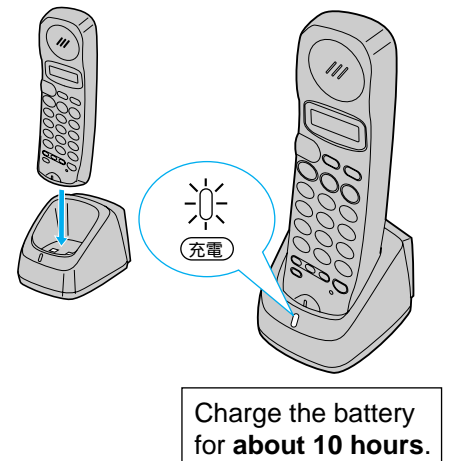

4 Making calls

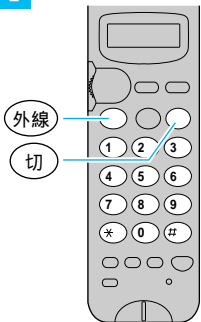

1. Press 外線 (outside line).
2. Dial the phone number.
3. Talk to the other party.
4. Press 切 (disconnect) when finished.

7 Receiving fax documents

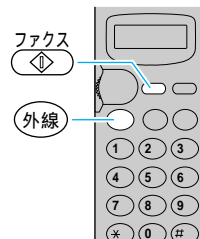

1. Press 外線 (outside line) when a call is received.
2. Press ファクス (fax) when a slow beep or no sound is heard. The main unit will start fax receiving.

5 Answering calls

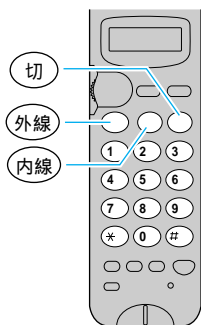

Answering outside calls

1. Press 外線 (outside line).
2. Press 切 (disconnect) when finished.

Answering intercom calls

1. Press 内線 (extension).
2. Press 切 (disconnect) when finished.

Answering outside calls transferred from the main unit

1. Press 内線 (extension).
Talk with the main unit user.
You can talk to the outside caller after the main unit user hangs up.
2. Press 切 (disconnect) when finished.

6 Paging the main unit

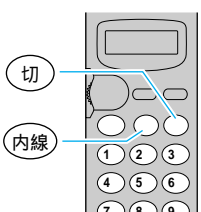

1. Press 内線 (extension).
2. Talk.
3. Press 切 (disconnect) when finished.

8 Automatic dialing

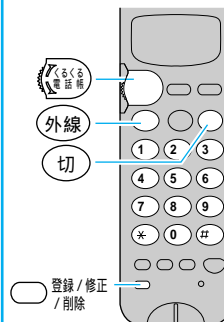

Storing

1. Press 登録/修正/削除 (register/edit/erase).
2. Enter the station name using the dialing buttons, up to 12 characters. (See the character list below.)
3. Press 登録/修正/削除 (register/edit/erase).
4. Enter the phone number, up to 30 digits.
5. Press 登録/修正/削除 (register/edit/erase).

Dialing

1. Rotate 検索ダイヤル (search dial) until the name you want to dial appears on the display.
2. Press 外線 (outside line).
3. Talk.
4. Press 切 (disconnect) when finished.

Character List

Characters	Characters
① アイウエオアイウエオ1	⑥ ハヒフヘホMNOmno6
② カキクケコABCabc2	⑦ マミムメモPRSprs7
③ サシスセソDEFdef3	⑧ ヤユヨヤユTUVtuv8
④ タチツテトGGHIghi4	⑨ ラリルレロWXYwxy9
⑤ ナニヌネノJKLjkl5	⑩ ワヲン`°QZqz0().-.:_

- * : To move the cursor to the left キャッチ : To delete one character
 # : To move the cursor to the right 音量 : To insert a space

Setting the Receive Mode

This unit has five types of receive modes. Choose the desired mode according to your needs. Press  (auto receive) to switch the manual receive and auto receive modes.

1 Manual receive mode

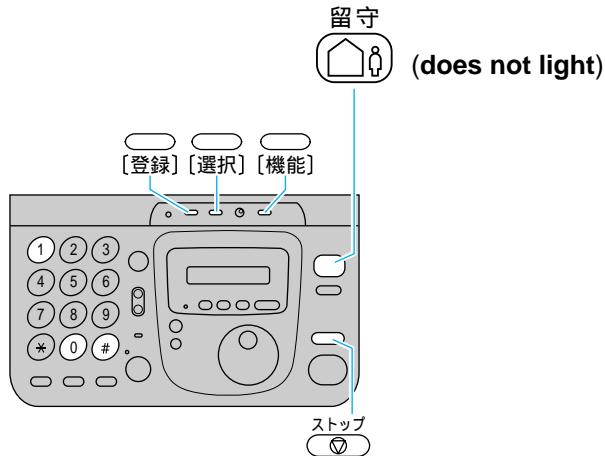





Telephone mode (デンワユウセン)

When you want to answer all calls manually.
After answering the call, press the start button for fax receiving.

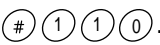
Facsimile/Telephone mode (FAXユウセン)

When you want to answer voice calls but do not want to be disturbed by fax calls.
If no one answers the call, the unit will receive the documents automatically. Or you can answer the call and press the start button for fax receiving.

1. Press  (function). キノウ トウロク モード*
2. Press . サ* イタク=テ* ヲウユウセン
or
サ* イタク=FAXユウセン
3. Press  (select) to select the Telephone mode (テ* ヲウユウセン) or Facsimile/Telephone mode (FAXユウセン).
4. Press  (record).
5. Press  (stop).

2 Auto receive mode

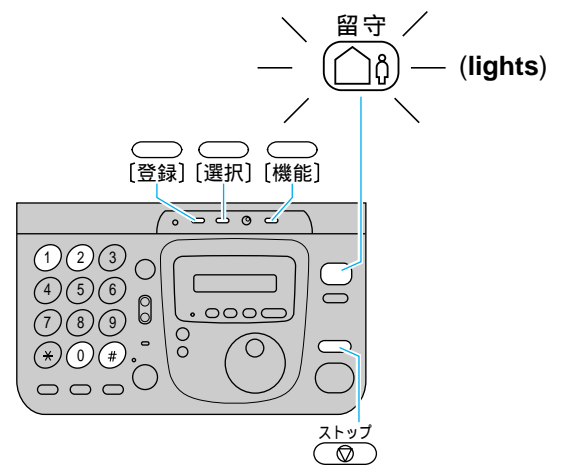

Answering machine/Facsimile mode (FAX/ルスデン)





When you want to use the unit to record voice messages and receive documents.
When a call is received, the unit plays your greeting message and records the voice message.
If a fax is detected, the unit receives the documents automatically.

Facsimile mode (FAXセンヨウ)

When you want to use the unit solely as a fax machine.
The unit receives documents automatically. You can not answer voice calls and the answering device will not function.

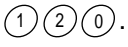
Answering machine mode (ルスデンセンヨウ)

When you want to use the unit to record voice messages only.
The unit will not receive documents automatically.

1. Press  (function). キノウ トウロク モード*
2. Press . ルス=FAX/ルステ* ヲン
or
ルス=FAXセンヨウ
or
ルス=ルステ* ヲンセンヨウ
3. Press  (select) to select the Facsimile mode, (FAX/ルステ* ヲン) Answering machine mode (FAXセンヨウ), or Answering machine/Facsimile mode (ルステ* ヲンセンヨウ).
4. Press  (register).
5. Press  (stop).

Answering Device Functions

1 Recording a greeting message

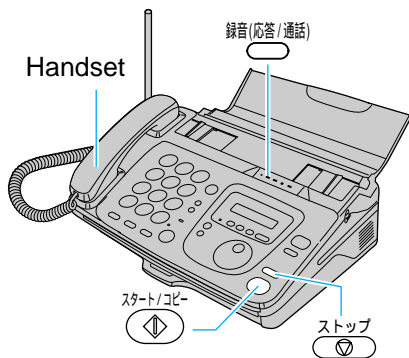

1. Press **録音(応答/通話)** (record).
2. Lift the handset.
3. Press **スタート/コピー** (start/copy).
4. Record your greeting message up to 16 seconds.
5. Press **ストップ** (stop) and replace the handset.
– The greeting message will be played back once automatically.

2 Erasing the greeting message

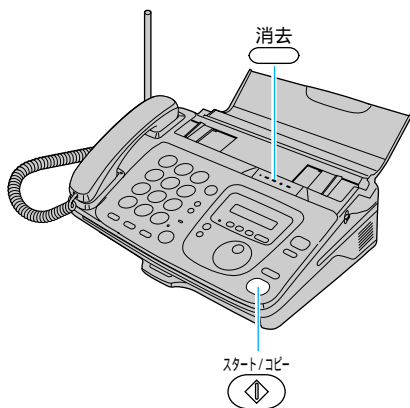

1. Press **消去** (erase) two times.
2. Press **スタート/コピー** (start/copy).

3 Setting the automatic answering device

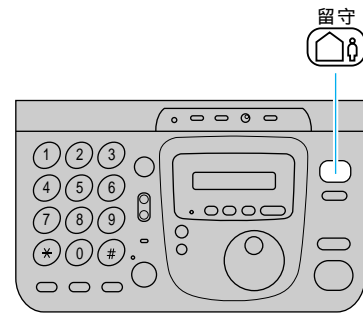

Press **留守** (auto receive).

- To cancel the automatic answering device mode, press **留守** (auto receive) again.

4 Listening to recorded messages

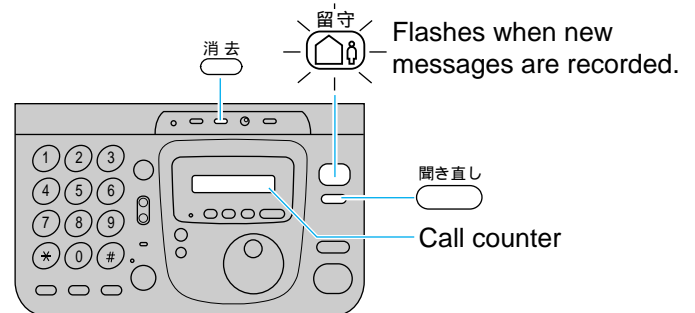

Press **留守** (auto receive) or **聞き直し** (repeat).

- To repeat a message during playback, press **聞き直し** (repeat).
- To play back the previous message, press **前の用件 ①** (previous).
- To change the playback speed, press **遅聞き ④** (slow) or **早聞き ⑤** (fast).
- To skip a message, press **次の用件 ③** (skip).

5 Erasing recorded messages

To erase all the recorded messages

1. Press **消去** (erase).
2. Press **スタート/コピー** (start/copy).

To erase a specific message

1. Press **消去** (erase) while listening to the message you want to erase.
2. Press **スタート/コピー** (start/copy).

Hand Scanner Functions (For KX-PW21CL only)

1 Preparations

1. Remove the hand scanner from the main unit and open the battery cover.

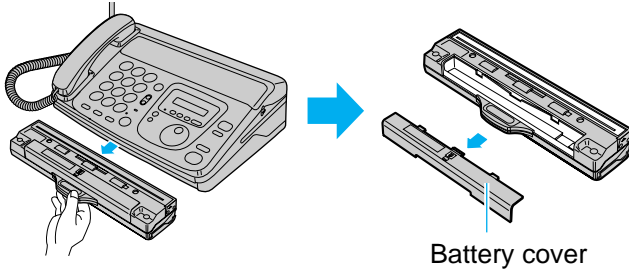

2. Install the battery (included).

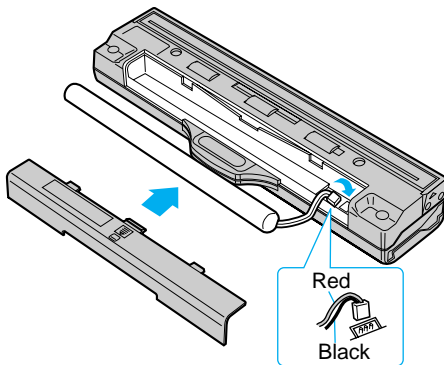

3. Connect the hand scanner to the main unit.

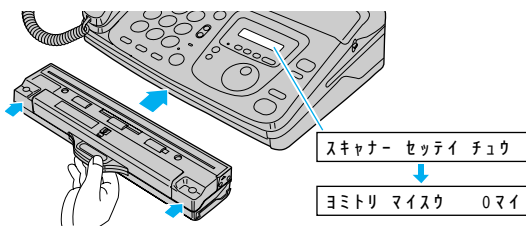

Power Indicator Memory Indicator

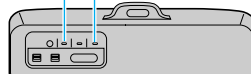

Power Indicator

	Lights (Red)	The battery power is full.
	Flashes (Red)	The battery power is low. Replace the battery.
	Does not light.	Replace the battery.

Memory Indicator

	Does not light.	Memory is empty.
	Lights (Green)	66% of memory is used.
	Flashes slowly (Green)	99% of memory is used.
	Flashes (Green)	Memory is full.

2 Scanning documents

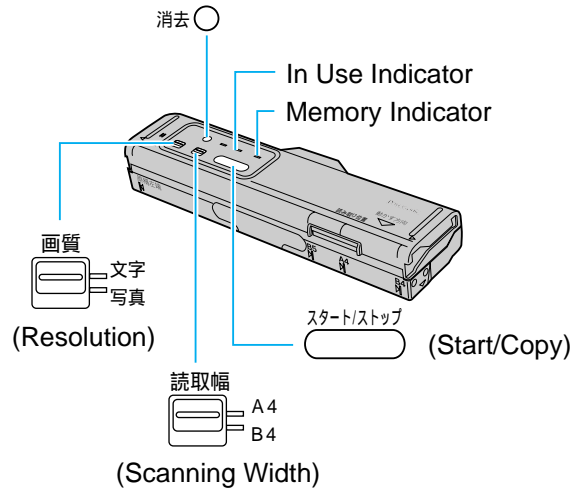

1. Remove the hand scanner from the main unit.
2. Select the resolution. (文字 : text, 写真 : photo)
3. Select the scanning width.
4. Set the hand scanner on the document.

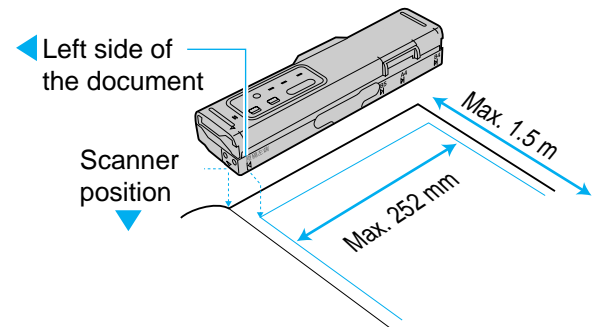

5. Press (start/stop).
 - A beep is heard.
 - The in use indicator light turns on (green).
6. Move the hand scanner slowly over the document.

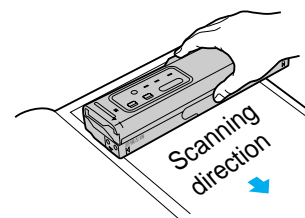

7. Press (start/stop) to end the operation.
8. Connect the hand scanner to the main unit.

Hand Scanner Functions (For KX-PW21CL only)

1 Printing all of the stored documents

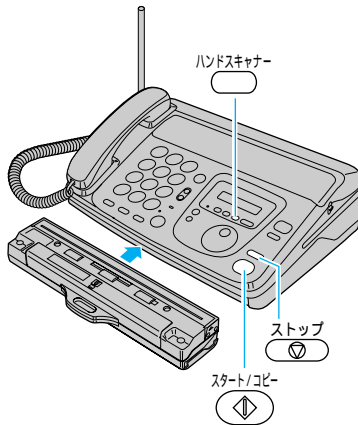

1. Connect the hand scanner to the main unit.
OR
If the hand scanner has already been connected,

press  (hand scanner).

- The main unit display will show:

ヨミトリ マイスウ 10マイ

10 pages are stored in the hand scanner.

2. Press  (start/copy).

- The main unit prints out all of the stored documents.

2 Erasing all of the stored documents

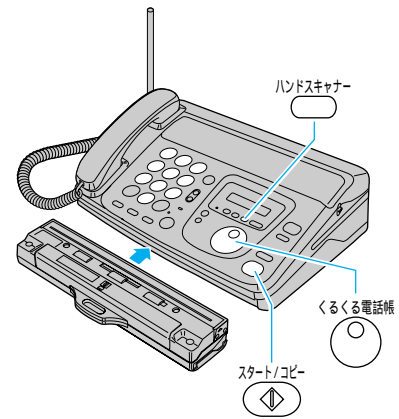

1. Connect the hand scanner to the main unit.
OR
If the hand scanner has already been connected,

press  .

- The main unit display will show:

ヨミトリ マイスウ 10マイ

2. Rotate  (search dial) until the main unit display shows the following message.

イッカツ ショウキヨ

3. Press  (start/copy).

Using a Caller ID Display Service

This unit can work with NTT's number display service. A contract with NTT (charge fee) and setting this unit are required.

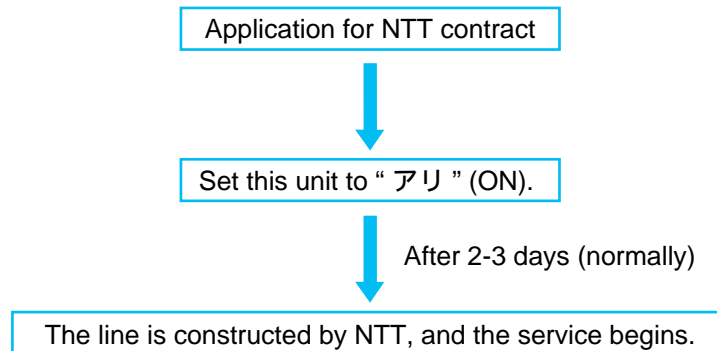

1 How the number is displayed

When you do not want to display your telephone number to the other party when calling, there are two methods available.

First choose the method and then you must apply to NTT.

Per-call Blocking

If you enter **184** before the number you call, your number will not be displayed.

Per-line Blocking

Your number will not be displayed for any call you make. However, you can display your number if you enter **186** before the number you call.

2 Setting up

Subscribe to NTT, and then set the display to “アリ” (ON).

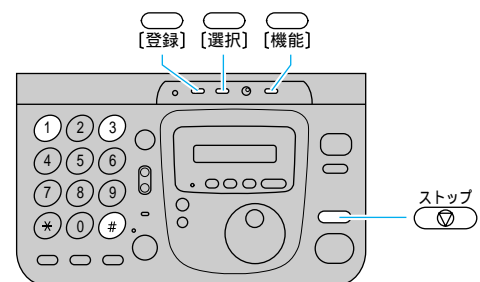

1. Press [機能] (function).
2. Press # 1 3 3.
3. Press [選択] (select) to select “アリ” (ON).

NO.ディスプレイ=アリ ON

↑ Changes each time you press [機能] (function). ↓

NO.ディスプレイ=ナシ OFF

4. Press [登録] (register).
5. Press ストップ (stop).

Note:

If you do not set the unit to “アリ” (ON), the first bell will ring shorter than usual, even if you receive the Caller ID Display service.

When you cancel the Caller ID Display service, select “ナシ” (OFF) in step 3.

Caller ID Display Service Functions

Using the Caller ID Display Service, this unit can store phone numbers and the date and time of the calls in memory. (Up to 30 calls, except 99 calls, can be stored in the search dial.) By using the search dial, you can search for the phone number, and the date and time of a call on the display of the unit.

1 Searching for a phone number with the main unit

[When you have not answered (a) call(s)]

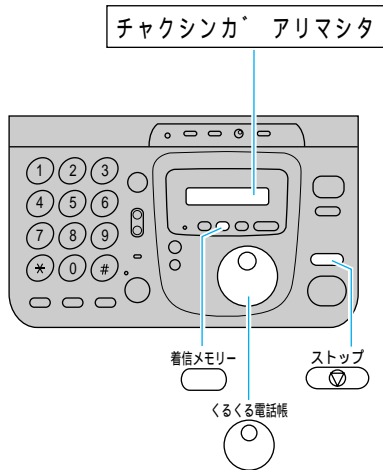

1. Press  (received call memory).

2. Rotate  (search dial).

“*” means new calls which have not been checked.

When you stop rotating  (search dial), the display will change between the number and the date and time.

Up to 13 digits can be displayed.

The latest 30 calls will be stored in memory.

3. When finished, press  (stop).

2 Searching for a phone number with the portable handset

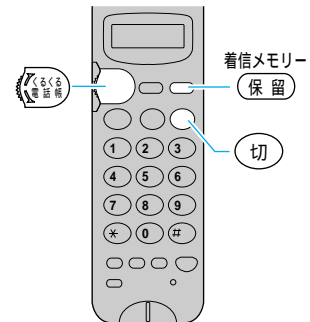

1. Press  (received call memory).

2. Rotate  (search dial).

“*” means new calls which have not been checked.

When you stop rotating  (search dial), the display will change between the number and the date and time.

Up to 11 digits can be displayed.

3. When finished, press  (disconnect).

Caller ID Display Service Functions

1 Printing a caller list

着信リスト		1998. 5. 1 12:00	
No.	年月日	時分	相手局名 (名前)
1	1998. 4. 30	15:30	09876543・・・ *
2	1998. 4. 29	13:54	01234567・・・ (カタオカ)
3	1998. 4. 29	8:30	コウシュウ デンワ

* マーク : ミカコンノ チャクシンメモリー



No., 年月日(year/month/day), 時分(hour/minute)

The unit prints the date and time of the received calls from the most recent call. (up to 30 calls)

相手局名(caller's phone number)

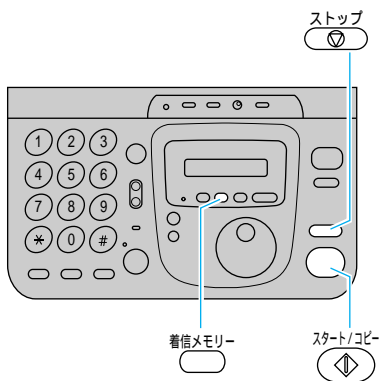
The unit prints the phone number of the caller. If the caller's name or phone number cannot be displayed, a message will be printed out instead. "*" means the call has not been checked. Up to 20 digits, including "*", can be printed.



1. Press  (received call memory).
2. Press  (start/copy).
3. When finished, press  (stop).

Using α -FAX Service

α -FAX service allows you to send documents overseas via the internet and has a cost efficient advantage due to the internet being integrated into the network.

To use this service, contracts with DDIE and DDI are required (free of charge).

For more information, call toll free 0077-772 (DDI customer service center).

1 How your fax is sent to the other party's fax machine

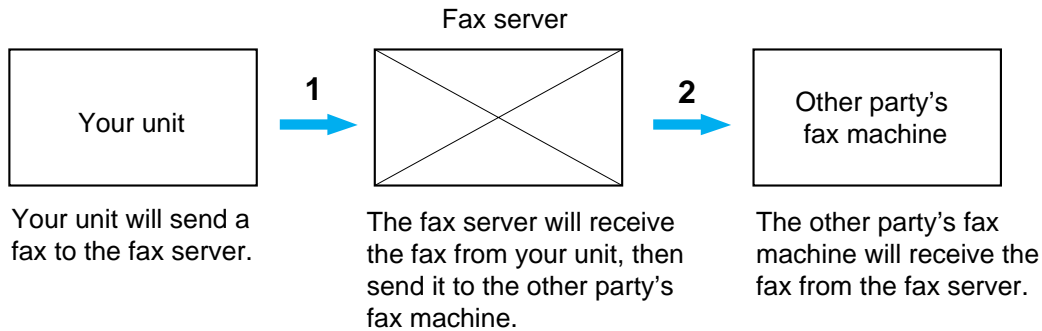

- 1 If any transmission errors occur between your unit and the fax server, your unit will automatically redial the fax server up to 3 times.
- 2 If any transmission errors occur between the fax server and the other party's fax machine, the fax server will automatically redial the other party's fax machine up to 4 times. If your fax is still not transmitted after 4 attempts, the fax server will fax a non-delivery notice to you. In this case, there is no charge. Set your unit to receive a fax.

2 Transmitting documents overseas using the α -FAX service

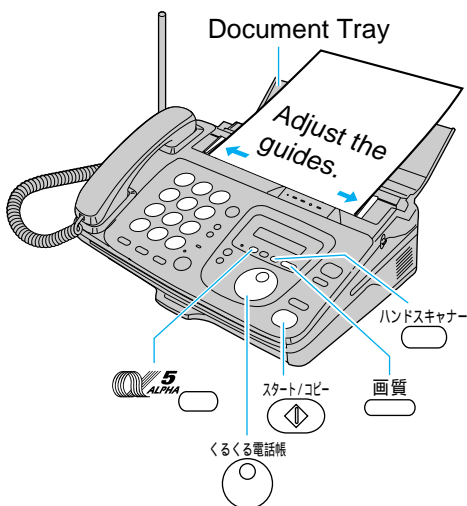

1. Open the document tray and adjust the guides.
2. Insert the document FACE DOWN until a beep is heard. (up to 5 sheets at a time)
3. Press (resolution) to select the resolution.
4. Press until the following is displayed.

1. アルファファクス
5. Press (start/copy).
6. Dial the phone number (country code, area code and telephone number).
– (search dial) can also be used.
7. Press (start/copy).

Note:

When you dial the phone number in step 6, do not enter an international access code such as "001" before the country code.

Specifications

■ Main unit

Power supply:

AC 100 V (50 Hz/60Hz)

Power Consumption:

	KX-PW11CL	KX-PW21CL
Transmission	Approx. 16 W	Approx. 18 W
Reception	Approx. 36 W	Approx. 36 W
Copy:	Approx. 38 W	Approx. 38 W
Standby:	Approx. 6 W	Approx. 6.5 W
Maximum*:	Approx. 140 W	Approx. 140 W

(*When copying a 100 % black document.)

Dimensions (H×W×D):

KX-PW11CL: Approx. 154×329×245 mm

KX-PW21CL: Approx. 154×329×249 mm

Mass (Weight):

KX-PW11CL: Approx. 3.3 Kg

KX-PW21CL: Approx. 3.9 Kg

Operating Environment:

5 °C–35 °C, 45 %–85 % RH (Relative Humidity)

Applicable Lines:

Telephone line (tone/pulse)

Facsimile communication network, NCC line

DC Resistance*1:

320 Ω

Compatibility

G3 compatible

Document Size:

B4–A5 (Max. 257 mm in width, Max. 800 mm in length)

Effective Scanning Width:

252 mm (B4), 208 mm (A4)

Effective Printing Width:

252 mm (B4), 206 mm (A4)

Transmission Time*2:

Approx. 15s/page (Original mode)

Modem Speed:

9600/7200/4800/2400 bps; Automatic fallback

Halftone Level:

64-level

Scanning Density:

Horizontal: 8 pels/mm

Vertical: 7.7 lines/mm—Fine, Photo

3.85 lines/mm—Standard

Scanner Type:

CCD image sensor

Printer Type:

Thermal printing

Data Compression System:

Modified Huffman (MH)

Recording Paper Size:

B4: 257 mm×30 m roll

A4: 210 mm×30 m roll

Answering Device:

Greeting message: Digital recording system (up to 16 sec.)

Pre-recorded greeting message

ICM Recording: Digital recording system (approx. 12 min. in total)

■ Portable handset

Power Supply:

Ni-Cd battery (part no. KX-AN35)

(DC 3.6 V) (600 mAh)

Dimensions (H×W×D):

Approx. 195×50×45 mm

Mass (Weight):

Approx. 204 g (including battery)

Operating Environment:

5 °C–35 °C, 45 %–85 % RH (Relative Humidity)

■ Battery charger

Power Supply:

AC Adaptor (part no. KX-A12N, PFAP1001)

AC 100 V (50 Hz/60 Hz) (DC 9 V) (200 mA)

Power Consumption:

Charging: Approx. 2.8 W

Standby: Approx. 1.0 W

Dimensions (H×W×D):

Approx. 76×79×90 mm

Mass (Weight):

Approx. 86 g

Operating Environment:

5 °C–35 °C, 45 %–85 % RH (Relative Humidity)

■ Hand scanner (KX-PW21CL only)

Power Supply:

Ni-Cd battery (part no. KX-FAN36)

(DC 4.8 V) (600 mAh)

Dimensions (H×W×D):

Approx. 40×275×83 mm

Mass (Weight):

Approx. 452 g (including battery)

Operating Environment:

5 °C–35 °C, 45 %–85 % RH (Relative Humidity)

Effective Scanning Width:

252 mm (B4), 208 mm (A4)

Scanning Density:

Horizontal: 8 pels/mm

Vertical: 7.7 lines/mm

Scanner Type:

CCD image sensor

Memory Capacity*3:

Approx. 20 pages—Text (Standard)

Approx. 10 pages—Text (Fine)

Approx. 1 page—Photo

*1 If you cannot make a voice call due to 320 Ω of DC resistance, consult with your dealer.

*2 The transmission speed is based on an A4-size document including 700 characters sent in standard resolution at 9600 bps. Transmission speed depends upon the contents of the pages, resolution, telephone line conditions and capability of the receiving unit.

*3 The memory capacity is based on an A4-size document including 700 characters.

