

Miele

Operating and installation instructions



Wine conditioning unit KWT 4974 SG ed

To avoid the risk of accidents or damage to the appliance, it is **essential** to read these instructions before it is installed and used for the first time.

en - AU, GB

M.-Nr. 07 742 070

Contents

Description of the appliance	4
Optional accessories	6
Bottle presenter	6
Caring for the environment	7
Warning and Safety instructions	8
Switching on and off	12
Safety lock	12
Switching off for longer periods of time	13
The optimum temperature and humidity	14
Temperature	14
Safety features	14
Isolator plates for thermal separation	14
Setting the temperature	15
Temperature range	15
Temperature displays	15
Temperature display brightness	16
Humidity level	16
Constant humidity (Dynamic cooling) button 	17
Switching off Dynamic cooling	17
Air filtering with the active charcoal filter	17
Interior lighting	18
Switching on the interior lighting	18
Adjusting the brightness	18
Storing wine bottles	19
Descriptive labels	19
Maximum capacity	19
Door lock	19
Alarm	20
Temperature alarm	20
Door alarm	20
Activating the alarm system	20
Switching the alarm off early	20
Defrosting	21
Cleaning and care	22
Cleaning the outer casing, the door, the interior and accessories	22
Ventilation gaps	23
Door seal	23

Contents

Metal grille at the back of the appliance	23
Active charcoal filter	23
Problem solving guide	24
Noises	26
How to save energy	27
After Sales / Guarantee	28
Electrical connection IRL, U.K., ZA	29
Electrical connection AUS, NZ	30
Installation	31
Location	31
Climate range	31
Ventilation	31
Installation	32
Aligning the appliance.	32
Changing the door hinging	33

Description of the appliance

Upper and middle temperature zone controls

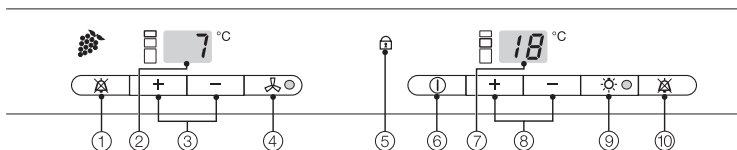

- ① Alarm off button for upper zone
- ② Temperature display for upper zone
- ③ Temperature selector buttons for upper zone (+ for warmer; – for colder)
- ④ Constant humidity (Dynamic cooling) button with indicator light for upper and middle zones
- ⑤ Safety lock indicator light for upper and middle zones
- ⑥ On/Off button for upper and middle zones
- ⑦ Temperature display for middle zone
- ⑧ Temperature selector buttons for middle zone (+ for warmer; – for colder)
- ⑨ Interior lighting button with indicator light for entire appliance
- ⑩ Alarm off button for middle zone

Lower temperature zone controls

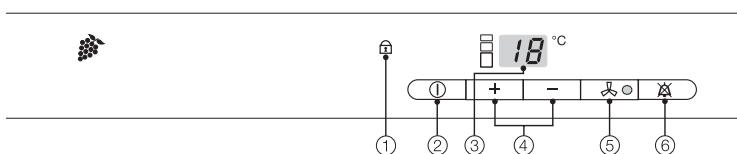

- ① Safety lock indicator light for lower zone
- ② On/Off button for lower zone
- ③ Temperature display for lower zone
- ④ Temperature selector buttons for lower zone (+ for warmer; – for colder)
- ⑤ Constant humidity (Dynamic cooling) button with indicator light for lower zone
- ⑥ Alarm off button for lower zone

Description of the appliance

- ① Door lock
- ② Interior lighting
- ③ Active charcoal filter
- ④ Wooden shelf with shelf edge trim for descriptive labels
- ⑤ Controls for the upper and middle temperature zones / Isolator plate for separating the zones
- ⑥ Glass door with UV filter
- ⑦ Handle
- ⑧ Controls for the lower temperature zones / Isolator plate for separating the zones
- ⑨ Isolator strip for separating the temperature zones
- ⑩ Condensate channel and drain hole

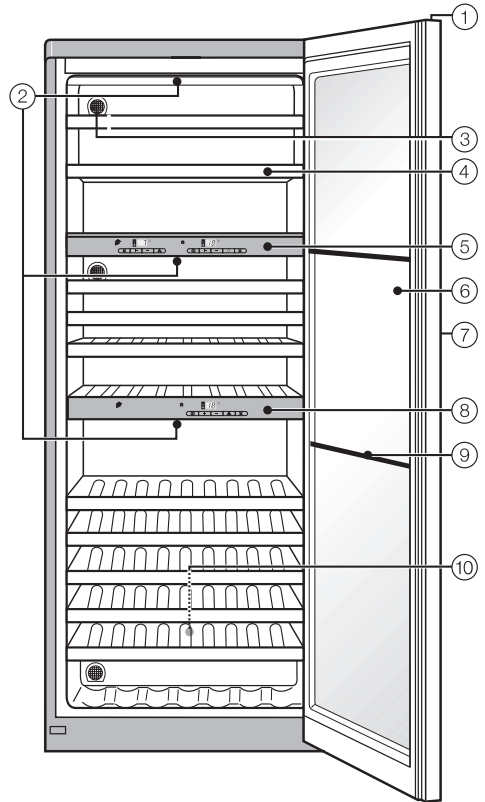

Important!

In tropical areas with temperatures over 38°C and a humidity level greater than 70%, the appliance may only be used in air conditioned rooms. Otherwise the efficiency of the appliance cannot be guaranteed.

Description of the appliance

Optional accessories

Bottle presenter

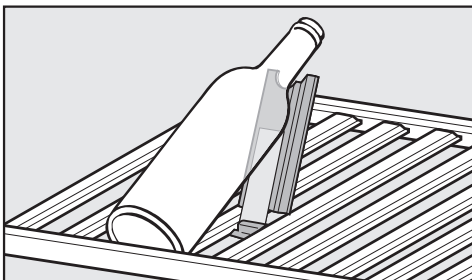

This bottle presenter is available from the Miele Spare Parts Department or your dealer.

Disposal of the packing material

The transport and protective packing has been selected from materials which are environmentally friendly for disposal, and can normally be recycled.

Ensure that any plastic wrappings, bags etc. are disposed of safely and kept out of the reach of babies and young children. Danger of suffocation!

Rather than just throwing these materials away, please ensure that they are recycled.

Disposal of your old appliance

Electrical and electronic appliances often contain materials which, if handled or disposed of incorrectly, could be potentially hazardous to human health and to the environment. They are, however, essential for the correct functioning of your appliance. Please do not therefore dispose of it with your household waste.

Please dispose of it at your local community waste collection / recycling centre or contact your dealer for advice. Ensure that it presents no danger to children while being stored for disposal.

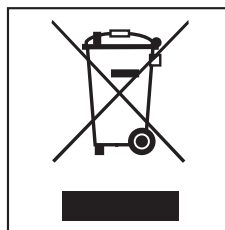

It should be unplugged or disconnected from the mains electricity supply by a competent person.

Take care not to damage the pipework at the back of it before or during transportation to an authorised collection depot.

In this way, refrigerant in the pipework and oil in the compressor will be contained, and will not leak out into the environment.

Warning and Safety instructions

This appliance complies with all relevant local and national safety requirements. Improper use can, however, present a risk of both personal injury and material damage.

To avoid the risk of accidents and damage to the appliance, please read these instructions carefully before using it for the first time. They contain important notes on the installation, safety, operation and care of the appliance.

Keep these instructions in a safe place and pass them on to any future user.

Warning!

If installed at altitudes above 1500 m, there is a risk of the glazing in the door shattering. Shards of glass are very sharp and can cause severe injury if not handled with care.

Correct application

- ▶ This appliance is intended for domestic use only for storing wine. Any other usage is not supported by the manufacturer and could be dangerous. The manufacturer cannot be held liable for damage resulting from the incorrect or improper use of the appliance.
- ▶ This appliance is not intended for use by persons (including children) with reduced physical, sensory or mental capabilities, or lack of experience and knowledge, unless they are supervised whilst using it, or have been shown how to use it correctly by a person responsible for their safety.

Safety with children

- ▶ This appliance is not a toy! To avoid the risk of injury, do not allow children to play with it or near it, or to play with the controls. Neither should they be allowed to climb inside it or to swing on the door. Please supervise young children whilst you are using it. Older children may only use the appliance when its operation has been clearly explained to them and they are able to use it safely, recognising the dangers of misuse.

Warning and Safety instructions

Technical safety

- ▶ Before setting up the appliance, check it for any externally visible damage.
Do not install and use a damaged appliance.



- ▶ This appliance contains the coolant Isobutane (R600a), a natural gas which is environmentally friendly. Care must be taken during transportation and setting up of the appliance that no parts of the cooling system are damaged. Leaking coolant can damage the eyes. In the event of any damage:

- avoid open flames and anything which creates a spark,
- disconnect from the mains,
- air the room in which the appliance is located for several minutes and
- contact the Service Department for advice.

- ▶ The more coolant there is in an appliance, the larger the room it should be installed in. In the event of a leakage, if the appliance is in a small room, there is the danger of combustible gases building up. For every 8 g of coolant at least 1 m³ of room space is required. The amount of coolant in the appliance is stated on the data plate inside the appliance.

- ▶ Before connecting the appliance to the mains supply, make sure that the connection data on the data plate (voltage and connected load) match the mains electricity supply. This data must correspond in order to avoid the risk of damage to the appliance. Consult a qualified electrician if in any doubt.

- ▶ The electrical safety of this appliance can only be guaranteed when continuity is complete between it and an effective earthing system which complies with current local and national safety regulations. It is most important that this basic safety requirement is present and tested regularly, and where there is any doubt, the household wiring system should be inspected by a qualified electrician. The manufacturer cannot be held liable for damage or injury caused by the lack of or inadequacy of an effective earthing system (e.g. electric shock).

- ▶ If the connection cable is faulty it must only be replaced by a Miele approved service technician to protect the user from danger.

- ▶ Safe operation of the appliance is only assured if it has been installed and connected in accordance with these operating and installation instructions.

- ▶ This appliance may only be used in mobile installations such as ships, if a risk assessment of the installation has been carried out by a suitably qualified engineer.

Warning and Safety instructions

► Installation work, maintenance and repairs may only be carried out by suitably qualified and competent persons in accordance with national and local safety regulations. Repairs and other work by unqualified persons could be dangerous and the manufacturer will not be held liable. Ensure current is not supplied to the appliance until after maintenance or repair work has been carried out.

► The appliance is only completely isolated from the electricity supply when:

- it has been switched off at the wall socket and the plug has been withdrawn, or
- the fuse from the fused spur connection unit has been withdrawn, or
- the mains fuse has been disconnected, or
- the screw-out fuse is removed (in countries where this is applicable).

► Do not connect the appliance to the mains electricity supply by an extension lead.

Extension leads do not guarantee the required safety of the appliance (e.g. danger of overheating).

► In countries where there are areas which may be subject to infestation by cockroaches or other vermin, pay particular attention to keeping the appliance and its surroundings in a clean condition at all times. Any damage which may be caused by cockroaches or other vermin will not be covered by the guarantee.

Correct use

► Do not store explosive materials in the appliance or any products containing propellants (e.g. spray cans). Thermostats switching on may produce sparks which could present a fire hazard. Flammable compounds could explode.

► Do not use any electrical equipment in this appliance. Danger of sparking and explosion.

► Do not use any oils or grease on the door seals, as these will cause the seals to deteriorate and become porous with time.

► Do not block the ventilation gaps in the appliance as this would impair the efficiency of the appliance, increase the electricity consumption and could cause damage to the appliance.

► The appliance is designed for use within certain climate ranges (ambient temperatures), and should not be used outside this range. The climate range for your appliance is stated on the data plate inside the appliance.

Installing it in a room with too low an ambient temperature, e.g. a garage, can lead to the appliance switching off for longer periods so that it cannot maintain the required temperature.

► Do not use a steam-cleaning appliance to clean this appliance. Steam could reach the electrical components and cause a short circuit.

Disposing of your old appliance

► Before disposing of an old appliance, first make the door latch or lock unusable.

This way you will prevent children from accidentally locking themselves in and endangering their lives.

► Be careful not to damage any part of the pipework whilst awaiting disposal, e.g. by

- puncturing the refrigerant channels in the evaporator.
- bending any pipework.
- scratching the surface coating.

Splashes of refrigerant can damage the eyes.

The manufacturer cannot be held liable for damage caused by non-compliance with these Warning and Safety instructions.

Switching on and off

Before using for the first time

The stainless steel surfaces have a layer of protective foil to prevent scratching during transportation.

- Do not remove this foil until the appliance has been installed or built in. Start at one of the upper corners.
- After removing the protective foil, treat stainless steel surfaces with a suitable stainless steel conditioning agent (available from www.miele-shop.com).

Important: Stainless steel conditioner gives long lasting protection, and helps to prevent resoiling.

- Clean the inside of the appliance and the accessories with warm water and a little washing-up liquid, and then dry with a soft cloth.

Important:
To ensure the correct functioning of the appliance, let it stand for between 1½ and 2 hours after transporting it to its final location before connecting it to the mains.

Switching on

The upper and middle temperature zones can only be switched on and off together, whereas the lower temperature zone can be switched on and off separately. In this way the lower temperature zone, for example, can be switched off if not required.

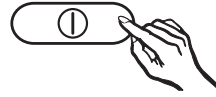

- Press the On/Off button for the zone you wish to switch on until the temperature display lights up or flashes.

The appliance will begin to cool down, and the interior light comes on when the door is opened (the interior light only comes on when both upper zones are switched on).

Switching off

- Press the On/Off button for the zone you wish to switch off until the temperature display goes out.

The cooling system is switched off. (If this does not happen, the safety lock is still activated).

Safety lock

The safety lock can be used to prevent the two upper zones or the lower zone from being switched off inadvertently.

Activating or de-activating the safety lock

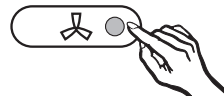

- Press and hold the constant humidity button for the relevant zone for approx. 5 seconds.

The constant humidity button indicator light will start flashing and a **■** will flash in the relevant temperature display.

- Press the constant humidity button again.

☒ will light up in the display.



- You can now choose between ☒ 0 and ☒ 1:

0: the safety lock is de-activated,

1: the safety lock is activated.

- Press the constant humidity button to save the setting.

The relevant safety lock indicator light  will light up when the safety lock has been activated.

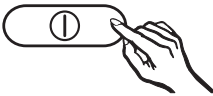

- Press the relevant On/Off button to come out of the setting mode.

If you do not do this the electronics will revert automatically to normal operation after a couple of minutes.

Switching off for longer periods of time

If the appliance is not going to be used for a longer period of time, e.g. whilst on holiday,

- switch the appliance off,
- switch off at the wall socket and withdraw the plug,
- clean the appliance out and
- leave the door ajar to air the appliance.

If, during a long absence, the appliance is switched off but not cleaned out and the door is left shut, there is a danger of mould and odours building up inside the appliance.

The optimum temperature and humidity

Wine keeps on maturing depending on the surrounding conditions. The length of time for which wine can be kept in good condition will therefore depend not only on the temperature but also on the air quality.

The wine conditioning unit, with its constant ideal temperature, increased air humidity and odour free atmosphere, offers the perfect conditions for storing your wine.

Temperature

Wine can be stored at a temperature between 5°C and 18°C. If you wish to store red and white wines together, select a temperature between 10 and 12°C. Most white wines are palatable at this temperature. It is best to take red wine out of the appliance about two hours before drinking. Open the wine to allow it to breathe and to develop its aroma. After two hours, red wine will be at the correct temperature for drinking.

If wine is stored at a temperature above 22°C it will mature too quickly. Wine should not be stored below 5°C for a long period of time as it will not mature fully at this low temperature.

Fluctuations in temperature put wine under stress and interrupt the maturing process. It is therefore very important to maintain a constant temperature.

A constant temperature will be maintained in the appliance at an ambient room temperature of 10 to 38 °C. (This is a wider temperature range than the climate range quoted on the data plate).

Safety features

A thermostat prevents the temperature in the appliance falling too low. If the external temperature should drop below this level, a heater element in the appliance switches on automatically to keep the temperature inside as constant as possible.

Isolator plates for thermal separation

The appliance has two fixed isolator plates which divide the cabinet into three different temperature zones. This enables you to store three different types of wine at the same time, e.g. red wine, white wine and Champagne.

The isolator strips on the inner surface of the glass door keep the temperature constant in the individual zones.

The following temperatures are recommended for the different types of wine:

Red wine:	+14 °C to +18 °C
Rosé wine:	+10 °C to +12 °C
White wine:	+8 °C to +12 °C
Sparkling white wines:	+7 °C to +9 °C
Champagne:	+5 °C to +7 °C

The optimum temperature and humidity

Setting the temperature

The temperature can be set in all three zones separately.

To do this, press the buttons under the respective temperature displays:

Press the



- + button : to raise the temperature
- button: to reduce the temperature.

The temperature being set will flash in the display.

When pressing the buttons, the following information shows in the display:

- When first pressed, the **last temperature selected** flashes.
- Each subsequent press of the button adjusts the temperature shown in 1 °C steps.
- Keeping the button pressed in adjusts the temperature continually.

Approx. 5 seconds after letting go of the button, the **current** temperature of the zone concerned is automatically shown.

Temperature range

In all three zones, it is possible to set temperatures between 5 and 20°C.

Temperature displays

During normal operation, the temperature displays on the control panel show the temperatures inside each zone.

If the temperature in one of the zones is not within the range that the appliance is able to display, only bars will light up in the temperature display.

Depending on the ambient temperature and the setting, it can take the appliance a few hours to reach the temperature required and for this temperature to then be shown as a constant temperature in the display.

The **temperature display will flash** if

- a different temperature is being set,
- the temperature in one of the zones is too high or too low.

The optimum temperature and humidity

Temperature display brightness

The appliance is supplied with the brightness of the temperature displays set as low as possible.

You can adjust the brightness of the temperature displays (the temperature displays for the upper and middle zones are adjusted together):

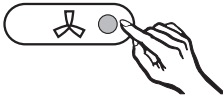

- Press and hold the constant humidity button for the relevant zone for approx. 5 seconds.

The constant humidity button indicator light will start flashing, and a **h** will flash in the relevant temperature display.



- Press one of the temperature selector buttons repeatedly until **h** appears in the display.

- Press the constant humidity button again.

h will light up in the display.

- You can now adjust the level of brightness by pressing the temperature selector buttons. You can choose from settings **1** to **5**:

1: lowest setting,

5: brightest setting.

- Press the constant humidity button to save the setting.

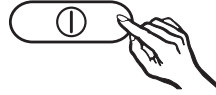

- Press the relevant On/Off button to come out of the setting mode.

If you do not do this the electronics will revert automatically to normal operation after a couple of minutes.

Humidity level

It is very important to store wine in an atmosphere with a high humidity level so that the corks remain moist on the outside. A refrigerator with its low humidity level is therefore not the best place to store wine. Low humidity causes corks to dry out from the outside, and so do not seal the bottles as tightly. Wine should be stored lying down to keep the corks moist from the inside too. Air entering the bottle will inevitably spoil the wine.

The ideal humidity level of up to 70 % will be maintained inside the appliance as long as the ambient room temperature is between 15°C and 35°C.

Useful tip: Before serving, stand the wine upright for at least two hours, or the entire day if possible, to allow any sediment to settle at the bottom of the bottle.

The optimum temperature and humidity

Constant humidity (Dynamic cooling) button

Dynamic cooling raises the relative humidity inside the appliance, and distributes the humidity and the temperature evenly around the interior so that you can store all your wine under exactly the same excellent conditions.

You can switch dynamic cooling on and off for both the upper zones together and separately for the lower zone.

Switching on Dynamic cooling

If you would like to use the appliance to store wine long term, we recommend that you keep the dynamic cooling function switched on. This will create a continuous climate in the cabinet which imitates that of a wine cellar.

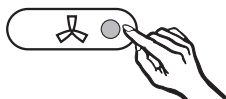

- Press the relevant constant humidity button. The indicator light will come on.

Even if dynamic cooling has not been switched on, the fans in the appliance will come on automatically when the cooling system switches on to ensure your wine is kept in the optimum climate.

The fans switch off automatically when the door is open.

Switching off Dynamic cooling

The appliance uses slightly more energy and is a little noisier when the dynamic cooling function is switched on. You can switch it off now and then if you wish.

- Press the relevant constant humidity button. The indicator light will go out.

Air filtering with the active charcoal filter

The active charcoal filters achieve optimum air quality by filtering the incoming air.

Fresh air from the outside enters the appliance via the active charcoal filters. The dynamic cooling system then distributes the air evenly throughout the cabinet.

Filtering the incoming air through the active charcoal filters ensures that all the air entering the appliance is fresh and free from dust and smells.

This in turn ensures your wine does not absorb any unwanted odours.

Replace the active charcoal filters with new ones once a year (see "Cleaning and care"). These are available from your dealer or the Miele Spare Parts Department.

Interior lighting

The interior lighting can be switched on to display your wine to its best effect when the door is shut.

Each temperature zone has its own light, so that all three zones are lit up.

The use of LED lighting avoids any damage to the wine due to heat or UV light.

Switching on the interior lighting

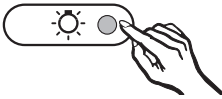

- Press the interior lighting button. The indicator light will come on.

All three lights are switched on or off simultaneously.

Adjusting the brightness

The brightness of the interior lighting can be adjusted.

- Press and hold the interior lighting button. The indicator light will come on



- Press one of the two temperature buttons.

Press the

+ button : for the lighting to become brighter

– button: for the lighting to become dimmer

The brightness for all three zones is adjusted simultaneously.

Do not remove the lighting covers. Should the covers be damaged or need to be removed due to damage, **exercise caution.** There are lasers in the lighting (laser beam class 1M) which you should avoid looking at directly. Do not use optical instruments to look at the lighting either!

Any vibration or movement of the bottle can affect the wine by interrupting the natural respiration process and so impair the taste.

As far as possible, store bottles of the same type of wine beside each other on the same shelf. Removing a bottle of one type will then leave the other types undisturbed and will avoid the need to move different bottles around.

Please make sure that the vents at the top of each of the three temperature zones are not covered by bottles. This is important for the correct functioning of the appliance. Use these areas to store narrower wine bottles.

Wooden shelves

Each wooden shelf has a load bearing capacity of 50 kg and can support a maximum of 4 layers of bottles (each row taking 9 x 0.75 litre bottles).

The wooden shelves are on runners which can be pulled out to make it easier to store and remove bottles.

The wooden shelves can be removed if required.

- Pull out the wooden shelf on its rails until it stops, then lift it up and out.
- To replace the shelf, click it into place on the extended rails.

Descriptive labels

Use the labels supplied to identify your wine quickly and easily. Insert the labels into the strips at the front of the shelves from above.

Additional labels can be purchased from your Miele Dealer or the Miele Spare Parts Department.

Maximum capacity

A total of 143 bottles (0.75 l) can be stored in the appliance, with 36 in the upper zone, 45 in the middle zone and 62 in the lower zone.

Door lock

You can lock the door of the wine conditioning unit to prevent it being opened without your knowledge.

- Insert the key into the door lock.
- Press it down and turn it 90° until the door lock engages.
- Remove the key by pulling it upwards.

To unlock the appliance, carry out the procedure in the reverse order, turning the key in the opposite direction.

Alarm

Your appliance is fitted with a warning system which ensures that the temperature in the three zones cannot rise or fall unnoticed and impair the wine.

Temperature alarm

The alarm will sound if the temperature in one of the zones rises approx. 4 °C above or falls approx. 4 °C below the set temperature. The relevant temperature display will flash at the same time.

The alarm will sound and the temperature display will flash:

- when you switch the appliance on, and for as long as the temperature in a particular zone differs from the temperature set.
- if the door has been left open for a while in order to re-arrange or take wine bottles out and warm air has entered the appliance.
- if a large number of wine bottles are put into the storage unit at once.
- if there has been a lengthy interruption to the power supply.

Door alarm

If the door has been left open for more than approx. 60 seconds the alarm will sound.

Activating the alarm system

The alarm system is always active. It does not have to be switched on manually.

Switching the alarm off early

Once the set temperature has been reached in a particular temperature zone, the alarm stops and the temperature display concerned lights up constantly. However, if the noise disturbs you, you can switch the alarm off before this if you wish.



- Press the alarm off button concerned.

The alarm will stop. The temperature display continues to flash until the set temperature has been reached. The display then lights up constantly. The alarm system is now fully active once more.

Condensate and frost can build up on the back wall of the appliance whilst it is in use. These are automatically defrosted and removed by the appliance.

The condensate is drained away via a channel and drain hole into an evaporation system at the back of the appliance.

Ensure that the condensate channel and drain hole are never blocked so that condensate can flow away without hindrance.

Cleaning and care

Never use cleaning agents containing abrasive substances such as sand, soda, acids or chemical solvents. "Non-abrasive" cleaning agents are also unsuitable as they can cause matt areas to appear.

For stainless steel surfaces, use a suitable stainless steel conditioning agent (available from www.miele-shop.com).

Make sure that no water can penetrate into the electronic unit or into the lighting.

Do not let water get into the drainage channel and drain hole when cleaning.

Do not use steam cleaning apparatus to clean the appliance. Steam could reach the electrical components and cause a short circuit.

The data plate located inside the appliance must not be removed. It contains information which is required in the event of a service call.

Before cleaning

- Switch the appliance off at the wall socket and remove the plug.
- Take out any removable parts, e.g. shelves, for cleaning.

Cleaning the outer casing, the door, the interior and accessories

Use warm water with a little washing up liquid. Accessories and shelves should all be hand-washed only.

- Clean the condensate channel and drain hole frequently so that condensate can drain away unhindered. Use a straw or similar to clear the drain if necessary.
- After cleaning, wipe the interior and accessories with a damp cloth, and dry with a soft cloth. Leave the door open to air the appliance for a short while.
- Clean stainless steel surfaces with a suitable cleaning agent following the manufacturer's instructions on the packaging.
- After cleaning, stainless steel surfaces should be treated with a conditioning agent for stainless steel.

It is important to do this every time the stainless steel surfaces are cleaned, as the stainless steel conditioner protects the surfaces and helps prevent re-soiling.

- Clean the appliance door with a proprietary glass cleaner.
- A microfibre "E-Cloth" is available from the Miele UK Spare Parts Department, which is suitable for cleaning surfaces such as stainless steel, glass, plastic and chrome without the use of chemicals.

Ventilation gaps

- The ventilation gaps should be cleaned regularly with a brush or vacuum cleaner. A build-up of dust will increase the energy consumption of the appliance.

Door seal

Do not use any oils or grease on the door seal as these will cause the seal to deteriorate and become porous over time.

The door seal should be cleaned regularly with clean water and then wiped dry with a soft cloth.

Metal grille at the back of the appliance

The metal grille at the back of the appliance (heat exchanger) should be dusted at least once a year. A build-up of dust will increase the energy consumption of the appliance.

When cleaning the grille, make sure that the pipework and other components do not get broken or damaged in any way.

Active charcoal filter

Replace the active charcoal filters with new ones once a year. These can be purchased from your Miele dealer.

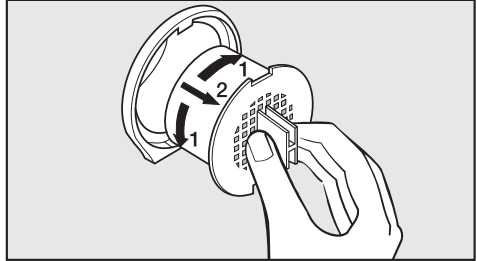

- Turn the filter 90° clockwise or anti-clockwise.
- Remove the filter.
- Insert a new filter with the handle in the vertical position.
- Turn the filter 90° clockwise or anti-clockwise until it clicks into position.

After cleaning

- Replace all shelves and accessories in the appliance.
- Insert the plug in the socket and switch the appliance back on.

Problem solving guide

Repairs to electrical appliances should only be carried out by a suitably qualified and competent person in strict accordance with current local and national safety regulations. Repairs and other work by unqualified persons could be dangerous. The manufacturer cannot be held liable for unauthorised work.

What to do if . . .

. . . the appliance does not get cool.

- Check whether the appliance has been switched on. The temperature display must be lit up.
- Check that the plug is correctly inserted in the socket and switched on.
- Check that the fuse is not defective and that the mains fuse has not blown.

If it has, contact the Miele Service Department.

. . . the appliance is switching in too frequently and for too long.

- Check whether the ventilation gaps have been covered over or become dusty.
- Check whether the metal grille (heat exchanger) at the back of the appliance has become too dusty.
- The appliance door is being opened frequently.
- Check that the door has been closed properly.

. . . the alarm sounds and the temperature display flashes.

The temperature in one of the zones has risen higher or fallen lower than the temperature that has been set. This could be due to:

- the appliance door being opened too often.
- a blocked ventilation gap.
- a lengthy interruption to the power supply.

Once the problem has been resolved the temperature display will light up constantly and the alarm will stop.

. . . a bar is lit up or flashing in the temperature display.

Only temperatures within the range the appliance can display will be shown. If the temperature is not within this range, a bar will be displayed instead.

. . . "F0" or "F1" appears in the temperature display.

There is a fault. Call the Service Department.

. . . you cannot switch the appliance off.

The safety lock has been activated.

. . . the interior light is not working.

- Was the door left open for too long? The lighting switches itself off automatically after approx. 15 minutes.
- Are the upper two zones switched off? The interior lighting only comes on when the upper two zones are switched on.

If this is not the case, then there is a fault.

Call the Miele Service Department.

Do not remove the lighting covers. Should the covers be damaged or need to be removed due to damage, **exercise caution**. There are lasers in the lighting (laser beam class 1M) which you should avoid looking at directly. Do not use optical instruments to look at the lighting either!

. . . mildew has begun to form on the wine bottle labels

Mildew can begin to form on the labels, depending on the type of adhesive used.

- Wash the wine bottles and remove any adhesive residue.

If you still cannot remedy the fault having followed these suggestions, please contact the Miele Service Department.

To prevent unnecessary loss of temperature it is advisable not to open the door while waiting for the appliance to be serviced.

Noises

Normal noises	What causes them
Brrrrr...	Humming noise made by the motor (compressor). This noise can get louder for brief periods when the motor is switching on.
Blubb, blubb....	A gurgling noise can be heard when coolant is circulating through the pipes.
Click....	Clicking sounds are made when the thermostat switches the motor on and off.
Sssrrrrr....	On multi-zone and frost-free appliances you can sometimes just hear the movement of air circulating inside the appliance.

Remember that the noise of the compressor and the coolant circulating in the system is unavoidable.

Noises that you can easily rectify	What causes them, and what can you do about them?
Rattling, vibrating	The appliance is uneven: Realign the appliance using a spirit level, by raising or lowering the screw feet underneath the appliance.
	The appliance is touching another appliance or piece of furniture: Move it away.
	Drawers, baskets or shelves are unstable or sticking: Check all removable items and refit them correctly.
	Are any bottles or containers unstable or knocking against each other? Separate them.
	The transport cable clips are hanging loose at the back of the appliance: Remove the clips.

How to save energy

	Normal energy consumption	Increased energy consumption
Installation site	In a ventilated room.	In an enclosed, unventilated room.
	Protected from direct sunlight.	In direct sunlight.
	Not situated near to a heat source (radiator, oven).	Situated near to a heat source (radiator, oven).
	Where the ideal ambient room temperature is approx. 20°C.	Where there is a high ambient room temperature.
Temperature setting with a thermostat which is approximate (set in stages).	With a medium setting of 2 to 3.	With a high setting: the lower the temperature in the compartment, the higher the energy consumption.
Temperature setting with a thermostat which is exact to the degree (digital display).	Cellar section 8 to 12°C	On appliances with winter setting, please make sure that the winter setting is switched off when the ambient temperature is warmer than 16 °C.
	Refrigerator section 4 to 5 °C	
	PerfectFresh zone just above 0 °C	
	Freezer section -18°C	
	Wine storage section 10 to 12 °C	
Use	Only open the doors when necessary and for as short a time as possible.	Frequent opening of the doors for long periods will cause a loss of coldness.
	Store food in an organised way.	If food is not stored in an organised way, searching for an item will mean the door is open for longer.
	Allow hot food and drinks to cool down before placing them in the appliance.	Placing hot food in the appliance will cause the compressor to run for a long time, as the appliance will have to work harder to lower the temperature.
	Store food covered or packaged.	The evaporation or condensation of liquids will cause a loss of coldness in the refrigerator.
	Place frozen food in the refrigerator to defrost.	
	Do not over-fill the appliance to allow air to circulate.	
Defrosting	Defrost the freezer compartment when a layer of ice 0.5 cm thick has built up.	A layer of ice hinders the cold from reaching the frozen food, and causes an increase in energy consumption.

After Sales / Guarantee

In the event of a fault which you cannot correct yourself, or if the appliance is under guarantee, please contact:

– your Miele Dealer

or

– Miele
(see back cover for contact details).

When contacting your Dealer or Miele, please quote the model and serial number of your appliance. This information is given on the data plate inside your appliance.

Please note that telephone calls may be monitored and recorded for training purposes.

N.B. A call-out charge will be applied for service visits where the problem could have been resolved as described in these instructions.

Guarantee

For information on the appliance guarantee specific to your country please contact Miele. See back cover for contact details.

In the U.K. your appliance is guaranteed for 2 years from the date of delivery. However, you must activate your cover by calling 0845 365 6640 or registering online at www.miele.co.uk.

All electrical work should be carried out by a suitably qualified and competent person in strict accordance with current local and national safety regulations (BS 7671 in the UK).

The appliance is supplied with a mains cable and moulded plug ready for connection to an a.c. single phase 220-240 V 50 Hz supply.

Please ensure that the connection data quoted on the data plate match the household mains supply.

Connection should be made via a suitable switched socket which is easily accessible. For extra safety it is advisable to install a residual current device (RCD) with a trip current of 30 mA (in accordance with DIN VDE 0664, VDE 0100, Section 739).

Do not connect the appliance to the mains electricity supply by an extension lead. Extension leads do not guarantee the required safety of the appliance (e.g. danger of overheating).

The appliance must not be connected to an inverter and must not be used with a plug adapter as these can cause damage to the appliance's electronic unit.

Non-rewireable plugs (BS 1363)

The fuse cover must be re-fitted when changing the fuse, and if the fuse cover is lost, the plug must not be used until a suitable replacement is obtained. The colour of the correct replacement cover is that of the coloured insert in the base of the plug, or the colour that is embossed in words in the base of the plug (as applicable to the design of the plug fitted).

Replacement fuses should be ASTA approved to BS 1362 and have the correct rating. Replacement fuses and fuse covers may be purchased from your local electrical supplier.

WARNING
THIS APPLIANCE MUST BE
EARTHED

Electrical connection AUS, NZ

All electrical work should be carried out by a suitably qualified and competent person in accordance with local and national safety regulations.

The appliance is supplied with a mains cable and moulded plug ready for connection to 220-240 V 50 Hz supply.

The voltage and frequency are given on the data plate. Please ensure that these match the household mains supply.

Connection should be made via a suitable switched socket which is easily accessible. For extra safety it is advisable to install a residual current device (RCD) with a trip current of 30 mA.

Do not connect the appliance to the mains electricity supply by an extension lead. Extension leads do not guarantee the required safety of the appliance (e.g. danger of overheating).

The appliance must not be connected to an inverter and must not be used with a plug adapter as these can cause damage to the appliance's electronic unit.

WARNING
THIS APPLIANCE MUST BE
EARTHED

Do not place any appliance which gives off heat, such as a toaster or microwave oven, on top of this appliance, as this would increase the appliance's energy consumption.

Location

The appliance should be installed in a dry, well-ventilated room.

It should not be installed where it is exposed to direct sunlight or directly adjacent to a heat-producing appliance such as an oven or a radiator.

The higher the ambient temperature of the room, the more energy the appliance requires to operate.

Important: tropical / humid environments

During periods of high humidity, some condensation may appear on outside surfaces of cooling appliances. This condensation will disappear when humidity levels drop. For prevention, it is advisable to install the appliance with sufficient ventilation in a dry and/or an air-conditioned room.

Please ensure that doors are closing and sealing properly.

Please ensure that the appliance is installed in accordance with these installation instructions and that the handle is fitted correctly. Should you require further assistance please contact your Miele customer service centre.

Climate range

The climate range of the appliance is stated on the data plate inside the appliance.

Climate range	Ambient room temperature
SN	+10°C to +32°C
N	+16°C to +32°C
ST	+16°C to +38°C
T	+16°C to +43°C

This appliance can operate in a wider room temperature range than indicated by the climate range. A constant temperature will be maintained in the appliance at an ambient room temperature of 10 to 38 °C. It is important that the room temperature should be kept within this range.

Ventilation

The appliance can be placed directly against a wall. To ensure sufficient ventilation, the ventilation gaps must not be covered over. The air inlet and outlet must not be covered or blocked in any way. They should be dusted on a regular basis.

Installation

Installation

- Remove any cable clips from the back of the appliance.
- Check that all parts at the back of the appliance are unhindered. Carefully remove any hindrance.
- Carefully push the appliance into position.

Aligning the appliance

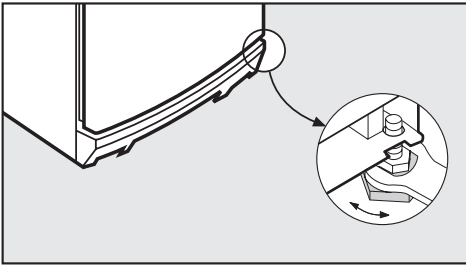

- To align the appliance adjust the feet using the spanner supplied.

Changing the door hinging

The appliance is supplied right hand hinged. If left hand door hinging is required, follow the instructions below.

 We recommend that the changing of the door hinging is carried out by a qualified kitchen fitter.

It is essential that the procedure is carried out by two people. The glass door is very heavy and could break.

Changing over the door:

In the following illustration the door is not shown in the closed position to make it easier to see what happens next.

- Close the appliance door.
- If necessary unlock the door.

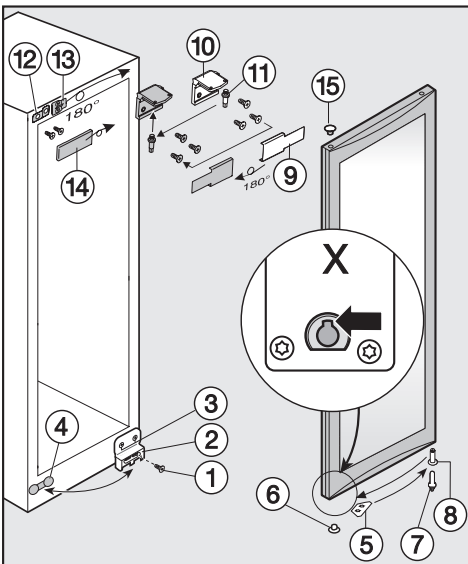

- Unscrew screw ① out of lower hinge bracket ②.

Caution.

The door is very heavy.

- Raise the door, open it outwards and remove it carefully.
- Remove cover ④. Unscrew lower hinge bracket ③ and refit lower hinge bracket ② on the opposite side. Refit cover ④ on the opposite side.

On the underside of the appliance door:

- Remove door opening limiter ⑤ and refit it on the opposite side.
- Remove cover cap ⑥ and pull hinge pin ⑦ and bearing bush ⑧ out from underneath the other side of the door.
- First refit bearing bush ⑧ and then hinge pin ⑦ on the opposite side. Please note the shape of the notch in the bearing bush (insert x).
- Now turn hinge pin ⑦ 90° until it is securely positioned in bearing bush ⑧.
- Remove cover ⑨ from the top of the appliance and unscrew hinge bracket ⑩.
- Insert hinge pin ⑪ in the second hole of hinge bracket ⑩.
- Refit brackets ⑫ and ⑬ as well as cover ⑭ turned through 180° on the opposite side.
- Screw hinge bracket ⑩ into the opposite side.
- Turn cover ⑨ through 180°, and fit it on the other side.

Changing the door hinging

- Remove cover ⑮ from the top of the appliance door.
- Place the door on upper hinge pin ⑪.
- Swing the door slowly inwards so that lower hinge pin ⑦ fits into the guide on hinge bracket ②.

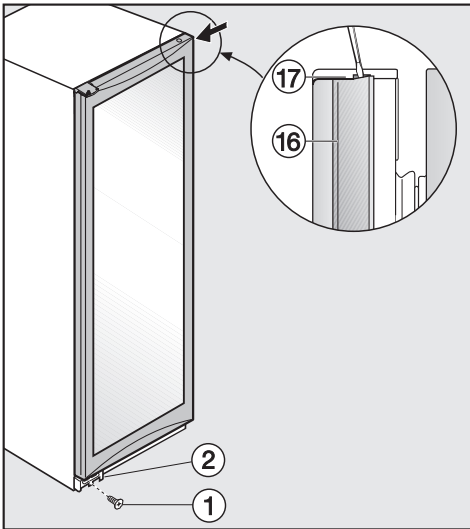

- Close the door and align it both vertically and horizontally.
- Insert screw ① into the outer hole of hinge bracket ② and tighten to secure the hinge pin in the hinge bracket.
- Carefully lever recessed handle fascia ⑮ away from the door by inserting a flathead screwdriver into groove ⑮ as shown.

Be careful not to let the screwdriver slip and cause damage to the appliance.

- Carefully remove handle fascia ⑮ towards the right hand side.

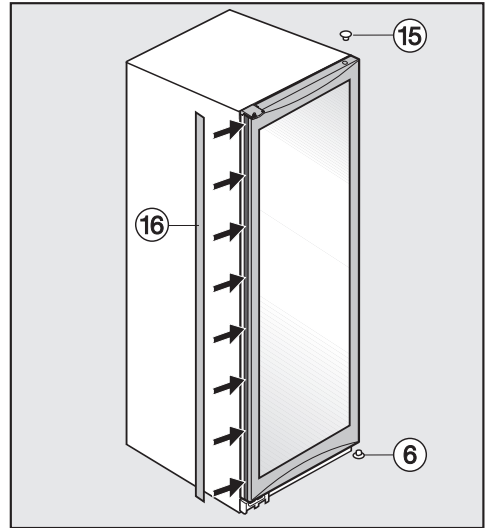

- Now insert handle fascia ⑮ into the handle strip on the opposite side of the door. Work it in methodically until it is sitting flush at the sides.
- Place cover caps ⑥ and ⑮ into the now open handle strip **from the inside** so that the plugs are not visible from the outside.

Changing the door hinging

Changing over the door lock:

- Open the appliance door.
- Remove the key from the door lock.

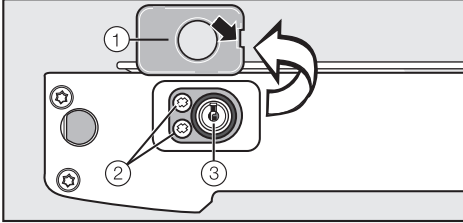

- Remove cover (1) by inserting a flathead screwdriver into the notch in the cover (see arrow).
- Remove both screws (2) from the lock mounting.
- Remove lock (3) together with the lock mounting. To do this you can insert the key in the lock and then use the key to pull out the lock.

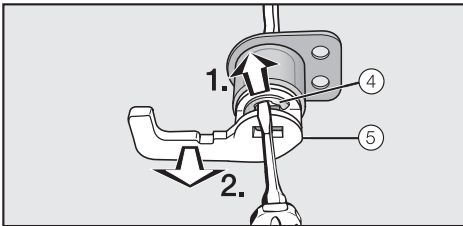

- Place the lock in front of you as shown and use a flathead screwdriver to lever safety disc (4) upwards and out.
- Remove lock lever (5) from the lock.

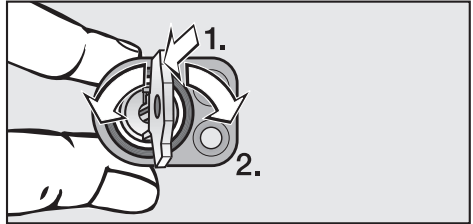

- Hold the lock mounting in your hand as shown.
- Press the lock down and turn it 90° as far as it will go.

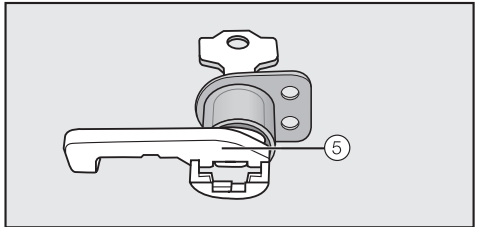

- Replace lock lever (5) turned through 180° (as shown).

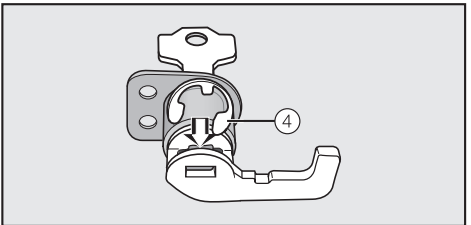

- Slide in safety disc (4) as shown, until it clicks into position.
- Remove the cover from the opposite side of the door and refit it in the position the lock was previously.
- Insert the lock into its new position on the other side of the door.
- Secure the door lock with the screw and refit cover (1).

Miele

United Kingdom

Miele Co. Ltd.
Fairacres, Marcham Road
Abingdon, Oxon, OX14 1TW
Tel: 0845 365 0555
Fax: 0845 365 0777
Customer Contact Centre Tel: 0845 365 6600
E-mail: info@miele.co.uk
Internet: www.miele.co.uk

Australia

Miele Australia Pty. Ltd.
ABN 96 005 635 398
1 Gilbert Park Drive, Knoxfield, VIC 3180
Tel: (03) 9764 7130, Fax: (03) 9764 7149
Internet: www.miele.com.au

China

Miele Shanghai
Suite 4105-06, Plaza 66
1266 Nanjing Road West
Jing An District
Shanghai 200040, PRC
Tel: +86 21 6288 4200, Fax: +86 21 6288 4100
E-mail: mieleshanghai@cn.miele.com
Internet: www.miele.cn

Hong Kong

Miele (Hong Kong) Limited
AIA Plaza, 24th Floor
18 Hysan Avenue
Causeway Bay
Tel: +852- 2610-1331, Fax: +852-2610-1013
E-mail: mielehk@miele.com.hk
Internet: www.miele.hk

India

Miele Appliances India Pvt. Ltd.
Ground Floor, Copia Corporate Suites
Plot No. 9, Jasola
New Delhi – 110025
Tel: 011-46 900 000, Fax: 011-46 900 001
E-mail: customercare@miele.in
Internet: www.miele.in

Ireland

Miele Ireland Ltd.
Broomhill Road, Tallaght, Dublin 24
Tel: (01) 461 0710, Fax: (01) 461 07 97
E-Mail: info@miele.ie
Internet: www.miele.ie

New Zealand

Miele New Zealand Limited
Unit L, 10-20 Sylvia Park Road
Mt. Wellington, 1060, Auckland, NZ
Tel: 0800 264 353, Fax: 0800 463 453
Internet: www.miele.co.nz

Singapore

Miele Southeast Asia
Miele Pte. Ltd.
163 Penang Road
04 - 02/03 Winsland House II
Singapore 238463
Tel: +65 6735 1191, Fax: +65 6735 1161
E-Mail: infosea@miele.com.sg
Internet: www.miele.sg

South Africa

Miele (Pty) Ltd
63 Peter Place, Bryanston 2194
P.O. Box 69434, Bryanston 2021
Tel: +27 (0) 11 548-1900
Fax: +27 (0) 11 548-1935
E-mail: info@miele.co.za
Internet: www.miele.co.za

United Arab Emirates

Miele Appliances Ltd.
P.O. Box 11 47 82
Gold & Diamond Park
Sheikh Zayed Road
Building 6 / Offices Nos. 6-214 to 6-220
Dubai
Tel: +971-4-341 84 44
Fax: +971-4-341 88 52
E-Mail: info@miele.ae
Internet: www.miele.ae