

Memorex[®]

**MP3 PERSONAL COMPACT DISC
PLAYER WITH 105 SECOND DIGITAL
ANTI SKIP PROTECTION**

MODEL: MPD8505CP

**BEFORE OPERATING THIS PRODUCT, PLEASE
READ THESE INSTRUCTIONS COMPLETELY.**

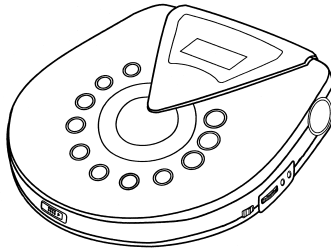

OPERATING INSTRUCTIONS

SAFETY PRECAUTIONS



DANGEROUS VOLTAGE

The lightning flash with arrowhead symbol, within an equilateral triangle is intended to alert the user to the presence of uninsulated dangerous voltage within the product's enclosure that may be of sufficient magnitude to constitute a risk of electric shock to persons.



ATTENTION

The exclamation point within an equilateral triangle is intended to alert the user to the presence of important operating and maintenance (servicing) instructions in the literature accompanying the appliance.



DANGER:

This product utilizes a Class 1 laser to read Compact Discs. This laser Compact Disk Player is equipped with safety switches to avoid exposure when the CD door is open and the safety interlocks are defeated. Invisible and hazardous laser radiation when open and interlock failed or defeated. Avoid direct exposure to beam. Please do not attempt to defeat or bypass the safety switches.



CAUTION

**RISK OF ELECTRIC SHOCK
DO NOT OPEN**



CAUTION: TO REDUCE THE RISK OF ELECTRIC SHOCK, DO NOT REMOVE COVER (OR BACK). NO USER-SERVICEABLE PARTS INSIDE. REFER SERVICING TO QUALIFIED SERVICE PERSONNEL.

SURGE PROTECTORS:

It is recommended to use a surge protector for AC connection. Lightning and power surges ARE NOT covered under warranty for this product.

SAFETY PRECAUTIONS

- Do not open the CD compartment while the CD is rotating.
- Always keep the CD compartment closed when not in use.
- Keep all foreign objects out of the CD compartment.
- Place the unit on a stable surface.
- Avoid installing the unit in locations described below:
 - Places exposed to direct sunlight or close to heat radiating appliances such as electric heaters.
 - On top of other stereo equipment that radiates too much heat.
 - Placed lacking ventilation or dusty places.
 - Places subject to constant vibration.
 - Humid or moist places.

INFORMATION

This equipment has been tested and found to comply with the limits for a Class B digital device, pursuant to Part 15 of the FCC Rules. These limits are designed to provide reasonable protection against harmful interference in a residential installation. This equipment generates, uses, and can radiate radio frequency energy and, if not installed and used in accordance with instructions, may cause harmful interference to radio communications. However, there is no guarantee that interference will not occur in a particular installation. If this equipment does cause harmful interference to radio or television reception, which can be determined by turning the equipment off and on, the user is encouraged to try to correct the interference by one or more of the following measures:

- Reorient or relocate the receiving antenna.
- Increase the separation between the equipment and receiver.
- Connect the equipment into an outlet on a circuit different from that to which the receiver is connected.
- Consult the dealer or an experienced radio/TV technician for help.

LOCATION OF CONTROLS

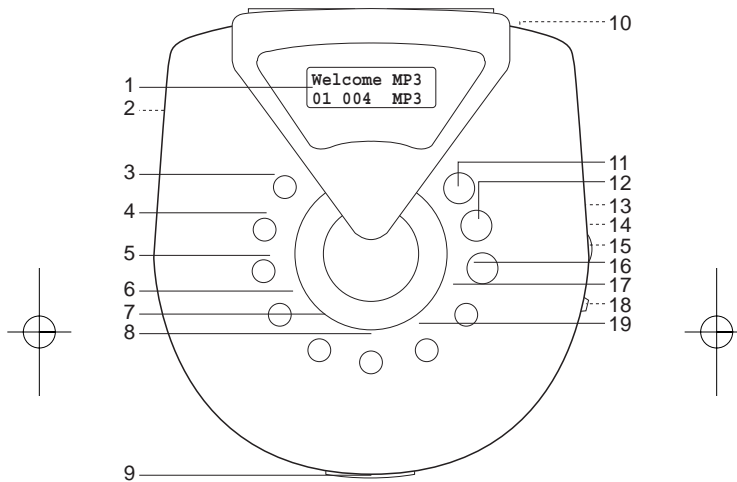

Many of the buttons have dual functions, meaning they will perform one function in the Normal mode and a different function in the Search mode. The descriptions on the following page will indicate the function while in the Normal mode, followed by the function in the File Search mode (if applicable).

LOCATION OF CONTROLS (CONTINUED)

No.	Name	Normal Mode	File Search
1	Display	LCD Function Display	
2	Battery Compartment	Insert Batteries, see page 5	
3	FILE SEARCH	Search for MP3 files	ENTER
4	DISPLAY	MP3 Display select	0, CLEAR
5	FILE/DIR.	Locate MP3 file	9, "Space"
6	RESUME	CD: Continues playback from last track played. MP3: Continues playback from last position played.	8,W,X,Y,Z
7	ANTI-SKIP	Anti Skip Protection ensures continuous playback.	7,T,U,V
8	PROGRAM	Memorizes & reviews programs.	6,P,Q,R,S
9	OPEN Switch	Slide to the right to open the CD compartment.	
10	DC4.5V Jack	Use with external Power Supply.	
11	PLAY/PAUSE	Turns the unit on. Also starts and pauses playback.	1,A,B,C
12	STOP	Stops CD play, clears a program. Also turns the unit off.	2,D,E,F
13	LINE OUT Jack	Connect to an external amplifier, such as a car stereo.	
14	PHONES Jack	Connect 3.5mm headphones.	
15	VOLUME	Adjusts the volume.	
16	SKIP/SEARCH+	Press & release:Skip forward. Press & Hold: Search forward.	3,G,H,I
17	SKIP/SEARCH-	Press & release:Skip backward. Press & Hold: Search backward.	4,J,K,L
18	DBBS	Turns BASS enhancement on/off.	
19	PLAY MODE	Cycles between RANDOM, INTRO,REPEAT A,REPEAT1.	5,M,N,O

INSTALLATION

This CD player can be powered by either 2 "AA" batteries, a car or the provided AC adapter.

AC Operation

To operate the unit using AC power, connect the AC adapter (included) to the DC4.5V jack on the rear of the CD Player and to a wall outlet having 120V, 60Hz AC only. The batteries are automatically disconnected when the AC adapter is used.

CAUTION: Use only the AC adapter provided with this unit. Disconnect the adapter when not in use.

Battery Installation

Batteries need to be replaced when "LOW BATTERY" appears in the display. Fresh Alkaline batteries will last approximately 7 hours with ESP off, and 6 Hours with ESP on.

1. Open the battery compartment door on the bottom of the unit by sliding it out and then lifting it. **To prevent the possibility of losing the cover, it cannot be removed.**
2. Insert two (2) "AA" batteries (not included) according to the polarity diagram. Alkaline batteries are recommended for longer playing time.



BATTERY PRECAUTIONS

Follow these precautions when using batteries in this device:

1. Do not mix different types of batteries together (e.g. Alkaline and Carbon-zinc) or old batteries with fresh ones.
2. If the device is not to be used for a long period of time, remove the batteries to prevent damage or injury from possible battery leakage.
3. Do not try to recharge batteries not intended to be recharged; they can overheat and rupture. (Follow battery manufacturer's directions.)

INSTALLATION (CONTINUED)

Using the Cassette Adapter

Compact discs played in this unit can be heard through a cassette deck by using the CD Cassette Adapter (included). When listening to a CD in the car, use the CD Cassette Adapter and DC Car Cord to play a CD through the car stereo cassette deck.

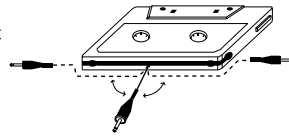

Operating Instructions:

1. Put the CD player on a horizontal, vibration-free and stable surface. Make sure it is in a safe place where it is not a danger or obstacle to the driver and passengers.
2. Connect the CD plug of the Voltage Converter to the 4.5V DC jack of the CD player and the other end into the car cigarette lighter. **Use only with a 12V, negative grounded car battery.**
3. Insert the cassette adapter plug into the LINE OUT jack of the CD player.
4. Turn on the cassette deck, set the deck's volume to a low level and insert the cassette adapter with the THIS SIDE UP label facing upwards.

If using an auto-reverse cassette deck, set the direction control as if playing the top side of the cassette adapter or the adapter will not work.

5. Play the CD and adjust the volume on the cassette deck. The CD player's VOLUME control does not affect the volume.

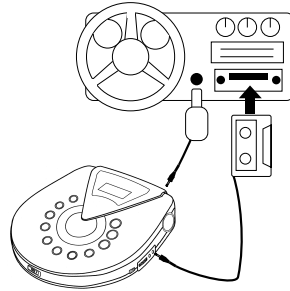

INSTALLATION (CONTINUED)

Playback Through a Home Audio System:

By using a home audio connection cable, superb CD sound can be heard through your home audio system. Before making any connections, turn off the power to all equipment. Plug a connection cable (not included) between the LINE OUT jack on the side of the CD player and the amplifier's CD or AUX input jacks. (Do not connect it to the amplifier's PHONO jacks.)

NOTE: If the CD player interferes with TV or radio reception, move the CD player away from the TV or radio or turn off the power to the CD player.

Headphones:

Connect the supplied headphones into the green PHONES (Headphones) jack.

Use your common Sense when using headphones:

- **Hearing Safety:** Do not play your unit at high volume. Hearing experts advise against continuous extended play. If you experience a ringing in your ears, reduce the volume or discontinue use.
- **Traffic Safety:** Do not use while operating a motor vehicle. It may create a traffic hazard and it is illegal in many areas. You should use extreme caution or temporarily discontinue use in potentially hazardous situations. Even if your headset is an open-air type designed to let you hear outside sounds, do not turn up the volume so high that you can't hear what's around you.

OPERATION

TO INSERT AND PLAY A CD

This CD player is designed to play all kinds of Audio Discs and MP3 CD ROMS, such as CD recordables and rewritables. Do not try to play CDI, CDV, DVD or computer CDs.

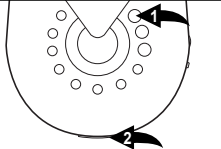
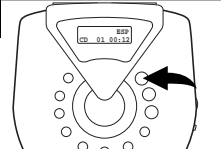
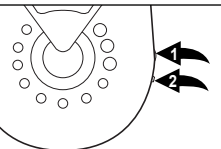
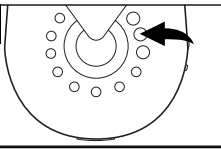
<div style="text-align: center;">  </div> <p>1</p> <p>Press the PLAY/PAUSE button ❶ to turn the unit on. Open the CD compartment lid by sliding the OPEN switch ❷. Gently press a disc, label side up, onto the spindle until it locks in place. Close the CD compartment lid; the total tracks and playing time (and folders, if using MP3) will appear in the display.</p>	<div style="text-align: center;">  </div> <p>2</p> <p>Press the PLAY/PAUSE button to begin playback; the current track and elapsed playing time (and folder, if using MP3) will appear in the display.</p>
<div style="text-align: center;">  </div> <p>3</p> <p>Adjust the VOLUME control ❶ and DBBS switch ❷ as desired.</p>	<div style="text-align: center;">  </div> <p>4</p> <p>When the disc is through playing, it will stop. Press the STOP button to stop the disc before it is finished. Press the STOP button again to turn the unit off.</p>

OPERATION (CONTINUED)

CD PLAYBACK NOTES:

- See page 15 for more information on MP3's.
- When recording ("burning") CDs, make sure the session is "finalized", or simply record ("burn" only one session). You can find more information on "finalizing" in your CD recorder's manual.
- This unit is capable of playing standard CDs or 3" singles; no adapter is required.
- If a disc is inserted incorrectly, dirty, damaged or not present at all, "no disc" will appear in the display.
- If a disc is not recorded properly, "disc error" will appear in the display.
- Playback will stop when you open the CD compartment, but it is not recommended to open the compartment before the STOP button is pressed.
- If there is no activity for 60 seconds, the unit will turn itself off to save the batteries.
- It may take 10 to 30 seconds for the player to read an MP3 CD and begin playback, depending on the number of tracks burned on the CD.

CD PAUSE CONTROL

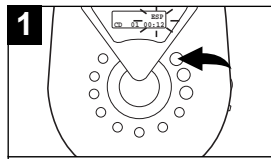
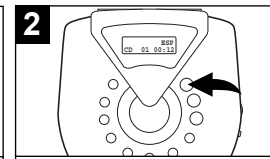
	
<p>1 During CD playback, if you wish to pause the disc momentarily, press the PLAY/PAUSE button. Playback stops but the disc continues to spin and the elapsed time flashes in the Display.</p>	<p>2 Press the PLAY/PAUSE button again to release Pause and resume playback. The sound returns and the elapsed time in the Display stops flashing.</p>

OPERATION (CONTINUED)

TO BEGIN PLAYBACK FROM A SPECIFIC TRACK

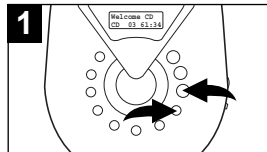

1 After you insert the disc into the CD player and the total number of tracks appear on the display, you may press either the SKIP/SEARCH + or – buttons to select a specific track for playback.



2 When the desired track number (and file number if using MP3) appears in the display, press the PLAY/PAUSE button. Playback will begin with the track (or file) you selected.

FORWARD/REVERSE SKIP TRACK

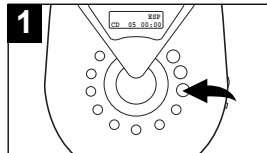

1 During playback, press and release the SKIP/SEARCH + button once to advance the player to the beginning of the next track. Press the SKIP/SEARCH + button repeatedly to advance the player to higher number tracks.

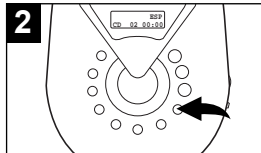

2 During playback, press and release the SKIP/SEARCH – button once to move the player back to the beginning of the currently playing track. Press the SKIP/SEARCH – button repeatedly to move the player back to lower numbered tracks.

OPERATION (CONTINUED)

HIGH-SPEED MUSIC SEARCH

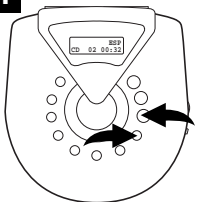
1		<p>During playback, depress and hold either the SKIP/SEARCH + or - button to move the player forward or backward within a track to locate a specific musical passage. The player will move forward or backward at high speed as long as the buttons are depressed. When you release the SKIP/SEARCH button, normal playback will resume at that point.</p>
----------	---	--

REPEAT PLAYBACK OF ONE TRACK

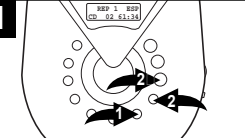
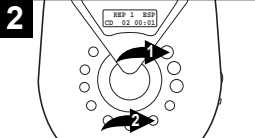
1		2	
<p>To repeat a single track, press the PLAY MODE button 1 once; "REP 1" will appear in the display. Press the SKIP/ SEARCH + or - button 2 to select the specific track that you wish to repeat.</p>		<p>When the desired track number appears in the display, press the PLAY/PAUSE button 1 to begin playback. The specific track you selected will be repeated continuously. To cancel Repeat playback, press the PLAY MODE button 2 repeatedly until the mode indicator disappears.</p>	

OPERATION (CONTINUED)
REPEAT PLAYBACK OF ALL TRACKS ON A CD

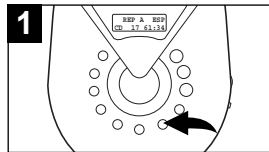

1 To repeat all the tracks on the CD, press the PLAY MODE button twice; "REP A" will appear in the display.

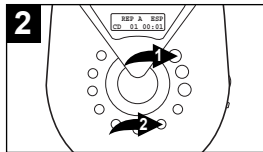

2 Press the PLAY/PAUSE button **1** to begin playback. All tracks on the disc will be repeated continuously. To stop Repeat playback, press the PLAY MODE button **2** repeatedly until the mode indicator disappears.

REPEAT PLAYBACK OF A FOLDER (MP3 ONLY)

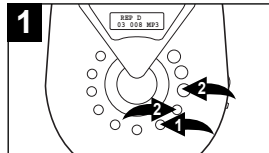

1 To repeat all files in a directory (MP3 CD only), press the PLAY MODE button **1** 3 times; "REP D" will appear in the display. Press the SKIP/ SEARCH + or - button **2** to select the specific folder that you wish to repeat.

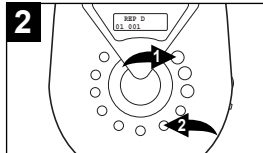

2 Press the PLAY/PAUSE button **1** to begin playback. All files in the selected directory will be repeated continuously. Press the PLAY MODE button **2** repeatedly until the mode indicator disappears to stop Repeat playback.. See page 15 for more info on MP3 format.

OPERATION (CONTINUED)

INTRO PLAYBACK (Will play the first 10 seconds of each track)

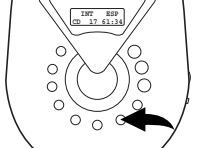
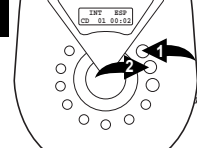
<p>1</p> 	<p>2</p> 
<p>While in the Stop mode, press the PLAY MODE button 3 times (4 times if an MP3 CD with multiple directories is inserted); "INT" will appear in the display.</p>	<p>Press the PLAY/PAUSE button 1 to begin Intro playback. The first 10 seconds of all tracks on the disc will be played in sequence. Press the STOP button 2 to stop Intro playback.</p>

TO RANDOMLY PLAY BACK A CD

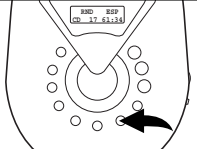
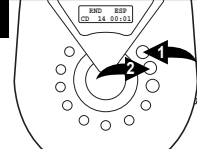
<p>1</p> 	<p>2</p> 
<p>While in the Stop mode, press the PLAY MODE button 4 times (5 times if an MP3 CD with multiple directories is inserted); "RND" will appear in the display.</p>	<p>Press the PLAY/PAUSE button 1 to begin playback. The unit will play all the tracks in random order. When all the tracks have been played, the unit will stop. Press the STOP button 2 to stop Random playback.</p>

OPERATION (CONTINUED)

TO PROGRAM THE MEMORY (UP TO 24 TRACKS)

Programming is the ability to preselect the order in which a series of tracks will be played.

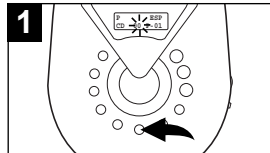

1 While in the Stop mode, press the PROGRAM button. The track number will blink and "P-01" will appear in the display. If using a MP3 disc, see the note on page 14.

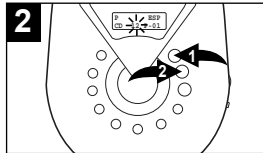

2 Within 10 seconds, select a track to be programmed by directly entering it. For example, press PLAY/PAUSE/1 and STOP/2 to enter in track number 12.

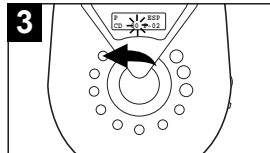

3 Press the FILE SEARCH/ENTER button to memorize the track. Repeat steps 2 and 3 to program additional tracks up to a maximum of 24 tracks.

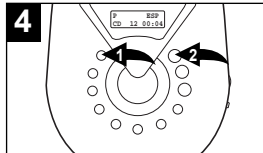

4 Press the FILE SEARCH/ENTER button again to finalize the program. Press the PLAY/PAUSE button to begin program playback.

See the top of the following page for notes on Program playback.

OPERATION (CONTINUED)

NOTES ON PROGRAM PLAYBACK

- **MP3:** If an MP3 CD is inserted, you will first select the directory number in step 1, and then the file.
- You can review the program by pressing the PROGRAM, then the SKIP/SEARCH button when playback is stopped.
- If you press the PROGRAM button, but do not enter a file number within 10 seconds, the player exits the Program mode and returns to the Normal mode.
- Press the REPEAT button twice during program playback to repeat the program repeatedly until the STOP button is pressed.
- Press the STOP button to stop and cancel the program before it is finished.
- Each file may be stored in the program memory as many times as desired (up to 24 files).
- If an error is made while programming or searching, hold the DISPLAY/CLEAR button for 2 seconds.
- If an error is made while programming, hold the DISPLAY/CLEAR button for 2 seconds to clear it.

ESP (ELECTRONIC SKIP PROTECTION)

This feature protects against loss of sound caused by vibrations and shocks. Continuous playback is ensured once some of the music has been stored into memory.

ESP will automatically be activated when listening to standard or MP3 CDs. You cannot deactivate ESP while listening to an MP3 CD. However, you can deactivate it when playing a standard CD by simply pressing the ESP button; the ESP indicator will disappear from the display. Deactivating the ESP will conserve battery life.

RESUME

This will allow you to resume playback of a CD that was previously stopped. If you stopped a CD in the middle of playing, simply press the RESUME button and the CD will continue at the start of the last played track location where the CD was stopped.

OPERATION (CONTINUED)

MP3 FAQs - Frequently Asked Questions

Please read before playing an MP3 CD.

Can the HD7088 read CD-RW (Rewriteable CDRs)?

Yes it can. However, you must reformat the CD-RW every time you want to record new group of MP3 files. No multi-session recording allowed.

Can the HD7088 read regular music CDs?

Yes it can. However you can not mix MP3s and WAV files on the same CD. If you do this your Portable MP3 CD Player will play only the MP3 files.

Does the HD7088 have Electronic Skip Protection built-in?

Yes it has a 45 seconds anti-shock buffer. What it means for everyday user is that it can withstand road bumps, shaking, etc. There will be no skipping when you jog, or run on a tread mill or drive on a bumpy road.

Can I use the MP3 extension for non-audio data files?

No, this may result in serious malfunction and harmful noise interference.

Can I mix MP3 files with other file types on the CDR?

Yes, but your Portable MP3 CD Player will ignore those files and read only the MP3 files on the CDR.

Does the HD7088 support multi-session CDRs?

No it will not. It supports only single session recorded CDRs. Single-session means you must burn all your MP3 files on the CDR at once, and they must have an MPEG rate of 32-128Kbps.

Does the HD7088 support subdirectories (subfolders)?

Yes, the HD7088 can read MP3 files from subfolders.

What appears on the display when playing back MP3 CDs??

The album, title and artist (if set when MP3 was recorded).

OPERATION (CONTINUED)

MP3 FAST FILE SELECT

If an MP3 CD **with or without Multiple Directories** is inserted, you can directly enter the desired file number as follows:

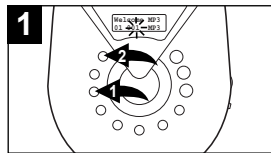
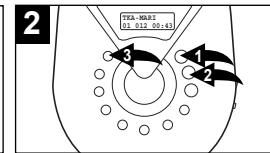
	
<p>While the unit is in the Stop mode, press the FILE/DIR. button 1 once; the file number will blink. Then, press the ENTER button 2.</p>	<p>Select a file by directly entering it. For example, press PLAY/PAUSE/1 1 and STOP/2 2 to enter in file number 12. Press the ENTER button 3 to begin playback from that file.</p>

MP3 FAST DIRECTORY SELECT

If an MP3 CD **with Multiple Directories** is inserted, you can directly enter the directory number as follows:

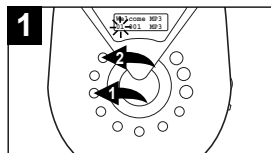
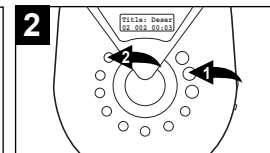
	
<p>While the unit is in the Stop mode, press the FILE/DIR. button 1 twice; the directory number will blink. Then, press the ENTER button 2.</p>	<p>Select a directory by directly entering it. For example, press STOP/2 1 to enter in directory number 2. Press the ENTER button 2 to begin playback of that directory.</p>

OPERATION (CONTINUED)**MP3 SELECTING SONGS BY TITLE**

You can search for a song by title, using the letter buttons to enter the name of the song.

First, press the FILE SEARCH/ENTER button, followed by the appropriate letters to enter the name of the song. Remember that each letter button can enter 4 or 5 letters/numbers depending on the number of times you press the button. If you press the 1ABC button once, the number "1" appears. Press twice for "A", 3 times for "B" and 4 times for "C". For example, if the first word in the song title is "Funny", you would enter the word "Funny" on the display as follows:

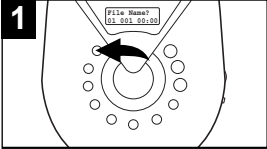
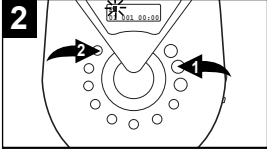
	
1 Press the FILE SEARCH/ENTER button once.	2 Press the 2DEF button 1 4 times to select the letter "F", then press the FILE SEARCH/ENTER button 2 to enter the "F" and move the cursor to the next position.

OPERATION (CONTINUED)

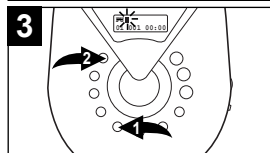

3 Press the 7TUV button **1** 3 times to select the letter "U", then press the FILE SEARCH/ENTER button **1** to enter the "U" and move the cursor to the next position.

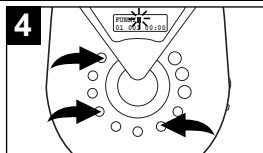

4 Continue to enter the word "Funny" as follows:
 "N"-Press 5MNO button 3 times, press FILE SEARCH/ ENTER.
 "N"-Press 5MNO button 3 times, press FILE SEARCH/ ENTER.
 "Y"-Press 8WXYZ button 4 times, press FILE SEARCH/ ENTER.

4 When done entering the title, press the FILE SEARCH button once again and the player will search for the title. Once found, playback will begin automatically.

To insert a space between 2 words in a song title, press the 9/SPACE button twice.

It may not be necessary to enter the entire song title to select the song. After entering the first few letters as describe above, press the FILE SEARCH/ENTER button again. The player will search the disc for a song that begins with those letters and playback begins automatically. If the player finds more than one song that begins with the same letters, the display will flash. If this occurs, you must continue entering letters until the player can identify the specific title you are looking for.

NOTES:

- The maximum number of letters that can be entered is 6.
- The maximum number of titles that can be located by name is 67.

OPERATION (CONTINUED)

SINGLE SESSION

The following chart is an example of a **Windows Explorer** display that will appear on your computer monitor for a single session MP3 CD ROM with Folders/Albums. Check the added notes to help you understand the MP3 CD unit display and the playback sequence of folders/albums and tracks on a single session MP3 CD.

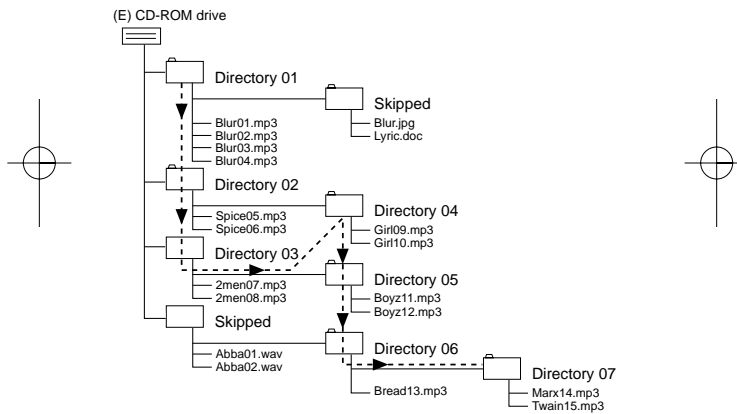

See the following page for notes regarding this diagram.

OPERATION (CONTINUED)

ABOUT THE DIAGRAM ON THE PREVIOUS PAGE:

- The arrow pathway shows the sequence of MP3 directory and file playback.
- This example has a total of 7 MP3 directories.
- Based on this layout, the first file will be "Blur01.mp3" and the last file will be "Twain15.mp3".
- When the MP3 CD is inserted into the CD player, the Display will appear as the following figure.
The "07" represent the total directory and "015" represents the total files.
- "Skipped" denotes a directory which contains non-audio files only, e.g. jpg, wav, etc. These cannot be detected nor played on this player. When an album contains mixed format files, the non-MP3 files will be skipped.

Welcome MP3
05 010 MP3

SPECIFICATIONS

MPEG Rate32-384Kbps
Sampling frequency44.1KHz
MPEG1Layer 3
MP3 PlaybackISO9660 format compatible
Check the CD burner/recorder's documentation to see if it complies with these specifications.

FOR ADDITIONAL SET-UP OR OPERATING ASSISTANCE, PLEASE VISIT OUR WEBSITE AT WWW.MEMCORPINC.COM OR CONTACT CUSTOMER SERVICE AT 1-800-919-3647

PLEASE KEEP ALL PACKAGING MATERIAL FOR AT LEAST 90 DAYS IN CASE YOU NEED TO RETURN THIS PRODUCT TO YOUR PLACE OF PURCHASE OR MEMOREX.

FOR PARTS AND ACCESSORIES, CONTACT FOX INT'L AT 1-800-321-6993.

TROUBLESHOOTING GUIDE

Should this unit exhibit a problem, check the following before seeking service.

SYMPTOM	POSSIBLE CAUSE	POSSIBLE SOLUTION
Unit will not turn on.	Batteries inserted incorrectly.	Insert batteries correctly.
	Batteries dead or weak.	Replace batteries.
	Power connection loose, or not connected.	Properly connect AC adapter securely.
	Power not on.	Press the PLAY/PAUSE button to turn the power on.
CD will not play.	CD compartment not closed.	Close CD compartment door.
	Disc inserted incorrectly.	Insert disc correctly.
	Dirty or defective CD.	Try another CD.
Erratic playback.	Condensation is on the lens.	Wait until the lens has cleared.
	Dirty or defective CD.	Try another CD.
	Error in the MP3 recording of the CD.	This is an error with the CD/burner, not the unit. Try another CD.
	Unit locks up.	Press and hold the DISPLAY/CLEAR button for 2 seconds to reset.
Playback does not start from track 1.	The Resume or Program function was activated.	Clear the program, and do not start with the resume function.
No sound, or poor sound.	Headphone or Line Out plugs not inserted properly.	Check connections.
	The volume is set too low.	Raise the volume.
	Plugs are dirty.	Clean plugs and reinsert.

LIMITED WARRANTY

We at Memorex believe you will be pleased with your new Audio product. Please read this Warranty carefully. Memorex warrants this product to be free from manufacturing defects including original parts and workmanship for a period of ninety (90) days from the date of original purchase in, and if used in, the United States.

Should you find your unit is not operating properly during the terms of full coverage of this warranty, ninety (90) days, you should contact your original place of purchase for an exchange with a valid receipt. If necessary, Memorex will provide one of the following options (at Memorex's discretion), providing the manufacturing defect is verified along with the date of purchase.

- 1 Repair service for ninety (90) days from date of original purchase at no charge for labor and parts at their authorized warranty service facility, providing the manufacturing defect is verified along with the date of purchase.
- 2 Replacement of defective unit with either a new, refurbished, or equivalent model at no charge for ninety (90) days from date of original purchase.

This warranty is void if the product is:

- A) Damaged through negligence, abuse, misuse, accident, or acts of God.
- B) Used in commercial applications or retails.
- C) Modified or repaired by anyone other than Memorex or their expressly authorized representative.
- D) Damage resulting from the improper connection to equipment of other manufacturers.

This warranty does not cover:

- A) Cost incurred in the shipping of the product to and from the Memorex-authorized repair facility listed.
- B) Damage or improper operation caused by the failure to follow the operating instructions provided with the product.
- C) Routine adjustments to the product, which can be performed by the customer as outlined in the owner's manual.
- D) Damage to a compact disc.
- E) Signal reception problems caused by external factors.

- F) Products not purchased in the United States.
- G) Damage to the products used outside to the United States.

In the event that service is required under this warranty, please contact CUSTOMER SERVICE at 1-800-919-3647 or contact our website at www.memorex.com.

THIS WARRANTY IS NON-TRANSFERABLE AND APPLIES SOLELY TO THE ORIGINAL PURCHASER AND DOES NOT EXTEND TO SUBSEQUENTLY OWNERS OF THE PRODUCT. ANY APPLICABLE IMPLIED WARRANTIES, INCLUDING THE WARRANTY OF MERCHANTABILITY, ARE LIMITED IN DURATION TO A PERIOD OF THE EXPRESSED WARRANTY AS PROVIDED HEREIN BEGINNING WITH THE DATE OF THE ORIGINAL PURCHASE AT RETAIL AND NO WARRANTIES, WHETHER EXPRESSED OR IMPLIED SHALL APPLY TO THE PRODUCT THEREAFTER. MEMOREX MAKES NO WARRANTY AS TO THE FITNESS OF THE PRODUCT FOR ANY PARTICULAR PURPOSE OR USE.

THE EXTENT OF MEMOREX'S LIABILITY UNDER THIS LIMITED WARRANTY IS THE REPAIR OR REPLACEMENT PROVIDED ABOVE AT THE SOLE DISCRETION OF MEMOREX. IN NO EVENT SHALL MEMOREX'S LIABILITY EXCEED THE PURCHASE PRICE PAID BY THE DIRECT, INDIRECT INCIDENTAL, FORESEEN, UNFORESEEN, SPECIAL, OR CONSEQUENTIAL DAMAGE ARISING OUT OF OR IN CONNECTION WITH THE USE OF THIS PRODUCT.

THIS WARRANTY IS VALID ONLY IN THE UNITED STATES. THIS WARRANTY GIVES YOU SPECIFIC LEGAL RIGHTS, HOWEVER, YOU MAY HAVE OTHER RIGHTS WHICH MAY VARY FROM STATE TO STATE. SOME STATES DO NOT ALLOW LIMITATIONS ON IMPLIED WARRANTIES OR EXCLUSION OF CONSEQUENTIAL DAMAGE, THEREFORE THESE RESTRICTIONS MAY NOT APPLY TO YOU.

© 2000. Memorex is a registered trademark of Memorex Telex N.V.



Memcorp, Inc.
Weston, FL 33331
Printed in Hong Kong

Visit our website at www.memorex.com