

Operating and assembly instructions

VF 230-610

Electric deep fryer



GAGGENAU

Preface

Important safeguards	Page 3
1. Important notes	Page 4-5
1.1 For your safety	Page 4
1.2 Operating for the first time	Page 4
1.3 About use	Page 5
2. Structure and operating principle	Page 6-7
2.1 Structure of the appliance	Page 6
2.2 Accessories	Page 6
2.3 Operating principle	Page 7
3. Operation	Page 8-11
3.1 Switching on/off	Page 8
3.2 Fat melting stage	Page 9
3.3 And this is how to deep fry	Page 10
3.4 Operating the child lock	Page 11
4. Cleaning and care	Page 12
5. Draining the deep frying oil	Page 13
6. Maintenance	Page 14
7. Practical tips	Page 15-17
7.1 Cooking table	Page 15
7.2 Recipes	Page 16
7.3 Tips and tricks	Page 17

Preface

Deep frying with your new deep fryer will be even more fun than before.

Among other things, the appliance offers you the following **advantages**:

- a gentle fat melting stage
- thanks to exact (electronic) temperature control, the surfaces of deep fried titbits can be closed so fast that deep frying oil or fat cannot penetrate into the food you are cooking. This ensures that proteins, vitamins and minerals are retained.
- thanks to the novel installation method implemented, installation is child's play!

To ensure that you will be able to use this appliance in all its diversity, read through the operating and assembly instructions conscientiously **before operating it for the first time**. The instructions contain **important notes on use, installation and maintenance** of the appliance.

You will find notes on Page 3 that you ought to observe **before operating the appliance for the first time**.

The chapters entitled **“Structure and operating principle”** and **“Operation”** will tell you all the things your deep fryer is capable of doing and how the appliance is operated.

“Cleaning and care” makes sure that your appliance will stay beautiful for a long time.

And now we wish you lots of fun with your deep fryer.

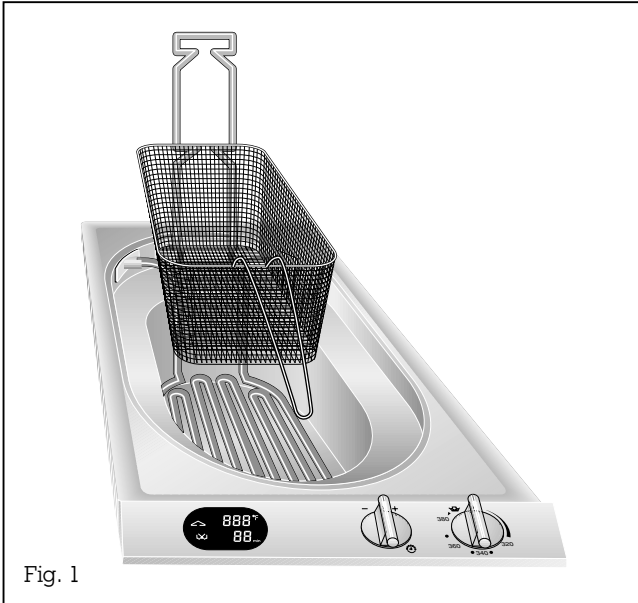

Fig. 1

Important safeguards

1. **Read All Instructions.**

2. To eliminate the risk of burns or fire by reaching over the heated surface units, cabinet storage space located above the surface units should be avoided. If cabinet storage is to be provided, the risk can be reduced by installing a range hood that projects horizontally a minimum of 5 inches (127 mm) beyond the bottom of cabinets.

3. **Important instructions**

- a) Ensure that this appliance is properly connected and grounded by a qualified electrician.
- b) Never use this appliance for warming or heating the room.
- c) Do Not Leave Children Alone – Children should not be left alone or unattended in area where appliances are in use. They should never be allowed to sit or stand on any part of the appliance.
- d) Wear Proper Apparel – Loose fitting or hanging garments should never be worn while using the appliance.
- e) User Servicing – Do not repair or replace any part of the appliance unless specifically recommended in the manual. All other servicing should be referred to a qualified technician.
- f) Storage in or on Appliance – Flammable materials should not be stored in an oven or near surface units.
- g) Do Not Use Water on Grease Fires – Smother fire or flame or use dry chemical or foam-type extinguisher.
- h) Use Only Dry Potholders – Moist or damp potholders on hot surface may result in burns from steam. Do not let potholders touch hot heating elements. Do not use a towel or other bulky cloth.

- i) Never Leave Surface Units Unattended at High Heat Settings – Boilover causes smoking and greasy spillovers that may ignite.

- k) Use extreme caution when moving the grease kettle or disposing of hot grease.

4. **DO NOT TOUCH HEATING ELEMENTS OR AREAS NEAR UNITS.** Heating elements may be hot even though they are dark in color. Areas near heating elements may become hot enough to cause burns. During and after use, do not touch or let clothing or other flammable materials contact heating elements or areas near units until they have had sufficient time to cool.

5. **CAUTION:**

Do not store items of interest to children in cabinets above a range. Children climbing on the appliance to reach items could be seriously injured.

6. **Note** – To avoid jeopardising the electrical safety of the appliance, it is forbidden to use high-pressure or steam jet cleaning devices.

7. **Save These Instructions.**

1. Important notes

1.1 For your safety

You must not operate the **appliance if it is damaged**.

The appliance must only be connected by an **authorised specialist**, paying attention to the relevant regulations of the power supply companies and the regional construction regulations. **Observe the assembly instructions!**

When connecting electrical appliances in the proximity of the deep fryer, make sure that connecting cables do not come into contact with hot cooking surfaces.

As the user, you yourself are responsible for maintenance and proper use in the household.

Only ever operate the appliance under supervision.

Please make sure never to heat up the deep fryer while it is empty. Top up the oil or fat when the level drops below the minimum mark. **Risk of burns!**

Caution! The appliance gets hot during operation. Keep it out of the reach of children!

Note: to avoid jeopardising the electrical safety of the appliance, **it is forbidden** to use high-pressure or steam jet cleaning devices.

Isolate the appliance from the mains during every maintenance operation. To do this, remove the mains plug or actuate the corresponding fuse.

Repairs may only be carried out by **authorised electricians**, in order to guarantee the safety of the appliance.

No **warranty claims** can be lodged for any damage resulting from failure to observe these instructions.

Caution! Fats and oils can ignite easily if they get overheated. Keep naked lights away from the appliance! Fire risk!

Observe particular **caution** when working with water in the proximity of the warm appliance.

Explosion risk!

Foodstuffs that are prepared in fat and oil (e.g. French fries) must only be prepared under constant supervision!

Caution! Over-greased filters are a fire risk if the appliance is positioned under an extractor hood or adjacent to a hob ventilator!

The appliance cover must only be placed over the deep fryer after it has cooled down. Risk of burns!

Technical modifications reserved.

1.2 Operating for the first time

Before operating the appliance for the first time, please pay attention to the following notes:

- **Read through** these instructions attentively before operating your appliance for the first time.
- **The appliance** must be installed and connected by a specialist.
- **The rating plate** for this appliance is included with the instructions on a separate sheet. Store the rating plate in the same location as your operating and assembly instructions.
- **Remove the packaging** from the appliance and dispose of it properly. The packaging consists of foil and cardboard.
- **Pay attention** to the fact that there are accessories in the base of the packaging. Keep packaging elements away from children.
- **Thoroughly clean** the appliance and accessories before using them for the first time. This will eliminate any 'newness' smells and soiling (see chapter entitled Cleaning and care).
- **Before operating the appliance** for the first time, make sure that the mains connection is in proper working order.

1.3 About use

The appliance is intended solely for use in the household and must not be put to any other uses.

Use the appliance to prepare meals only. It must not be used to heat up the room in which it is installed.



Keep ventilation openings open (doors, extractor hoods and windows).

Do not store any combustible items inside the appliance. **During operation**, only ever leave the items you need inside the appliance.

Only ever use deep frying inserts (deep frying baskets) that are intended for the purpose.

The  (heating) **symbol** in the control panel goes off as soon as the set temperature has been reached.

Return the “Temperature” knob to “0” after deep frying.

The appliance must not be operated empty (i.e. without oil or fat; do not use water!). If the appliance is operated empty, it will switch off automatically and the  (limiter) symbol will appear in the display. If this is the case, turn the “Temperature” knob to the 0 position. Wait until the  (limiter) symbol goes off again.

Note: If the  (limiter) symbol appears in the display, there may be many reasons for this (see Structure and operating principle).

Top up oil or fat as soon as it is below the minimum level (bottom marking). **Caution:** there is a risk of fires if the filling should drop below the bottom marking!

Observe caution with oils and fats. They may overheat and **burn** easily. Old/soiled fat must be replaced if it becomes brown, has an unpleasant smell and/or smokes prematurely. **Fire risk!**

If a fire should break out, remove the mains plug and place the lid on the deep fryer. **Never extinguish with water!** **Switch off the extractor hood immediately because the draught will otherwise intensify the fire!**

The deep frying oil/fat will foam over if foodstuffs that are too wet or if excessive quantities are inserted. **Risk of burns!**

In the event of malfunctions, first of all check the household fuses. If the problem has nothing to do with the power supply, please contact your specialist dealer or your local Gaggenau after-sales service.

Built-in temperature protection prevents overheating of the appliance and of build-in furniture.

Clean the appliance at regular intervals and also replace the deep frying oil or fat at regular intervals because soiling causes the deep frying oil or fat to become more easily ignitable.

Do not use the lid during deep frying. The lid must only be placed over the deep fryer after it has cooled down fully.

Caution: never use the glass cover of the steam cooker for the deep fryer.

2. Structure and operating principle

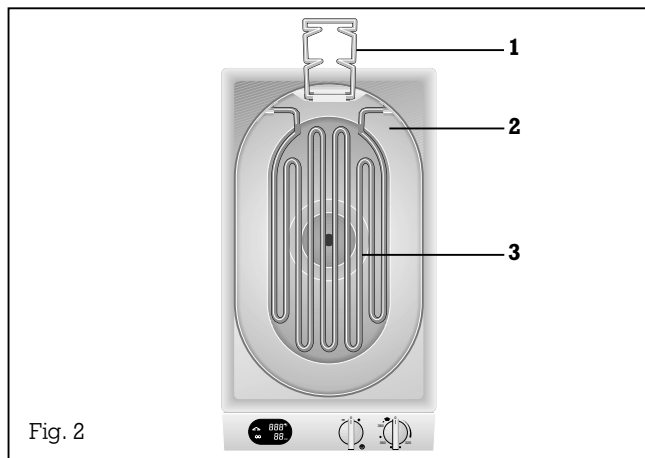

2.1 Structure of the appliance

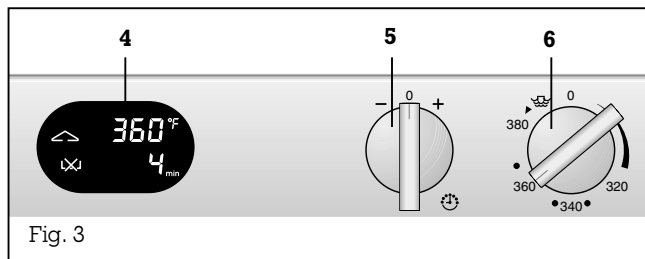

- 1 Deep frying basket suspension
- 2 Foaming edge
- 3 Heating element (2300 W)



Panel:

- 4 Display offering the following possibilities:
 -  (heating) symbol
 - Display of the set temperature
 - Display of the set short time
 -  (limiter) symbol
- 5 “Short time” knob, featuring the + and - options (adjustment range from 1 to 90 minutes)
- 6 “Temperature” knob (adjustment range 270-380°F) with fat melting stage

2.2 Accessories

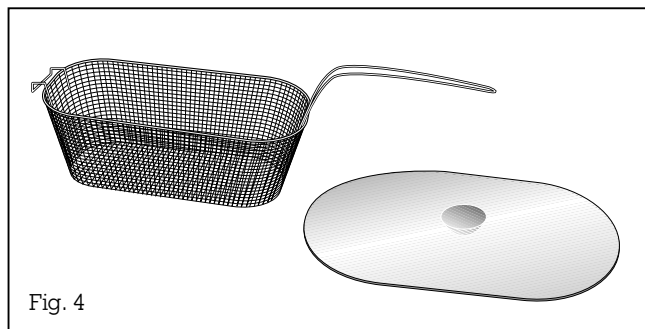

As standard, your deep fryer comes with the following accessories (Fig. 4):

- deep frying basket (FK 023-000)
- stainless steel cover

You can order the following special accessories:

- VV 200-000** connecting strip for combination with other Vario appliances
- VD 201-010** appliance cover

2.3 Operating principle

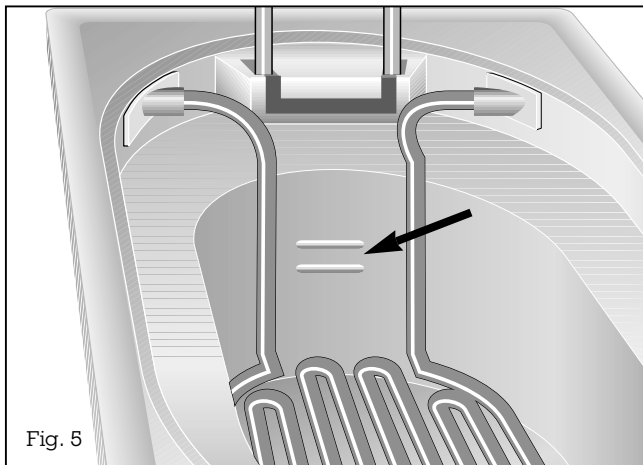

Fig. 5

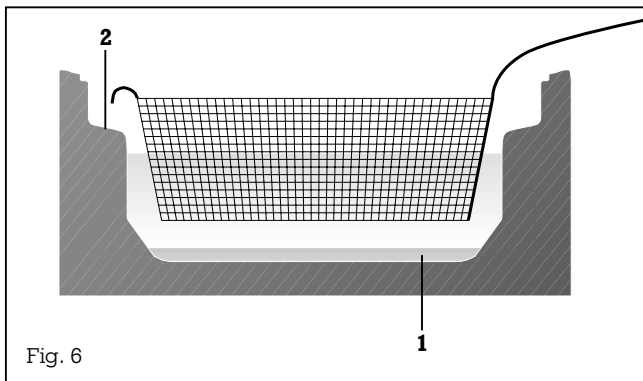

Fig. 6

During deep frying, the heat that is generated by the appliance is transmitted by the fat to the food you are cooking. When this fast cooking method is employed, a tasty crust is formed around the cooked food. The deep frying temperature range lies between 320 and 360 °F. The maximum temperature is 380 °F. A higher temperature would result in a consistency change in the deep frying fat or oil.

The **two marks** on the rear of the deep fryer indicate the **maximum and minimum levels** for the deep-frying oil or fat. The oil/fat level should always be between the two marking lines (Fig. 5). The food to be fried should always be completely covered by the deep-frying oil or fat; if this is impossible, turn the food after half the frying time.

Any water contained in the food sinks to the bottom of the Gaggenau Electric Fryer into so-called **cold oil zone** (see **1** in Fig. 6). This prevents the oil frothing over. Also, any particles of food which break away during frying fall through the basket and sink to this cold zone.

The lower temperature in this zone prevents the oil breaking down and considerably **prolongs** the time for which the oil or fat can be used.

The **foaming edge** (see **2** in Fig. 6) serves to limit the foam that occurs during deep frying.

Numerous safeguards serve to protect you. Turn the "Temperature" knob back to 0 if the  (limiter) symbol should appear on the display.

Possible causes:

- No fat/oil in the deep frying tub or not enough.
- The deep fryer has been switched on with the tubular heating element tilted out.
- The  (limiter) symbol goes off as soon as the temperature on the heating element drops below a critical value. Pour fat/oil into the deep frying tub. The appliance can then be easily operated again.

Please inform your local Gaggenau after-sales service if the  (limiter) symbol does not go off after a few minutes.

3. Operation

3.1 Switching on /off

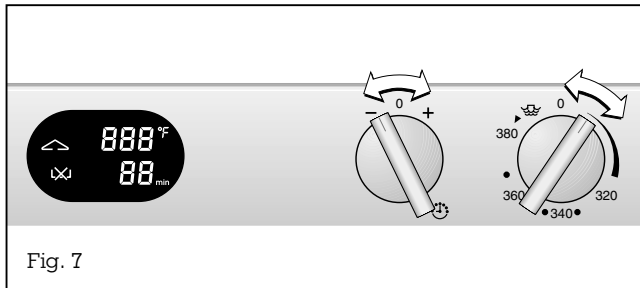

Fig. 7

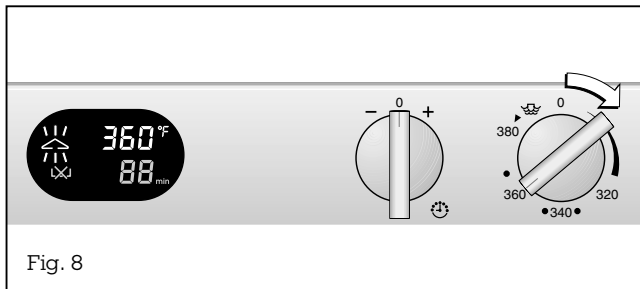

Fig. 8

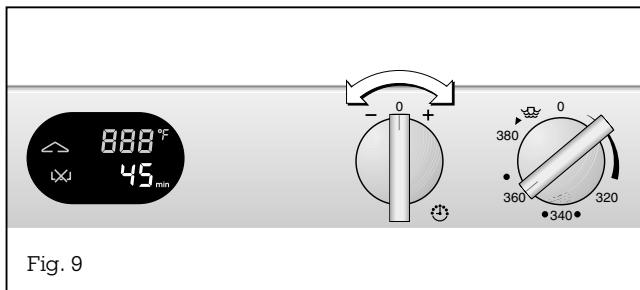

Fig. 9

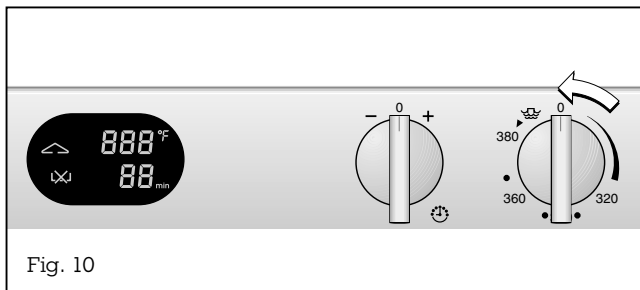

Fig. 10

“Temperature” knob

The temperature can be set within the range from 270-380°F. The fat melting stage can also be set.

“Short time” knob

The short time can be set within a range from 1 minute to 90 minutes (Fig. 7). The appliance is not switched off by the short-time reminder.

Switching on:

Turn the “Temperature” knob to the temperature you require. The chosen temperature is shown on the display. While the appliance is heating up, the  (heating) symbol will appear on the display (Fig. 8)

Turn the “Short time” knob to the left or the right to set the short time you require (Fig. 9). The range that can be set is between 1 minute (01) and 90 minutes (90). The set time elapses on the display. If you turn the knob fully to the left, 90 appears in the display. After a few seconds, the chosen value is confirmed by an audible signal.

Note: the short time reminder does not switch the appliance. You can use the short time reminder even when the appliance is switched off.



Switching off:

Turn the “Temperature” knob to the 0 position (Fig. 10). The indication in the display goes off.

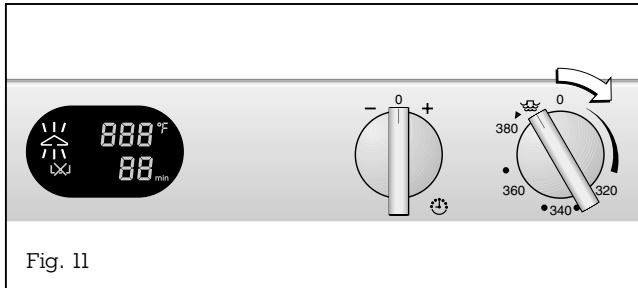

(Exception:  (limiter) symbol)

3.2 Fat melting stage



- Place approximately 3 kg of crushed fat in the deep fryer.
- Turn the “Temperature” control knob to the fat melting stage position  on the right. In this position, the fat is melted slowly and overheating of the heating element, and thus damaging of the appliance, are prevented. The  (heating) symbol flashes on the display and 210°F is displayed.

or

- Turn the “Temperature” control knob to the right to the fat melting stage position . As soon as an audible signal sounds, turn the control knob **to the left** to the temperature you require. During the melting process, the  (heating) symbol flashes on the display. The appliance then heats up automatically to the selected temperature.

Important:

Owing to the low temperature in the cold oil zone, fat that has not melted may remain in this zone. You can start deep frying as soon as the  (heating) symbol has gone off.

3.3 And this is how to deep fry

(see also 7.1)

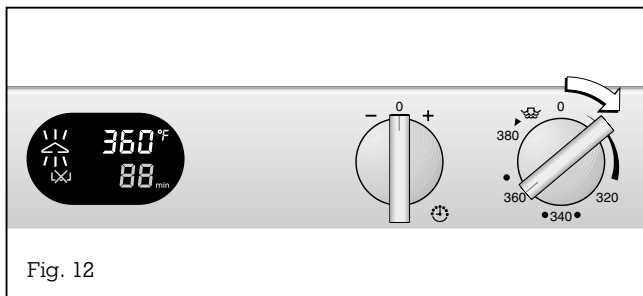

Fig. 12

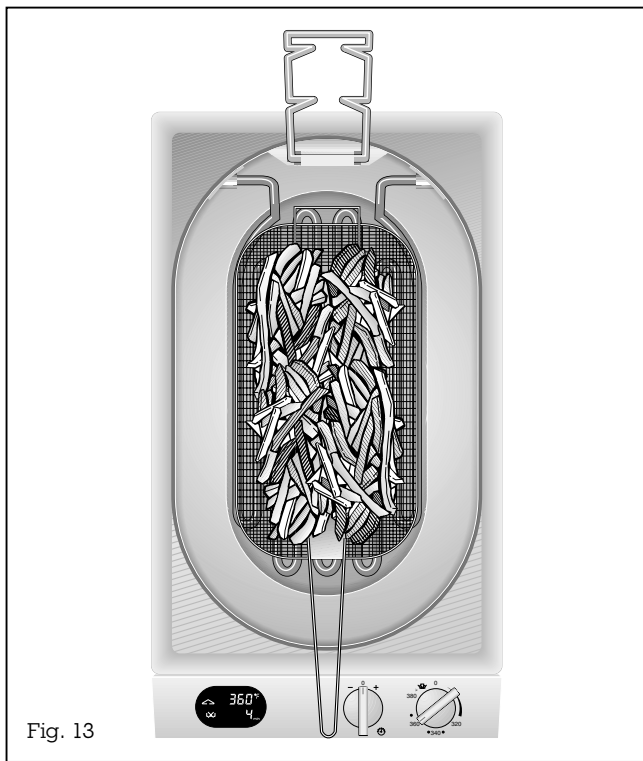



Fig. 13

- Set the required temperature with the temperature control knob. The required temperature has been reached as soon as the  (heating) symbol goes off.

Important:

Only ever switch on the appliance after having placed deep frying fat or oil in the deep frying tub. Deep frying fat must be melted (see page 9)!

- Briefly dip the deep frying basket into the hot fat or oil. The optimum quantity is 3-3.5 l of oil (or 3 kg of fat).

Moist foods such as fish, shellfish, pieces of meat, vegetables or fruit slices must be thoroughly dried.

- Place the food in the deep frying basket and fry it. The basket has a capacity of 500 g.
- When the food is ready (see Table 7.1), take out the deep frying basket and shake it lightly. This will make sure that the fat or oil can drip off faster.

Note:

The deep frying times stated are only approximate values; more or less times and energy may be required, depending on the condition of the food and your own personal taste.

Important!

Do not salt or spice the food above the deep fryer, since this would flavour the oil or fat and, consequently, the next food fried.

Please observe our tips and tricks!

3.4 Operating the child lock

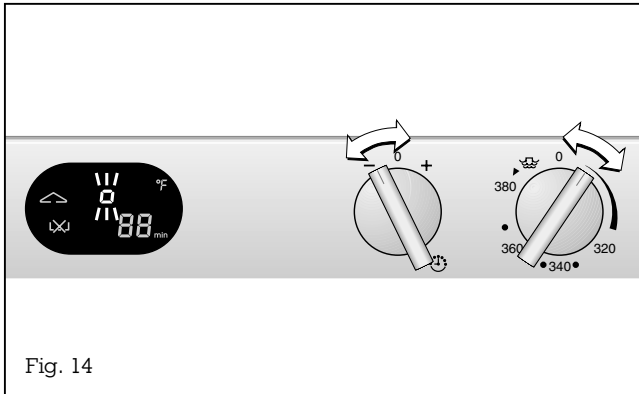

Activating the child lock

- Turn the “Short time” control knob to the left to the minus position. Hold the knob in this position.
- Turn the “Temperature” control knob to any temperature on the right.
- Turn the “Temperature” control knob back to the 0 position.
- Turn the “Short time” knob back to the 0 position. The symbol  (child lock) flashes on the display (Fig. 14). You can now turn the “Temperature” control knob to any position without the appliance heating up.

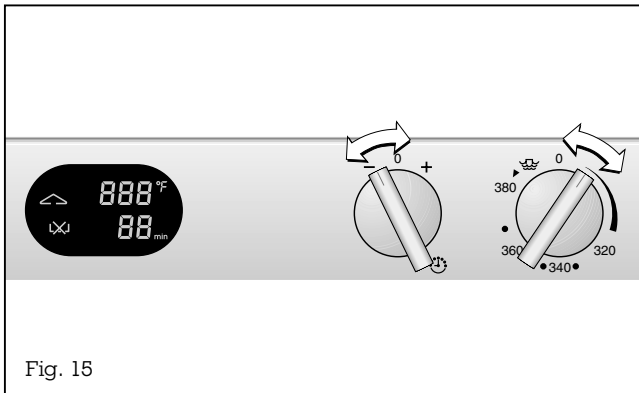

Deactivating the child lock

- Turn the “Short time” control knob to the left to the minus position and hold the knob in this position.
- Turn the “Temperature” control knob to any temperature on the right.
- Turn the “Short time” control knob to the 0 position.
- Turn the “Temperature” control knob to the 0 position. The “child lock” symbol on the display goes off (Fig. 15).

The appliance is now operable again.

4. Cleaning and care

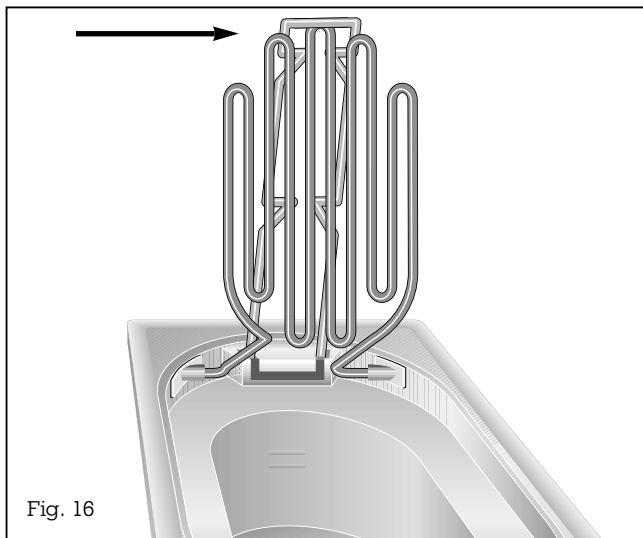

Fig. 16

Caution! Risk of burns!

Wait until the appliance has cooled down completely before cleaning it. Never switch on the fryer as long as the heating element is tilted up.

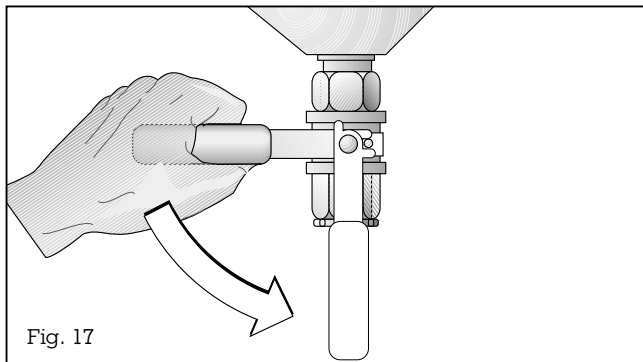

Fig. 17

Note:

To avoid jeopardising the electrical safety of the appliance, it is forbidden to use high-pressure or steam jet cleaning devices.

Please clean the appliance thoroughly before operating it for the first time.

Cleaning the deep frying tub:

- **Take out** the deep frying basket and tilt up the heating element. Clamp the heating element onto the deep frying basket suspension (Fig. 16).
- **Pour** approximately four litres of water with detergent into the empty tub.
- **Tilt the heating element** back into the frying tub and heat up the appliance to the fat melting stage.
- **The water** is drained off through the oil drain valve, which is located under the funnel-shaped base of the deep frying tub as follows: Unscrew the plastic cap from the drain valve and open the oil drain valve by turning the handle down (Fig. 17).
- **Use** a temperature-resistant bucket with a capacity of at least 10 litres to collect the water.
- **Rinse** the appliance with hot water and rub it dry. Close the oil drain valve again (turn the handle up) and screw on the plastic cap.

Note: The deep frying tub should not be treated with stainless steel cleaners or care agents because, in most cases, these are not neutral as far as foodstuffs are concerned.

Clean the cover and the deep frying basket suspension with hot rinsing detergent solution before operating the appliance for the first time and after every use. Clean the deep frying basket in a dishwasher.

Clean operator controls with a moist cloth and gentle rinsing detergent only and wipe them dry with a soft dry cloth. Do not use any abrasive sponges or abrasive or caustic cleaning agents. Do not use any commercially available stainless steel cleaners as these may be aggressive to the printed markings.

Caution! Risk of burns!

Water must not be allowed to drip into the hot fat!

5. Draining the deep frying oil

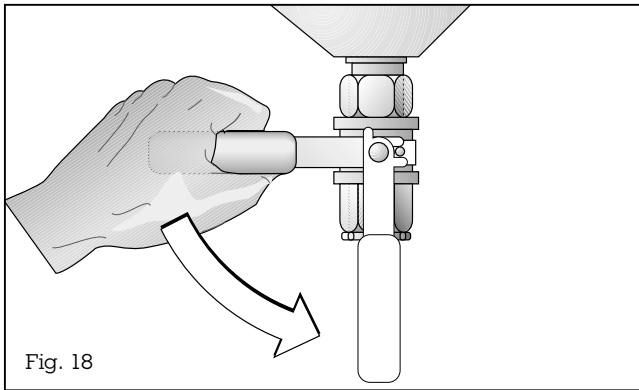

Fig. 18

Draining the deep frying oil and fat

Drain used oil only after it has cooled down.

Melt used fat at the melting stage. In the cold oil zone, the fat melts only slowly.

Use a temperature-resistant bucket with a capacity of at least 10 litres to collect the oil/fat.

Water that collects in the cold oil zone can also be drained by way of the oil drain plug.

The deep frying oil or fat is drained off through the oil drain valve, which is located under the funnel-shaped base of the deep frying tub: First unscrew the plastic cap from the drain valve and open the drain valve by pulling the handle down (Fig. 18).

Dispose of used oil and fat in accordance with local regulations.

6. Maintenance

The appliance must be disconnected from the power supply during all repair work.



If the appliance does not function correctly, check the fuses first.

If the power supply is functioning correctly, but your appliance still does not work, please contact your **Gaggenau dealer** who will provide you with the address and telephone number of your nearest manufacturer's authorized service agent or contact **Gaggenau USA on (800) 828-9165**. Specify the appliance type (see rating plate).

Repairs may only be carried out by **authorised technicians**, in order to guarantee the safety of the appliance.

Unauthorised tampering with the appliance will invalidate any warranty claims.

Only ever use original spare parts.

What to do if ...	The solution!
... deep fried food is still raw on the inside.	Reduce the temperature and extend the deep frying time.
... the deep fried food no longer becomes the usual crispy brown.	Use fresh oil or fat.
... the  (Limiter) symbol appears on the display.	Switch off the appliance and allow it to cool down. Contact Gaggenau after-sales service if the  (Limiter) symbol does not go off after some time.

7. Practical tips

7.1 Cooking table

Item	Temperature (°F)	Quantity	Deep frying time (min.)	Remarks
Snacks and hors d'oeuvres				
Camembert, breaded	320	4	3	
Spring rolls	320-340	4 - 6	4 - 6	Depending on size
Pears filled with Roquefort cheese	310	2	8	Turn frequently
Flaky pasties (e.g. filled with mushrooms, mince or feta cheese)	360-370	4 - 6	5 - 7	Depending on size
Vegetables				
Various vegetable pasties / vols au vent (e.g. aubergine and zucchini slices, oyster mushroom, Brussels sprouts*, sellery slices*, cauliflower florets*, mushroom heads) *pre-cooked firm	350-360	—	3 - 6	Depending on cooked state and size, deep fry without basket
Onion rings	340	200 g	1 - 2	
Vegetable strips (e.g. carrots, potatoes, leek)	350	100 - 200 g	1 - 2	
Potato croquettes, homemade	350	10	3 - 4	
Meat				
Meatballs	340	10	6 - 10	
Scallop of veal, breaded Viennese style	360	2	1-2 each side	
Cordon bleu, pork	360	2	3-4 each side	
Chicken legs, breaded	330	4	25	Turn once
Pieces of ham in sparkling wine dough	360	150 g	3 - 4	
Fish and seafood				
Fritto Misto	320 / 360	—	2 - 3	Deep fry fish at 320°F and meat at 360°F without basket
Fish fillet, breaded	320	2	3 - 5	Depends on size and type of fish
King prawns in batter	360	10	4 - 5	
Sweets				
Apple-beignets	360	5 - 6	3 - 4	Deep fry without the basket
Berlin-style pancake	360	5 - 6	3 each side	
Doughnuts	340	5 - 6	2 each side	
Plum dumplings	350	4 - 6	5	
Fruits wrapped in pastry (e.g. pears, grapes, apricots, strawberries, pineapple slices, bananas, cherries, peach and kiwi halves)	360	—	2 - 3	Deep fry without the basket
'Schlosserbuben' (plum doughnuts)	320	10	6	
Shortbread	360	6	3 each side	
The values specified here are guide values, which may differ depending on the condition of the food and personal taste. Prepare deep frozen foodstuffs according to the information specified on the package.				

7.2 Recipes

Fishballs in a cabbage jacket

Ingredients

400 g fillet of cod	4 giant prawns
1 head of Chinese cabbage	1 lime
2 tablespoons soya sauce	2 eggs
2 spring onions	80 g starch
100 ml whipped cream	Salt, pepper

Preparation

Wash the fish fillet, dab it dry and cut it into small cubes. Press out the lime. Mix the lime juice and the soya sauce into the fish cubes and put this in the fridge.

Clean the spring onions. Chop the onions. Blanch the onion stem for 1 minute and then allow it to cool. Remove 6 good leaves from the head of cabbage, blanch them for 2-3 minutes and then allow them to cool.

Grind the thoroughly cooled fish fillet in a mixer. In doing so, add the cooled whipped cream bit by bit. Season it with salt and pepper and place it back in the fridge.

Break the prawns out of their shells and remove the intestines. Coarsely cube the prawns, mix them with the chopped spring onions into the fish stuffing and place everything back in the fridge.

Remove the ribs from the China cabbage leaves and halve the leaves lengthwise.

Shape 12 balls out of the fish stuffing and place them on the cabbage leaves. Shape small bundles and tie them up with strips of spring onions.

Preheat the deep fryer to 330°F.

Whip the eggs and turn the balls first in the eggs and then in starch.

Deep fry for 4 to 6 minutes at 330°F.

Game skewers

For 4 skewers

Ingredients

300 g hare fillet
300 g deer fillet
12 shallots
12 small mushroom heads
4 slices of pineapple (quartered)
1 fresh mango (in pieces)
Salt, pepper

Preparation

Preheat the deep fryer to 350°F.

Cut the prepared game into cubes of equal size. Alternating with the vegetables and fruit, skewer it on 4 skewers.

Deep fry for 3 to 4 minutes at 350°F. Then salt and pepper.

7.3 Tips and tricks

- **If you have large quantities of food** to deep fry, you are advised to remove the basket from the tub after 1-2 minutes to allow the oil or fat to assume the selected temperature faster. The deep fried food will also become crisper.
 - **After every use** of the deep fryer, remove any resulting remainders of food from the oil or fat.
 - **Replace** the deep frying oil or fat completely if the food you are deep frying no longer becomes crispy despite having set the correct temperature or if the oil or fat goes brown.
 - **Only ever use** fat for deep frying that is devoid of water and protein. Such fats have a high smoking point. This means that such a fat is a heat-resistant fat.
 - **The following foodstuffs are suitable for deep frying:** small pieces of meat and fish, vegetables, potatoes, pastries, fruit and breaded foodstuffs.
 - **Do not deep fry** very large quantities at once as the fat would cool down too much.
 - **After cooling down**, close the lid. This is necessary for safety reasons and prevents dirt from falling into the fat.
- Would you have known?**
- **With your** deep fryer you have a possibility of preparing tasty meals.
 - **Valuable ingredients** are retained and serve to protect your health.
 - During deep frying (from 340°F), **oil and fat** takes on neither an odour nor taste. So, you can deep fry fish and fruits straight after one another. Residues (bread crumb coating etc.) must be removed.
 - **Remove ice** from deep frozen foodstuffs. Fill the basket outside of the deep fryer.
 - **Allow deep frozen** fish to thaw slightly. This will shorten the deep frying time and the fish will take on a lovely golden yellow colouring.
 - **Peel zucchini and aubergines** before coating them with bread crumbs. The bread crumb coating will then adhere better.
 - **Cut into cutlets** several times on the bone before deep frying them. This facilitates uniform deep frying.
 - **Moist or frozen** food leads to particularly hefty foaming of the fat when it is inserted. Slowly lower the filled basket several times. This prevents overflowing of the fat.
 - **Dab freshly** deep fried food with a kitchen cloth.
 - **Set** the recommended temperature. The surface will crust too fast if **the frying fat is too hot**. Its interior will remain raw, though. The food will take on too much fat if **the fat is too cold**.
 - **If the fat** is at the right temperature, its pores will close swiftly when it is dipped in and proteins will form a protective crust. So, only a small amount of fat is able to penetrate into it. Also dry freshly deep fried food with a kitchen cloth. This reduces the amount of fat even more.
 - **As the result** of the short heating up time, valuable and vital nutrients such as vitamins and minerals are retained.

GAGGENAU

GAGGENAU HAUSGERÄTE GMBH
P.O. BOX 10 02 50 · 80076 MÜNCHEN
GERMANY

☎ (089) 45 90-03
FAX (089) 45 90-23 47

GAGGENAU

5551 McFADDEN AVENUE
HUNTINGTON BEACH, CA 92649
USA

☎ (800) 828-9165 · FAX (714) 901-0979
www.gaggenau-usa.com