



OPERATIONANDINSTALLATIONMANUAL

SDA SERIES 350 - 2100 CFM LARGE DEHUMIDIFYING DRYERS

IMPORTANT: PLEASE READ CAREFULLY BEFORE ATTEMPTING TO INSTALL OR OPERATE EQUIPMENT



Bulletin No: DH1-655-1

Part No: 882.00225.00

Effective: 4-28-08

Write Down Your Serial Numbers Here For Future Reference:

_____	_____
_____	_____
_____	_____

We are committed to a continuing program of product improvement.
Specifications, appearance, and dimensions described in this manual are subject to change without notice.

DCN No. _____

© Copyright 2008

All rights reserved.

Shipping Info

Unpacking and Inspection

You should inspect your dryer for possible shipping damage.

Thoroughly check the equipment for any damage that might have occurred in transit, such as broken or loose wiring and components, loose hardware and mounting screws, etc.

In the Event of Shipping Damage

According to the contract terms and conditions of the Carrier, the responsibility of the Shipper ends at the time and place of shipment.

Notify the transportation company's local agent if you discover damage.

Hold the damaged goods and packing material for the examining agent's inspection. **Do not return any goods before the transportation company's inspection and authorization.**

File a claim with the transportation company. Substantiate the claim by referring to the agent's report. A certified copy of our invoice is available upon request. The original Bill of Lading is attached to our original invoice. If the shipment was prepaid, write us for a receipted transportation bill.

Advise customer service regarding your wish for assistance and to obtain an RMA (return material authorization) number.

If the Shipment is Not Complete

Check the packing list as back-ordered items are noted on it. You should have:

- Dehumidifying Dryer
- Bill of lading
- Packing list
- Operating and Installation packet
- Electrical schematic and panel layout drawings
- Component instruction manuals

Re-inspect the container and packing material to see if you missed any smaller items during unpacking.

If the Shipment is Not Correct

If the shipment is not what you ordered, **contact the parts and service department immediately** at [262] 641-8610. Have the item and order numbers ready to expedite your return. *Hold the items until you receive shipping instructions.*

Returns

Do not return any damaged or incorrect items until you receive shipping instructions from the shipping department.

Table of Contents

CHAPTER 1: SAFETY	6
1-1 How to Use This Manual	6
<i>Safety Symbols Used in this Manual</i>	6
1-2 Safety Tag Information	7
<i>Dryer Safety Tags</i>	7
1-3 Warnings and Precautions	8
1-4 Responsibility	9
<i>General Responsibility</i>	9
<i>Operator Responsibility</i>	9
<i>Maintenance Responsibility</i>	10
<i>Reporting a Safety Defect</i>	11
1-5 Responsibility	11
CHAPTER 2: FUNCTIONAL DESCRIPTION	12
2-1 Models Covered in This Manual	12
2-2 General Description	12
2-3 Typical Features and Components	12
2-4 Optional Features	12
2-5 The Closed Loop Drying System	13
2-6 What is Desiccant?	13
2-7 The Process/Regeneration Cycle	13
2-8 Specifying a Drying System	14
CHAPTER 3: INSTALLATION	17
3-1 Work Rules	17
3-2 Electrical Connections	17
3-3 Check For Proper Blower Rotation	17
3-4 Dryer/Drying Hopper Process Air Hose Connection	17
3-5 Aftercooler Cooling Water Connection	18
3-6 Drying Hopper Air Trap	18
CHAPTER 4: CONTROL PANEL	20
4-1 Control Panel Indicator Lights	20
4-2 Switches and Meters	22
4-3 PLC Control	23
4-4 Process Air Temperature Controller	23
4-5 Temperature Controller LED Indicators	25
4-6 Temperature Controller Keys – (See Figure 5 in Section 3-6)	26
4-7 Optional Communications Protocols	26
CHAPTER 5: STARTUP, SHUTDOWN & OPERATION	27
5-1 Pre-Startup Checks	27
5-2 Startup	27
5-3 Shutdown	28
5-4 Setting the Process Air Temperature	28

5-5	Setting the High and Low Temperature Alarms	28
5-6	Temperature Controller Autotune Procedure	29
5-7	Temperature Controller Internal Switches.....	29
5-8	Temperature Controller Anti-Tamper Lockout Switch	29
5-9	Changing the Display from Fahrenheit to Centigrade	30
5-10	Setting the Dewpoint Extend Shift Point.....	30
5-11	Regeneration Monitoring System Signal Processor.....	31
5-12	Auxiliary Process Safety System (Optional).....	32
5-13	Seven Day Timer (Optional).....	32
CHAPTER 6: MAINTENANCE		35
6-1	Servicing the Process Air Filters (Models 350-700)	35
6-2	Filter Cleaning/Replacement	35
6-3	Servicing the Process Air Filters (Models 850 through 2100)	36
6-4	Servicing the Regeneration Filter	37
6-5	Dirty Filter Alarm Calibration	37
6-6	Dewpoint Control System Service.....	38
6-7	Symptoms of Worn Out Desiccant	38
6-8	Desiccant Replacement Procedure.....	39
6-9	Process Heater Replacement Procedure.....	40
6-10	Regeneration Heater Replacement Procedure	41
6-11	Restoring a Temperature Controller to the Factory Setup	42
6-12	Regeneration Monitor Advanced Programming	48
CHAPTER 7: TROUBLESHOOTING		52
CHAPTER 8: APPENDIX.....		55
8-1	Customer Satisfaction Warranty Program.....	Error! Bookmark not defined.
8-2	Technical Assistance.....	58
	<i>Parts Department</i>	Error! Bookmark not defined.
	<i>Service Department</i>	Error! Bookmark not defined.
	<i>Sales Department</i>	Error! Bookmark not defined.
	<i>Contract Department</i>	Error! Bookmark not defined.

Chapter 1: Safety

1-1 How to Use This Manual

Use this manual as a guide and reference for installing, operating, and maintaining your dehumidifying dryer. The purpose is to assist you in applying efficient, proven techniques that enhance equipment productivity.

This manual covers only light corrective maintenance. No other maintenance should be undertaken without first contacting a service engineer.

The Functional Description section outlines models covered, standard features, and safety features. Additional sections within the manual provide instructions for installation, pre-operational procedures, operation, preventive maintenance, and corrective maintenance.

The Installation chapter includes required data for receiving, unpacking, inspecting, and setup of the dehumidifying dryer. We can also provide the assistance of a factory-trained technician to help train your operator(s) for a nominal charge. This section includes instructions, checks, and adjustments that should be followed before commencing with operation of the dehumidifying dryer. These instructions are intended to supplement standard shop procedures performed at shift, daily, and weekly intervals.

The Operation chapter includes a description of electrical and mechanical controls, in addition to information for operating the dryer safely and efficiently.

The Maintenance chapter is intended to serve as a source of detailed assembly and disassembly instructions for those areas of the equipment requiring service. Preventive maintenance sections are included to ensure that your dehumidifying dryer provides excellent, long service.

The Troubleshooting chapter serves as a guide for identification of most common problems. Potential problems are listed, along with possible causes and related solutions.

The Appendix contains technical specifications, drawings, schematics, parts lists, and available options. A spare parts list with part numbers specific to your machine is provided with your shipping paperwork package. Refer to this section for a listing of spare parts for purchase. Have your serial number and model number ready when ordering.

Safety Symbols Used in this Manual

The following safety alert symbols are used to alert you to potential personal injury hazards. Obey all safety messages that follow these symbols to avoid possible injury or death.

DANGER! *DANGER indicates an imminently hazardous situation that, if not avoided, will result in death or serious injury.*

WARNING! *WARNING indicates a potentially hazardous situation or practice that, if not avoided, could result in death or serious injury.*

Caution! *CAUTION indicates a potentially hazardous situation or practice that, if not avoided, may result in minor or moderate injury or in property damage.*

1-2 Safety Tag Information

Dryer Safety Tags



Hot!



**Read Operation
and Installation
Manual**



**High Voltage
Inside Enclosure**



Earth Ground



Lifting Point



**Protected Earth
Ground**

1-3 Warnings and Precautions

Our equipment is designed to provide safe and reliable operation when installed and operated within design specifications, following national and local safety codes. This may include, but is not limited to OSHA, NEC, CSA, SPI, and any other local, national and international regulations.

To avoid possible personal injury or equipment damage when installing, operating, or maintaining this equipment, use good judgment and follow these safe practices:

- ☑ **Read and follow these operation and installation instructions when installing, operating, and maintaining this equipment. If these instructions become damaged or unreadable, additional copies are available from the manufacturer.**
- ☑ Follow all **SAFETY CODES**.
- ☑ Wear **SAFETY GLASSES** and **WORK GLOVES**.
- ☑ Work only with approved tools and devices.
- ☑ Disconnect and/or lock out power before servicing or maintaining the equipment.
- ☑ Use care when **LOADING, UNLOADING, RIGGING, or MOVING** this equipment.
- ☑ Operate this equipment within design specifications.
- ☑ **OPEN, TAG, and LOCK ALL DISCONNECTS** before working on equipment. You should remove the fuses and carry them with you.
- ☑ Make sure the equipment and components are properly **GROUNDED** before you switch on power.
- ☑ Use **EXTREME CAUTION** when working with dryer. **HIGH HEAT** can be dangerous. Keep body parts, tools, clothing, and debris away from dryer.
- ☑ When welding or brazing in or around this equipment, make sure **VENTILATION** is **ADEQUATE. PROTECT** adjacent materials from flame or sparks by shielding with sheet metal. An approved **FIRE EXTINGUISHER** should be close at hand and ready for use if needed.
- ☑ Do not restore power until you remove all tools, test equipment, etc., and the equipment and related components are fully reassembled.
- ☑ Only **PROPERLY TRAINED** personnel familiar with the information in this manual should work on this equipment.

We have long recognized the importance of safety and have designed and manufactured our equipment with operator safety as a prime consideration. We expect you, as a user, to abide by the foregoing recommendations in order to make operator safety a reality.

1-4 Responsibility

These machines are constructed for maximum operator safety when used under standard operating conditions and when recommended instructions are followed in the maintenance and operation of the machine.

All personnel engaged in the use of the machine should become familiar with its operation as described in this manual.

Proper operation of the machine promotes safety for the operator and all workers in its vicinity.

Each individual must take responsibility for observing the prescribed safety rules as outlined. All warning and danger signs must be observed and obeyed. All actual or potential danger areas must be reported to your immediate supervisor.

General Responsibility

No matter who you are, safety is important. Owners, operators and maintenance personnel must realize that every day, safety is a vital part of their jobs.

If your main concern is loss of productivity, remember that production is always affected in a negative way following an accident. The following are some of the ways that accidents can affect your production:

- Loss of a skilled operator (temporarily or permanently)
- Breakdown of shop morale
- Costly damage to equipment
- Downtime

An effective safety program is responsible and economically sound.

Organize a safety committee or group, and hold regular meetings. Promote this group from the management level. Through this group, the safety program can be continually reviewed, maintained, and improved. Keep minutes or a record of the meetings.

Hold daily equipment inspections in addition to regular maintenance checks. You will keep your equipment safe for production and exhibit your commitment to safety.

Please read and use this manual as a guide to equipment safety. This manual contains safety warnings throughout, specific to each function and point of operation.

Operator Responsibility

The operator's responsibility does not end with efficient production. The operator usually has the most daily contact with the equipment and intimately knows its capabilities and limitations.

Plant and personnel safety is sometimes forgotten in the desire to meet incentive rates, or through a casual attitude toward machinery formed over a period of months or years. Your employer probably has established a set of safety rules in your workplace. Those rules, this manual, or any other safety information will not keep you from being injured while operating your equipment.

Learn and always use safe operation. Cooperate with co-workers to promote safe practices. Immediately report any potentially dangerous situation to your supervisor or appropriate person.

REMEMBER:

- **NEVER** place your hands or any part of your body in any dangerous location.
- **NEVER** operate, service, or adjust the dryer without appropriate training and first reading and understanding this manual.
- **NEVER** try to pull material out of the dryer with your hands while it is running!
- Before you start the dryer check the following:
 - Remove all tools from the dryer;
 - Be sure no objects (tools, nuts, bolts, clamps, bars) are laying in the hopper area;
- If your dryer has been inoperative or unattended, check all settings before starting the unit.
- At the beginning of your shift and after breaks, verify that the controls and other auxiliary equipment are functioning properly.
- Keep all safety guards in place and in good repair. **NEVER** attempt to bypass, modify, or remove safety guards. Such alteration is not only unsafe, but will void the warranty on your equipment.
- When changing control settings to perform a different mode of operation, be sure selector switches are correctly positioned. Locking selector switches should only be adjusted by authorized personnel and the keys removed after setting.
- Report the following occurrences **IMMEDIATELY**:
 - unsafe operation or condition
 - unusual dryer action
 - leakage
 - improper maintenance
 - **NEVER** stand or sit where you could slip or stumble into the dryer while working on it.
- **DO NOT** wear loose clothing or jewelry, which can be caught while working on a dryer. In addition, cover or tie back long hair.
- Clean the dryer and surrounding area **DAILY**, and inspect the machine for loose, missing or broken parts.
- Shut off power to the dryer when it is not in use. Turn the switch to the **OFF** position, or unplug it from the power source.

Maintenance Responsibility

Proper maintenance is essential to safety. If you are a maintenance worker, you must make safety a priority to effectively repair and maintain equipment.

Before removing, adjusting, or replacing parts on a machine, remember to turn off all electric supplies and all accessory equipment at the machine, and disconnect and lockout electrical power. Attach warning tags to the disconnect switch.

When you need to perform maintenance or repair work on a dryer above floor level, use a solid platform or a hydraulic elevator. If there is a permanently installed catwalk on your dryer, use it. The work platform should have secure footing and a place for tools and parts. **DO NOT** climb on dryers, machines, or work from ladders.

If you need to repair a large component, use appropriate handling equipment. Before you use handling equipment (portable “A” frames, electric boom trucks, fork trucks, overhead cranes) be sure the load does not exceed the capacity of the handling equipment or cause it to become unstable.

Carefully test the condition of lifting cables, chains, ropes, slings, and hooks before using them to lift a load.

Be sure that all non-current carrying parts are correctly connected to earth ground with an electrical conductor that complies with current codes. Install in accordance with national and local codes.

When you have completed the repair or maintenance procedure, check your work and remove your tools, rigging, and handling equipment.

Do not restore power to the dryer until all persons are clear of the area. **DO NOT** start and run the dryer until you are sure all parts are functioning correctly.

BEFORE you turn the dryer over to the operator for production, verify all dryer enclosure panels, guards and safety devices are in place and functioning properly.

Reporting a Safety Defect

If you believe that your equipment has a defect that could cause injury, you should immediately discontinue its use and inform the manufacturer.

The principle factors that can result in injury are failure to follow proper operating procedures (i.e. lockout/tagout), or failure to maintain a clean and safe working environment.

1-5 Responsibility

These machines are constructed for maximum operator safety when used under standard operating conditions and when recommended instructions are followed in the maintenance and operation of the machine.

All personnel engaged in the use of the machine should become familiar with its operation as described in this manual.

Proper operation of the machine promotes safety for the operator and all workers in its vicinity.

Becoming familiar with materials, inspection, speed limitations, screens, and guard maintenance and total user responsibility will assist you in learning potential areas in need of observation for danger.

Each individual must take responsibility for observing the prescribed safety rules as outlined. All caution, warning and danger signs must be observed and obeyed. All actual or potential danger areas must be reported to your immediate supervisor.

Chapter 2: Functional Description

2-1 Models Covered in This Manual

This manual provides operation, installation, and maintenance instructions for WD/SDA/CDA 350, 425, 500, 600, 700, 850, 1000, 1250, 1500, 1800, and 2100 cfm large dehumidifying dryers in both standard 300° F and 400° F high temperature “-RT” models. Model numbers are listed on the serial tag. Make sure you know the model and serial number of your equipment before contacting the manufacturer for parts or service.

2-2 General Description

Dehumidifying Dryers are designed to generate heated, dehumidified air at carefully controlled temperatures for use in closed-loop plastic drying systems. Drying systems are sized to meet the specific requirements stated by the purchaser at the time of purchase.

Moisture removal from hygroscopic (moisture attracting) plastic pellets is an essential step in the manufacture of high-quality plastic products.

ACS dryers are used by the plastics industry to generate very low dewpoint air that is heated to a controlled temperature for drying plastic pellets and regrind.

2-3 Typical Features and Components

1. Branch Fusing provides additional protection to the operator and the components on the dryer's sub-panel.
2. Dewpoint Monitor indicates dryer efficiency

2-4 Optional Features

Options can tailor an ACS dryer to meet the exact requirements of the drying task being performed.

- Dirty filter indicator to advise the operator when it's time to clean the filters.
- Water-cooled aftercooler for closed loop regeneration air cooling
- SMART PLC to combine PLC features and a "Plain English" interface. This option is fully described in its own manual.
- Heater Burnout Indicator to monitor the heater(s) amp draw.
- Compressed air filter cleaning to lower maintenance on regrind/dusty material drying processes.
- Auxiliary high temperature safety system to cut high voltage to the blowers and heaters in the event of run-away process heaters.
- Seven day timer to allow programmable dryer start up.
- Communications to meet customer needs.
- Drying Hoppers come in many sizes and mounting configurations.
- Conveying Equipment to transport material to and from the drying system.
- Insulated Process Air Hose to minimize heat loss between the dryer and the drying hopper.

2-5 The Closed Loop Drying System

ACS dryers force hot, dry air through the resin in the drying hopper, where the air picks up moisture from the material and is drawn back to the dryer.

In the dryer, moisture is stripped from the air by a desiccant bed. The dried process air is then re-heated and delivered back into the drying hopper to dry material again.

This system is a "closed loop", because ambient (outside) air is never introduced into the process air. The closed loop system is used by ACS because the process air is typically much drier than ambient air, even after carrying moisture out of the plastic resin. Recycling process air maintains drying efficiency at a consistently high level.

Figure 1: WD/SDA/CDA 350-2100 Dryer Specifications

Model Number	Amp Draw	Dimensions (Inches)			Hose Connection (Inches)	Shipping Weight	Process Blower	Regen Blower	Desiccant Lbs./Bed	
		L	W	H					I.D.	Lbs.
	460-3-60									
350		56	56	73	4	1000	5	½	30	76
350-RT		56	56	73	4	1000	5	½	30	76
425		61	52	82	5	1100	7½	½	30	90
425-RT		61	52	82	5	1100	7½	½	30	90
500		63	66	94	5	1200	7½	¾	40	100
500-RT		63	66	94	5	1200	7½	¾	40	100
600		58	56	88	6	1450	10	¾	40	120
600-RT		58	56	88	6	1450	10	¾	40	120
700		59	66	93	6	1600	10	¾	40	135
700-RT		59	66	93	6	1600	10	¾	40	135
850	103	88	84	90	8		3	¾	120	120
850-RT	141	88	84	90	8		3	¾	120	120
1000	113	88	84	90	8		7½	¾	120	130
1000-RT	146	88	84	90	8		7½	¾	120	130
1250	138	88	84	90	8		7½	¾	120	180
1250-RT	194	88	84	90	8		7½	¾	120	180
1500	156	94	100	90	8		7½	¾	120	240
1500-RT	213	94	100	90	8		7½	¾	120	240
1800	179	94	100	90	8		10	¾	120	310
1800-RT	235	94	100	90	8		10	¾	120	310
2100	203	94	100	98	10		15	¾	120	360
2100-RT	278	94	100	98	10		15	¾	120	360

2-6 What is Desiccant?

Desiccant is a material which attracts and holds (absorbs) water from the air. The desiccant ACS dryers use is a synthetic crystalline metal aluminosilicate that is blended with a clay binder and formed into beads.

Absorbed water is driven from saturated desiccant by heating it to a high temperature (reducing the desiccant's capacity to hold water) and forcing air through it. This moisture removal process is called "regeneration".

2-7 The Process/Regeneration Cycle

ACS dryers have two desiccant beds. While one bed is on-line in the process air loop, the other is off-line being regenerated.

When a desiccant bed is on-line, it absorbs moisture from the process air. In time, the bed becomes saturated with moisture and needs to be regenerated. The dryer automatically redirects the process airflow to the second bed, and starts the regeneration cycle on the first bed.

During regeneration, air is heated to approximately 550°F and forced through the desiccant bed. The moisture driven off the bed is bled to the atmosphere.

If the temperature of the air bled to atmosphere (bleed temperature) is measured, a rise can be observed after a period of time. This condition, called "bed breakthrough" indicates that the bed is dry. At bed breakthrough, the bleed air temperature peaks between 350°F and 400°F.

Dryer models 350 through 2100 dryers are equipped with the Dewpoint Extend feature. The regeneration heaters turn off automatically on bed breakthrough for additional energy savings. A 550°F regeneration temperature will dry the desiccant beds sufficiently to produce process air dewpoint of -40°F. In a properly sized system, this ultra-low humidity level will be more than adequate to dry plastics to as little as .003% moisture.

2-8 Specifying a Drying System

There were many variables considered in the selection of your drying system, including: type of materials, residence time, throughput of the extruder or injection molding machine, ambient air moisture and temperature, and the altitude at the processing site. Should your operating environment change, the manufacturer can advise you on necessary equipment and process time and temperature modifications.

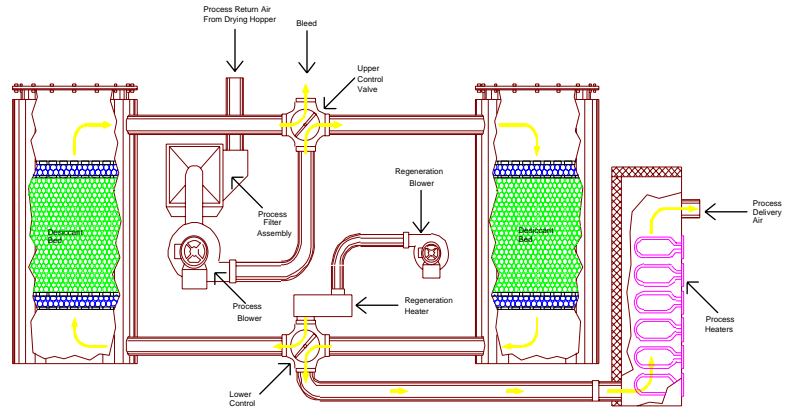

**Figure Two:
Airflow Diagram**

Figure 3: Dryer Dimensions

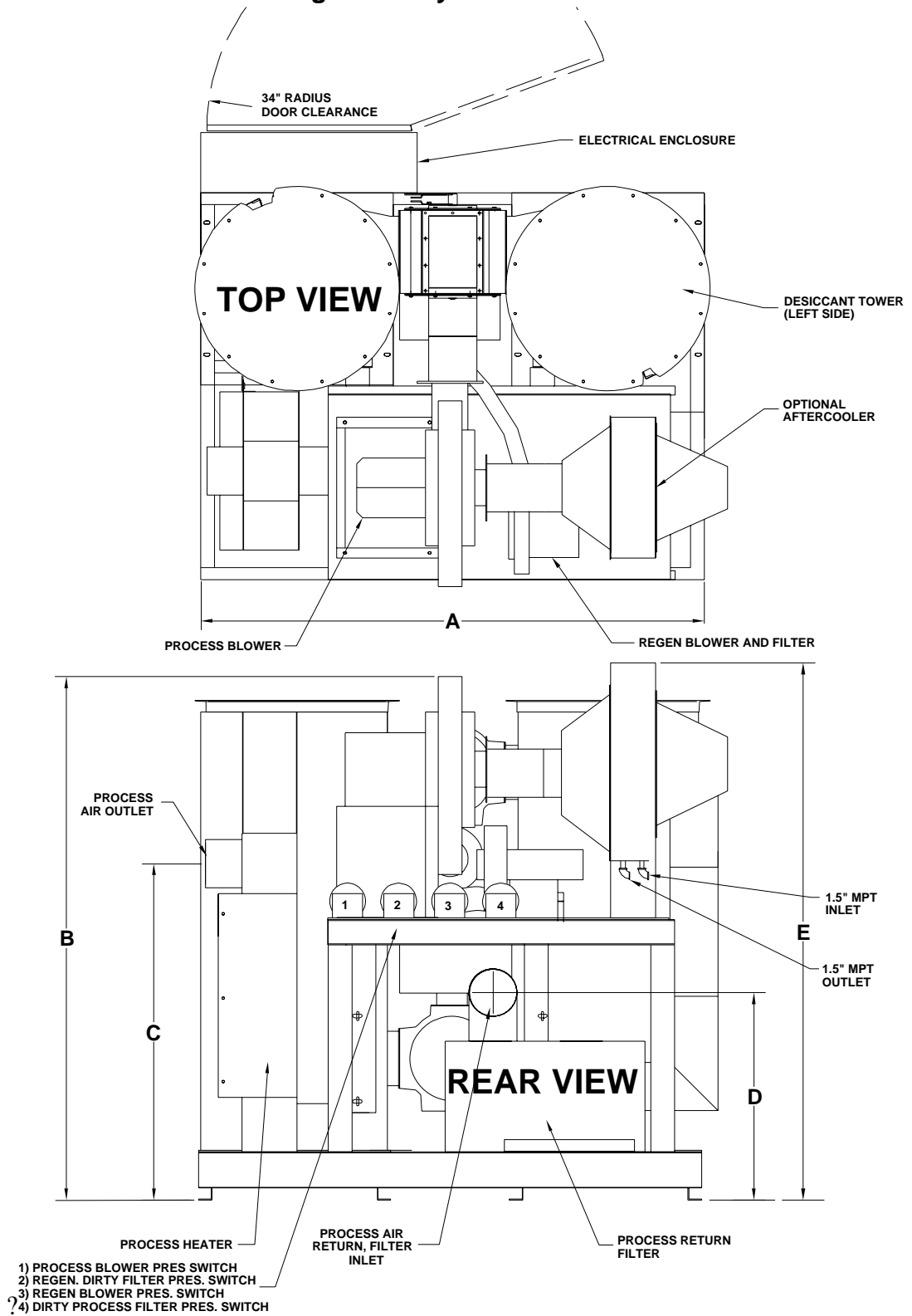
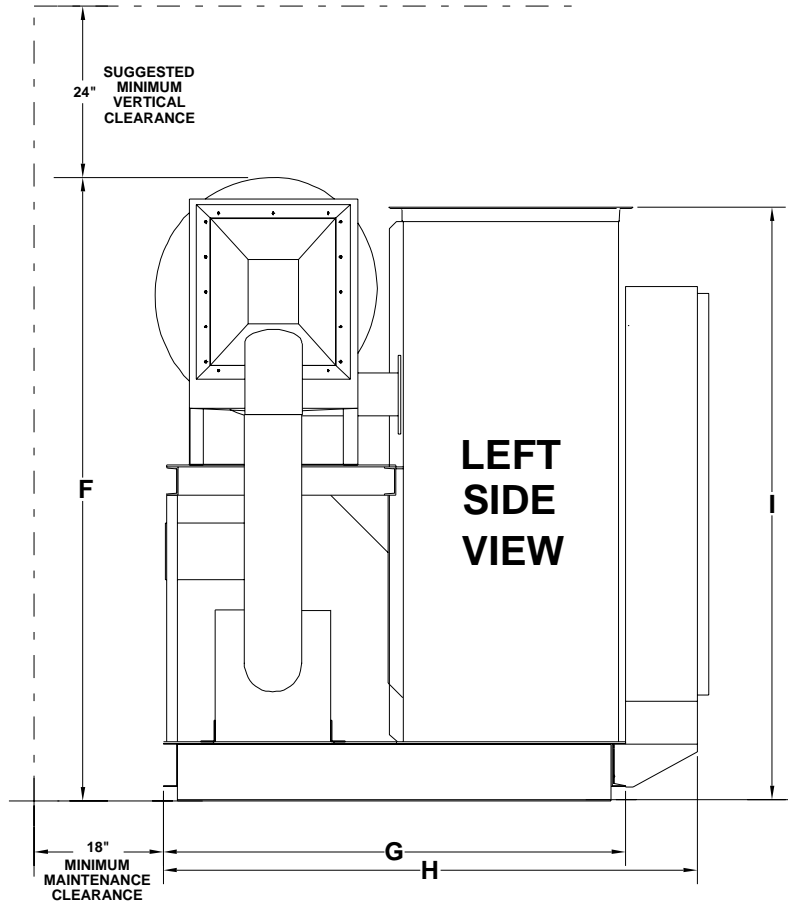

Figure 4: Dryer Dimensions



Model	A	B	C	D	E	F	G	H	I
850	84	88	56	34 ½	90	87 ½	84 ½	74	83
1000	84	88	56	34 ½	90	87 ½	84 ½	74	83
1250	84	88	56	34 ½	90	87 ½	84 ½	74	83
1500	100	90 ½	82 ½	44 ½	90 ½	88	70 ½	91 ½	83
1800	100	90 ½	82 ½	44 ½	90 ½	88	70 ½	91 ½	83
2100	100	90 ½	82 1/2	44 ½	90 ½	88	70 ½	91 ½	83

Chapter 3: Installation

3-1 Work Rules

The installation, operation, and maintenance of this equipment must be conducted in accordance with all applicable work and safety codes for the installation location. This may include, but not limited to, OSHA, NEC, CSA, and any other local, national and international regulations.

1. Read and follow these operating instructions when installing, operating and maintaining this equipment. If the instructions become damaged or unreadable, additional copies are available from the manufacturer.
2. Only qualified personnel familiar with this equipment should work on or with this dryer.
3. Work with approved tools and devices.
4. Disconnect the electricity before maintenance or service. If the dryer is installed with a power cord that can be unplugged, unplug it. If the dryer is permanently wired to a power main, a fused power disconnect must be installed to allow the disconnect to be locked in the "OFF" position. Open and lock out the disconnect installed in the control enclosure.

3-2 Electrical Connections

The voltage, phase and amp draw information is listed on the serial tag.

- Line voltage must be within $\pm 10\%$ of the voltage listed on the serial tag, or damage may occur. Phase imbalance must be less than 5%.
- Fulfill all national, state and local safety and electrical code requirements.
- Connection should be made by a qualified electrician.
- Connect main power to the dryer at the disconnect or terminals in the upper right corner of the control enclosure.
- Install a fused disconnect with a lockout feature in the power main leading to the dryer.
- The power drop must include a ground wire.

3-3 Check For Proper Blower Rotation

The blowers are rotating properly when air flows from the delivery outlet.

- Incorrect phasing of power leads will cause backward rotation of blower motors and contamination of the desiccant.

If both blowers are rotating improperly, reverse any two wires at the fused disconnect outside the dryer or at the disconnect/terminal in the control enclosure. This assures that both blowers will be rotating in the proper direction.

- Reverse the wires at the motor starters only if one blower is rotating incorrectly.

3-4 Dryer/Drying Hopper Process Air Hose Connection

- Use high-temperature flexible dryer hose or rigid tubing to connect the dryer to the drying hopper.

- ☑ Keep the delivery (to the drying hopper) hose as short as possible to minimize heat loss. Insulated hose is recommended and available for maximum energy savings.
- ☑ Do not use insulated hose on the return (from the drying hopper)
- ☑ Do not shorten the return hose. The return air to the blower must be 150°F or below.
- ☑ Make sure the hoses are not kinked.
- ☑ Drying hopper air inlet and outlet locations vary, but always connect the hoses so the dry process air from the dryer enters the bottom of the drying hopper and flows out the top to return to the dryer inlet.

3-5 Aftercooler Cooling Water Connection

The Aftercooler cools the moist air returning to the dryer from the drying hopper. The aftercooler can cool the return air from 250°F to about 150°F. This maintains the dryer's efficiency and condenses unwanted plasticizers from the airstream.

1. Support both sides of the fitting when making the cooling water connections to prevent damage to the aftercooler coil.
2. Connect 85°F water to the 1½" NPT inlet closest to the exiting air side of the aftercooler coil. This will cool the process air about 100°F and raise the water-out temperature about 10°F.

Aftercooler Model	Recommended Cooling Water Flow Rate (GPM)
AFT350	6.6 gpm
AFT425	10 gpm
AFT500	10 gpm
AFT600	13.2 gpm
AFT700	18 gpm
AFT850	18 gpm
AFT1000	22 gpm
AFT1250	22 gpm
AFT1500	25 gpm
AFT1800	25 gpm
AFT2100	25 gpm

3-6 Drying Hopper Air Trap

ACS's exclusive air trap assembly in the top of the drying hopper prevents ambient air from contaminating the material being dried.

5. Keep the material level above the bottom edge of the air trap for maximum efficiency.
6. Use a hopper loader or vacuum conveying system to maintain the proper material level.

Figure 5: Typical Control Panel

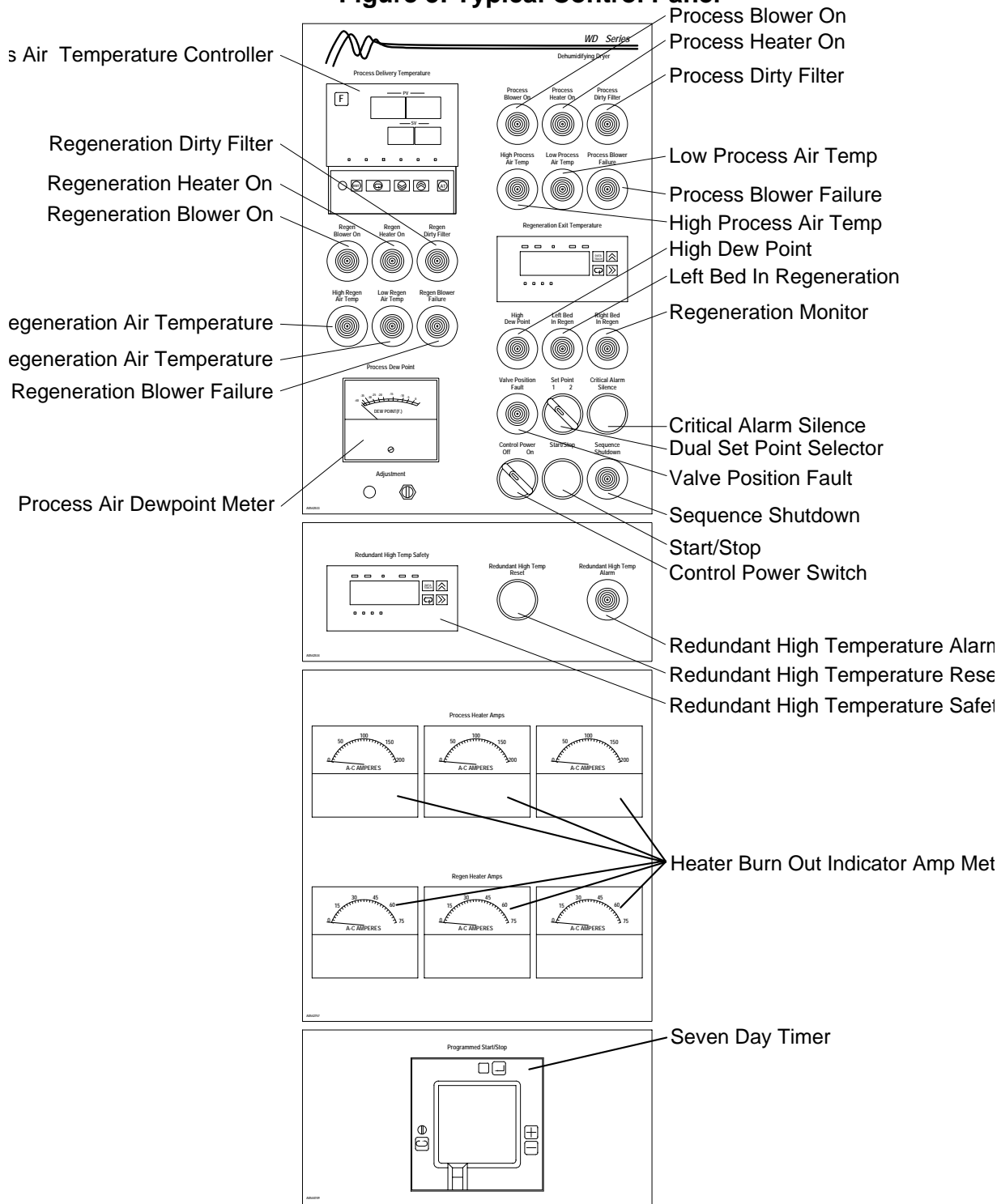

OPTIONAL EQUIPMENT SHOWN

Chapter 4: Control Panel

4-1 Control Panel Indicator Lights

PROCESS BLOWER ON

This indicator lights when the process blower is energized.

PROCESS HEATER ON

This indicator lights when the process air heaters are energized.

HIGH PROCESS AIR TEMPERATURE ALARM

- This indicator lights when the temperature at the process air thermocouple is above the set high alarm value.
- When the indicator lights, the alarm relay is energized and all the heaters turn off while the blowers remain on.
- The alarm mode and value are factory-set to track 25°F above the process setpoint. The alarm value is a deviation above the process setpoint.
- When the temperature at the process thermocouple returns to within the acceptable range, the alarm output is de-energized and all the heaters turn on again automatically.
- The alarm range may be altered - See Section 5-5.

REGEN BLOWER ON

This indicator lights when the regeneration blower is energized.

REGEN HEATER ON

This indicator lights when the regeneration heater is on.

LEFT BED REGENERATING & RIGHT BED REGENERATING

The indicator lit shows which bed is currently being regenerated [off-line].

HIGH DEW POINT ALARM

This indicator lights when the process air delivery dew point exceeds the dew point shift point, as set by the adjustment pot on the control enclosure graphic panel. See Section 5-6.

DIRTY FILTER ALARM

- This indicator lights if the pressure differential across either the process air return filter or the regeneration inlet filter exceeds the pressure switch setting.
- This indicates a filter in need of service.
- The light resets automatically when the filter is serviced.
- The pressure switch is adjustable - See Section 6-4.

LOW PROCESS AIR TEMPERATURE ALARM

- This indicator lights when the temperature at the process air thermocouple is below the set low alarm value.

- ☑ The alarm mode and value are factory-set to track 25°F below the process setpoint. The alarm value is a deviation above the process setpoint.
- ☑ This alarm is informational. If the alarm light stays lit for an extended period of time, check for blown fuses or possible burnt-out heaters.
- ☑ When the temperature at the thermocouple returns within limits, the alarm clears automatically.
- ☑ This alarm is delayed on initial start-up to avoid nuisance alarms.
- ☑ The alarm range may be altered. See Section 5-5.

PROCESS BLOWER FAILURE ALARM

- ☑ This indicator lights if pressure switch 2PS detects a loss of process blower air pressure.
- ☑ All heaters are shut-off until the alarm is cleared.

REGEN BLOWER FAILURE ALARM

- ☑ This indicator lights if pressure switch 1PS detects a loss of regeneration blower air pressure.
- ☑ All heaters are shut-off until the alarm is cleared.

HIGH REGEN AIR TEMPERATURE ALARM

This indicator lights when the thermocouple below the regeneration heater assembly senses an abnormally high temperature.

Note: Do not adjust the factory setpoint of 3CNTL, the 1/16 DIN panel-mounted temperature controller inside the enclosure.

The regeneration heaters are shut-off until the temperature falls below the alarm point. The regeneration blower will continue to run and cool the heaters and desiccant bed.

The alarm light will clear automatically when the temperature drops below the alarm point, and the heaters will re-energize automatically.

LOW REGEN AIR TEMPERATURE

This indicator lights if the regeneration bleed temperature has not reached the factory setpoint of 150°F within 30 minutes of the start of bed regeneration.

The panel meter (2CNTL) and the PLC monitor the regeneration bleed temperature.

This alarm is informational, and does not affect the regeneration process.

This alarm may indicate a very wet desiccant bed or, if the light does not go off within an hour, malfunctioning or burnt out regeneration heaters. For more details on the regeneration monitoring system, see Section 5-7.

CRITICAL ALARM SILENCE

Press this button to turn off the audible alarm and flashing beacon when a critical, operation stopping alarm occurs.

The alarm will repeat every five minutes unless the problem causing the alarm has been resolved.

VALVE POSITION ERROR

A pair of position switches confirm proper shifting of the valves.

If full travel is not confirmed by the switches, the cycle will not begin on the new bed.

4-2 Switches and Meters

ON/OFF SELECTOR SWITCH

This energizes or de-energizes the dryer's control power.

START/STOP PUSH-BUTTON

Press this momentary contact switch to start the dryer. Press this switch to shut down an operating dryer. The dryer shutdown sequence is:

1. Process heaters shut off immediately.
2. Process blower continues to run for 20 minutes to cool the process heater, then shuts off.
3. The regeneration cycle of the off-line bed will continue until finished, the regeneration heaters will shut off, followed by the regeneration blower.

DEWPOINT METER

- This meter indicates the current process air delivery moisture content.
- When the Push To Set button is pressed, the meter indicates the Dewpoint Shift point. See Section 5-10.

PUSH TO SET

This push-button is used when setting or confirming the Dewpoint Shift point. See Section 5-6.

DEWPOINT SHIFT ADJUST

This potentiometer [pot] is used when setting the Dewpoint Shift point. See Section 5-6.

SHIFT SET SELECTOR SWITCH

In the "ON" position, the drying temperature is raised or lowered to the ¼ DIN controller's alternate temperature - see Section 4-5.

OVER TEMPERATURE RESET [Optional]

This push-button resets the control system to allow restart of heaters and blowers after process air temperature has dropped below the high value programmed into the 1/8 DIN panel meter (4CNTL)

This is on dryers equipped with the auxiliary hi-temperature safety option.

HEATER BURN-OUT INDICATOR METERS [Optional]

- The six current indicating meters monitor the current draw on each phase of the process and regeneration heaters.
- During normal operation, all three meters (phases) should read within one or two amps of each other.

- ☑ If one or two of a heater's three meters indicates a low reading, a burned-out heater is likely, and should be serviced.

4-3 PLC Control

These dryers are equipped with an Omron C28K programmable logic controller (PLC).

The "brick" type PLC has 28 I/O points - 16 inputs and 12 outputs.

All inputs are 115 VAC, except for the 24 VDC input #1 from the dewpoint circuit board.

All programming and logic is factory installed on an EPROM, and cannot be modified.

A battery backup retains the programming during power failures.

Battery life is 5 years at room temperature.

If the alarm indicator blinks intermittently, replace the battery [P/N A0544701] within one week.

4-4 Process Air Temperature Controller

Standard ACS dryers use a microprocessor based PID control for maintaining process air temperature. The controller is a modular, self-contained unit that can slide from its mounting housing. All parameters except for the process air setpoint are factory set and adjusted; no field adjustment to the internal controls is normally necessary.

Figure 6: Process Air Temperature Controller

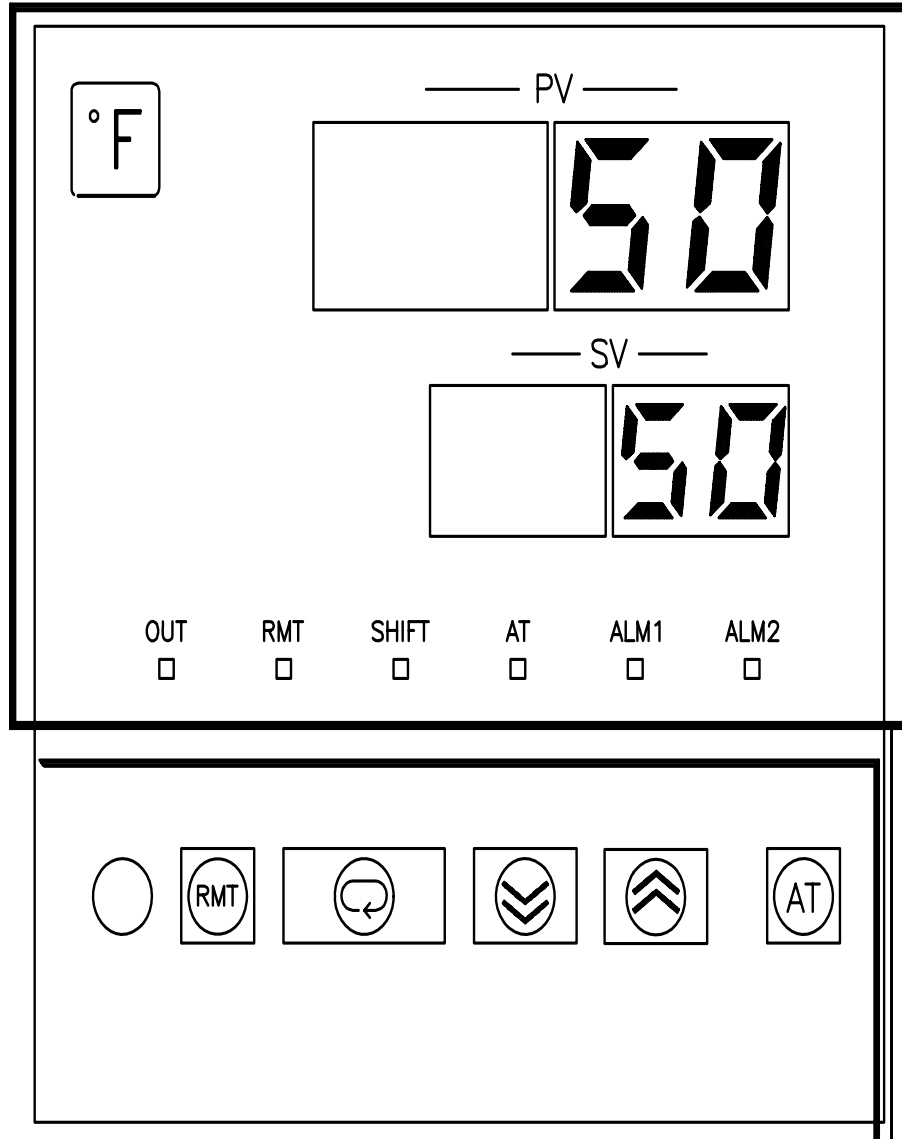

4-5 Temperature Controller LED Indicators

—— PV —— **Process Value Numeric LED**

During normal operation, this red LED on the control displays the process temperature at the "To Process" thermocouple. It also lists parameters during setup and error messages if an error occurs.

—— SV —— **Set Value Numeric LED**

During normal operation, this green LED on the control displays the process set point you want the dryer to maintain. It also displays parameter and pre-set function values during setup.

OUT

Output LED

This orange LED lights when the control output energizes the process air heater.

RMT

Remote LED

This lights when remote operation occurs on dryers equipped with optional communications.

SHIFT

Shift LED

This orange LED lights if the optional Shift Set switch is closed. The process temperature will be changed by the amount set in the **SP-5** value in the Level 1 parameters. To shift to a lower value, be sure to enter a negative value.

AT

Auto-Tune LED

This orange LED flashes during the Auto-Tune sequence. The controller will automatically determine the proper P.I.D. values for the operating conditions. See Section 6-11.

ALM1

Alarm One LED - High Temp Alarm

This lights when the process air temperature has risen more than 25°F [factory default] from the setpoint. The alarm relay in the PLC is energized when this LED is lit. The audible/visual alarm will sound if the dryer is so-equipped. All heaters turn off and the blowers stay on to cool the heaters. It is adjustable - see Section 5-5.

ALM2

Alarm Two LED - Low Temp Alarm

This lights when the process air temperature drops more than 25°F [factory default] from the setpoint. The alarm relay in the PLC is energized when this LED is out. The audible/visual alarm will sound if the dryer is so-equipped. It is adjustable - see Section 5-5.

4-6 Temperature Controller Keys – (See Figure 5 in Section 3-6)

LEVEL KEY

When pressed for two seconds or more, this key selects the next of the three indication levels (0, 1 and 2) where specific control parameters may be set. The control defaults to level 0 on power up.

REMOTE KEY

This key is on controls with optional communications. For information on RS-232C, RS-422, or RS-485 communications, refer to the Communications Manual [part number A0535959]. For RS-232C units with the SPI CPC protocol converter, refer to the CPC Operation & Installation Manual [part number A0536527].

MODE KEY

This key scrolls through the parameters that can be set in indication levels 0 and 1.

Note: *During normal operation, use this key to change the alarm setting only. The factory alarm settings are 25°F above and below the setpoint and are satisfactory for most applications.*

DOWN KEY

This key lowers the process air set point temperature. During setup, it decreases the value of the parameter displayed by the Set Value (SV) LED.

UP KEY

This key raises the process air set point Temperature. During setup, it increases the value of the parameter displayed by the Set Value (SV) LED.

AUTOTUNE KEY

When pressed and held for one second or more, this key starts the Auto-Tune function.

4-7 Optional Communications Protocols

For SPI, RS-232C, RS-422, and RS-485 communications, a connection port on the electrical cabinet permits easy hook-up to the host computer. The connection port is a direct pin to pin extension from the plug on the back of the temperature controller. For pin outs, consult the control module's communication manual [part number A0535959].

Chapter 5: Startup, Shutdown & Operation

5-1 Pre-Startup Checks

- ☑ Check the process and return hoses for tight connections.
- ☑ Check that all companion equipment, such as the drying hopper, loading system and aftercooler are ready for operation.
- ☑ Check the dryer electrical connections.

Note: Clean the rust-preventive oil from inside the drying hopper. Failure to clean the hopper will cause fouling of the desiccant in the dryer, and will void the warranty.

5-2 Startup

Close the slidegate at the bottom of the drying hopper.

1. Fill the drying hopper with material.
2. Turn on (energize) the disconnect switch in your power drop, then turn on the one on the dryer.
3. Flip the on/off switch to "ON."
4. Press the stop/start button. The blowers should start, and the proper control panel indicators should light.
5. Make sure both blowers are turning the right direction. Verify rotation direction is correct. If one or both blowers do not start:
 - Check to see if an overload on the blower motor starter has tripped. If so, set it properly and reset. Check the blower fuses, too.
 - If one of the optional Valve Position Error lights is lit, the blowers will not start. Make sure the valve arm has tripped the proper limit switch. If the electric actuator is not fully extended or retracted, check the line fuse (8FU) near the actuator's 24 VDC power supply.

The valve actuator has built-in limit switches to shut off its motor. It must fully extend and retract to prevent the motor from burning out.

- If a blower failure light is lit after the blower has run for a few seconds and shut down, the blower pressure switch will need to be adjusted until the failure light goes out.

The pressure switches at the rear of the dryer were adjusted during factory-testing. Pressure changes in the drying system as installed may make some adjustment to these necessary during initial startup.

6. If the dryer has an aftercooler, make sure there is proper flow of cooling water flow through the coil, and any trapped air has been bled from the system.
7. Make sure the damper on the hopper air inlet tube is about 50% open.
8. Remove the lower end of the 2½" flex hose from the tube stub on the lower drying hopper. Carefully adjust the damper valve on the return line back to the filter to achieve approximately 200 cfm air flow out of the flex hose.
9. Set the process setpoint on the temperature controller.
10. After the proper pre-drying time for the initial hopper fill has elapsed, fully open the drying hopper slidegate.



To allow proper residence time during continuous processing, the material level in the hopper should be maintained at the midpoint of the air trap assembly.

5-3 Shutdown

- Turn off the conveying system supplying the drying hopper.
- When processing is complete, close the hopper slide gate and shut down any in-line companion equipment, i.e. an aftercooler.
- Push the Start/Stop button. After both blowers have shut down and regeneration is complete, turn the On/Off selector switch "OFF".
- Empty the drying hopper, if desired.
- For maintenance or long-term shut down, open (de-energize) the electrical disconnects at the dryer and in the power drop.



5-4 Setting the Process Air Temperature

To Change Process Air Temperature Set Point:



- Press  to raise the Setpoint.
- Press  to lower the Setpoint.

5-5 Setting the High and Low Temperature Alarms

To Change the Process Air High Temperature Alarm Setting:

1. Press  for at least two seconds to access the level 1 parameters.
2. When the PV LED display shows **AL-1**, use  and  to set the desired high temperature alarm value.

The high temperature alarm value is a deviation of the process air temperature set point. The alarm value will track the set temperature. If the high temperature alarm is set to "25", a high temperature alarm occurs if the process air temperature rises more than 25°F above the process air temperature setpoint.

3. Press  until the PV LED shows **AL-2**. Use  and  to set the desired low temperature alarm value.

The low temperature alarm value is a deviation of the process air temperature set point. The alarm value will track the set temperature. If the low temperature alarm is set to "-25", a low temperature alarm occurs if the process air temperature falls more than 25°F below the process air temperature setpoint.

4. Press  until the Level 0 values [process air temperature setpoint and process air temperature] are displayed. The High Temperature Alarm is now set.

5-6 Temperature Controller Autotune Procedure

Auto-tune fine tunes the control's PID to process requirements. Auto-tune whenever the process under control changes or when the controller cycles more than 2° or 3° above or below the setpoint.

Don't be alarmed by the control's response. It may take the process temperature above and below the set points as many as three times. It will then level off and control to the process set point. Auto-tuning can take up to 30 minutes, and is best done before any process is being run.





To Auto-Tune the Control:

1. Press and hold down  for several seconds until the "AT" indicator flashes. The AT LED flashes to indicate that the control is tuning itself.
2. When the AT LED light stops flashing, the controller is tuned and ready for operation.

5-7 Temperature Controller Internal Switches

The control is set up and tested at the factory for optimum operation, and the internal switches don't need to be adjusted. If the control does not work properly, or you suspect someone has accidentally changed some settings, there are two solutions. First, try the AUTO-TUNE PROCEDURE as described in Section 6-11. If that doesn't work, see Section 6-15.

5-8 Temperature Controller Anti-Tamper Lockout Switch

This slide switch prevents unauthorized changes to set points. If this switch [SW101] is On, the , ,  and  keys are disabled. Only the process set point and alarm settings may be viewed. Dryers are factory-set with the protection turned Off.

Enabling the Lockout Feature:

1. Disconnect main electrical power to the dryer.
2. Press up the latch at the bottom of the control module's front panel and slide out the control chassis.
3. Locate the slide-type switch SW101 {PROTECT} on the left circuit board. Slide it to ON.
4. Slide the chassis back into the control module's housing.

Tamper protection will now be enabled.

5-9 Changing the Display from Fahrenheit to Centigrade

To change the display from the factory °F setting to °C:

1. Disconnect main electrical power to the dryer.



2. Press up the latch at the bottom of the control module's front panel and slide out the control chassis.
3. Locate DIP switch SW201 {FUNCTION} on the right circuit board.
4. Slide the #5 pin to OFF.
5. Slide the chassis back into the control module's housing.
6. Cover the °F label with the °C sticker included in the information packet.

5-10 Setting the Dewpoint Extend Shift Point

1. 350 - 2100 cfm dryers shift air flow from the on-line desiccant bed to the regenerated desiccant bed based on actual dewpoint demand, not by fixed time cycles.
2. Set the Dewpoint Shift Point to the highest process air moisture content you would like to allow before the dryer shifts air flow to the regenerated desiccant bed.
3. The Dewpoint Shift Point is set with the dewpoint meter, the Push To Set push-button, and the Dewpoint Shift Adjust potentiometer [pot].

To Change the Dewpoint Shift Point:

1. Carefully loosen the locking hex nut on the Dewpoint Shift adjust pot. The pot is just below the dewpoint meter.
2. Press and hold the Push To Set push-button next to the Dewpoint Shift Adjust pot.
3. With a small screwdriver, adjust the Dewpoint Shift Adjust pot until the dewpoint meter reads the highest acceptable process air dewpoint. This is the point that airflow will be shifted from the on-line bed to the regenerated bed, providing the regeneration cycle has been completed.
4. Release the Push To Set push-button and re-tighten the locking nut on the Dewpoint Shift Adjust pot.

Note: *Don't let the adjusting screw move and change the setting.*

5. Reconfirm the Dewpoint Shift Point by pressing the Push To Test push-button.

Note: *Securely lock the Dewpoint Shift Adjust pot in place with the locknut. An inadvertent change in the pot's setting will cause a change in the Dewpoint Shift Point.*

5-11 Regeneration Monitoring System Signal Processor

Dryer models 350 through 2100 have a 1/8 DIN signal processor that monitors the bleed air discharged from the desiccant tower being regenerated. The signal processor has four programmable temperature setpoints that, when reached, signal the PLC to cycle through the regeneration process. The PLC interprets the outputs from the signal processor depending on the part of the regeneration process currently underway.

The signal processor's setpoints are factory set for efficient operation in most situations. The manufacturer does not recommend changing the setpoints indiscriminately, but persons knowledgeable of the processing system may fine tune the setpoints for decreased energy consumption.

LL Setpoint - Low Regeneration Alarm Setpoint - 130°F

This setpoint alerts the PLC and operator to possible regeneration heater problems. If this bleed air temperature is not reached within 30 minutes of the regeneration heaters being energized, the Low Regen Air Temp Alarm lights. The light will go out automatically when the setpoint is reached. The alarm can indicate burnt out regeneration heaters, or an extremely moist desiccant bed.

L Setpoint - Regeneration Blower Shutdown Temp - 160°F

After a desiccant tower has been regenerated, the regeneration blower continues to cool the desiccant until this setpoint is reached. The signal processor informs the PLC, and the PLC shuts down the regeneration blower to prevent loading the regenerated bed with ambient moisture.

H Setpoint - Optional Closed Loop Regeneration Cool Down Temp - 250°F

This setpoint output is used on dryers equipped with optional closed loop regeneration cool down. When this setpoint is reached, the output signals the PLC to shift the Wye valve in this device's aftercooler and the cooling water valve to close loop and cool the regeneration air. The very dry regeneration bleed air is directed back into the aftercooler where it is cooled to about 150°, and then back into regeneration blower inlet. This ensures that no moisture will be added to the desiccant bed until it goes back on line.



HH Setpoint - Heater Cut Off Temp - 300°F





This setpoint is the temperature at which the PLC is signaled to shut off the regeneration heaters because the desiccant is dry, and begin the cool down process.

Raising this setpoint will *not* significantly improve dryer performance, but merely increase energy consumption.

Basic information is listed below. For more detailed information, refer to the processor manual shipped with the dryer.

To change the Regeneration Monitor System Setpoints:

- Press  until the LED above the parameter to be changed (LL, L, H, or HH) is lit. The number value displayed is the selected parameter's current set point.
-
- Within 5 seconds, press  until the digit to be changed blinks.
- Press  until the desired number value is displayed in that digit position.

- Press  again to move one digit to the right. Then press  to display the desired value.
- Follow this procedure to set all four digits.
- When satisfied with the value displayed, press  to save the new value to the regeneration monitor's memory, and move on to the next parameter, if desired.
- Press  repeatedly to review the new settings.

5-12 Auxiliary Process Safety System (Optional)

This option provides an extra level of protection from hopper meltdown due to a runaway heat condition such as a fused heater contactor. When triggered, this system will drop out high voltage to all heater contactors and blowers. This drastic action, to protect the resin and the drying hopper, will only occur if a high temperature condition is not first handled by the ¼ DIN control [Section 4-1] on the dryer subpanel and/or the heater contactor(s) is/are fused.

This system must be manually reset by pressing the *OVERTEMP RESET* button after fixing the problem.

This option uses a signal processor identical to the one used in the regeneration monitoring system. It monitors the process temperature through a thermocouple mounted at the drying hopper inlet. Only one of the setpoints [H] is used. See Section 5-11 for instructions on setting the H setpoint.

The H setpoint should be the highest temperature tolerable at the drying hopper, before resin or drying hopper degradation occurs. This temperature varies depending on the resin and the drying temperature, but a suggested starting temperature is 75°F above the drying temperature.

5-13 Seven Day Timer (Optional)

The seven day timer can be programmed for weekly ON/OFF operation of up to sixteen setpoints. An internal battery back-up holds the settings in memory when the dryer is de-energized.













The dryer's Power toggle switch must be in the "ON" position for normal or programmed dryer operation.

- To bypass programmed operation, switch the manual override switch on the seven day timer to the "ON" position.
- To execute programmed operations, set the manual override switch on the seven day timer to the "RUN" position.
- To de-energize the seven day timer, set the manual override switch to the "OFF" position.









The dryer will not run if the timer switch is "OFF".

Program 1 is operational, Program 2 is not used.

Setting the Current Day of the Week, Hour and Minute:









1. Apply main power to the dryer.
2. Turn on the timer by sliding the left manual override switch to the "ON" position. The timer's memory is cleared on power up.
3. Press and hold  until  becomes visible and  blinks.
4. Press  or  until the current day of the week is displayed.
5. Press  to store the current day of the week in the timer's memory. The day of the week indicator will stop blinking.
6. The current hour indicator should now be blinking. Press  or  to set the current hour.
The time is set in a 24-hour format.
7. Press  to store the current hour in the timer's memory. The hour indicator will stop blinking.
8. Press  or  to set the current blinking current minute indicator.
9. Press  to store the current minute in the timer's memory. The minute indicator should stop blinking.

Setting the start up time:





1. Press and hold  until  is lit and the hour indicator is blinking.
2. Press  or  until the desired dryer start up hour is displayed. The start up time is set in a 24-hour format.
3. Press  to store the dryer start up hour in the timer's memory. The hour indicator will stop blinking.
4. Press  or  until the desired dryer start up minute is displayed. The minute indicator should be blinking.
5. Press  to store the start up minute in the timer's memory. The minute indicator will stop blinking.
6. Now the #1 output status indicator should be blinking. Press  to turn the output to the ON status.

7. Press  once. The hour and minute display returns to zeroes and the hour indicator should be blinking.

Setting the stop time:

1. Press  or  until the desired dryer shut down hour is displayed. The shut down time is set in a 24-hour format.
2. Press  to store the shut down hour in the timer's memory. The hour indicator should stop blinking.
3. Press  or  until the desired dryer shut down minute is displayed. The minute indicator should be blinking.
4. Press  to store the shut down minute in the timer's memory. The minute indicator will stop blinking.
5. Now the #1 output Status indicator should be blinking. Press  once to set the output to the OFF status.
6. Press  once. The hour and minute display will return to zeroes and the hour indicator should be blinking.

Set the days of the week for automatic operation:

1. Press . The Day of the Week indicator will appear and the Sunday indicator should be flashing.
2. Press  to automatically operate the dryer on Sunday, press  to prevent the dryer from automatically operating on Sunday. Reverse video - white characters on a black background indicates the day(s) selected for automatic operation. For example: 
3. Press  to store Sunday in the timer's memory. Proceed until all desired days of the week are set.

Put the timer into Run mode:

1. Press  until the current time appears. The colon between the hours and minute should be blinking. The timer is now in run mode and automatic operation will begin as programmed.

Chapter 6: Maintenance

6-1 Servicing the Process Air Filters (Models 350-700)

WARNING: Operating the dryer without the process air filters installed will void the warranty. Filter Cleaning is an important part of dryer maintenance.

Dryer models 350 through 700 have single high temperature [up to 350°F] cartridge cannister-type filter in the process air loop. It's mounted above the process blower on the rear of the dryer. This filter protects the centrifugal blowers from plastic fines being drawn in from the drying hopper. Regular filter cleaning will keep your dryer operating at peak efficiency.

The filter can be washed or blown out, but remember, the filter's dirt holding capacity is reduced with each washing. The risk of dirt reaching the clean side of the filter during cleaning, plus possible filter damage from high pressure washing or blowing makes washing a gamble.

Careful cleaning or washing can be done when the airflow restriction trips the dirty filter alarm. Filters should not be washed more than six times or used for more than a year, whichever comes first.

Use a detergent that won't damage the filter media. Such a detergent permits easy removal of dirt particles through flushing and rinsing. An effective detergent will remove the fine particles from the pores of the filter media.

The filter's manufacturer recommends FM 1400 washing compound. It is formulated specifically for air filter element cleaning. It is non-sudsing and works in hot or cold water. FM 1400 contains biodegradable synthetic detergents and is non-phosphate, non N.T.A. It is marketed by Filter Service Corp., 2603 A West Main, Farmington, New Mexico, [505] 326-1127.

6-2 Filter Cleaning/Replacement

- Turn off and/or lock out electrical power [and compressed air, if so equipped] to the dryer.
- Remove the hand knobs or threaded fasteners securing the filter access cover and remove the cover.
- Remove the nut on the center retaining rod to remove a filter cartridge.
- Inspect the filter - a damaged filter should not be washed or reused.
- Remove loose dirt from the filter with compressed air or a water hose. Compressed air should be less than 100 psi – use a 1/8" diameter nozzle at least 2" away from the filter. Water should be less than 40 psi – don't use a nozzle.
- Soak the filter in FM 1400 or comparable detergent solution for at least 15 minutes. Never soak more than 24 hours.
- Swish the filter around in the solution to agitate, loosen dirt particles, and put them in suspension.
- Rinse the filter from the "clean" side to the "dirty" side with a gentle stream of water

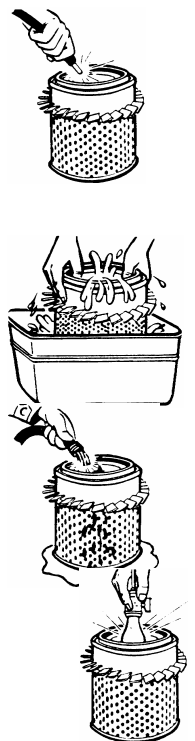

to remove all dirt and suds (less than 40 psi, no nozzle). If the clean or downstream side of the filter has been contaminated with dirty water during the soak cycle, rinse from both sides.

- Dry the filter before re-using. Circulate warm air at less than 160°F. **Do not use a light bulb to dry the filter.**
- Inspect for holes and tears by looking through the filter toward a bright light. Check for damaged gaskets or dented metal parts. Do not re-use a damaged filter.

6-3 Servicing the Process Air Filters (Models 850 through 2100)

On 850 through 2100 cfm dryers, the multiple high temperature [up to 350°F] process filters are located in the housing under the blower platform on the left rear corner of the dryer. These filters protect the centrifugal blowers from plastic fines being drawn in from the drying hopper. Regular filter cleaning will keep your dryer operating at peak efficiency.

Filter Cleaning/Replacement

- Turn off and/or lock out electrical power [and compressed air, if so equipped] to the dryer.
- Remove the hand knobs or threaded fasteners securing the filter access cover and remove the cover.
- Remove the nut on the center retaining rod to remove a filter cartridge.
- Blow or vacuum each filter until the filter is clean. If the filter is worn through or can't be cleaned, replace it.
- Remove the small fines cleanout cover from the lower back portion of the filter unit below the air outlet transition.
- Vacuum out the fines and reinstall the cover and gasket.
- Reinstall all the filter cartridges, tightening them securely.
- Replace the door or access cover, being careful to keep the gasket intact, if supplied.

Recommendations for Cleaning Heavily Soiled 850 through 2100 cfm Process Filters

Vacuuming

Try vacuum cleaning a soiled filter first. Vacuuming removes most large particles and surface contaminants, and may be all that's needed the first time a filter is cleaned. Use a commercial duty [recommended] or household vacuum cleaner. Vacuum the filter from the air intake [dirty] side only.

Compressed Air Cleaning

Blow clean, dry compressed air up and down the pleats, blowing out the filter from the clean side. Don't shoot the air in a criss-cross motion against the grain of the pleats - you won't end up with a clean filter, and you might damage it.

Washing

As a last resort, wash the filter. This is only necessary when the pressure drop is too high due to fine dirt embedded in the filter or there's been oily mist near the intake air location. Use a mild, low sudsing detergent and warm water. Soak the filter 5–10 minutes, then gently agitate for several minutes. Rinse thoroughly with clean water to remove all detergent. Let the filter dry completely before returning it to

service. Satisfactory filtration should be obtained through the second or third washing , however the dirt holding capacity of the filter decreases after each washing.

After Each Cleaning:

- Inspect the filter element – hold a light bulb behind the element to find fatigued paper or residual dirt.
- Inspect the end plates – damage here could allow air to bypass the filter.
- Look for rust on the end plates and metal core – rust particles could flake off and contaminate the dryer and resin.
- Check the gasket for damage – a damaged gasket will allow contaminants into the process. Replace if needed.

6-4 Servicing the Regeneration Filter

WARNING:

***Operating the dryer without the regeneration air filters installed will void the warranty.
Filter Cleaning is an important part of dryer maintenance.***

These dryers are equipped with a filter in the regeneration air loop. Regular filter cleaning will keep your dryer operating at peak efficiency.

To Clean the Regeneration Filter:

- Turn off and/or lock out electrical power to the dryer.
- Slide the panel filter out of its housing.
- Vacuum or carefully blow out the filter with compressed air. If the filter is worn or can't be cleaned, replace it.
- Slide the filter back into its housing.

6-5 Dirty Filter Alarm Calibration

Dryer models 350-2100 may be equipped with an optional Dirty Filter Indicator. When this indicator lights, it is time to clean or change the filter. The Dirty Filter indicator is tested and calibrated at the factory, but it can be adjusted in the field.

1. Be sure that your filter is clean, and use the following procedure.
2. Remove the process air return filter element from its housing.
3. Block off approximately 50% of the filter's surface area to simulate a dirty filter.
4. Reinstall the cartridge and secure the cover.
5. While the process blower is operating, adjust the trim screw on the differential pressure switch until the alarm light just comes on.
6. Remove the restricted filter cartridge from the housing again. The alarm light should stay off when the process blower operates if the switch is adjusted correctly.
7. Re-install the obstructed cartridge filter. The alarm light should go on again if the switch is adjusted correctly.
8. Fine tune the switch setting so it consistently warns of a blocked filter and does not falsely indicate a blockage of a clean filter.

9. Remove the restriction from the filter element and re-install the clean filter. The alarm light should remain off.

6-6 Dewpoint Control System Service

The Dewpoint Shift feature on dryer models 350 through 2100 depends on the proper operation of the dewpoint sensor and its control board. The dewpoint sensor is in the process airstream and is therefore susceptible to contamination.

Dewpoint sensor life is dependent on:

- Air temperature and flow passing over the sensor.
- The amount of fines [dust] in the process air.
- The amount of plasticizer vapor in the process air.

The dryer operator should monitor the initial dewpoint sensor readings and establish a periodic replacement schedule as needed.

Note: *Note: Do not attempt to check the continuity or resistance of a dewpoint sensor. The sensor will be destroyed.*

If you suspect that the dewpoint readings on the dewpoint meter are incorrect, a dewpoint simulation calibrator is available from the manufacturer [part number A0549143]. This device simulates various dewpoint outputs. It can confirm proper operation of the dewpoint sensor and dewpoint system control board.

To check the dewpoint sensor and dewpoint control board:

1. Remove the sensor cable from the sensor hex nut adapter.
2. Connect the cable to the plug on the rear of the simulator.
3. Turn the rotary knob on the simulator to each position and note the readings on the dewpoint meter on the dryer's control panel. The readings should correspond within a degree or two across the entire range.
4. If the readings agree, the control board is OK. Dewpoint sensor replacement is recommended. If the readings do not agree, replace the control board and run the test again to rule out the possibility of a bad sensor.

Do not attempt to make any adjustments to the components on the dewpoint control board.

5. When testing is finished, re-connect the control cable to the sensor adapter.

6-7 Symptoms of Worn Out Desiccant

The moisture adsorption capacity of the desiccant used in ACS dryers degrades after an indefinite period of time. Useful life depends on variables such as material moisture content, plasticizer vapors in the return air and number of regeneration cycles.

Your dryer may need new desiccant if it exhibits any of the following symptoms:

- The plastic material is not being dried sufficiently (high scrap/reject rate).
- The air temperature at the top of the regenerating desiccant bed rapidly climbs to 350°F or more shortly after the start of regeneration, even though a saturated bed has just started heating.
- The process air dewpoint, measured with a portable dewpoint monitor, is higher than -10°F throughout the process drying cycle.
- Smoke or dust is being blown out of the process air outlet.

- Noticeable amounts of desiccant in the beds is a medium-brown color, or darker.

If any of these signs are noticed, the desiccant in the desiccant beds should be replaced. Desiccant replacement kits are available from the Parts Department. If you wish, the desiccant beds can be repacked at your site by a technician.

WARNING
DESICCANT MATERIAL CAUSES EYE IRRITATION
BREATHING MAY BE HARMFUL/MAY CAUSE SKIN IRRITATION

- Do not get in eyes.
- Avoid prolonged contact with skin.
- Use with adequate ventilation.
- Wash thoroughly after handling.

FIRST AID:

In case of eye contact, immediately flush eyes with plenty of water for at least 15 minutes. If irritation persists, see a physician.

6-8 Desiccant Replacement Procedure

Follow the procedure below to change the desiccant.

1. Disconnect electrical power to the dryer.
2. Remove the bolts and nuts securing the cover of each desiccant tower. Remove the covers with a lifting fixture.
3. With a shop vacuum, carefully remove all desiccant from each tower.
4. Inspect each lower desiccant screen for tears or burn-through spots. Replace if necessary.
5. After cleaning each tower, add a level layer of half the large bead desiccant on top of the screen. Next, carefully add the full amount specified "per bed" of small bead desiccant. Smooth the top level, and finally add another layer of the remaining large bead desiccant to the top. Make sure this layer is level and smooth.
6. Repeat the above step for the other bed.
7. Inspect the gasketing on each of the covers. Replace if necessary.
8. Re-install the covers.

Figure 6: Desiccant Amounts Required

Dryer Model	Desiccant Required per Tower		
	Large Bead	Small Bead	Total
350	30	76	106
350-RT	30	76	106
425	30	90	120
425-RT	30	90	120
500	40	100	140
500-RT	40	100	140
600	40	120	160
600-RT	40	120	160
700	40	35	175
700-RT	40	35	175
850	120	120	240
850-RT	120	120	240
1000	120	130	250
1000-RT	120	130	250
1250	120	180	300
250-RT	120	180	300
1500	120	240	360
1500-RT	120	240	360
1800	120	310	430
1800-RT	120	310	430
2100	120	360	480
2100-RT	120	360	480

6-9 Process Heater Replacement Procedure

ACS dryers have a number of single phase Calrod-type heater elements wired in a delta formation. They are mounted in the vertical compartment behind the right hand desiccant tower. The number and wattage of the heaters varies with model, voltage, temperature range, etc., but the replacement procedure is the same.

WARNING! *Disconnect and lock out power before heater replacement.*

1. Remove the bolts securing the process heater access cover.
2. Sketch the heater wiring configuration so the heaters may be re-wired properly. Heaters are mounted on a common plate of three or six for easy maintenance.
3. Remove the jumper bars and wires for the heater plate assembly(ies) being removed or replaced.
4. Remove the bolts securing the heater plate assembly and slide out the assembly. Avoid damaging the gasketing.
5. Remove individual heaters for replacement by removing the large brass nuts and washers.
6. Re-install the heaters and heater plate assemblies in reverse order, replacing gaskets if necessary.

Caution! *Heater loops should not touch each other. "Hot spots" will lead to premature heater failure.*

7. Re-install the jumper wires and bars according to the sketch made earlier.
8. Re-secure the process heater access cover.

6-10 Regeneration Heater Replacement Procedure

Dryer models 350 through 2100 Dryers have four or eight three-phase regeneration heaters wired in the wye formation mounted in the insulated box directly above the lower valve.

WARNING! **WARNING! Disconnect and lock out power before heater replacement.**

1. Access the regeneration heaters from the rear of the dryer. Remove the cover plate secured by two bolts.
3. Sketch the heater wiring configuration so the heaters may be re-assembled properly. Also, note that the loops of the heaters are vertical to prevent drooping when hot.
4. Remove the jumper wires for the heater(s) being removed and/or replaced.
5. Remove the four bolts securing each heater's 3 1/2" mounting plate. Slide out the heater, taking care to not damage the gasketing.
6. Re-install the new heaters in reverse order. Be sure their loops are vertical, like the original heaters were. Securely tighten all fasteners.

Caution! **Caution! The heater loops should not touch each other. This will create "hot spots" and lead to premature heater failure.**

7. Re-install the jumper wires according to the sketch made earlier.
8. Re-secure the regeneration heater access cover.

6-11 Restoring a Temperature Controller to the Factory Setup

If the control's pre-set parameters have been tampered with and it will no longer control, try restoring the factory set up:

1. Turn off the power switch on the graphic display and remove all electrical power to the dryer.
2. Press up the latch at the bottom of the module's front panel and slide out the control chassis.
3. Locate the slide-type lockout switch [SW101 {PROTECT}] on the left circuit board. It should be Off.



4. Check to make sure the control output relays are installed on the right-hand circuit board. Dryers use one E53-S Solid State Relay (SSR) mounted in the socket marked S201 (HEAT). This relay switches the heaters on and off.
5. Set the output selector switch SW202 to PULSE. This slide-type switch is near the control output socket. If the dryer is equipped with an S.C.R. controller [an E53-C output module is installed], set the switch to Current.
6. Set the rotary-type alarm mode selector switch SW203 to position 2 for upper limit alarm.

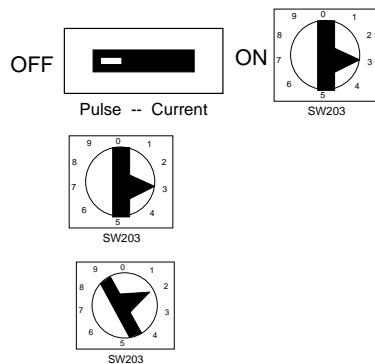

7. Set the rotary-type ALM2 switch SW203 to position 3 for lower limit alarm.
8. Set the rotary temperature sensor selector switch to position 2. It is marked SW206 (INPUT TYPE) and is on the right circuit board. ACS Dryers are factory-equipped with type K thermocouples; 6 other temperature sensor types can be used if the switch is properly set. These are listed below.

Display Characters	Sensor Type	Switch Position	Temp Range	
			°C	°F
	Thermocouple Type R	0	0 - 1,700	0 - 3,000
	Thermocouple Type S	1	0 - 1,700	0 - 3,000
	Thermocouple Type K	2	-200 to 1,300	-300 to 2,300
	Thermocouple Type J	3	-100 to 900	-100 to 1,600
	Thermocouple Type T	4	-200 to 400	-300 to 700
	Thermocouple Type E	5	0 to 600	0 to 1,100
	Platinum RTD (JIS 1981)	6	-99.9 to 450.0	-99.9 to 800.0
	Platinum RTD (DIN)	7	-99.9 to 450.0	-99.9 to 800.0
	Not Used	8		
	Not Used	9		

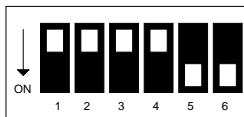

9. Set both transmission output selector DIP switches OFF. They are marked SW207 (TRANSFER) and are on the right circuit board on controls equipped with optional communications. See the Communications Manual [part number A0535959].



10. The function selector DIP switch [SW201 (FUNCTION)] selects 6 control modes. It is on the right circuit board. Put this switch in the set-up configuration at right while inputting the initial control parameters.

SW201 Set-up Configuration	
1 OFF	Control Mode
2 OFF	Normal/Reverse Output
3 OFF	Input Shift
4 OFF	Temperature Sensor Standard
5 ON	Scale Indication
6 ON	PID Constant Indication

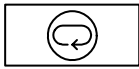
11. Slide the control chassis back into the control housing. The remaining parameters are set with the keypad.
12. Ready the dryer for startup with a real or simulated load. Restore the electrical power.
13. Turn the control power on. The PV LED will display four zeros [0000] and then display the current process air temperature.

14. Press  to page through the Level-0 control parameters. The PV LED displays codes indicating the currently selected mode; the SV LED shows the selected parameter's current setting. Use  and  to select a setting.

15. Set the Level-0 parameters according to Figure 10.

16. Press  for at least two seconds to access the Level-1 parameters. Set them using the procedure in the previous step.

Note: *You can proceed to Level-2, but these parameters are read- only. Controls with optional communications have user-set variables [unit address and ID] on Level-2.*

17. Turn off the power switch on the graphic display and remove all electrical power to the dryer.
18. Press up the latch at the bottom of the control's front panel and slide out the control chassis.

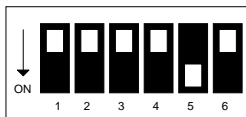



19. Set the #6 position of the DIP-type function selector switch to OFF. It is marked SW201 [FUNCTION] and is on the right circuit board. Slide the control back into the chassis.
20. Turn the control power on. The PV LED will display four zeros [0000] and seconds later display the current process temperature.
21. Auto-tune the dryer using the procedure in Section 5-6. If the control still fails to control, call the Service Department

Figure 7: Factory Pre-Set Control Parameters

Parameter Setting Levels	Parameter Description	PV LED Display	Dryer SV LED Setting
0	Display at Power Up	AL-2	10°F
	Alarm Range	P	10°F
	Proportional Bandwidth	L	90.0 Seconds
	Reset Time	d	20 Seconds
1	Rate Time	SL-L	0°F
	Lower Limit Value of Control Range	SL-H	250°F
	Dead Band	C-db	1°F
	Cooling Coefficient	C-SC	1.0°F
	Heating Control Period	CP	20 Seconds
	Cooling Control Period	C-CP	5 Seconds
	Shift Set Value	SP-S	0°F
2	Control Output Variable	0	Read Only
	Temperature Sensor Type	La-b	H CA
	Alarm Mode	AL-2	3-E
	Unit Number Setting w/Optional Communications	Un-5	Varies with Network
	Baud Rate Setting w/Optional Communications	bP-5	Varies With Network

Figure 8: Process Temperature Control Error Messages

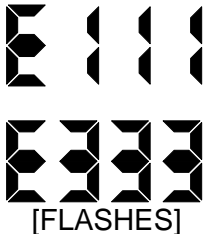
Message	Cause	Control Output		Alarm Output
		With output unit other than current output unit	With current output unit	
	Input temperature has risen beyond the upper limit of the temperature range by more than 20°C [68°F] ①	OFF during reverse (heating) action, ON during normal cooling action.	4 mA during reverse (heating) action, 20 mA during normal (cooling) action.	Issues alarm outputs in accordance with the set alarm mode.
	Input temperature has fallen below the lower limit of the temperature range by more than 20°C [68°F] ②	ON during reverse (heating) action, OFF during normal (cooling) action.	20 mA during reverse (heating) action, 4 mA during normal (cooling) action.	Issues alarm outputs in accordance with the set alarm mode.
	The thermocouple has burned out or the short circuit bar has been removed. The platinum RTD has burned out or A and B have been short circuited.	OFF	Approximately 1 mA	Issues alarm outputs in accordance with the set alarm mode. Proportional alarm output is OFF
	Memory failure (E111) or analog to digital converter failure (E333) has occurred. Temperature controller must be repaired if recovery is not made by turning power off once and on again.	OFF	Approximately 1 mA	OFF

① When a type J thermocouple is used, this error message is not displayed until the temperature has risen above the normal operating temperature operating range by more than 70°C [158°F].

② When a platinum RTD sensor is used, this message is displayed when the temperature has fallen to -99.9°C [-147.82°F].





Figure 9: Regeneration Monitor Signal Processor Error Messages

Item	Condition	Error Message	Output Status				Corrective Action
			Comparative Outputs	BCD Output	Linear Output	Communications	
Device Failure	CPU RAM error, external memory error, memory data error.		OFF	OFF	OFF	OFF	Turn the power OFF and then ON again once. If the error persists, call Service.
	Corrupted Data		OFF	OFF	OFF	OFF	Turn the power OFF and then ON again once. If the error persists, press the mode key and set all parameters again.
Sensor Error	Breakage or short circuit of sensor. When the thermocouple is used, terminals 11 and 13 are not short circuited.		OFF	OFF	OFF	OFF	Check sensors for breakage, short circuiting, or incorrect wiring.
Overflow, Underflow	Input value or display value outside range.	Display Blinks	Continues	Continues OVER ON	Continues	Continues OVER ON	Keep the input value and display value within the range.
Output Type Change	When output type has changed.		OFF	OFF	OFF	OFF	Check the output type. If correct, press the mode key. This erases the set parameters, so re-enter them. If the problem persists, call Service.
Output Type Error	Output type other than specified.		OFF	OFF	OFF	OFF	Turn the power OFF and then ON again once. If the error persists, call Service.
Input Specification Error	Input type other than specified.		OFF	OFF	OFF	OFF	Turn the power OFF and then ON again once. If the error persists, call Service.

6-12 Regeneration Monitor Advanced Programming

The regeneration monitor has three menu levels, numbered 0 through 2. Each menu level allows specific parameters to be viewed and/or set.

Moving Between Levels

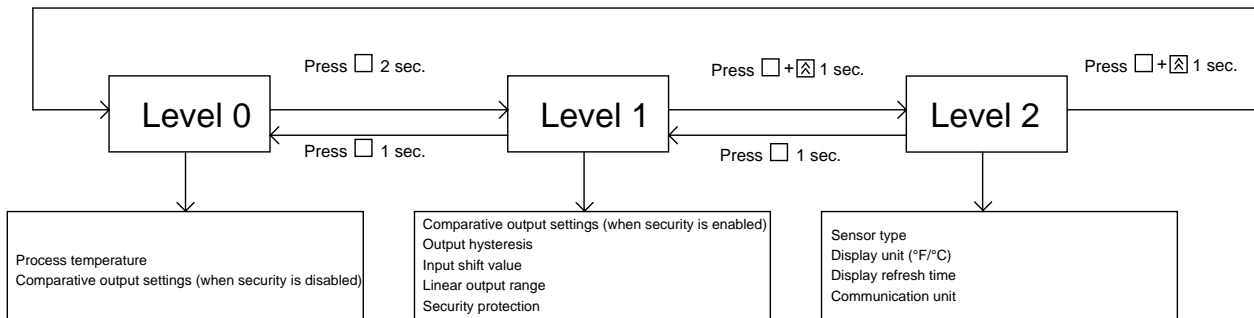

Level 0, the RUN mode, is the default and automatically appears when the dryer is powered up. To move to Level 1, press and hold  for 2 seconds. When Level 1 is reached, press and hold both  and  for 1 second to move up a level, or move back to RUN mode by pressing  for 1 second. See the flow chart below.





LEVEL 0

In this, the default level, the present regeneration bleed air temperature is displayed, plus the monitor's four setpoints can be viewed and changed.

If security is enabled, the setpoints cannot be changed. They may be reviewed by pressing .

If security is disabled, the setpoints can be changed on this level by using  and .

When the desired setpoint is displayed, press  to move to the digit you want to change, and use  to change the digit. Then press  to save the new setting to memory and to move on to the next setpoint.

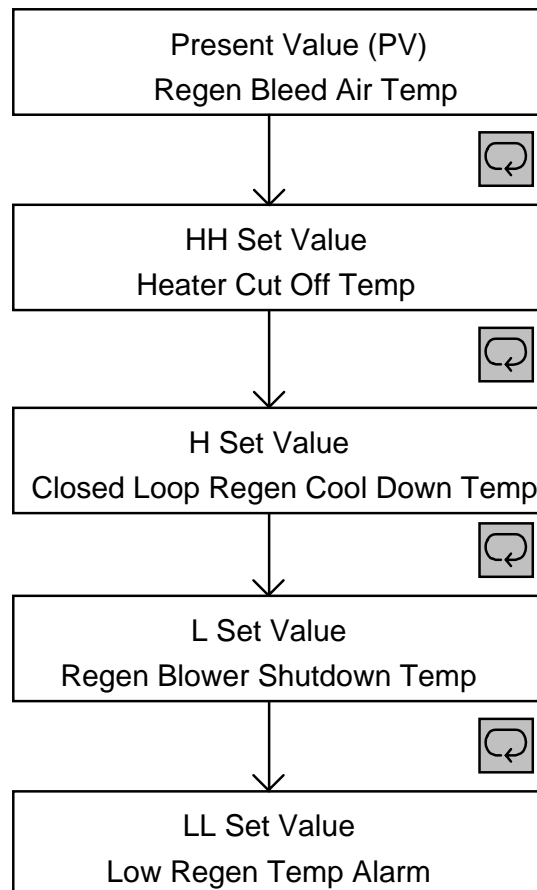



LEVEL 1

In this level, the four setpoints can be changed, plus Hysteresis, Input Shift and Security Protection can be set.

Use  to move from one parameter to the next.



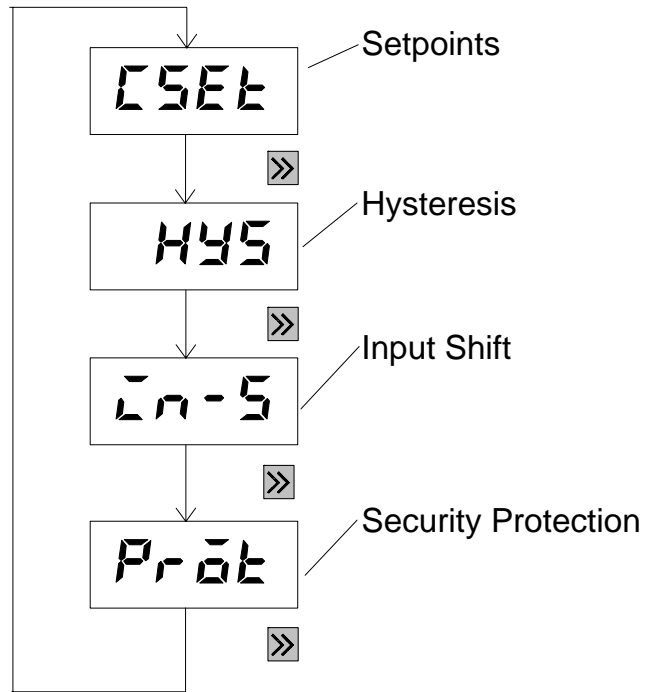

When the desired parameter appears on the LED display, press  to select that parameter for programming. The parameter's current value appears on the LED display.

When the desired parameter is displayed, use  and  to view and/or change the parameter. Then press  to save the new setting to memory, and to move on to the next parameter.







Setpoints - **CSEt**

When **CSEt** appears on the LED display, the HH, H, L, and LL setpoints can be changed even while security lockout is enabled.

To set the values, press  after **CSEt** appears. The present value for the HH setpoint will appear on the LED display. Use  and  to view and/or change the setpoint. Then press  to save the new setting to memory, and to move on to the next setpoint. After all setpoints are set, the LED display returns to **CSEt**.

Hysteresis - **HYS**





The hysteresis value for the setpoints can range from 0° to 99° C or F.

Press  after **HYS** appears on the LED display. Use  and  to set the value. Then press  to save the new setting to memory.

Input Shift - **Ln-S**



The input shift value can range from -99° to +99° C or F. The factory set value is “000”

The input shift value offsets the displayed temperature by the value you set here. This may be useful to force the regeneration monitor to display the same temperature as a known [or supposed] temperature reading.

Press  after **Ln-5** appears on the LED display. Use  and  to set the value. Then press  to save the new setting to memory.

Security Protection - Pr \bar{a} t

When Security Protection is enabled, the setpoints can't be changed when the Regeneration Monitor is in "RUN" mode. The setpoints can only be changed in Level 1 using the **CSEt** function.

Press  after **Pr \bar{a} t** appears on the LED display. Use  to toggle between ON and OFF. The factory setting is "OFF". When the selection has been made, press  to save the new setting to memory.

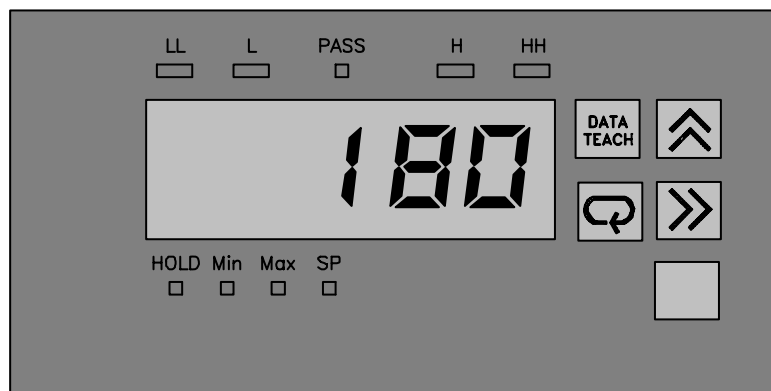

LEVEL 2

In this level, parameters such as the type of temperature sensor connected to the regeneration monitor, Fahrenheit/centigrade display, and display refresh cycle can be set.

» moves from one parameter to the next. When the desired parameter appears on the

LED display, press ↻ to select that parameter for programming. The current value of the parameter is then displayed on

the LED display. Use » and ⬆ to change

the setting. When you are satisfied with the new setting, press ↻ to save the new setting to memory.

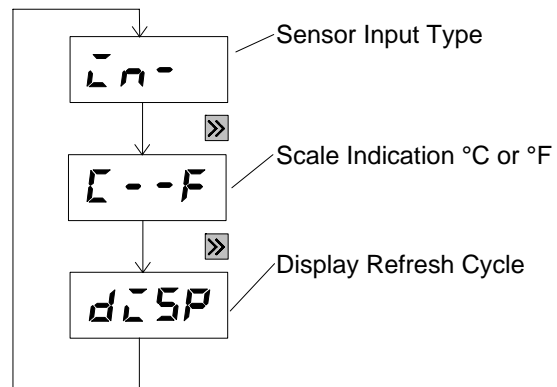

Sensor Input Type **K**

The regeneration monitor is factory equipped with and configured to use a type K thermocouple. Type R, S, J, L, T, U, E, and 100 W RTD's can also be used. The factory setting is **K**.

Press ↻ after **K** appears on the LED display. Use ⬆ to scroll through the available sensor types. Then press ↻ to save the new setting to memory. **8888**

Scale Indication **C--F**

The regeneration monitor can display the regeneration bleed air temperature in either Fahrenheit (°F, the factory default) or Celsius (°C). The control is factory set to the scale indicated on the dryer at the time of purchase.

Press ↻ after **C--F** appears on the LED display. Use ⬆ to toggle between the two choices. Then press ↻ to save the new setting to memory.

Display Refresh Cycle **dLSP**

The regeneration monitor's display refresh speed can be set separately from the sampling speed.

Press ↻ after **dLSP** appears on the LED display. Use ⬆ to toggle between the two choices: **FAST** (500 ms) or **SLOW** (2 seconds). Then press ↻ to save the new setting to memory. The factory setting is **FAST**.

Note: *Even if the display refresh speed is set to two seconds, the sampling times for the setpoints still remains at 500 milliseconds.*

Chapter 7: Troubleshooting

PROBLEM	POSSIBLE CAUSE	CORRECTIVE ACTION
Little or no air coming from process delivery tube.	A. Dirty Filters	A. Clean or replace filters.
	B. Desiccant beds contaminated by material or plasticizer leaking into the system. See Sec. 6-6.	B. Replace desiccant
	C. Blower fuse(s) blown.	C. Fix problem and Replace fuse(s).
	D. Overload tripped.	D. Fix problem and reset the overload.
	E. Blower fins filled with dust or contaminants.	E. Remove blower sideplate, clean baffles, replace.
Suction in delivery tube, pressure from the return tube.	A. Phase is reversed on power drop coming into the dryer.	A. Stop the Dryer. If the dryer was connected to the drying hopper, check to see if the desiccant and process air heater has been contaminated with resin. If so, replace the desiccant and remove any resin carry-over. Otherwise, change the phase of two legs of the three-phase power drop. Never change the phase at the motor starters unless only one of the two blowers is rotating improperly.

PROBLEM	POSSIBLE CAUSE	CORRECTIVE ACTION
Loss or reduction of process air temperature.	A. Process heaters are faulty.	A. Check for open or shorted heaters. Replace if required. Check the fuses.
	B. Solid-state temperature controller faulty.	B. Replace.
	C. Process temperature was adjusted in error by plant personnel.	C. Make sure that plant personnel are aware of the proper temperature setpoint. A sign posted next to the control would be helpful.
Loss or reduction in drying capacity.	A. Process heaters are faulty.	A. Replace.
	B. Desiccant beds are contaminated.	B. Replace desiccant.
	C. Material being dried differs from material specified at the time of purchase.	C. Drying systems are designed for the material which was originally specified. Different materials may need a longer residence time or different drying temperature.
	D. Break in flex hose to/from drying hopper.	D. Inspect for air leaks; replace if necessary.
	E. Airflow valves sticking or failing to shift.	E. Check for proper operation of linear valve actuator. Check fusing. Repair or replace if necessary.
	F. Blower fins filled with dust or contaminants.	F. Remove blower sideplate, clean baffles, replace. Replace filter elements.

PROBLEM	POSSIBLE CAUSE	CORRECTIVE ACTION
Material in drying hopper cakes, or meltdown occurs.	A. Process temperature set too high due to operator error.	A. Check resin manufacturer's data sheet for proper drying temperature. Make sure plant personnel are aware of the correct process temperature Set Point.
	B. High temperature alarm not set properly.	B. See Section 5-5.
	C. Process set point is out of acceptable range.	C. Restore temperature controller to factory pre-sets. Auto-Tune if necessary. See Sec. 6-11.
Poor Dew Point Performance.	A. Burned out regeneration heater.	A. Repair or replace.
	B. Contaminated or worn out desiccant.	B. Replace.
	C. Leaking process air hoses.	C. Repair or replace.
	D. Dryer is being operated beyond its capacity.	D. Check dryer and drying hopper sizing.
	E. Bad dew point sensor.	E. Replace.
	F. Fouled dew point sensor manifold.	F. Clear obstruction. Air should flow freely through sensor.

Chapter 8: Appendix

8-1 Returned Material Policy

Credit Returns

Prior to the return of any material, **authorization** must be given by the **manufacturer**. A RMS number will be assigned for the equipment to be returned.

Reason for requesting the return must be given.

All returned material purchased from the manufacturer is subject to a 15% (\$75.00 minimum) restocking charge.

All returns are to be shipped prepaid.

The invoice number and date or purchase order number and date must be supplied.

No credit will be issued for material that is not within the manufacturer's warranty period and/or in new and unused condition, suitable for resale.

Warranty Returns

Prior to the return of any material, **authorization** must be given by the **manufacturer**. A RMS number will be assigned for the equipment to be returned.

Reason for requesting the return must be given.

All returns are to be shipped prepaid.

The invoice number and date or purchase order number and date must be supplied.

After inspecting the material, a replacement or credit will be given, at the **manufacturer's** discretion, if the item is found to be defective in materials or workmanship. Purchased components are covered under their specific warranty terms.

-Notes-

Preventive Maintenance Checklist

Dehumidifying Dryers

Dryer Model #	Serial #
---------------	----------

EVERY WEEK	Date/By	Date/By	Date/By	Date/By	Date/By	Date/By	Date/By	Date/By	Date/By	Date/By	Date/By	Date/By	Date/By
Inspect all filters for wear, replace/clean if dirty or worn													
Check air regulator to make sure pressure is 60-80 psi. [If applicable]													

EVERY MONTH	Jan	Feb	Mar	Apr	May	Jun	Jul	Aug	Sep	Oct	Nov	Dec
Lock out electrical power and inspect electrical wiring for integrity												
Lock out electrical power and check heater elements for continuity using an ohmmeter												
Check Dew point and temperature tracking with an external dew point monitor and pyrometer												
Visually inspect the shifting of the airflow valve during one cycle												

EVERY YEAR	Next Scheduled Inspection	Actual Inspection Date/By	Next Scheduled Inspection	Actual Inspection Date/By
Inspect desiccant. Replace if brown or broken				

EVERY 2 YEARS	Scheduled Replacement Date	Actual Replacement Date/Work Done By	Scheduled Replacement Date	Actual Replacement Date/Work Done By
Replace desiccant				

8-2 Technical Assistance

Parts Department

Call toll-free 7am–5pm CST [800] 423-3183 or call [262] 641-8610 Fax: [262] 641-8653

The ACS Customer Service Group will provide your company with genuine OEM quality parts manufactured to engineering design specifications, which will maximize your equipment's performance and efficiency. To assist in expediting your phone or fax order, please have the model and serial number of your unit when you contact us. A customer replacement parts list is included in this manual for your convenience. ACS welcomes inquiries on all your parts needs and is dedicated to providing excellent customer service.

Service Department

Call toll-free 8am–5pm CST [800] 423-3183 or call [262] 641-8610
Emergencies after 5pm CST, call [847] 439-5655

We have a qualified service department ready to help. Service contracts are available for most products. Service contracts are available for most of our products.

Sales Department

Call [262] 641-8610 Monday–Friday, 8am–5pm CST

Our products are sold by a world-wide network of independent sales representatives. Contact our Sales Department for the name of the sales representative nearest you.

Contract Department

Call [262] 641-8610 Monday–Friday, 8am–5pm CST

Let us install your system. The Contract Department offers any or all of these services: project planning; system packages including drawings; equipment, labor, and construction materials; and union or non-union installations.

Sterling, Inc.
2900 S. 160th Street
New Berlin, WI 53151
www.sterlco.com