

Grizzly Industrial, Inc.®

16 GAUGE STAPLER KIT

MODEL G6044/G6772

INSTRUCTION MANUAL



Model G6772 shown here

COPYRIGHT © MAY, 2002 BY GRIZZLY INDUSTRIAL, INC.

1821 VALENCIA ST., BELLINGHAM, WA 98227

WARNING: NO PORTION OF THIS MANUAL MAY BE REPRODUCED IN ANY SHAPE OR FORM WITHOUT THE WRITTEN APPROVAL OF GRIZZLY INDUSTRIAL, INC.

PRINTED IN TAIWAN

SAFETY

WARNING

For Your Own Safety Read Instruction Manual Before Operating This Equipment

The purpose of safety symbols is to attract your attention to possible hazardous conditions. This manual uses a series of symbols and signal words which are intended to convey the level of importance of the safety messages. The progression of symbols is described below. Remember that safety messages by themselves do not eliminate danger and are not a substitute for proper accident prevention measures.



Indicates an imminently hazardous situation which, if not avoided, WILL result in death or serious injury.



Indicates a potentially hazardous situation which, if not avoided, COULD result in death or serious injury.



Indicates a potentially hazardous situation which, if not avoided, MAY result in minor or moderate injury. It may also be used to alert against unsafe practices.



This symbol is used to alert the user to useful information about proper operation of the equipment.

WARNING

Safety Instructions For Pneumatic Tools

1. **KEEP ALL SAFETY DEVICES IN PLACE** and in working order.
2. **REMOVE ADJUSTING KEYS AND WRENCHES.** Form habit of checking to see that keys and adjusting wrenches are removed from tool before operation.
3. **KEEP WORK AREA CLEAN.** Cluttered areas and benches invite accidents.
4. **DO NOT USE IN DANGEROUS ENVIRONMENT.** Do not use pneumatic tools in damp or wet locations, or where any flammable or noxious fumes may exist. Keep work area well lighted.
5. **KEEP CHILDREN AND VISITORS AWAY.** All children and visitors should be kept at a safe distance from work area.
6. **MAKE WORKSHOP CHILD PROOF** with padlocks, master switches, or by removing air hoses from tools.
7. **DO NOT FORCE TOOL.** It will do the job better and safer at the rate for which it was designed.
8. **USE THE RIGHT TOOL.** Do not force tool or attachment to do a job for which it was not designed.
9. **DO NOT USE UNDER THE INFLUENCE OF DRUGS OR ALCOHOL.**

WARNING

Safety Instructions For Pneumatic Tools

10. **USE PROPER AIR HOSE** for the tool. Make sure your air hose is in good condition and is long enough to reach your work without stretching.
11. **WEAR PROPER APPAREL.** Do not wear loose clothing, gloves, neckties, rings, bracelets, or other jewelry which may get caught in moving parts. Non-slip footwear is recommended. Wear a protective hair covering to contain long hair.
12. **ALWAYS USE SAFETY GLASSES.** Also use a face or dust mask if cutting operation is dusty. Everyday eyeglasses only have impact resistant lenses, they are NOT safety glasses.
13. **WEAR APPROVED HEARING PROTECTION.**
14. **SECURE WORK.** Use clamps or a vise to hold work when practical. It is safer than using your hand and frees both hands to operate tool.
15. **DO NOT OVERREACH.** Keep proper footing and balance at all times.
16. **MAINTAIN TOOLS WITH CARE.** Keep tools lubricated and clean for best and safest performance. Follow instructions for lubricating and changing accessories.
17. **REDUCE THE RISK OF UNINTENTIONAL STARTING.** Do not carry tool with hand on trigger and always disconnect from air when not in use.
18. **DISCONNECT TOOLS** before servicing and changing accessories.
19. **USE THE RECOMMENDED ACCESSORIES.** Consult the owner's manual for recommended accessories. The use of improper accessories may cause risk of injury.
20. **CHECK DAMAGED PARTS.** Before further use of the tool, a guard or other part that is damaged should be carefully checked to determine that it will operate properly and perform its intended function. Check for alignment of moving parts, binding of moving parts, breakage of parts, mounting, and any other conditions that may affect its operation. A guard or other part that is damaged should be properly repaired or replaced.
21. **NEVER LEAVE UNATTENDED TOOL CONNECTED TO AIR.** Disconnect the air hose and do not leave tool until it is relieved of any built up pressure.
22. **NEVER ALLOW UNTRAINED USERS TO USE THIS TOOL WHILE UNSUPERVISED.**
23. **IF YOU ARE UNSURE OF THE INTENDED OPERATION, STOP USING THE TOOL.** Seek formal training or research books or magazines that specialize in pneumatic tools.

! WARNING

Basic Stapler Safety

In addition to the rules stated in the previous section, and those in the warning boxes throughout this manual, please observe the following safety tips for your new stapler:

1. **READ THIS ENTIRE MANUAL BEFORE OPERATING THE STAPLER.**
2. **ALWAYS DISCONNECT AIR FROM THE STAPLER** whenever servicing or installing staples. During maintenance, a stapler connected to air may fire accidentally, causing serious personal injury.
3. **DO NOT PLACE HANDS NEAR STAPLE POINT OF ENTRY.** Staple can deflect and tear through the surface of the workpiece, puncturing your hand or fingers.
4. **NEVER CONNECT THE STAPLER TO PRESSURIZED OXYGEN OR OTHER COMBUSTIBLE GASES** as a power source. Only use filtered, lubricated, and regulated compressed air.
5. **NEVER USE GASOLINE OR OTHER FLAMMABLE LIQUIDS TO CLEAN THE STAPLER.** Vapors in the tool will ignite by a spark and cause the tool to explode.
6. **DO NOT CARRY THE STAPLER BY ANY OTHER PART THAN THE HANDLE,** and do not carry the stapler by the air hose.
7. **DO NOT KEEP THE TRIGGER PULLED ON THE SAFETY YOKE MECHANISM WHEN CARRYING OR HOLDING THE TOOL.**
8. **DO NOT USE A CHECK VALVE OR ANY OTHER FITTING** that allows air to remain in the tool.

! WARNING

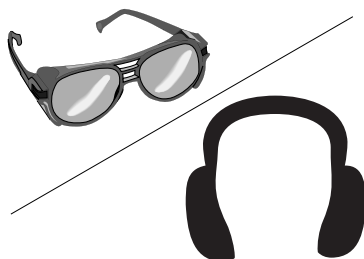

Operating this stapler can propel objects into the air, causing immediate eye damage. To protect yourself, always wear American National Standards Institute (ANSI) approved safety glasses or goggles when operating this equipment. In addition, this stapler discharges at 85-90 decibels. To protect your hearing, always wear ANSI approved ear protection when operating this stapler.

! WARNING



Never point this stapler at yourself or another person! Always pay attention to the direction this stapler is pointed. Use this tool with respect and caution to lessen the possibility of operator or bystander injury. Ignoring this warning may result in serious personal injury.

INTRODUCTION

Commentary

We are proud to offer the Grizzly Model G6044/G6772 16 Gauge Stapler. This model is part of a growing Grizzly family of fine power tools. When used according to the guidelines set forth in this manual, you can expect years of trouble-free, enjoyable operation and proof of Grizzly's commitment to customer satisfaction.

This stapler features a 360° adjustable exhaust, a quick release nose clamp, a convenient bottom-loading magazine, a safety trigger and a durable plastic carrying case. The Model G6044 shoots 7/16" wide staples and the Model G6772 shoots 1/2" wide staples. Both models shoot 16 gauge staples 5/8"-2" in length and have a capacity of 140 staples. Each model weighs 5.9 lbs.

We are pleased to provide this manual with the Model G6044/G6772. It was written to encourage safety considerations and guide you through general operating procedures and maintenance. This manual represents our effort to produce the best documentation possible.

The specifications, details, and photographs in this manual represent the Model G6044/G6772 as supplied when the manual was prepared. However, owing to Grizzly's policy of continuous improvement, changes may be made at any time with no obligation on the part of Grizzly. If you have any comments regarding this manual, please write to us at the address below:

Grizzly Industrial, Inc.
% Technical Documentation
P.O. Box 2069
Bellingham, WA 98227-2069

Most important, we stand behind our tools. If you have any service questions or parts requests, please call or write us at the location listed below.

Grizzly Industrial, Inc.
1203 Lycoming Mall Circle
Pennsdale, PA 17756
Phone: (570) 546-9663
Fax: (800) 438-5901

E-Mail: techsupport@grizzly.com
Web Site: <http://www.grizzly.com>



WARNING

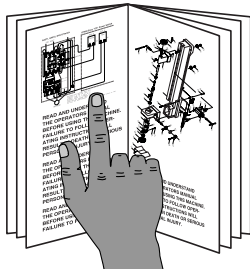

Read the manual before assembly and operation. Become familiar with this tool, its safety instructions, and its operation before beginning any work. Serious personal injury may result if safety or operational information is not understood or followed.

Compressed Air System

The Model G6044/G6772 is designed to be operated at 80-120 psi. **Do not exceed the maximum operating pressure!**

Before you use your new stapler, regulate the air pressure on your air compressor to barely over the minimum psi for your model. Increase air pressure only if needed.

Many pneumatic tools benefit from an in-line filter/lubricator/regulator unit. This attachment is connected by hoses between the air compressor and the stapler. Using this unit protects your tool from damaging water build-up, allows you to adjust and maintain constant air pressure to your tool, and saves you the inconvenience of having to manually lubricate your tool every time you use it. Check the current Grizzly catalog for availability of this unit. If you plan on installing a filter/lubricator/regulator unit in your compressed air system, always follow the connection instructions that come with the unit.

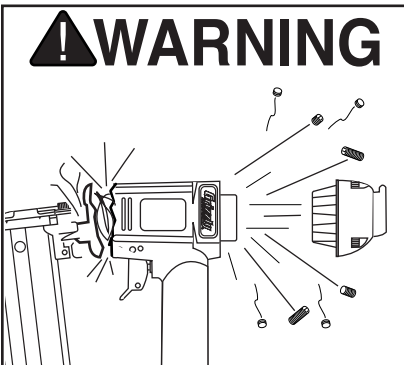

Exceeding the maximum permissible operating pressure may cause the stapler to explode, blowing metal fragments in all directions. To protect yourself from serious personal injury, DO NOT allow your air compressor to exceed the recommended pressure when connected to this stapler!

Safety Yoke Mechanism

A safety yoke mechanism on the nose of the stapler acts as a safety device. When the trigger is pressed, the stapler will not fire until the safety yoke mechanism is depressed.

Before you use your stapler for the first time, check the safety yoke mechanism to ensure proper function. To do this:

1. **Make sure the stapler is disconnected from the air supply!**
2. Make sure the magazine is empty and contains no staples.
3. Make sure the trigger and the safety yoke mechanism move up and down without sticking.
4. Connect the stapler to the air supply.
5. **Without pressing the trigger**, depress the safety yoke mechanism against a scrap piece of wood that is clean and free of any knots, staples, or other foreign objects. If the stapler does not fire, then the safety yoke mechanism is working correctly. If the stapler **does fire** when you do this, immediately disconnect the stapler from the air supply and call our customer service for help.

Similarly if the stapler fires when the trigger is pulled, **without the safety yoke mechanism being depressed**, then the stapler is not working properly.

If either of these two conditions develop after you have used your stapler for a period of time, check the lubrication of these mechanisms.

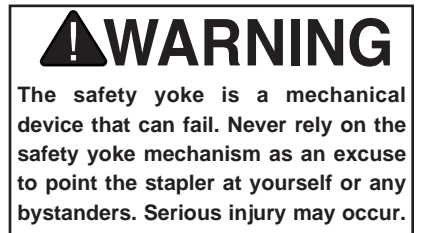

OPERATION

Loading Stapler

To load your stapler:

1. **Disconnect the air supply from the stapler!**
2. Pull the magazine pusher (shown in **Figure 1**) all the way to the back of the magazine until it snaps in place.

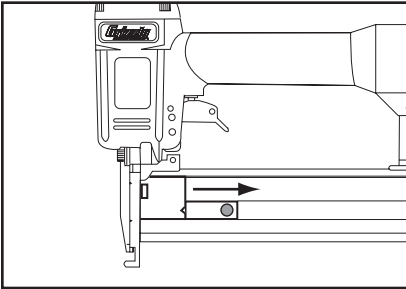

Figure 1. Pull magazine pusher back.

3. Point the stapler down and insert a stick of staples onto the magazine as shown in **Figure 2**. Make sure that the pointed ends of the staples point in the same direction as the stapler nose piece.

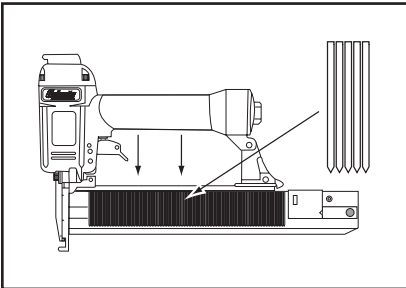

Figure 2. Loading staples onto stapler.

4. Release the plunger on the pusher while holding the pusher, so it does not spring forward out of control.
5. Carefully let the pusher come forward until it stops.

When replacing staples for your Model G6044/G6772, follow these guidelines:

Gauge: 16
Length: $\frac{5}{8}$ "-2"
Width: $\frac{7}{16}$ "
Capacity: 140 Staples

Single/Bump Fire Mode

The Model G6044/G6772 is equipped with a single/bump fire trigger.

To select single or bump fire operation:

1. **Disconnect the air supply from the stapler!**
2. Locate the hex nut that secures the safety yoke mechanism to the trigger housing. See **Figure 3**.
3. To select **Single Fire** mode, tighten the hex nut completely.
4. To select **Bump Fire** mode, unthread the hex nut at least two full turns.

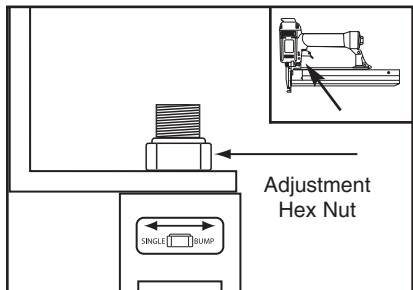

Figure 3. Loading staples into stapler.

Operating Stapler

If you have not read the safety instructions in this manual, do not operate the stapler.

Before the first operation, and periodically after that, place one drop of the included oil into the quick connect fitting where the stapler connects to the air supply. After oiling, wipe off any excess oil near the stapler exhaust to avoid dust build-up.

To operate your stapler:

1. Connect the air supply to the quick connect fitting.
2. Test the loaded stapler for proper penetration. Hold the stapler perpendicular to the surface of a piece of clean scrap wood that is thick enough for the length of staples you have loaded. Depress the safety yoke mechanism on your workpiece.
3. Before pressing the trigger, make sure your free hand is positioned out of the way of a potential path of a staple in case of deflection. (Deflection is caused when the staple changes its path, resulting in the staple puncturing the surface of the workpiece as shown in **Figure 4**.) Besides damaging your workpiece, deflection can cause injury if your free

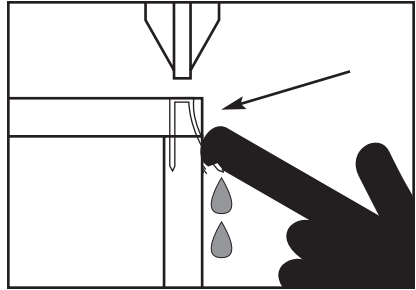

Figure 4. Example of staple deflection.

hand is securing the workpiece in the location that the staple deflects.

4. Press the trigger. If the staple drove into the wood far enough, continue with your intended operations. If the staple either went too far or not far enough, then adjust the air pressure. More air pressure will make the staple go deeper and less air pressure will decrease the staple penetration.

Clearing Jammed Staples

The most frequent situation that may occur with any type of stapler is a staple jam. A jammed staple must be cleared before using the stapler again. The two places where a staple can get jammed are the magazine and the discharge area.

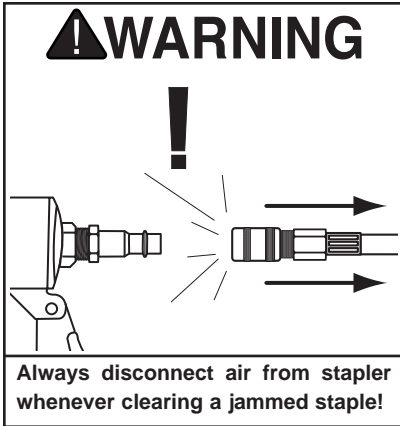

To clear a jammed staple from the magazine:

1. **Disconnect the stapler from the air supply!**
2. Pull the magazine pusher all the way back.
3. Locate and remove the jammed staple with a pair of needle nose pliers.
4. Place undamaged staples back on the magazine and engage the pusher.

To clear a jammed staple from the discharge area:

1. **Disconnect the stapler from the air supply!**
2. Remove all of the staples from the magazine.
3. Flip the quick release latch on the nose of the pliers, and remove from the nose as shown in **Figure 5**.
4. The jammed staple should now be visible; remove it from the discharge area with needle nose pliers.
5. Replace the quick release latch. Place undamaged staples back on the magazine and engage the pusher.

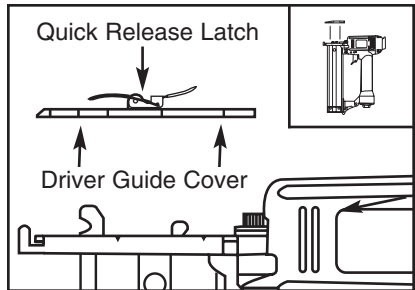

Figure 5. Removing guide cover.

Oiling Stapler

The Model G6044/G6772 is considered an oil-less model. This means it features a teflon piston assembly that does not require oil to operate. However, periodic applications of oil will extend the useful life of the piston assembly.

Special oil has been included with your new Grizzly stapler. Periodically place one drop of oil in the stapler air inlet (as shown in **Figure 6**). After oiling, wipe off any excess oil near the stapler exhaust to avoid dust build-up. When the oil that was included with the stapler has been completely used, replace with Grizzly Model G2820 Pneumatic Tool Oil.

Another option to manual oiling would be to install a lubricator in your air compressor line. If your air compressor line already has a lubricator, then regular lubrication of your stapler will not be necessary. Just make sure there is always oil in the lubricator.

As mentioned before, the best option is to install a filter/lubricator/regulator unit such as the Grizzly Model H2333 in your air line.

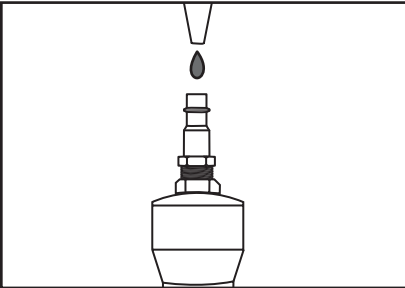

Figure 6. Lubricating stapler via air inlet.

NOTICE

Too much oil in the stapler will ruin the O-rings!

Cleaning Stapler

Use a good solvent to clean the nose assembly of the stapler. Always be sure that the stapler is dry before using it again.

Do not allow dust, chips, sand, etc. into the air connectors or into the body of the stapler; this may result in leaks and damage to the stapler and the air couplings.



Never use gasoline or other flammable liquids to clean this tool. Vapors in the tool may ignite, causing the tool to explode. Ignoring this warning may lead to serious personal injury or even death!

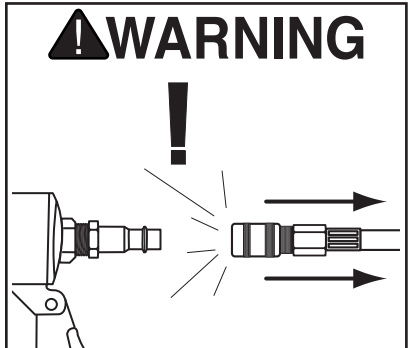

Always disconnect air from stapler whenever servicing! During maintenance, a stapler connected to air may fire accidentally, causing serious personal injury!

Replacing Pistons/O-Rings

If you use your stapler day in and day out, Grizzly offers repair pistons as cheap insurance against wasted down time and lost profits in the event that a piston or piston shaft becomes worn out. To replace a piston:

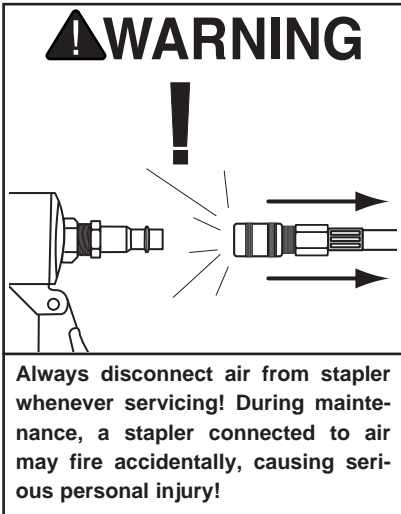

1. **Disconnect the stapler from the air supply!**
2. Remove all staples from the magazine.
3. Remove the 4 cap screws from the stapler exhaust cap.
4. Remove the exhaust cap as shown in **Figure 7**.
5. The top of the piston should now be visible inside the cylinder, which is housed in the head of the stapler.
6. Open the magazine.
7. Watch the discharge area and push the top of the piston with your finger. You will see the piston shaft slide down the discharge area.

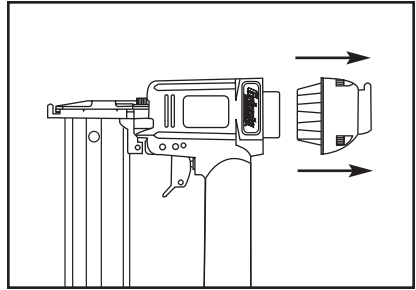
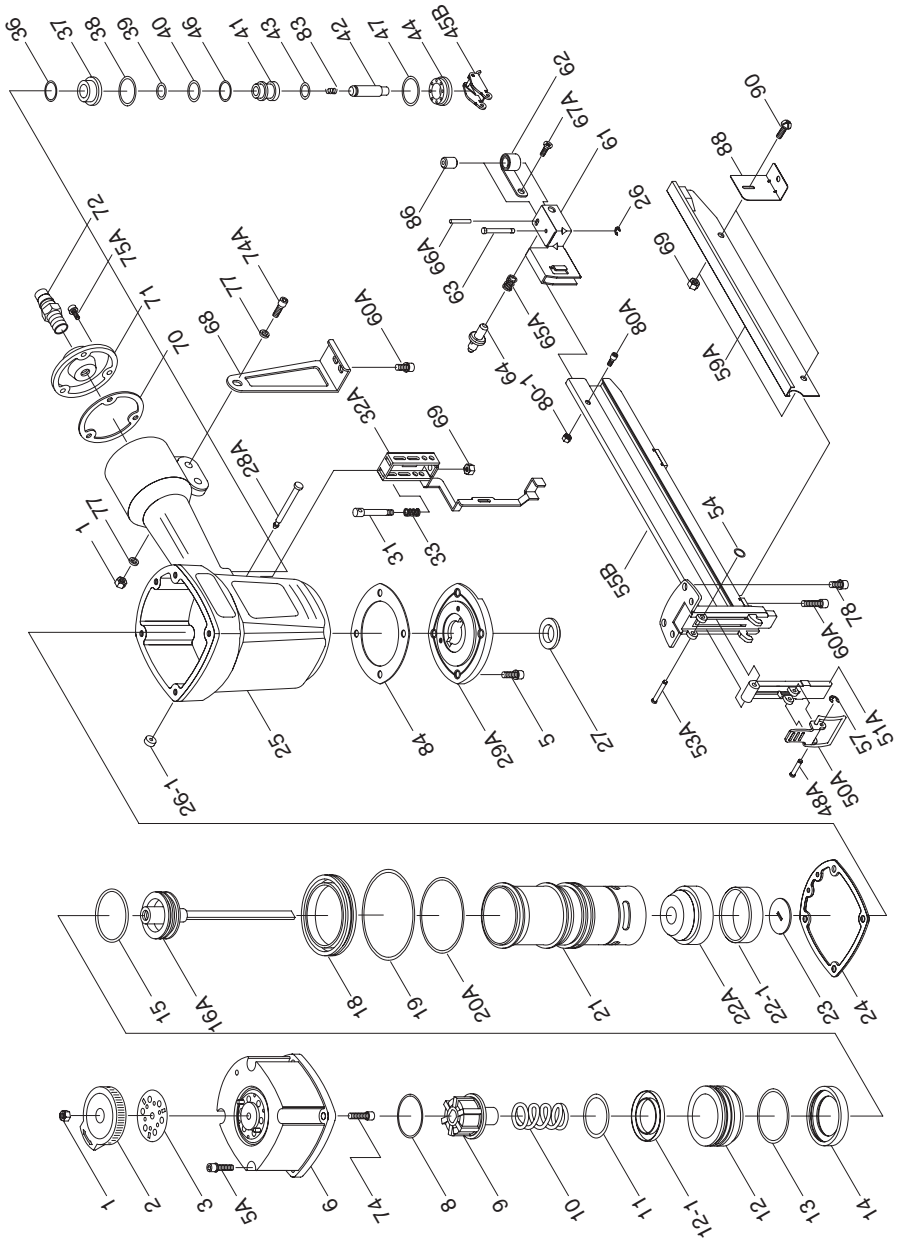

Figure 7. Removing stapler exhaust cap.

8. With a long flathead screwdriver or similarly shaped tool, push the piston shaft back inside the stapler until you can grip the piston head and remove it from the cylinder. (Be careful not to scratch the discharge area when pushing the piston shaft with the screwdriver.)
9. Place a new O-ring on the new piston and apply a thin film of the stapler lubricating oil on the O-ring.
10. Insert the new piston in the cylinder. Make sure that the grooves on the piston shaft line up with those on the nose guide at the bottom of the cylinder. The new piston should easily slide into the cylinder. **Do not force the piston into the cylinder!** If the piston is not easily inserted, double-check the alignment of the piston shaft with the grooves on the guide.
11. After the piston is inserted correctly, close the magazine. Replace the rear cap assembly and tighten the 4 cap screws.
12. For more assistance, or to install a complete O-ring set, refer to the appropriate breakdown diagram in the back of this manual.

MAINTENANCE NOTES

G6044 PART BREAKDOWN



REF	PART #	DESCRIPTION
01	P6044001	LOCK NUT
02	P6044002	EXHAUST COVER
03	P6044003	SPRING PLATE
05A	P6044005A	CAP SCREW
06	P6044006	CAP
08	P6044008	SPACER
09	P6044009	PISTON STOPPER
10	P6044010	SPRING
11	P6044011	O-RING
12	P6044012	PISTON HEAD VALVE
12-1	P6044012-1	SPACER
13	P6044013	O-RING
14	P6044014	SEAL
15	P6044015	O-RING
16A	P6044016A	PISTON ASSEMBLY
18	P6044018	CYLINDER SPACER
19	P6044019	O-RING
20A	P6044020A	O-RING
21	P6044021	CYLINDER
22A	P6044022A	BUMPER
22-1	P6044022-1	COLLAR
23	P6044023	WASHER
24	P6044024	GASKET
25	P6044025	BODY
26	P6044026	E RING
26-1	P6044026	PU RING
27	P6044027	SET BLOCK
28A	P6044028A	STEPPED PIN
29A	P6044029A	BOTTOM
31	P6044031	SPRING GUIDE
32A	P6044032A	SAFETY LEVER
33	P6044033	SPRING
36	P6044036	O-RING
37	P6044037	VALVE
38	P6044038	O-RING
39	P6044039	O-RING
40	P6044040	O-RING
41	P6044041	VALVE PLUNGER

REF	PART #	DESCRIPTION
42	P6044042	PLUNGER
43	P6044043	O-RING
44	P6044044	PLUNGER CAP
45B	P6044045B	TRIGGER ASSEMBLY
46	P6044046	O-RING
47	P6044047	O-RING
48A	P6044048A	STEPPED PIN
50A	P6044050A	LATCH
51A	P6044051A	GUIDE COVER
53A	P6044053A	STEPPED PIN
54	P6044054	O-RING
55B	P6044055B	GUIDE UNIT ASSY
57	P6044057	E RING
59A	P6044059A	COVER
60A	P6044060A	CAP SCREW
61	P6044061	PUSHER
62	P6044062	SPRING
63	P6044063	SHAFT
64	P6044064	STOPPER
65A	P6044065A	SPRING
66A	P6044066A	ROLLED PIN
67A	P6044067A	FLAT HD SCREW
68	P6044068	BRACKET
69	P6044069	LOCK NUT
70	P6044070	GASKET
71	P6044071	REAR COVER
72	P6044072	AIR PLUG
74A	P6044074A	CAP SCREW
75A	P6044075A	CAP SCREW
77	P6044077	FLAT WASHER
78	P6044078	CAP SCREW
80A	P6044080A	CAP SCREW
80-1	P6044080-1	LOCK NUT
83	P6044083	SPRING
84	P6044084	GASKET
86	P6044086	ROLLER
88	P6044088	COVER SUPPORT
90	P6044090	BUTTON HD CAP SCR

G6772 PART BREAKDOWN

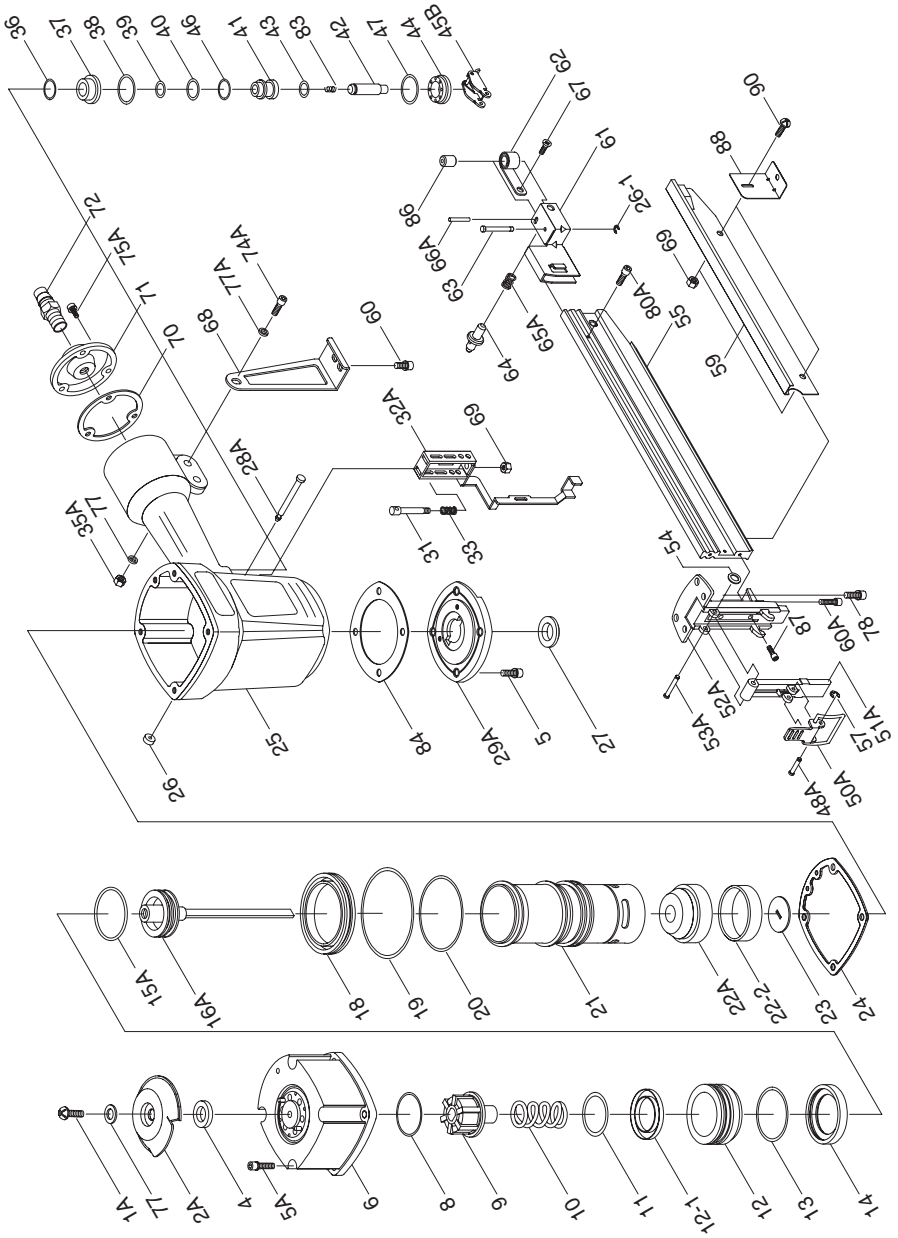

REF	PART #	DESCRIPTION
01A	P6772001A	BUTTON HD CAP SCR
02A	P6772002A	EXHAUST COVER
04	P6772004	PU WASHER
05A	P6044005A	CAP SCREW + SW
06	P6772006	CAP
08	P6772008	SPACER
09	P6772009	PISTON STOPPER
10	P6772010	SPRING
11	P6772011	O-RING
12	P6772012	PISTON HEAD VALVE
12-1	P6044012-1	SPACER
13	P6772013	O-RING
14	P6772014	SEAL
15A	P6044015	O-RING
16A	P6772016A	PISTON ASSEMBLY
18	P6772018	CYLINDER SPACER
19	P6772019	O-RING
20	P6772020	O-RING
21	P6772021	CYLINDER
22A	P6044022A	BUMPER
22-2	P6044022-1	COLLAR
23	P6772023	WASHER
24	P6772024	GASKET
25	P6772025	BODY
26	P6772026	PU RING
26-1	P6772026-1	E RING
27	P6772027	SET BLOCK
28A	P6044028A	STEPPED PIN
29A	P6044029A	BOTTOM
31	P6772031	SPRING GUIDE
32A	P6044032A	SAFETY LEVER
33	P6772033	SPRING
35A	P6772035A	LOCK NUT
36	P6772036	O-RING
37	P6772037	VALVE
38	P6772038	O-RING
39	P6772039	O-RING
40	P6772040	O-RING
41	P6772041	VALVE PLUNGER

REF	PART #	DESCRIPTION
42	P6772042	PLUNGER
43	P6772043	O-RING
44	P6772044	PLUNGER CAP
45B	P6772045B	TRIGGER ASSEMBLY
46	P6044046	O-RING
47	P6044047	O-RING
48A	P6044048A	STEPPED PIN
50A	P6772050A	LATCH
51A	P6772051A	GUIDE COVER
52A	P6772052A	NOSE
53A	P6772053A	STEPPED PIN
54	P6044054	O-RING
55	P6772055	GUIDE UNIT ASSY
57	P6044057	E RING
59	P6772059	COVER
60A	P6044060A	CAP SCREW
61	P6772061	PUSHER
62	P6772062	SPRING
63	P6772063	SHAFT
64	P6772064	STOPPER
65A	P6044065A	SPRING
66A	P6044066A	ROLLED PIN
67	P6772067	FLAT HD SCREW
68	P6772068	BRACKET
69	P6772069	LOCK NUT
70	P6772070	GASKET
71	P6772071	REAR COVER
72	P6772072	AIR PLUG
74A	P6044074A	CAP SCREW
75A	P6044075A	CAP SCREW
77A	P6044077	FLAT WASHER
78	P6772078	CAP SCREW
80A	P6044080A	CAP SCREW
83	P6772083	SPRING
84	P6772084	GASKET
86	P6772086	ROLLER
87	P6772087	CAP SCREW
88	P6044088	COVER SUPPORT
90	P6044090	BUTTON HD CAP SCR

TROUBLESHOOTING

PROBLEM	CAUSE	ACTION
Air leaking at trigger valve area.	1. O-rings in trigger valve housing are damaged.	1. O-rings must be replaced & operation of safety yoke must be checked.
Air leaking between housing and hose.	1. Loose screws in housing. 2. Damaged O-ring. 3. Loose air fitting.	1. Tighten screws. 2. Replace O-ring. 3. Tighten air fitting.
Air leaking between housing and cap assembly.	1. Damaged seal.	1. Replace damaged seals.
Tool skips staples while discharging.	1. Air leaks. 2. Dirt in nose. 3. Dirt or damage prevents staples from moving freely in magazine. 4. Inadequate air flow to tool. 5. Worn O-ring on piston or lack of lubrication. 6. Damaged O-rings on trigger valve. 7. Worn bumper. 8. Cap seal leaking.	1. Tighten screws and fittings. 2. Clean nose. 3. Clean magazine and inspect/repair damage. 4. Check fitting, hose, compressor & air pressure. 5. Replace piston O-ring. Lubricate. 6. Replace trigger valve O-rings. 7. Replace bumper. 8. Replace cap seal.
Tool runs slowly or has a loss of power.	1. Stapler is not sufficiently lubricated. 2. Broken spring in cap assembly. 3. Exhaust port in cap is blocked.	1. Lubricate stapler. 2. Replace spring. 3. Clean or replace damaged internal parts.
Fasteners frequently jam the stapler.	1. Staples are the wrong size. 2. Staples are bent. 3. Magazine or nose screws are loose. 4. Driver or driver guide are worn or damaged.	1. Use correct staples. 2. Use undamaged staples. 3. Tighten magazine and nose screws. 4. Replace worn or damaged parts.
Stapler does not fire.	1. Staple is jammed in magazine or discharge area. 2. Piston shaft is damaged. 3. Air pressure too low.	1. Clear stapler magazine or discharge area. 2. Replace piston shaft. 3. Check/increase air pressure.

WARRANTY AND RETURNS

Grizzly Industrial, Inc. warrants every product it sells for a period of **1 year** to the original purchaser from the date of purchase. This warranty does not apply to defects due directly or indirectly to misuse, abuse, negligence, accidents, repairs or alterations or lack of maintenance. This is Grizzly's sole written warranty and any and all warranties that may be implied by law, including any merchantability or fitness, for any particular purpose, are hereby limited to the duration of this written warranty. We do not warrant or represent that the merchandise complies with the provisions of any law or acts unless the manufacturer so warrants. In no event shall Grizzly's liability under this warranty exceed the purchase price paid for the product and any legal actions brought against Grizzly shall be tried in the State of Washington, County of Whatcom.

We shall in no event be liable for death, injuries to persons or property or for incidental, contingent, special, or consequential damages arising from the use of our products.

To take advantage of this warranty, contact us by mail or phone and give us all the details. We will then issue you a "Return Authorization Number," which must be clearly posted on the outside as well as the inside of the carton. We will not accept any item back without this number. Proof of purchase must accompany the merchandise.

The manufacturers reserve the right to change specifications at any time because they constantly strive to achieve better quality equipment. We make every effort to ensure that our products meet high quality and durability standards and we hope you never need to use this warranty.

Please feel free to write or call us if you have any questions about the machine or the manual.

Grizzly Industrial, Inc.
1203 Lycoming Mall Circle
Pennsdale, PA 17756
Phone: (570) 546-9663
Fax: (800) 438-5901

E-Mail:
techsupport@grizzly.com

Web Site: <http://www.grizzly.com>

Thank you again for your business and continued support. We hope to serve you again soon!

WARRANTY CARD

Name _____

Street _____

City _____ State _____ Zip _____

Phone Number _____ E-Mail _____ FAX _____

Model # _____ Serial# _____ Order # _____

The following information is given on a voluntary basis. It will be used for marketing purposes to help us develop better products and services. Of course, all information is strictly confidential.

- How did you learn about us?
 Advertisement Friend
 Catalog Card Deck
 World Wide Web
 Other _____
- What is your annual household income?
 \$20,000-\$29,999 \$60,000-\$69,999
 \$30,000-\$39,999 \$70,000-\$79,999
 \$40,000-\$49,999 \$80,000-\$89,999
 \$50,000-\$59,999 \$90,000 +
- What is your age group?
 20-29 50-59
 30-39 60-69
 40-49 70 +
- How long have you been a woodworker?
 0 - 2 Years 8 - 20 Years
 2 - 8 Years 20+ Years
- How would you rank your woodworking skills?
 Simple Advanced
 Intermediate Master Craftsman
- What stationary woodworking tools do you own?
Check all that apply.
 Air Compressor Panel Saw
 Band Saw Planer
 Drill Press Power Feeder
 Drum Sander Radial Arm Saw
 Dust Collector Shaper
 Spindle Sander Jointer
 Table Saw Lathe
 Mortiser Wide Belt Sander
 Horiz.Boring Machine
 Vacuum Veneer Press
 Other _____
- How many of your woodworking machines are Grizzly? _____
- Which benchtop tools do you own? Check all that apply.
 1"x42" Belt Sander 6" - 8" Grinder
 5" - 8" Drill Press Mini Lathe
 8" Table Saw 8" - 10" Bandsaw
 Scroll Saw Disc/Belt Sander
 Spindle/Belt Sander Mini Jointer
 10"-12"Thickness Planer
 Other _____
- How many of the machines checked above are Grizzly? _____
- Which portable/hand held power tools do you own? Check all that apply.
 Belt Sander Orbital Sander
 Biscuit Joiner Palm Sander
 Circular Saw Portable Planer
 Detail Sander Saber Saw
 Drill/Driver Reciprocating Saw
 Miter Saw Router
 Other _____
- What machines/supplies would you like Grizzly Industrial to carry?

- What new accessories would you like Grizzly Industrial to carry?

- What other companies do you purchase your tools and supplies from?

- Do you think your purchase represents good value?
 Yes No
- Would you recommend Grizzly to a friend?
 Yes No
- Would you allow us to use your name as a reference for Grizzly customers in your area? **Note: We never use names more than three times.**
 Yes No
- Comments: _____

Send a Grizzly Catalog to a friend:

Name_____
Street_____
City_____State_____Zip_____

FOLD ALONG DOTTED LINE

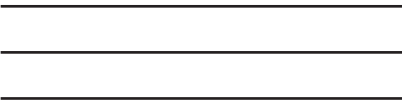

Place
Stamp
Here



GRIZZLY INDUSTRIAL, INC.
P.O. BOX 2069
BELLINGHAM, WA 98227-2069



TAPE ALONG EDGES--PLEASE DO NOT STAPLE