

OPERATING INSTRUCTIONS

FAX

Telephone-Answering System with Facsimile

MODEL NO.

KX-F100

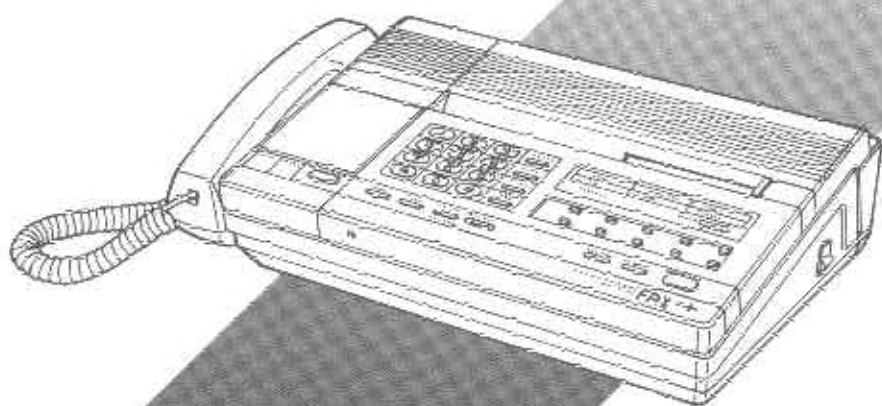

Panasonic

Please read before use.

Quick reference cards can be found
under the MEMORY Card.

FACSIMILE

ANSWERING MACHINE

TELEPHONE

Thank you for purchasing the Panasonic Telephone-Answering System with Facsimile.

Before reading these instructions, read the INSTALLATION MANUAL, then install the unit and make the initial settings.

Since this unit functions as a Facsimile, an Answering Machine and a Telephone utilizing one telephone line, you can receive both voice-messages and documents.

To Speak with the Other Party and then Transmit/Receive a Document

With the automatic telephone/facsimile switching feature, you can switch between telephone and facsimile functions without redialing. So, if you are in the middle of a conversation and want to transmit/receive a document, simply push the START/COPY button and facsimile transmission/reception will take place automatically.

To Record a Voice-Message and Receive a Document

The unit will automatically function as an Answering Machine or a Facsimile depending on the caller's choice (voice-message/document). When a call is received during your absence, the unit will play your Outgoing Message (OGM) and then be ready to record a voice-message and/or receive a document (Automatic Answer Mode).

• In this mode you may speak with the other party and transmit/receive a document manually.

To Set the Automatic Answer Mode

- Push the AUTO ANSWER button to turn on the AUTO ANSWER indicator light.
- Record your Outgoing Message.
- Set the AUTO/FAX selector to "AUTO" position.

AUTO/FAX Selector

• AUTO position

The unit will automatically switch between Answering Machine and Facsimile. If the caller's voice is not heard within 5 seconds of the end of the OGM, the unit will automatically switch to the FAX mode to receive a document. If the caller's voice is heard, the unit will function as an answering machine.

• FAX position

When a call is received, the unit will function as a facsimile (FAX) machine only.

□ If a caller wishes to transmit a document after recording a voice-message; advise the caller to "Push the ASTERISK (*) button after or during the playing of the Outgoing Message (OGM)", the unit will change from the answering machine mode to the facsimile mode.

□ If a caller wishes to record a voice-message after transmitting a document; advise the caller to "Make a call reservation following a voice contact procedure on your facsimile during transmission". The unit will start playing the OGM again and then be able to record a voice-message.

Features

■ Multi-Function System utilizing Single Telephone Line

allows you to speak with a caller and/or receive a document.

automatically records a caller's message and/or receives a document during your absence.

■ Facsimile

- CCITT GIII communication compatibility
- Automatic document feeder up to five pages at a time
- One-touch transmission with automatic dialer 10 (30 digits) fax numbers for one-touch dialing
- Superb image quality
- Up to letter size

■ Answering System

- AUTO-LOGIC™ operation automatically rewinds, plays back messages, stops at the last message and provides for answering the next call, at the touch of a button.
- Recordable OGM chip
- Beeperless remote control with tone phone

■ Integrated Telephone System

- Built-in speakerphone
- One-touch/speed dialing
- Automatic redialing up to 15 times in a hands-free (speakerphone) operation.

■ Copier Function

- Right at your desk
- Clear copy

QUICK REFERENCE CARD

FOR TONE REMOTE CONTROL

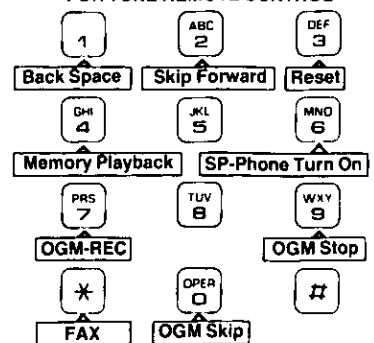

□ To set to the Automatic Answer mode remotely
1. Dial the phone number.
2. Wait until 15 rings, and hang up after hearing OGM.

□ To set to the FAX mode after recording message

1. Push the button.
- The "Beep" (answering carrier tone) will be heard.

Location of Controls

For your convenience, keep this page open when you read the following instructions.

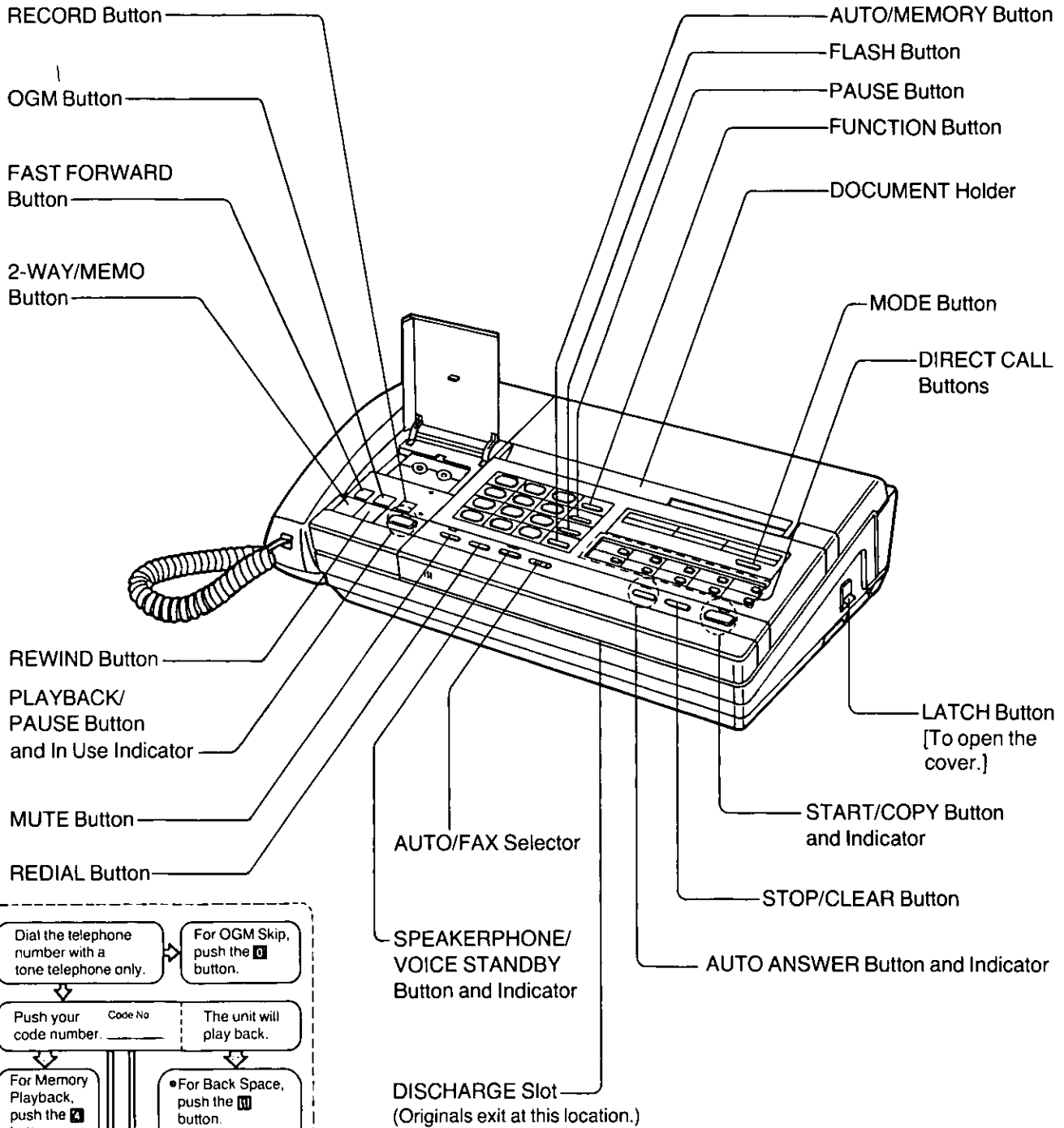

Dial the telephone number with a tone telephone only. → For OGM Skip, push the **0** button.

Push your code number Code No _____ The unit will play back.

For Memory Playback, push the **2** button.

To turn on the SP-Phone, push the **3** button.

To change the OGM

1. Push the **7** button.
2. Record the new OGM after a long beep.
3. When finishing, push the **9** button.

- For Back Space, push the **11** button.
- For Skip Forward, push the **2** button.
- To record the ICM from the beginning of the tape, push the **3** button.
- To save the ICM, hang up after playback.
- To record a marker message, speak after hearing 2 beeps.

•When you push any button, push firmly.

Location of Controls (cont.)

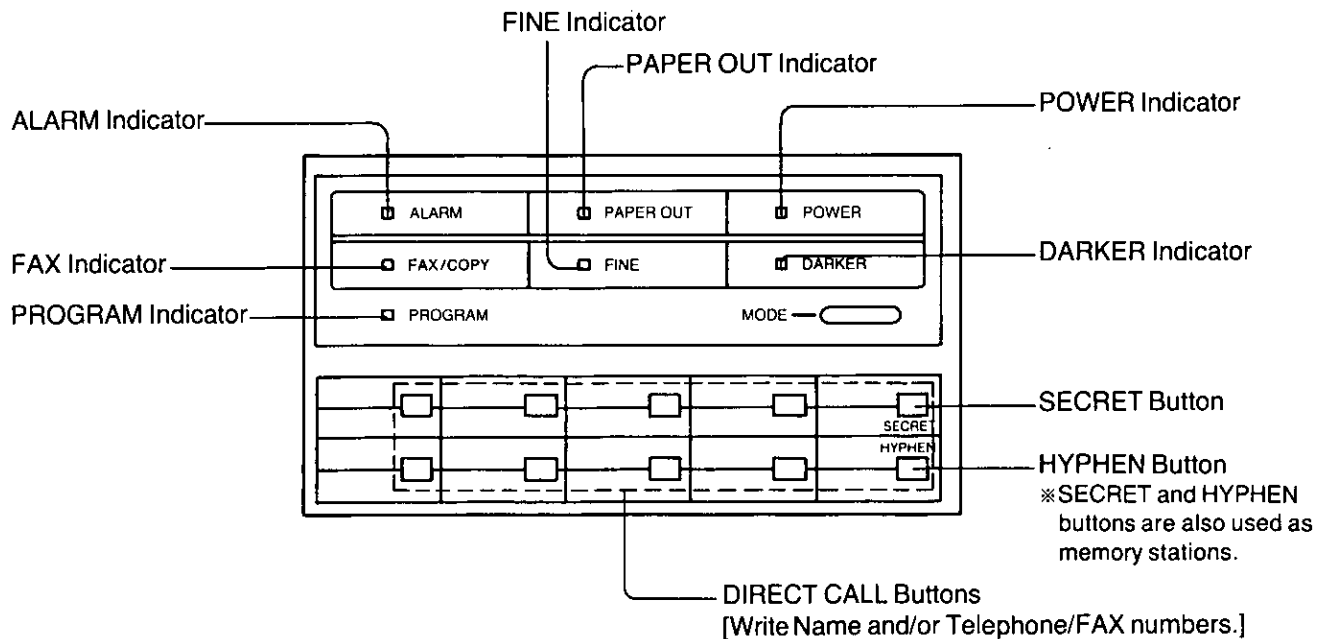
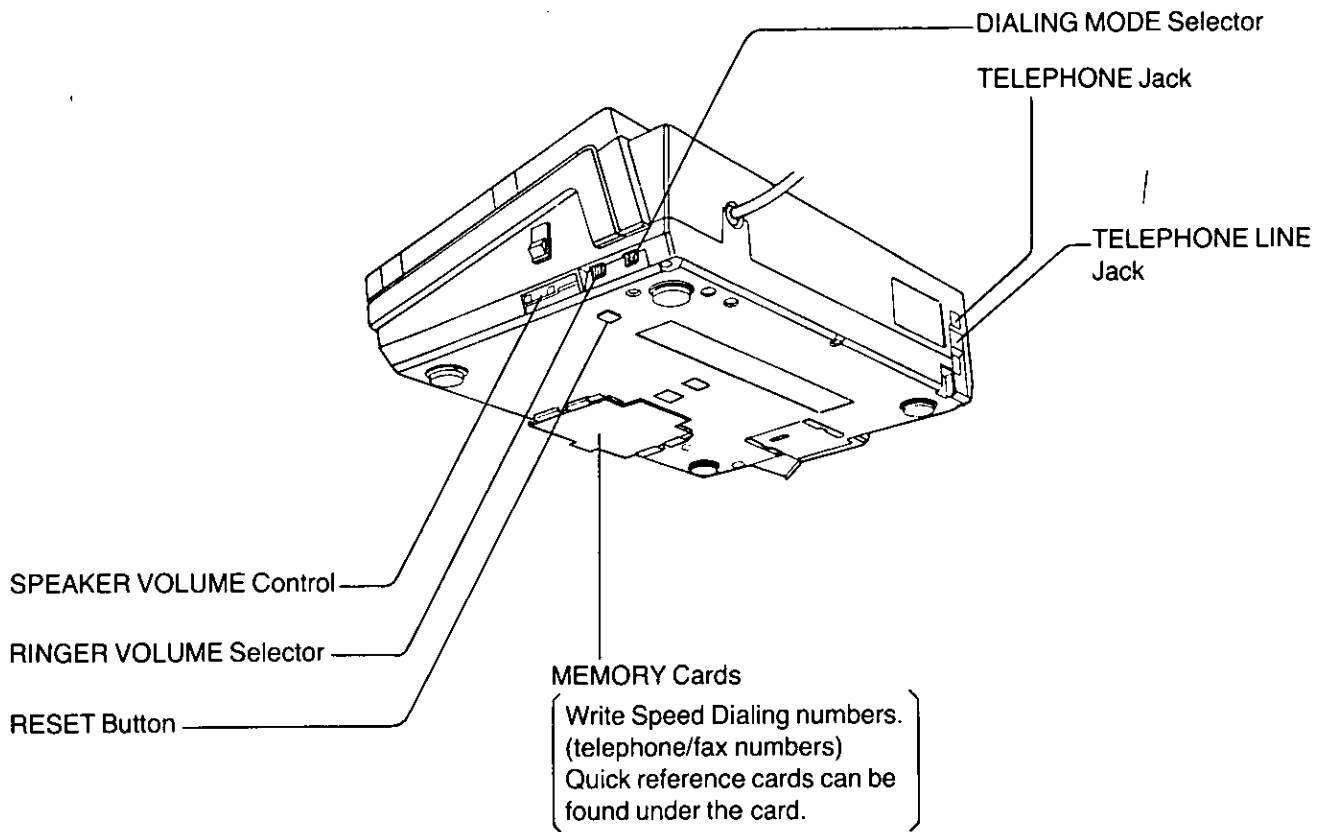

Accessories

Telephone Line Cord	1	Recording Paper	1
Incoming Message Tape	1	Document Tray	1
Handset	1	AA Size Batteries	4
Handset Cord	1	Card Holder for Speed Dialing	1
Paper Shaft	1		

Table of Contents

System Set Up	5
Listing the Memory Card	7

FACSIMILE

Basic Operation

Manual Transmission and Reception	1-1
---	-----

- Transmission
- Reception
- Scanning Line Density (Resolution)
- Document Contrast

Transmissible Document	1-4
------------------------------	-----

- Information on Originals

Automatic Document Reception	1-5
------------------------------------	-----

- Preparation
- Setting Up for Automatic Answering
- Setting Up for Automatic Answering Remotely
- Receiving a Document

Detailed Operation

How to Transmit a Document

Automatically	1-7
---------------------	-----

- When Using One-Touch Transmission
- When Using Speed Dialing

Voice Contact	1-9
---------------------	-----

- Initiating Voice Contact
 - During Transmission or Reception
- Receiving a Request for Contact

How to Operate Your Unit from a Remote Location	1-10
---	------

Other Information	1-10
-------------------------	------

Making a Copy	1-11
---------------------	------

Individual Transmission Report	1-12
--------------------------------------	------

Activity Report (JOURNAL)	1-13
---------------------------------	------

Printout Function	1-14
-------------------------	------

ANSWERING MACHINE

Preparing the Answering Machine	2-1
---------------------------------------	-----

- Recording OGM
- Selecting the Caller's Recording Time
- Selecting the Remote Code No. for Remote Operation
- Setting Up the Automatic Answer Mode
- Preparing the ICM Tape

Operating the Answering Machine	2-4
---------------------------------------	-----

- Playing Back Your Messages
- Call Counter
- Saving Your Messages
- Erasing the ICM
- Monitoring Incoming Calls
- Message Memo
- Recording a 2 Way Conversation

How to Operate from a Remote Phone ..	2-7
---------------------------------------	-----

- Turning On the Automatic Answer Mode from a Remote Phone
- Playing Back Messages
- Memory Playback
- Back Space and Skip Forward
- Recording a Marker Message
- Remote Reset
- Skipping OGM for ICM Recording
- Turning On the Speakerphone (Answer Back)
- Changing the OGM

TELEPHONE

Manual Dialing and Reception	3-1
------------------------------------	-----

- Making a Call
- Receiving a Call
- Redialing

Switching to Hands-free or Handset

Operation during a Conversation	3-2
---------------------------------------	-----

- Handset to Hands-free
- Hands-free to Handset

Speed Dialing and One-Touch Dialing ..	3-3
--	-----

- Programming the Phone Numbers for Speed Dialing
- Programming the FAX/Phone Numbers for One-Touch Dialing
- Erasing the Stored Numbers
- Dialing

Other Features	3-6
----------------------	-----

- How to Store a Secret Phone Number
- Mute Operation
- Flash Button Usage
- Tone Button Usage
- Combination Dialing
- Outside Line or Computer Accessed Line (Pause Usage)

GENERAL INFORMATION

Recording Paper Installation	4-1
------------------------------------	-----

Troubleshooting Guide	4-2
-----------------------------	-----

Glossary of Terms	4-5
-------------------------	-----

System Set Up

There are 14 user programmable functions in the unit. After entering the Programming Mode by pushing the FUNCTION button, these functions may be selected or changed.

You can print out the "SYSTEM SET UP LIST" and "HOW TO SET UP" by simply pushing the FUNCTION button then the START/COPY button.

CODE NO.	FUNCTION	PAGE
01	Logo and Sender's Identification	See page 9 in INSTALLATION MANUAL.
02	Remote ID for remote operation	See page 2-2.
03	Caller's Recording Time	See page 2-1.
04	CPC (Calling Party Control) Mode	See page 7 in INSTALLATION MANUAL.
05	Dial Speed for pulse dialing	See page 7 in INSTALLATION MANUAL.
06	Tone Detect	See page 7 in INSTALLATION MANUAL.
07	Journal	See page 1-13.
08	Transmission (TX) Report	See page 1-12.
09	Transmission (TX) Speed	See page 7 in INSTALLATION MANUAL.
10	ID Position	See page 7 in INSTALLATION MANUAL.
11	Motor Test	See page 15 in INSTALLATION MANUAL.
12	Printer Test	See page 15 in INSTALLATION MANUAL.
13	Telephone No. List Print	See page 1-14.
14	Journal Print	See page 1-14.

■ Initial Setting

<< SYSTEM SET UP LIST >>

```

#01 SENDER ID =
#02 REMOTE ID = 111
#03 REC TIME = VOX (1 = VOX 2 = 1MIN )
#04 CPC MODE = A (1 = A 2 = B )
#05 DIAL SPEED = 10 (1 = 10 PPS 2 = 20 PPS )
#06 TONE DETECT= ON (1 = ON 2 = OFF )
#07 JOURNAL = AUTO (1 = AUTO 2 = MANUAL )
#08 TX REPORT = OFF (1 = OFF 2 = ON )
#09 TX SPEED = 9600 (1 = 9600BPS 2 = 4800BPS)
#10 ID POSITION= OUT (1 = OUT 2 = IN 3 = OFF)
#11 MOTOR TEST
#12 PRINTER TEST
#13 TEL LIST PRINT
#14 JOURNAL PRINT
  
```

--<< HOW TO SET UP >>---

1. PUSH "FUNCTION"
2. PUSH "#" THEN "CODE NO. (01-14)"
3. ENTER VALUE FOR REQUEST
4. PUSH "AUTO/MEMORY" TO STORE YOUR SELECTION
5. PUSH "FUNCTION" TO END THE OPERATION

System Set Up (cont.)

You can select the desired function directly by pushing the “#” and CODE NO. (01 through 14).

Example: To select the CPC Mode setting

1 Push **FUNCTION**.

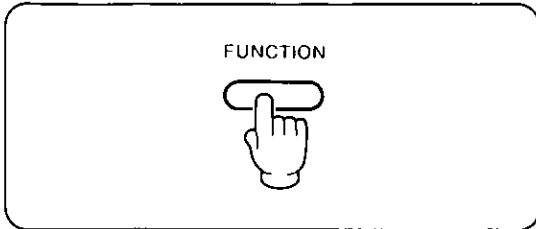

•The PROGRAM indicator will light.

2 Push “#” then push “0” and “4” for CPC setting.

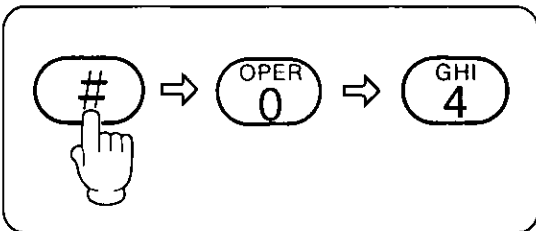

4 Push **AUTO/MEMORY** to store your selection.

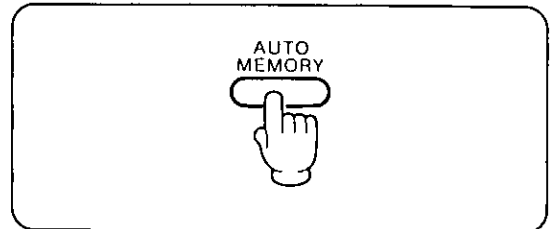

5 Push **FUNCTION** to end the operation.

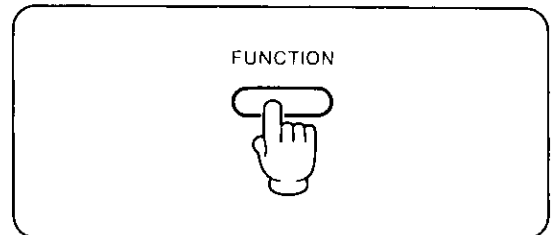

•The PROGRAM indicator will go out.

3 Select the desired mode.

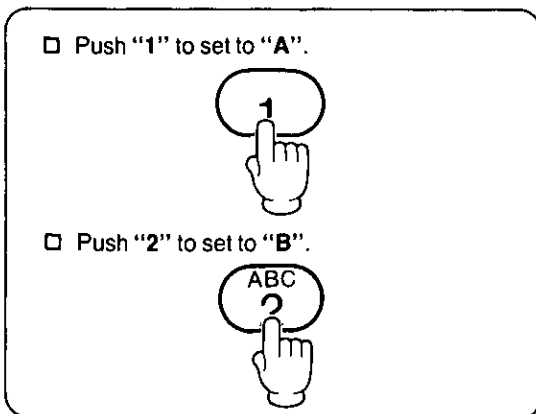

Listing the Memory Card

Remove the cover with a pencil or the like as shown.
Use a pencil or a ball-point pen to fill in Memory Card with station names.

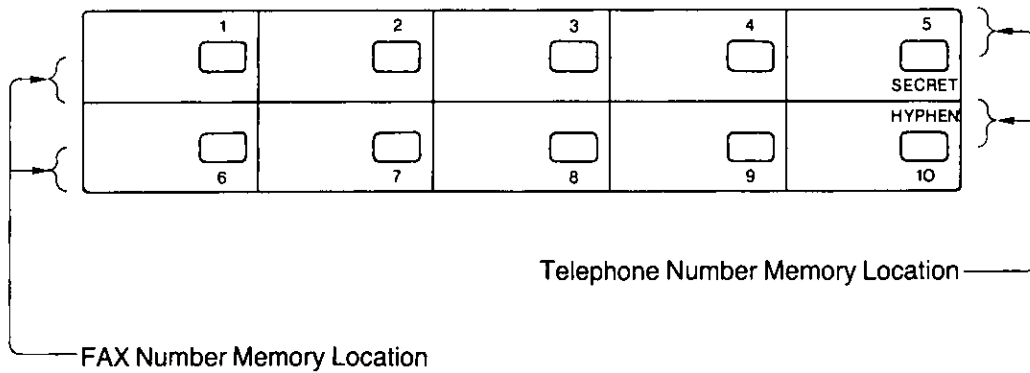
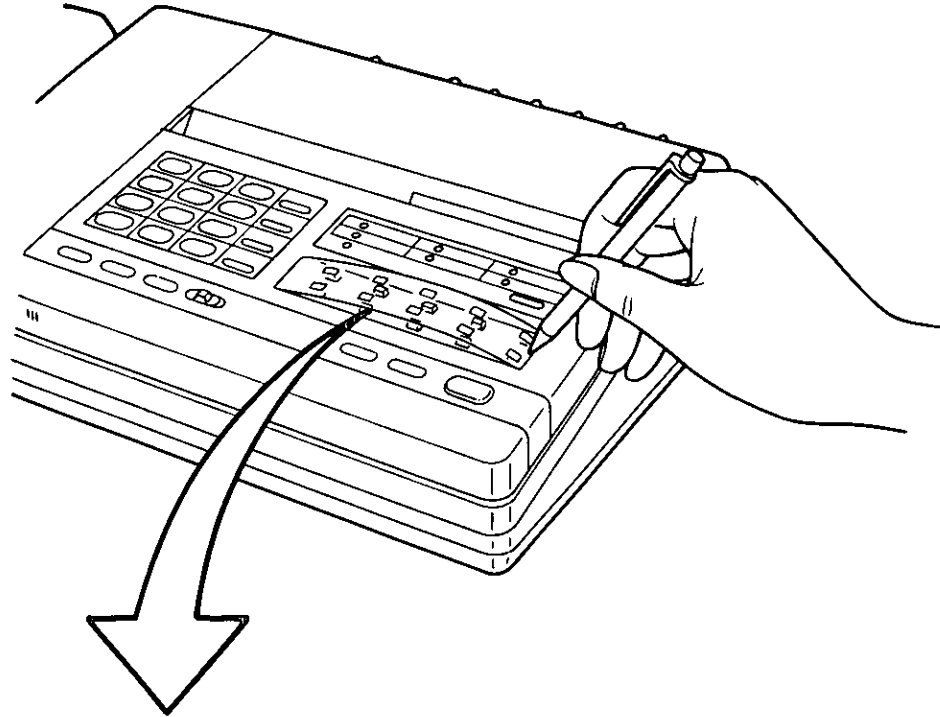

How to Operate as a Facsimile Machine

Table of Contents

Manual Transmission and Reception	1-1
Transmission	1-1
Reception	1-1
Scanning Line Density (Resolution)	1-2
Document Contrast	1-2
Transmissible Document	1-4
Information on Originals	1-4
Automatic Document Reception	1-5
Preparation	1-5
Setting Up for Automatic Answering	1-6
Setting Up for Automatic Answering Remotely	1-6
Receiving a Document	1-6
How to Transmit a Document Automatically	1-7
When Using One-Touch Transmission	1-7
When Using Speed Dialing	1-8
Voice Contact	1-9
Initiating Voice Contact During Transmission or Reception	1-9
Receiving a Request for Contact	1-9
How to Operate Your Unit from a Remote Location	1-10
Other Information	1-10
Making a Copy	1-11
Individual Transmission Report	1-12
Activity Report (JOURNAL)	1-13
Printout Function	1-14

Manual Transmission and Reception

Transmission

- 1 Place the document face down.

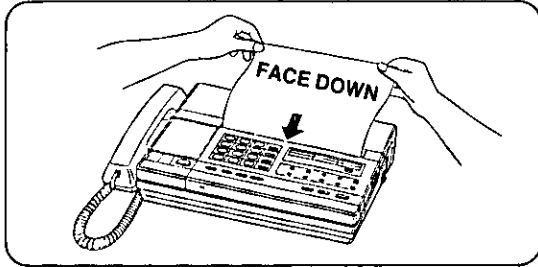

•The FAX/COPY indicator will light.

- 2 Lift the handset or push SP-PHONE, then dial the FAX NO.

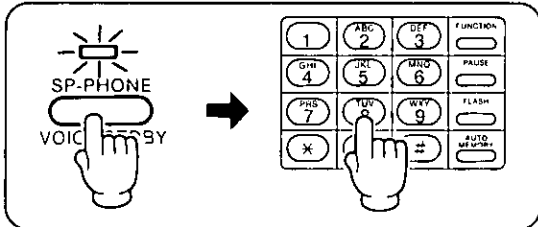

- 3 When the "Beep" (answering carrier tone) is heard, push START/COPY.

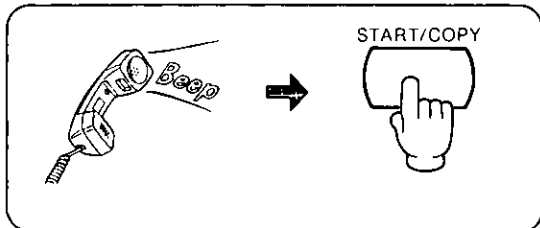

•The START/COPY indicator will change from a flashing to a steady light.

- 4 After pushing START/COPY, replace the handset.

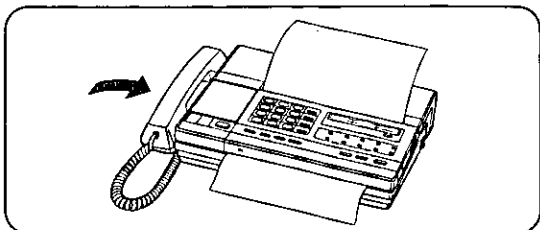

•Do not pull document through rollers. Wait until transmission is completed to remove the document.

Reception

- 1 Lift the handset to speak to the caller.

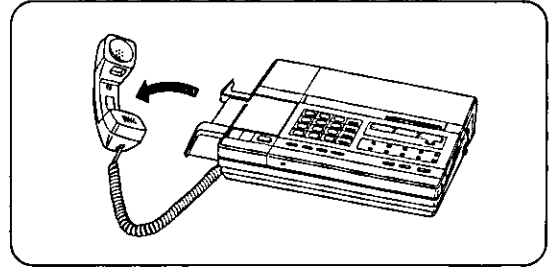

- 2 Push START/COPY to receive a document.

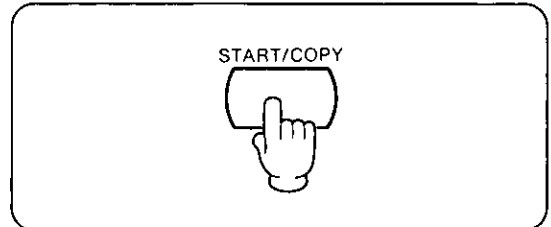

•The START/COPY indicator will change from a flashing to a steady light.

- 3 After pushing START/COPY, replace the handset.

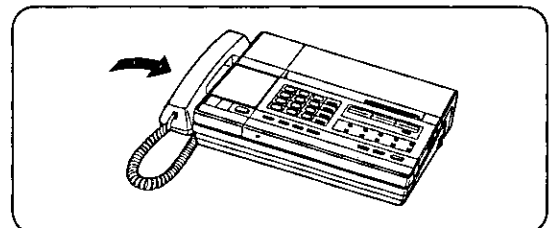

Manual Transmission and Reception (cont.)

Scanning Line Density (Resolution)

The resolution (density) of the received image (e.g. characters, pictures) can be set as shown below:

- STANDARD** is suitable for printed or typewritten originals with normal size characters.
- FINE** is suitable for originals written with small characters.

1 Push **MODE**.

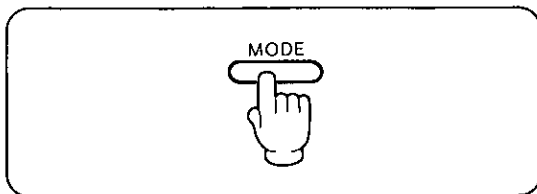

•FINE mode is indicated by the FINE indicator.

Document Contrast

The document contrast can be set as shown below.

- NORMAL** is suitable for transmitting or copying printed or typewritten documents.
- DARKER** is suitable for transmitting or copying originals written in light pencil.

1 Push **FUNCTION**.

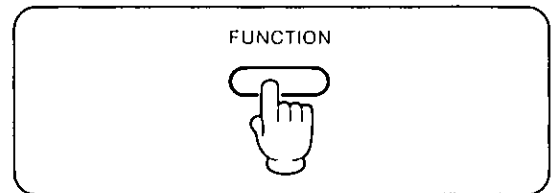

2 Push **MODE**.

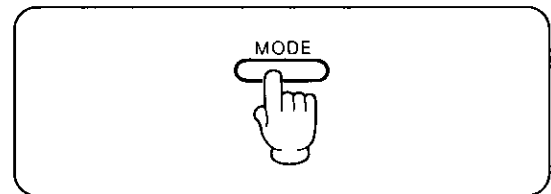

•DARKER mode is indicated by the DARKER indicator.

FACSIMILE

NOTES:

•START/COPY indicator:

The START/COPY indicator will change from a flashing to a steady light, and the unit will begin transmitting or receiving the document.

•If you are using the speakerphone, the line will be automatically disconnected after the transmission is completed.

•Begin by transmitting the FAX CORRESPONDENCE leaflet (included) to several of your business associates to confirm that your unit is functioning correctly, and to inform them of the procedure for transmitting documents and/or recording voice-messages on your unit.

•If you do not hang up the handset after transmitting, the unit will automatically call the other party.

For further details, see "Voice Contact" on page 1-9.

Manual Transmission and Reception (cont.)

FACSIMILE

■ To stop transmission:

- 1 Push **STOP/CLEAR** firmly.

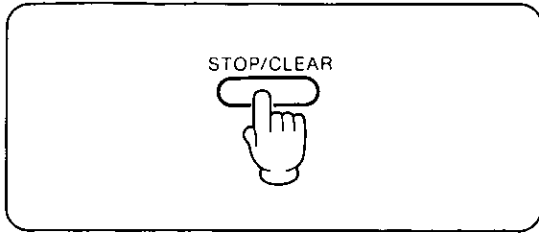

■ If a document jams during transmission:

- 1 Push **STOP/CLEAR** to stop transmission and then push **LATCH** to open the cover.

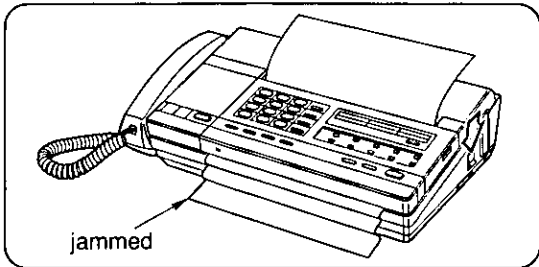

- 2 Pull out the document.

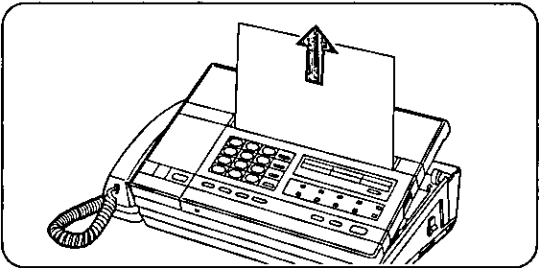

□ To transmit continuously: (Weight of document is 16 to 20 pounds.)

- 1 First insert a maximum of 5 pages.
- 2 Start the fax transmission.
- 3 Insert additional pages (5 sheet max.).
 - Insert additional pages when the last page disappears from the top of the **DOCUMENT** holder and while the **START/COPY** indicator is still lit.

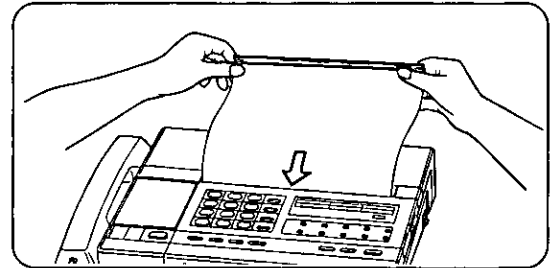

CAUTION:

When you set the documents, a beep will be heard. Tight insertion of multiple documents may cause simultaneous transmission of the documents.

□ To transmit continuously: (Weight of document is except 16 to 20 pounds.)

- 1 Transmit a single page.
- 2 Insert additional page before the fourth beep is heard.

*When the unit is ready to transmit an additional page, 4 beeps will be heard.

Transmissible Document

The unit can transmit documents with the following sizes, weights and textures.

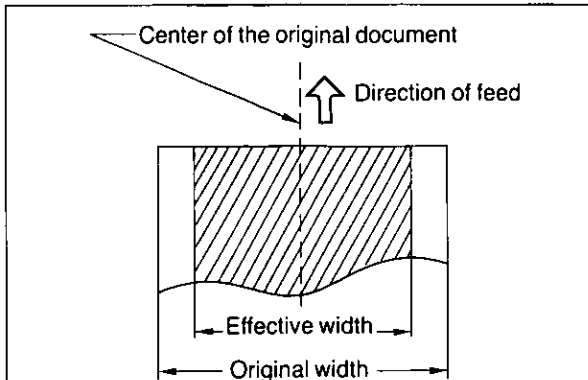

- Original width is 128 mm (5") to 216 mm (8½").
- Effective width is up to 208 mm (8¾").
- Weight of transmissible document is 12 to 24 pounds when sending each page separately.

Maximum size of original	Minimum size of original
<p>216 mm (8½")</p> <p>600 mm (23⅝")</p>	<p>128 mm (5")</p> <p>128 mm (5")</p>

□ Automatic Document Feeder:

- Up to 5 pages at the same time
- Bond paper (16 to 20 pounds)
- Letter size
- Paper with an uncoated surface
- When you are transmitting a narrow document, slide the right document guide over to support the document.

NOTES:

- A document which is over 600 mm (23⅝") cannot be transmitted. This will be indicated by the lighting of the ALARM indicator and the sounding of the alarm for 1 second.
- If the originals are electrostatically charged, the automatic document feeder may not function properly.
- In case of malfunction of the automatic document feeder, try to send each page separately.

Information on Originals

The following documents should first be copied on a copier machine, and the copy used as the fax document.

- Paper with chemically treated surfaces such as carbon-blackened paper or carbonless duplicating paper
- Heavily curled, creased or torn paper
- Paper with a coated surface
- Small size paper such as a slip or voucher
- Thin paper (less than 12 pounds)
You can transmit a document with thin paper using the optional carrier sheet (Panasonic KX-A111).
- Wet paper with ink or paste
- Document which has staples or clips
- * Make the copy using a copier machine to transmit a legible document in the following cases:
 - Thick paper (over 24 pounds), since a carrier sheet cannot be used.
 - When the contrast between the printed letter and the background is small.
 - When the letters printed on the back side can be seen from the front of the paper. (e.g. newspaper)

FACSIMILE

Automatic Document Reception

In most cases you will be using your unit in the Auto Receiving mode, so that you can receive documents or messages without the need for manual operations.

To receive a document automatically, you should first record an Outgoing Message (OGM) and set the unit to the Automatic Answer mode. (The AUTO ANSWER indicator will light.)

Preparation

■ OGM Recording:

The purpose of the OGM (Outgoing Message) is to answer a caller during your absence.

- 1 Push **REC**, while holding it, push **OGM** until a beep is heard.

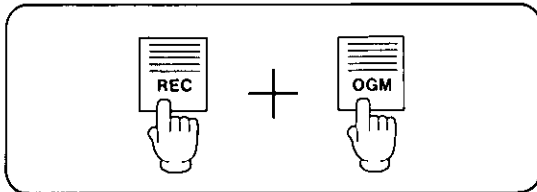

- The IN USE indicator will light.

- 2 **Speak** clearly and loudly into the microphone (MIC), approximately 8 inches away.

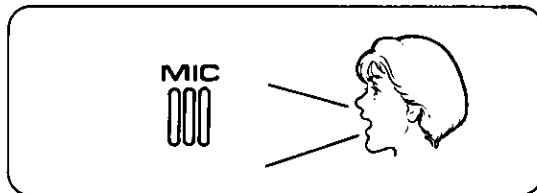

- Recording time is 16 seconds.
- 6 seconds before the end of the recording time, it will start flashing quickly to warn you.
- For optimum performance, record your OGM within 12 seconds.

- 3 When you are finished, push **OGM**.

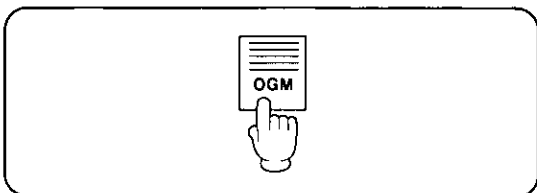

- If you want to change your OGM, simply repeat the above procedure.

■ Confirming the OGM:

Push the OGM button.

- The OGM will be played back.

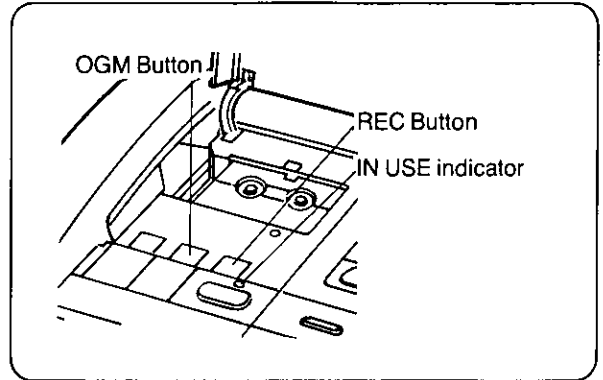

■ Recordable OGM Chip:

- Your Outgoing Message will be stored on a voice-recordable microchip.
- Prepare and practice your announcement before you record it. Your Outgoing Message is limited to 16 seconds.

Samples of OGM

■ Set the Recording Time to "VOX".

"This is the Panasonic Company. To send a FAX, push the asterisk (*) button. To leave a message, speak after the beep".

■ Set the Recording Time to "1 minute".

"This is the Panasonic Company. To send a FAX, push the asterisk (*) button. To leave a message, speak after the beep, up to 1 minute".

NOTE:

Please record your message using the examples shown. Remember that the caller will have to push the asterisk button to begin transmission after hearing the OGM.

Automatic Document Reception (cont.)

Setting Up for Automatic Answering

- 1 Push **AUTO ANSWER** to set up.

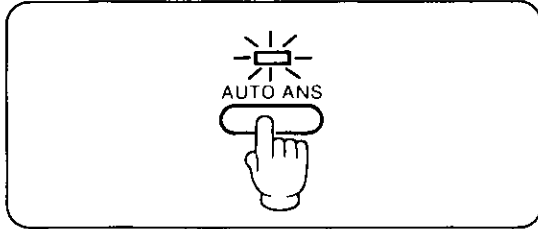

- The AUTO ANSWER indicator will light.
- The unit will automatically answer all calls.

- 2 Set the **AUTO/FAX selector** to "AUTO".

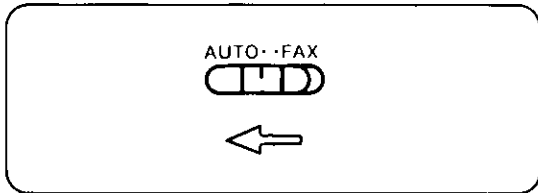

□ AUTO/FAX Selector:

• AUTO position

The unit will automatically switch between the Answering Machine and Facsimile as follows:
If the caller's voice is not heard within 5 seconds of the end of the OGM or the caller pushes the asterisk (*) button, it will automatically switch to the FAX mode to receive a document.

If a voice is detected, it will function as an Answering Machine.

• FAX position

When a call is received, the unit will function as a Facsimile (FAX) machine only.

Setting Up for Automatic Answering Remotely

Call the KX-F100, and let the telephone ring 15 times. The unit will go into the Automatic Answer mode and the AUTO ANSWER indicator will light. You can then hang up. See page 2-7.

NOTE:

If someone is unable to transmit a document to you after several tries, we recommend the following.

- Shorten your OGM (e.g. "To send a FAX, push the asterisk button."), and ask them to try again.
- Set the AUTO/FAX selector to "FAX" position if transmission cannot be done by using step shown in (i) above.

Receiving a Document

When a call is received, the unit will answer and begin playing your recorded OGM.
If the caller's voice is not heard, leave the unit alone. The unit will automatically receive the transmitted document.

- Tear off the recorded document as shown.

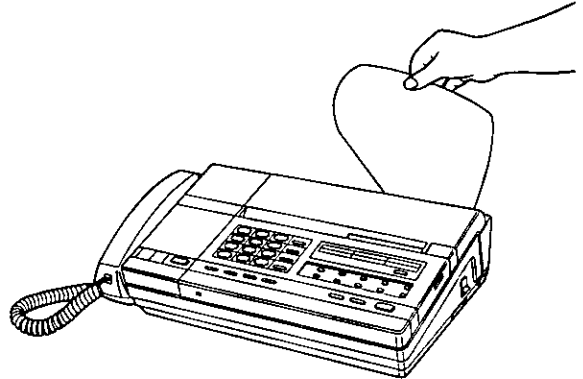

□ If you want to receive documents only:

- 1 Set the **AUTO/FAX selector** to "FAX".

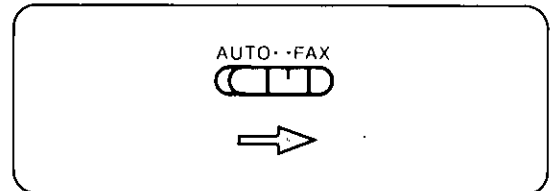

How to Transmit a Document Automatically

For convenient transmission, you are allowed to store the FAX number into ten DIRECT CALL buttons (ten FAX memory locations) for One-Touch Dialing and station number for Speed Dialing.
For more details on how to store the FAX number, refer to "Speed Dialing and One-Touch Dialing" on page 3-4.

When Using One-Touch Transmission

It is not necessary to use the handset or SP-PHONE. The unit will automatically dial the number in the FAX memory location and transmit the document.

Be sure that the FAX number is stored in FAX memory location. (See page 3-4.)

- 1 Place the document face down.

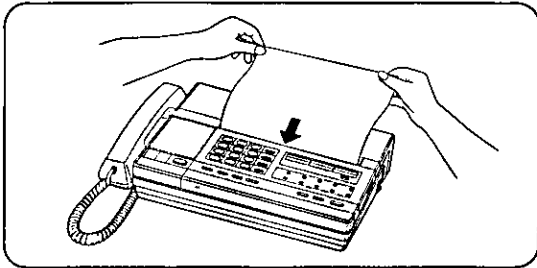

- The FAX/COPY indicator will light.
- The FAX memory locations will be automatically selected.

- 2 Push the **DIRECT CALL** button which contains the FAX number you wish to transmit to.
(e.g. If the Direct station No. is 4.)

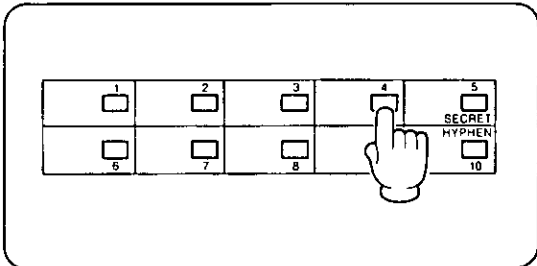

- Facsimile transmission will begin automatically.
- The START/COPY indicator will change from a flashing to a steady light, and the unit will begin transmitting.

■ Automatic Redialing:

When the line is busy, the unit will automatically redial the number up to 6 times within a 10-minute period.

- During a redialing, the SP-PHONE indicator will blink slowly.
- To cancel, push the STOP/CLEAR button.

NOTE:

- When you push the **DIRECT CALL** button; If the document has been placed onto the DOCUMENT holder, the unit will dial using the FAX memory location and transmit the document.

If the DOCUMENT holder is empty, the unit will dial using the telephone memory location.

How to Transmit a Document Automatically (cont.)

When Using Speed Dialing

- 1 Place the document **face down**.

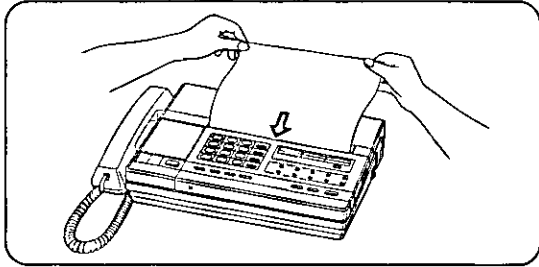

- 4 When the answering carrier tone is heard, push **START/COPY**.

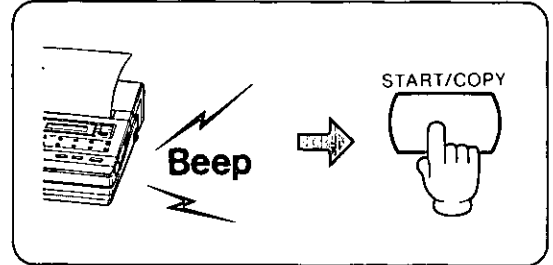

- 2 Lift the **handset** or push **SP-PHONE**.

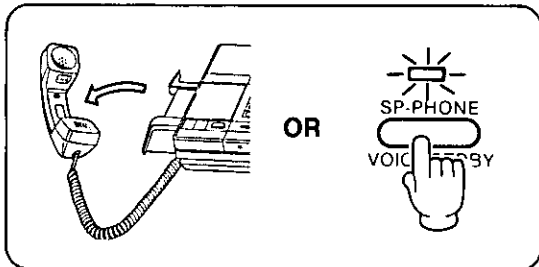

- 5 After pushing **START/COPY**, replace the handset.

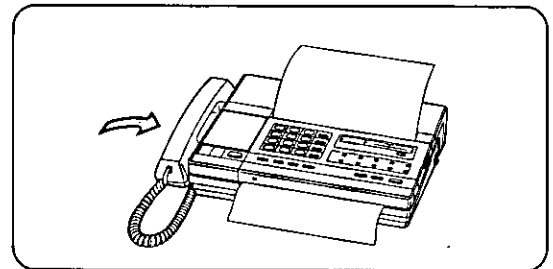

•Facsimile transmission will begin automatically.

- 3 Enter the **speed dial No.**
00 to 99 (2 digits)
(e.g. If the station No. is 12)

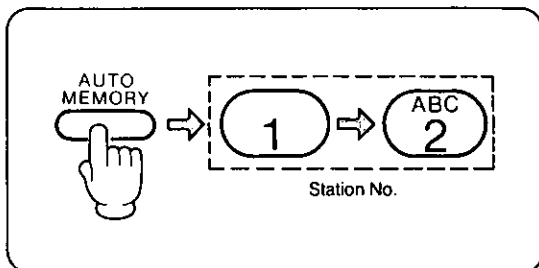

FACSIMILE

Voice Contact

FACSIMILE

While you are transmitting or receiving documents, you may wish to speak with the other party.
If the other party's unit is equipped with the voice contact feature, you can initiate voice contact as follows.

Initiating Voice Contact During Transmission or Reception

- 1 Lift the handset or push **SP-PHONE**.

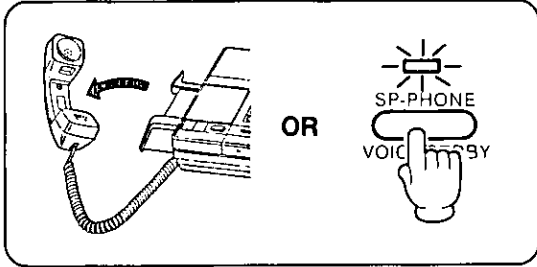

- 2 When the other party answers, start speaking.



■ During Transmission:

If you initiate voice contact during transmission, you will be able to speak **after all of the documents have been transmitted**.

The other party's unit will ring or beep depending on the type of unit, **after all of the documents have been sent**.

■ During Reception:

If you initiate voice contact during receipt of a document, you will be able to speak **after receiving the current page of the document**.

The other party's unit will ring or beep depending on the type of the unit **after current page has been sent**.

Receiving a Request for Contact

If the other party tries to contact you during transmission or reception of a document, the unit will beep.

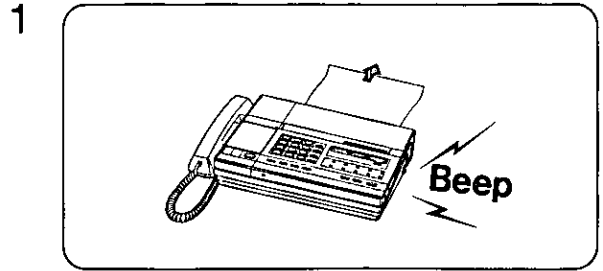

- 2 Lift the handset or push **SP-PHONE**.

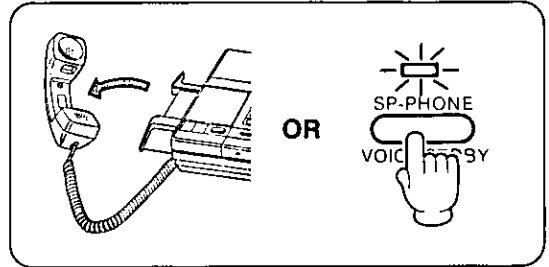

- 3 Start speaking.



NOTES:

- When you are using the handset and wish to speak with the other party immediately after the transmission is completed, do not replace the handset after pushing the START/COPY button. This will cause your unit to automatically call the other party.
- If you receive a Request for Voice Contact and you do not pick up the handset or push the SP-PHONE button, the unit will automatically switch to the Incoming Message recording mode, 10 seconds after the beeps are heard, if the AUTO/FAX selector is set to "AUTO", and the AUTO ANSWER indicator is lit.
- It may happen that the voice contact cannot be done because of the type of the voice contact provided with the other party's unit.

How to Operate Your Unit from a Remote Location

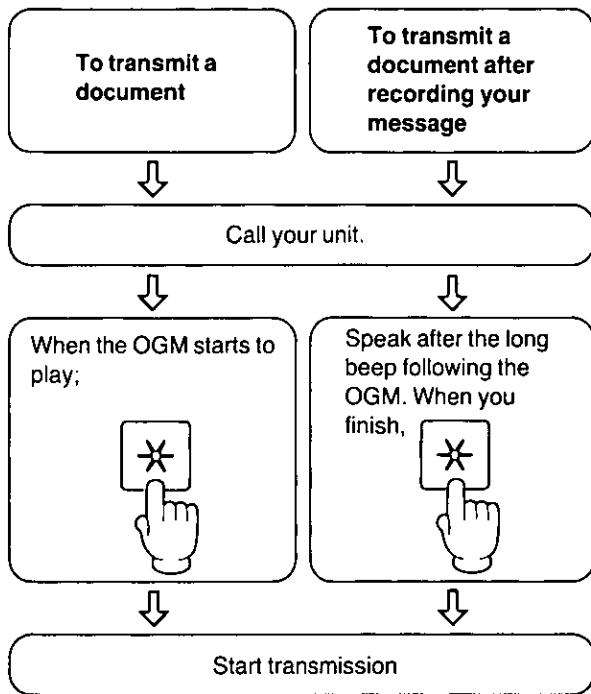

□ To record a voice message after transmitting a document to another KX-F100:

- 1 During transmission, lift the handset or push the SP-PHONE button.
- 2 Speak after the long beep following the OGM.

□ If you are calling from a rotary (pulse) phone: To transmit a document

1. While the OGM is playing, push your mute button or cover the mouthpiece of your handset until the answering carrier tone is heard. This will prevent the recording of your voice or of background noise and allow you to transmit your document.
2. Start transmission after hearing the answering carrier tone.

To transmit a document and voice-message

1. Make a call reservation (e.g....lift the handset) during transmission of a document.
2. Speak your message after a long beep following the OGM.

Other Information

- If a caller hangs up during or immediately after hearing the OGM, the START/COPY indicator may flash for about 40 seconds, but nothing is recorded. This may occur due to differences in Central Office lines and is a normal condition.
- If you are using a call waiting service, and a call is received at the same time that a document is being received, the document may include distorted characters, or reception errors may occur.
- If a telephone connected in parallel with your unit is used during transmission of a document, the document may be sent with distorted characters.
- If the letters and/or drawing in an original document are small or intricate, change the Scanning Line Density (Resolution) to "FINE". When you transmit the FAX CORRESPONDENCE sheet, we recommend that you set to "FINE" so that the other party can receive a clear copy.
- If the condition of the telephone line is poor (noisy) or the recording paper of the receiving unit is out, the ALARM indicator will flash and a beep will be heard. During these conditions, transmission is not possible.
- When you are transmitting a narrow document, slide the right document guide over to support the document.

□ WARNINGS:

- When the unit is used in the facsimile mode for a long time, it may overheat and stop operating. At this time, the ALARM indicator will light and do not disconnect the AC cord from the power outlet. Operation will automatically resume as soon as the unit has cooled.
- If you should experience difficulty transmitting/receiving a document (particularly international FAXES) because of poor telephone line conditions, refer to the INSTALLATION MANUAL.

FACSIMILE

Making a Copy

The unit may also be used to make single or multiple copies. Any documents which can be transmitted can also be copied.

- 1 Place the document **face down** onto the holder.

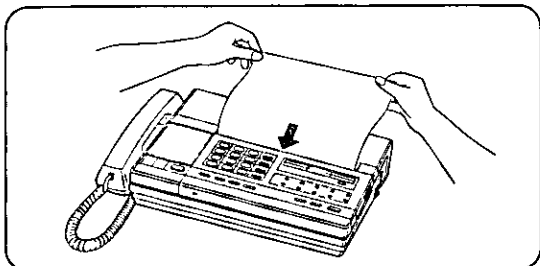

•The FAX/COPY indicator will light.

- 2 Push **START/COPY**.

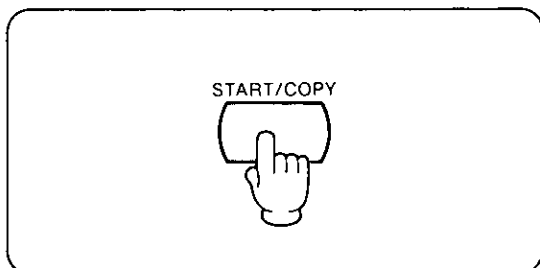

- **To abort a copy:**

Push **STOP/CLEAR** firmly.

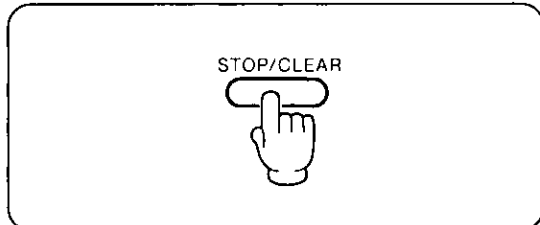

- The document will be ejected.
- If the document does not feed straight while making a copy, stop copying, open the cover and pull out the document.

- **If the PAPER OUT indicator lights;**

Replace the paper. Refer to "Recording Paper Installation" on page 4-1.

- **To copy continuously:**

Insert additional pages when the last page disappears from the top of the DOCUMENT holder and while the START/COPY indicator is still lit.

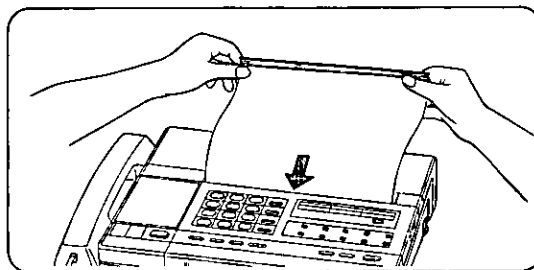

NOTE:

- The document feeder can handle up to five sheets at a time. The top sheet of the document will be copied first.
- Weight and/or size of usable document are the same as transmissible document.
(Refer to "Transmissible Document" on page 1-4)

Individual Transmission Report

Each time a document is transmitted, this function will cause a record of the transmission to be printed.
Once Individual Transmission Report is set ON, it will remain ON until it is switched OFF.

The Individual Transmission Report is preset to OFF.

1 Push **FUNCTION**.

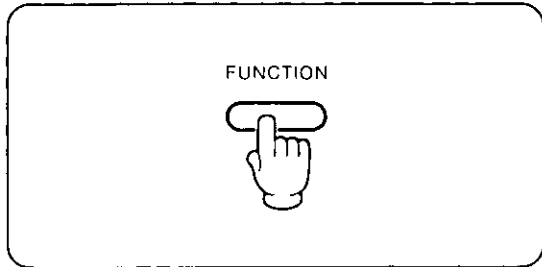

•The PROGRAM indicator will light.

2 Push “#” then push “0” and “8” for TX (Transmit) Report setting.

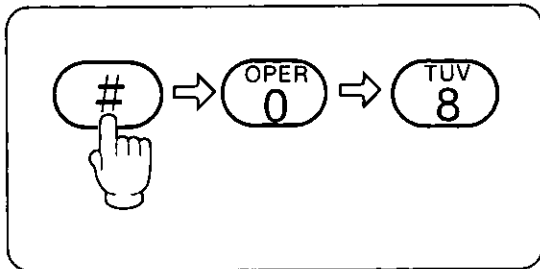

3 Push the button as follows.

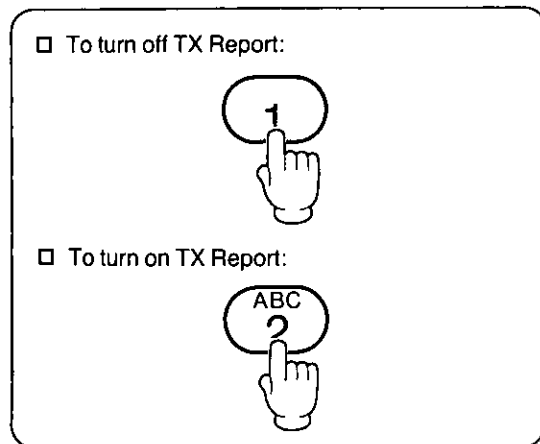

4 Push **AUTO/MEMORY** to store your selection.

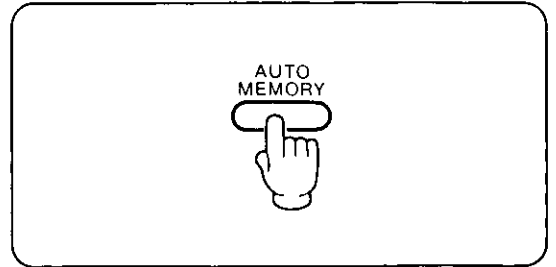

5 Push **FUNCTION** to end the operation.

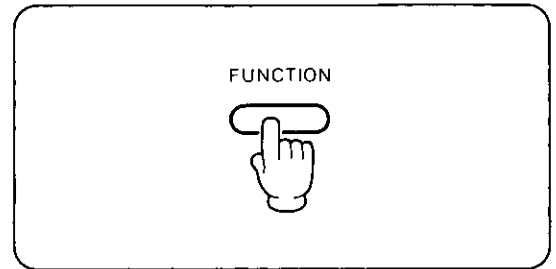

•The PROGRAM indicator will go out.

FACSIMILE

[INDIVIDUAL TRANSMISSION REPORT Example]

No.	OTHER FACSIMILE	< TX REPORT >	PAGES	RESULT
01	<F1>		01	OK

Activity Report (JOURNAL)

The **JOURNAL** is a record of the last 30 transactions (transmission and receptions). It is printed out automatically after every 30 transactions when the JOURNAL is set to the AUTO mode. It may also be printed out on request.

The Activity Report (JOURNAL) is preset to AUTO.

■ When set to the AUTO mode:

The Activity Report will be automatically printed when the memory becomes full (30 transactions).

The journal memory will then be cleared.

■ When set to the MANUAL mode:

The Activity Report will be stored until the memory becomes full. The oldest line of the report will then be deleted.

When printing out the report using the MANUAL mode, refer to "Printout Functions" on page 1-14.

4 Push **AUTO/MEMORY** to store your selection.

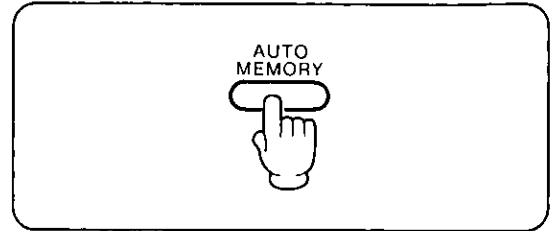

5 Push **FUNCTION** to end the operation.

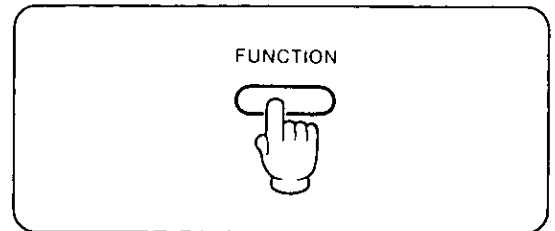

1 Push **FUNCTION**.

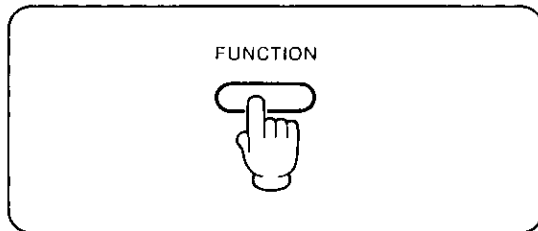

•The PROGRAM indicator will light.

2 Push "#", then push "0" and "7" for JOURNAL setting.

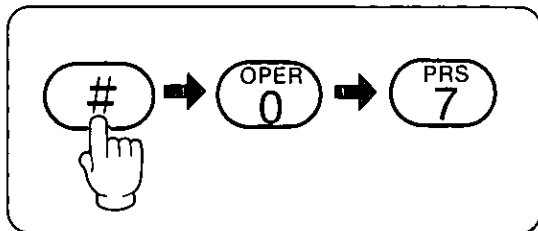

3 Push "2" to set to MANUAL mode.

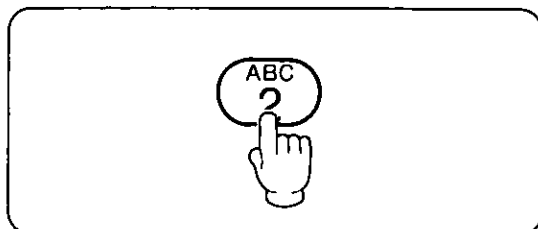

•If you wish to change to AUTO mode, push "1" instead of pushing "2".

Printout Function

A list of Transmissions/Receptions (**JOURNAL**) and/or Stored Phone Numbers (**TEL LIST**) can be printed out on request.

List of Transmissions/Receptions (JOURNAL)

This is a report of the last 30 transmissions and receptions. If there was no activity, no JOURNAL will be printed.

Stored Phone Numbers (TEL LIST)

This is a list of stored phone number for One-Touch and Speed dialing.

1 Push **FUNCTION**.

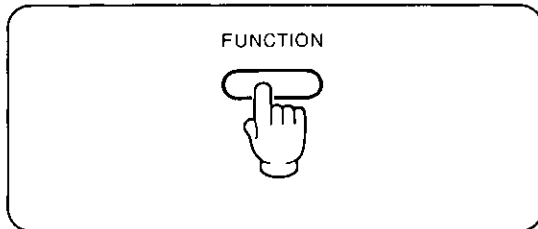

•The PROGRAM indicator will light.

2 Push the buttons as follows.

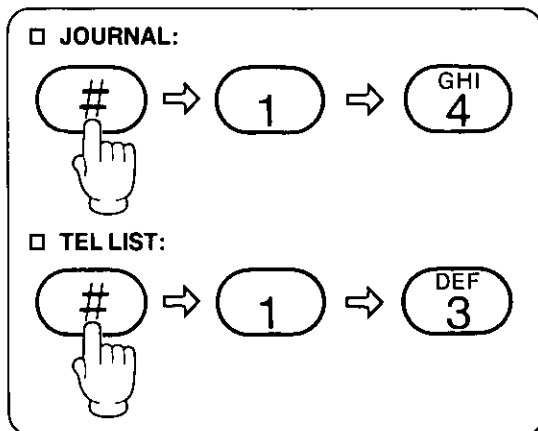

[TEL LIST Example]

<< TELEPHONE NO. LIST >>

TEL NO

01 T222-2222
 02 T2345
 03 T800-447-4700
 04 T205-525-4195
 05 T333-3333
 06 T123-4567
 07 T999

FAX NO

01 T123-1234
 02 T3434
 03 T392-4767
 04 T3435
 05
 06 T123456789
 07 T098-765-4321

Explanation of TEL LIST

- T...When you enter the telephone number with setting the Dialing Mode Selector to the TONE position.
- R...When you enter the telephone number with setting the Dialing Mode Selector to the PULSE position.

00 R526-3057

3 Push **START/COPY** to start printing.

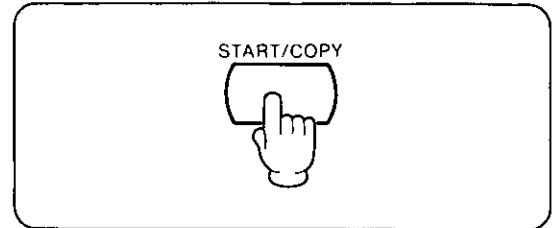

4 Push **FUNCTION** to end the operation.

Printout Function (cont.)

[JOURNAL Example]

<<< JOURNAL >>>

FACSIMILE

(1) No.	(2) OTHER FACSIMILE	(3) MODE	(4) PAGES	(5) RESULT
01	1736852	TX	01	OK
02	INCOMING	RX	01	04
03	<A11>	TX	01	OK
04	<F2>	TX	01	OK
05	INCOMING	TX	01	OK
06	INCOMING	TX	01	OK
07	<F2>	TX	01	02
08	<F2>	TX	00	02
09	INCOMING	RX	00	06
10	<A11>	TX	00	07

Explanation of JOURNAL

(1) Communication number (up to 30)

(2) Dial Number

1736852: The other party's number dialed manually is 1736852

A11: Station No. 11 for Speed Dialing is used.

F2: Station No. 2 for One-Touch Dialing is used.

INCOMING: Document or telephone call is received.

(3) Transmission/Reception

TX: Transmission

RX: Reception

(4) Number of pages transmitted or received successfully

(5) Communication result

OK: Successful completion

Numeral: Error code (See Error code below.)

CODE	DESCRIPTION	CODE	DESCRIPTION
01	When the power unit overheats. Allow unit to cool.	04	When transmission/reception error occurs.
02	When transmission is interrupted by pushing the STOP/CLEAR button.	05	When the printhead overheats. Allow unit to cool.
		06	When the unit is out of paper. Check paper.
03	When a document is jammed or does not feed into the unit. Check paper path.	07	When the cover is opened. Check Cover Latch.

How to Operate as an Answering Machine

Table of Contents

Preparing the Answering Machine	2-1
Recording OGM	2-1
Selecting the Caller's Recording Time	2-1
Selecting the Remote Code No. for Remote Operation	2-2
Setting Up the Automatic Answer Mode	2-3
Preparing the ICM Tape	2-3
Operating the Answering Machine	2-4
Playing Back Your Messages	2-4
Call Counter	2-4
Saving Your Messages	2-4
Erasing the ICM	2-5
Monitoring Incoming Calls	2-5
Message Memo	2-6
Recording a 2 Way Conversation	2-6
How to Operate from a Remote Phone	2-7
Turning On the Automatic Answer Mode from a Remote Phone	2-7
Playing Back Messages	2-7
Memory Playback	2-8
Back Space and Skip Forward	2-8
Recording a Marker Message	2-8
Remote Reset	2-9
Skipping OGM for ICM Recording	2-9
Turning On the Speakerphone (Answer Back)	2-10
Changing the OGM	2-11

Preparing the Answering Machine

To use the unit as an Answering Machine, you should first record an Outgoing Message (OGM).

- The purpose of the OGM is to answer the caller during your absence.
- To have calls answered automatically during your absence, set the unit to the Automatic Answer (AUTO ANS) mode.
- To record voice messages, select the recording time.

Recording OGM

See "Preparation-OGM Recording" on page 1-5.

Selecting the Caller's Recording Time

The Recording Time for Incoming Messages can be set to "VOX" or "1 minute".

Be sure that the handset is on the cradle and that the SP-PHONE button is off.

The Recording time is preset to "VOX".

■ VOX:

The unit will record an Incoming Message for as long as the caller speaks.

■ 1 Minute:

The unit will record an Incoming Message (ICM) up to 1 minute.

- 1 Push **FUNCTION**.

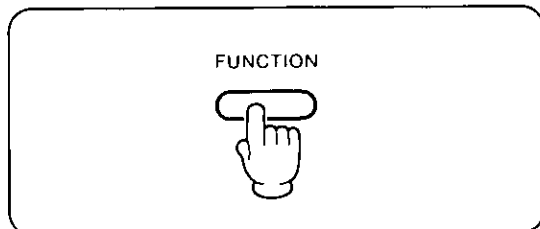

- The PROGRAM indicator will light.

- 2 Push "#", then push "0" and "3" for recording time setting.

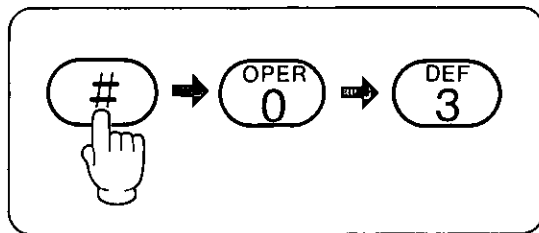

- 3 Push the button as follows.

- Push "1" to set to "VOX".



- Push "2" to set to "1 Minute".



- 4 Push **AUTO/MEMORY**.

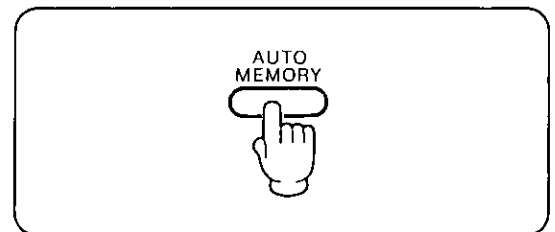

- After pushing the AUTO/MEMORY button, you may go directly to step 2, "Selecting the Remote Code No. for Remote Operation" if you wish.

- 5 Push **FUNCTION** to end the operation.

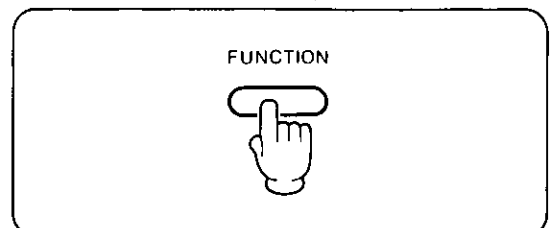

- The PROGRAM indicator will go out.

Preparing the Answering Machine (cont.)

Selecting the Remote Code No. for Remote Operation

A remote code helps to protect from unauthorized persons accessing your unit and retrieving your messages. The remote code No. has been set to 111 at the factory. However, you may choose another code from within the following ranges:

Single Digit 1 to 9
Double Digit 11 to 99
Triple Digit 111 to 999

1 Push **FUNCTION**.

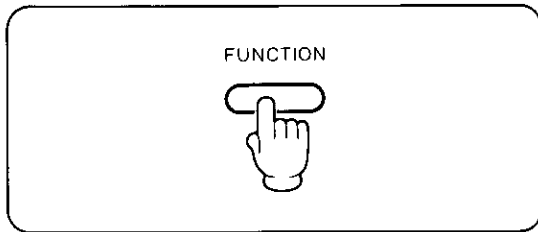

•The PROGRAM indicator will light.

2 Push "#", then push "0" and "2" for remote code setting.

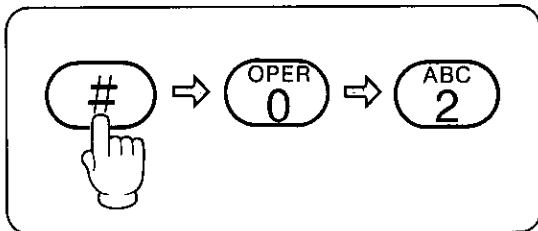

3 Enter the desired **Remote Code** and then push **AUTO/MEMORY**.
(e.g. If the remote code is 123)

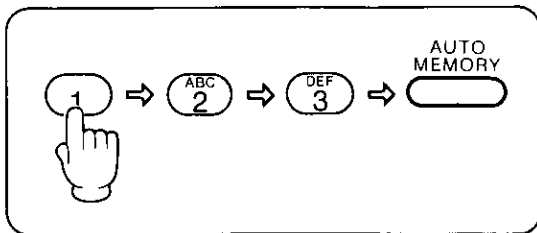

4 Push **FUNCTION** to end the operation.

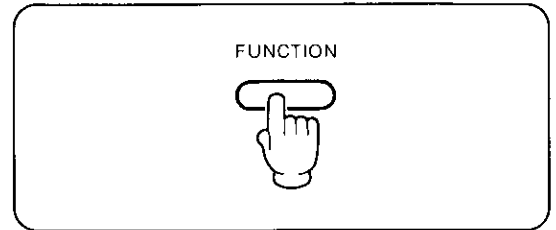

•The PROGRAM indicator will go out.

NOTE:

You cannot use codes which contain zero (0). We recommend that you do not use seven (7) as a code No., since this number is used to control other remote functions.

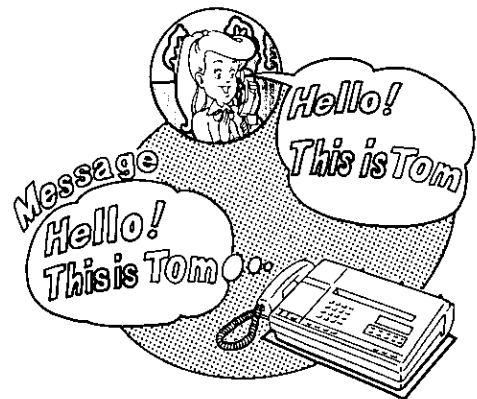

Preparing the Answering Machine (cont.)

Setting Up the Automatic Answer Mode

- 1 Push **AUTO ANS.**

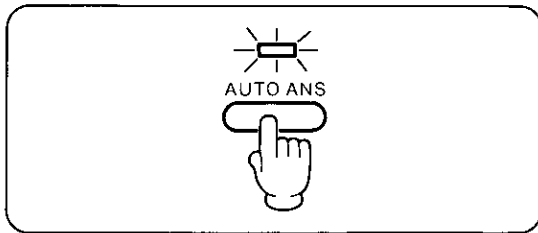

• The AUTO ANSWER indicator will light.

- 2 Set **AUTO/FAX selector** to **AUTO**.

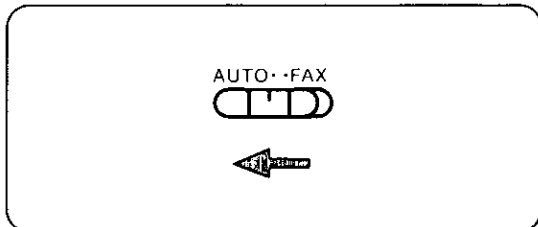

- Before leaving the office, confirm that the AUTO ANSWER indicator is lit and the AUTO/FAX selector is set to AUTO or FAX (as needed).

AUTO/FAX Selector

AUTO Position

When a call is received, the unit will answer and begin playing your OGM. If the caller's voice is not heard within 5 seconds of the end of the OGM or the caller pushes the asterisk (*) button, the FAX mode will automatically be selected.

If a voice is detected, the unit will function as an Answering Machine.

FAX Position

When a call is received, the unit will function as a Facsimile (FAX) Machine only. No OGM will be played and no messages can be left on the answering machine. Remote operation (from another phone) is also impossible.

- To cancel the Automatic Answer mode, push the AUTO ANS button. The AUTO ANSWER indicator will go out. The unit will now function as a telephone.

Preparing the ICM Tape

After reviewing the Outgoing or Incoming Messages, the unit will automatically reset itself to the Automatic Answer mode and will be ready to answer the next call.

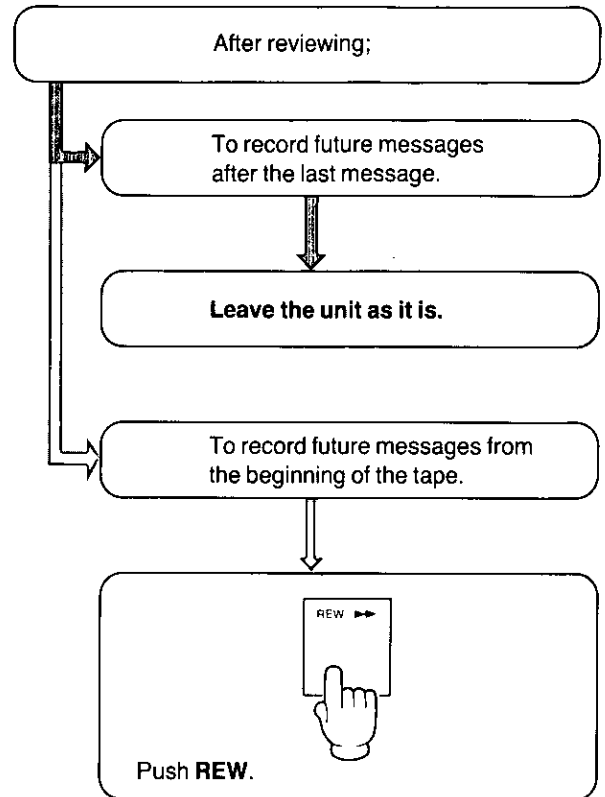

- If you use a new ICM tape, push the REW button to reset the tape.

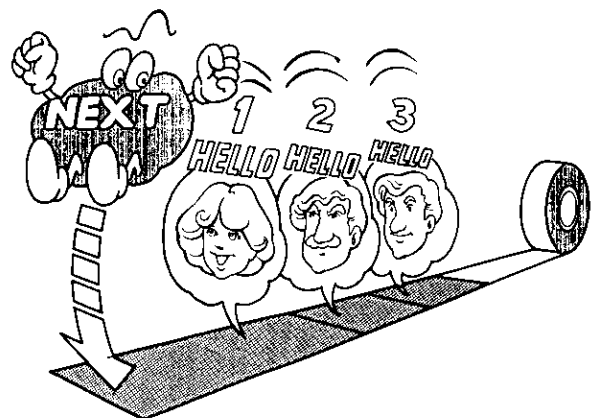

ANSWERING MACHINE

Operating the Answering Machine

Playing Back Your Messages

- 1 Push **PLAYBACK/PAUSE**.

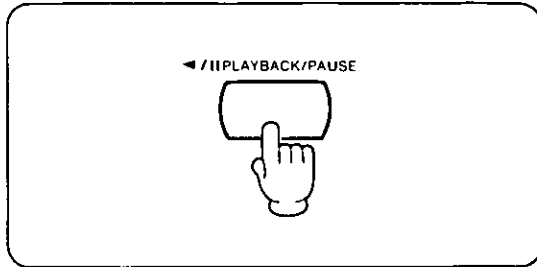

□ Auto-Logic (One Touch Operation)

At the touch of the **PLAYBACK/PAUSE** button, the unit will automatically rewind, playback all the recorded messages and stop. After 7 seconds, the unit will reset itself to the Automatic Answer mode. All calls will be automatically saved.

- Future Incoming Messages will be recorded after the last message.
- To record the future messages from the beginning of the tape, push the **REW** button.

□ To stop the tape temporarily:

- 1 Push **PLAYBACK/PAUSE**.

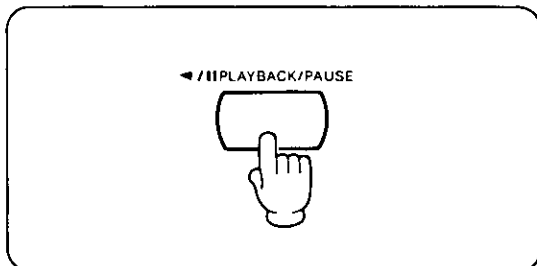

- The **IN USE** indicator will flash.
- To restart, push the **PLAYBACK/PAUSE** button again.
- While pausing, the unit does not answer a call automatically.

□ To Rewind the Tape:

Push the **REW** button.

□ To Fast Forward the Tape:

Push the **FF** button.

Call Counter

The unit will show you the number of recorded voice messages by flashing of the **AUTO ANSWER** indicator. (i.e. Three flashes, follows by a pause means 3 messages were received)

In the case of a power interruption, **AUTO ANSWER** indicator will flash slowly after the power is restored. At this time, confirm your **OGM**. If the **OGM** is erased, replace all of the batteries early. Otherwise lack of your **OGM** occurs every time a power failure occurs.

Saving Your Messages

You can save your messages as follows:

- 1 Play back the tape to the end of the message you want to save then push **REW** and **PLAYBACK/PAUSE** simultaneously.

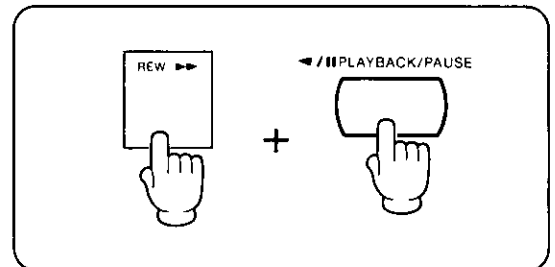

- The unit will go into the Answer mode and future Incoming Messages will be recorded after the messages you have saved.

Operating the Answering Machine (cont.)

Erasing the ICM

To Erase the Recorded Messages:

Wait until the last message has played back and the tape stops.

- 1 Push **REC**, while holding it, push **REW** until a beep is heard.

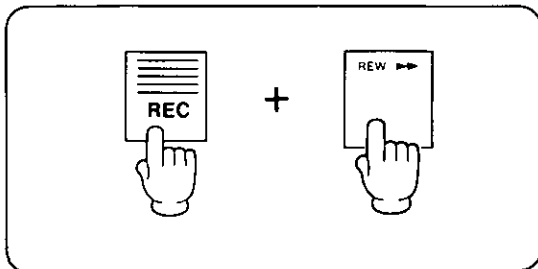

- The messages will be erased while the tape is rewinding.

NOTE:

The tape can be erased at high speed even if the record-prevention (knock-out) tabs have been removed.

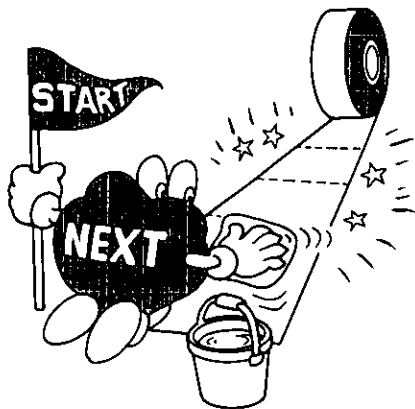
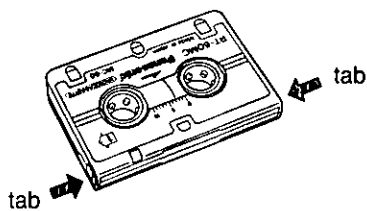

Monitoring Incoming Calls

While an Incoming Message is being recorded, you can monitor it through the built-in speaker by adjusting the **SPEAKER VOLUME** control.

To speak to the caller directly:

- 1 Lift the handset or push **SP-PHONE** and speak.

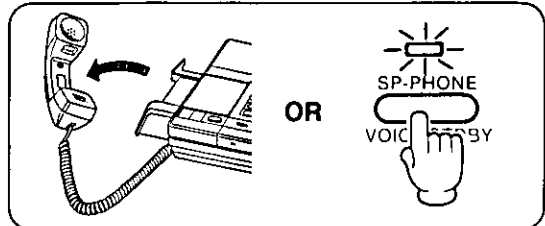

- The tape will stop.



Operating the Answering Machine (cont.)

Message Memo

You can record a confidential message on the Incoming Message tape (ICM) which can be retrieved by anyone with your remote code number.

- 1 Push **2 WAY/MEMO** until a beep is heard.

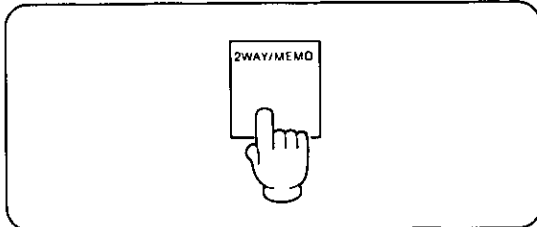

•The IN USE indicator will light.

- 2 Speak into the **Microphone** to record your message about 8 inches away.

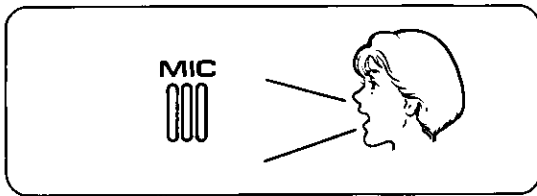

- 3 When you are finished, push **2 WAY/MEMO** again.

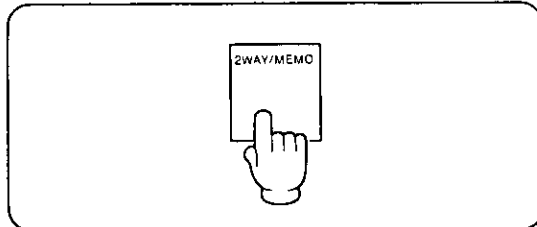

•The IN USE indicator will go out.
•The unit will return to the Auto Answer mode if the AUTO ANS indicator is on.

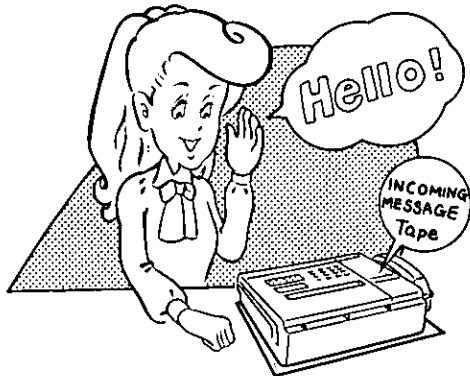

Recording a 2 Way Conversation

While speaking with someone on the telephone, you can record the conversation, **however, many states have regulations in which 2-Way Telephone Conversations may be recorded**, so you should first consult your public utility agency before using this feature.

□ To record a 2-Way Conversation:

- 1 While speaking, push **2 WAY/MEMO** until a beep is heard.

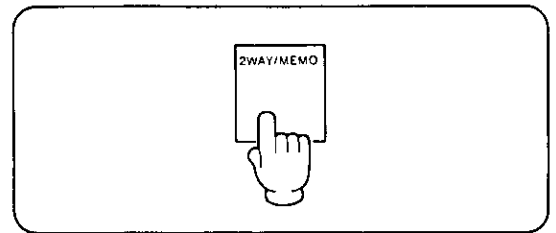

•The IN USE indicator will light.

- 2 Talk with the other party.



•The unit will generate a beep every 15 seconds to notify the caller that the conversation is being recorded.

- 3 When you are finished, push **2 WAY/MEMO** again.

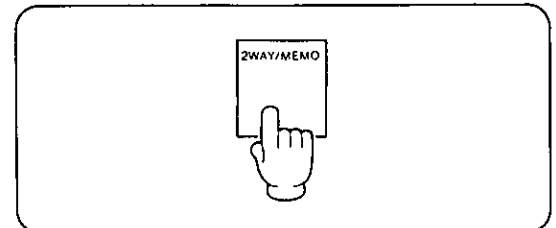

•The IN USE indicator will go out.

How to Operate from a Remote Phone

You can use a tone phone to listen your recorded Incoming Messages, from a remote phone.
Before remote operation, the Remote Code number must be set. (See page 2-2.)

Turning On the Automatic Answer Mode from a Remote Phone

If you forget to turn your unit to the Automatic Answer mode before leaving your office, you may turn it on from a remote location, using any telephone.

- 1 Call your unit and wait for 15 rings.

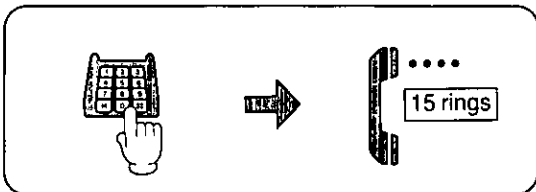

•After 15 rings, the unit will switch to the Automatic Answer mode.

- 2 After hearing the OGM or the beep tone, hang up.

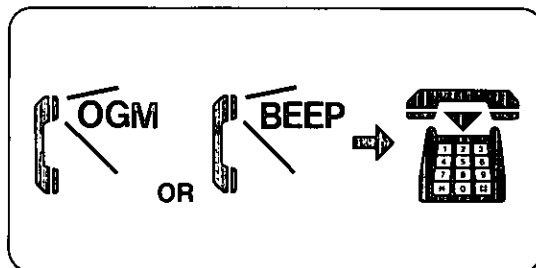

- If the AUTO/FAX selector is set to "AUTO", the unit will begin to play the OGM.
- If the AUTO/FAX selector is set to "FAX", you will hear several "beeps" (answering carrier tone of your unit).

NOTES:

- If you hear nothing, record a new OGM.
- A beep will be heard after the OGM.
 - 1 beep: You may hang up.
 - 6 beeps: The tape is full. Reset the tape. See "Remote Reset of Tape" on page 2-9.

Playing Back Messages

- 1 Call your unit.

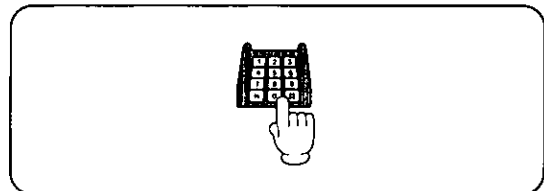

- 2 Push your code No. during the OGM.

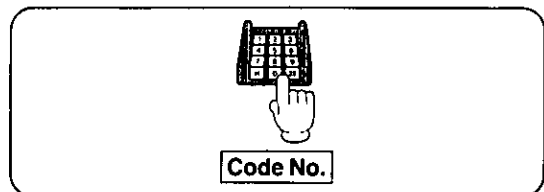

- A beep will sound, followed by other (up to 8) beeps, which represent the number of recorded messages.
- Another series of short beeps will be heard as the ICM tape is rewinding and then your message will be played.

- 3 Listen to messages.

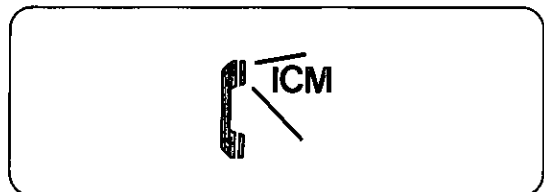

•3 beeps will be heard after the last message.

- 4 Hang up the handset.



•All calls will be automatically saved.

How to Operate from a Remote Phone (cont.)

Memory Playback

If you have already heard your old messages from a remote phone, you can skip them and only listen to the newly recorded ones.

- 1 Call your unit.

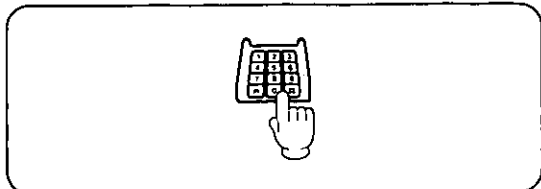

- 2 Push your code No. during the OGM.

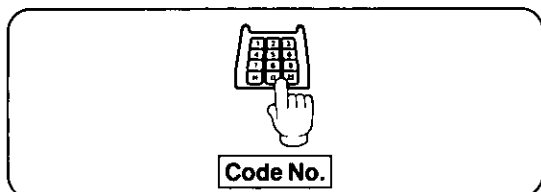

- 3 After hearing the beeps, push "4" immediately.

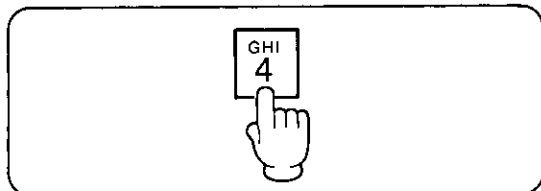

- The beeps indicate the number of recorded messages.
- During the playback of previously heard messages, you can also skip them by pushing "4".

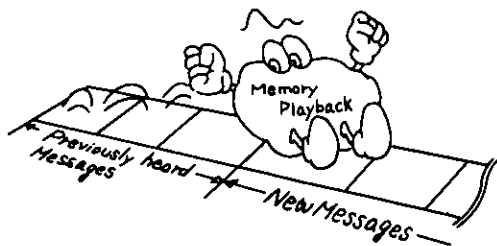

Back Space and Skip Forward

After listening to the recorded messages or while they are playing, you can skip forward or back space.

- **Back Space:**

- 1 Push "1".

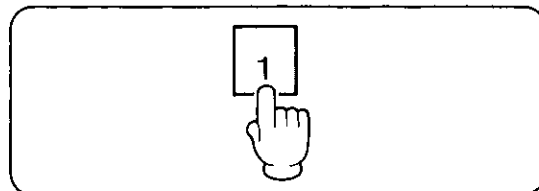

- **Skip Forward:**

- 1 Push "2".

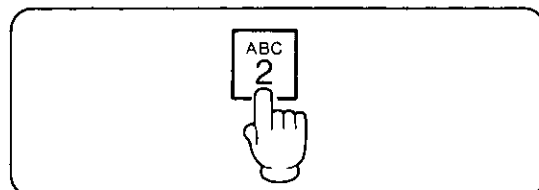

- The tape will rewind or advance for approximately 15 seconds of playback time, and not to the beginning or end of a message.

Recording a Marker Message

After reviewing all the messages, you can leave your index message on the tape to be heard by anyone who has your remote code.

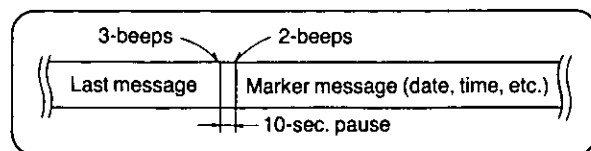

- 3 beep tones will be heard after the last message has been played, followed by a 10-second pause, and then 2 more beep tones.

- 1 Speak immediately after the last 2 beeps.

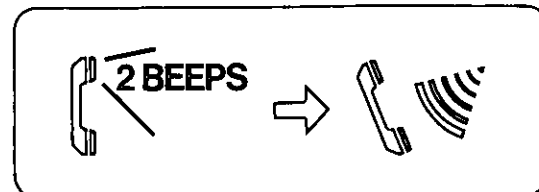

- 2 When you are finished, hang up.

ANSWERING MACHINE

How to Operate from a Remote Phone (cont.)

Remote Reset

To record new Incoming Messages from the beginning of the tape.

■ **After the recorded messages have been played back or while they are playing back;**

- 1 Push "3" and then hang up.

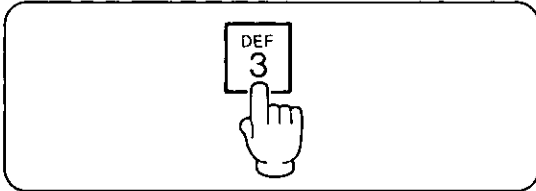

• The unit will rewind to the beginning of the tape and reset itself.

■ **If you have used the Memory Playback;**

- 1 Push "3".

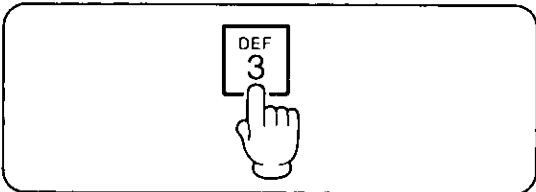

• The unit will rewind to the beginning of the newly recorded messages and a beep will be heard.

- 2 Push "3" again to advance to the beginning of the tape.

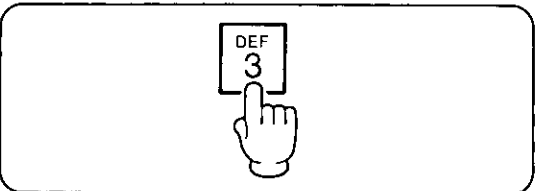

• A beep tone will be heard and future Incoming Messages will be recorded from the beginning of the tape.

■ **To cancel the Remote Reset (All calls will be saved.);**

Push "2" after the tape has been reset (one beep) and then hang up.

Skipping OGM for ICM Recording

If you would like to leave a message on your unit, but do not want to listen to your Outgoing Message before doing so, you can switch directly to the Incoming Message (Recording) Mode.

- 1 Call your unit.

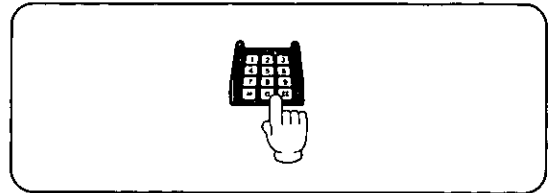

- 2 Push "0" during OGM (instead of your Code No.).

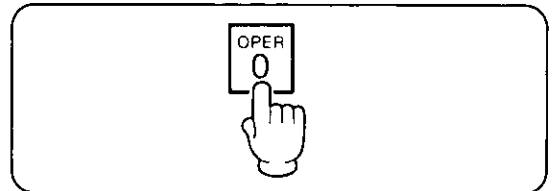

• One beep will be heard and the unit will go directly to the Incoming Messages mode.

- 3 After hearing a long beep, speak clearly and loudly to record your message.

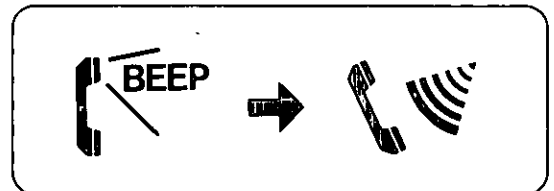

How to Operate from a Remote Phone (cont.)

Turning On the Speakerphone (Answer Back)

You may screen the room where the unit is installed for sound, by turning the speakerphone on remotely. You can speak with anyone in the room, even if they can not reach the unit.

1 Call your unit.

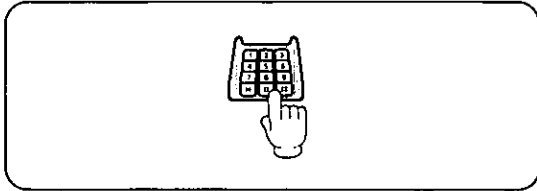

2 Push your **code No.** during OGM.

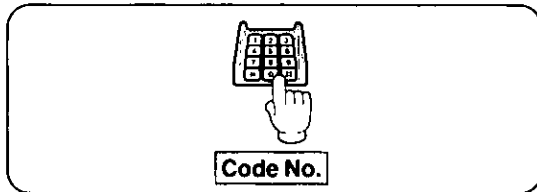

3 After hearing the beeps, push "6" immediately.

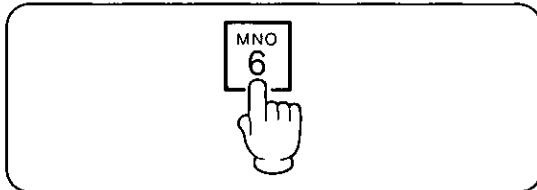

□ If you want to talk to the other party in the room:

Ask the other party to pick up the handset or push the SP-PHONE button, and start the conversation.

• If no one picks up the handset or pushes the SP-PHONE button, the line will terminate after 30 seconds.

• To use this Answer Back function, position the SPEAKER VOLUME control for normal use, otherwise it may be difficult for anyone to hear you from the speakerphone.

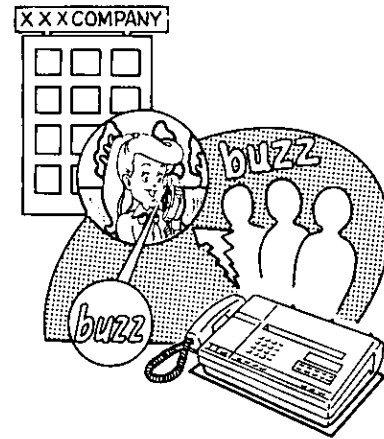

- The beeps indicate the number of recorded messages.
- The speakerphone of your unit will be turned on.
- You can monitor the room for 30 seconds.
- To monitor further, push "6" again within 10 seconds of the beep.

How to Operate from a Remote Phone (cont.)

Changing the OGM

You can record a new Outgoing Message from a remote phone.

- 1 Call your unit.

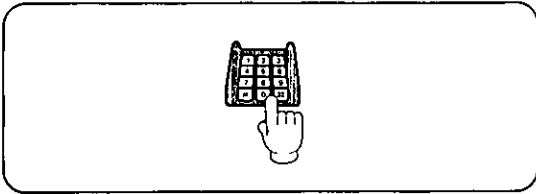

- 2 Push your **code No.** during OGM.

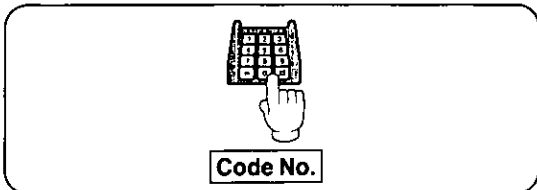

- 3 After hearing the beeps, push "7" immediately.

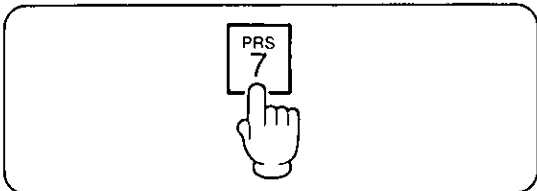

- The beeps indicate the number of recorded messages.

- 4 After hearing a long beep, speak clearly and loudly for up to 16 seconds.

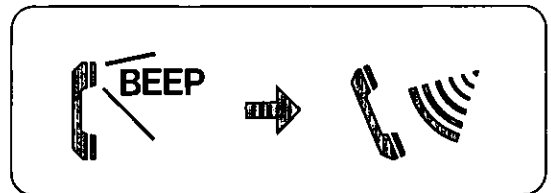

- 5 When you are finished, push "9".

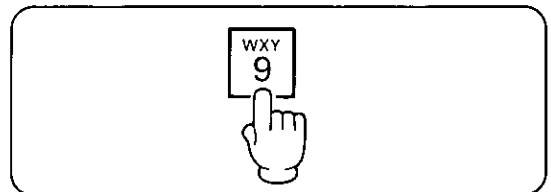

- The new Outgoing Message will be played back.

NOTES:

- In some areas, a remote tone phone may not function due to telephone line conditions such as line noise, echo, etc.
- The unit may not respond if tones produced by the telephone are too short.

How to Operate as a Telephone

Table of Contents

Manual Dialing and Reception	3-1
Making a Call	3-1
Receiving a Call.....	3-1
Redialing	3-1
Switching to Hands-free or Handset Operation during a Conversation	3-2
Handset to Hands-free	3-2
Hands-free to Handset	3-2
Speed Dialing and One-Touch Dialing	3-3
Programming the Phone Numbers for Speed Dialing	3-3
Programming the FAX/Phone Numbers for One-Touch Dialing	3-4
Erasing the Stored Numbers	3-5
Dialing	3-5
Other Features	3-6
How to Store a Secret Phone Number	3-6
Mute Operation	3-7
Flash Button Usage	3-7
Tone Button Usage	3-7
Combination Dialing	3-7
Outside Line or Computer Accessed Line (Pause Usage)	3-7

Manual Dialing and Reception

Making a Call

■ Using the Handset

- 1 Lift the handset and dial the phone number.
- 2 Speak with the other party.
- 3 Hang up the handset when finished.

■ On-hook Dialing

- 1 Push **SP-PHONE**.

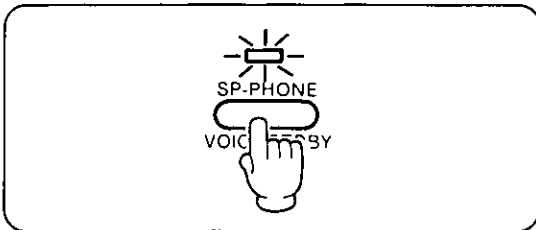

- The SP-PHONE indicator will light.

- 2 Dial the phone number and speak.

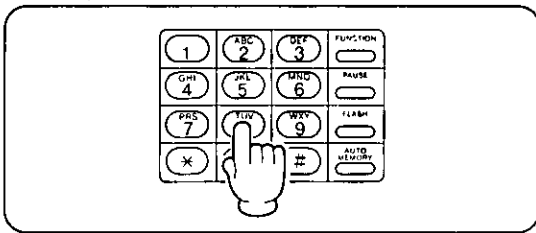

- 3 When finished, push **SP-PHONE** again.

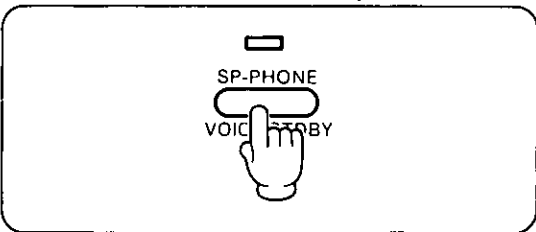

- The SP-PHONE indicator will go out.

NOTE:

During dialing, the MUTE indicator will remain lit. When dialing is completed, it will go out. However, if TONE detect function is selected to off, this feature is disabled.

Receiving a Call

- 1 Lift the handset or push **SP-PHONE** and speak.

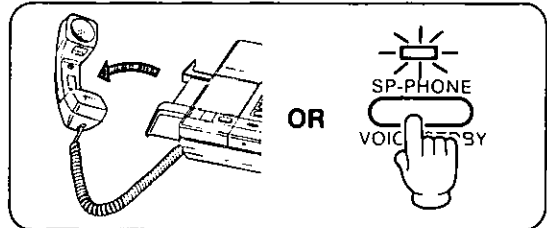

Redialing

You can redial the last dialed number by simply pushing the REDIAL button.

- 1 Push **REDIAL** if the line is busy.

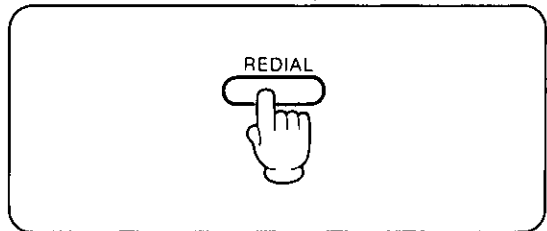

■ When using the handset:

Depressing the REDIAL button causes the last number to be redialed once.

■ When using the speakerphone: (Automatic Redialing)

The unit will automatically redial the last number dialed up to 15 times within a 10-minute period.

- During the pause between each redialing, the SP-PHONE indicator will blink slowly.
- To cancel the automatic redialing, push the FLASH button.

Switching to Hands-free or Handset Operation during a Conversation

You may choose to switch to the handset or the speakerphone during a conversation.

Handset → Hands-free Switch to

- 1 Push **SP-PHONE** and **continue speaking**.

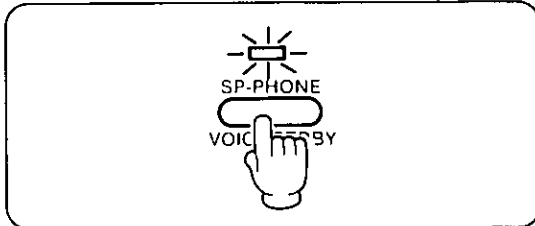

•The SP-PHONE indicator will light.

- 2 **Replace the handset** onto the cradle.

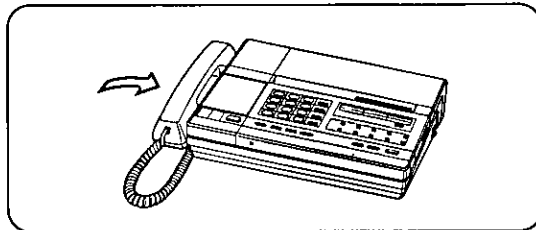

•If you replace the handset onto the cradle before pushing the SP-PHONE button, the conversation will be cut off.

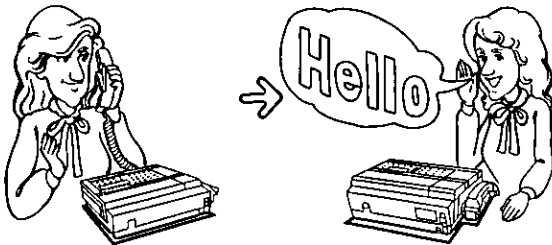

Hands-free → Handset Switch to

- 1 **Lift the handset** while speaking in a Hands-free Operation.

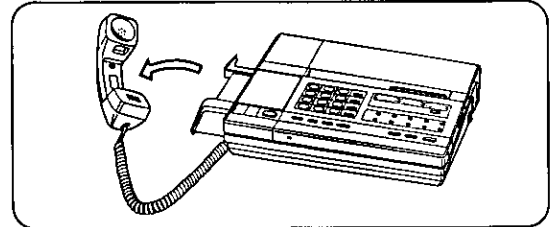

•The SP-PHONE indicator will go out.

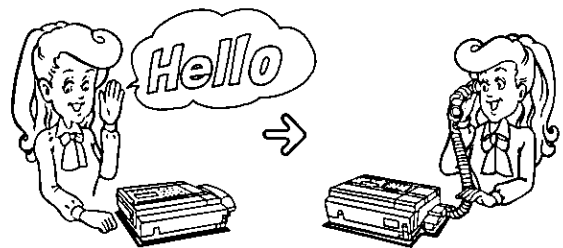

HELPFUL HINTS FOR HANDS-FREE:

•If it is difficult to hear the other party's voice when using the speakerphone:

Raise the sound level using the **SPEAKER VOLUME** control.

•Lower the sound level if the other party has difficulty hearing you.

•Absorbing echoes:

Use this unit in a room which has curtains or carpeting.

•To avoid lost or broken conversations:

If you and the caller speak at the same time, parts of your conversation will be lost. To avoid this, speak alternately.

Speed Dialing and One-Touch Dialing

SPEED DIALING:

The unit allows keys "0" to "9" on the dial pad to be used for an additional 100 memory stations. These stations can then be accessed by dialing two digits ("00" through "99"). Each station is capable of storing 30 digits.

ONE-TOUCH DIALING:

The unit is also equipped with ten One-Touch dialing stations (using the DIRECT CALL buttons), each of which consists of two locations; Telephone and FAX Number. Each location (Telephone/FAX No.) is capable of storing 30 digits.

Programming the Phone Numbers for Speed Dialing

- Be sure that the handset is on the cradle and that the SP-PHONE button is off.

1 Push FUNCTION.

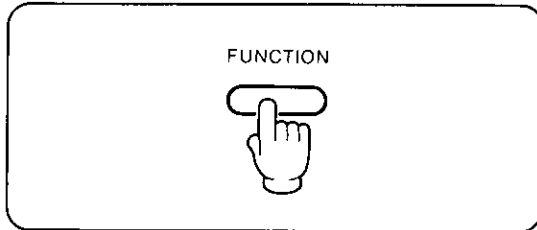

- The PROGRAM indicator will light.

4 Push FUNCTION to end the operation.

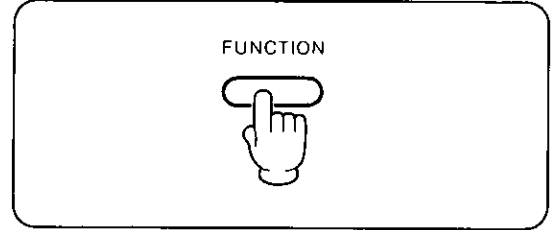

- The PROGRAM indicator will go out.

2 Enter the Station No. (00 to 99, 2 digits). (e.g. If the Station No. is 46.)

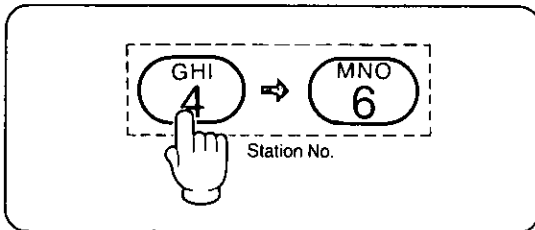

3 Enter the telephone number, then push AUTO/MEMORY. (e.g. Phone number is 234-5678.)

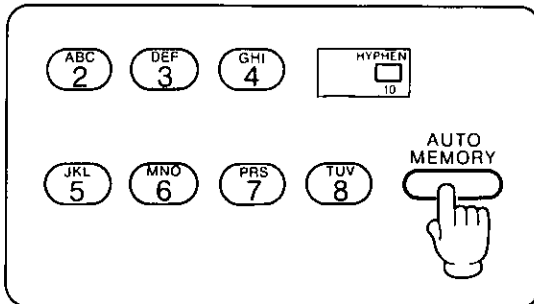

- To store phone numbers in succession, repeat steps 2 and 3.
- A maximum of 30 digits may be stored.

- You may also store FAX numbers into the Speed Dial keys similarly.

- **Correcting an error while programming:**
Push the STOP/CLEAR button instead of pushing the AUTO/MEMORY button and then re-program the correct number.

- The new entry will be cleared and the previous storage will remain untouched.

- **Confirming a stored number:**

Repeat storing the same number into the same station. When AUTO/MEMORY button is pushed, a beep will be heard.

- **Twice:**

The entry is the same as what was previously stored.

- **Once:**

The entry is different from the one that was previously stored. Repeat the procedure of storing.

- To print out the stored phone number, see page 1-14.

Speed Dialing and One-Touch Dialing (cont.)

Programming the FAX/Phone Numbers for One-Touch Dialing

• Be sure that the handset is on the cradle and that the SP-PHONE button is off.

1 Push **FUNCTION**.

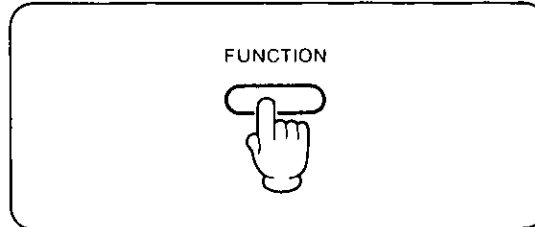

• The PROGRAM indicator will light.

Storing Phone No.
(Into the telephone number memory location)

2 Push a **DIRECT CALL** button.
(e.g. If the Direct station No. is 4.)

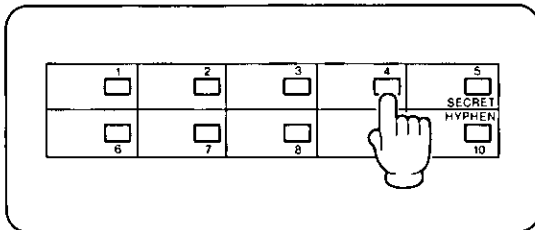

3 Enter the **telephone number**, then push **AUTO/MEMORY**. (e.g. Phone number is 123-4567.)

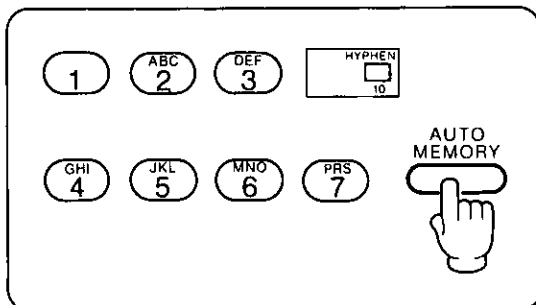

• To store telephone numbers in succession, repeat steps 2 and 3.
• A maximum of 30 digits may be stored.

Storing FAX No.
(Into the FAX number memory location)

2 Push a **DIRECT CALL** button, then push **MODE** to enter the FAX No. (e.g. If the Direct station No. is 4.)

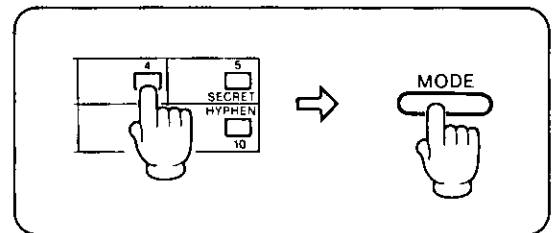

• The FAX/COPY indicator will light.

3 Enter the **FAX number**, then push **AUTO/MEMORY**. (e.g. Phone number is 765-4321.)

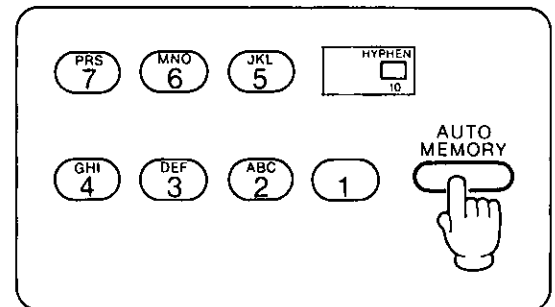

• To store FAX numbers in succession, repeat steps 2 and 3.
• After pushing the Direct Call button, you must push the MODE button to store a FAX number into the FAX memory location.
• A maximum of 30 digits may be stored.

4 Push **FUNCTION** to end the operation.

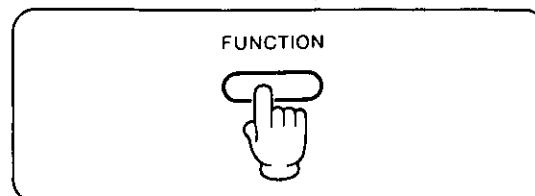

• The PROGRAM indicator will go out.

TELEPHONE

Speed Dialing and One-Touch Dialing (cont.)

Programming the FAX/Phone Numbers for One-Touch Dialing (cont.)

- **Correcting an error while programming:**
Push the **STOP/CLEAR** button instead of pushing the **AUTO/MEMORY** button and then re-program the correct number.
 - If a number was previously stored at this location, it would remain intact.
- **Confirming a stored number:**
Repeat storing the same number into the same station. When **AUTO/MEMORY** button is pushed, a beep will be heard.
 - **Twice:**
The entry is the same as what was previously stored.
 - **Once:**
The entry is different from the one that was previously stored. Repeat the procedure of storing.
- **To print out the stored numbers, see page 1-14.**

Erasing the Stored Numbers

Example: To erase the number in memory station "02".

- 1 Push **FUNCTION**.
 - The PROGRAM indicator will light.
- 2 Push "02" and then **AUTO/MEMORY**.

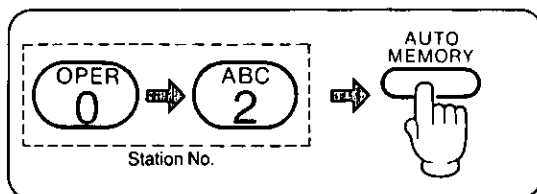

- 3 Push **FUNCTION** to end the operation.
 - The PROGRAM indicator will go out.
 - You can also erase the stored phone/FAX number for One-Touch Dialing by pushing the **DIRECT CALL** button instead of the memory station at step 2.
Be sure to push the **MODE** button after pushing the **DIRECT CALL** button when you erase the FAX number of the FAX memory location.

Dialing

- 1 Lift the handset or push **SP-PHONE**.

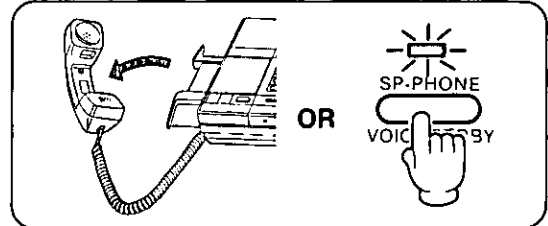

- 2 **Using Speed Dialing:**
Push **AUTO** and then push the **Station No.**
(e.g. If the Station No. is 12.)

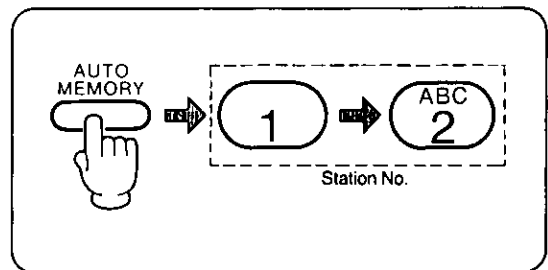

Using One-Touch Dialing:

Push **DIRECT CALL**.
(e.g. If the Direct station No. is 3.)

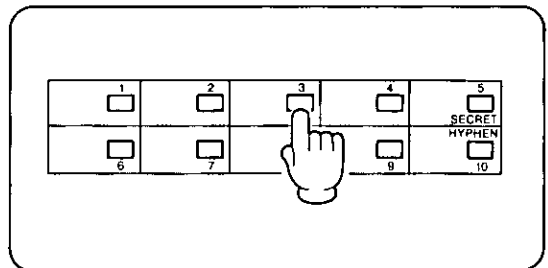

NOTE:

When you push the DIRECT CALL Button;

- If a document has been placed onto the **DOCUMENT** holder (The **FAX/COPY** indicator lights.), the unit will dial the number using the **FAX** memory location.
- If the **DOCUMENT** holder is empty, the unit will dial the number using the **telephone** memory location.

Other Features

How to Store a Secret Phone Numbers

This function is useful for keeping a FAX/Phone No. (or a portion of it) secret, when you print out the list of phone numbers, using the Printout Function. (Refer to "Printout Function" on page 1-14.)

Be sure that the handset is on the cradle and that the SP-PHONE button is off.

Example:

Store the phone No. 123-4567 into the telephone memory location as a secret No.

1 Push **FUNCTION**.

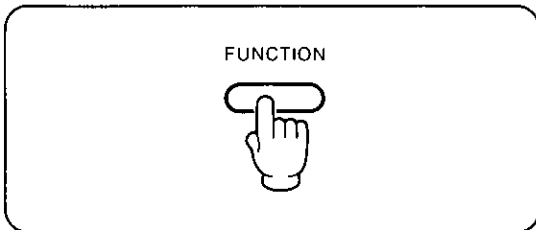

•The PROGRAM indicator will light.

2 Push a **DIRECT CALL** button.
(e.g. If the Direct station No. is 3.)

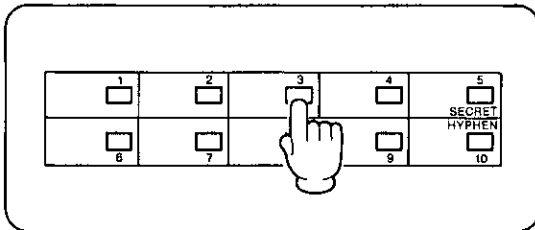

3 Enter the telephone number.

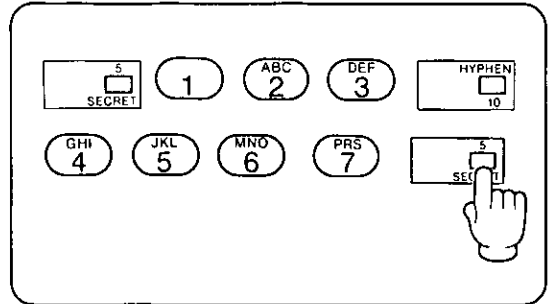

4 Push **AUTO/MEMORY**.

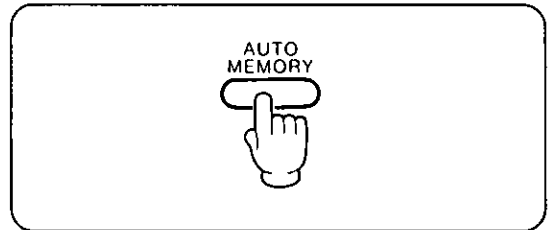

□ Confirming a stored number:

Repeat storing the same number into the same station. When AUTO/MEMORY button is pushed, a beep will be heard.

•**Twice:**

The entry is the same as what was previously stored.

•**Once:**

The entry is different from the one that was previously stored. Repeat the procedure of storing.

NOTE:

When you print out your list of phone number, the secret numbers will not be printed.
(Refer to TEL LIST Example as shown below.)

[TEL LIST Example]

<< TELEPHONE NO. LIST >>

TEL NO

01 T123-4567

02 T321-8546

03 T[]

04 T951-5624

05

06

Secret Phone No.

FAX NO

01 T452-6523

02 T784-6589

03 T126-5468

04 T841-5847

05

TELEPHONE

Other Features (cont.)

Mute Operation

Use this feature when you do not want your voice to be heard by the other party.

- 1 Push **MUTE**.

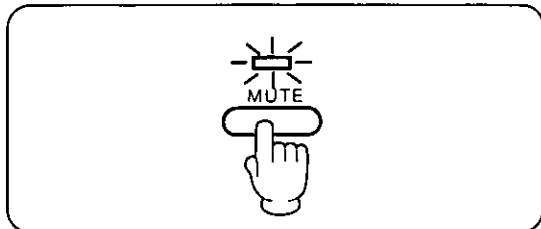

- The MUTE indicator will light.

■ To resume the conversation:

Push the MUTE button again.

- The MUTE indicator will go out.

Flash Button Usage

You can access some of the features of your host PBX by using the FLASH button instead of the Hookswitch. This is done by pushing the FLASH button lightly when required. "FLASH" can also be stored in memory the same as "Programming Phone Numbers" on page 3-3.

Tone Button Usage

If you wish to change from Pulse to Tone while dialing you may do so by pressing, the "**TONE (*)**" button instead of changing the DIALING MODE selector.

When you hang up, the unit will automatically return to the Pulse mode.

Combination Dialing

Any of the following dialing combinations is possible.

- Automatic and Manual Dialing
- Pulse and Tone Dialing
- Plural Memory Stations

Outside Line or Computer Accessed Line (Pause Usage)

Using the PAUSE button function during a dial operation is helpful when accessing an outside line or a computer accessed long distance service.

■ One pause is required when waiting for an outside dial tone.

Example (PBX):

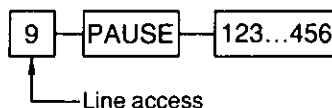

Some PBXs require this pause during an automatic redial.

■ Two pauses are required when waiting for a computer tone from long distance service companies such as MCI, SPRINT, METRO and others.

Example:

Local access telephone number for the alternate long distance service company **123-5434**,

Authorization no. **563478**,

Long distance no. **901-210-9812**

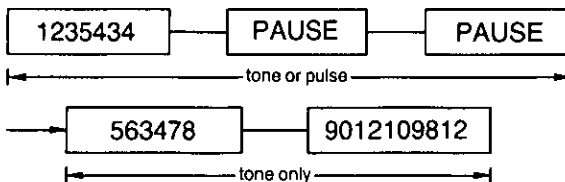

- The above numbers are used as examples only.

NOTE:

- Pushing the PAUSE button once counts as 1 digit.
- Pushing the TONE button counts as 1 digit. (Refer to "Tone button Usage".)
- A maximum of 30 digits may be used.

General Information

Table of Contents

Recording Paper Installation	4-1
Troubleshooting Guide	4-2
Glossary of Terms	4-5

Recording Paper Installation

Follow the steps below to install the recording paper.

Replace the recording paper roll when the end mark appears on the both sides of the paper (red line). When the roll is finished, your facsimile will stop receiving and the PAPER OUT indicator will light.

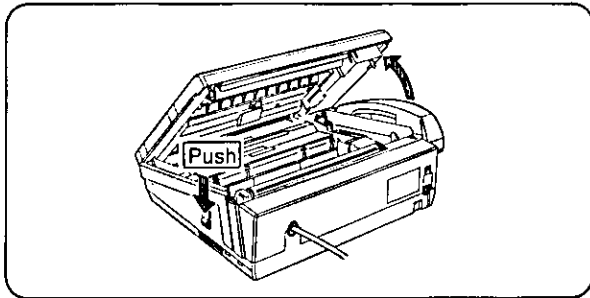

- 1 Push the LATCH button to open the cover.
 - The ALARM indicator will light.

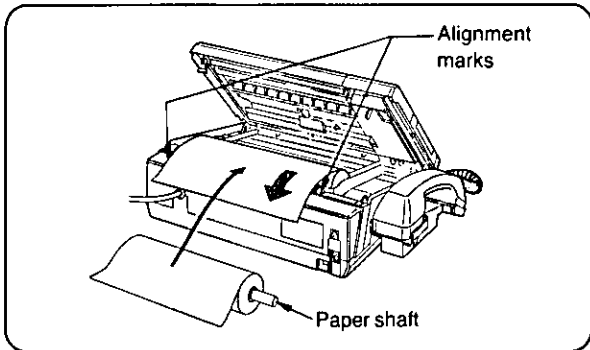

- 2 Insert the paper shaft into the recording paper (Panasonic KX-A101) and then insert the recording paper as shown so that it feeds from the top of the roll and a few inches of paper extend out of the unit.
 - Align the recording paper with two Alignment marks.
 - Use the paper shaft included with this unit to prevent the recording paper from jamming.

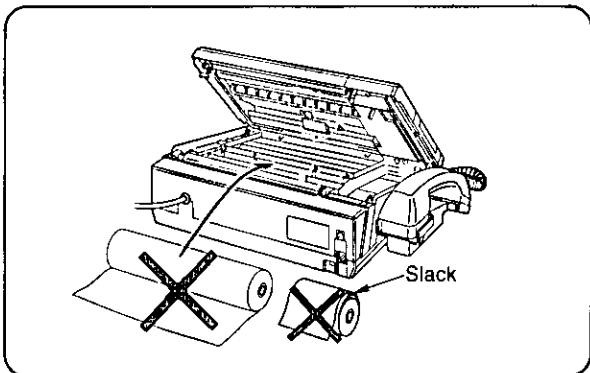

- 3 Make sure that the recording paper is correctly oriented. If it is reversed, no messages will be recorded.
 - To record the messages properly, make sure that the recording paper is not slackened.

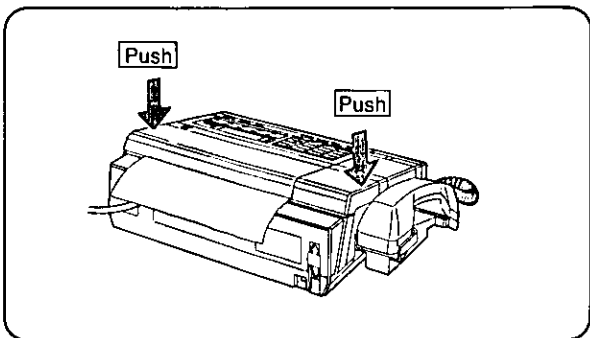

- 4 Close the cover carefully by pressing both ends gently.
 - Confirm the PAPER OUT and ALARM indicators go out.

Troubleshooting Guide

If an error occurs, the following indicators inform you by flashing of lighting.

Problem

Cause & Remedy

ALARM AND PAPER OUT INDICATORS

When the PAPER OUT indicator lights;	the recording paper is finished, replace it.
When the AUTO ANSWER indicator flashes;	a power failure has occurred, confirm whether the voice messages are recorded on the tape or not.
When the ALARM indicator flashes after transmission;	the document was not transmitted, try again.
When the ALARM indicator lights;	<p>A) A document jams during transmission.</p> <p>B) Confirm your OGM. If 6 beeps are heard when you push the OGM button, batteries have become weak and the OGM is erased. Replace all of the batteries. Then re-record a new OGM.</p> <p>C) Confirm that the cover of the unit is closed firmly.</p> <p>D) When the unit overheats, it will stop operating. Do not disconnect the power cord at this time. Operation will automatically resume as soon as the unit has cooled.</p>

FACSIMILE

The ALARM indicator lights during transmission.	<ul style="list-style-type: none"> ◦ Confirm whether the cover is closed completely or not. ◦ When you transmit a document which is longer than 600 mm, the alarm may sound. Open the cover and remove the document. ◦ If you have call waiting service, it may have been activated by another telephone call. Re-connect the unit to a line that does not have call waiting service.
Recording image is scratchy and cannot be read completely.	The Sender transmitted a light density document. Have the other Sender darken the density of a document (e.g. by copying) then have them transmit it again.
The document is not pulled into the unit.	If the document is not properly inserted into the DOCUMENT holder, it may not be pulled into the feeder. Insert the document sufficiently until it stops.
The recording paper jams during reception.	<ul style="list-style-type: none"> ◦ Use the paper shaft included. ◦ Make sure that the recording paper is not slackened.

Troubleshooting Guide (cont.)

Problem

Cause & Remedy

FACSIMILE (CONT.)

<p>The other party complains that documents are being received with distorted letters.</p>	<ul style="list-style-type: none"> ◦Someone may have used a telephone connected in parallel with the unit. ◦If you have call waiting service, it may have been activated by another telephone call. Re-connect the unit to a line that does not have call waiting service.
<p>The unit has been set the Automatic Answer mode, but a document cannot be received automatically.</p>	<p>Confirm whether you have recorded the following OGM-"To send a FAX, push the asterisk button." or not. See page 1-5. If you cannot transmit, see page 1-6.</p>
<p>When using an automatic dialer (One-Touch Transmission), I cannot dial the other party's FAX number.</p>	<p>Confirm whether the FAX number has been stored into the FAX memory station or not. When you place your document into the unit, the unit will automatically select the FAX memory station.</p>
<p>The START/COPY indicator flashes for about 40 seconds after your unit receives a call automatically but nothing is recorded.</p>	<p>The caller hang up during or immediately after the playing of the OGM. This may occur if the disconnect single is not transmitted from the Central Office, and your unit is in normal condition.</p>
<p>The unit does not operate properly in telephone mode, answering machine mode and/or facsimile mode.</p>	<p>Push the RESET button. (found on the bottom of the unit) If the unit does not operate properly even if pushing the RESET button, unplug the AC cord and then plug it in again after 1 minute.</p>
<p>When I receive or copy a document whose background is very dark or containing photographs, the unit may produce a high tone.</p>	<p>This is quite normal.</p>
<p>Problems receiving international facsimiles.</p>	<p>Refer to the INSTALLATION MANUAL, page 13 and 14.</p> <ul style="list-style-type: none"> ◦Shorten OGM to 10 sec. or less. ◦G III receiving speed may need to be set to 4800 bps. ◦CED frequency may need to be set to 1100 Hz.

Troubleshooting Guide (cont.)

Problem

Cause & Remedy

ANSWERING MACHINE

<p>The unit does not work when I push buttons. I cannot remove the cassette from the unit.</p>	<p>Push the RESET button. (found on the bottom of the unit) If the unit does not operate properly even if pushing the RESET button, unplug the AC cord and then plug it in again after 1 minute.</p>
<p>The unit has been set to the Automatic Answer mode, but no Incoming Messages have been recorded.</p>	<ul style="list-style-type: none"> ◦The microcassette is broken (cut, worn out or twisted) or not inserted. Replace the cassette with a new one. ◦The OGM is recorded improperly. Record a new OGM. ◦The AUTO/FAX selector is set to the "FAX" position. Change the selector to the "AUTO" position.
<p>When the tape is played back, the sound level is low, even if the SPEAKER VOLUME control is turned up fully.</p>	<p>Clean the heads. (See "Maintenance" on page 16 in INSTALLATION MANUAL.)</p>
<p>I have played back all the recorded messages and I want to record the next phone call after the last previously recorded messages.</p>	<p>When the AUTO ANSWER indicator starts blinking, wait for 7 seconds. When the AUTO ANSWER indicator is off, push the AUTO ANSWER button. The unit will be ready to record next phone call.</p>
<p>I push the buttons of a remote phone, but the unit does not respond.</p>	<ul style="list-style-type: none"> ◦Make sure that you are using the correct code number. ◦Record the Outgoing Message in a quiet place.
<p>Some Incoming Messages have not been fully recorded.</p>	<p>Set the CPC to "B". (See "Initial Preparation" on page 7 in INSTALLATION MANUAL.)</p>
<p>Playback causes tape to turn, but messages cannot be heard.</p>	<p>Check to make sure that handset is firmly in the cradle.</p>
<p>When the caller hangs up after leaving message, the tape does not stop.</p>	<p>Vox detect time may need to be set to 4 sec. Refer to the INSTALLATION MANUAL, page 13 and 14.</p>

TELEPHONE

<p>The unit does not ring.</p>	<ul style="list-style-type: none"> ◦The RINGER VOLUME selector is set to "OFF". Should be set to "HIGH" or "LOW".
<p>The caller suddenly cannot hear my voice during a conversation.</p>	<p>Look at the MUTE indicator. If it is lit, push the MUTE button to resume the conversation.</p>

Glossary of Terms

One-Touch Transmission:

By placing the document onto the DOCUMENT holder and pushing the DIRECT CALL button, the unit will automatically dial the number in the FAX memory location and transmit the document.

JOURNAL: This is a report of the transmissions and receptions.

TX REPORT:

Individual Transmission Report

Each time a document is transmitted, this function will cause a record of the transmission to be printed.

OGM: Outgoing Message

ICM: Incoming Message

CPC: Calling Party Control
Calling party control enables the unit to detect when a caller hangs up.

Automatic Answer Mode:

When a call is received, the unit will automatically answer, record voice messages and/or receive documents.

AUTO-LOGIC (One-Touch Operation):

At the touch of the PLAYBACK/PAUSE button, the unit will automatically rewind, playback all the recorded messages and stop. After 7 seconds, the unit will reset itself to the Automatic Answer Mode.

VOX: Voice Activated Circuit
The caller can leave a message for any length of time for as long as he/she continues to speak.

FLASH: If you connect your unit to a PBX, you may access some features of your PBX by using the FLASH button instead of the hookswitch.

The following sections can be found in INSTALLATION MANUAL.

- Connection
- Battery Installation
- Recording Paper Installation
- Cassette Tape Installation
- Document Tray Installation
- Installation of the Card for Speed Dialing
- Initial Preparation
- Setting the Logo and/or Identification (ID) Number
- Programming Functions
- Service Functions for Facsimile
- Printer and Motor Test
- Maintenance
- Cassette Tape
- Others
- Important Information
- Accessory Order Information
- Specifications of Facsimile
- Servicenter Directry
- Warranty

MEMO

MEMO

Panasonic Company
Division of Matsushita Electric Corporation of America
One Panasonic Way, Secaucus, New Jersey 07094

Panasonic Hawaii, Inc. ("PHI")
99-859 Iwaiwa Street, Honolulu, Hawaii 96808-0774

Panasonic Sales Company ("PSC"),
Division of Matsushita Electric of Puerto Rico, Inc.
San Gabriel Industrial Park, 65th Infantry Avenue, KM 9.5, Carolina, P.R. 00630