



**POLARIS**<sup>®</sup>  
The Way Out.



**2007**

**120 Owner's Manual  
for Maintenance and Safety**



**POLARIS**  
The Way Out.®

For your nearest Polaris dealer,  
call 1-800-POLARIS  
or visit [www.polarisindustries.com](http://www.polarisindustries.com)  
Polaris Sales Inc.,  
2100 Hwy. 55, Medina, MN 55340  
Phone (763) 417-8650 Fax (763) 542-0599  
Part No. 9920513  
Printed in USA

** WARNING**

Read, understand, and follow all of the instructions and safety precautions in this manual and on all product labels.

Failure to follow the safety precautions could result in serious injury or death.

** WARNING**

The engine exhaust from this product contains chemicals known to the State of California to cause cancer, birth defects or other reproductive harm.

# WELCOME

Thank you for purchasing a Polaris vehicle, and welcome to our world-wide family of Polaris enthusiasts. Visit us online at [www.polarisindustries.com](http://www.polarisindustries.com) for the latest news, new product introductions, upcoming events, career opportunities and more.

At Polaris we proudly produce an exciting line of utility and recreational products.

- Snowmobiles
- All-terrain vehicles (ATVs)
- *RANGER* utility vehicles
- Victory motorcycles

We believe Polaris sets a standard of excellence for all utility and recreational vehicles manufactured in the world today. Many years of experience have gone into the engineering, design, and development of your Polaris vehicle, making it the finest machine we've ever produced.

We also take great pride in our complete line of apparel, parts and accessories, available through our online store at [www.purepolaris.com](http://www.purepolaris.com). Have your accessories and clothing delivered right to your door!



**POLARIS**<sup>®</sup>  
The Way Out.

# WELCOME

## **Dear Parents:**

We believe your children should have the opportunity to enjoy The Way Out experience along with you. We've provided this owner's manual to assist you and your children in learning about the safe operation and care of your new Polaris snowmobile. Please review the information in this manual with any child who may operate the snowmobile. Help your children learn to operate the snowmobile with safety as a top priority. Help them also learn to show respect for our environment and for the rights of others while operating the snowmobile. Since the operator will be a newcomer to the exciting winter sport of snowmobiling, please be sure he/she understands this information before riding the snowmobile. Never allow a child to operate the snowmobile without adult supervision.

This Owner's Manual contains instructions for minor maintenance, but major repairs are covered in the Polaris Service Manual and should be performed by a Factory Certified MSD (Master Service Dealer) Technician. Be sure to return to your dealership for all of your service needs during, and after, the warranty period.

The preventive maintenance program outlined in this manual is designed to ensure that all critical components on your child's snowmobile are thoroughly inspected at various intervals. If you have any questions about the snowmobile, contact a Polaris dealer for assistance. See page 82 for the part numbers of Polaris products.

# WELCOME

## **Dear Children:**

Before you ride your new Polaris snowmobile, there are some important things that you need to know. Your parents and Polaris want you to enjoy riding your new snowmobile, and that's why you need to read and understand the information in your owner's manual.

Ask your parents to explain anything you don't understand, and pay close attention to the warnings and instructions you read. Your safety and the safety of others is the most important thing to think about at all times.

As the driver of the snowmobile, you must learn how to keep yourself and those around you safe while you're riding. So read your manual, and then enjoy riding your new Polaris snowmobile!

POLARIS and POLARIS THE WAY OUT are registered trademarks of Polaris Industries Inc.

Copyright 2006 Polaris Sales Inc. All information contained within this publication is based on the latest product information at the time of publication. Due to constant improvements in the design and quality of production components, some minor discrepancies may result between the actual vehicle and the information presented in this publication. Depictions and/or procedures in this publication are intended for reference use only. No liability can be accepted for omissions or inaccuracies. Any reprinting or reuse of the depictions and/or procedures contained within, whether whole or in part, is expressly prohibited.

Printed in U.S.A.

2007 120 Snowmobile Owner's Manual

P/N 9920513

# TABLE OF CONTENTS

<b>Introduction</b> . . . . .	<b>6</b>
Important Notes for Owners and Drivers . . . . .	6
Preservation of the Environment . . . . .	7
Vehicle Identification Numbers . . . . .	9
<b>Safety</b> . . . . .	<b>10</b>
<b>Youth Section</b> . . . . .	<b>14</b>
Know Your Snowmobile . . . . .	14
Pre-Ride Check . . . . .	19
Riding Rules . . . . .	21
<b>Adult Section</b> . . . . .	<b>25</b>
Pre-Ride Check . . . . .	25
Operation Warnings . . . . .	29
Component Identification . . . . .	40
Break-In Period . . . . .	42
Operation . . . . .	43
Emission Control Information . . . . .	48
Maintenance . . . . .	49
<b>Troubleshooting</b> . . . . .	<b>79</b>
<b>Specifications</b> . . . . .	<b>80</b>
<b>Polaris Products</b> . . . . .	<b>82</b>
<b>Warranty</b> . . . . .	<b>83</b>
<b>Maintenance Log</b> . . . . .	<b>94</b>
<b>Index</b> . . . . .	<b>96</b>



# INTRODUCTION

## Important Notes for Owners and Drivers

After reading this manual, store it in the snowmobile for convenient reference. It should remain with the snowmobile when the snowmobile is sold.

You and your dealer must complete the registration form included with your snowmobile and forward it to us. This completed form is necessary to ensure warranty coverage.

**NOTE:** The illustrations and photos used in this manual are general representations. Your model may differ.

### IMPORTANT

Parents should sit down with their children and read the Youth Section with them before allowing them to use this snowmobile. Parents must also read the Adult Section before allowing their children to ride this snowmobile.

**PARENTS:** Do not allow anyone under the age of six (6) to operate this machine. Review the information in this manual with any child who may be operating the snowmobile. It is up to you to teach any operator the proper and safe way to ride a snowmobile. You must set boundaries and adhere to them, keeping the operator's safety foremost in your mind. Never allow a child to operate this machine without adult supervision.

These units are not designed for adult use. Serious damage to the vehicle may occur if the maximum rider weight capacity is exceeded. The maximum rider weight capacity is 140 lbs. (63.5 kg).

**CHILDREN:** Before you ride your new Polaris snowmobile, there are some important things that you need to know. Your safety and the safety of others is the most important thing to think about at all times. As the driver of the snowmobile, you must learn how to keep yourself and those around you safe while you're riding.

Pay attention when you see this symbol:



This is the safety alert symbol. When you see this symbol on your snowmobile or in this manual it means **PAY ATTENTION** because you could die or be seriously hurt if you don't follow the instructions.

# INTRODUCTION

## Preservation of the Environment

Teach your child to drive their snowmobile with consideration for the protection and preservation of the environment.

### Noise

One of the most publicized subjects with regard to snowmobiles is noise. The Society of Automotive Engineers (SAE), which is the standard-setting body for snowmobiles, has recommended that snowmobiles conform to prescribed sound levels. This Polaris snowmobile has been engineered to conform to these SAE standards.

In order to be meaningful, all regulations require the cooperation of the snowmobile owner. Muffling systems, designed to reduce noise levels, should not be altered or removed. Snowmobile drivers must be aware that they have a public responsibility to operate their snowmobiles with concern for others. As a snowmobile operator you may not realize the sound of your snowmobile may annoy non-snowmobilers. We are attempting to do our part through the manufacture of quieter machines, and we also ask your help in the effort to further reduce the impact of noise.

### Air Pollution

As a part of Polaris' plan for the snowmobile's compatibility within the environment, our engineers are investigating ways to reduce emission levels of engines. We expect our efforts to lead to the reduction of potential air pollution.

The four-stroke engine used in this snowmobile produces less exhaust emissions and reduces noise, as well.

In addition to technological research, we also suggest that governmental agencies, manufacturers, distributors, dealers, ecologists, and other interested parties work together to develop data on environmental topics. We will continue to participate in this type of study so that someday we may find the answers to these difficult issues.

# **INTRODUCTION**

## **Preservation of the Environment**

### **Environmental Protection**

As part of the continuing environmental education campaign, we are encouraging state and provincial governments across the snowbelt to adopt rigorous safety training programs which also encourage protection of our environment, wildlife and vegetation. Snowmobile clubs and other organizations are working together to protect our environment. It is very important that we encourage them as well as become actively involved ourselves. Protect and preserve your right to ride by joining your local trail riding clubs. Teach your child the following:

Respect your snowmobile;  
respect your environment;  
and you will earn  
the respect of everyone.

# INTRODUCTION

## Vehicle Identification Numbers

Record your snowmobile's identification numbers and key number in the spaces provided. Remove the spare key and store it in a safe place. Your key can be duplicated only by mating a Polaris key blank with one of your existing keys, so if both keys are lost, the ignition switch must be replaced.

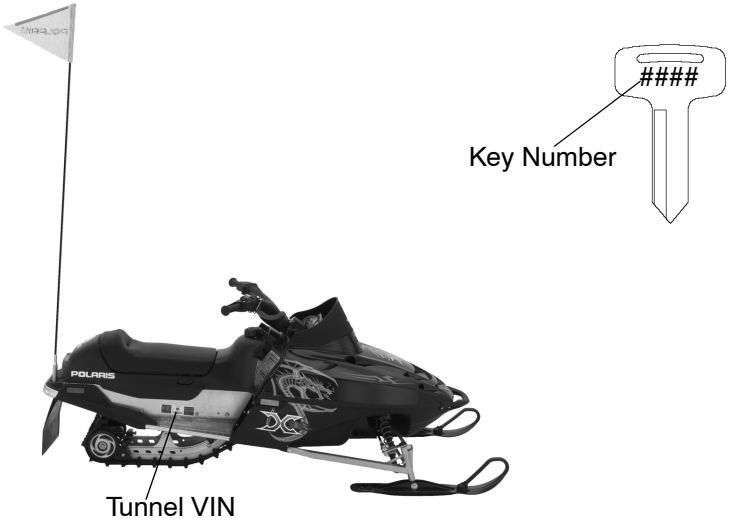

Vehicle Model Number: \_\_\_\_\_

Tunnel VIN: \_\_\_\_\_  
(lower right side of the tunnel)

Engine Serial Number: \_\_\_\_\_  
(right front side of engine crankcase)

Key Number: \_\_\_\_\_

# SAFETY

The following signal words and symbols appear throughout this manual and on your vehicle. Your safety is involved when these words and symbols are used. Become familiar with their meanings before reading the manual.



The *safety alert symbol*, on your vehicle or in this manual, alerts you to the potential for injury.

## WARNING

The *safety alert warning* indicates a potential hazard that may result in serious injury or death.

## CAUTION

The *safety alert caution* indicates a potential hazard that may result in minor injury or damage to the vehicle.

## CAUTION

A *caution* indicates a situation that may result in damage to the vehicle.

## NOTE

A *note* will alert you to important information or instructions.

## **WARNING**

Failure to follow the warnings in this manual can result in severe injury or death. Read and understand the owner's manual and all warning decals before operating a Polaris snowmobile. Adults must thoroughly explain this information, including all safe operating procedures, to all operators of the snowmobile. All operators must be at least six (6) years old and must understand the consequences and risks if they choose to ignore or neglect this information.

## **Equipment Modifications**

All Polaris snowmobiles have been designed and tested to provide safe operation when used as directed. Failure of critical machine components may result from operation with any modification; especially those that increase speed or power. There is a significant possibility of loss of control at higher speeds.

We are concerned for the safety of our customers and for the general public. Any modifications to the original equipment of the vehicle create a substantial safety hazard and increase the risk of bodily injury. Therefore, we strongly recommend that consumers do not install on a Polaris snowmobile any equipment that may increase the speed or power of the vehicle, or make any other modifications to the vehicle for these purposes.

The warranty on your Polaris snowmobile is terminated if any equipment has been added to the vehicle, or if any modifications have been made to the vehicle, that increase its speed or power.

# **SAFETY**

## **Maintenance Program**

This snowmobile is not a toy. The information in this manual is provided to aid you in its safe operation.

For the safety of the operator, always make sure that the snowmobile is in excellent operating condition at all times. We strongly recommend that the operator, as well as an adult, check major and vital safety components before each use of the vehicle.

We also recommend that you strictly follow the maintenance schedule outlined in this manual to ensure that all critical components on the snowmobile are thoroughly inspected by your dealer at various mileage intervals.

## Safety Decals

Safety and warning decals have been placed on the vehicle for the operator's protection. Make sure the operator understands the information on all decals. If any decal becomes illegible or comes off, contact your Polaris dealer for a replacement. Replacement *safety* decals are provided by Polaris at no charge. The part number is printed on the decal.

### General Warning Decal

#### WARNING

- Read and understand warnings and the Owner's Manual before operation. Severe injury or death can result from not heeding the warnings.
- This vehicle is intended for daylight use in restricted off-road areas clear of obstacles, primarily on snow and not on frozen bodies of water, by a child of not less than 6 years of age who is in the presence of, and in active supervision of an adult. Use of this vehicle on public trails, streets, roads, and highways can be hazardous and is prohibited by law in most cases.
- Do not start or operate this vehicle without guards and shields in position, or with hood not latched in place.
- This vehicle is intended for one operator only, no passenger. Passengers, cargo, or towed objects can cause loss of control.
- Verify proper operation of all controls before starting the engine.
- When operating this vehicle, the operator shall wear suitable protective clothing including an approved safety helmet and shield or goggles.
- Securely attach the safety lanyard to the child's body before starting the engine.
- This vehicle can be operated between 0 and 8 mph (13 km/h). However, it is recommended that the adult supervising the child regulate the maximum speed to match the experience and ability of the child. Instructions for regulating maximum speed are provided in the Owner's Manual.
- The Auxiliary Shut Off Switch is the primary means of stopping this vehicle in case of emergency and is located on the top of the throttle control assembly. Depress the switch to stop the engine. Routinely check this switch for proper function with the engine idling.
- If Owner's Manual is missing, contact a Polaris Dealer for a replacement.

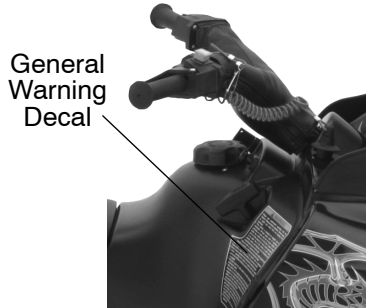



# YOUTH SECTION

## Know Your Snowmobile

Before you have an adult start the engine for you for the first time, let's learn about the controls on your new snowmobile.

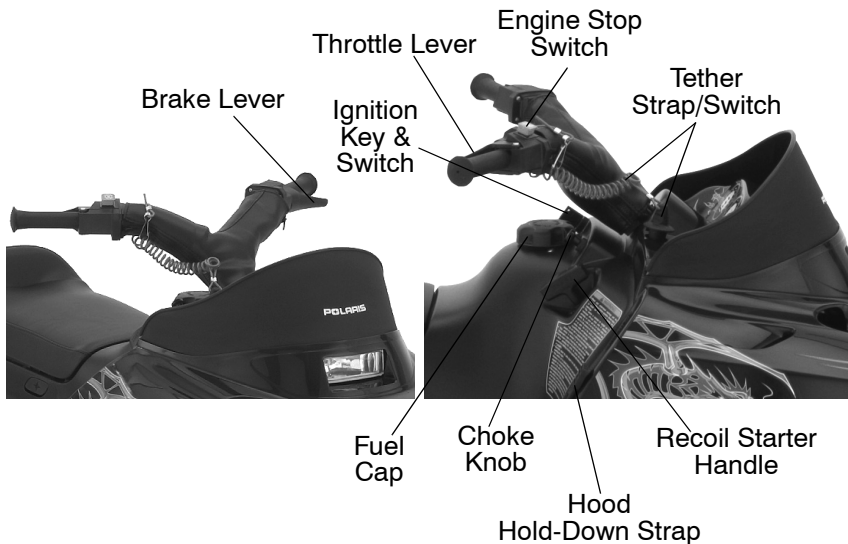

### **Engine Stop Switch**

When the engine is running, push this button down to stop the engine. Pull the stop switch up before trying to start the engine again.

### **Throttle Lever**

The throttle lever makes your snowmobile go forward when you press it with your thumb. Before you drive your snowmobile, always make sure the throttle lever does not stick. Read more about it on page 19.

### **Recoil Starter Handle**

Pull the recoil starter handle to start your snowmobile. An adult will help you start it the first time.

### **Choke Knob**

You may need to use the choke to help start your snowmobile if the engine is cold. Read more about it on page 45.

## Know Your Snowmobile

### Gas Cap

An adult will take the gas cap off to put gas in your snowmobile. Never take the gas cap off. Always make sure it's tightly closed.



Always have an adult put gas in your snowmobile. Never try to do it yourself.

### Brake Lever

Squeeze the brake lever toward the handlebar to make your snowmobile slow down or stop.



Always take your thumb off the throttle lever when you squeeze the brake lever.

### Ignition Switch

The ignition switch key must be turned ON before you pull the recoil starter handle to start your snowmobile. You can also stop the engine if you turn the key OFF.

### Tether Strap/Switch

Always attach the tether strap snugly to your right wrist and to your snowmobile every time you drive. If you fall off your snowmobile, the tether strap will pull away from the switch and the engine will stop.



Never ride without the tether strap attached to your right wrist and to your snowmobile. Be careful not to let the cord get tangled around the handlebars or any part of your body.

### Hood Hold-Down Strap

Two straps hold down the hood of your snowmobile. Always make sure both straps are latched before you start the engine.

# YOUTH SECTION

## Know Your Snowmobile

Let's learn more about the parts of your snowmobile before we learn about riding.

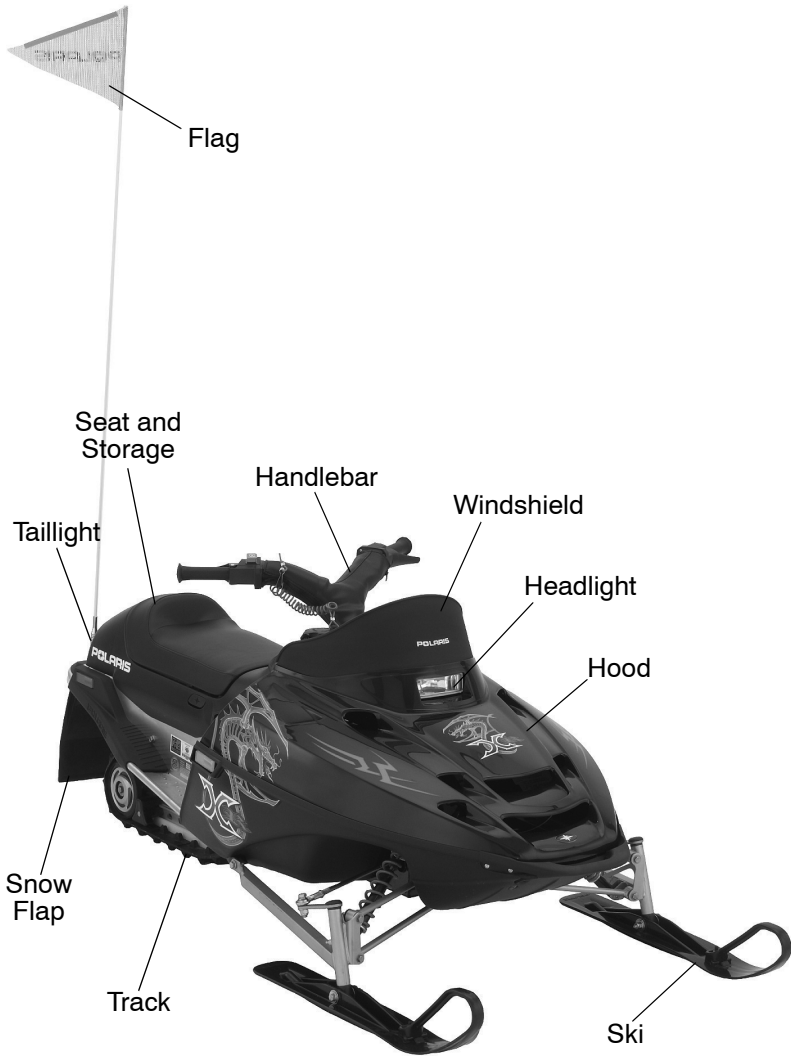

## Know Your Snowmobile

### Hood

The hood covers the moving and hot parts of the engine. Always make sure the hood is securely latched before you ride.

### Headlight

The headlight is always on when the engine is running. It helps others see you when you're riding during daylight, but it's not meant to be strong enough to help you see in the dark. Drive your snowmobile only in the daylight.

### Windshield

Always keep your windshield clean so you can see through it.

### Handlebar

The handlebar is connected to the skis. When you turn the handlebar, the skis turn in the same direction.

### Flag

The flag helps other people see where you are. Your snowmobile is smaller than an adult snowmobile, so it's harder to see. Never remove the flag from your snowmobile.

### Seat and Storage

When the engine is stopped, you can take the seat cushion off and put things under the seat in the special compartment.

### Taillight

The taillight is always on when the engine is running. It will help others see you when you're riding.

### Snow Flap

The snow flap keeps snow, ice or other things from flying out behind your snowmobile.

### Track

When you squeeze the throttle lever, the track turns and makes the snowmobile move forward.



Never get close to a moving track. Never wear clothing that could get caught in a moving track, like a long scarf or baggy clothing. Tie up long hair.

### Skis

The skis help you steer your snowmobile. When you turn the handlebar, the skis turn in the same direction.

# YOUTH SECTION

## Know Your Snowmobile

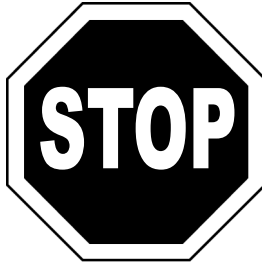

**Let's review the 3 ways to stop your snowmobile:**

1. Push the stop switch down.
2. Pull the tether strap off the switch.
3. Turn the key off.

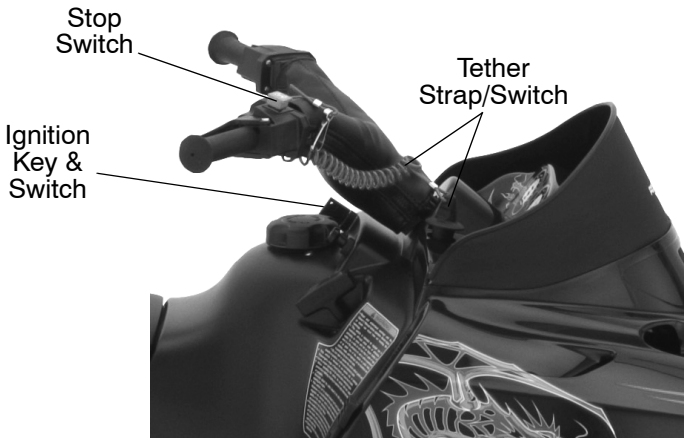

## Pre-Ride Check

You're almost ready to have an adult start your snowmobile. But first you must do a **PRE-RIDE CHECK** to make sure the snowmobile is safe to ride. Every time you want to ride your snowmobile, always have an adult help you check these things before you start the engine.

### ✔ **Throttle Lever**

Squeeze the throttle lever toward the handlebar and then let it go. The lever should go right back to where it was before you squeezed it. If it goes back slowly or stays close to the handlebar, you have a sticky throttle. This means that something is wrong or broken.



Don't start the snowmobile until an adult fixes the sticky lever. You could get hurt if you ride with a sticky throttle.

### ✔ **Brake Lever**

Squeeze the brake lever toward the handlebar and then let it go. The lever should go right back to where it was before you squeezed it. If it goes back slowly or stays close to the handlebar, you have a sticky brake lever. This means that something is wrong or broken.



Don't start the snowmobile until an adult fixes the sticky lever. You could get hurt if you ride with sticky brakes.

### ✔ **Seat Latches**

Check the seat latches. Make sure they are latched tightly.

### ✔ **Hood Hold-Down Straps**

Check the hood hold-down straps. Make sure they are latched tightly.

### ✔ **Track and Skis**



Never check the track or skis when the engine is running. You could get hurt if the snowmobile moves unexpectedly. Never stand behind or in front of any snowmobile when the engine is running.

Make sure the engine is off, then stand behind the snowmobile and lift up the rear end. This will free the track if it is frozen to the ground.

Turn the handlebars all the way to the left and to the right. This will turn the skis to make sure they aren't frozen to the ground.

If any of this is hard to do, have an adult help you.

# YOUTH SECTION

## Pre-Ride Check

### ✔ Gas Level



Always have an adult put gas in your snowmobile. Never try to do it yourself.

Have an adult check the gas level to see if your snowmobile needs more gas. Children should never open the gas cap or add gas. Always have an adult do this. Before anyone adds gas to your snowmobile they must read the instructions and warnings on page 43 in this Owner's Manual.

### ✔ Oil Level

Have an adult check the engine oil level when the engine is cold. The engine is very hot after it has been running. It could burn your skin. Children should never check the oil. Always have an adult do this.

### ✔ 3 Ways to STOP

Always check to make sure that ALL 3 WAYS TO STOP are working the way they should. Do you remember what they are? Follow these steps:

1. Start the engine. Push the stop switch down. The engine should stop.
2. Start the engine. Pull the tether strap off the switch. The engine should stop.
3. Start the engine. Turn the key off. The engine should stop.

If the engine does not stop when you do these checks, do not ride the snowmobile until an adult fixes it.

## Riding Rules

Now you're ready to learn about driving your Polaris snowmobile. This snowmobile is not a toy. There are some things you can do and there are some things you must never do. Rules are very important when you're driving a snowmobile. Adults have riding rules, too. The rules help keep us safe when we ride.

You must be at least six (6) years old before you can ride this snowmobile. The adult with you is your teacher. Always pay attention to what your teacher says so you can learn how to always drive safely.

Let's learn how to ride!



Always follow the safe riding rules found on the next pages. You or others around you could be seriously hurt or killed if you don't follow the safe riding rules.

- ▶ Your snowmobile is made for only one rider. Never carry a passenger. A passenger will make the snowmobile harder to drive. You may lose control and hurt yourself and your passenger.
- ▶ Never pull anything behind your snowmobile.
- ▶ Make sure you know where you're going to drive before you start the engine. Make sure the area is safe all around your snowmobile.
- ▶ Never ride alone. An adult should always be watching you in case you need help. Always drive where an adult can see you.
- ▶ Never ride on public trails.
- ▶ When you're a beginner, always stay on level ground.
- ▶ Don't ride your snowmobile on roads or over railroad tracks. Your snowmobile makes noise that will keep you from hearing cars, trucks or trains that may be coming toward you.
- ▶ Stay away from fences. Make sure you know where all the fences are before you ride. If you drive into a fence, you could get hurt.
- ▶ Don't ride at night. The headlight on your snowmobile is there only so others can see you driving during the day.



# YOUTH SECTION

## Riding Rules

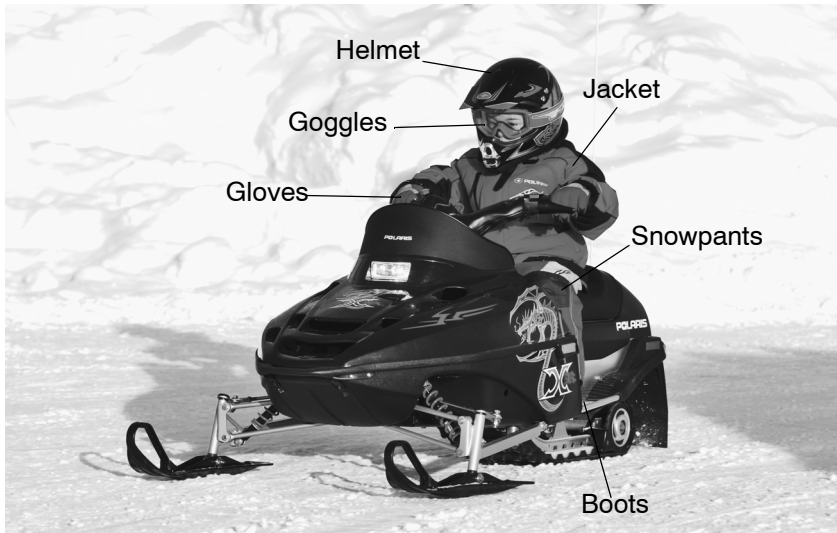

- ▶ Always wear the right kind of clothing when you ride your snowmobile. Always wear a helmet with a face shield or goggles. Wear a warm jacket and snowpants. Make sure your clothing fits properly. Tight clothing could keep you from moving easily. Baggy clothing could hang down and get caught in the track or another moving part. Never wear a long scarf. Wear warm snowmobile boots and gloves, and make sure your boot laces are tied. If you have long hair, tie it up or put it inside your helmet or jacket.
- ▶ Learn if there are lakes, rivers, ponds and ditches in your driving area. Stay away from them. Never ride on frozen water. Your snowmobile could fall through the ice into the water and you could drown or freeze to death.
- ▶ Always be alert and pay attention to where you're driving. Always watch out for objects or people in your driving area and stay a safe distance away from them.

## Riding Rules

- ▶ Always sit down when you drive. Keep both hands on the handlebars. Keep both feet on the running boards.
- ▶ Never follow another snowmobile too closely. Always allow lots of space to stop your snowmobile.
- ▶ Ride your snowmobile only where you know it's safe to drive and where you have permission to drive.
- ▶ Always be a polite driver. Don't drive through the flower garden or over small trees.
- ▶ Always attach the tether strap to your wrist and to the snowmobile before riding.



Attach tether strap to snowmobile



Attach tether strap to your wrist

# YOUTH SECTION

## Riding Rules

Learn how to use your hands and arms as signals. Use these signals to let others know when you are getting ready to turn or stop your snowmobile. Read and understand your Owner's Manual.



**Left Turn**



**Right Turn**



**Stop**

### Pre-Ride Check

As the adult, you must teach the child the proper and safe way to ride a snowmobile. Set boundaries and adhere to them, keeping the child's safety foremost in your mind. Never allow the child to operate this vehicle without adult supervision.

#### **WARNING**

Serious injury or death could result if the vehicle is not inspected properly before operation. Teach all operators to perform the following Pre-Ride Check before each use of the snowmobile.

- ✔ Check the throttle for proper operation. See page 26.
- ✔ Check the brake for proper operation. See page 26.
- ✔ Check the steering system for proper operation. See page 26.
- ✔ Check the throttle safety switch for proper operation. See page 27.
- ✔ Start the engine and push the stop switch down to test for proper operation. The engine should stop immediately.
- ✔ Start the engine and disconnect the tether switch to test for proper operation. The engine should stop immediately.
- ✔ Start the engine and turn the ignition key off to test for proper operation. The engine should stop immediately.
- ✔ Inspect the track. See page 28.
- ✔ Make sure the seat is securely attached.
- ✔ Make sure the hood is latched.
- ✔ Make sure the track and skis are not frozen to the ground.
- ✔ Check the gas and oil levels for the rider. Add more if necessary.
- ✔ Make sure the headlight and taillight are working properly.

These checks should become automatic for the child before each ride. As the adult teacher, you must instill in all riders the importance of performing this Pre-Ride Check before they operate the snowmobile.

# ADULT SECTION

## Pre-Ride Check

### ✔ **Read and Understand Your Owner's Manual**

Read and make sure the operators understand the Owner's Manual completely before allowing anyone to operate this snowmobile. It's also a good idea to review it periodically to reinforce the information. It's very important to familiarize all operators with the cautions and warnings pertaining to the machine as well as safe operating procedures. We've attempted to provide you with as much information as possible to alert you to the safety requirements of snowmobiling.

### **WARNING**

The throttle and brake are the primary controls of the snowmobile. If either should malfunction, the operator could lose control, which could lead to serious injury or death. Always check the throttle and brake levers for proper operation before operating the vehicle.

### ✔ **Check the throttle for proper operation**

When checking the throttle, make sure the throttle lever compresses evenly and smoothly. When the lever is released, it should immediately return to the idle position without binding or hesitation. If the throttle does not function smoothly, do not start the engine. Have the throttle serviced before operating the snowmobile.

### ✔ **Check the brake for proper operation**

Squeeze the brake lever toward the handlebar. When the lever is released, it should return to its original position smoothly. If the lever hesitates or seems sticky, do not start the engine. Have the brakes serviced before operating the snowmobile. See page 31 for brake lever travel specifications.

### ✔ **Check for proper operation of the steering system**

Check for proper operation of the steering system. Manually turn the skis completely to the right and to the left. If difficulty is encountered, check for ice and snow buildup that may be obstructing the steering linkage. Make sure all greaseable components are properly lubricated.

## Pre-Ride Check

### ✔ Check the throttle safety switch

Test the throttle safety switch system on a daily basis before the vehicle is used.

With the engine idling, hold the throttle lever pin stationary by exerting pressure on the pivot pin in the direction shown in the illustration. Apply a slight amount of throttle opening. A properly functioning switch *must* shut down the engine.

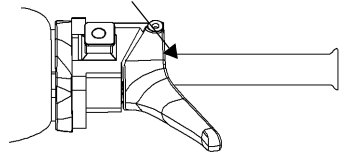

The throttle safety switch is designed to stop the engine whenever all pressure is removed from the throttle lever and the throttle cable or valve does not return to the normal closed position.

If excessive play develops in the throttle cable, the safety switch may be activated and will prevent the engine from starting. If the engine doesn't start and throttle safety switch malfunction is suspected, return the machine to an authorized Polaris dealer for service. If an adult must start the engine in an emergency situation, the throttle safety switch and engine stop switch may be disconnected from the wire harness. In this situation, the ignition key switch must be used to shut off the engine. Be sure to reconnect the safety switches and have the snowmobile serviced before operating the vehicle again.

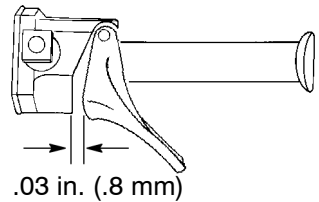

### **⚠ WARNING**

*Do not* continue to operate the vehicle with the throttle safety switch disconnected as serious injury or death could result. See your authorized Polaris dealer for service before operating.

# ADULT SECTION

## Pre-Ride Check

### ✓ Inspect the track

Driving for extended periods of time with marginal lubrication could severely damage the track. Driving on icy trails or driving when there is little or no snow are two examples of situations that would provide marginal lubrication and are not recommended. Do not operate the snowmobile with a damaged track.

### **WARNING**

Operating the snowmobile with a damaged track will increase the possibility of additional track damage and/or failure. This could cause loss of control, resulting in severe injury or death. Always inspect for damage before using the snowmobile.

**NOTE:** Track damage or failure caused by operation under poor lubrication conditions will void the track warranty.

## Operation Warnings

### ✔ Do not carry passengers

This snowmobile is designed for a single operator.

### ✔ Do not operate with intake silencer removed

#### CAUTION

If the engine is operated with the intake silencer removed, damage to the engine may occur. Do not operate the engine with the intake silencer removed.

### ✔ Stay clear of track

#### ⚠ WARNING

During warm-up and operation, stand clear of the rotating track. Entanglement and serious injury or death may result. Use just enough throttle to rotate the track and warm up the engine.

### ✔ Do not operate with drive chain guard removed

#### ⚠ WARNING

The drive chain guard is designed to protect the operator from metal parts in the event of a drive chain failure. Although the chance of failure is extremely remote, do not defeat the purpose of the guard by removing it. It is provided for the safety of the child.



# ADULT SECTION

## Operation Warnings

### ✔ Do not touch the engine after it's been running

<b>⚠ WARNING</b>
------------------

Hot components can cause serious burns to skin. Do not touch engine and exhaust parts after the engine has been running.
--

### ✔ Disabled operators

<b>⚠ WARNING</b>
------------------

Safe operation of this rider-active vehicle requires good judgement and physical skills. Persons with cognitive or physical disabilities who operate this vehicle have an increased risk of overturns and loss of control, which could result in serious injury or death.
---

## Operation Warnings

### ✔ **Check brake lever travel**

Depress the brake lever fully. Measure the clearance between the lever and brake block. Clearance should be no more than 3/4" (1.9 cm).

Excessive travel indicates a need to adjust the brake cable. Refer to the mechanical brake adjustment information on page 56.

### ✔ **Secure the hood**

The hood of the snowmobile protects the operator from moving and hot parts as well as aiding in sound emission control and other functions. Never operate a snowmobile with the hood open or removed.

### ✔ **Remove the ignition key**

Don't tempt someone to steal or ride your snowmobile without permission by leaving the key in the ignition. Always remove the key and store it in a safe location.

### ✔ **Check lights**

Start the engine and ensure that both the headlight and taillight operate.

# ADULT SECTION

## Operation Warnings

### ✔ Check surroundings

Make sure the operation area is clear of obstacles and bystanders. Some sideways movement is possible when the snowmobile first begins to move, and debris may be thrown by the track. Teach the operator to check the operating area before riding.

### ✔ Sit properly on the snowmobile

Operating a snowmobile requires skill and balance for proper control. An improper position can reduce the child's ability to control the snowmobile. The riding position may vary as the operator becomes more skilled, but under most conditions the proper position is to be seated with both feet on the running boards, in a comfortable position for proper throttle, brake and steering control.

### **⚠ WARNING**

This snowmobile is propelled by a revolving track, which must be partially exposed for proper operation. Serious injuries may be caused by operator carelessness, resulting in hands, feet, hair or clothing becoming entangled in the track. Teach the child to respect this machine and all moving parts. Teach the child that being properly seated is the safest way to stay clear of the track.

### **⚠ WARNING**

Never hold the snowmobile up or stand behind it while warming up the track. A loose track or flying debris could cause serious personal injury or death.



## Operation Warnings

### ✔ Always wear clothing designed for snowmobiling

Always make sure the operator is wearing an approved helmet and eye protection. Do not allow the child to wear loose clothing or long scarves because they can easily become entangled in moving parts. If your child has long hair, be sure it is always tied up securely and tucked into the helmet or jacket.

### Helmet

Wearing a helmet can prevent a severe head injury. Whenever riding a Polaris vehicle, always wear a helmet that meets or exceeds established safety standards.

Approved helmets in the USA and Canada bear a U.S. Department of Transportation (DOT) label.

Approved helmets in Europe, Asia and Oceania bear the ECE 22.05 label. The ECE mark consists of a circle surrounding the letter E, followed by the distinguishing number of the country which has granted approval. The approval number and serial number will also be displayed on the label.

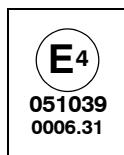

### Eye Protection

Do not depend on eyeglasses or sunglasses for eye protection. Whenever riding a Polaris vehicle, always wear shatterproof goggles or use a shatterproof helmet face shield. Polaris recommends wearing approved Personal Protective Equipment (PPE) bearing markings such as VESC 8, V-8, Z87.1, or CE. Make sure protective eye wear is kept clean.

# ADULT SECTION

## Operation Warnings

### ✔ Stop engine before attempting adjustments

#### **WARNING**

The snowmobile engine compartment contains moving parts. Shields and guards have been provided for safety, but it is still possible to carelessly get your hands or fingers into a moving chain or a rotating shaft. For this reason never attempt adjustments with the engine running. Serious personal injuries can result. The proper method is to turn off the ignition, raise the hood, make the adjustment, secure shields and guards, secure the hood, and then re-start the engine to check its operation. The same is true of track alignment. If the track must be re-aligned, it is recommended that this service be performed by your dealer.

### ✔ Know limitations of machine and skills of driver

The operator should be aware that most areas have laws governing snowmobile operation and that these laws should be followed. They have been established for the protection of all snowmobile riders. Many local organizations offer a snowmobile safety course for children. Check with local authorities to locate providers of this service.

This vehicle is intended for daylight use only. Check both the headlight and taillight to ensure proper operation.

**IMPORTANT:** The headlight and taillight are intended only to increase the visibility of the snowmobile during daylight operation. Do not operate this snowmobile in the dark.

## Operation Warnings

### ✔ Instruct all operators

Teach all young drivers to always be alert and to pay attention to the driving area ahead. When teaching inexperienced operators to ride, set up a predetermined course. Establish boundaries and make sure all operators know and understand them. Make sure they know how to drive and control the snowmobile before you allow them to drive longer supervised distances. Teach them proper snowmobile courtesy.

It's a good idea to predetermine some hand signals as a way to communicate with a child while giving instruction. It may be difficult for a child to hear your voice over the sound of the snowmobile and through a helmet.

Teach the operator that the sound of the engine will make it difficult to hear the sound of approaching vehicles. Do not allow a child to operate the snowmobile on or near roads and railroad tracks.

Teach operators what it means to drive defensively. Never tailgate and always allow ample stopping distances.

### ✔ Be alert for obstacles

Wire fences are a serious hazard. Teach operators to always be on the alert for fences. Single strands are especially dangerous, since there can be a great distance between posts. Ground wires on utility poles are also difficult to see. Teach operators to reduce speed when traveling near poles, posts or other obstacles.

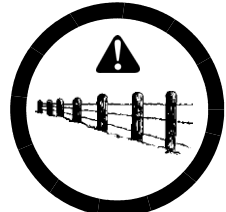

### ✔ Check the weather

Extremely cold weather can cause frostbite and/or hypothermia. Always be aware of weather conditions, especially the windchill. See the table on page 39.



# **ADULT SECTION**

## **Operation Warnings**

### **Driving Responsibly**

As the adult, you must teach the child the proper and safe way to ride a snowmobile. Set boundaries and adhere to them, keeping the child's safety foremost in your mind. Never allow the child to operate this vehicle without adult supervision.

### **Drive-Away from Parked**

When the snowmobile has been parked for more than a few hours, especially overnight, the skis and track may freeze to the ground. Loosen the skis and track for the operator. You may have to apply extra throttle initially to move the snowmobile. Teach operators not to be afraid of applying extra throttle in this situation, but make sure they understand that too much throttle could cause the snowmobile to lurch forward.

### **Track Lubrication**

Do not operate the snowmobile for more than a few minutes on ground surfaces that contain little or no snow. The track needs snow for lubrication, so driving in too little snow will result in excessive wear and damage to the slide rail and track.

### **Snow and Ice Build-Up**

Snow and ice buildup in the underhood area can interfere with the steering. Manually turn the skis completely to the right and to the left. If difficulty is encountered, remove any ice and snow buildup that may be obstructing the steering linkage.

## Operation Warnings

### Snow Conditions

This snowmobile is designed to operate best on snow. Maneuverability is attained by the steering, skis, and the shifting of the driver's body weight. Maximum control will be attained by shifting body weight. Maneuverability will change for lighter operators.

If the snowmobile becomes stuck in snow, stop the engine. Clear the snow away from the running board area and clear away or step down the snow in front of the snowmobile. Restart the engine and drive out of the deep snow. Encourage the operator to stay on established riding areas to avoid getting stuck.

### Ice and Hard-Packed Surfaces

Steering and braking control are substantially reduced when operating on hard surfaces, hard-packed snow or icy surfaces. Teach your child to reduce speed to maintain control in all driving conditions. If necessary, limit the maximum speed of the snowmobile as outlined on page 44.

If ice or slippery conditions are unavoidable, use extreme caution and operate at speeds no faster than a walk. The skis need snow to help the snowmobile make turns. On hard surfaces the snowmobile will not make turns easily. It may be best to stop the engine, dismount, and manually move the front or rear of the snowmobile to change direction.

Never make a sharp turn on a slippery surface. The snowmobile may skid out of control. Teach all operators to drive only in approved areas within the vision of the supervising adult.

### **WARNING**

Children must never ride on a frozen body of water. Make sure all operators understand that severe injury or death can result if the snowmobile and its rider fall through the ice.



# ADULT SECTION

## Operation Warnings

### Driving on Hills

Traveling on hills is not recommended. A child may not be capable of maneuvering body weight as needed for operating on hills. If traveling on hills is unavoidable, teach your child to use extreme caution and obey the following proper operating procedures.

<b>⚠ WARNING</b>
------------------

Serious injury or death can result if the snowmobile rolls or slides downhill. If the snowmobile stops while the operator is driving on a hill, the operator should dismount on the uphill side of the vehicle. Never dismount or stand on the downhill side of a snowmobile.
---

### Driving Uphill

Driving uphill should be attempted only by experienced operators.

1. Stand on the running boards, keeping body weight low and forward.
2. Accelerate before the start of the climb, releasing the throttle as needed to prevent the track from slipping on the snow.
3. Slow down at the crest of the hill. Be prepared to avoid obstacles, sharp drops, or other people or vehicles that may be on the other side of the hill.

### Driving Downhill

Drive downhill slowly. Apply just enough throttle to keep the clutch engaged. This will allow engine compression to help slow the machine and prevent the snowmobile from rolling freely downhill.

# ADULT SECTION

## Operation Warnings

### Windchill/Temperature Charts

The following information is provided to help you determine when temperatures become dangerous for riding.

#### WINDCHILL CHART (°F)

Wind Speed in MPH	Actual Thermometer Reading (°F)																		
	40	35	30	25	20	15	10	5	0	-5	-10	-15	-20	-25	-30	-35	-40	-45	
	Equivalent Temperature (°F)																		
Calm	40	35	30	25	20	15	10	5	0	-5	-10	-15	-20	-25	-30	-35	-40	-45	
5	36	31	25	19	13	7	1	-5	-11	-16	-22	-28	-34	-40	-46	-52	-57	-63	
10	34	27	21	15	9	3	-4	-10	-16	-22	-28	-35	-41	-47	-53	-59	-66	-72	
15	32	25	19	13	6	0	-7	-13	-19	-26	-32	-39	-45	-51	-58	-64	-71	-77	
20	30	24	17	11	4	-2	-9	-15	-22	-29	-35	-42	-48	-55	-61	-68	-74	-81	
25	29	23	16	9	3	-4	-11	-17	-24	-31	-37	-44	-51	-58	-64	-71	-78	-84	
30	28	22	15	8	1	-5	-12	-19	-26	-33	-39	-46	-53	-60	-67	-73	-80	-87	
35	28	21	14	7	0	-7	-14	-21	-27	-34	-41	-48	-55	-62	-69	-76	-82	-89	
40	27	20	13	6	-1	-8	-15	-22	-29	-36	-43	-50	-57	-64	-71	-78	-84	-91	
45	26	19	12	5	-2	-9	-16	-23	-30	-37	-44	-51	-58	-65	-72	-79	-86	-93	
50	26	19	12	4	-3	-10	-17	-24	-31	-38	-45	-52	-60	-67	-74	-81	-88	-95	
55	25	18	11	4	-3	-11	-18	-25	-32	-39	-46	-54	-61	-68	-75	-82	-89	-97	
60	25	17	10	3	-4	-11	-19	-26	-33	-40	-48	-55	-62	-69	-76	-84	-91	-98	
Frostbite in >>										30 min.	10 min.	5 min.							

#### WINDCHILL CHART (°C)

Wind Speed in KPH	Actual Thermometer Reading (°C)																		
	5	2	-1	-4	-7	-10	-13	-16	-19	-22	-25	-28	-31	-34	-37	-40	-43	-46	
	Equivalent Temperature (°C)																		
Calm	5	2	-1	-4	-7	-10	-13	-16	-19	-22	-25	-28	-31	-34	-37	-40	-43	-46	
8	3	0	-	-7	-11	-14	-18	-22	-25	-29	-32	-36	-39	-43	-46	-50	-53	-57	
16	2	-2	-6	-10	-13	-17	-21	-24	-28	-32	-36	-39	-43	-47	-50	-54	-58	-62	
24	1	-3	-7	-11	-15	-19	-22	-26	-30	-34	-38	-42	-45	-49	-53	-57	-61	-65	
32	0	-4	-8	-12	-16	-20	-24	-28	-32	-36	-39	-43	-47	-51	-55	-59	-63	-67	
40	-1	-5	-9	-13	-17	-21	-25	-29	-33	-37	-41	-45	-49	-53	-57	-61	-65	-69	
48	-1	-5	-9	-13	-18	-22	-26	-30	-34	-38	-42	-46	-50	-54	-58	-62	-66	-70	
56	-2	-6	-10	-14	-18	-22	-26	-31	-35	-39	-43	-47	-51	-55	-59	-64	-68	-72	
64	-2	-6	-10	-15	-19	-23	-27	-31	-35	-40	-44	-48	-52	-56	-61	-65	-69	-73	
72	-2	-7	-11	-15	-19	-23	-28	-32	-36	-40	-45	-49	-53	-57	-61	-66	-70	-74	
80	-3	-7	-11	-15	-20	-24	-28	-33	-37	-41	-45	-50	-54	-58	-62	-67	-71	-75	
88	-3	-7	-12	-16	-20	-24	-29	-33	-37	-42	-46	-50	-55	-59	-63	-67	-72	-76	
96	-3	-8	-12	-16	-21	-25	-29	-34	-38	-42	-47	-51	-55	-60	-64	-68	-73	-77	
Frostbite in >>										30 min.	10 min.	5 min.							

# ADULT SECTION

## Component Identification

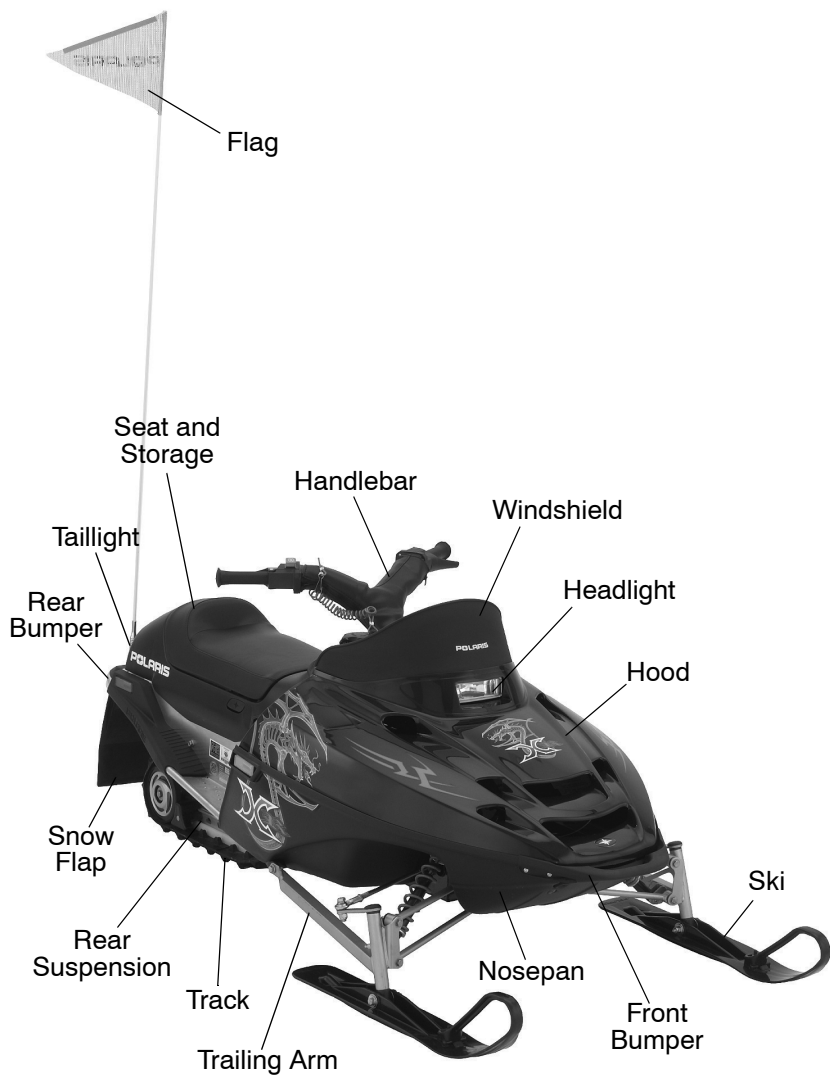

## Component Identification

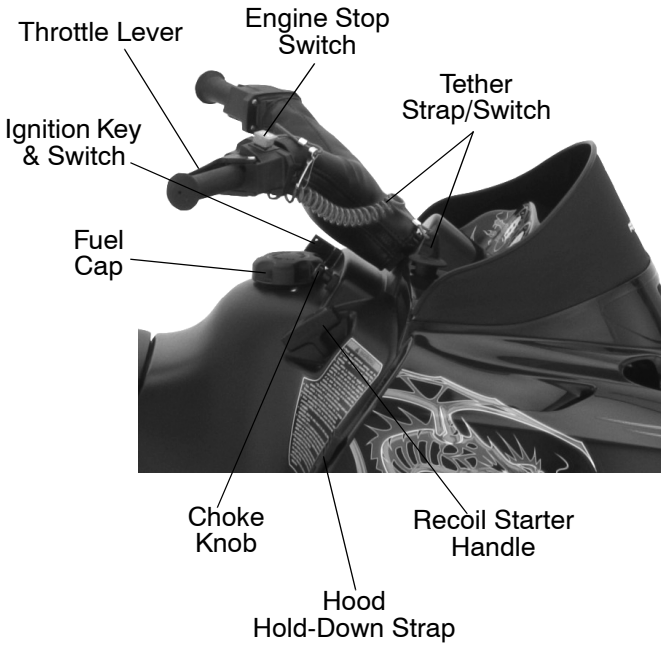

# ADULT SECTION

## Break-In Period

### Engine Break-In

The break-in period for your new snowmobile is defined as the first ten hours of operation, or the time it takes to use the first two tanks full of gasoline. No single action on your part is as important as a proper break-in period. Careful treatment of a new engine will result in more efficient performance and longer life for the engine.

<b>CAUTION</b>
Excessive heat build-up during the first three hours of operation will damage close-fitted engine parts. Do not operate at full throttle or high speeds during the first three hours of use.

1. Fill the fuel tank with gasoline.
2. Check the oil level. See page 61.
3. Drive slowly at first. Select an area that's open and will allow room to familiarize yourself with vehicle operation and handling.
4. Vary the throttle positions. Do not operate at sustained idle.
5. Perform regular checks on fluid levels, controls and areas outlined on the daily pre-ride inspection checklist. See pages 19 and 25.
6. Change the oil after the first 20 hours of operation.

## Operation

### Fuel

When refueling, use either leaded or unleaded gasoline with a minimum pump octane number of  $87=(R+M)/2$  octane. *Do not use E-85 fuel.*

#### **WARNING**

*Gasoline is highly flammable and explosive under certain conditions.*

- Always exercise extreme caution whenever handling gasoline.
- Always refuel with the engine stopped, and outdoors or in a well ventilated area.
- Do not smoke or allow open flames or sparks in or near the area where refueling is performed or where gasoline is stored.
- Do not overfill the tank. Do not fill the tank neck.
- If gasoline spills on your skin or clothing, immediately wash it off with soap and water and change clothing.
- If you get gasoline in your eyes or if you swallow gasoline, see your doctor immediately.
- Never start the engine or let it run in an enclosed area. Engine exhaust fumes are poisonous and can cause loss of consciousness or death in a short time.
- Turn the fuel valve off whenever the vehicle is stored or parked.

#### **WARNING**

The engine exhaust from this product contains chemicals known to cause cancer, birth defects or other reproductive harm. Operate this vehicle only outdoors or in well-ventilated areas.

# ADULT SECTION

## Operation

### Speed/Performance Regulation

As the adult, you must teach the child the proper and safe way to ride a snowmobile. Set boundaries and adhere to them, keeping the child's safety foremost in your mind. Never allow the child to operate this vehicle without adult supervision.

You can regulate the speed and acceleration of the snowmobile.

#### **⚠ CAUTION**

Hot engine components can cause serious burns to skin. Always perform the following procedures when the engine is cool.

Move the governor spring to hole #3 for maximum performance (highest available speed).

Move the governor spring to hole #1 for minimum performance (lowest available speed).

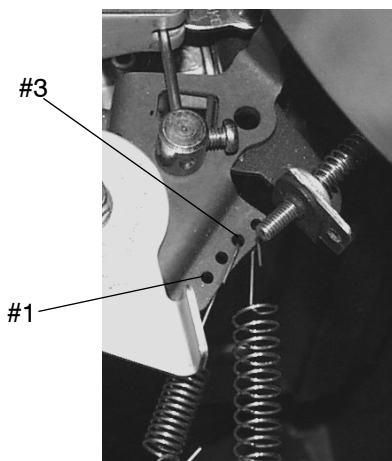

## Operation

### Starting the Engine

Never start the engine before performing the Pre-Ride Check. See pages 19 and 25.

1. Turn the key to ON.
2. Pull the engine stop switch up to the RUN position.
3. Do not use the choke when starting a warm engine. If the engine is cold, pull the choke lever completely out to the FULL ON position.

**NOTE:** Do not apply throttle while starting.

4. Grasp the starter handle and pull slowly until the recoil engages, then pull abruptly to start the engine.

<b>CAUTION</b>
----------------

Extending the starter rope too far or allowing it to snap back into the housing will cause damage to the recoil assembly. Do not extend the starter rope to its maximum length, and do not drop the rope handle during starting.
--

5. If the engine slows or stops, position the choke knob half way in.
6. Apply the brakes and vary the engine RPM slightly with the throttle to aid in warm-up. When the engine idles smoothly, push the choke knob all the way in.

**NOTE:** To prevent excessive wear on the clutch components, don't engage the clutch while performing the warm-up.



# ADULT SECTION

## Operation

### Emergency Stopping Procedures

The following chart lists methods for stopping the snowmobile in the event of an emergency. See pages 14 and 27 for more information about the engine stop switch and throttle safety switch.

SYSTEM	WHAT IT DOES	THROTTLE CONDITION
Engine Stop Switch	Interrupts ignition circuit	All
Throttle Safety Switch	Interrupts ignition circuit	All
Tether Switch	Interrupts ignition circuit	All
Ignition Switch	Interrupts ignition circuit	All
Brake	Slows jackshaft	All
Choke	Floods engine	Half throttle or less

### Daily Storage

At the end of each ride, park the snowmobile on a level surface. Support the rear with an appropriate track stand. The track should be suspended approximately 4" (10 cm) off the ground.

Remove the key and cover the snowmobile with an appropriate snowmobile cover.

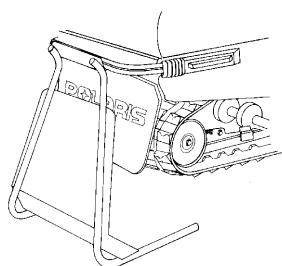

## Operation

### Pre-Ride Warm-Up

Always warm up the engine, drive train and track before operating the snowmobile. Support the rear with an appropriate track stand. The track should be suspended approximately 4" (10 cm) off the ground.

<b>▲ WARNING</b>
------------------

A loose track or flying debris could cause serious personal injury or death. Be sure the rear support is stable. Stand clear of the front of the machine and the moving track. Never hold the snowmobile up or stand behind it while performing this procedure. Do not use too much throttle during warm-up or when the track is free-hanging.
--

1. Start the engine. Allow it to idle for two to three minutes.
2. Engage the drive system abruptly and allow it to rotate the track several revolutions.

**NOTE:** In colder weather, the track will need a few more revolutions to fully warm it.

3. Stop the engine. Remove the rear support.
4. Grasp the skis by their front loops and move them from side to side to loosen frozen snow.

## **ADULT SECTION**

### **Emission Control Information**

Any qualified repair shop or qualified person may maintain, replace, or repair the emission control devices or systems on your snowmobile.

#### **Emission Control Label**

Your snowmobile is equipped at the time of sale with an emission control information (ECI) label and a factory-installed emissions information hang tag. These items are required by U.S. Environmental Protection Agency regulations. The ECI label is permanently affixed to either the right side of the tunnel or the engine recoil cover. The ECI label should not be removed, even after you purchase the snowmobile. You may remove the factory-installed emissions information hangtag, which is intended solely for your use in making a purchasing decision.

#### **Emission Control Maintenance Requirements**

Your snowmobile is certified to operate on gasoline with a minimum octane level of 87 (R+M)/2. The emission control system designation per SAE J1930 is EM. If your snowmobile is equipped with a check engine light and it comes on, you must take your snowmobile to a qualified dealer for diagnostic service. Specifications and adjustments for engine tune-ups are located in the Service Manual, which is available to your qualified service technician. Reverse (if equipped) must not be engaged during engine tune-ups.

#### **Owner's Responsibilities**

Please read the Snowmobile Engine Emissions Limited Warranty on page 92, and read the maintenance section of your owner's manual. You are responsible for ensuring that the specified maintenance is performed, including the emission-related maintenance outlined in these sections of the manual.

Polaris considers the specified maintenance for the spark plugs and oil changes to be critical emission-related maintenance. Any qualified repair shop or qualified person may maintain, replace, or repair the emission control devices or systems on your snowmobile. Polaris recommends that you contact an authorized Polaris dealer to perform any service that may be necessary.

## Maintenance

### Polaris Recommended Maintenance Program

To ensure many trouble-free miles of snowmobiling enjoyment, follow recommended regular maintenance and perform service checks as outlined in this manual. Record maintenance and service in the Maintenance Log beginning on page 94.

The recommended maintenance schedule for your snowmobile calls for a service and maintenance inspection at 50 hours, at 100 hours and at 150 hours. These inspections should be performed by a qualified service technician.

*All necessary replacement parts and labor incurred, with the exception of authorized warranty repairs, become the responsibility of the registered owner.* If, during the course of the warranty period, part failures occur as a result of owner neglect in performing recommended regular maintenance, the cost of repairs are the responsibility of the owner.

Personal safety is critical when attempting to service or make adjustments to your snowmobile. If you're not familiar with safe service or adjustment procedures and the use of tools, or if you don't feel comfortable performing these tasks yourself, contact an authorized Polaris dealer for service.

### **CAUTION**

Hot components can cause damage to plastic. Always make sure the exhaust system and engine have cooled before tipping the snowmobile on its side for service or inspection.

# ADULT SECTION

## Maintenance

### Periodic Maintenance Chart

The following chart is a guide based on average riding conditions. You may need to increase frequency based on riding conditions. When inspection reveals the need for replacement parts, always use genuine Polaris parts, available from your Polaris dealer.

ITEM	SEE PAGE	DAILY	WEEKLY OR BEFORE EXTENDED PERIOD OF OPERATION	50 HRS	100 HRS	150 HRS
Test engine stop switch	20, 25	X				
Test throttle safety switch	27	X				
Test tether switch	20	X				
Test throttle lever operation	19, 26	X				
Test brake lever operation	19	X				
Check brake operation and adjustment	56	X				
Check steering system operation	26	X				
Check operation of headlight and taillight	31	X				
Clean dust and debris from engine	--	X				
Check ski skags, replace when worn to 1/2 original diameter	71	X				
Inspect fuel lines, replace as needed	54	X				
Check engine oil level	20, 61	X				
Oil the drive chain	60		Every 10 Hrs			
Check track tension, tighten if necessary	63		Every 10 Hrs			
Grease the clutch	73		Every 15 Hrs			
Change oil	62		At 20 Hrs	X	X	X

# ADULT SECTION

## Maintenance

### Periodic Maintenance Chart

ITEM	SEE PAGE	DAILY	WEEKLY OR BEFORE EXTENDED PERIOD OF OPERATION	50 HRS	100 HRS	150 HRS
Check track alignment	65		X			
Check track condition	67		X			
Check drive chain tension	59		X			
Check and tighten any loose suspension mounting bolts	72		X			
Tighten ski saddle and spindle bolts if loose	--		X			
Check front and rear limiter strap condition, tighten loose bolts	--		X			
Check slider thickness, replace when worn (see dealer)	68		X			
Tighten rear idler wheel bolts if loose	--		X			
Check spark plug condition	52		X			
Check for brake cable wear and adjustment	56		X			
Throttle cable pivot slug	58			X	X	X
Lubricate steering post support bracket and pivot (aerosol)	--			X	X	X
Grease ski spindles	73			X	X	X
Lubricate ski bushings to spindle area	73			X	X	X
Grease lower steering post pivot	--			X	X	X
Grease rear suspension pivot shafts	72			X	X	X
Lubricate throttle cable	58				X	X
Lubricate choke slide and cable	58				X	X
Inspect exhaust pipe for cracks or damage	54			X	X	X

# ADULT SECTION

## Maintenance

### Spark Plugs

A new engine can cause temporary spark plug fouling due to the preservative added during the assembly process. Avoid prolonged idle speeds, which cause plug fouling and carbonization.

Refer to the specifications section beginning on page 80 for recommended spark plug type and gap.

### CAUTION

Using non-recommended spark plugs can result in serious engine damage. Always use the spark plugs recommended for your snowmobile.

Spark plug condition is indicative of engine operation. The spark plug firing end condition should be read after the engine has been warmed up and the vehicle has been driven. Immediately check the spark plug for correct color.

### ⚠ WARNING

A hot exhaust system and engine can cause serious burns. Wear protective gloves when removing a spark plug for inspection.

### Spark Plug Removal and Replacement

1. Stop the engine.
2. Remove the spark plug cap.
3. Using the special wrench provided in the tool pouch, rotate the spark plug counterclockwise to remove it.
4. Reverse the procedure for spark plug installation. Torque to 12-14 ft. lbs. (16-19 Nm).

## Maintenance

### Spark Plugs

#### Normal Plug

The normal insulator tip is gray, tan or light brown. There will be few combustion deposits. The electrodes are not burned or eroded. This indicates the proper type and heat range for the engine and the service.

**NOTE:** The tip should not be white. A white insulator tip indicates overheating, caused by use of an improper spark plug or incorrect carburetion adjustments.

#### Wet Fouled Plug

The wet fouled insulator tip is black. A damp oil film covers the firing end. There may be a carbon layer over the entire nose. Generally, the electrodes are not worn. General causes of fouling are excessive oil, use of non-recommended oil, improper use of the choke, or incorrect carburetion adjustments.



# ADULT SECTION

## Maintenance

### Fuel Valve/Fuel Lines

Inspect the fuel valve and the fuel lines regularly. Carefully check the system's fuel line condition after periods of storage. Normal deterioration from weather and fuel compounds can occur. Replace any worn or damaged components.

### Exhaust System

At approximately 50 hours, check the exhaust system for wear or damage. To inspect, allow the engine and exhaust system to cool completely. Open the hood and inspect the muffler and pipes for cracks or damage. Check for weak or missing retaining springs or damper/support grommets.

<b>▲ WARNING</b>
Hot exhaust system parts can cause serious burns. Allow adequate time for the exhaust system to cool. Never perform this procedure with the engine running.

## Maintenance

### Carburetor

Proper carburetor adjustment is critical, since a mixture too lean (too much air, too little fuel) will result in overheating of the combustion chamber causing pre-ignition of the fuel. This results in piston burning, bearing failure, or complete engine failure. A lean mixture can be the result of fuel line restrictions, foreign matter in the carburetor, etc. A mixture too rich (too much fuel, too little air) is also unfavorable because it can foul plugs and cause generally poor engine performance.

All carburetors have been pre-set at the factory for adequate fuel supply. Higher altitude operation may require different adjustment and settings. The number stamped in the end of the main jet indicates the jet size that was installed at the time of manufacture. For questions about optional jetting for conditions in your area, see your Polaris dealer.

Correct setup provides engine RPM within its given power band at full throttle settings and also provides maximum efficiency and operation at all other throttle openings. See your dealer for carburetor adjustments, which may include the following:

- Carburetor component changes for specific altitude and ambient temperatures
- Choke adjustment
- Air screw settings (if applicable)
- Idle RPM adjustments
- Throttle safety switch inspections and service
- Throttle block-to-throttle flipper clearance adjustment

### **CAUTION**

Improper carburetor adjustments can result in safety hazards as well as serious engine damage. We recommend that all carburetor adjustments be performed by your Polaris dealer.

# ADULT SECTION

## Maintenance

### Brake Lever Travel

Firmly depress the brake lever. Measure the clearance between the lever and brake block.

If clearance is more than 3/4" (19 mm), adjust the brake cable as outlined below.

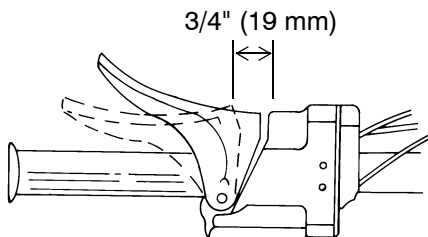

### Brake Cable Adjustment

If proper adjustment cannot be achieved using the following methods, check the brake band. If the brake band has excessive wear, see your Polaris dealer for installation of a new band.

#### **▲ WARNING**

Improper brake adjustment can result in brake failure, which could result in severe injury or death. Perform the adjustment procedures exactly as outlined, or see your Polaris dealer for service.

1. Slide the two rubber protector covers back to expose the cable adjuster.
2. Using an 8mm wrench to hold the barrel nut, loosen the jam nut with a 10mm wrench.
3. With your left hand, grasp the cables as close to the adjuster as possible. Use your right hand to rotate the barrel nut until you have reached the proper brake lever adjustment.

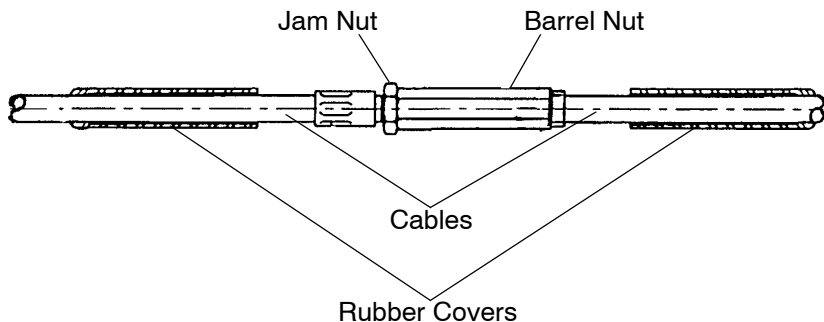

## Maintenance

### Brake Cable Adjustment

4. Check the actuator linkage to ensure there is adequate freedom of movement for positive brake operation and that all floating parts move freely and that all parts are mounted securely. Tighten hardware as required.
5. Tighten the adjuster jam nut and slide the rubber protectors onto the adjuster.
6. The brake band is adjusted correctly when brake lever freeplay is  $1/4$ -  $3/8$ " (6-10 mm) and clearance between the brake lever and block with the lever fully depressed is no more than  $3/4$ " (19 mm). Torque the band bolt nut to 6 ft. lbs. (8 Nm).

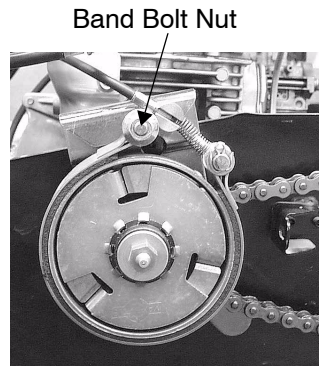
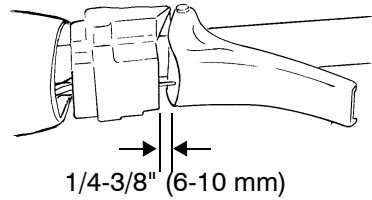

# ADULT SECTION

## Maintenance

### Throttle Cable Lubrication

With the engine off, lubricate the throttle cable occasionally. Turn the handlebars to the left and lubricate liberally with Polaris All Season Grease.

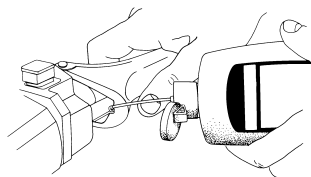

### Choke/Cable Lubrication

Lubricate the choke slide and cables occasionally as shown. Operate the choke intermittently before turning the engine off. This draws moisture out of the choke plunger area and reduces the possibility of the choke becoming frozen.

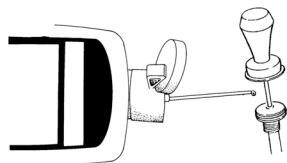

### Throttle Cable Pivot Slug

Lubricate the throttle cable pivot slug every 50 hours or twice a year using an aerosol lubricant.

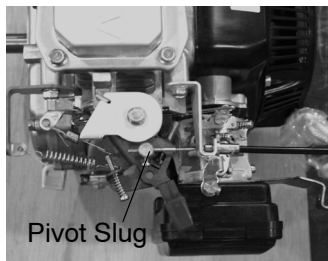

## Maintenance

### Chain Tensioner

Inspect the chain. Proper deflection is one inch (25 mm). Adjust the chain if deflection is incorrect.

1. Loosen the nut on the chain tensioner.
2. Raise the tensioner until the correct deflection is attained.
3. Tighten the nut to 15-18 ft. lbs. (20-24 Nm).

**NOTE:** When the chain has stretched to within 1/8" (3 mm) of the muffler mount bracket on the chassis, replace the chain. Inspect the sprockets as they also wear and often need replacement when the chain is replaced.

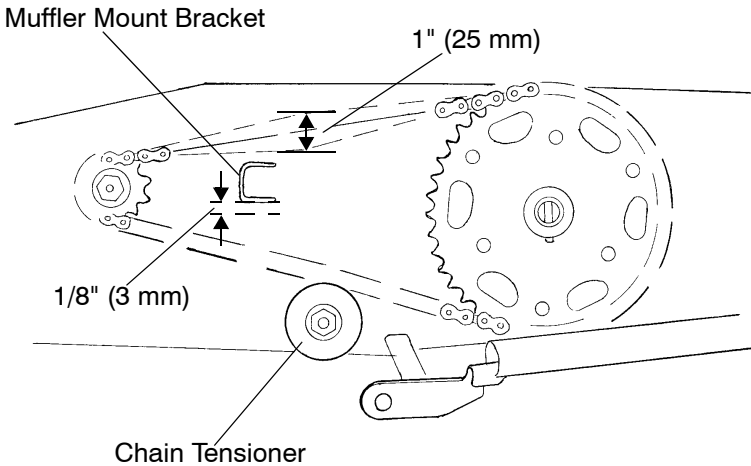

# ADULT SECTION

## Maintenance

### Driveline Lubrication

**NOTE:** Driveline noise is normal for this vehicle.

To ensure long life of the snowmobile's driveline, lubricate as follows:

- Lubricate Point A every 15 hours of operation with a small amount of Polaris Premium All Season Grease.
- Lubricate Point B every 10 hours of operation with aerosol chain lube or SAE 30 oil.

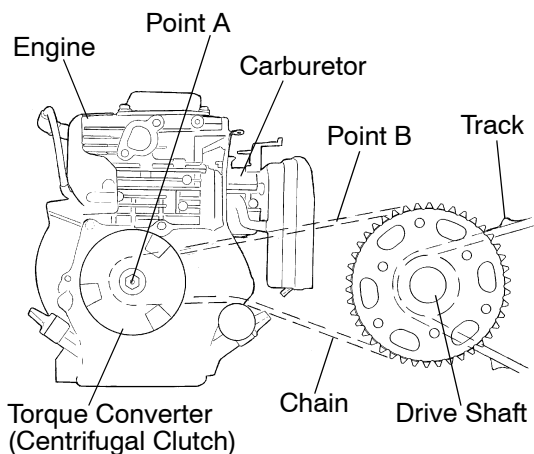

## Maintenance

### Engine Oil

#### Oil Recommendations

Polaris recommends the use of Polaris Premium 4 All Season Synthetic Oil or any class SE, SF (API classification) or higher grade oil. If multi-grade oil is used, oil consumption will increase when the ambient temperature is high.

Always check and change the oil at the intervals outlined in the Periodic Maintenance Chart beginning on page 50. Perform the break-in oil change after 20 hours of operation. Always change the oil any time it's contaminated with water, fuel or debris.

### CAUTION

Mixing brands or using a non-recommended oil may cause serious engine damage. Never substitute or mix oil brands.

#### Oil Level

Maintain the oil level between the upper and lower marks on the dipstick.

1. Position the vehicle on a level surface.
2. Stop the engine.
3. Remove the dipstick and wipe it dry with a clean shop towel.
4. Insert the dipstick into the oil fill hole completely, but do not thread it.
5. Remove the dipstick and view the oil level.
6. If the oil level is below the lower mark on the dipstick, add the recommended oil to the upper mark.

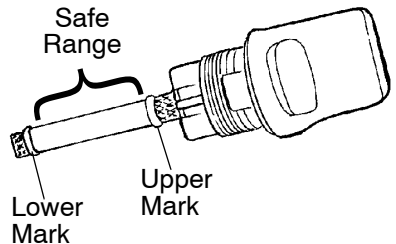
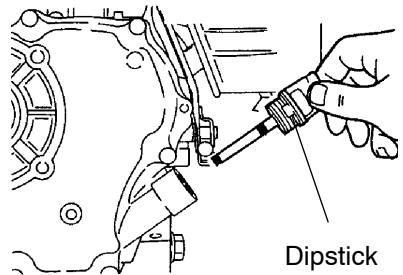



# ADULT SECTION

## Maintenance

### Engine Oil

#### Oil Change

1. Support the rear of the snowmobile slightly off the ground with an appropriate snowmobile support.
2. Place a drain pan under the drain plug.

**NOTE:** The drain plug is located under the bulkhead and in front of the engine.

3. Remove the drain plug.
4. Remove the dipstick and wipe it dry with a clean shop towel.

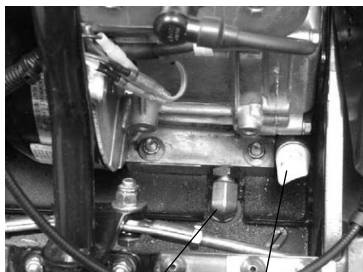

Drain Plug

Dipstick

**NOTE:** The oil will drain faster with the dipstick removed.

5. Allow the oil to drain completely.
6. Reinstall the drain plug and sealing washer.
7. Using a long funnel, pour 20 oz. (.6 l) of the recommended oil into the oil fill hole.
8. Insert the dipstick into the oil fill hole completely, but do not thread it.
9. Remove the dipstick and view the oil level.
10. If the oil level is below the lower mark on the dipstick, add the recommended oil to the upper mark.

## Maintenance

### Track Tension

Track adjustment is critical for proper handling. Always maintain correct tension and alignment.

1. Operate the snowmobile to warm up the track.
2. Stop the engine.
3. Support the rear of the snowmobile slightly off the ground with an appropriate snowmobile support.
4. Hang a 10-pound (4.5 kg) weight 8 inches (20 cm) from the center of the rear idler wheel.
5. Measure the distance between wear surface of the track clip and the plastic slider at the point where the weight is hanging. Deflection at this point should be  $\frac{3}{4}$ " (19 mm).
6. If the track tension needs adjustment, follow the procedure on page 64.

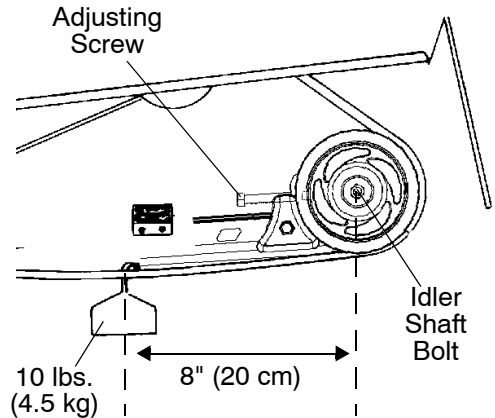

# ADULT SECTION

## Maintenance

### Track Tension Adjustment

1. Loosen the rear idler shaft bolt.
2. Tighten or loosen the track adjusting screws to provide equal adjustment on both sides of the track.
3. Repeat the measurement on the other side of the track.

**NOTE:** Check tension more frequently when the machine is new.

### **WARNING**

When performing the following checks and adjustments, stay clear of all moving parts to avoid serious personal injury. Make sure the track contains no objects that could be thrown out while the track is rotating. Keep clear of track. This includes but is not limited to hands, tools, feet and clothing. Make sure no one is standing close to the machine while the track is rotating.

4. Start the engine and slowly rotate the track at least five revolutions. Allow the track to stop rotating by itself (do not apply brakes).
5. Check and adjust track alignment. See page 65.
6. Tighten the idler shaft bolt. Torque to 35-40 ft. lbs. (47-54 Nm).
7. Readjust the toe block to proper spacing and tighten.

## Maintenance

### Track Alignment

Check track alignment at the intervals outlined in the periodic maintenance chart beginning on page 50. Make sure the track is centered and running evenly on the slide rails. Misalignment will cause excessive wear to the track and slide rail.

#### **⚠ WARNING**

When performing the following checks and adjustments, stay clear of all moving parts to avoid serious personal injury. Make sure the track contains no objects that could be thrown out while the track is rotating. Keep clear of track. This includes but is not limited to hands, tools, feet and clothing. Make sure no one is standing close to the machine while the track is rotating.

1. Support the rear of the snowmobile slightly off the ground with an appropriate snowmobile support.
2. Start the engine and apply a small amount of throttle until the track turns *slowly* at least five complete revolutions. Stop the engine.
3. Inspect track alignment by looking through the track windows to make sure the rails are evenly spaced on each side. If the track runs to the left, loosen the left idler wheel mounting bolt and tighten the left track adjusting bolt. If the track runs to the right, loosen the right idler wheel mounting bolt and tighten the right track adjusting bolt.
4. After adjustments are complete, tighten the locknuts and idler shaft bolts. Torque to 35-40 ft. lbs. (47-54 Nm).
5. Repeat step 2 to verify proper alignment.

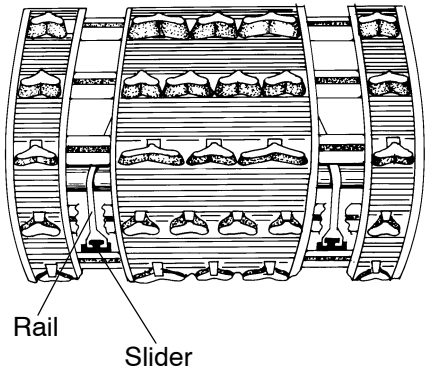

# ADULT SECTION

## Maintenance

### Track Warm Up

After storing your snowmobile outside overnight, warm up the track before driving the snowmobile. This reduces drive clutch wear.

1. Support the rear of the snowmobile slightly off the ground with an appropriate snowmobile support.

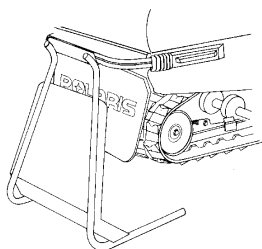

### **⚠ WARNING**

Never hold the snowmobile up or stand behind it while rotating the track. A loose track or flying debris could cause serious personal injury or death.



2. Start the engine.
3. Abruptly engage the clutch, allowing the track to turn for several revolutions.
4. Release the throttle and apply the brakes.
5. Stop the engine.
6. Lower the rear of the snowmobile to the ground while the engine is off.

## Maintenance

### Track Inspection

Check track condition at the intervals outlined in the periodic maintenance chart beginning on page 50.

#### **▲ WARNING**

Inspecting the track while the engine is running can result in serious personal injury if the track should be moving. Never inspect the track with the engine running. Never hold the snowmobile up or stand behind it while rotating the track. A loose track or flying debris could cause serious personal injury or death.



1. Support the rear of the snowmobile slightly off the ground with an appropriate snowmobile support.
2. Rotate the track by hand to check for wear or damage.
3. Carefully examine the track along the entire length of each track rod, bending the track and inspecting for breakage.

**NOTE:** The three most common places where breakage occurs are shown in the illustration.

4. Check the track clips and tighten any loose clips. If any rod damage is found, install a new track.

**NOTE:** This snowmobile track has molded-in track clips. It is common for a thin layer of rubber to detach from the clip area and peel off during initial use.

Common Breakage Areas

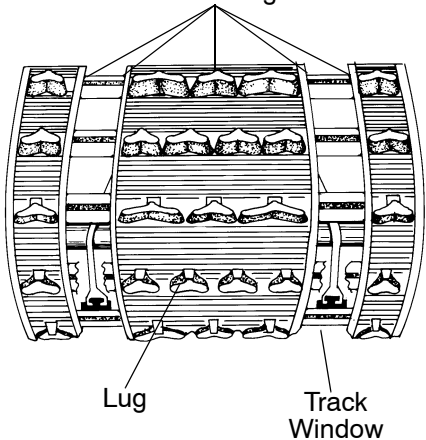

# ADULT SECTION

## Maintenance

### Slider Replacement

Polaris rail slides have a wear limit indicator groove to indicate the minimum permissible slide thickness. Replace the rail slides if they are worn to the top of the groove at any point along their length. Failure to do so may result in permanent damage to the track or rails.

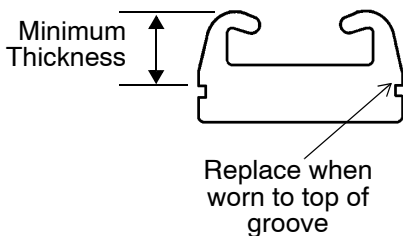

### Track Lubrication

Track failure, loss of vehicle control and braking ability can result from extended use of this vehicle on surfaces providing marginal lubrication between the slider and track guide clips. Examples of marginal lubrication would include lakes without snow cover, icy trails and no-snow conditions.

The slide rail is designed to operate in conditions with adequate snow cover in order to provide sufficient lubrication. Excessive wear indicates insufficient lubrication. A new slider can cause faster heat build up in limited lubrication than a used slider, resulting in excessive wear.

**NOTE:** Track damage or failure caused by operation on ice or poor lubrication conditions may void the track warranty.

### Steering System

The steering systems on Polaris snowmobiles can be adjusted with ski toe alignment. Improper toe alignment can cause erratic steering. See your dealer for adjustments.

#### **▲ WARNING**

Improper alignment or adjustment may cause loss of steering control, resulting in serious injury or death. Do not attempt to change the ski alignment. See your Polaris dealer.

## Maintenance

### Steering Inspection

Each week, or before a long ride, check all steering system fasteners. Tighten any loose fasteners. The stars in the illustration below indicate fastener locations.

### Steering Adjustment

With the handlebars in a straight ahead position, and with vehicle weight compressing the suspension, measure from the straight edge of the skis at the center of the ski mounting bolt. The measurement between the skis at point X should be  $1/8''$  (3 mm) greater than the measurement at point Y.

**NOTE:** If the skis are misaligned, we recommend that your dealer make the necessary adjustments.

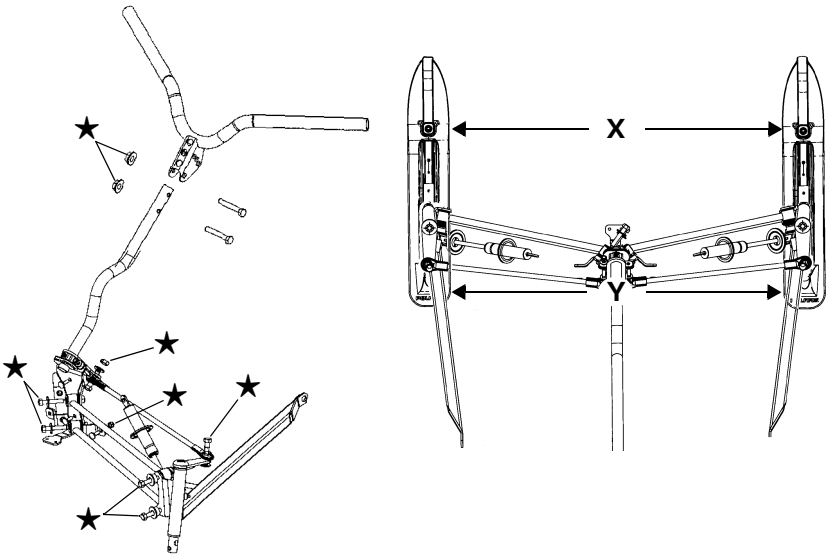



# ADULT SECTION

## Maintenance

### Handlebar Adjustment

1. Slide the handlebar pad upward to access the adjuster bolts. If additional room is required, unzip one of the handlebar pad zippers and roll the pad to the side.
2. Remove the upper flange nut and carriage bolt.
3. Loosen the lower flange nut only enough so the bracket can move freely.
4. Position the handlebar to the desired height.
5. Reinstall the upper carriage bolt and flange nut.
6. Torque both flange nuts to 15-17 ft. lbs. (20-23 Nm).
7. Reinstall the handlebar pad.

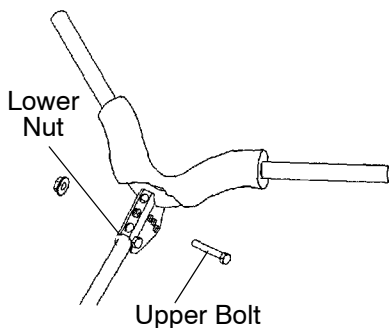

## Maintenance

### Ski Skags

The skag is a replaceable bar attached to the underside of the ski. The purpose of the skag is to assist in turning the snowmobile and to prevent the wearing away of the ski caused by contact with roads and other bare terrain.

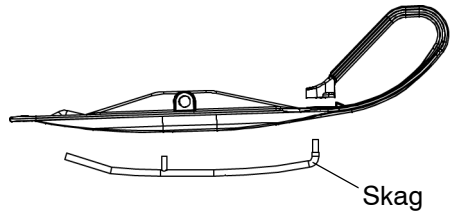

Check skags weekly to maintain positive steering characteristics. Replace skags when they are worn to half their original diameter.

**NOTE:** See the dealer track studding and skag chart for recommended skags.

### **⚠ WARNING**

Worn skis and/or skags will adversely affect handling and can cause loss of vehicle control, which can lead to serious injury or death. Replace worn skis and/or skags when inspection reveals wear.

### Skag Replacement

1. Raise and support the front of the machine so the skis are approximately 6" (15 cm) off the ground.
2. Remove the attaching nuts and pry the skag downward.
3. Remove the forward portion of the skag.
4. Reverse this procedure for new skag installation.

**NOTE:** If the rear idler wheel assembly washers are removed, be sure they are reinstalled with the domed side of the washer facing outward as shown.

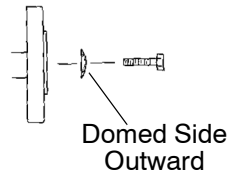
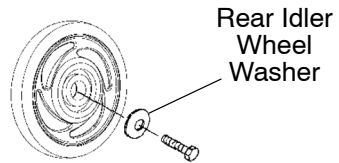

# ADULT SECTION

## Maintenance

### Lubrication Recommendations

#### Suspension

To maintain rider comfort and to retard wear of the pivot shafts, lubricate the suspension pivot shafts with Polaris Premium All Season Grease several times during the season and again before summer storage each year. Lack of lubrication will result in reduced performance and a less comfortable riding experience.

**NOTE:** The stars in the following illustration indicate lubrication points. A grease gun kit complete with grease and adaptors is available to lubricate all fittings on Polaris snowmobiles. See page 82 for the part numbers of Polaris products.

**IMPORTANT:** Make it a weekly practice to check for loose bolts and nuts on the suspension system. If any loose bolts are found on the rail be sure to clean the threads and apply LOCTITE 262 before tightening.

#### Suspension Components

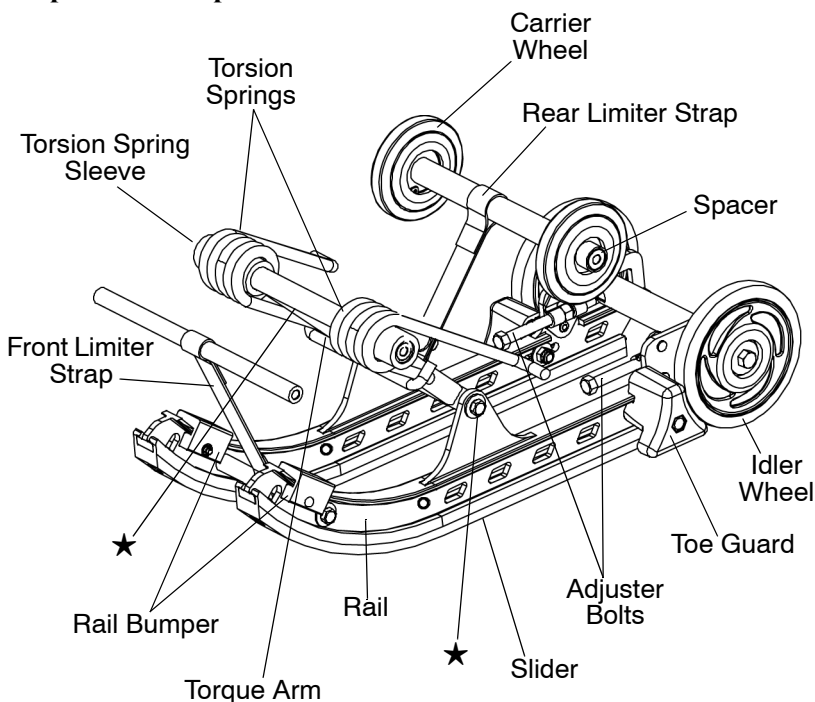

## Maintenance

### Lubrication Recommendations

Inspect and lubricate all greaseable components at the intervals outlined in the Periodic Maintenance Chart beginning on page 50.

### Controls and Linkage

Lubricate all bushings, spindle shafts, and tie rod ends with a light coat of oil or grease. Lubricate throttle and brake controls and cables with Polaris Premium All Season Grease. Force a small amount of lubricant down the cable.

### Bearings

Always grease drive shaft clutch side bearings with a high quality bearing grease to prevent corrosion, which will destroy the bearings.

### Electrical Connections

Separate the electrical connector blocks and clean corrosive build-up from the connectors. Lubricate the blocks with dielectric grease and re-connect. Replace worn or frayed electrical wire and connectors. Be sure wiring harnesses are properly secured away from sharp edges, steering linkage, moving parts, and hot exhaust components.

# ADULT SECTION

## Maintenance

### Washing the Vehicle

Keeping your Polaris vehicle clean will not only improve its appearance but it can also extend the life of various components.

<b>CAUTION</b>
----------------

High water pressure may damage components. Polaris recommends washing the vehicle by hand or with a garden hose, using mild soap.
---

The best and safest way to clean your Polaris vehicle is with a garden hose and a pail of mild soap and water.

1. Use a professional-type washing cloth, cleaning the upper body first and the lower parts last.
2. Rinse with clean water frequently.
3. Dry surfaces with a chamois to prevent water spots.

### Washing Tips

- Avoid the use of harsh cleaners, which can scratch the finish.
- Do not use a power washer to clean the vehicle.

**NOTE:** If a high pressure car wash is used (not recommended), grease all zerk fittings immediately after washing. Also run the vehicle to evaporate any water that might have entered the engine or exhaust system.

- Do not use medium to heavy duty compounds on the finish.
- Always use clean cloths and pads for cleaning and polishing. Old or reused cloths and pads may contain dirt particles that will scratch the finish.
- If any decal becomes illegible or comes off, contact your Polaris dealer to purchase a replacement. Replacement *safety* decals are provided by Polaris at no charge

### Waxing the Vehicle

Your snowmobile can be waxed with any high quality brand of automotive paste wax. Avoid the use of harsh cleaners since they can scratch the body finish.

## Maintenance

### Storage

Off season or extended storage of your snowmobile requires preventive measures to aid against deterioration and to prolong the useful life of many components.

### Fog the Engine

1. Treat the fuel system with Polaris Carbon Clean. See page 76.
2. Support the front end of the machine so the engine is level or tilted slightly rearward.
3. Turn the fuel valve off.
4. Remove the spark plug.
5. Pour 5cc of Premium 4 Synthetic 0W40 engine oil into the cylinder.
6. Slowly pull the recoil starter to turn the engine over two or three times.
7. Reinstall the spark plug.
8. Rotate the piston to bottom dead center (BDC) and
9. Slowly pull the recoil starter handle until resistance is felt. Leave it in that position.
10. Clean the engine thoroughly with an oiled cloth.

**NOTE:** If Polaris fuel system additive is not used, the fuel tank, fuel lines, and carburetor should be completely drained of gasoline. Observe all fire safety rules when draining the carburetor. Review the fuel-related warnings on page 43. To eliminate any fuel remaining in the carburetor, run the engine until it stops.

# ADULT SECTION

## Maintenance

### Storage

#### Stabilize the Fuel

Proper off-season preparation of the engine and fuel system is vital to the prevention of rust and corrosion formation on precision engine parts during storage. See page 82 for the part numbers of Polaris products.

1. Fill the fuel tank with fresh fuel.
2. Add Polaris Carbon Clean Fuel Treatment or Polaris Fuel Stabilizer. Follow the instructions on the container for the recommended amount.

**NOTE:** Carbon Clean removes water from fuel systems, stabilizes fuel and removes carbon deposits from pistons, rings, valves and exhaust systems.

3. Start the engine. Allow it to idle for five minutes to disperse additives through the entire fuel system.
4. Turn the fuel valve off.

## Maintenance

### Storage

#### Track and Suspension

Support the rear of the snowmobile slightly off the ground with an appropriate snowmobile support. This will allow the track to hang freely.

Elevate the front end of the machine and place blocks securely under it to remove tension from the shocks and springs. This will minimize fatigue on the front shocks and springs.

#### Storage Area

Your snowmobile should be stored in a dry garage or shed, out of direct sunlight. It should be covered with a fabric snowmobile cover. Plastic covers can cause condensation to form and may damage some snowmobile components.

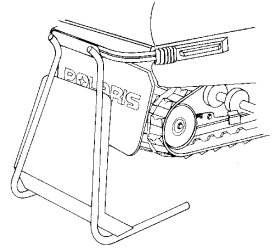



# **ADULT SECTION**

## **Maintenance**

### **Transporting the Snowmobile**

Whenever the snowmobile is transported the following measures should be taken:

1. Turn the fuel valve off.
2. Be sure the fuel cap is installed correctly.
3. Always tie the snowmobile to the transporting unit securely using suitable straps.

### **Fall Tune-Up**

To obtain maximum performance from your snowmobile, we encourage you to arrange for a fall service tune-up with your Polaris dealer.

### **Towing**

Do not pull or tow any person or object behind this snowmobile. If a disabled snowmobile must be towed by another snowmobile, attach the tow rope to the spindles of the disabled snowmobile, not to the ski toe loops.

### **Emergency Preparation**

For your added protection, carry the following items in your snowmobile when traveling farther than a five-minute walk from home.

- Extra Spark Plugs
- First Aid Kit
- Winter Survival Kit
- Extra Gloves
- Owner's Manual

# TROUBLESHOOTING

## Engine Turns Over, Fails to Start

Contact your Polaris dealer for service if you're unable to identify solutions using the following chart.

Possible Cause	Solution
Tether switch not engaged	Install tether switch/strap
Engine stop switch not on	Pull stop switch up to RUN position
Throttle safety switch malfunction	See your Polaris dealer
Out of fuel	Refuel
Clogged fuel valve or filter	Inspect and clean or replace
Water is present in fuel	Drain the fuel system and refuel
Fuel valve is off	Turn the fuel valve on
Old or non-recommended fuel	Replace with new fuel
Fouled or defective spark plug(s)	Inspect plug(s), replace if necessary
No spark to spark plug	Inspect plug(s), verify stop switch is on
Overuse of choke	Inspect, clean and/or replace spark plugs
Mechanical failure	See your Polaris dealer

# SPECIFICATIONS

## Capacities and Dimensions

Body Style	Mini Indy
Rider/Weight Capacity	1/150 lbs. (68 kg) maximum
Dry Weight	147.5 lbs. (67 kg)
Fuel Tank Capacity	.5 gal. (1.9 l)
Engine Oil Capacity	20 oz. (.6 l)
Height	31 in. (78.7 cm)
Length	75 in. (190.5 cm)
Width	34 in. (86.4 cm)
Track Length	69 in. (175.3 cm)
Track Width	10 in. (25.4 cm)
Brake Type	Mechanical
Ski Center Distance	30 in. (76.2 cm)
Clutch Type	Centrifugal
Drive Chain Length	#40

## Suspension

Front Type	IFS
IFS Shock Type	Mini
Rear Type	Mini Indy

## Engine and Cooling

Engine Model Number	EH122PM017	
Alternator Output	50 watt @ 3600 rpm	
Bore x Stroke	60 x 43 mm	
Displacement	121 cc	
Carburetor Model	Mikuni BV18	NOTE: <i>These carburetor settings are to be used in conjunction with the jetting chart on the following page, which is based on the recommended fuel octane.</i>
Idle RPM +/- 200	1650	
Main Jet	70	
Pilot Jet	50	
Cutaway	170 Throttle Valve	
Fuel Screw	1.75 Turns	
Pilot Air Jet	1.3	
Cooling	Air	
Cylinders	1	
Ignition Timing	23° BTDC @ 3600 RPM	
Ignition Type	Flywheel Magneto (solid state)	
Oil Injection	0W-40 Synthetic	
Spark Plug/Gap	NGK BR6ES/.028" (.70 mm)	
Recommended Fuel Octane	Minimum 87 octane non-oxygenated or 89 octane oxygenated	

# SPECIFICATIONS

## Carburetor Jetting

AMBIENT TEMPERATURE								
ALTITUDE Meters (Feet)	Below -25°F (-31°C)	-30° to -10°F (-34° to -23°C)	-15° to +5°F (-26°C to -15°C)	0° to +20°F (-18° to -7°C)	+15° to +35°F (-9° to +2°C)	+30° to +50°F (-1° to +10°C)	+45° to +65°F (+7° to +18°C)	Above +60°F (+16°C)
NOTE: Main jet is the first number in each cell; Pilot jet is the second number (in italics)								
0-600 (0-2000)	72.5 <i>55</i>	72.5 <i>55</i>	<b>70</b> <i>50</i>	70 <i>50</i>	70 <i>50</i>	67.5 <i>50</i>	67.5 <i>45</i>	67.5 <i>45</i>
600-1200 (2000-4000)	70 <i>50</i>	70 <i>50</i>	70 <i>50</i>	67.5 <i>50</i>	67.5 <i>50</i>	67.5 <i>50</i>	65 <i>45</i>	65 <i>45</i>
1200-1800 (4000-6000)	67.5 <i>50</i>	67.5 <i>50</i>	67.5 <i>50</i>	65 <i>50</i>	65 <i>50</i>	65 <i>45</i>	62.5 <i>45</i>	62.5 <i>45</i>
1800-2400 (6000-8000)	65 <i>50</i>	65 <i>50</i>	65 <i>50</i>	65 <i>50</i>	65 <i>45</i>	62.5 <i>45</i>	62.5 <i>45</i>	60 <i>45</i>
2400-3000 (8000-10000)	65 <i>50</i>	65 <i>50</i>	62.5 <i>50</i>	62.5 <i>45</i>	60 <i>45</i>	60 <i>45</i>	60 <i>45</i>	60 <i>45</i>
3000-3700 (10000-12000)	62.5 <i>50</i>	62.5 <i>50</i>	60 <i>45</i>	60 <i>45</i>	60 <i>45</i>	57.5 <i>45</i>	57.5 <i>45</i>	57.5 <i>45</i>

# POLARIS PRODUCTS

Part No.	Description
<b>Engine Lubricants</b>	
2870791	Fogging Oil (12 oz. Aerosol)
2871281	Premium 4 Synthetic 0W-40 Engine Oil (4-Cycle)(qt.)
<b>Gearcase/Transmission Lubricants</b>	
2873602	Premium Synthetic Gearcase Lubricant (qt.)
2871653	Premium Front Gearcase Fluid (8 oz.)
2871654	Premium Demand Drive Hub Fluid (8 oz.)
<b>Grease/Specialized Lubricants</b>	
2871312	Grease Gun Kit, Premium All Season (3 oz.)
2871322	Premium All Season Grease (3 oz. cartridge)
2871423	Premium All Season Grease (14 oz. cartridge)
2871329	Dielectric Grease (Nyogel™)
<b>Coolant</b>	
2871323	Anitfreeze, 60/40 Premix (gal.)
2871534	Anitfreeze, 60/40 Premix (qt.)
<b>Additives/Miscellaneous</b>	
2871326	Carbon Clean Plus (12 oz.)
2870652	Fuel Stabilizer (16 oz.)
2872189	DOT 4 Brake Fluid (12 oz.)
2872893	Engine Degreaser (12 oz.)
2870505	Isopropyl
2872889	Brake and Clutch Cleaner
2872890	Carb and Throttle Body Cleaner

## Service and Warranty Information

### Obtaining Service and Warranty Assistance

Read and understand the service data and the Polaris warranty information contained in this manual. Contact your Polaris dealer for replacement parts, service or warranty. Your dealer receives frequent updates on changes, modifications and tips on snowmobile maintenance, which may supersede information contained in this manual. Your dealer is also familiar with Polaris policies and procedures and will be happy to assist you.

When contacting us about parts, service, or warranty, always provide the following information:

1. Serial number
2. Model number
3. Dealer name
4. Date of purchase
5. Details of trouble experienced
6. Length of time and conditions of operation
7. Previous correspondence

Use the page provided near the front of your Owner's Manual to record the identification numbers of your snowmobile and its engine.

### **Polaris Customer Service**

United States: 1-763-417-8650

Canada: 1-204-925-7100

# **WARRANTY**

## **Service and Warranty Information**

### **Polaris Anti-Theft System**

The Polaris anti-theft system (PATS) monitoring program is designed to aid owners of registered snowmobiles in recovery of stolen machines.

#### **Administration**

1. Polaris snowmobile owner reports theft.
  - A. In addition to notifying the proper law enforcement officials, the owner must call Polaris Customer Service.
  - B. Owners must provide their name, address, telephone number and the model and serial number of stolen machines.
2. Polaris warranty will provide all dealerships with a monthly updated list of all stolen units to further monitor thefts.
3. Polaris warranty will aid in notifying the proper owner when a unit is recovered.

## Limited Warranty

Polaris Sales Inc., 2100 Highway 55, Medina, MN 55340, provides a ONE YEAR LIMITED WARRANTY on all components of the Polaris snowmobile against defects in material or workmanship. This warranty covers the parts and labor charges for repair or replacement of defective parts that are covered by this warranty. The warranty begins on the date of purchase. This warranty is transferable to another consumer, during the warranty period, through a Polaris dealer.

## Registration

At the time of sale, the Warranty Registration Form must be completed by your dealer and submitted to Polaris within ten days. Upon receipt of this registration, Polaris will record the registration for warranty. No verification of registration will be sent to the purchaser as the copy of the Warranty Registration Form will be the warranty entitlement. If you have not signed the original registration and received the customer copy, please contact your dealer immediately. **NO WARRANTY COVERAGE WILL BE ALLOWED UNLESS THE SNOWMOBILE IS REGISTERED WITH POLARIS.**

Initial dealer preparation and setup of your snowmobile is very important in ensuring trouble-free operation. Purchasing a snowmobile in the crate or without proper dealer setup will void your warranty coverage.

## Warranty Coverage and Exclusions

### Limitations of warranties and remedies

This warranty excludes any failures not caused by a defect in material or workmanship. The warranty does not cover accidental damage, normal wear and tear, abuse or improper handling. The warranty also does not cover any snowmobile that has been structurally altered, neglected, improperly maintained, used for racing or used for purposes other than for which it was manufactured. The warranty does not cover any damages that occur during trailer transit or as a result of unauthorized service or parts. In addition, this warranty does not cover physical damage to paint or finish, stress cracks, tearing or puncturing of upholstery material, corrosion or defects in parts, components or the snowmobile due to fire, explosions or any other cause beyond Polaris' control.

This warranty does not cover the use of unauthorized lubricants, chemicals, or fuels that are not compatible with the snowmobile.

The exclusive remedy for breach of this warranty shall be, at Polaris' exclusive option, repair or replacement of any defective materials, or components or products. **THE REMEDIES SET FORTH IN THIS WARRANTY ARE THE ONLY REMEDIES AVAILABLE TO ANY PERSON FOR BREACH OF THIS WARRANTY. POLARIS SHALL HAVE NO LIABILITY TO ANY PERSON FOR INCIDENTAL, CONSEQUENTIAL OR SPECIAL DAMAGES OF ANY DESCRIPTION, WHETHER ARISING OUT OF EXPRESS OR IMPLIED WARRANTY OR ANY OTHER CONTRACT, NEGLIGENCE, OR OTHER TORT OR OTHERWISE.** Some states do not permit the exclusion or limitation of incidental or consequential damages or implied warranties, so the above limitations or exclusions may not apply to you if inconsistent with controlling state law.



# WARRANTY

## Limitations of warranties and remedies

ALL IMPLIED WARRANTIES (INCLUDING BUT NOT LIMITED TO THE IMPLIED WARRANTIES OF MERCHANTABILITY AND FITNESS FOR A PARTICULAR PURPOSE) ARE LIMITED IN DURATION TO THE ABOVE ONE YEAR WARRANTY PERIOD. POLARIS FURTHER DISCLAIMS ALL EXPRESS WARRANTIES NOT STATED IN THIS WARRANTY. Some states do not allow limitations on how long an implied warranty lasts, so the above limitation may not apply to you if inconsistent with controlling state law.

## How to Obtain Warranty Service

If your snowmobile requires warranty service, you must take it to a Polaris dealer authorized to repair Polaris snowmobiles. When requesting warranty service you must present your copy of the Warranty Registration form to the dealer. (The cost of transportation to and from the dealer is YOUR responsibility). Polaris recommends that you use your original selling dealer; however, you may use any Polaris Servicing Dealer to perform warranty service.

Please work with your dealer to resolve any warranty issues. Your dealer will contact the appropriate personnel at Polaris if additional assistance is needed.

This warranty gives you specific legal rights, and you may also have other rights which vary from state to state.

If any of the above terms are void because of state or federal law, all other warranty terms will remain in effect.

## Engine Oil

1. Mixing oil brands or using non-recommended oil may cause engine damage. We recommend the use of Polaris engine oil.
2. Damage resulting from the use of non-recommended lubricants may not be covered by warranty.

# WARRANTY

## Conditions and Exclusions

In order to qualify for warranty, the product must have been properly set up and tested by a Polaris Dealer (if applicable). Failure of any dealer to perform the required vehicle Pre-Delivery Inspection, perform all applicable service bulletins and have the consumer sign the PDI form prior to delivery may void the warranty. Failure to provide proof of required periodic maintenance upon request may result in denial of warranty coverage. Use of the recommended Polaris products for lubrication and maintenance as directed by the Owner's manual is highly recommended. Should a failure occur during the warranty period resulting from the use of non-recommended products, warranty coverage may be denied.

Warranty does not apply to parts exposed to friction surfaces, stresses, environmental conditions and/or contamination. The following items are excluded from warranty consideration if the failure was due to wear or not the direct result of a defect:

Skis	Ski wear rods
Tracks	Slide rails
Suspension components	Finished and unfinished surfaces
Brake components	Carburetor/Throttle body components
Seat components	Engine components
Clutches and components	Drive belts
Steering components	Hydraulic components
Batteries	Circuit breakers/Fuses
Light bulbs/Sealed beam lamps	Electronic components
Idler wheels	

Warranty applies to the product only and does not allow for coverage of personal loss. Some items are considered "consumable," meaning they are considered part of normal maintenance or part of completing an effective repair. The following items are excluded from warranty coverage in the event of a warranty claim:

Spark Plugs	Lubricants such as oil, grease, etc.
Filters	Batteries (unless defective)
Fuel	Cosmetic damage/repair
Sealants	Coolants
Hotel fees	Meals
Towing charges	Shipping/ handling fees
Mileage	Product pick-up/delivery
Rentals/Loss of product use	Loss of vacation/personal time

This warranty also excludes failures resulting from improper lubrication; improper engine timing; improper fuel; surface imperfections caused by external stress, heat, cold or contamination; operator error or abuse; improper component alignment, tension, adjustment or altitude compensation; failure due to snow, water, dirt or other foreign substance ingestion/contamination; improper maintenance; modified components; use of aftermarket components resulting in failure; unauthorized repairs; repairs made after the warranty period expires or by an unauthorized repair center; use of the product in competition or for commercial purposes. Warranty will not apply to any product which has been damaged by abuse, accident, fire or any other casualty not determined a defect of materials or workmanship.

# WARRANTY

## Polaris Second Year Engine Service Contract

Second Year Engine Service Contract is standard on all eligible new and unused snowmobiles that were Snow Checked through an authorized Polaris dealer during the March/April Snow Check promotion. The free Second Year Engine Service Contract is honored by all authorized Polaris snowmobile dealers in North America and is transferable 120 days after the original purchase date, free of charge, through any Polaris snowmobile dealer. Coverage on Snow Check units is automatic. Although you do not receive a warranty card, your dealership should have printed a copy of the warranty registration form. This form is your proof of warranty.

### Consumer Exclusions

- Each repair visit after the first twelve months of standard warranty coverage is subject to a \$50 deductible.
- The free Second Year Engine Service Contract applies to the first 5,000 miles or two (2) calendar years from date of purchase, whichever comes first. Tampering with the odometer shall void all warranties/service contracts. No extensions to coverage under this engine service contract can be given. Used snowmobiles are not eligible under this program.
- Snowmobiles used for commercial purposes or for racing are excluded from coverage.

# WARRANTY

## Polaris Second Year Engine Service Contract

### Coverage

Coverage for second year engine failures due to defects in materials and workmanship will be determined by Polaris in its sole discretion. Coverage is automatic with no additional paperwork required. The free Second Year Engine Service Contract is subject to a \$50 deductible per visit. Regular, documented service maintenance visits are required to validate this warranty.

A partial list of items excluded from coverage includes:

- Damage due to accident, fire, explosion, theft, or other causes beyond Polaris' control.
- Damage caused by the failure of other components of the snowmobile.
- Failures caused by improper fuel or oil.
- Piston seizures, unless caused by a defective engine component.
- Failures caused due to improper adjustments.
- Failure due to unauthorized service.
- Failures due to lack of service as required in the owner's manual or Polaris updates. This includes off-season storage as listed in the owner's manual.
- Failure due to use of unauthorized parts or modifications.
- Normal wear parts, including but not limited to spark plugs, hoses, batteries, controls, and recoil ropes are excluded from coverage. Gaskets are covered, as are intake and exhaust manifolds excluding paint coverage.
- Electrical coverage is limited to the ECU box, coils, stator plate, and sensors. Wiring and other electrical components are excluded from coverage.
- Cooling system coverage is limited to the water pump assembly and components, fan, fan bearings, temperature sensor, gasket and seals.
- Non wear related throttle body parts are covered. The fuel pump is covered.
- Clutches and related clutch parts, including but not limited to, the drive belt, are excluded from coverage.
- Electrical components are excluded from coverage.
- Gearcases and transmissions are excluded from coverage.

# WARRANTY

## Exported Vehicles

EXCEPT WHERE SPECIFICALLY REQUIRED BY LAW, THERE IS NO WARRANTY OR SERVICE BULLETIN COVERAGE ON THIS VEHICLE IF IT IS SOLD OUTSIDE THE COUNTRY OF THE SELLING DEALER'S AUTHORIZED LOCATION.

This policy does not apply to vehicles that have received authorization for export from Polaris Industries. Dealers may not give authorization for export. You should consult an authorized dealer to determine this vehicle's warranty or service bulletin coverage if you have any questions.

This policy does not apply to vehicles registered to government officials or military personnel on assignment outside the country of the selling dealer's authorized location.

This policy does not apply to Safety Recalls.

## Exported Vehicles

### How to Get Service

#### *In the Country where your vehicle was purchased:*

Warranty or Service Bulletin repairs must be done by an authorized Polaris dealer. If you move or are traveling within the country where your vehicle was purchased, Warranty or Service Bulletin repairs may be requested from any authorized Polaris dealer who sells the same line as your vehicle.

#### *Outside the Country where your vehicle was purchased:*

If you are traveling temporarily outside the country where your vehicle was purchased, you should take your vehicle to an authorized Polaris dealer. You must show the dealer photo identification from the country of the selling dealer's authorized location as proof of residence. Upon residence verification, the servicing dealer will be authorized to perform the warranty repair.

#### *If You Move:*

If you move to another country, be sure to contact Polaris Customer Assistance and the customs department of the destination country before you move. Vehicles importation rules vary considerably from country to country. You may be required to present documentation of your move to Polaris Industries in order to continue your warranty coverage. You may also be required to obtain documentation from Polaris Industries in order to register your vehicle in your new country.

#### *If Purchased From A Private Party:*

If you purchase a Polaris product from a private citizen outside of the country in which the vehicle was originally purchased, all warranty coverage will be denied.

### Notice

If your vehicle is registered outside of the country where it was purchased, and you have not followed the procedure set out above, your vehicle will no longer be eligible for warranty or service bulletin coverage of any kind. (Vehicles registered to Government officials or military personnel on assignment outside of the country where the vehicle was purchased will continue to be covered by the basic warranty.)

*For questions call Polaris Customer Assistance (see page 83).*

# WARRANTY

## Snowmobile Engine Emissions Limited Warranty

This snowmobile engine emissions limited warranty is in addition to the Polaris standard limited warranty for snowmobiles. Polaris Industries Inc. warrants that at the time it is first purchased, this emissions-certified snowmobile engine meets current U.S. Environmental Protection Agency regulations applicable to snowmobile emissions under 40 CFR1051, 1065 and 1068.

Polaris warrants that the engine is free from defects in materials and workmanship that would cause it to fail to meet these regulations. The warranty period for this emissions certified snowmobile engine starts on the date when the engine is first purchased and continues for 4000 kilometers (2485 miles) of vehicle travel, 200 hours of operation, or 30 calendar months, whichever comes first.

This engine emissions limited warranty covers the parts and labor charges for repair or replacement of defective parts that are covered by this warranty. This includes components whose failure increases the snowmobile engine's emissions. To the extent they are present on your snowmobile engine, this includes electronic controls, fuel injection components, exhaust-gas recirculation system components, and aftertreatment system components. Replacing or repairing other components not covered by this warranty is the responsibility of the snowmobile owner.

The exclusive remedy for breach of this limited warranty shall be, at the exclusive option of Polaris, repair or replacement of any defective materials, components or products.

THE REMEDIES SET FORTH IN THIS LIMITED WARRANTY ARE THE ONLY REMEDIES AVAILABLE TO ANY PERSON FOR BREACH OF THIS WARRANTY. POLARIS SHALL HAVE NO LIABILITY TO ANY PERSON FOR INCIDENTAL, CONSEQUENTIAL OR SPECIAL DAMAGES OF ANY DESCRIPTION, WHETHER ARISING OUT OF EXPRESS OR IMPLIED WARRANTY OR ANY OTHER CONTRACT, NEGLIGENCE OR OTHER TORT OR OTHERWISE. ALL IMPLIED WARRANTIES (INCLUDING BUT NOT LIMITED TO ANY IMPLIED WARRANTIES OF MERCHANTABILITY AND FITNESS FOR A PARTICULAR PURPOSE) ARE LIMITED IN DURATION TO THE WARRANTY PERIOD DESCRIBED HEREIN. POLARIS DISCLAIMS ALL EXPRESS WARRANTIES NOT STATED IN THIS WARRANTY.

# WARRANTY

## Snowmobile Engine Emissions Limited Warranty

Some states do not allow limitations on how long an implied warranty lasts, so the above limitation may not apply if it is inconsistent with the controlling state law. This limited warranty excludes failures not caused by a defect in material or workmanship. This limited warranty does not cover damage due to accidents, abuse or improper handling, maintenance or use. This limited warranty also does not cover any engine that has been structurally altered, or any engine that has been used in racing competition. This limited warranty also does not cover physical damage, corrosion or defects caused by fire, explosions or other similar causes beyond the control of Polaris.

Owners are responsible for performing the scheduled maintenance identified in the owner's manual. Polaris can deny an emissions warranty claim if any specified critical emissions-related maintenance is not performed. Performance of other scheduled maintenance is strongly recommended, but is not necessary to keep the emissions-related warranty valid.

Any qualified repair shop or qualified person may maintain, replace, or repair the emission control devices or systems on your snowmobile. Polaris recommends that you contact an authorized Polaris dealer to perform any service that may be necessary.

It is a potential violation of the Clean Air Act if a part supplied by an aftermarket parts manufacturer reduces the effectiveness of the vehicle's emission controls. Tampering with emission controls is prohibited by federal law and may result in civil penalties.



# MAINTENANCE LOG

Present this section of your manual to your dealer each time your snowmobile is serviced. This will provide you and future owners with an accurate log of maintenance and services performed on the snowmobile.

DATE	HOURS	TECHNICIAN	SERVICE PERFORMED / COMMENTS
	50		
	100		
	150		

# MAINTENANCE LOG

DATE	HOURS	TECHNICIAN	SERVICE PERFORMED / COMMENTS

# INDEX

## A

Air Pollution . . . . . 7

## B

Bearings . . . . . 73  
Brake Cable Adjustment . . . . . 56-57  
Brake Lever . . . . . 15  
Brake Lever Travel . . . . . 56  
Break-In Period . . . . . 42

## C

Carburetor . . . . . 55  
Carburetor Jetting . . . . . 81  
Chain Tensioner . . . . . 59  
Choke Knob . . . . . 14  
Choke/Cable Lubrication . . . . . 58  
Component Identification . . . . . 40-41  
Controls and Linkage . . . . . 73  
Customer Service . . . . . 83

## D

Daily Storage . . . . . 46  
Drive-Away from Parked . . . . . 36  
Driveline Lubrication . . . . . 60  
Driving on Hills . . . . . 38  
Driving Responsibly . . . . . 36

## E

Electrical Connections . . . . . 73  
Emergency Preparation . . . . . 78  
Emission Control Information . . . . . 48  
Emissions Limited Warranty . . . . . 92-93  
Engine Break-In . . . . . 42  
Engine Oil . . . . . 61-62  
Engine Starting . . . . . 45  
Engine Stop Switch . . . . . 14  
Environment . . . . . 7-8  
Exhaust System . . . . . 54

## F

Fall Tune-Up . . . . . 78  
Fuel . . . . . 43  
Fuel Lines . . . . . 54  
Fuel Valve . . . . . 54

## G

Gas Cap . . . . . 15

## H

Handlebar Adjustment . . . . . 70  
Hood Hold-Down Strap . . . . . 15

## I

Ice and Hard-Packed Surfaces . . . . . 37  
Ignition Switch . . . . . 15

## K

Know Your Snowmobile . . . . . 14-18

## L

**Lubrication**  
Bearings . . . . . 73  
Controls and Linkage . . . . . 73  
Electrical Connections . . . . . 73  
Lubrication Recommendations . . . . . 72-73

## M

Maintenance . . . . . 49-78  
Maintenance Chart . . . . . 50-51  
Maintenance Log . . . . . 94-95  
Maintenance Program . . . . . 12, 49  
Modifications . . . . . 11

## N

Noise . . . . . 7

## O

Oil Change . . . . . 62  
Oil Level . . . . . 61  
Oil Recommendations . . . . . 61  
Oil, Engine . . . . . 61-62  
Operation . . . . . 43-47  
Operation Warnings . . . . . 29-39

## P

Polaris Products . . . . . 82  
Pre-Ride Check . . . . . 19-20, 25-28  
Pre-Ride Warm-Up . . . . . 47

## R

Recoil Starter . . . . . 14  
Registration, Warranty . . . . . 85  
Riding Rules . . . . . 21-24

# INDEX

## S

Safety Decals . . . . .	13
Safety Symbols . . . . .	10
Signal Words . . . . .	10
Skag Replacement . . . . .	71
Ski Skags . . . . .	71
Slider Replacement . . . . .	68
Snow and Ice Build-Up . . . . .	36
Snow Conditions . . . . .	37
Spark Plug Condition . . . . .	52
Spark Plugs . . . . .	52-53
Speed/Performance Regulation . . . . .	44
Starting the Engine . . . . .	45
Steering Adjustment . . . . .	69
Steering Inspection . . . . .	69
Steering System . . . . .	68
Stop Switch . . . . .	14
Stopping . . . . .	18
Stopping Procedures . . . . .	46
<b>Storage . . . . .</b>	<b>46, 75-77</b>
Engine Fogging . . . . .	75
Stabilize the Fuel . . . . .	76
Storage Area . . . . .	77
Track and Suspension . . . . .	77
Suspension Components . . . . .	72
Suspension Lubrication . . . . .	72

## T

Tether Strap/Switch . . . . .	15
Throttle Cable Lubrication . . . . .	58
Throttle Cable Pivot Slug . . . . .	58
Throttle Lever . . . . .	14
Towing . . . . .	78
Track Alignment . . . . .	65
Track Inspection . . . . .	67
Track Lubrication . . . . .	36, 68
Track Tension . . . . .	63
Track Tension Adjustment . . . . .	64
Transporting the Snowmobile . . . . .	78
Troubleshooting . . . . .	79

## V

Vehicle Identification Numbers . . . . .	9
--	---

## W

Washing the Vehicle . . . . .	74
Waxing the Vehicle . . . . .	74
Windchill . . . . .	39