

Administrator's Guide

for the V500 System



July 2004 Edition
3725-21743-003/A
V500 Version 7.0



Trademark Information

Polycom® and the Polycom logo design are registered trademarks of Polycom, Inc. V500™, Global Management System™, Pro-Motion™, and Siren™ 14 are trademarks of Polycom, Inc. in the United States and various other countries. All other trademarks are the property of their respective owners.

Patent Information

The accompanying product is protected by one or more U.S. and foreign patents and patents pending held by Polycom, Inc. Polycom Siren™ 14 Stereo (patent pending).

© 2004 Polycom, Inc. All rights reserved.

Polycom Inc.
4750 Willow Road
Pleasanton, CA 94588-2708
USA

No part of this document may be reproduced or transmitted in any form or by any means, electronic or mechanical, for any purpose, without the express written permission of Polycom, Inc. Under the law, reproducing includes translating into another language or format.

As between the parties, Polycom, Inc. retains title to, and ownership of, all proprietary rights with respect to the software contained within its products. The software is protected by United States copyright laws and international treaty provision. Therefore, you must treat the software like any other copyrighted material (e.g. a book or sound recording).

Every effort has been made to ensure that the information in this manual is accurate. Polycom, Inc. is not responsible for printing or clerical errors. Information in this document is subject to change without notice.

About this Guide

The *Administrator's Guide for the V500 System* is for administrators of the V500 system who need to:

- Learn about and set up the system hardware
- Configure the system
- Customize the behavior and appearance of the system for easy and efficient use
- Obtain information about calls made by the system, and gather usage and performance data
- Troubleshoot any issues that occur with the system

Other documents available for the V500 system include:

- Setting Up the System*, which describes how to install the hardware
- The *Getting Started Guide*, which describes how to place calls and perform other video calling tasks
- Setup Sheets, which describe how to install optional hardware
- Release Notes

For support or service, please contact your Polycom distributor or go to Polycom Support at www.polycom.com/support.

Polycom recommends that you record the serial number of your V500 system here for future reference. The serial number for the system is printed on the unit.

System Serial Number: _____

Contents

Chapter 1 - Introducing the V500 System

Key Features	1 - 2
Rich Conference Experience	1 - 2
Enhanced User Experience	1 - 2
Easy Installation	1 - 3
Security and Network Management	1 - 3
Standard System Components	1 - 5
Optional System Components	1 - 6

Chapter 2 - Setting Up Your System Hardware

Standard System Set-up	2 - 2
Positioning the System	2 - 2
Connecting the Monitor	2 - 3
Connecting the System to the LAN	2 - 3
Connecting Power	2 - 4
Installing Batteries in the Remote Control	2 - 5
Powering on the System	2 - 5
Optional Equipment Set-up	2 - 6
Connecting to a BRI Network Interface	2 - 6
Connecting Headphones	2 - 6

Chapter 3 - Configuring Network Use

Getting the Network Ready	3 - 2
Network Connectivity Checklist	3 - 2
Configuring with the Setup Wizard	3 - 3
Configuring LAN Properties	3 - 4
Configuring IP Network Support	3 - 6
Specifying H.323 Settings	3 - 6
Configuring the System to Use a Gatekeeper	3 - 7
Configuring the System to Use a Gateway	3 - 8
Specifying SIP Settings	3 - 9
Specifying Quality of Service	3 - 10
Configuring the System for Use with a Firewall or NAT	3 - 11
Configuring ISDN Support	3 - 13
Configuring the BRI Network Interface	3 - 13
Configuring Call Preferences	3 - 14
Configuring the Global Directory	3 - 16
Configuring the Directory Server Settings	3 - 16
Setting the Dialing Rules	3 - 17
Placing a Test Call	3 - 17
Checking System Status	3 - 18
Keeping your Software Current	3 - 19

Chapter 4 - Designing the User Experience

Managing User Access to Settings and Features	4 - 2
Setting the Admin Password	4 - 2
Screens that Require the Admin Password for Access	4 - 3
Letting Users Customize the Workspace	4 - 4
Limiting What Users Can Do With the System	4 - 5
Using the System for Specialized Applications	4 - 5
Designing Video Behaviors	4 - 6
Configuring Camera Settings	4 - 6
Configuring the TV Monitor	4 - 7
Using Dual Monitor Emulation	4 - 8
Adjusting the Monitor's Color Balance	4 - 9
Designing Audio Behaviors	4 - 9
Configuring General Audio Settings	4 - 10
Setting the Volume on an External Audio System	4 - 10
Designing General System Behaviors	4 - 11
Configuring Call Settings	4 - 11
Configuring Remote Control Behavior	4 - 12
Configuring Directory Settings	4 - 12
Setting the Call Answering Mode	4 - 13
Enabling AES Encryption	4 - 13
Setting Passwords and Security Options	4 - 14
Setting Date, Time, and Location	4 - 15
Customizing the Workspace Appearance	4 - 16
Designing the Home Screen	4 - 17
Adding Sites to the Home Screen	4 - 19
Adding On-screen Instructions	4 - 20
Using Marquee Text	4 - 20
Using Screen Saver Text	4 - 20
Changing System Appearance	4 - 21
Setting Ring Tones and Alert Tones	4 - 21
Configuring Closed Captioning	4 - 22
Audio Options for Closed Captioners	4 - 22
Options for Supplying Closed Captions to Conferences	4 - 22
Providing Captions Via the V500 Web Interface	4 - 23
Providing Captions Via a Telnet Session	4 - 24
Getting Started with Calling	4 - 25

Chapter 5 - Managing the System Remotely

Using the V500 Web Interface	5 - 2
Accessing the V500 Web Interface	5 - 2
Managing System Profiles with the V500 Web Interface	5 - 3
Managing Directories with the V500 Web Interface	5 - 4
Configuring Global Services	5 - 5
Viewing the Management Servers List	5 - 5
Requiring an Account Number for Calls	5 - 6
Adding My Information	5 - 6
Requesting Technical Support from the GM S Administrator	5 - 7

Setting Up SNMP	5 - 8
Downloading MIBs	5 - 8
Configuring for SNMP Management	5 - 9

Chapter 6 - System Usage and Statistics

Call Summary	6 - 2
Call Statistics	6 - 3
Call Status	6 - 4
Recent Calls	6 - 5
Call Detail Report	6 - 6
Information in the Call Detail Report	6 - 6
Call Detail Report Archives	6 - 9

Chapter 7 - Diagnostics and General Troubleshooting

Sending a Message	7 - 2
System Screens Quick Reference	7 - 2
Diagnostic Screens	7 - 3
Indicators	7 - 7
System Lights	7 - 7
Network Interface Lights	7 - 7
General Troubleshooting	7 - 8
Critical Problems	7 - 8
Severe Problems	7 - 9
Moderate Issues	7 - 11
Minor Issues	7 - 13
Normal System Behaviors	7 - 16
How to Contact Technical Support	7 - 17
By Telephone	7 - 17
By Internet	7 - 17

Appendix

Cable Descriptions	Appendix - 1
Cable Drawings	Appendix - 2
LAN Cable	Appendix - 2
Composite Video Cable	Appendix - 3
Q.850 Cause Codes	Appendix - 4

Safety and Legal Notices

Index

1

Introducing the V500 System

Your V500 video conferencing system is a state-of-the-art visual collaboration tool. With crisp, clean video and crystal-clear sound, your V500 system provides the essential tools your home or small business needs for video conferencing over broadband networks.



What's in this Chapter?	Page
Key Features	1-2
Standard System Components	1-5
Optional System Components	1-6

Key Features

Rich Conference Experience

- ❑ **Best-in-class video algorithms** — The H.264 video algorithm provides smooth, natural TV-like video.
- ❑ **State-of-the-art audio quality** — The V500 system offers Polycom Siren™ 14, a 14 kHz frequency response that delivers CD-quality sound.
- ❑ **See more with single-monitor systems** — Use Dual Monitor Emulation (split-screen viewing) to see more even when you only have room for one monitor.
- ❑ **Language support** — Use the V500 system user interface, remote control, and web interface in any of twelve languages.

Enhanced User Experience

- ❑ **Customizable home screen** — Customize the home screen to support different types of users:
 - **Novice users** — Offer just a few options, so users need little or no training.
 - **Advanced users** — Provide a wide range of video conferencing features.
- ❑ **Customizable look and feel** — Set up the workspace to suit your environment.
- ❑ **Easy-to-use remote control** — Navigate through the configuration screens and place calls easily using the remote control.
 - **Enter text** — Press the number buttons to enter text using the method commonly used with cell phones.
 - **Color-coded buttons** — Find buttons for related features quickly since they are color coded.
 - **Separate buttons for calling and hanging up** — Call and hang up without confusion even if you have never made a video call before.

- ❑ **Many ways to use the directory** — Find information in the directory using the method you find most convenient.
 - **Assign entries to categories** — Sort your directory by department or category.
 - **Search by name** — Quickly find people by entering the first, middle, or last name.
 - **Find others and let them find you** — Register with the Global Directory Server and make it easy to call other registered systems and just as easy for the other registered systems to call you. The system automatically copies the global directory to your system periodically, so entries are always available.

Easy Installation

- ❑ **Firewall (UPnP™) support** — The V500 system offers support for routers that support UPnP (Universal Plug and Play) NAT traversal, making video conferencing setup easier for users in homes and small offices.
- ❑ **IP or ISDN calling** — The V500 system has a built-in 10/100 Mb Ethernet port for IP calls. Add the optional single BRI network interface to make calls over your ISDN telephone lines.
- ❑ **Easy configuration wizard** — The system setup wizard detects your network connections and guides you through configuring the system to work on an IP network or ISDN.
- ❑ **Fully broadband capable** — The standards-compliant V500 system works with any other H.323 system.
- ❑ **Auto-sensing power supply** — The system automatically adjusts for line voltages from 90 to 260 V and line frequencies from 47 to 63 Hz.

Security and Network Management







- ❑ **Use AES encryption** — Enable the integrated AES encryption to automatically encrypt calls to other AES-capable systems, without external encryption equipment.
- ❑ **Remote access** — Configure, manage, and monitor the system from a remote computer using the V500 web interface (the system's web interface), the Polycom Global Management™ System, or SNMP. Alternatively, you can choose not to allow remote management.
- ❑ **Secure system management** — The local administrator's password on the system prevents others from changing system configuration while allowing you to manage the system.

- ❑ **Call Detail Reports** — Access the system's call history from the V500 web interface. You can download the data to a spreadsheet application for sorting and formatting.
- ❑ **Remote diagnostics** — Tools in the V500 web interface allow you to identify and correct issues that affect the video conferencing experience.
- ❑ **SNMP reporting** — The V500 system sends SNMP reports to indicate a total of 31 conditions.

Standard System Components

This section describes the standard components that come with the V500 system.

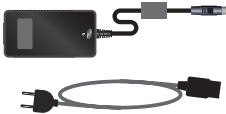
Two models of the V500 system are available — IP only, and IP with ISDN.

Name	Component	Description
V500 System		The V500 system delivers high-quality, face-to-face video communication in a sleek package that includes the camera and microphone.
Remote Control		The remote control is designed to make it easy to set up and operate the system — color-coded buttons correspond to system features.
Composite video cable		The composite video cable is a triple RCA cable with S-video that connects the V500 system to a monitor.
LAN cable		The LAN cable connects the system to the IP network.
BRI cable (IP with ISDN model only)		The BRI cable connects the system to the ISDN.
Power supply		The power supply connects power to the system.
Documentation		Read Me First <i>Setting Up the V500 System</i> V500 system documentation CD

Optional System Components

To extend what you do with your V500 system, the following additional options are available. For information about ordering these options, please see your Polycom distributor.

- Single BRI network interface** — Connect the system to use ISDN.
- Headphone** — Listen privately by adding your own headphone using the 3.5 mm stereo mini jack.

2

Setting Up Your System Hardware

This chapter describes how to set up your system with the required components and optional equipment. If you need additional installation information, refer to the system setup document that was provided with your system.

For optional components, you can also refer to the setup sheet that was shipped with the component.

To obtain additional copies of any of these documents, refer to the documentation CD that came with the system or go to the Polycom web site, www.polycom.com/videodocumentation.

What's in this Chapter?	Page
Standard System Set-up	2-2
Optional Equipment Set-up	2-6

Standard System Set-up

This section describes how to connect the components that are required for the basic system set-up. Procedures for connecting additional equipment are in the next section, [Optional Equipment Set-up on page 2-6](#).

Positioning the System

The V500 system is designed for homes, home offices, or small offices.

To position the system:

- >> Place the system on top of your monitor. For optimal audio and video performance, locate the monitor within 5 to 10 feet (1.52 to 3.05 meters) away from the people in the call.

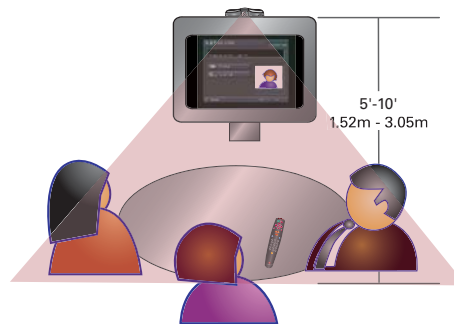

Connecting the Monitor

You must connect a television monitor to the V500 system. This may be an NTSC or PAL monitor, depending on your system.



To connect a monitor to the system:

1. Connect the monitor to the S-video or composite video outputs on the back of the V500 system.

You must use the same type of connector on the monitor as on the system. For example, if you use the S-video connector on the monitor, use the S-video connector on the system.

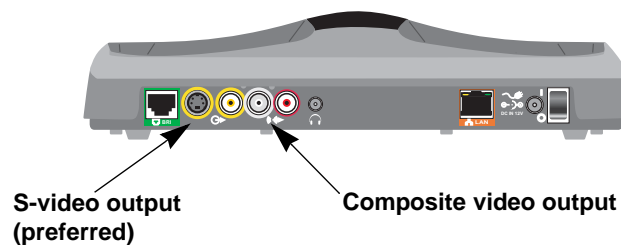

S-video provides superior video quality, and is recommended.

2. Connect the system's audio outputs to the monitor's audio inputs using the red and white connectors on the monitor cable.



After you have finished setting up the system, you will need to configure the monitor's behavior. Refer to [Configuring the TV Monitor on page 4-7](#).

Connecting the System to the LAN

The steps you need to take to connect to the LAN depend on your network environment. For example, you may have a small office with multiple PCs, a broadband modem, and a router; you may have a broadband modem and one PC in your home; or, you may have another type of network environment altogether.

In all cases, you must first connect the LAN to the system with the LAN cable. If you have a router, gateway, or broadband modem, you must also open the ports used by the V500 system to access the Internet. Once you have done these, refer to the section that pertains to your environment.



To connect the system to the LAN:

1. Connect the LAN cable to the LAN connector on the back of the system.

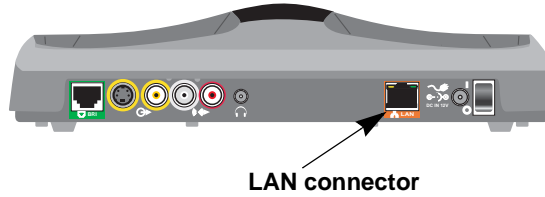

2. Connect the other end of the LAN cable to the LAN.



After you have finished setting up the system, you will need to configure it to work properly in your network. Refer to [Configuring Network Use on page 3-1](#).

Connecting Power

The V500 system has an external power supply.



Do not use a power supply other than the one supplied with your V500 system. Using the wrong power supply will void the warranty and may damage your system.



To connect power to the system:

1. Connect the power supply to the power connector on the back of the system.

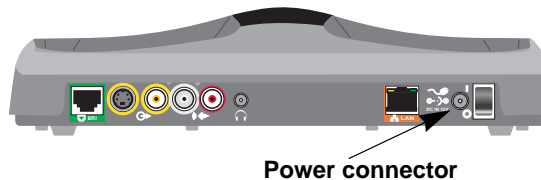

2. Connect the power cord to the power supply.



Do not connect the V500 system power cord to a wall outlet until you have connected all equipment to the system.

Installing Batteries in the Remote Control

The remote control uses three AAA batteries, which are included with the system.



To install batteries in the remote control:

1. Remove the battery cover from the back of the remote control.
2. Refer to the diagram inside the remote control, and install the batteries in the orientation shown.
3. Reinstall the battery cover on the remote control.

Powering on the System

After you have connected all your standard and optional equipment, plug the power cord into a wall outlet.

To power on the system:

- >> Press the power switch located at the back of the system.

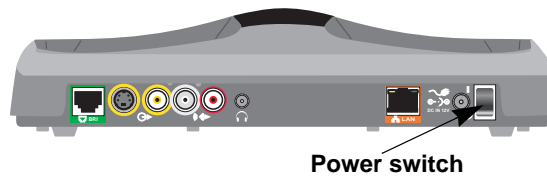

Optional Equipment Set-up

This section describes how to connect optional components to the V500 system.

Connecting to a BRI Network Interface

The V500 system is available with the optional BRI network interface, which allows you to make ISDN calls.

You may need an NT-1 device if your site does not use an internal telephone system (PBX). A PBX or an NT-1 device provides the S/T interface that the system's BRI network interface requires.



To install the BRI network interface:

1. Make sure the system is powered off.
2. Connect the BRI cable from the BRI connector on the back of the system to ISDN or to your NT-1 device, as appropriate.

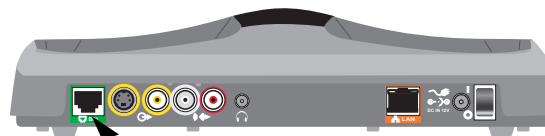

BRI connector

3. If you are using an NT-1 device, connect it to the ISDN.

Connecting Headphones

You can connect headphones to the V500 system to listen to your calls privately.

To connect headphones to the system:

- >> Connect the headphone cable to the headphone jack on the back of the system.

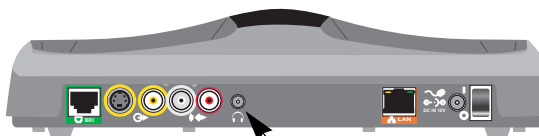

Headphone jack

3

Configuring Network Use

This chapter lists the information you need to get your network ready for video conferencing. Once you've gathered that information, you can begin configuring the system's network options. Details on how to perform this configuration are also included in this chapter.

When you power on your system for the first time, the setup wizard detects the system's IP and ISDN connections and leads you through the minimum configuration steps required to place a call.

If you need to change any of the initial settings to accommodate your environment, you can manually adjust them using the screens described in this chapter.

Note that if you establish an administrator's password during the setup wizard, you will need to enter it each time you wish to change advanced settings.

What's in this Chapter?	Page
Getting the Network Ready	3-2
Network Connectivity Checklist	3-2
Configuring with the Setup Wizard	3-3
Configuring LAN Properties	3-4
Configuring IP Network Support	3-6
Configuring ISDN Support	3-13
Configuring Call Preferences	3-14
Configuring the Global Directory	3-16
Placing a Test Call	3-17
Checking System Status	3-18
Keeping your Software Current	3-19

Getting the Network Ready

Before you begin configuring the network options, you must make sure your network is ready for video conferencing.

To begin, refer to the *Preparing Your Network for Collaboration* document, available at www.polycom.com/videodocumentation. This document contains information you need to prepare your network, such as worksheets that will help you order ISDN.

Network Connectivity Checklist

You may need this information to make and receive video calls at your site:

If:	This information:	Should be provided by your:
Your system is using a static IP address	IP address	IP Network Service Provider
Your network uses a gatekeeper	Gatekeeper address	IP Network Service Provider
Your system is behind a firewall	Firewall information	IP Network Service Provider
You are using BRI	ISDN address	ISDN Service Provider
You are using ISDN and are in North America	SPIDs	ISDN Service Provider
You are using ISDN	ISDN switch protocols	ISDN Service Provider

Configuring with the Setup Wizard

When you power on your system for the first time, the setup wizard detects the system's IP and ISDN connections and leads you through the minimum configuration steps required to place a call. If you need more information about these steps, refer to the corresponding sections in this chapter.

The setup wizard enables you to set an administrator password, which allows you to limit access to the Admin Settings. The administrator password may contain letters and numbers, but no other characters.



The default administrator password is the system's serial number. If you change the password, make sure you remember it. If you forget the password, you will have to reset the system, delete the system files, and run the setup wizard again in order to access the Admin Settings and reset the password. You cannot set the administrator password from a remote location.

You can run the setup wizard or view the configuration screens in either of these two ways.

- In the room with the system** — Use the remote control to navigate the screens and enter information. You can use the number pad on the remote control to enter text just like you can with a cell phone.
- From a remote location** — Use a web browser to access the V500 web interface. To do this, you need to know the IP address of the system. Polycom recommends using Microsoft® Internet Explorer 6.0 or later.



You can use the web interface to configure all of the system settings except the remote management settings, which must be configured on the local system.

To access the system via the V500 web interface:

1. On a PC, open a web browser.
2. In the browser address line, enter the IP address of the system (for example, `http://255.255.255.255`) to go to the V500 web interface.
3. Enter your user name and the password, if a password has been established.

Configuring LAN Properties

If your system is part of a LAN, use this section to configure the system to work with the LAN.

Before you Begin

If you are connecting the system via a modem, you need to request an additional public IP address from your Internet service provider.

Your service provider will provide you with one of these IP addresses:

- Static IP address** – The address is reserved for your system and will not change. When you configure the LAN properties of the system, choose the **Enter IP Address Manually** option.
Your service provider should also provide you with the DNS server address, default gateway address, subnet mask, and WINS server IP address.
- Dynamic IP address** – The address is obtained from your service provider's DHCP server, and therefore may change. When you configure the LAN properties of the system, choose the **Obtain IP Address Automatically** option.

To configure LAN properties:

1. Go to **System > Admin Settings > LAN Properties**.
2. Configure these settings:

Setting	Description
Connect to my LAN	Specifies whether the system is part of the LAN.
Allow IP Calls	Enables the system to make and receive IP calls.
Host Name	Indicates the system's DNS name. If you change the Host Name, the system restarts.
IP Address	Specifies how the system obtains an IP address. <ul style="list-style-type: none"> • Obtain IP Address Automatically — Select if the system gets an IP address from the DHCP server on the LAN. • Enter IP Address Manually — Select if the IP address will not be assigned automatically.
Your IP Address is or Use the Following IP Address	If the system obtains its IP address automatically, this area displays the IP address currently assigned to the system. If you selected Enter IP Address Manually , enter the IP address here.

Setting	Description
Domain Name	Displays the domain name currently assigned to the system. If the system does not automatically obtain a domain name, enter one here.
DNS Servers	Displays the DNS servers currently assigned to the system. If the system does not automatically obtain a DNS server address, enter up to four DNS servers here.
Default Gateway	Displays the gateway currently assigned to the system. If the system does not automatically obtain a gateway IP address, enter one here.
Subnet Mask	Displays the subnet mask currently assigned to the system. If the system does not automatically obtain a subnet mask, enter one here.
WINS Server	Displays the WINS server currently assigned to the system. If the system does not automatically obtain a WINS server IP address, enter one here.
WINS Resolution	Sends a request to the WINS server for WINS name resolution.
LAN Speed	Specify the LAN speed to use. Note that the speed you choose must be supported by the switch. Choose Auto to have the network switch negotiate the speed automatically. If you choose 10 Mbps or 100 Mbps , you must also select a duplex mode.
Duplex Mode	Specify the Duplex mode to use. Note that the Duplex mode you choose must be supported by the switch. Choose Auto to have the network switch negotiate the Duplex mode automatically.

Configuring IP Network Support

Use the following sections to configure the system so that you can place and receive video calls using IP on your LAN or WAN:

- H.323 Settings, including Gatekeeper and Gateway
- SIP Settings
- Quality of Service
- Firewall or NAT

Specifying H.323 Settings

If your network uses a gatekeeper, the system can automatically register its H.323 name and extension. This allows others to call the system by entering the H.323 name or extension instead of the IP address.

To specify H.323 settings:

1. Go to **System > Admin Settings > Network > IP > H.323 Settings**.
2. Configure these settings:

Setting	Description
Enable IP H.323	Specifies whether to allow IP dialing.
Display H.323 Extension	Lets you place a gateway call by entering the H.323 extension separately from the gateway ID. If you do not check this box, you can make gateway calls by entering the call information in this format: gateway ID + TCS4 delimiter + extension Check with your network provider to determine your TCS4 delimiter.
H.323 Name	Specifies the name that gatekeepers and gateways use to identify this system. You can make point-to-point calls using H.323 names if both systems are registered to a gatekeeper. The H.323 Name is the same as the System Name, unless you change it. Your dial plan may define the names you can use.
H.323 Extension (E.164)	Lets you place point-to-point calls using the extension if both systems are registered with a gatekeeper. The default H.323 Extension is based on the system serial number, but it can be changed. Your dial plan may define the extensions you can use.

Configuring the System to Use a Gatekeeper

A gatekeeper supervises network traffic and manages functions such as bandwidth control and admission control. The gatekeeper also handles address translation, which allows you to make calls using static aliases instead of IP addresses that may change each day.

To configure the system to use a gatekeeper:

1. Go to **System > Admin Settings > Network > IP > H.323 Settings**.
2. Select  and configure these settings:

Setting	Description
Use Gatekeeper	Specifies whether to use a gatekeeper. Gateways and gatekeepers are required for calls between ISDN and IP networks. <ul style="list-style-type: none"> • Off — Calls do not use a gatekeeper. • Auto — System automatically finds an available gatekeeper. • Specify — Calls use the specified gatekeeper. Enter the gatekeeper's IP address or name (for example, gatekeeper.companyname.usa.com or 255.255.255.255).
H.323 Name	Specifies the name that gatekeepers and gateways use to identify this system. You can make point-to-point calls using H.323 names if both systems are registered to a gatekeeper. The H.323 Name is the same as the System Name, unless you change it. Your dial plan may define the names you can use.
H.323 Extension (E.164)	Lets you place point-to-point calls using the extension if both systems are registered with a gatekeeper. The default H.323 Extension is based on the system serial number, but it can be changed. Your dial plan may define the extensions you can use.
Outbound Call Route	For systems using a gatekeeper, specifies whether calls initiated by this system should be handled as IP calls sent through a gateway or as ISDN.
Gatekeeper IP Address	If you chose to use an automatically selected gatekeeper, this area displays the gatekeeper's IP address. If you chose to specify a gatekeeper, enter the IP address here.
Alternate Gatekeepers	If you chose to specify a gatekeeper, you can specify other gatekeepers that the system can use if the primary gatekeeper is not available.

Configuring the System to Use a Gateway

A gateway performs code and protocol conversion between IP networks and ISDN, so that users on different networks can call one another. If the system is configured to use a gateway, you must also configure it to use a gatekeeper.

To configure the system to use a gateway:

1. Go to **System > Admin Settings > Network > IP > H.323 Settings**.
2. Select  twice and configure these settings:

Setting	Description
Country Code	Specifies the country code for the system's location.
Area Code	Specifies the area or city code for the system's location.
Number	Specifies the gateway's number.
H.323 Extension (E.164)	Lets you place point-to-point calls using the extension if both systems are registered with a gatekeeper. The default H.323 Extension is based on the system serial number, but it can be changed.
Gateway Number Type	Specifies the number type users enter to call this system: <ul style="list-style-type: none"> • Direct Inward Dial (DID) — Users enter an internal extension to call this system directly. NOTE: If you choose this option, you must also register the number with the gatekeeper as an E.164 alias. • Number + Extension — Users enter the gateway number and the system's extension to call this system.
Number of Digits in DID Number	Specifies the number of digits in the DID number. The national or regional dialing plan for your location determines the standard number of digits. For instance, the US standard is 7 digits.
Number of Digits in Extension	Specifies the number of digits in the extension used when Number + Extension is selected. Your organization's dial plan determines this number.

3. Select  and enter a prefix or suffix for each bandwidth you want to allow for gateway calls.



Be sure to configure the gateway to use the same prefixes and suffixes you define for the system.

Specifying SIP Settings

If your network supports the Session Initiation Protocol (SIP), you can use SIP to connect IP calls.

To specify SIP Settings:

1. Go to **System > Admin Settings > Network > IP > SIP Settings**.
2. Configure these settings:

Setting	Description
Enable SIP	Allows the system to make calls using SIP.
Transport Protocol	Indicates the protocol the system uses for SIP signalling. The SIP network infrastructure in which your V500 system is operating determines which protocol is required. For example, if your V500 system is operating in a Microsoft Live Communication Server (LCS) SIP network, choose TCP . If your V500 system is operating in a Nortel Multimedia Communication Server (MCS) SIP network, choose UDP .
Password	Specifies the password that authenticates the system to the Registrar Server.
User Name	Specifies the system's SIP name. If you leave this field blank, the system's IP address is the SIP user name.
Proxy Server	Specifies the DNS name or IP address of the SIP Proxy Server. If you leave this field blank, no proxy server is used. By default, the SIP signalling is sent to port 5060 on the proxy server. To specify a different port, add it to the address as shown here: 255.255.255.255:5070
Registrar Server	Specifies the name or IP address of the SIP Registrar Server. By default, the SIP signalling is sent to port 5060 on the registrar server. To specify a different port, add it to the address as shown here: 255.255.255.255:5070

Specifying Quality of Service

Set the Quality of Service options for the way your network handles IP packets during video calls.

To specify Quality of Service:

1. Go to **System > Admin Settings > Network > IP > Quality of Service**.
2. Configure these settings:

Setting	Description
Type of Service	Specifies your service type and lets you choose how to set the priority of IP packets sent to the system for video, audio, and far-end camera control: <ul style="list-style-type: none"> • IP Precedence — Represents the priority of IP packets sent to the system. The value can be between 0 and 5. If this option is selected, enter the value in the Type of Service Value field. • DiffServ — Represents a priority level between 0 and 63. If this option is selected, enter the value in the Type of Service Value field.
Type of Service Value	Specifies the IP Precedence or Diffserv value for Video, Audio, and Far-End Camera Control.
Enable PVEC	Allows the system to use PVEC (Polycom Video Error Concealment) if packet loss occurs.
Dynamic Bandwidth	Specifies whether to let the system automatically find the optimum line speed for a call.
Maximum Transmit Bandwidth	Specifies the maximum transmit line speed between 48 Kbps and 512 Kbps.
Maximum Receive Bandwidth	Specifies the maximum receive line speed between 48 Kbps and 512 Kbps.



If the system is connected to the Internet via DSL or a cable modem, it is useful to set maximums for transmitting and receiving bandwidth. DSL and cable modems typically allow for faster download (receive) speeds compared to upload (transmit) speeds, and so these settings provide an opportunity to regulate differences.

Configuring the System for Use with a Firewall or NAT

A firewall protects your network by controlling data traffic from outside the network. Unless the firewall is designed to work with H.323 video conferencing equipment, you must configure the system and the firewall to allow video conferencing traffic to pass in and out of the network.

Network Address Translation (NAT) network environments use private internal IP addresses for devices within the network, while using one external IP address to allow devices on the LAN to communicate with other devices outside the LAN. If your system is connected to a LAN that uses a NAT, you will need to enter the NAT public (WAN) address so that your system can communicate outside the LAN.

To set up the system to work with a firewall or NAT:

1. Go to **System > Admin Settings > Network > IP > Firewall**.
2. Configure these settings:

Setting	Description
Fixed Ports	<p>Lets you specify whether to define the TCP and UDP ports.</p> <ul style="list-style-type: none"> • If the firewall is not H.323 compatible, enable this option. The V500 system assigns a range of ports starting with the TCP and UDP ports you specify. The system defaults to a range beginning with port 3230 for both TCP and UDP. <p>NOTE: You must open the corresponding ports in the firewall. You must also open the firewall's TCP port 1720 to allow H.323 traffic.</p> <ul style="list-style-type: none"> • If the firewall is H.323 compatible or if the system is not behind a firewall, disable this option.
TCP Ports UDP Ports	<p>Lets you specify the beginning value for the range of TCP and UDP ports used by the system.</p> <p>NOTE: You must also open the firewall's TCP port 1720 to allow H.323 traffic.</p>

Setting	Description
NAT Configuration	<p>Lets you specify whether the system should determine the NAT Public WAN Address automatically.</p> <ul style="list-style-type: none"> If the system is behind a NAT that allows HTTP traffic, select Auto. If the system is behind a NAT that does not allow HTTP traffic, select Manual. If the system is not behind a NAT or is connected to the IP network through a Virtual Private Network (VPN), select Off. If the system is behind a firewalled NAT router that is UPnP™ (Universal Plug and Play) certified, select UPnP. <p>Many routers used in homes and small businesses support UPnP NAT traversal. If this is your situation, try selecting UPnP first. If this selection does not work for your router, select Auto or Manual.</p>
NAT Public (WAN) Address	Displays the address that callers from outside the LAN use to call your system. If you chose to configure the NAT manually, enter the NAT Public Address here.
NAT is H.323 Compatible	Specifies that the system is behind a NAT that allows HTTP traffic.
Address Displayed in Global Directory	Lets you choose whether to display this system's public or private address in the Global Directory.

Configure the V500 system for specific products as follows:

If you use this type of NAT or firewall:	Configure your V500 system this way:		
	Use Fixed Ports	System is Behind a NAT	NAT is H.323 Compatible
Cisco® PIX® NOTE: Do not select the Fix Up H.323 feature.	Yes	Yes	No
Cisco® Router NAT	No	No	No
Linksys®	Yes	Setting is ignored	No
Netgear®	No	No	Yes
SMC® Barricade™	Yes	Yes	No



Systems deployed outside a firewall are potentially vulnerable to unauthorized access. Visit the Polycom Security Center at www.polycom.com for timely security information. You can also register to receive periodic email updates and advisories.

Configuring ISDN Support

The V500 system supports the BRI network interface for ISDN calling.

The system automatically detects the type of interface installed and displays only the required configuration screens.

Configuring the BRI Network Interface

To configure the ISDN interface settings:

1. Go to **System > Admin Settings > Network > ISDN**.
2. Configure these settings:

Setting	Description
Enable ISDN H.320	Allows this system to make H.320 (ISDN) calls.
Outside Line Dialing Prefix	Specifies the ISDN dialing prefix used to call outside the network.
ISDN Switch Protocols	Specifies the protocol used by your network's switch.
ISDN Voice Algorithm	Specifies which voice algorithm (Alaw or uLaw) is used for ISDN voice calls. Do not change this setting unless you experience audio issues in all ISDN voice calls.
Auto BRI Configuration	Allows the NI-1 switch to automatically configure the directory numbers and SPIDs. This setting is only available if you have selected the NI-1 switch protocol.

3. Select  and configure these settings:

Setting	Description
Area Code	Specifies the area code for this system's location.
Directory Numbers	Specifies the numbers assigned to the B1 and B2 channels for the BRI line. The two numbers for a line may be the same or different, depending on the switch protocol in use.
Enable	Specifies whether to enable the ISDN line. If you selected the Standard ETSI Euro ISDN protocol, you must enable the BRI line.

The ISDN BRI Numbers screen also displays the country selected as the system's location and the Country Code used for international calls to the system. To specify the system's location, go to **System > Admin Settings > General Settings > Location**. The system automatically supplies the country code when you specify the country.

4. If you have configured the ISDN switch protocol to be AT&T 5ESS Multipoint, NI-1, or Nortel DMS-100, select  and enter the ISDN BRI SPIDs provided by your service provider.

After you enter the SPIDs, the system verifies them. If the system is unable to verify the SPIDs, make sure the system is connected and that the ISDN numbers you entered are correct.

If you do not have the SPIDs from your service provider, you can click **Start** to Auto-Detect SPIDs.

Configuring Call Preferences

Call preferences help you manage the network bandwidth used for calls. You can specify the default and optional call settings for outgoing calls. You can also limit the call speeds of incoming calls.

To choose call preferences:

1. Go to **System > Admin Settings > Network > Call Preference**.

2. Configure these settings:

Setting	Description
Enable H.329	Specifies standards-based People + Content data collaboration.
Enable IP H.323	Allows the system to make IP calls.
Enable SIP	Allows the system to use SIP when connecting IP calls.
Enable ISDN H.320	Allows the system to make ISDN calls.
Enable Voice Over ISDN	Allows the system to make voice-only calls to phones connected to an ISDN network, such as an organization's PBX.

3. Select  to go to the **Network Dialing** screen and specify the dialing order preference between IP and ISDN.

If the sites in your directory have both IP and ISDN numbers, these settings determine your network preferences for placing the call.

4. Select  to go to the **Preferred Speeds** screens and configure these settings:

Setting	Description
Preferred Speed for Placing Calls	<p>Determines the speeds that will be used for calls from this system when:</p> <ul style="list-style-type: none"> • Call Quality is set to Auto on the home screen and Directory screen • The Call Quality option is not available for users <p>If the far-end system does not support this quality, the system automatically negotiates a lower quality.</p>
Maximum Speed for Receiving Calls	<p>Allows you to restrict the bandwidth used when receiving calls.</p> <p>If the far site attempts to call the system at a higher speed than selected here, the call is re-negotiated at the speed specified in this field.</p>

5. Select  to go to the **Call Speeds** screen and specify the call speeds to make available to users, if you are allowing them to choose speeds on a call-by-call basis.

Configuring the Global Directory

If you use the Polycom Global Management System, you can configure your system to use the Global Directory. The Global Directory provides a list of other systems that are registered with the Global Directory Server and are available for calls. The other systems appear in the Directory, allowing you to place calls to other users by selecting their names.

Configuring the Directory Server Settings

To configure the Directory Server settings:

1. Go to **System > Admin Settings > Global Services > Directory Servers**.
2. Configure these settings:

Setting	Description
Global Directory (GDS)	Specifies the IP address or DNS address of the Global Directory Server. You can enter up to five addresses.
Register	Registers this system with the Global Directory Server.
Password	Lets you enter the Global Directory password, if there is one.
Display Global Addresses	Displays other registered systems in the Global Directory.
Display Name in Global Directory	Specifies whether to display the system's name in the Global Directories of other registered systems.
Save Global Directory to System	Copies the Global Directory to this local system.

Setting the Dialing Rules

If your system is connected to a private network and also to a public network, you may need to specify the codes and prefixes necessary for dialing other systems.

To set the dialing rules:



1. Go to **System > Admin Settings > Global Services > Dialing Rules**.
2. Configure these settings:

Setting	Description
Always Dial Area Code	Specifies that calls to sites in the same area code must include the area code.
Dial 1+ for all USA calls	Specifies that calls to systems in the United States must include a "1" before the area code.

Placing a Test Call

When you finish configuring the system, you can use one of the sample numbers in the directory to test your setup.

To place a test call:

1. On the Place a Call screen, select .
2. Select **Category**.
3. Select **Sample Sites** and highlight a location.
4. Press  on the remote control.



You can also find a list of worldwide numbers that you can use to test your V500 system at www.polycom.com/videtest.

If you have trouble making video calls:

- Make sure the number you dialed is correct, then try the call again. For example, you may need to dial 9 for an outside line or include a long distance access code or country code.
- To find out if the problem exists in your system, ask the person you were trying to reach to call you instead.
- Find out if the system you are calling has its power turned on and is functioning properly.
- If you can make calls but not receive them, make sure that your system is configured with the correct number.

Checking System Status

The System Status screen provides detailed information about system settings, IP and ISDN connections, time server connections, and other information that is important to the functioning of the system. For an explanation of any of the status items, select the item and press  on the remote.

When there is a change in system status or a potential problem, you see an alert at the bottom of the Place a Call screen.

To view System Status information:

>> Go to **System > Diagnostics > System Status**.

To get information about a status message:

>> Select the status message and press  or  on the remote control.

Keeping your Software Current

If you have Internet access, you can use the web-based Softupdate application to upgrade the system software. If you do not have Internet access, your reseller can supply you with the updated software on CD-ROM.



Before you begin, read the *Release Notes*, available at www.polycom.com/videosoftware, for the latest information about this software version.

To upgrade your software via the Internet:

1. From your PC, go to www.polycom.com/videosoftware.
2. Log in to the Polycom Product Resource Center, find your product page, and download the software update file in .zip format.
3. Double-click the software.zip file to extract the file.
4. Double-click **Softupdate.exe**.
5. Click **Softupdate**, then enter the IP address of the system you want to update. Enter the administrator password, if required, and click **OK** to begin the upgrade.
6. On the Options tab of the Softupdate application, select the other actions you want to occur during the update:
 - **Remove Address Book** — Check this option to delete your existing directory before the update.
 - **Remove System Files** — Check this option to delete your existing system files before installing new system files.
7. Click **Continue** to upgrade the software.



Caution

Do not power off the system during the software upgrade process. If the upgrade is interrupted, the system reverts to its original software version.

4

Designing the User Experience

Everybody who uses the Polycom V500 system has different needs. That's why your system has a customizable user interface. You can design the video conferencing experience to meet your needs and the needs of any other users who use the system.

You can customize the behavior of the system, and then build in various access levels for the different users, depending on how much or how little you want them to change system behaviors.

When you set up the system for the first time, the system is configured with the most commonly used settings. If you need to change any of these initial settings, you can adjust the screen settings as described in this chapter.

If you established an administrator's password during the initial configuration, you must enter it each time you change advanced settings.

What's in this Chapter?	Page
Managing User Access to Settings and Features	4-2
Designing Video Behaviors	4-6
Designing General System Behaviors	4-11
Customizing the Workspace Appearance	4-16
Configuring Closed Captioning	4-22
Getting Started with Calling	4-25

Managing User Access to Settings and Features

You can manage access to various settings and features by using passwords and by configuring the system to show only those options you want other users to see.

To maintain this security level:	You can allow users to:
High (Kiosk mode)	Call only the numbers you specify on the home screen. See Using the System for Specialized Applications on page 4-5 and Designing the Home Screen on page 4-17 .
Medium	Place calls using the restrictions you specify for length of call, type of call, and use of the directory. See Limiting What Users Can Do With the System on page 4-5 .
Low	Configure user settings. See Letting Users Customize the Workspace on page 4-4 .
Very low	Configure all system settings.

Setting the Admin Password

Set an administrator's password to restrict who can:

- Make changes other than those in the User Settings screen
- Update the software
- Perform remote management using the V500 web interface

To set or change the Admin Password:

1. Go to **System > Admin Settings > General Settings > Security**.
2. Enter or change the password. You may use letters and numbers, but no other characters.

To reset a forgotten Admin Password:

1. Get the system’s serial number from the system or from the System Information screen.
2. Go to **System >Diagnostics > Reset System**.
3. Enter the system’s serial number and select **Delete System Settings**.
4. Select **Reset System**.

When the system completes the reset, it leads you through the setup wizard. You can enter a new Admin Password when you set up the system.

Screens that Require the Admin Password for Access

The following diagram shows top-level system screens. All screens within Admin Settings require the administrator’s password.

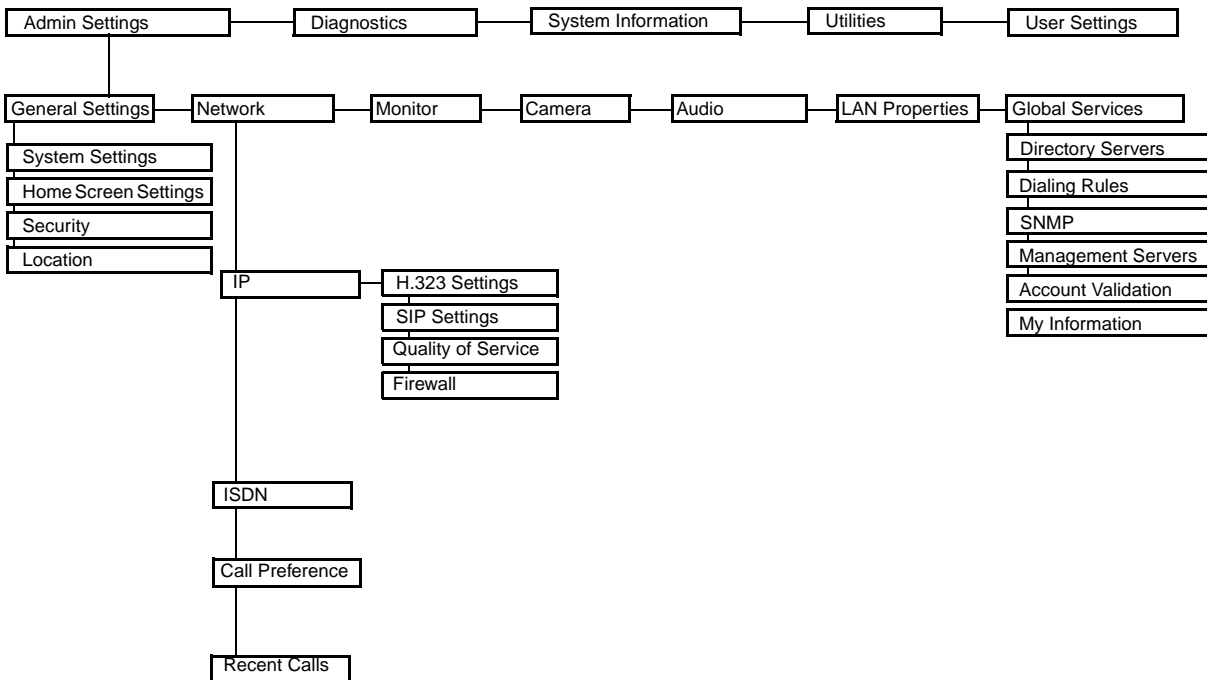

Letting Users Customize the Workspace

You can allow other users of the V500 system to change common user preferences by providing access to the User Settings screen.

To allow users to customize the workspace:

1. Go to **System > Admin Settings > General Settings > Security**.
2. Check the **Allow Access to User Settings** option to make the **User Settings** button available to users on the System screen.

User Settings contains the following options:

- Backlight Compensation
- Camera Brightness
- Meeting Password
- Auto-Answer Point to Point
- Mute Auto-Answer Calls
- PIP
- Keypad Audio Confirmation
- Color Scheme
- Far Site Name Display Time
- Dual Monitor Emulation
- Allow Video Display on Web



These options are also available to the administrator on the Admin Settings screens.

Limiting What Users Can Do With the System

You can limit what you allow other users to do with the system by configuring the following:

- Maximum Time in Call** — If you want to specify the maximum time a call can last, go to **System > Admin Settings > General Settings > System Settings > Call Settings** and enter the maximum call length allowed.
- Allow Directory Changes** — If you do not want anyone to save changes to the local directory of the system, go to **System > Admin Settings > General Settings > System Settings > Directory** and clear this option.

Using the System for Specialized Applications

You can customize the system to show only a specific set of numbers to call. This mode, also known as “kiosk mode,” can be used for specialized applications, such as customer query stations or systems used for calling the same numbers on a regular basis. Kiosk mode requires little or no training and instructions can be incorporated into the screen design.

See [Designing the Home Screen on page 4-17](#) for more details about the kiosk mode and its applications.

Designing Video Behaviors

You can configure the following video behaviors to accommodate your environment:

- Camera Settings
- TV Monitor
- Dual Monitor Emulation
- Monitor's Color Balance

Configuring Camera Settings

The Camera screen lets you specify camera settings.

To configure camera settings:

1. Go to **System > Admin Settings > Camera**.
2. Configure these settings:

Setting	Description
Backlight Compensation	Specifies whether to have the camera automatically adjust for a light background. Backlight compensation is best used in situations where the subject appears darker than the background.
Camera Brightness	Specifies how much light is let into the camera's iris. A low number allows in less light; a high number allows in more light.

Configuring the TV Monitor

The V500 system allows you to customize the display to suit your room and equipment configuration.

To configure the TV monitor:

1. Go to **System > Admin Settings > Monitor**.
2. Configure these settings:

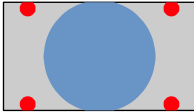
Setting	Description
Monitor	<p>Specifies the monitor's aspect ratio:</p> <ul style="list-style-type: none"> • 4:3 — Select if you are using a regular TV monitor. • 16:9 — Select if you are using a wide screen monitor and configuring for dual-monitor emulation. <p>You can set a wide-screen monitor to 16:9 to resize the UI screens even if you do not configure it for dual-monitor emulation. The far-site video is displayed in the same way for both settings.</p> <p>NOTE: If you select 16:9, you will also need to set up the monitor for full-screen display. In the monitor's setup menu, choose the setting that stretches the picture uniformly without clipping the edges.</p> <p>Use this setting:  Not this setting: </p>
PIP	<p>Specifies PIP (Picture-in-Picture) behavior:</p> <ul style="list-style-type: none"> • On — The PIP window stays on for the duration of the call. • Off — The PIP window is not displayed during the call. • Auto — The PIP window is displayed when a user picks up the remote. <p>NOTE: PIP settings are also available in the User Settings screen. Users can turn the PIP on or off and change its location on the screen using the PIP button on the remote control.</p>
Display Icons in a Call	Specifies whether to display all on-screen graphics, including icons and help text, during calls.
Snapshot Timeout	<p>Lets you choose whether to have snapshots time out after a period of four minutes, after which the system returns to live video.</p> <p>If you want to return to live video before four minutes have elapsed, press the Near button on the remote control twice.</p>
Dual Monitor Emulation	Specifies whether both sites are displayed in a split-screen mode when using one monitor.

Using Dual Monitor Emulation

With Dual Monitor Emulation, you see both near and far sites on one monitor in two different views. During presentations, you see content *and* the near and far sites.

Setting Up

On the monitor's setup menu, select the full-screen setting that stretches the picture uniformly, without clipping.

On the TV Monitor screen:

1. If you are using a wide screen monitor, set Monitor to **16:9**.
Otherwise, set Monitor to **4:3**.
2. Select **Dual Monitor Emulation**.

Using in a Call

Call connects

Near and far site are the same size and appear side by side.



Far site Near site

Near site presses PIP

Size of far site window increases.



Far site presents to near site

Content, near site, and far site are displayed in dual monitor emulation mode.



Adjusting the Monitor's Color Balance

In most cases, the monitor you connect to your system provides natural color without any adjustment. Depending on your environment as well as the model of monitor, however, the video may exhibit one of these problems:

- Picture is too dark
- Colors appear faded
- Picture has too much of one color — for example, the picture may appear greenish

If you notice any of these, the monitor needs to be adjusted.

To adjust the monitor for natural color:

1. Go to **System > Diagnostics > Video**.
2. Select the **Color Bars** icon to display the color bar test screen.
3. Adjust the color using the monitor's controls for color, contrast, and brightness. Your monitor may also have controls for tint and temperature.
4. When the colors look right on the test screen, press the  **Near** button on the remote control to stop the Color Bars test and show video of the room.
5. If the color appears natural, you do not need to make further adjustments. If the color still needs adjustment, use the monitor's controls to make small adjustments until the picture appears natural.

Designing Audio Behaviors

This section describes how to configure the audio behaviors of the V500 system, including:

- General Audio Settings
- Volume on an External Audio System

Configuring General Audio Settings

To configure general audio settings:

1. Go to **System > Admin Settings > Audio**.
2. Configure these settings:

Setting	Description
Master Audio Volume	Sets the volume level for audio from the far site.
Sound Effects Volume	Sets the volume level of the ring tone and user alert tones.
Incoming Video Call	Specifies the ring tone used for incoming calls.
User Alert Tones	Specifies the tone used for user alerts.
Bass	Sets the volume level for the lower frequencies without changing the master audio volume.
Treble	Sets the volume level for the higher frequencies without changing the master audio volume.
Mute Auto-Answer Calls	Specifies whether to mute incoming calls. If you select this option, incoming calls are muted until you press the Mute button on the remote control.
Enable Internal Ringer	Specifies an additional ring tone when receiving an incoming call. The ringer is built into the system and will alert you to incoming calls even if the TV monitor connected to the system is powered off.

Setting the Volume on an External Audio System

If you have connected an external audio system, you may need to adjust its volume.

To set the volume:

1. Go to **System > Diagnostics > Audio > Speaker Test**.
2. Adjust the external audio system's volume so that the tone is as loud as a person talking in the room.

After you do this, you can adjust volume levels using the V500 system's remote control.

Designing General System Behaviors

You can configure the following general system behaviors to accommodate the needs of your organization:

- Call Settings
- Remote Control Behavior
- Directory Settings
- Call Answering Mode
- AES Encryption
- Passwords and Security Options
- Date, Time, and System Location

Configuring Call Settings

The Call Settings screens provide access to high-level options for the entire system. For convenience, some of the User Settings options are repeated on these screens.

To configure call settings:

1. Go to **System > Admin Settings > General Settings > System Settings > Call Settings**.
2. Configure these settings:

Setting	Description
Maximum Time in Call	Enter the maximum number of minutes allowed for call length. When that time has expired, you see a message asking you if you want to hang up or stay in the call. If you do not answer within one minute, the call automatically disconnects. If you choose to stay in the call at this time, you will not be prompted again.
Auto-Answer Point to Point	Specifies whether to answer incoming point-to-point calls automatically.
Display Time in Call	Specifies whether to display the elapsed time or the local time during a call. You can also choose not to display the time.
Call Detail Report	Specifies whether to generate a report of all calls made with the system. When selected, details for all calls can be viewed via the V500 web interface and downloaded as a .csv file.

Setting	Description
Recent Calls	Specifies whether to display the Recent Calls button on the home screen. The Recent Calls screen lists the site number or name, the date and time, and whether the call was incoming or outgoing. NOTE: If the Call Detail Report option is not selected, the Recent Calls option is not available.
Far Site Name Display Time	Specifies the time period the far-site name appears on screen when calls first connect.

Configuring Remote Control Behavior

You can customize the behavior of the remote control to support the your environment.

To configure remote control behavior:

1. Go to **System > Admin Settings > General Settings > System Settings > Remote Control**.
2. Configure these settings:

Setting	Description
Keypad Audio Confirmation	Specifies whether to play a voice confirmation of numbers selected with the remote control.
Remote Control Keypad	Specifies whether the camera moves to presets or creates DTMF tones when the remote control keypad buttons are pressed.

Configuring Directory Settings

You can customize the behavior of the Directory on the Directory screen.

To configure system settings:

1. Go to **System > Admin Settings > General Settings > System Settings > Directory**.
2. Configure these settings:

Setting	Description
System Name	Enter or change the system name in this field. This name appears on the screen for the far site when you are making calls.
Allow Directory Changes	Specifies whether you can save changes you make to the directory.

Setting	Description
Confirm Directory Additions	Specifies whether you are prompted to confirm new directory entries when saving the information for the last site called.
Confirm Directory Deletions	Specifies whether you are prompted to confirm deletions of directory entries.

Setting the Call Answering Mode

You can choose to answer calls automatically or manually, or you can set the system to automatically refuse any incoming calls.

To set the call answering mode:

1. Go to **System > Admin Settings > General Settings > System Settings > Call Settings**.
2. Select **Auto-Answer Point to Point**.
3. Select one of the following:
 - **Yes** – Answers calls automatically.
 - **No** – Enables you to answer calls manually.
 - **Do Not Disturb** – Refuses incoming calls automatically. The caller receives a message that the site is unavailable.



Automatically answering calls is convenient, but keep in mind that an unexpected caller could interrupt you or see and hear you without your knowledge. If you still want to automatically answer calls but you want to prevent incoming callers from seeing and hearing you, you can choose to mute all automatically answered calls and make sure your lens cover is closed.

Enabling AES Encryption

AES encryption is a standard feature on all V500 systems.

To enable AES encryption:

- >> Go to **System > Admin Settings > General Settings > Security** and select **AES Encryption**.

Setting Passwords and Security Options

You can enter or change the administrator and meeting passwords as well as specify whether to allow remote access to the system.

To set passwords and security options:

1. Go to **System > Admin Settings > General Settings > Security**.
2. Configure these settings:

Setting	Description
Admin Password	<p>Enter or change the Admin password.</p> <p>When the Admin password is set, you must enter this password to:</p> <ul style="list-style-type: none"> • Make configuration changes not in the User Settings screen. • Update the software. • Manage the system using the V500 web interface.
Meeting Password	Enter or change the meeting password, if any.
Allow Access to User Settings	<p>Specifies whether the User Settings screen is accessible to users via the System screen.</p> <p>Uncheck this option if you do not want users to change environmental settings.</p>
AES Encryption	Specifies whether to encrypt calls with other sites that support AES encryption.
Enable Remote Access	<p>Specifies whether to allow remote access to the system by:</p> <ul style="list-style-type: none"> • FTP • Web • Telnet • SNMP <p>You may select any of these, or any combination of them.</p> <p>NOTE: The system reboots if you change the remote access settings.</p>
Web Access Port	<p>Specifies the port to use when accessing the system using the V500 web interface.</p> <p>If you change this from the default (port 80), you will need to include the port number with the IP address when you use the V500 web interface to access the system. This makes unauthorized access more difficult.</p>
Allow Video Display on Web	Specifies whether to allow administrators to view the room where the system is located using the V500 web interface.

Setting Date, Time, and Location

You can update the system with regional settings, including the location-specific language and calling parameters.

To set the date, time, and location:

1. Go to **System > Admin Settings > General Settings > Location**.
2. Configure these settings:

Setting	Description
Country	Specifies the country where the system is located. Changing the country automatically adjusts the country code associated with your system number.
Language	Sets the language for the user interface.
Country Code	Specifies the country code for the system location.
Area Code Required	Specifies if an area code is required to place ISDN calls in the specified country.
ISDN International Access	Specifies the international code required for placing ISDN calls from the system location to another country.
Room Telephone Number	Indicates the telephone number of the room where the system is located.

3. Select  and configure these settings:

Setting	Description
Date Format and Time Format	Specifies your format preference for the date and time display and lets you enter your local date and time.
Daylight Saving Time	Specifies whether it is daylight saving time.
Time Difference from GMT	Specifies the time difference between GMT (Greenwich Mean Time) and your location.
Display Time in Call	Specifies the time display in a call: <ul style="list-style-type: none"> • Elapsed Time – Displays the amount of time in the call. • Local Time – Displays the local time on the screen during a call. • Off – Time is not displayed.
Time Server	Specifies connection to a time server for automatic system time settings.

Customizing the Workspace Appearance

You can customize the V500 system workspace appearance to suit your environment functionally and aesthetically.

For example, by customizing the home screen into kiosk mode, anyone who uses the system only has to select a site and press the  **Call** button on the remote control to place a call.

Use the following sections to configure the general appearance of the system:

- Designing the Home screen
- Adding Sites to the Home screen
- Adding On-screen Instructions
- Changing Color Schemes
- Setting Ring Tones and Alert Tones

Designing the Home Screen

Customize the system functionality according to your needs, skill level, and environment.

Infrequent Users (Kiosk Mode)

Provide a simple workspace so no training is needed:

- Let users make calls to pre-defined numbers with one button click.
- Include instructions on screen.

Include a short list of specific items for users to select

Use the marquee to add instructions



New Users

Provide more options but keep it simple:

- Dialing entry field
- Directory numbers
- Recent Calls

Add features for users as needed

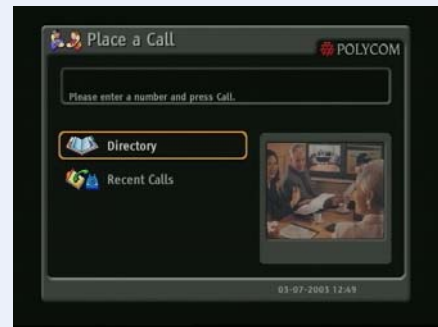

Advanced Users

Provide additional options for advanced video conferencing users:

- Call Quality
- User Settings, Diagnostics, and System Information
- Speed Dial list of frequently called sites

Add more features as users gain experience



To design the home screen:

1. Go to **System > Admin Settings > General Settings > Home Screen Settings**.
2. Configure these settings:

Setting	Description
Dialing Display	Specifies which dialing option to display: <ul style="list-style-type: none"> • Dialing entry field — Allows users to enter numbers manually. • Display marquee — Displays text in the dialing entry field. Can be used to display user instructions. Users cannot enter numbers manually when this option is selected. • None — Removes the dialing entry field from the screen.
Call Quality	Allows users to select the bandwidth for calls.
H.323 Extension (E.164)	Allows users to enter extensions on the home screen.
Directory	Allows users to access the directory.
System	Allows users to access the System screen, which includes User Settings, Diagnostics, and System Information.



If you remove the System button, you can still access the System screen by navigating to the home screen, pressing  **Help** on the remote, and selecting **System**.

3. Select  and configure these settings:

Setting	Description
System Name	Specifies whether to display the name of the system on the home screen above the PIP window.
IP or ISDN Information	Specifies whether to display the system's IP address, ISDN number, or both on the home screen.
Local Date and Time	Specifies whether to display the local date and time on the home screen.
Do Not Disturb Icon	Allows users to set the system to automatically accept or ignore incoming calls using the Do Not Disturb button on the home screen.
Call Detail Report	Specifies whether to generate a report of all calls made with the system. When selected, all calls can be viewed through the web interface and downloaded as a .csv file.
Recent Calls	Allows users to access a list of recent calls made with the system by displaying the Recent Calls button on the home screen. If the Call Detail Report option is not selected, the Recent Calls option is not available.

4. Select  and configure these settings:

Setting	Description
Sites	Allows users to access any pre-defined sites from a My Contacts/Speed Dial list on the home screen.
Last Number Dialed	Specifies whether to display the last number dialed or clear the address box on the home screen.

Adding Sites to the Home Screen

Creating Site buttons on the home screen makes it easy for you to place calls to sites that you call on a regular basis.

Sites can appear as individual buttons or as part of a list called **Speed Dial** or **My Contacts**.



You must enter the site information in the directory before creating specific Site buttons for the home screen.

To add sites on the Home screen:

1. Go to **System > Admin Settings > General Settings > Home Screen Settings**.
2. Select  three times to access the Sites screen.
3. Select **Add** and choose the sites to add from the directory.
4. Select either **Speed Dial** or **Contacts** as the name you want to appear on the button.

Adding On-screen Instructions

Using Marquee Text

You can create marquee text to display in the dialing entry field on the home screen. You can create context-specific instructions or, if the home screen has Site buttons, the marquee text can provide information that helps other users choose which site to call.

To enter marquee text:

1. Go to **System > Admin Settings > General Settings > Home Screen Settings**.
2. In **Dialing Display**, select **Display Marquee** and enter the text.



You can also add marquee text through the V500 web interface.

Using Screen Saver Text

You can customize the V500 system to display text when the system is in sleep mode. For instance, you can display on-screen instructions.

To enter screen saver text:

1. On a PC, open a web browser.
2. In the browser address line, enter the system's IP address (for example, `http://255.255.255.255`) to go to the V500 web interface.
3. Enter your user name and the password, if a password has been established.
4. Click **System Setup > Utilities > Screen Saver** and enter:
 - **Text** — Appears as scrolling text when the system is in sleep mode. You can use this scrolling text to provide instructions or next steps for users of the system.
 - **Logo Text** — Appears underneath the logo before the system goes into sleep mode.
5. Click **Update**.

Changing System Appearance

Different user interface color schemes are available, allowing you to coordinate the system interface with the room décor.

To change the color scheme:

1. Go to **System > Admin Settings > General Settings > System Settings > Appearance**.
2. Configure these settings:

Setting	Description
Color Scheme	Customizes the look of your system with different color schemes.
Screen Saver Wait Time	Specifies how long the system remains awake during periods of inactivity. The default is 3 minutes.

You can allow users to change color schemes by allowing user access to the User Settings screen.

Setting Ring Tones and Alert Tones

To set ring tones and alert tones:

1. Go to **System > Admin Settings > Audio**.
2. Select a tone, as desired.

To set the V500 system's internal ringer:

1. Go to **System > Admin Settings > Audio**.
2. Select **Enable Internal Ringer** to specify an additional ring tone when receiving an incoming call.



The ringer is built into the system and will alert you to incoming calls even if the TV monitor connected to the system is powered off.

Configuring Closed Captioning

You can provide real-time text transcriptions or language translations of the video conference by displaying closed captions on your system. When you provide captions for a conference, the captioner uses a web browser to listen to the conference audio and enter the caption text in the system's web interface. When the captioner sends a unit of text, all sites see it on the main monitor for 15 seconds. The text then disappears automatically.

Audio Options for Closed Captioners

When you provide captions for a conference, the captioner may be present, or may use a telephone or web browser to listen to the conference audio.

The captioner must receive audio from the conference in one of these ways:

- Attending one of the conferences sites
- Listening to the conference via the V500 web interface
- Listening to the conference via a speakerphone in the room at one of the sites

Options for Supplying Closed Captions to Conferences

Captions can be provided in any language that uses the Latin alphabet.

The captioner can enter caption text in one of these ways:

- In the room or remotely, using the V500 web interface
- In the room or remotely, using a Telnet session

Providing Captions Via the V500 Web Interface

Closed captioners can provide captions from inside the conference room, or from a remote location, by entering the captions directly into the V500 web interface, as shown in the diagram below.

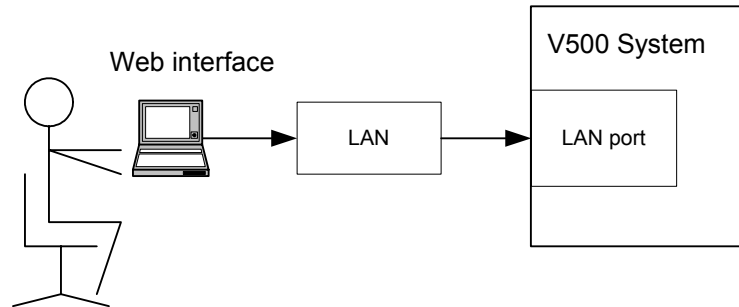

To supply closed captions for a conference using the V500 web interface:

1. On a PC, open a web browser.
2. In the browser address line, enter the IP address of the system (for example, `http://255.255.255.255`) to go to the system's web interface.
3. Go to **System Setup > Utilities > Closed Caption**.
4. Enter your user name and the password, if a password has been established.
5. In the Closed Caption screen, type the caption text into the text field. Text wraps to the next line after 59 characters.
6. Press **Enter** to send the text to the sites in the conference.

Providing Captions Via a Telnet Session

Closed captioners can provide captions from inside the conference room, or from a remote location, by entering captions via a Telnet session, as shown in the diagram below:

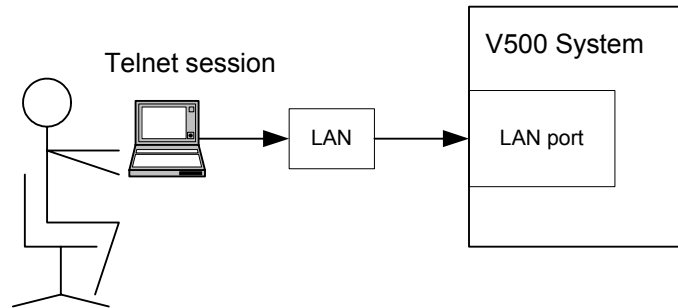

To supply closed captions for a conference using a Telnet session:

1. On a PC, open a command line interface.
2. Start a Telnet session using the V500 system's IP address and port 24 (for example, `telnet 255.255.255.24`).
3. Enter the command `cc` to start captioning.
4. Press **Enter** to send the text.
5. To stop sending closed captions, press **CTRL-Z**.

Getting Started with Calling

The system is installed and you've finished the network configuration and designed the behaviors. Now it's time for you to start placing calls. You may want to spend time becoming familiar with basic calling tasks.

The following resources are available:

- ❑ *V500 System Getting Started Guide* — This guide is for all users, from beginners to the more experienced. It covers meeting basics, different ways to place calls, how to use the remote control, and how to deliver presentations.
It is included on the V500 system documentation CD and is also available on the web.
- ❑ Screen Help — The home and Directory screens have context-specific help. Users can press  on the remote control to access help topics.
- ❑ www.polycom.com/videodocumentation — Refer to the video documentation page on the Polycom website for the latest documents supporting these products.

5

Managing the System Remotely

You configure, manage, and monitor the system from a remote computer using the V500 web interface (the system's web interface), the Polycom Global Management System, or SNMP.

Your choice of management tool depends on your network environment:

- V500 web interface requires only a web browser to control the system.
- Polycom Global Management System requires the GMS application to be installed on your network.
- SNMP requires network management software on your network management station.

What's in this Chapter?	Page
Using the V500 Web Interface	5-2
Configuring Global Services	5-5
Setting Up SNMP	5-8

Using the V500 Web Interface

You can use the web interface to perform most of the calling and configuration tasks you can perform on the local system.

Accessing the V500 Web Interface

To configure your browser to use the web interface:

1. Be sure that your web browser uses Microsoft Internet Explorer 6.0 or later.
2. Configure these settings:
 - Allow cookies: Enabled
 - Force pages to reload on every visit to a page: Enabled

To access the system using the web interface:

1. On a PC, open a web browser.
2. In the browser address line, enter the system's IP address (for example, `http://255.255.255.255`) to go to V500 web interface.
3. Enter `admin` as the user name, and the password, if a password has been established.



You can use the web interface to configure all of the system settings except the remote management settings. For security reasons, these settings must be configured on the local system by an administrator.

Managing System Profiles with the V500 Web Interface

The customization options for V500 systems have been extended with the ability to store your system settings as separate profiles. Profiles can be stored on your PC as a .csv file using the V500 web interface. There is no limit to the number of profiles you can save.

This is particularly useful if you are managing systems that support multiple applications. Changing the interface and behaviors of the V500 system can be done quickly and easily.

The following settings are included in a profile:

- Home Screen settings
- User access levels
- Icon selections
- Option keys
- System behaviors



Polycom recommends using profiles as a way to back up system settings. Attempting to edit a stored profile or upload it to a different system can result in unexpected problems.

To store a profile:

1. In the V500 web interface, go to **System Setup > Utilities > Profile Center**.
2. Click **V500 -> PC** to download the .csv file from the V500 system.
3. Save the file to a location on your PC.

To upload a profile:

1. In the V500 web interface, go to **System Setup > Utilities > Profile Center**.
2. Click **Browse** and browse to the location of the .csv file on your PC.
3. Click **PC -> V500** to upload the .csv file to your system.

Managing Directories with the V500 Web Interface

The V500 web interface's import/export directory feature allows you to efficiently maintain consistency of V500 system directories. It is particularly useful if you are managing multiple systems that call the same locations. You can:

- Transfer existing directory entries between V500 systems
- Develop directory entries on one system, save them to your PC, and then distribute them to other systems

Only local directories can be downloaded. The directory file is in .csv format.

To download a V500 system directory to your PC:

1. In the V500 web interface, go to **System Setup > Utilities > Import Directory**.
2. Click **V500 -> PC** to download the .csv file from the V500 system.
3. Save the file to a location on your PC.

To upload V500 system directory entries:

1. In the V500 web interface, go to **System Setup > Utilities > Import Directory**.
2. Click **PC -> V500**.
3. Click **Browse** and browse to the location of the .csv file on your PC.
4. Click **Export Directory** to upload the .csv file to the V500 system.

Configuring Global Services

If you use the Polycom Global Management System, you can configure, manage, and monitor the V500 system using the Global Management System (GMS) server. GMS is a web-based client/server software tool that allows administrators to manage a network of video conferencing systems.

To use global services for the system, configure the following:

- Management Servers
- Account Numbers
- My Information

Viewing the Management Servers List

On networks managed by the Global Management System, several Global Servers may be configured to manage this system remotely. The system also has a primary Global Management System server that performs account validation. You can view information about these servers, but this information can only be changed by the GMS Administrator.

To view the management servers list:

>> Go to **System > Admin Settings > Global Services > Management Servers**.

Requiring an Account Number for Calls

If your system is set up for use with the Global Management System, the system can prompt you to enter an account number before placing a call. The account number is added to the Global Management System's Call Detail Record (CDR), and this information can be used for call tracking and billing purposes.

If you configure the system to validate the account number, calls placed without a valid account number are not completed. If you do not configure the system to validate account numbers, calls are completed regardless of whether the account number is valid. Account numbers are set up in the Global Management System by the Global Management System administrator.

For more information about account validation, please contact your Global Management System administrator.

To require an account number for calls:

1. Go to **System > Admin Settings > Global Services > Account Validation**.
2. Specify whether to require an account number for placing calls and whether that number should be validated by the Global Management System server.

Adding My Information



If your system is managed by the Global Management System, you can configure the V500 system so that you can request help from the Global Management System administrator.

To add information for the Global Management System administrator:

1. Go to **System > Admin Settings > Global Services > My Information**.
2. Enter the contact information for the Global Management System administrator for technical support.

The following section illustrates the interaction between Global Management System and the system you are configuring.

Requesting Technical Support from the GM S Administrator

- 1. From the Place A Call screen, press  on the remote.
- 2. Select **Support** and press  on the remote.

You see the following message:
Tech Support will be alerted to phone you at the following number. Continue?
Enter your contact telephone number.

The V500 system sends your information to the Global Management System.

You see the following message:
Tech Support has been alerted. You can also call this number for assistance.
The message displays the telephone number you entered for Tech Support on the My Information screen.

The GMS administrator opens the alert message containing your telephone number.

GMS sends a message to your V500 system.

The V500 system displays the message from GMS:
Your request for help has been acknowledged.

The GMS administrator calls you.

Setting Up SNMP

The V500 system sends SNMP (Simple Network Management Protocol) reports to indicate a total of 31 conditions, including the following:

- All alert conditions found on the V500 system's alert page
- Details of jitter, latency, and packet loss
- Low battery power is detected in the remote control
- A system powers on after a long period powered off
- Administrator logon is successful or unsuccessful
- A call fails for a reason other than a busy line
- A user requests help
- A telephone or video call connects or disconnects

Downloading MIBs

Before you can perform SNMP reporting, you need to install Polycom MIBs on the computer you intend to use as your network management station.

The MIBs are available for download from the V500 web interface.

To download the Polycom MIBs:

1. On a PC, open a web browser.
2. In the browser address line, enter the IP address of the system (for example, `http://255.255.255.255`) to go to the system's web interface.
3. Go to **Admin Settings > Global Services > SNMP**.
4. Click **Download MIB** and follow the onscreen instructions.

Configuring for SNMP Management

To configure the V500 system for SNMP management:

1. In the V500 web interface or from the V500 system, go to **Admin Settings > Global Services > SNMP**.
2. Configure these settings:

Setting	Description
Enable SNMP	Allows administrators to manage the system remotely using SNMP.
SNMP Community	Specifies the SNMP management community in which you want to enable this system. The default community is <i>public</i> .
SNMP Contact Name	Specifies the name of the person responsible for remote management of this system.
SNMP Location Name	Specifies the location of the system. The default is <i>your system name@your country name</i> .
SNMP System Description	Specifies the type of video conferencing device. This is a display-only field.
SNMP Console IP Address	Specifies the IP address of the SNMP traps sent by the system. Enter 0 . 0 . 0 . 0 in this field if any SNMP management console is capable of receiving information from this agent.

6

System Usage and Statistics

The V500 system provides various screens that allow you to review information about calls made by the system and to review network usage and performance.

What's in this Chapter?	Page
Call Summary	6-2
Call Statistics	6-3
Call Status	6-4
Recent Calls	6-6
Call Detail Report	6-6

Call Summary

The Call Summary screen provides details about the calls placed by the system, including:

- Duration of the last call
- Total number of calls placed and received
- Number, total time, and percentage of IP calls
- Number, total time, and percentage of ISDN calls

To view the Call Summary screen:

>> Go to **System > Diagnostics > Call Statistics** and then select  three times.



You can view Call Statistics and Call Summary during a call by pressing  on the remote.

Call Statistics

The two Call Statistics screens provide information about the call in progress, including:

This screen:	Displays this information:
Call Statistics (1)	<ul style="list-style-type: none"> • Call speed (transmit and receive) • Video protocol, annexes, and format in use (transmit and receive)^a • Audio protocol in use (transmit and receive) • Number of packets lost and percentage packet loss (transmit and receive) in IP calls • Encryption type, key exchange algorithm type, and key exchange check code (if the encryption option is enabled and the call is encrypted) • Far site details and call type
Call Statistics (2)	<ul style="list-style-type: none"> • Audio and video data rates specified (transmit and receive) • Video data rate and frame rate in use (transmit and receive) • Video packet loss and jitter in IP calls • Audio packet loss and jitter in IP calls • Far site details and call type

a. The video protocol is shown in green if the system is currently using error concealment.

To view the Call Statistics screen:

>> Go to **System > Diagnostics > Call Statistics** and then select .



You can view Call Statistics and Call Summary during a call by pressing  on the remote.

Call Status

The Call Status screen provides call connection information. The spheres on the screen provide details for each line. When you place a call, you'll see the status change as the call connects.

To view the Call Status screen:

>> Go to **System > Diagnostics > Call Statistics**.

You can highlight the spheres on this screen to see the number dialed, the relevant status code, and details of any errors.



You can view **Call Status** during a call by pressing  on the remote.

Recent Calls

Recent Calls shows a list of up to 99 calls made by the system. It includes the following information:

- Site name or number
- Date
- Time
- Call In or Out

The Recent Calls list shows incoming and outgoing calls that connect, as well as outgoing calls that do not connect.

If Do Not Disturb has been enabled, any incoming calls attempted by other sites will not be listed.





The Home screen can be configured to include Recent Calls. For more information about including the Recent Calls list on the home screen, see [Designing the Home Screen on page 4-17](#).

To view the Recent Calls screen:

>> Go to **System > Admin Settings > Network > Recent Calls**.

You can see more detail about any call by selecting an entry and pressing  on the remote. Information includes the far site's number and name, and the type, speed (bandwidth), and duration of the call.

You can call any site on the Recent Calls list by highlighting the entry and pressing  or  on the remote to place the call.



If you need even more detail about calls, you can download the Call Detail Report (CDR) from the V500 web interface. For more information about the CDR, see [Call Detail Report on page 6-6](#).

Call Detail Report

The Call Detail Report (CDR) provides the system's call history. You can view the CDR from the V500 web interface, and you can download the data in CSV format for sorting and formatting.



CSV stands for Comma Separated Value. CSV files can be imported into spreadsheet and database programs.

Every call that connects is added to the CDR, whether it is a call that you make or that you receive. If a call does not connect, the report shows the reason.

The CDR does not include incoming calls that the V500 system does not answer, so if calls were missed while Do Not Disturb was enabled, details will not be included in the CDR.

To view and download the CDR via the V500 web interface:

1. On a PC, open a web browser.
2. In the browser address line, enter the system's IP address (for example, `http://255.255.255.255`) to go to V500 web interface.
3. Enter your user name and the password, if a password has been established.
4. Click **System Setup > Utilities > Call Detail Report** to view the details of the file.
5. Click **Save** and then specify a location on your computer to save the file.

Information in the Call Detail Report

The following table describes the data fields in the CDR.

Data	Description
Row ID	Each call is logged on the first available row.
Start Date	The call start date, in the format dd-mmm-yyyy.
Start Time	The call start time, in the 24-hour format hh:mm:ss.
End Date	The call end date.
End Time	The call end time.
Call Duration	The length of the call.

Data	Description
Account Number	If Require Account Number to Dial is enabled on the system, the value entered by the user is displayed in this field.
Remote System Name	The far site's system name.
Call Field Number 1	The number dialed from the first call field, not necessarily the transport address. For incoming calls — The caller ID information from the first number received from a far site.
Call Field Number 2 (if applicable for call)	For outgoing calls — The number dialed from the second call field, not necessarily the transport address. For incoming calls — The caller ID information from the second number received from a far site.
Transport Type	The type of call — Either H.320 (ISDN) or H.323 (IP).
Call Rate	The bandwidth negotiated with the far site.
System Manufacturer	The name of the system manufacturer, model, and software version, if they can be determined.
Call Direction	In — For calls received. Out — For calls placed from the system.
Conference ID	A number given to each conference.
Call ID	Identifies individual calls within the same conference.
Total H.320 Channels Used	The total number of ISDN B channels used in the call.
Endpoint Alias	The alias of the far site.
Endpoint Additional Alias	An additional alias of the far site.
Endpoint Type	Terminal, gateway, or MCU.
Endpoint Transport Address	The actual address of the far site (not necessarily the address dialed).
Audio Protocol (Tx)	The audio protocol transmitted to the far site, such as G.728.
Audio Protocol (Rx)	The audio protocol received from the far site, such as G.728 or G.722.
Video Protocol (Tx)	The video protocol transmitted to the far site, such as H.263 or H.264.
Video Protocol (Rx)	The video protocol received from the far site, such as H.261 or H.263.
Video Format (Tx)	The video format transmitted to the far site, such as CIF or SIF.
Video Format (Rx)	The video format received from the far site, such as CIF or SIF.

Data	Description
Disconnect Reason	The description of the Q.850 (ISDN) cause code showing how the call ended.
Q.850 Cause Code	The Q.850 cause code showing how the call ended.
Total H.320 Errors	The number of errors during an H.320 call.
Average Percent of Packet Loss (Tx)	The combined average of the percentage of both audio and video packets transmitted that were lost during the 5 seconds preceding the moment at which a sample was taken. This value does not report a cumulative average for the entire H.323 call. However, it does report an average of the sampled values.
Average Percent of Packet Loss (Rx)	The combined average of the percentage of both audio and video packets received that were lost during the 5 seconds preceding the moment at which a sample was taken. This value does not report a cumulative average for the entire H.323 call. However, it does report an average of the sampled values.
Average Packets Lost (Tx)	The number of packets transmitted that were lost during an H.323 call.
Average Packets Lost (Rx)	The number of packets from the far site that were lost during an H.323 call.
Average Latency (Tx)	The average latency of packets transmitted during an H.323 call based on round-trip delay, calculated from sample tests done once per minute.
Average Latency (Rx)	The average latency of packets received during an H.323 call based on round-trip delay, calculated from sample tests done once per minute.
Maximum Latency (Tx)	The maximum latency for packets transmitted during an H.323 call based on round-trip delay, calculated from sample tests done once per minute.
Maximum Latency (Rx)	The maximum latency for packets received during an H.323 call based on round-trip delay, calculated from sample tests done once per minute.
Average Jitter (Tx)	The average jitter of packets transmitted during an H.323 call, calculated from sample tests done once per minute.
Average Jitter (Rx)	The average jitter of packets received during an H.323 call, calculated from sample tests done once per minute.
Maximum Jitter (Tx)	The maximum jitter of packets transmitted during an H.323 call, calculated from sample tests done once per minute.
Maximum Jitter (Rx)	The maximum jitter of packets received during an H.323 call, calculated from sample tests done once per minute.

Call Detail Report Archives

Calls are added to the CDR until the file size reaches 50 KB, which is equivalent to about 150 calls. The system then automatically archives the CDR and creates a new CDR file. If an archive is already present, the new archive overwrites it.

Each CDR starts with Row 1, but the conference numbers continue from the file most recently archived. Conference numbering restarts at 1 after the system assigns conference number 100,000.

To get an archived CDR:

1. From your computer, open an FTP client.
2. FTP into the V500 system.
3. Enter this FTP command:
`GET localcdr_archive.csv`
4. Close your FTP session.

7

Diagnostics and General Troubleshooting

This chapter covers the diagnostic screens of the V500 system. It is organized by category to help you troubleshoot any issue.

Diagnostic tools are available via the system itself and the system's web server. To connect to your system's web server and troubleshoot via the web, enter your system's IP address in a web browser and browse to the required diagnostic tool.

What's in this Chapter?	Page
Sending a Message	7-2
System Screens Quick Reference	7-2
Diagnostic Screens	7-3
General Troubleshooting	7-8
How to Contact Technical Support	7-17

Sending a Message

You can send a message to the V500 system from the V500 web interface.

Only the near site can see the message; it is not broadcast to the far site in the call.

To send a message via the V500 web interface:

1. On a PC, open a web browser.
2. In the browser address line, enter the system's IP address (for example, `http://255.255.255.255`) to go to V500 web interface.
3. Enter your user name and the password, if a password has been established.
4. Go to **System Setup > Diagnostics > Send a Message**.
5. Enter a message (up to 100 characters in length), then click **Send**.

The message is displayed for 15 seconds on the screen of the system.

System Screens Quick Reference

These screens allow you to view information about the system, configure the system, and diagnose performance issues if they arise. They are available on the system and through the V500 web interface.

To view information about the system, go to the home screen and select **System**. Then choose the type of information you need:

This choice:	Presents this information or capability:
Admin Settings	User interface customization, system customization, security, dialing requirements and network configuration, Global Management System information.
Diagnostics	System status and performance and system tests. The V500 web interface also offers the Send Message function and provides access to the Call Detail Report.
System Information	Identifying information.
Utilities	Call scheduling and calendar.
User Settings	System behavior and appearance.

Diagnostic Screens

You can view network statistics and perform diagnostic tests from the V500 system's Diagnostics screens.

To access the Diagnostics screens on the system:



>> Go to **System > Diagnostics**.

To access the Diagnostics screens from the V500 web interface:

1. On a PC, open a web browser.
2. In the browser address line, enter the system's IP address (for example, `http://255.255.255.255`) to go to V500 web interface.
3. Enter your user name and the password, if a password has been established.
4. Go to **System Setup > Diagnostics** and select one of the tools from the Diagnostics menu.

The following diagnostic screen and tools are available:

Call Status Tools		
Diagnostic Tool	In the system's user interface	In the V500 web interface
System Status screen Displays system status information, including auto-answer point to point, remote control battery, time server, Global Directories, IP network, gatekeeper, UPnP, and ISDN BRI line.	On the Diagnostics screen, select System Status .	Select Diagnostics > System Status .
Call Summary screen Displays calling information, such as time spent in calls, total number of IP and ISDN calls, and percentage of time spent in IP and ISDN calls.	<ol style="list-style-type: none"> 1. On the Diagnostics screen, select System Status. 2. Select  to go to the Call Summary screen. 	Select Diagnostics > System Status > Call Summary .
	For more information about this screen, see Call Summary on page 6-2 .	

Call Status Tools		
Diagnostic Tool	In the system's user interface	In the V500 web interface
<p>Call Status screen</p> <p>Displays call type, data speed, and number dialed for the current call.</p> <p>In ISDN calls, this screen also displays connection status for each channel. Selecting a channel call progress indicator displays its ISDN number.</p>	<p>On the Diagnostics screen, select Call Statistics.</p>	<p>1. Select Diagnostics > Call Statistics.</p> <p>2. Select  twice.</p>
	<p>For more information about this screen, see Call Status on page 6-4.</p>	
<p>Call Statistics screen</p> <p>Displays call speed, audio and video protocols, annexes, and error count for the call in progress.</p>	<p>1. On the Diagnostics screen, select Call Statistics.</p> <p>2. Select  to go to the Call Statistics screen.</p>	<p>Select Diagnostics > Call Statistics.</p>
	<p>For more information about this screen, see Call Statistics on page 6-3.</p>	
<p>Call Detail Report screen</p> <p>Displays the current Call Detail Report (CDR) and provides access to the archived CDR.</p>	<p>Not available.</p>	<p>Select Utilities > Call Detail Report.</p>
	<p>For more information about this screen, see Call Detail Report on page 6-6.</p>	

Network Tools		
Diagnostic Tool	In the system's user interface	In the V500 web interface
<p>Near End Loop test</p> <p>Tests whether your system is able to make IP calls successfully.</p> <p>Monitor 1 displays the video and plays the audio that would be sent to the far site in a call.</p> <p>This test is not available when you are in an IP call.</p>	<p>1. On the Diagnostics screen, select Network.</p> <p>2. Select Near End Loop to start the test.</p> <p>3. Press any button on the remote control to stop the test.</p>	<p>1. Select Diagnostics > Network > Near End Loop.</p> <p>2. Click the Near End Loop icon.</p> <p>3. Click Near End Loop again to end the test.</p>
<p>PING test</p> <p>Tests whether the system can establish contact with a far-site IP address that you specify.</p>	<p>1. On the Diagnostics screen, select Network > PING.</p> <p>2. Enter the IP address that you wish to test.</p> <p>3. Select Start.</p> <p>If the test is successful, the system displays a message indicating that the IP address under test is available.</p>	<p>1. Select Diagnostics > Network > PING..</p> <p>2. Enter the IP address that you wish to test.</p> <p>3. Click the PING icon.</p> <p>If the test is successful, the system displays a message indicating that the IP address under test is available.</p>

Network Tools		
Diagnostic Tool	In the system's user interface	In the V500 web interface
<p>Trace Route test</p> <p>Tests the routing path between the local system and the IP address entered.</p>	<ol style="list-style-type: none"> 1. On the Diagnostics screen, select Network > Trace Route. 2. Enter the IP address that you wish to trace. 3. Select Start. 	<ol style="list-style-type: none"> 1. On the Diagnostics menu, select Network > Trace Route. 2. Enter the IP address that you wish to trace. 3. Click the Trace Route icon.
<p>Error Log files</p>	Not available.	Select Diagnostics > Network > Error Log .

Video and Audio Tools		
Diagnostic Tool	In the system's user interface	In the V500 web interface
<p>Color Bar test</p> <p>Tests the color settings of your monitor for optimum picture quality.</p> <p>If the color bars generated during the test are not clear, or the colors do not look correct, the monitor needs to be adjusted.</p>	<ol style="list-style-type: none"> 1. On the Diagnostics screen, select Video. 2. Select the Color Bars icon. 3. Press any button on the remote control to stop the test. 	<ol style="list-style-type: none"> 1. Select Diagnostics > Video. 2. Click the Color Bars icon. 3. Click the Color Bars icon again to stop the test.
<p>Speaker test</p> <p>Tests the audio cable connections. A 400 Hz audio tone indicates that the local audio connections are correct.</p>	<ol style="list-style-type: none"> 1. On the Diagnostics screen, select Audio > Speaker Test. 2. Select the Speaker Test icon. 3. Press any button on the remote control to stop the test. <p>If you are in a call, the far site will also hear the tone.</p>	<ol style="list-style-type: none"> 1. Select Diagnostics > Audio > Speaker Test. 2. Click the Speaker Test icon. 3. Click the Speaker Test icon again to stop the test. <p>The people at the site you are testing will hear the tone, but you will not. You can send a message to tell them how to notify you when they hear the speaker test.</p>
<p>Audio Meter screen</p> <p>Measures the strength of audio signals from the system's microphone.</p> <p>If the system is not receiving sound, ensure that people are close enough to the system, and check whether the microphone is muted.</p>	<ol style="list-style-type: none"> 1. On the Diagnostics screen, select Audio > Audio Meter. The audio meter should register between 0 and 15 dB. 2. To check the microphone, stand near the system and begin speaking. 	<p>Select Diagnostics > Audio > Audio Meter to start the test.</p> <p>The audio meter should register between 0 and 15 dB.</p>

Reset and Restart		
Diagnostic Tool	In the system's user interface	In the V500 web interface
<p>Reset System</p> <ul style="list-style-type: none"> • Cycles power to the system. • Allows you to keep your system settings (such as system name and network configuration) or restore factory settings. • Allows you to keep or delete the directory stored on the system. 	<ol style="list-style-type: none"> 1. On the Diagnostics screen, select Reset System. 2. Enter the system's serial number. 3. If you wish to restore the original factory settings, select Delete System Settings. This deletes the administrator's password, CDR, and CDR archive along with the other system settings. You may wish to download the CDR and CDR archive before you reset the system. See Call Detail Report on page 6-6. If you delete system settings, the setup wizard will lead you through the initial configuration after the system restarts. 4. If you wish to remove the directory, select Delete Directory Entries. This only deletes the system's local directory. System reset does not affect the Global Directory. 5. Select Reset System. 	<p>Not available.</p>
<p>Restart System</p> <p>Cycles power to the system.</p>	<p>Use the power switch on the system.</p>	<ol style="list-style-type: none"> 1. Select Diagnostics > Reset System. 2. Click the Reset System icon.

Indicators

The V500 system uses indicator lights to provide status information. The following tables give the meanings of each indicator.

System Lights

The system lights are located on the front of the V500 system.

When the V500 system...	It means...
Indicators are off	No power to the system.
Green indicator blinks slowly	The system is sleeping.
Green indicator flashes when you use the remote control	The system is not in a call, and is receiving signals from the remote control.
Amber indicator flashes when you use the remote control	The system is in a call, and is receiving signals from the remote control.
Green indicator is on	The system is ready to make a call.
Amber indicator is on	The system is in a call.
Red indicator is on.	The system microphone is muted.

Network Interface Lights

The BRI network interface lights are located on the back of the system near the BRI connector.

When the BRI network interface...	It means...
Indicators are off	<ul style="list-style-type: none"> No power to the system, or The system is not connected to the network, or The system is not receiving a clock signal from the network, or The system is restarting.
Green indicator is on	The system is receiving a clock signal from the network.
Yellow indicator is on	The system is able to make a call.
Green and yellow indicators are on	<ul style="list-style-type: none"> The system is receiving a software update, or The system is operating normally.

General Troubleshooting

This section presents problems, likely causes, and corrective actions. Problems are presented as follows:

- Critical problems** – Prevent use of the system or access to common functions.
- Severe problems** – Prevent you from making calls successfully.
- Moderate issues** – Prevent or interfere with meaningful communication during the call.
- Minor issues** – Detract from the user experience.

Critical Problems

This section describes problems that prevent normal use of the system. They may also mask other problems. For example, if the system is not able to make a call and there are no batteries in the remote, you will need to install new batteries before you are able to determine whether the system can make calls.

Symptom	Cause	Solution
System does not respond in any way.	The power switch is in the OFF position.	Turn on the power switch.
	The power cord is not connected.	Make sure that the system's power cord is in place, and that it is connected to a power outlet
	The power outlet is not active.	Check the power outlet by unplugging the system and plugging in a lamp, radio, or other small appliance. If it does not operate, connect the power cord to a different outlet.
	The power supply is not operating properly.	Check the power outlet by unplugging the system and plugging in a lamp, radio, or other small appliance. If it operates, the problem is in the system. Call Polycom Technical Support and arrange to return the system for service.
System starts in the Software Update screen.	The system software is corrupted or not loaded properly.	Load the system software from your PC. For instructions on how to do this, refer to Keeping your Software Current on page 3-19 or consult your network equipment provider.

Symptom	Cause	Solution
System does not respond to the remote control.	No batteries in the remote control.	Install the batteries in the remote control.
	The batteries are installed incorrectly in the remote control.	Insert the batteries in the correct +/- position.
	The room lights operate in the 38 KHz range and interfere with the remote control signals.	Turn off the lights in the room and try the remote control again.
	The infrared sensor is not receiving signals from the remote control.	Make sure you are pointing the remote control at the infrared sensor on the front of the system.

Severe Problems

The problems in this section prevent you from making calls successfully. They may also mask less serious problems. For example, if you cannot complete a call and there is also an audio problem, you will need to correct the problem that prevents calling before you can determine whether there is an audio problem

Symptom	Cause	Solution
IP: The System Information screen shows "waiting" in the IP Video Number field.	The LAN is not working.	Check the LAN connection. Contact your network service provider.
	The DHCP server is not available.	Contact your network service provider to correct the problem with the server or to assign a static IP address.
IP: Error message occurs when placing an IP (H.323) call.	The system is not connected to the LAN.	Verify that the LAN cable is connected properly.
	The system's LAN cable is not operating properly.	Replace the system's LAN cable.
	The far site is not connected.	Use the PING test (System > Diagnostics > Network > PING) to determine whether the far site is accessible to your system. If the test fails, the far site system is unavailable.
	The system is not configured correctly for the network.	Check your IP configuration.
	The IP Gateway/Gatekeeper is not operating or is not configured correctly.	Contact your network service provider.

Symptom	Cause	Solution
ISDN: Line Status icons do not go away so video calls cannot be made.	The system is not connected to an ISDN.	Check the ISDN line connections.
	The ISDN number is entered incorrectly.	Check the ISDN numbers with your service provider.
	The system was not able to auto-detect SPIDs, or the SPID numbers are entered incorrectly. NOTE: The AT&T point-to-point protocol does not require SPIDs.	Select the Clear icon on the Auto Detect SPIDs page, and then select the Start icon to automatically detect the new SPIDs. Make sure your ISDN numbers are entered correctly.
	The BRI network is directly connected to a U interface.	Install an NT-1 device between your network interface and the ISDN connection.
	The system is connected to an NT-1 then to a PBX.	You do not need an NT-1 device when connecting to a PBX. Connect the system directly to the PBX S/T connection.
	The ISDN line is provisioned incorrectly by the ISDN service provider.	Check that your ISDN line is provisioned for Voice/Data.
	The V500 system is in an unknown state.	Power off the system, wait five seconds, and power on the system.
ISDN: When placing a call, progress indicators do not turn green.	The call does not connect properly.	Try the call again.
ISDN: Error message occurs when placing an ISDN (H.320) call.	An ISDN cause code is received from the ISDN line.	Try the call again. For more information, please refer to Q.850 Cause Codes on page Appendix-4 .
	The line did not connect.	Be sure you are calling the correct number. The number may need to include: <ul style="list-style-type: none"> • A digit for an outside line • A long distance access code • An international access code • A country code • An area code or city code Check that all network cables are properly connected. Power off the system, wait five seconds, and power on the system. Ask the person at the far site to call your system.
	The ISDN switch type is not configured correctly on the V500 system.	Check the ISDN configuration and verify with your ISDN service provider that the system is configured correctly.

Symptom	Cause	Solution
Cannot dial remote system in bonding 128 K calls. (The call progress circles only show blue or yellow.)	Switch protocol issue.	Start by calling the far site at 1x56, 1x64, 2x56, or 2x64K, as appropriate. This will verify the primary number. If these calls complete, try the 128 K call. Being able to dial non-bonded but unable to dial bonded to all locations is usually a switch protocol issue. Verify your ISDN provisioning with the telephone service provider.
Cannot select 112 or 128 speeds for bonding calls from the speed selection.	Speeds do not show when selecting the speed icon.	Add line speeds on the Admin Settings > Network > Call Quality > Dialing Speeds screen.

Moderate Issues

The problems in this section interfere with or prevent meaningful communication in a call.

Symptom	Cause	Solution
The monitor screen remains blank when you pick up the remote control.	The monitor's power cord is not plugged in.	Connect the monitor's power cord and then power on the monitor.
	The monitor is powered off.	Power on the monitor.
	The monitor is not connected correctly to the system.	Verify that the monitor is connected correctly according to the installation procedures in Connecting the Monitor on page 2-3 .
The people at the far site cannot see you.	The privacy shutter is closed	Open the privacy shutter.

Symptom	Cause	Solution
No audio in a call.	The far site is muted.	Look for the far site Mute icon. Ask the far site to unmute the microphone. Note: The far site's microphone may be muted even if you do not see a far site Mute icon.
	The volume may be turned all the way down.	Use the remote control to turn up the volume.
	The far site's microphones are not placed correctly. (Far-site systems with separate microphones only.)	Ensure that each person who speaks is facing a microphone and is close enough to it.
	The far site's microphone is not connected or does not have power. (Far-site systems with separate microphones only.)	Ask the far site to check the cable to the microphone.
	Too many line errors	Try the call again later.
No audio in a call.	The volume is turned all the way down on the monitor or external audio system.	Check the monitor's or external audio system's volume setting. Then check the system's audio output using the Speaker Test screen under Diagnostics > Audio . You should hear a 400 Hz tone.
	The monitor's audio inputs are not connected properly	Check audio output using the Speaker Test screen under Diagnostics > Audio . You should hear a 400 Hz tone. Ask someone at the far site to speak into the microphone, and check the Far Site Audio meter on the Audio Meter screen under Diagnostics > Audio to determine whether your system is receiving audio.
	The system's audio outputs are not connected properly.	Check the system's audio connections to the monitor. Verify that the system is connected to the correct audio connectors on the monitor.

Symptom	Cause	Solution
The people at the far site cannot hear you.	The people at your site are too far from the system's microphone.	Move closer to the system.
	Your system's microphone is muted.	Check your system for one or more of these mute indications: <ul style="list-style-type: none"> Near site mute icon on the screen System indicator is red To unmute the system, press the  Mute button on the remote control.
	System's microphone does not work	Contact your Polycom reseller.
The headphones do not operate properly.	The headphone cable connector is not fully seated.	Connect the headphone cable, making sure it is fully seated.

Minor Issues

The issues in this table do not prevent meaningful communication, but detract from the videoconference experience.

Symptom	Cause	Solution
Picture is blank on the main monitor.	The system goes to "sleep" after a period of inactivity.	Pick up the remote control to wake up the system.
Picture freezes frequently during an IP call.	There is too much traffic on the LAN. Check the error count on the Call Statistics screen.	Go to Admin Settings > Network > IP Network > Quality of Service and enable dynamic bandwidth.
Picture freezes frequently during an ISDN call.	Too many network line transmission errors. Check the error count on the Diagnostics > Call Statistics screen to verify this.	Try the call again.
	Network interface cable may be bad.	Replace the cable.
Picture is slow or jerky.	Only one 64 Kbps channel is connecting in your call.	Check the ISDN number of the far site. Ask the far site to call your site.
	The system is receiving video that includes a large amount of motion.	A background with less motion provides a better, smoother video picture.
	Too many network line transmission errors. Check the error count on the Diagnostics > Call Statistics screen to verify this.	Try the call again.
No picture in the PIP window	The lens cover is closed.	Open the lens cover.

Symptom	Cause	Solution
Not enough volume during a call.	The volume is set too low on the system.	Turn up the volume using the remote control.
	The volume is set too low on the monitor.	Turn up the volume on your monitor.
	The people at the far site are too far from the microphone.	Ask the people at the far site to move closer to the microphone.
Sound effects too loud or too soft.	The sound effects volume is not set at desired level.	Adjust the sound effects volume on the Audio Settings screen. If you do not want to hear sound effects, set the volume to 0.
You hear the incoming call ring when you have set sound effects volume to 0.	The internal ringer is enabled.	On the Audio Settings screen, clear the Enable Internal Ringer option.
Incoming call ring is too loud or too soft.	The sound effects volume is not set at desired level.	Adjust the sound effects volume on the Audio Settings screen. If you do not want to hear sound effects, set the volume to 0.
You can hear yourself on your system's monitor.	The far site microphone is too close to the system's audio speaker. (Far-site systems with separate microphones only.)	At the far site, make sure the microphone is placed away from the system's audio speaker.
	The far site audio volume may be too loud.	Turn down the audio volume at the far site.
Cannot enter the Admin Settings screen.	The system requires a password.	Enter the password.
Low battery icon on the screen.	Low batteries in the remote control.	Replace the batteries in the remote control with 3 AAA batteries.

Symptom	Cause	Solution
Cannot access the system from the V500 web interface.	Web access is not enabled.	Go to Admin Settings > General Settings > Security and enable web access.
	DHCP Client is ON and no DHCP server is available.	Contact your network service provider.
	The LAN cable is not connected.	Connect the LAN cable to the LAN port on the rear of the system. Check the LAN cable to your computer.
	Bad LAN cable.	Check the lights on the system. There should be a steady green light indicating a connection to the LAN, and a flashing orange light indicating LAN traffic.
	DHCP Client is ON and no DHCP server is available.	Contact your network service provider.
	There is a firewall between your PC and your system.	Consult your network service provider.
	Your PC is on a different subnet and there is a router between you and your system.	Place the PC and the V500 system on the same subnet. If this corrects the problem, check your router configuration. If it does not, contact your network service provider.
System does not allow management via the V500 web interface.	Wrong password.	Enter the correct user name and password. NOTE: The default user name is admin , and the default password is the unit's serial number.
	Too many managers are logged into the system.	Only five system managers are allowed at any one time. To log everyone out, restart your system.
The monitor displays an error icon during an ISDN call.	The system has received more than the acceptable number of CRC errors or FEC errors within one second.	Retry the call if the video or audio quality becomes unacceptable to the call participants.
The monitor displays an error icon during an IP call.	The system has detected packet loss above the acceptable level set for the system.	Retry the call if the video or audio quality becomes unacceptable to the call participants.

Normal System Behaviors

Symptom	Cause	Solution
Screen is blank; start music plays and the logo appears briefly. The light on the front of the V500 system blinks.	The system is starting.	This is normal.
The monitor goes blank after displaying the splash screen.	The system is sleeping.	System is in power save sleep mode. The system wakes up on any action from the remote control or on an incoming call.

How to Contact Technical Support

If you are not able to make test calls successfully and you have verified that the equipment is installed and set up correctly, contact Polycom Technical Support by telephone or Internet as described below.

By Telephone

Before calling Polycom Technical Support, please have the following information ready. We also suggest that you go to **System > System Information** so that you will have the System Information screen showing when you call for help.

- Description of the issue – What is happening or not happening, and any related events you may be able to notice.
- The 14-digit serial number on the bottom of the system.

Contact Polycom Technical Support at 1-800-POLYCOM.

By Internet

To contact Polycom Technical Support, go to www.polycom.com/support.

Enter the following information, then ask a question or describe the problem. This information helps us to respond faster to your issue:

- The 14-digit serial number in the System Information screen (also present on the bottom of the system)
- The software version (go to **System > System Information**)
- Information about your network
- Troubleshooting steps you have already tried

Appendix

This appendix provides the following technical details about the V500 system:

- Cable Descriptions
- Cable Drawings
- Q.850 Cause Codes

Cable Descriptions

The following table gives information about the cables shipped with the system. Drawings for these cables are included in this appendix.

Cable	Maximum Approved Length	Part Number Shipped
LAN cable Orange RJ-45	100 ft (30 m)	2457-08343-001 12 ft (3.6 m)
Composite video cable Triple RCA with S-video		2457-08674-001 6 ft (1.8m)

If you have the ISDN option, you can also attach a BRI cable. The part number for this cable is 2457-08717-001 and the length is 20 ft.

Cable Drawings

The following cables are provided with V500 systems:

- LAN cable
- Composite video cable

Their pin-outs are shown in the following drawings.

LAN Cable

WIRING COLOR CODE STANDARDS: (WIRE/STRIPE)

P1	P2	PIN #	PIN #	AT&T 258A/268B
1	1	1	1	WHITE/ORANGE
2	2	2	2	ORANGE/WHITE
3	3	3	3	WHITE/GREEN
4	4	4	4	BLUE/WHITE
5	5	5	5	WHITE/BLUE
6	6	6	6	GREEN/WHITE
7	7	7	7	WHITE/BROWN
8	8	8	8	BROWN/WHITE

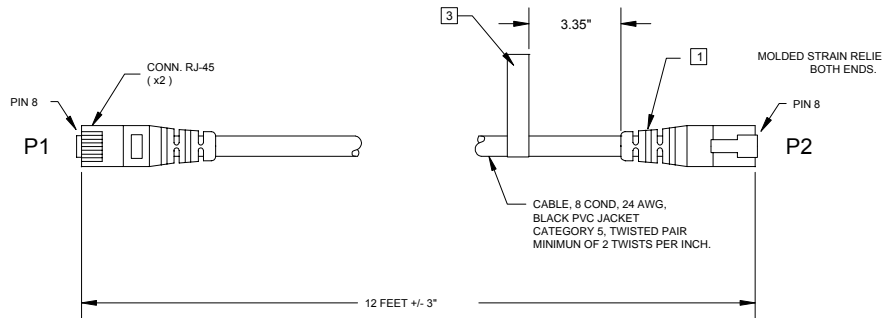

NOTES: (UNLESS OTHERWISE SPECIFIED).

- 1 MOLDING MATERIAL: PVC UL94 V-0
COLOR: ORANGE, APPROXIMATE MATCH TO PANTONE #1665 U.
2. APPROVED VENDOR: PAN INTERNATIONAL ELECTRONICS (THAILAND) CO. LTD. (66-2) 5293549-50.
PAN INTERNATIONAL DETAILED SPEC IS IN THE PART FILE.
- 3 THE BARCODE CONTAINS LAST 8 DIGIT OF CABLE PART NUMBER (REMOVE VV2457).
LABEL SPEC : LASER LABEL
SIZE : LABEL SIZE (12 X 76mm)

LAN Cable 2457-08343-001

Composite Video Cable

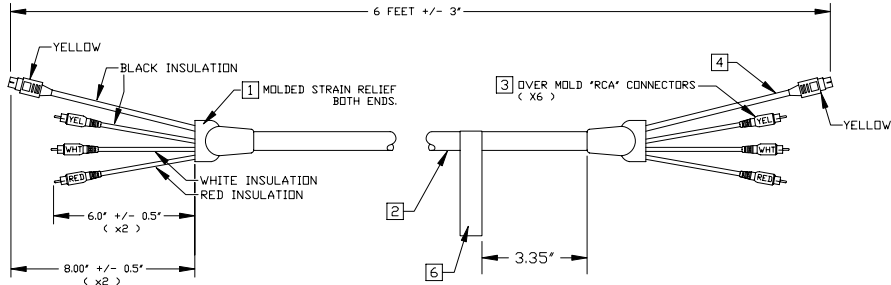

NOTES: (UNLESS OTHERWISE SPECIFIED).

- 1 MOLDING MATERIAL: PVC UL94 V-0
COLOR: BLACK
- 2 CABLE: COMPOSITE, ROUND MADE UP OF 3 COAXIAL-MINIATURE 75 ohm, 30 AWG, CELLULAR POLYOLEFIN, 90% TINNED COPPER SHIELD, CABLES WITH FILLER FOR ROUNDNESS, JACKET COLOR BLACK, MATTE FINISH.
- 3 OVER MOLDED CABLE END COLORS:
RED = APPROXIMATE MATCH TO PANTONE #199C.
WHT = WHITE (PANTONE DOES NOT HAVE SAMPLE).
YEL = APPROXIMATE MATCH TO PANTONE #109C.
- 4 ALTERNATE CABLE CONSTRUCTION FOR S-VIDEED LEAD IS NON-JACKETED CABLE WITH 2 INDIVIDUAL COAX CABLES.
- 5 APPROVED VENDOR: PAN INTERNATIONAL ELECTRONICS (THAILAND) CO, LTD. (66-2) 5293549-50.
PAN INTERNATIONAL DETAILED SPEC IS IN THE PART FILE.
- 6 THE BARCODE CONTAINS LAST 8 DIGIT OF CABLE PART NUMBER (REMOVE VV2457).
LABEL SPEC : LASER LABEL
SIZE : LABEL SIZE (12 X 76mm)

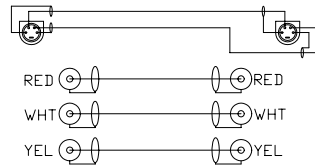

WIRING DIAGRAM

Composite Video Cable 2457-08674-001

Q.850 Cause Codes

The following table describes codes that the ISDN switch sends to the V500 system to indicate call status. Although the codes are standardized, each ISDN service provider defines them differently. Because of this, the definitions in the table may not exactly match the messages that you see.

Code	Cause	Definition
1	Unassigned number	The switch received the sent ISDN number in the correct format, but no destination equipment uses the number.
2	No route to specified transit network	The ISDN exchange does not recognize the intermediate network through which to route the call.
3	No route to destination	The intermediate network through which the call is routed does not serve the destination address.
6	Channel unacceptable	The specified channel does not provide adequate service quality to accept the requested connection.
7	Call awarded and delivered	The user is assigned an incoming call that is being connected to a call channel that has already been established for this user and this type of call.
16	Normal call clearing	The originator or receiver of the call has requested that it be cleared.
17	User busy	All B channels are in use; the called system acknowledges the connection request, but is unable to accept the call.
18	No user responding	The destination equipment does not respond to the call, so the connection cannot be completed.
19	No answer from user (user alerted)	The destination equipment did not complete the connection within the prescribed time after responding to the connection request. The problem is at the remote end of the connection.
21	Call rejected	The destination equipment is capable of accepting the call, but has rejected it for an unknown reason.
22	Number changed	The ISDN number used to set up the call is no longer valid. (The diagnostic field of the message may return an alternate address assigned to the called equipment.)
26	Non-selected user clearing	The destination is capable of accepting the call, but did not assign it to the user.
27	Destination out of order	A signaling message cannot be delivered because the interface is not functioning correctly, and the destination cannot be reached. This condition might be temporary; for example, remote equipment might be turned off.

Code	Cause	Definition
28	Invalid number format	Destination address was incomplete or presented in an unrecognizable format, which prevented the connection from being established.
29	Facility rejected	The network cannot provide the facility requested by the user.
30	Response to STATUS INQUIRY	The equipment returns this message when it receives a STATUS INQUIRY message.
31	Normal, unspecified	A normal event has occurred with no standard cause applying. No resulting action is required.
34	No circuit/channel available	The call cannot be taken because no appropriate channel is available to establish the connection.
38	Network out of order	A network problem prevented the call from reaching its destination. Attempts to reconnect will probably fail until the network problem is corrected.
41	Temporary failure	A network error occurred. The problem will be resolved shortly. Attempts to reconnect may succeed.
42	Switching equipment congestion	The destination cannot be reached because the network switching equipment is temporarily overloaded.
43	Access information discarded	The requested access information cannot be provided by the network. The diagnostic message may explain the problem.
44	Requested circuit/channel not available	The remote equipment cannot provide the requested channel. This may be temporary.
47	Resource unavailable, unspecified	An unknown problem prevents the remote equipment from providing the requested resource.
49	Quality of service unavailable	The network cannot provide the requested quality of service (as defined by CCITT recommendation X.213). This may be a subscription problem.
50	Requested facility not subscribed	The remote equipment is capable of providing the requested supplementary service, but is not subscribed to it.
57	Bearer capability not authorized	The caller has requested a bearer capability that the network can provide, but the user is not authorized to use. This may be a subscription problem.
58	Bearer capability not presently available	The network normally provides the requested bearer capability, but cannot provide it now. This may be a temporary network problem or a subscription problem.
63	Service or option not available, unspecified	An unspecified problem prevents the network or remote equipment from providing the requested service or option. This might be a subscription problem.

Code	Cause	Definition
65	Bearer capability not implemented	The network is not capable of providing the bearer capability requested by the user.
66	Channel type not implemented	The requested channel type is not supported by the equipment sending this code.
69	Requested facility not implemented	The remote equipment is not capable of providing the requested supplementary service.
70	Only restricted digital information bearer is available	The network is unable to provide unrestricted digital information over bearer capability.
79	Service or option not available, unspecified	The network or remote equipment is unable to provide the requested service option for an unspecified reason. This might be a subscription problem.
81	Invalid call reference value	The remote equipment received a call with a call reference that is not currently in use on the user-network interface.
82	Identified channel does not exist	The receiving equipment is requested to use a channel that is not activated on the interface for calls.
83	A suspended call exists but this call identity does not	The network received a call resume request that contained a call identity information element that does not match any suspended call.
84	Call identity in use	The network received a call suspend request that contained a call identity information element for a call that is already suspended.
85	No call suspended	The network received a call resume request when there was not a suspended call pending. This might be a transient error that will be resolved by successive call retries.
86	Call having requested call identity has been cleared	The network received a call resume request containing a call identity information element for a call that was cleared while suspended, either by timeout or by the remote user.
88	Incompatible destination	Indicates that an attempt was made to connect to non-ISDN equipment, such as an analog line.
91	Invalid transit network specified	The ISDN exchange was asked to route the call through an unrecognized intermediate network.
95	Invalid message, unspecified	An invalid message was received, for an unknown reason. This is usually due to a D-channel error. If this error occurs systematically, report it to your ISDN service provider.
96	Mandatory information element is missing	The equipment received a message that did not include one of the mandatory information elements. This is usually due to a D-channel error. If this error occurs systematically, report it to your ISDN service provider.

Code	Cause	Definition
97	Message type nonexistent or not implemented	The equipment received a message of a type that is invalid or not supported. This code indicates either a problem with the remote configuration or a problem with the local D channel.
98	Message incompatible with call state or message type nonexistent	The equipment received a message that is not valid in the current call state. Cause 98 is usually due to a D-channel error. If this error occurs systematically, report it to your ISDN service provider.
99	Information element nonexistent or not implemented	The equipment received a message that includes information elements which were not recognized. This is usually due to a D-channel error. If this error occurs systematically, report it to your ISDN service provider.
100	Invalid information element contents	The equipment received a message that includes invalid information in the information element. This is usually due to a D-channel error.
101	Message not compatible with call state	The remote equipment received a message that does not correspond to the current state of the connection. This is usually due to a D-channel error.
102	Recovery on timer expiry	A time-out has triggered an error-handling (recovery) procedure. This problem is typically temporary.
111	Protocol error, unspecified	An unspecified D-channel error when no other standard cause applies.
127	Interworking, unspecified	An event occurred within a network that does not provide causes for the action that it takes. The precise problem is unknown.
145	ISDN layer 1 and/or 2 link not established	User needs to check cabling, ISDN adapter status and network connections.
146	ISDN layer 3 connection to the ISDN switch/network inactive	There is either a switch protocol error, or (in the United States or Canada) a SPID assignment problem.
255	ISDN command processing error	The ISDN signaling code has encountered an error processing an ISDN action. ISDN adapter busy-wait and retry.

Safety and Legal Notices

Important Safeguards

Read and understand the following instructions before using the system:

- Close supervision is necessary when the system is used by or near children. Do not leave unattended while in use.
- Only use electrical extension cords with a current rating at least equal to that of the system.
- Always disconnect the system from power before cleaning and servicing and when not in use.
- Do not spray liquids directly onto the system when cleaning. Always apply the liquid first to a static free cloth.
- Do not immerse the system in any liquid or place any liquids on it.
- Do not disassemble this system. To reduce the risk of shock and to maintain the warranty on the system, a qualified technician must perform service or repair work.
- Connect this appliance to a grounded outlet.
- Only connect the system to surge protected power outlets.
- Keep ventilation openings free of any obstructions.
- SAVE THESE INSTRUCTIONS.

License Restrictions

THE SOFTWARE PROGRAMS CONTAINED OR DESCRIBED HEREIN ARE CONFIDENTIAL INFORMATION AND PROPRIETARY PRODUCTS OF POLYCOM, INC. OR ITS LICENSORS.

Buyer shall not sublicense or otherwise distribute any of the Subject Programs except to End Users and/or resellers who have entered into a Sublicense Agreement. For purposes of this Agreement a "Sublicense Agreement" shall mean a written license agreement between the Buyer and its purchaser, or, in the case of any sale by Buyer to a reseller, between such reseller and the End User, that is either 1) signed by the End User or 2) included with the Documentation, in such a manner that the End User reasonably indicates its acceptance of the Sublicense Agreement by turning on and using the Computer Equipment. Polycom, Inc. shall include so-called "break the seal software licenses" with the Documentation, and Buyer shall not remove or alter any such Sublicense Agreements or any notifications or warning stickers relating thereto. Buyer shall not waive, amend, or otherwise modify any Sublicense Agreement without Polycom's prior consent.

Title to all Subject Programs shall at all times remain and vest solely with Polycom, Inc. and its licensors. Buyer acknowledges Polycom's claim that the Subject Programs are its trade secret and confidential property, and shall treat them as such. Buyer will not attempt to disassemble, decompile, reverse-engineer or otherwise endeavor to discover or disclose the methods and concepts embodied in the Subject Programs. Except as expressly allowed under this Agreement, the Buyer shall not copy, modify, transcribe, store, translate, sell, lease, or otherwise transfer or distribute any of the Subject Programs in whole or in part, without prior authorization, in writing, from Polycom, Inc. Buyer shall not remove or destroy any copyright, patent, trademark or other proprietary mark or notice on Computer Equipment, and shall reproduce any such marks on any copies of Subject Programs that it makes hereunder.

You shall not, and shall not allow, any third party to 1) decompile, disassemble, or otherwise reverse-engineer or attempt to reconstruct or discover any source code or underlying ideas or algorithms of the software by any means whatsoever or 2) remove any product.

Warranty

Polycom, Inc. warrants its products to be free of defects in materials and factory workmanship for a period of twelve (12) months from date of purchase. This warranty does not apply to damage to products resulting from accident, misuse, service or modification by anyone other than a Polycom, Inc. authorized service facility/dealer. The warranty is limited to the original purchaser and is not transferable. Any liability of Polycom, Inc. or its suppliers with respect to the product or the performance thereof under any warranty, negligence, strict liability or other theory will be limited exclusively to product repair or replacement as provided above. Except for the foregoing, the product is provided "as is" without warranty of any kind including without limitation, any warranty of merchantability or fitness for a particular purpose. The entire risk of the quality and performance of the software programs contained in the system is with you.

Limitation of Remedies and Damages

Polycom, Inc., its agents, employees, suppliers, dealers and other authorized representatives shall not be responsible or liable with respect to the product or any other subject matter related thereto under any contract, negligence, strict liability or other theory for any indirect, incidental, or consequential damages, including, but not limited to loss of information, business, or profits.

The law of certain states or nations does not permit limitation or exclusion of implied warranties and consequential damages, so the above limitations, disclaimers, or exclusion may not apply to you. This warranty gives you special legal rights. You may also have other rights that vary by state and nation.

Warning

This is a Class A product. In a domestic environment, this product may cause radio interference in which case the user may be required to take adequate measures.

USA and Canadian Regulatory Notices

FCC Notice

Class A Digital Device or Peripheral

This equipment has been tested and found to comply with the limits for a Class A digital device, pursuant to Part 15 of the FCC Rules. These limits are designed to provide reasonable protection against harmful interference when the equipment is operated in a commercial environment. This equipment generates, uses, and can radiate radio frequency energy and, if not installed and used in accordance with the instruction manual, may cause harmful interference to radio communications. Operation of this equipment in a residential area is likely to cause harmful interference in which case the user will be required to correct the interference at his own expense.

In accordance with Part 15 of the FCC rules, the user is cautioned that any changes or modifications not expressly approved by Polycom Inc. could void the user's authority to operate this equipment.

The socket outlet to which this apparatus is connected must be installed near the equipment and must always be readily accessible.

Part 15 FCC Rules

This device complies with part 15 of the FCC rules. Operation is subject to the following two conditions:

- 1) This device may not cause harmful interference, and
- 2) this device must accept any interference received, including interference that may cause undesired operation.

Part 68 FCC Rules

This equipment complies with part 68 of the FCC rules and the rules adopted by the ACTA. On this equipment is a label that contains, among other information, a product identifier in the format US:AAAEQ#TXXX system. If requested, this number must be provided to the telephone company.

This equipment may not be used on a coin service or party line.

If you experience trouble with your V500 System, disconnect it from the telephone line to determine if the registered equipment is malfunctioning. For repair or warranty information, please contact Polycom Inc. at 1-888-248-4143 or 4750 Willow Road, Pleasanton, CA 94588-2708, USA. Contact information may also be found at <http://www.polycom.com>. If the system is causing harm to the network, the telephone company may request that you disconnect it until the problem is corrected.

If your V500 System causes harm to the telephone network, the telephone company will notify you in advance that temporary discontinuance of service may be required. However, if advance notice is not practical, you will be notified as soon as possible. You will be advised of your right to file a complaint with the FCC if you believe it is necessary.

Your telephone company may make changes in its facilities, equipment, operations, or procedures that could affect the operation of your equipment. If they do, you will be given advance notice so that you may make any changes necessary to maintain uninterrupted service.

The REN is useful to determine the quantity of devices that may be connected to the telephone line. Excessive RENs on the telephone line may result in the devices not ringing in response to an incoming call. In most, but not all areas, the sum of RENs of all devices that may be connected to a line, is determined by the total RENs, contact the local telephone company.

FCC compliant telephone cords and modular plugs are provided with this equipment. This equipment is designed to be connected to the telephone network or premises' wiring using a compatible modular jack, which is Part 68 compliant. See installation instructions for details.

WHEN PROGRAMMING EMERGENCY NUMBERS AND/OR MAKING TEST CALLS TO EMERGENCY NUMBERS:

- 1) Remain on the line and briefly explain to the dispatcher the reason for the call.
- 2) Perform such activities in the off-peak hours, such as early morning or late evening.

Industry Canada (IC)

This Class [A] digital apparatus complies with Canadian ICES-003.

Cet appareil numérique de la Classe [A] est conforme à la norme NMB-003 du Canada.

The Industry Canada label identifies certified equipment. This certification means that the equipment meets telecommunications network protective, operational and safety requirements as prescribed in the appropriate Terminal Equipment Technical Requirements document(s). The Department does not guarantee the equipment will operate to the user's satisfaction.

Before installing this equipment, users should ensure that it is permissible to be connected to the facilities of the local telecommunications company. The equipment must also be installed using an acceptable method of connection. The customer should be aware that compliance with the above conditions may not prevent degradation of service in some situations. Repairs to certified equipment should be coordinated by a representative designated by the supplier. Any repairs or alterations made by the user to this equipment, or equipment malfunctions, may give the telecommunications company cause to request the user to disconnect the equipment.

Users should ensure for their own protection that the electrical ground connections of the power utility, telephone lines and internal metallic water pipe system, if present, are connected together. This precaution may be particularly important in rural areas.

Caution: Users should not attempt to make such connections themselves, but should contact the appropriate electric inspection authority, or electrician, as appropriate.

The Ringer Equivalence Number (REN) assigned to each relevant terminal device provides an indication of the maximum number of terminals allowed to be connected to a telephone interface. The termination on an interface may consist of any combination of devices subject only to the requirement that the sum of the RENs of all the devices does not exceed 5.

The REN of this equipment is either marked on the unit or included in the new style USA FCC registration number. In the case that the REN is included in the FCC number, the user should use the following key to determine the value:

- The FCC number is formatted as US:AAAEQ#TXXX.
- # is the Ringer Equivalence Number without a decimal point (e.g. REN of 1.0 will be shown as 10, REN of 0.3 will be shown as 03). In the case of a Z ringer, ZZ shall appear. In the case of approved equipment without a network interface or equipment not to be connected to circuits with analog ringing supplied, NA shall appear.

EEA Regulatory Notices

CE Mark R & TTE Directive

This V500 System has been marked with the CE mark. This mark indicates compliance with EEC Directives 89/336/EEC, 73/23/EEC 1999/5/EC. A full copy of the Declaration of Conformity can be obtained from Polycom Ltd., 270 Bath Road, Slough UK SL1 4DX.

Declaration of Conformity:

Hereby, Polycom Ltd. declares that this V500 System is in compliance with the essential requirements and other relevant provisions of Directive 1999/5/EC.

Konformitetserklæring:

Hermed erklærer Polycom Ltd., at indestående V500 System er i overensstemmelse med de grundlæggende krav og de relevante punkter i direktiv 1999/5/EF.

Konformitätserklärung:

Hiermit erklärt Polycom Ltd., dass der V500 System die grundlegenden Anforderungen und sonstige maßgebliche Bestimmungen der Richtlinie 1999/5/EG erfüllt.

Δήλωση Συμμόρφωσης:

Δια του παρόντος, η εταιρεία Polycom Ltd. δηλώνει ότι η παρούσα συσκευή (δρομολογητής) V500; πληροί τις βασικές απαιτήσεις και άλλες βασικές προϋποθέσεις της Οδηγίας 1999/5/EK.

Vaatimustenmukaisuusvakuutus:

Polycom Ltd. vakuuttaa täten, että V500 System on direktiivin 1999/5/EC keskeisten vaatimusten ja sen muiden tätä koskevien säännösten mukainen.

Déclaration de conformité:

Par la présente, Polycom Ltd. déclare que ce V500 System est conforme aux conditions essentielles et à toute autre modalité pertinente de la Directive 1999/5/CE.

Dichiarazione di conformità:

Con la presente Polycom Ltd. dichiara che il V500 System soddisfa i requisiti essenziali e le altre disposizioni pertinenti della direttiva 1999/5/CE.

Verklaring van overeenstemming:

Hierbij verklaart Polycom Ltd. dat diens V500 System voldoet aan de basisvereisten en andere relevante voorwaarden van EG-richtlijn 1999/5/EG.

Declaração de Conformidade:

Através da presente, a Polycom Ltd. declara que este V500 System se encontra em conformidade com os requisitos essenciais e outras disposições relevantes da Directiva 1999/5/CE.

Declaración de conformidad:

Por la presente declaración, Polycom Ltd. declara que este V500 System cumple los requisitos esenciales y otras cláusulas importantes de la directiva 1999/5/CE.

Överensstämmelseförklaring:

Polycom Ltd. förklarar härmed att denna V500 System överensstämmer med de väsentliga kraven och övriga relevanta stadganden i direktiv 1999/5/EG.

CE Mark LVD and EMC Directive

This V500 System has been marked with the CE mark. This mark indicates compliance with EEC Directives 89/336/EEC and 73/23/EEC. A full copy of the Declaration of Conformity can be obtained from Polycom Ltd., 270 Bath Road, Slough UK SL1 4DX, UK.

Mains Powered POTS Voice Telephony Without Emergency 000 Dialing

Warning: This equipment will be inoperable when mains power fails.

この装置は、情報処理装置等電波障害自主規制協議会（VCCI）の基準に基づくクラス A 情報技術装置です。この装置を家庭環境で使用すると電波妨害を引き起こすことがあります。この場合には使用者が適切な対策を講ずるよう要求されることがあります。

声 明

此为 A 级产品，在生活环境中，该产品可能会造成无线电干扰。在这种情况下，可能需要用户对其干扰采取切实可行的措施。

A급 기기 (가정용 정보통신기기)

이 기기는 가정용으로 전자파적합등록을 한 기기로서
주거지역에서는 물론 모든 지역에서 사용할 수 있습니다.

Underwriters Laboratories Statement

The system is intended to be powered only by the supplied power supply unit.

Special Safety Instructions

Follow existing safety instructions and observe all safeguards as directed.

Installation Instructions

Installation must be performed in accordance with all relevant national wiring rules.

Plug Acts as Disconnect Device

The socket outlet to which this apparatus is connected must be installed near the equipment and must always be readily accessible.

A

- access levels
 - administrators 4-2
 - advanced users 4-2
 - new users 4-2
- account number 5-6
- address
 - gatekeeper 3-7
 - IP 3-4
- administrator password
 - configuring 4-14
 - resetting 4-3
 - screens that require 4-3
 - setting 4-2
 - setting with Setup Wizard 3-3
- AES encryption, *See* encryption
- alert tones 4-10, 4-21
- allowing
 - IP calls 3-4, 3-6
 - ISDN calls 3-13, 3-14
- answering mode 4-13
- area code, setting 4-15
- audio
 - Audio Meter test 7-5
 - configuring 4-10
 - confirmation, keypad 4-12
 - data rate 6-3, 6-5
 - diagnostic tools 7-5
 - protocol 6-3
 - quality 1-2
 - sound effects volume 4-10
 - volume 4-10
 - volume on external system 4-10
- Audio Meter screen 7-5
- Audio Meter test 7-5
- auto-answer
 - muting 4-10
 - point to point 4-11
- auto-detecting
 - ISDN connectivity 3-13
 - SPIDs 3-14

B

- backlight compensation 4-6
- bandwidth
 - dynamic 3-10
 - managing 3-7, 3-15
- bass adjustment 4-10
- BRI network interface
 - configuring 3-13
 - connecting 2-6
 - lights 7-7
- brightness, of camera 4-6
- browser requirements 3-3

C

- cable
 - composite video 1-5, 2-3
 - descriptions Appendix-1
 - drawings Appendix-2
 - ISDN BRI 2-6
 - LAN 1-5, 2-3
 - monitor 1-5
 - power 2-4
 - S-video 1-5
- call
 - answering mode 4-13
 - Call Statistics screen 7-4
 - Call Status screen 7-4
 - choosing call preferences 3-14
 - number of 6-2
 - preferences 3-15
 - progress indicators 6-4
 - quality 4-18
 - recent 6-5
 - speed 3-5, 3-15, 6-3
 - speed, maximum 3-15
 - speed, optimizing 3-7
 - statistics 6-3
 - status 6-4
 - status tools 7-3
 - summary 6-2
 - test 3-17
 - time, maximum 4-5
 - tracking 5-6
 - type 6-3

- Call Detail Report (CDR)
 - account numbers 5-6
 - archives 6-9
 - features 1-4
 - generating 4-11, 4-18
 - information in 6-6
 - screen 7-4
 - viewing and downloading 6-6
 - viewing recent calls 6-5
 - Call Detail Report screen 7-4, 7-5
 - Call Statistics screen 7-4
 - Call Summary screen 7-3
 - camera
 - configuring settings 4-6
 - setting brightness 4-6
 - cause codes, Q.850 Appendix-4
 - closed captions
 - audio options 4-22
 - displaying 4-22
 - Telnet session connection 4-24
 - V500 web interface connection 4-23
 - Color Bar test 7-5
 - color schemes 4-21
 - composite video cable
 - description 1-5
 - drawing Appendix-3
 - configuring
 - audio 4-10
 - BRI 3-13
 - Dual Monitor Emulation 4-7
 - firewall 3-12
 - monitor 4-7
 - NAT 3-11, 3-12
 - PIP 4-7
 - SNMP 5-8
 - connecting
 - ISDN BRI network interface 2-6
 - LAN 2-3
 - monitor 2-3
 - optional equipment 2-6
 - power 2-4
 - standard equipment 2-2
 - system 2-2
 - connectivity checklist, for network 3-2
 - connector
 - BRI 2-6
 - composite video 2-3
 - LAN 2-4
 - power 2-4
 - S-video 2-3
 - cord, power
 - connecting 2-4
 - description 1-5
 - country code 4-15
 - country selection 4-15
 - customizing
 - Home screen 4-17
 - system behavior 4-5
 - system features 1-2
 - workspace 4-4, 4-16
- ## D
- data rate
 - audio 6-3, 6-5
 - video 6-3, 6-5
 - date, displaying 4-18
 - daylight saving time 4-15
 - diagnostics
 - IP connectivity tools 7-4
 - network and call status tools 7-3
 - reset and restart 7-6
 - video and audio tools 7-5
 - dialing
 - last number dialed 4-19
 - options 4-18
 - prefix, ISDN 3-13
 - rules 3-17
 - speed dialing 4-19
 - DID number 3-8
 - Diffserv 3-10
 - directory
 - allowing access 4-18
 - allowing changes 4-5
 - configuring settings 4-12
 - confirming additions 4-13
 - confirming deletions 4-13
 - features 1-3
 - managing with V500 web interface 5-4
 - server 3-16

- displaying
 - date and time 4-18
 - graphics 4-7
 - icons in a call 4-7
 - system name 4-18
 - time in call 4-11, 4-15
- DNS name 3-4
- DNS server 3-5
- Do Not Disturb 4-13, 4-18
- documentation
 - available resources 4-25
 - description 1-5
- domain name 3-5
- Dual Monitor Emulation
 - description 1-2
 - specifying 4-7
 - using 4-8
- duplex mode 3-5
- dynamic bandwidth 3-10
 - See also* Quality of Service

E

- E.164
 - alias 3-8
 - extension 3-6, 3-7, 3-8
- encryption
 - enabling AES 4-13
 - features 1-3
 - viewing type 6-3
- error icon 7-15
- extension
 - E.164 3-6, 3-7, 3-8
 - H.323 4-18
 - H.323, displaying 3-6
 - H.323, specifying 3-6
 - H.323, specifying for gatekeeper 3-7
 - H.323, specifying for gateway 3-8
- external audio system, volume 4-10

F

- far site
 - system information 6-3
 - system name 4-12
- firewall 3-12
 - See also* NAT and security
- fixed ports 3-11, 3-12

G

- gatekeeper
 - configuring system to use 3-7
 - IP address 3-7
 - name 3-6
 - registering 3-6
 - using 3-7
- gateway
 - configuring system to use 3-8
 - placing call 3-6
 - specifying default 3-5
 - specifying number type 3-8
- Global Address Book, *see* Global Directory
- Global Directory Server 3-16
- Global Directory, features 1-3
- Global Management System™
 - description 5-5
 - management servers list 5-5
 - requesting support from administrator 5-7
 - See also* remote management
- global services, configuring 5-5

H

- H.323
 - displaying extension 3-6
 - name 3-6
 - specifying extension 3-6, 3-7, 3-8
 - specifying for Home screen 4-18
 - specifying name 3-7
 - specifying settings 3-6
- hardware
 - setting up optional 2-6
 - setting up standard 2-2
- headphone 1-6, 2-6
- help
 - from GMS administrator 5-6
 - on-screen 4-20, 4-25
- Home screen
 - adding sites 4-19
 - configuring settings 4-18
 - designing 4-17
 - features 1-2
- host name 3-4

I

- icons
 - displaying 4-7
 - error 7-15
- indicators
 - call progress 6-4
 - network interface 7-7
 - system 7-7
- initial system configuration 3-1, 3-3
- installing
 - features 1-3
 - optional equipment 2-6
 - standard equipment 2-2
 - system 2-1
- instructions, on-screen 4-20
- internal ringer 4-10
- IP
 - address, displaying 4-18
 - address, entering 3-4
 - address, gatekeeper 3-7
 - address, obtaining automatically 3-4
 - address, static 3-4
 - calls, allowing 3-4, 3-6
 - configuring network support 3-6
 - connectivity tools 7-4
 - dynamic address 3-4
 - precedence 3-10
 - See also* LAN
- ISDN
 - calls, allowing 3-13, 3-14
 - configuring network interface 3-13
 - configuring support 3-13
 - connectivity, auto-detecting 3-13
 - dialing rules 3-17
 - installing BRI network interface 2-6
 - international access code 4-15
 - Q.850 cause codes Appendix-4
 - SPIDs 3-14
 - switch protocol 3-13, 3-14
 - voice algorithm 3-13

J

- jitter 6-3, 6-5

K

- keypad
 - audio confirmation 4-12
 - remote control 4-12
- kiosk mode
 - description 4-5
 - managing user access 4-2, 4-17

L

- LAN
 - cable 1-5
 - cable, drawing Appendix-2
 - choosing speed 3-5
 - connecting 2-3, 2-4
 - properties, configuring 3-4
 - See also* IP
- language selection 4-15
- last number dialed 4-19
- lights
 - indicator 7-7
 - network interface 7-7
 - system 7-7
- location settings
 - area code/city code 4-15
 - country 4-15
 - country code 4-15
 - daylight saving time 4-15
 - language 4-15
 - time difference from GMT 4-15

M

- management servers list 5-5
- managing
 - bandwidth 3-7, 3-15
 - system remotely 5-1
- marquee text 4-20
- master audio volume 4-10
- meeting password 4-14
- MIBs, downloading 5-8
- monitor
 - cable 1-5
 - cable, drawing Appendix-3
 - configuring 4-7
 - connecting 2-3
- muting, auto-answer calls 4-4, 4-10
- My Contacts list 4-19

N

- name
 - DNS 3-4
 - far-site system 4-12
 - H.323 3-6, 3-7
 - host 3-4
 - system 4-12, 4-18
- NAT 3-11, 3-12
 - See also* firewall
- Near End Loop screen 7-4
- Near End Loop test 7-4
- network
 - configuring use of 3-1
 - connecting to ISDN 2-6
 - connecting to LAN 2-4
 - connectivity checklist 3-2
 - diagnostic tools 7-3
 - getting ready 3-2
 - interface lights 7-7
- Network Address Translation, *See* NAT
- network interface
 - BRI 2-6, 7-7
 - lights 7-7
- NT-1 device 2-6

O

- on-screen instructions 4-20
- optional equipment
 - BRI network interface 2-6
 - headphone 2-6
- outbound call route 3-7
- out-of-box setup 3-1, 3-3

P

- packet loss 6-3
- password
 - administrator 4-2, 4-14
 - administrator, forgetting 3-3
 - Global Directory 3-16
 - meeting 4-14
 - setting 4-14
- PBX 2-6
- PING screen 7-4
- PING test 7-4
- PIP, configuring 4-7

- point to point
 - auto-answer calls 4-4
 - call answer mode 4-13
- ports
 - fixed 3-11, 3-12
 - TCP 3-11
 - UDP 3-11
- positioning, system 2-2
- power
 - connecting 2-4
 - resetting system 7-6
 - restarting system 7-6
 - supply, auto-sensing 1-3
 - supply, description 1-5
 - switch 2-5
- power supply, *See* power
- preferences, call 3-14
- preventing security issues 3-12
- problems, *See* troubleshooting
- profile
 - managing 5-3
 - storing 5-3
 - uploading 5-3
- protocol
 - audio 6-3
 - ISDN switch 3-13, 3-14
 - video 6-3

Q

- Q.850 cause codes Appendix-4
- quality
 - audio 1-2
 - call 4-18
 - video 1-2, 2-3
- Quality of Service 3-10

R

- recent calls
 - button 4-12, 4-18
 - list 6-5
 - See also* Call Detail Report (CDR)
- registration, gatekeeper 3-6
- remote access, allowing 4-14

- remote control
 - configuring 4-12
 - description 1-5
 - features 1-2
 - installing batteries 2-5
 - keypad configuration 4-12
 - troubleshooting 7-9
- remote management
 - tools 5-1
 - using web browser 5-2
- requirements, web browser 3-3
- reset system 7-6
- Reset System screen 7-6
- restart system 7-6
- ring tones 4-10, 4-21
- ringer, internal 4-10

S

- screen
 - diagnostic 7-3
 - diagram of system 4-3
 - system quick reference 7-2
- screen saver 4-20, 4-21
- security 3-12
 - features 1-3
 - firewall 3-11, 3-12
 - setting options 4-14
- serial number 7-17
- servers
 - directory 3-16
 - DNS 3-5
 - WINS 3-5
- setup wizard
 - description 1-3, 3-1
 - running 3-3
 - using 3-3
- set-up, *See* hardware
- SIP
 - enabling 3-15
 - specifying settings 3-9
- Siren™ 14, description 1-2
- site buttons, adding 4-19
- sleep mode 7-16
- snapshots, timeout 4-7
- SNMP
 - configuring for SNMP management 5-9
 - setting up 5-8

- Softupdate 3-19
- software, upgrading 3-19
- sound effects volume 4-10
- Speaker test 7-5
- Speaker Test screen 7-5
- speed dial 4-19
- speed, call 3-5, 3-15, 6-3
- SPIDs 3-14
- split-screen, *See* Dual Monitor Emulation
- standard equipment
 - LAN 2-3
 - monitor 2-3
 - power 2-4
 - remote control 2-5
- statistics
 - call 6-3
 - Call Statistics screen 7-4
 - system 6-1
- status
 - Call Status screen 7-4
 - network and call diagnostic tools 7-3
 - system 3-18
 - System Status screen 7-3
- subnet mask 3-5
- switch protocol, ISDN 3-13, 3-14
- switch, power 2-5
- system
 - checking status 3-18
 - configuring call settings 4-11
 - designing behavior 4-11
 - displaying name 4-18
 - introduction to 1-1
 - lights 7-7
 - optional components 1-6
 - positioning 2-2
 - screens quick reference 7-2
 - setting up hardware 2-1
 - specifying name 4-12
 - standard components 1-5
- system profiles, managing 5-3
- System Status screen 7-3

T

- technical support
 - contacting 7-17
 - from GMS administrator 5-6, 5-7
 - information to provide 7-17
 - telephone number 7-17
 - web page address 7-17
- test
 - Audio Meter 7-5
 - Color Bar 7-5
 - Near End Loop 7-4
 - PING 7-4
 - Speaker 7-5
- test calls 3-17
- time
 - daylight saving 4-15
 - difference from GMT 4-15
 - displaying 4-18
 - displaying call length 4-11, 4-15
 - screen saver 4-21
 - server 4-15
 - setting 4-15
 - specifying maximum during call 4-11
- tones
 - alert 4-10, 4-21
 - internal ringer 4-10
 - ring 4-10, 4-21
- tools
 - IP connectivity 7-4
 - network and call status 7-3
 - reset and restart 7-6
 - video and audio 7-5
- tracking calls 5-6
- treble adjustment 4-10
- troubleshooting
 - critical problems 7-8
 - general 7-1, 7-8
 - minor issues 7-13
 - moderate issues 7-11
 - normal system behaviors 7-16
 - severe problems 7-9
- TV, *See* monitor

U

- upgrading, software 3-19

- user limitations
 - allow directory changes 4-12
 - managing user access 4-2
 - maximum call speed 3-15
 - maximum call time 4-11
 - removing features 4-18
 - setting 4-5
- user settings
 - allow video display on web 4-4
 - auto-answer point to point 4-4
 - backlight compensation 4-4
 - color schemes 4-4, 4-21
 - Dual Monitor Emulation 4-4
 - far-site name display time 4-4
 - keypad audio confirmation 4-4
 - managing access 4-2
 - meeting password 4-4
 - mute auto-answer calls 4-4
 - PIP adjustment 4-4

V

- V500
 - description 1-5
 - headphone, connecting 2-6
 - illustration 1-1
 - introduction to 1-1
 - ISDN BRI network interface 2-6
 - key features 1-2
 - LAN, connecting to 2-3
 - monitor, connecting 2-3
 - optional components 1-6
 - positioning 2-2
 - power, connecting to 2-4
 - powering on 2-5
 - remote control 2-5
 - setting up hardware 2-1
 - standard components 1-5
- V500 web interface
 - accessing 5-2
 - accessing diagnostic screens 7-3
 - accessing system via 3-3
 - managing directories 5-4
 - managing system profiles 5-3
 - sending message 7-2
 - viewing Call Detail Report 6-6, 7-2, 7-3

video

- cable 1-5
- cable, drawing Appendix-3
- configuring 4-6
- data rate 6-3, 6-5
- diagnostic tools 7-5
- protocol 6-3
- quality 1-2, 2-3

Video screen 7-5

voice algorithm, ISDN 3-13

volume

- bass 4-10
- master control 4-10
- setting 4-10
- setting on external system 4-10
- sound effects 4-10
- treble 4-10

W

web access port 4-14

web browser requirements 3-3

web interface, *See* V500 web interface

web site, for documentation 4-25

WINS name resolution 3-5

WINS server 3-5