



# COLOR MONITOR

SyncMaster 330TFT  
SyncMaster 530TFT  
SyncMaster 331TFT  
SyncMaster 531TFT

# *SERVICE Manual*

## COLOR MONITOR



## CONTENTS

1. Precautions
2. Reference Information
3. Product Specifications
4. Operating Instructions
5. Disassembly & Reassembly
6. Troubleshooting
7. Exploded View & Parts List
8. Block Diagram
9. Electrical Parts List
10. PCB Diagrams
11. Wiring Diagram
12. Schematic Diagrams



Samsung Electronics Co., Ltd. July 1998  
Printed in Korea  
Code No.: BN68-60017A

# 1 Precautions

Follow these safety, servicing and ESD precautions to prevent damage and to protect against potential hazards such as electrical shock.

## 1-1 Safety Precautions

### 1-1-1 Warnings

1. For continued safety, do not attempt to modify the circuit board.
2. Disconnect the AC power and DC Power Jack before servicing.
3. When the chassis is operating, semiconductor heatsinks are potential shock hazards.

### 1-1-2 Servicing the LCD Monitor

1. When servicing the LCD Monitor, remove the static charge by connecting a 10k ohm resistor in series with an insulated wire (such as a test probe) between the chassis and the anode lead. (Disconnect the AC line cord from the AC outlet.)
2. It is essential that service technicians have an accurate voltage meter available at all times. Check the calibration of this meter periodically.

### 1-1-3 Fire and Shock Hazard

Before returning the monitor to the user, perform the following safety checks:

1. Inspect each lead dress to make certain that the leads are not pinched or that hardware is not lodged between the chassis and other metal parts in the monitor.
2. Inspect all protective devices such as nonmetallic control knobs, insulating materials, cabinet backs, adjustment and compartment covers or shields, isolation resistor-capacitor networks, mechanical insulators, etc.
3. Leakage Current Hot Check (Figure 1-1): **WARNING: Do not use an isolation transformer during this test.** Use a leakage current tester or a metering system that complies with American National Standards Institute (*ANSI C101.1, Leakage Current for Appliances*), and Underwriters Laboratories (*UL Publication UL1410, 59.7*).

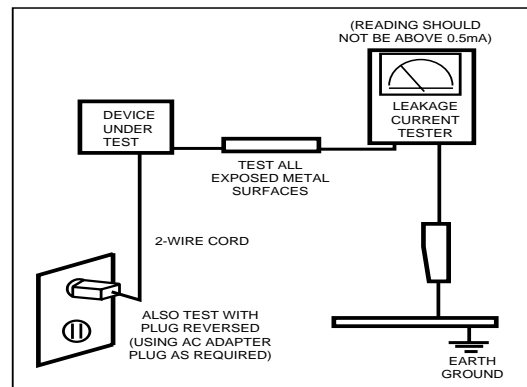



Figure 1-1. Leakage Current Test Circuit

4. With the unit completely reassembled, plug the AC line cord directly into a 120V AC outlet. With the unit's AC switch first in the ON position and then OFF, measure the current between a known earth ground (metal water pipe, conduit, etc.) and all exposed metal parts, including: metal cabinets, screwheads and control shafts. The current measured should not exceed 0.5 milliamp. Reverse the power-plug prongs in the AC outlet and repeat the test.

### 1-1-4 Product Safety Notices

Some electrical and mechanical parts have special safety-related characteristics which are often not evident from visual inspection. The protection they give may not be obtained by replacing them with components rated for higher voltage, wattage, etc. Parts that have special safety characteristics are identified by  on schematics and parts lists. A substitute replacement that does not have the same safety characteristics as the recommended replacement part might create shock, fire and / or other hazards. Product safety is under review continuously and new instructions are issued whenever appropriate.

## 1-2 Servicing Precautions

---

**WARNING:** An electrolytic capacitor installed with the wrong polarity might explode.

**Caution:** Before servicing units covered by this service manual, read and follow the Safety Precautions section of this manual.

**Note:** If unforeseen circumstances create conflict between the following servicing precautions and any of the safety precautions, always follow the safety precautions.

### 1-2-1 General Servicing Precautions

1. Always unplug the unit's AC power cord from the AC power source and disconnect the DC Power Jack before attempting to:
  - (a) remove or reinstall any component or assembly,
  - (b) disconnect PCB plugs or connectors, (c) connect a test component in parallel with an electrolytic capacitor.
2. Some components are raised above the printed circuit board for safety. An insulation tube or tape is sometimes used. The internal wiring is sometimes clamped to prevent contact with thermally hot components. Reinstall all such elements to their original position.
3. After servicing, always check that the screws, components and wiring have been correctly reinstalled. Make sure that the area around the serviced part has not been damaged.
4. Check the insulation between the blades of the AC plug and accessible conductive parts (examples: metal panels, input terminals and earphone jacks).
5. Insulation Checking Procedure: Disconnect the power cord from the AC source and turn the power switch ON. Connect an insulation resistance meter (500 V) to the blades of the AC plug.

The insulation resistance between each blade of the AC plug and accessible conductive parts (see above) should be greater than 1 megohm.
6. Always connect a test instrument's ground lead to the instrument chassis ground *before* connecting the positive lead; always remove the instrument's ground lead last.

## 1-3 Electrostatically Sensitive Devices (ESD) Precautions

---

Some semiconductor (solid state) devices can be easily damaged by static electricity. Such components are commonly called Electrostatically Sensitive Devices (ESD). Examples of typical ESD devices are integrated circuits and some field-effect transistors. The following techniques will reduce the incidence of component damage caused by static electricity.

1. Immediately before handling any semiconductor components or assemblies, drain the electrostatic charge from your body by touching a known earth ground. Alternatively, wear a discharging wrist-strap device. To avoid a shock hazard, be sure to remove the wrist strap before applying power to the monitor.
2. After removing an ESD-equipped assembly, place it on a conductive surface such as aluminum foil to prevent accumulation of an electrostatic charge.
3. Do not use freon-propelled chemicals. These can generate electrical charges sufficient to damage ESDs.
4. Use only a grounded-tip soldering iron to solder or desolder ESDs.
5. Use only an anti-static solder removal device. Some solder removal devices not classified as "anti-static" can generate electrical charges sufficient to damage ESDs.
6. Do not remove a replacement ESD from its protective package until you are ready to install it. Most replacement ESDs are packaged with leads that are electrically shorted together by conductive foam, aluminum foil or other conductive materials.
7. Immediately before removing the protective material from the leads of a replacement ESD, touch the protective material to the chassis or circuit assembly into which the device will be installed.

**Caution:** Be sure no power is applied to the chassis or circuit and observe all other safety precautions.
8. Minimize body motions when handling unpackaged replacement ESDs. Motions such as brushing clothes together, or lifting your foot from a carpeted floor can generate enough static electricity to damage an ESD.



## 2 Reference Information

### 2-1 List of Abbreviations, Symbols and Acronyms

#### 2-1-1 Abbreviations

Abbreviation	Definition	Abbreviation	Definition
AUTO_MENB	AUTO ENABLE (NEG.)	OSCOUT1	24MHz CLOCK
AUTO_SOG	SINK ON GREEN ENABLE	PANEL_EN	+12V_PANEL/+5V_PANEL ENABLE
BL_EN	LCD PANEL BACK LIGHT ENABLE	PC_BLUE_IN	BLUE COLOR SIGNAL FROM PC
BRIGHT	BRIGHTNESS CONTROL	PC_GREEN_IN	GREEN COLOR SIGNAL FROM PC
DAB(7:0)	BLUE COLOR DATA (ODD) FROM IC305	PC_HSYNC_IN	HSYNC FROM PC
DAG(7:0)	GREEN COLOR DATA (ODD) FROM IC305	PC_RED_IN	RED COLOR SIGNAL FROM PC
DAR(7:0)	RED COLOR DATA (ODD) FROM IC305	PC_VSYNC_IN	VSYNC FROM PC
DBB(7:0)	BLUE COLOR DATA (EVEN) FROM IC305	PCBLUE(7:0)	BLUE COLOR DATA FROM IC101
DBG(7:0)	GREEN COLOR DATA (EVEN) FROM IC305	PCCLAMP	BUFFERED VIDEO CLAMP SIGNAL
DBR(7:0)	RED COLOR DATA (EVEN) FROM IC305	PCCLAMP1	VIDEO CLAMP SIGNAL
DDC_SCL	DDC I2C CLOCK FROM PC	PCCLK	PLL CLOCK OUT FOR IC301
DDC_SDA	DDC I2C DATA FROM PC	PCCLK2	PLL CLOCK OUT FOR IC405
DEN	LVDS DATA ENABLE	PCCLK3	PLL CLOCK OUT FOR IC110
DFSYNCB	CONTROL SIGNAL FROM IC301 TO IC305	PCGREEN(7:0)	GREEN COLOR DATA FROM ADC(IC101)
DHCLK	DOT CLOCK FOR PANEL DRIVING	PCRED(7:0)	RED COLOR DATA FROM IC101
DHS	LVDS HSYNC	PCVSYNC2	BUFFERED VSYNC
DREFCLK1	67MHz OSC CLK FOR IC305	RESETB	RESET (NEG.)
DV_BLU	OSD BLUE DATA	RGB_HSYNC	HSYNC FOR MICOM(IC401)
DV_FBK	OSD ENABLE	RGB_VSYNC	VSYNC FOR MICOM(IC401)
DV_GRN	OSD GREEN DATA	SCL	I2C CLOCK
DV_RED	OSD RED DATA	SCSB	IC305 ENABLE
DVACTIV1B	HSYNC FOR OSD (NEG.)	SDA	I2C DATA
DVCLK	DOT CLOCK FOR OSD	SOG_CSYSN	COMPOSITE SYNC FROM SOG
DVS	LVDS VSYNC	SOURCE_PC	SELF RASTER CHECK SIGNAL
DVSYNCB	VSYNC FOR OSD (NEG.)	SPI_MISO	SERIAL INPUT DATA CONTROL
FSD(47:0)	VIDEO DATA BETWEEN IC301 AND IC302,IC303,IC304	SPI_MOSI	SERIAL OUTPUT DATA CONTROL
HSYNC_PLL	HSYNC FOR PLL	SPI_SCK	SERIAL CLOCK
INVERT	INTERLACE CONTROL SIGNAL	SW_REG_ENB	POWER ON/OFF CONTROL
KEY1	FUNCTION KEY SIGNAL1 TO MICOM	VAIL_CSB	IC301 ENABLE
KEY2	FUNCTION KEY SIGNAL2 TO MICOM	VCBLNKB	CONTROL SIGNAL FROM IC305 TO IC301
LED	LED ON	VCC	DC 5V FOR MICOM(IC401)
LVDS_DATA	DATA OUTPUT FROM IC310, IC311	VCLREQB	CONTROL SIGNAL FROM IC305 TO IC301
LVDS_EN	LVDS ENABLE	VGABLU(7:0)	NC
M_HSYNC	BUFFERED MICOM OUTPUT HSYNC	VGAGRE(7:0)	NC
M_HSYNC1	MICOM OUTPUT HSYNC	VGARE(7:0)	NC
M_VSYNC	BUFFERED MICOM OUTPUT VSYNC	VGBBLU(7:0)	BLUE COLOR DATA FROM IC301
M_VSYNC1	MICOM OUTPUT VSYNC	VGBGRE(7:0)	GREEN COLOR DATA FROM IC301
OSCOUT	BUFFERED 24MHz CLOCK	VGBRED(7:0)	RED COLOR DATA FROM IC301

**2-1-2 Symbols**

-  Hot Ground
-  Cold Ground
-  Provides special safety considerations

**2-1-2 Acronyms**

Acronym	Definition	Acronym	Definition
ABL	Automatic Brightness Limits	H/V	Horizontal/Vertical
AC	Alternating Current	HV	High Voltage
ACL	Automatic Contrast Limit	I/O	Input/Output
AFC	Automatic Frequency Control	IC	Integrated Circuit
ANSI	American National Standards Institute	LED	Light Emitting Diode
CMOS	Complementary Metal Oxide Semiconductor	MAC	Macintosh
CRT	Cathode Ray Tube	MOFA	Mask Outside Frame Assembly
DC	Direct Current	OCP	Over Current Protection
DDC	Data Display Channel	OP AMP	Operational Amplifier
DF	Dynamic Focus	OSD	On Screen Display
DMM	Digital Multimeter	P-P	Peak to Peak
DPMS	Display Power Management Signaling	PCB	Printed Circuit Board
DVM	Digital Voltmeter	PLL	Phase Locked Loop
DY	Deflection Yoke	PWM	Pulse Width Modulation
EEPROM	Electrically Erasable and Programmable Read only Memory	SMPS	Switch Mode Power Supply
ESD	Electrostatically Sensitive Device	SVGA	Super Video Graphics Array
ESF	Electronic Static Field	TP	Test Point
FBT	Flyback Transformer	UL	Underwriters Laboratories
FET	Field Effect Transistor	USB	Universal Serial Bus
FH	Horizontal Frequency	VESA	Video Electronics Standard Association
FS	Fail Safe	VGA	Video Graphics Array
FV	Vertical Frequency	VR	Variable Register
GD	Geometric Distortion	W/B	White Balance

## 3 Product Specifications

### 3-1 Specifications

Item	Description	
LCD Panel	TFT-LCD panel, RGB vertical stripe, normally white, 15-Inch viewable, 0.297 (H) x 0.297 (V) pixel pitch, 13.3-Inch viewable, 0.264 (H) x 0.264 (V) pixel pitch	
Scanning Frequency	Horizontal : 30 kHz to 61 kHz (Automatic) Vertical : 50 Hz to 75 Hz (Automatic)	
Display Colors	16.7 Million colors	
Maximum Resolution	Horizontal : 1024 Pixels Vertical : 768 Pixels	
Input Video Signal	Analog, 0.714 Vp-p $\pm$ 5% positive at 75 $\Omega$ , internally terminated	
Input Sync Signal	Type: Separate H/V sync, Composite H/V, Sync-on-Green, automatic synchronization without external switch of sync type Level: TTL level	
Maximum Pixel Clock rate	80 MHz	
Active Display Horizontal/Vertical	13.3": 270.3 mm / 207.8 mm 15": 304.1 mm / 228.1 mm	
AC power voltage & Frequency	AC 90 to 264 Volts, 60/ 50 Hz $\pm$ 3 Hz	
Power Consumption	13.3": 40 W (max.), 15": 45 W (max.)	
Dimensions	13.3"	15"
Unit (W x D x H) Carton (W x D x H)	13.9x7.7x15.6 Inches (354.3 x 195.6 x 395 mm) 17.9 x 11.1 x 19.2 Inches (455 x 282 x 488 mm)	15.9x7.7x16.5 Inches (404 x 196.6 x 418.7 mm) 18.7 x 11.1 x 20.1 Inches (475 x 282 x 510 mm)
Weight (Net/Gross)	13.3": 6.4 kg / 8.0 kg, 15": 7.5 kg / 9.5 kg	
Environmental Considerations	Operating Temperature : 50°F to 104°F (10°C to 40°C) Humidity : 10 % to 80 % Storage Temperature : -13°F to 113°F (-25°C to 45°C) Humidity : 5 % to 95 %	
Audio Characteristics	<ul style="list-style-type: none"> <li>• Audio Characteristics</li> <li>• Built-in Microphone: High-sensitivity condenser microphone (mono)</li> <li>• Audio input: Left/Right Stereo phone jack, 0.7 Vrms</li> <li>• Sound output: 1 W (left) + 1 W (right)/THD 1% at 8ohm</li> <li>• Frequency response: 80 Hz-20 kHz (at -3dB)</li> <li>• Headphone: Max 50mW output (3.5-pi jack)</li> <li>• Speaker: Internal semi Dome (8ohm x 2)</li> </ul>	
<ul style="list-style-type: none"> <li>• SyncMaster 33*TFT/53*TFT complies with SWEDAC (MPR II) recommendations for reduced electromagnetic fields.</li> <li>• Designs and specifications are subject to change without prior notice.</li> </ul>		

### 3-2 Pin Assignments

Pin No.	Sync Type	15-Pin Signal Cable Connector		
		Separate	Composite	Sync-on-green
1		Red	Red	Red
2		Green	Green	Green + H/V Sync
3		Blue	Blue	Blue
4		GND	GND	GND
5		GND (DDC Return)	GND (DDC Return)	GND (DDC Return)
6		GND-R	GND-R	GND-R
7		GND-G	GND-G	GND-G
8		GND-B	GND-B	GND-B
9		No Connection	No Connection	Not Used
10		GND-Sync/Self Test	GND-Sync/Self Test	GND-Sync/Self Test
11		GND	GND	GND
12		DDC Data	DDC Data	DDC Data
13		H-Sync	H/V-Sync	Not Used
14		V-Sync	Not Used	Not Used
15		DDC Clock	DDC Clock	DDC Clock

Pin No.	Sync Type	26-Pin Signal Cable Connector		
		Separate	Composite	Sync-on-green
1		Red	Red	Red
2		Green	Green	Green + H/V Sync
3		Blue	Blue	Blue
4		GND	GND	GND
5		GND (DDC Return)	GND (DDC Return)	GND (DDC Return)
6		GND-R	GND-R	GND-R
7		GND-G	GND-G	GND-G
8		GND-B	GND-B	GND-B
9		No Connection	No Connection	Not Used
10		GND-Sync/Self Test	GND-Sync/Self Test	GND-Sync/Self Test
11		GND	GND	GND
12		DDC Data	DDC Data	DDC Data
13		H-Sync	H/V-Sync	Not Used
14		V-Sync	Not Used	Not Used
15		DDC Clock	DDC Clock	DDC Clock
16 -26		GND	GND	GND



### 3-3 Timing Chart

This section of the service manual describes the timing that the computer industry recognizes as standard for computer-generated video signals.

Table 3-1. Timing Chart

Mode Timing	IBM			VESA			
	VGA1/70 Hz 640 x 350	VGA2/70 Hz 720 x 400	VGA3/60 Hz 640 x 480	640/72 Hz 640 x 480	640/75 Hz 640 x 480	800/56 Hz 800 x 600	800/60 Hz 800 x 600
fH (kHz)	31.469	31.469	31.469	37.861	37.500	35.156	37.879
A $\mu$ sec	31.778	31.777	31.778	26.413	26.667	28.444	26.400
B $\mu$ sec	3.813	3.813	3.813	1.270	2.032	2.000	3.200
C $\mu$ sec	1.589	1.589	1.589	3.810	3.810	3.556	2.200
D $\mu$ sec	26.058	26.058	26.058	20.825	20.317	22.222	20.000
E $\mu$ sec	0.318	0.318	0.318	0.508	0.508	0.667	1.000
fV (Hz)	70.086	70.087	59.940	72.809	75.000	56.250	60.317
O msec	14.268	14.268	16.683	13.735	13.333	17.778	16.579
P msec	0.064	0.064	0.064	0.079	0.080	0.057	0.106
Q msec	1.716	0.858	0.794	0.528	0.427	0.626	0.607
R msec	11.504	13.155	15.761	13.100	12.800	17.067	15.840
S msec	0.985	0.191	0.064	0.026	0.027	0.028	0.026
Clock Frequency (MHz)	25.175	28.322	25.175	31.500	31.500	36.000	40.000
Polarity H.Sync	Positive	Negative	Negative	Negative	Negative	Positive	Positive
V.Sync	Negative	Positive	Negative	Negative	Negative	Negative	Positive
Remark	Separate	Separate	Separate	Separate	Separate	Separate	Separate

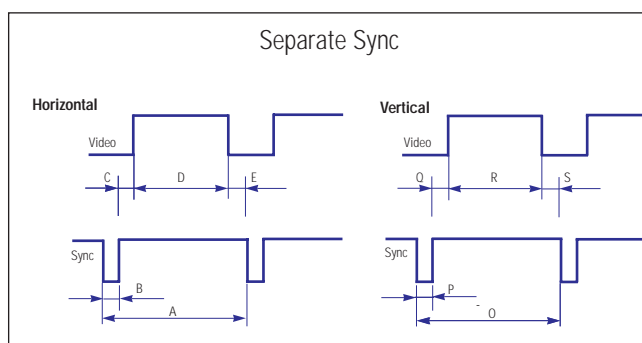

A : Line time total	B : Horizontal sync width	O : Frame time total	P : Vertical sync width
C : Back porch	D : Active time	Q : Back porch	R : Active time
E : Front porch		S : Front porch	

Table 3-1. Timing Chart Continued

Mode Timing	VESA					MAC.	
	800/72 Hz 800 x 600	800/75 Hz 800 x 600	1024/60 Hz 1024 x 768	1024/70 Hz 1024 x 768	1024/75 Hz 1024 x 768	640/67 Hz 60 x 480	832/75 Hz 832 x 624
fH (kHz)	48.077	46.875	48.363	56.476	60.023	35.000	49.726
A μsec	20.800	21.333	20.677	17.707	16.660	28.571	20.110
B μsec	2.400	1.616	2.092	1.813	1.219	2.116	1.117
C μsec	1.280	3.232	2.462	1.920	2.235	3.175	3.910
D μsec	16.000	16.162	15.754	13.653	13.003	21.164	14.524
E μsec	1.120	0.323	0.369	0.320	0.203	2.116	0.559
fV (Hz)	72.188	75.000	60.004	70.069	75.029	66.667	74.551
O msec	13.853	13.333	16.666	14.272	13.328	15.000	13.414
P msec	0.125	0.064	0.124	0.106	0.050	0.086	0.060
Q msec	0.478	0.448	0.600	0.513	0.466	1.114	0.784
R msec	12.480	12.800	15.880	13.599	12.795	13.714	12.549
S msec	0.770	0.021	0.062	0.053	0.017	0.086	0.020
Clock Frequency (MHz)	50.000	49.500	65.000	75.000	78.750	30.240	57.284
Polarity H.Sync	Positive	Positive	Negative	Negative	Positive	Negative	Negative
V.Sync	Positive	Positive	Negative	Negative	Positive	Negative	Negative
Remark	Separate	Separate	Separate	Separate	Separate	Separate	Separate

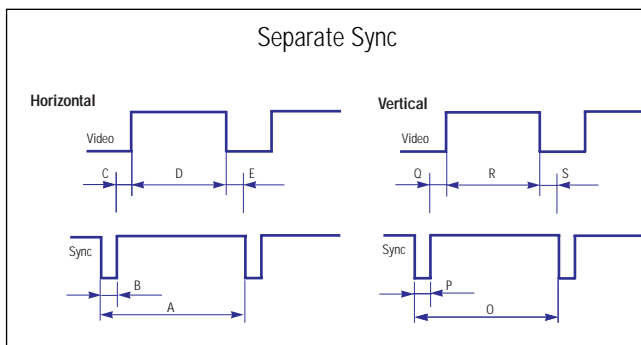

A : Line time total	B : Horizontal sync width	O : Frame time total	P : Vertical sync width
C : Back porch	D : Active time	Q : Back porch	R : Active time
E : Front porch		S : Front porch	

# 4 Operating Instructions

## 4-1 Control and Connectors

### 4-1-1 SyncMaster 331TFT/531TFT

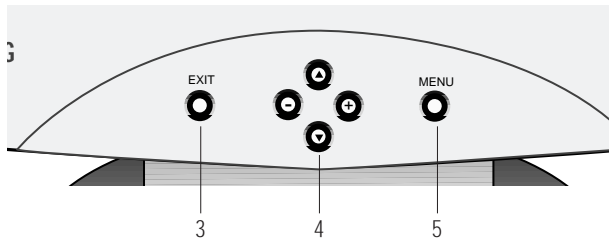

Figure 4-1. Front View and Control

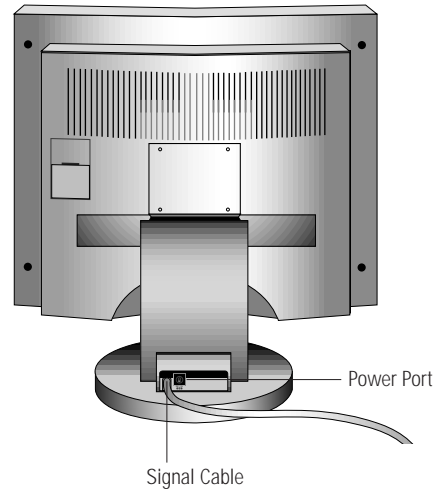

Figure 4-2. Rear View

Table 4-1. Front Panel Controls

Location	Symbol	Description
1		Power Button
2		Power Indicator
3		EXIT Button
4		Up / Down / + / - Buttons
5		MENU Button

4-1-2 SyncMaster 330TFT/530TFT

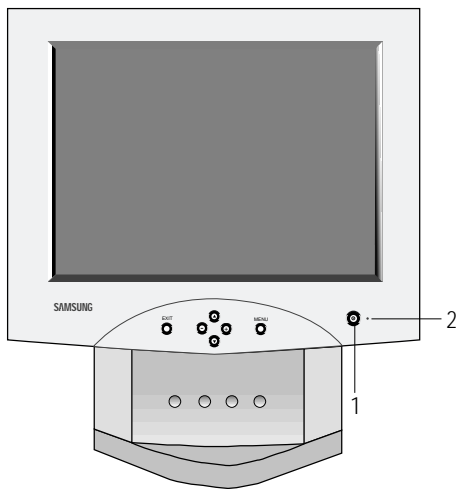

Figure 4-3. Front View and Control

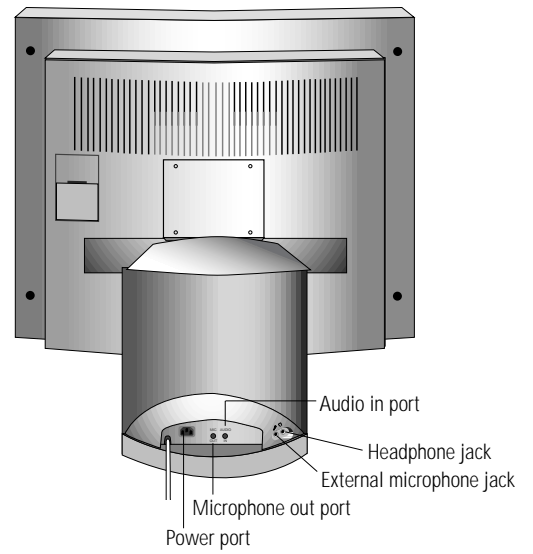

Figure 4-4. Rear View

Table 4-2. Front Panel Controls

Location	Symbol	Description
1		Power Button
2		Power Indicator
3		Menu Button
4		Exit Button
5		Up / Down / + / - Buttons
6		Audio On / Off & Volume Buttons
7		Bass Button
8		Treble Button
9		Microphone On / Off Button
10		Microphone
11		Amplified Stereo Speakers

## 4-2 Microprocessor Controls and Functions

This monitor has no “service only” micom controls. Should there be a problem with the microprocessor, replace the entire circuit board. There are, however, user accessible adjustment features that are described below.

This monitor has factory preset display settings for each of the signals listed in the standard display modes Timing Chart (see pages 3-3 and 3-4). As a result, when the monitor senses one of the standard signal timings, it automatically adjusts to an optimum size and position.

However, the user may wish to adjust the monitor to their own preferred settings rather than use those preset at the factory. The monitor saves up to 16 user defined settings.

### 4-2-1 OSD Window

The adjustable features described below all use the on-screen menu system.

1. Push the  $\downarrow$  button to open the display the on-screen menu.
2. Use the  $\blacktriangle$  or  $\blacktriangledown$  button to change an adjustment icon, use the  $\downarrow$  button to highlight an adjustment icon, then use the + or – buttons to make the adjustments.
3. To select another adjustment on the same screen, use the  $\blacktriangle$  or  $\blacktriangledown$  button to move to the next selection.
4. When you are done making adjustments on an adjustment icon, push the EXIT button.
5. When you are done making all adjustments, push the EXIT button.

Table 4-3 shows the adjustment types and their icons.

Table 4-3. Available adjustments

Icon	Description	Adjustment Range	Icon	Description	Adjustment Range
	Image Lock Fine Coarse	IBM VGA1/70 Hz 0-100 740-860		Position Horizontal Vertical	0 ~ 100 0 ~ 100
		VGA2/70 Hz 0-100 840-960			
		VGA3/60 Hz 0-100 740-860		Auto Reset Auto Adjustment Geometry Color	No/Yes No/Yes No/Yes
		VESA SVGA/56 Hz 0-100 964-1084			
		SVGA/60 Hz 0-100 996-1116			
		XGA/60 Hz 0-100 1284-1404		Image Size Zoom Display Size	x1, x2, x4, x8 Normal/Expand
	Brightness	0 ~ 100		Misc. Language Menu Position Menu Display Time Display Mode	0 ~ 100 0 ~ 100
	Contrast	0 ~ 100			
	Color Control Red Green Blue	0 ~ 100 0 ~ 100 0 ~ 100		Color Temperature Mode1 Mode2 Mode3	

## 4-3 Audio Controls

Your LCD monitor provides four audio control buttons located on the front of the stand.

### 4-3-1 Audio Adjustments

To access the on/off, volume, bass and treble functions push the appropriate blue control button until it pops out then turn it to the right or left to adjust the function.

Function Name	Effect of Control Movement	
	Left	Right
Audio On/Off and Volume	Off	On
	Decrease volume	Increase volume
Bass	Decrease Low sounds	Increase low sounds
Treble	Decrease high sounds	Increase High sounds

Your LCD monitor includes an internal microphone which you can turn On or Off using the rightmost control of the Audio controls.

Function Name	Effect of Control Movement	
	In	Out
Audio On/Off and Volume	Off	On

## 4-4 Power Management System

This monitor has a built-in power management system called PowerSaver. This system saves energy by switching your monitor into an off mode when it has not been used for an certain amount of time.

This system operates with a VESA DPMS compliant video card installed in your computer. You use a software utility installed on your computer to set up this feature. See the table below for details.

Table 4-4. Display Power Management Signaling (DPMS); 13.3"

State Items	Normal Operation	Power saving function EPA/NUTEK		
		Stand-By Mode	Suspend Mode Position A	Power Off Mode Position B
Horizontal Sync	Active	Inactive	Active	Inactive
Vertical Sync	Active	Active	Inactive	Inactive
Video	Active	Blanked	Blanked	Blanked
Power Indicator	Green	Amber	Amber Blinking (0.5 sec)	Amber Blinking (1 sec)
Power Consumption/hr (13.3")	40 W (max.) 30 W (nominal)	Less than 5 W	Less than 5 W	Less than 5 W
Power Consumption/hr (15")	45 W (max.) 35 W (nominal)	Less than 5 W	Less than 5 W	Less than 5 W

**Note 1:** This monitor automatically returns to normal operation when horizontal and vertical sync return. This occurs when you move the computer's mouse or press a key on the keyboard.

**Note 2:** This monitor is EPA ENERGY STAR<sup>®</sup> compliant and NUTEK compliant when used with a computer equipped with VESA DPMS functionality. If your computer system cannot support a display power management function, you can purchase an optional DPMS software program to enable the power saving function. Please contact Samsung or your dealer for more information.

**Note 3:** For energy conservation, turn your monitor OFF when it is not needed, or when leaving it unattended for long periods.

**Note 4:** Audio Part is operated separately by control button.

## 5 Disassembly and Reassembly

This section of the service manual describes the disassembly and reassembly procedures for the SyncMaster 33\*TFT/53\*TFT monitors.

**WARNING:** This monitor contains electrostatically sensitive devices. Use caution when handling these components.

### 5-1 Disassembly

- Cautions:**
1. Disconnect the monitor from the power source before disassembly.
  2. Follow these directions carefully; never use metal instruments to pry apart the cabinet.

#### 5-1-1 Removing the Stand

1. Carefully push the edge of the hinge cap with a '-' screw driver until the opposite end of the hinge cap releases.



Figure 5-1

2. Remove 4 screws in the hinge area.



Figure 5-2

3. Push the stand to the left side to release the hinge.  
**Caution:** Be careful. Signal cable and power cable are still attached to the monitor.
4. Lift the stand away from the monitor until Vesa Cover is completely visible. And pry it off the back of the monitor.

5. Disconnect Power Cord and Signal Cable.



Figure 5-3

#### 5-1-2 Main Body Disassembly

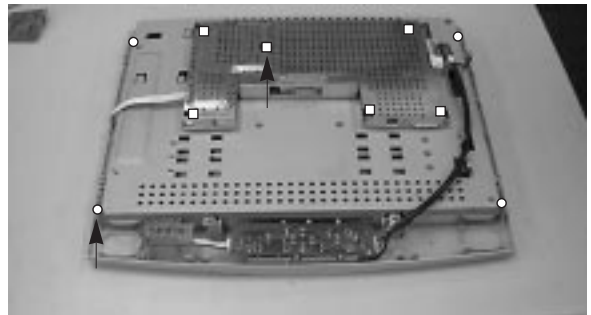

Figure 5-4

1. Remove the 4 screws on the Rear Cover. (Marked: ○ )
2. Remove Rear Cover from the Front Cover.
3. Remove 6 screws on the Shield. (Marked: □ )
4. Disconnect Inverter wire, Function PCB wire and Interface wire.
5. Remove the Main PCB Assembly.

## 5 Disassembly and Reassembly

6. Remove 4 screws on the Rear Panel Bracket.  
(15" : 6 screws)

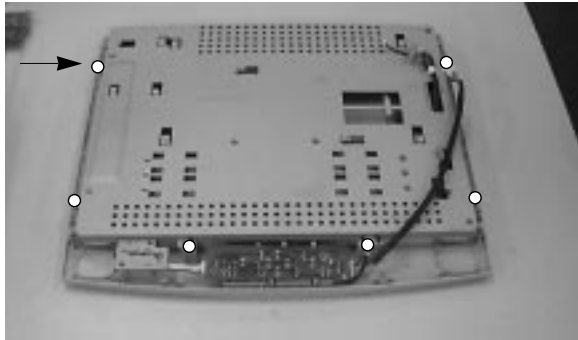

Figure 5-5

7. Remove the Bracket Assembly from the Front Cover.
8. Remove 1 screw on the Power PCB.
9. Remove Function PCB from locking area of Function Knob.



Figure 5-6

10. Remove 4 screws on the Shield of Panel.
11. Remove the Shield.
12. Disconnect the jack between Panel and Inverter PCB.
13. Remove Rear Bracket.

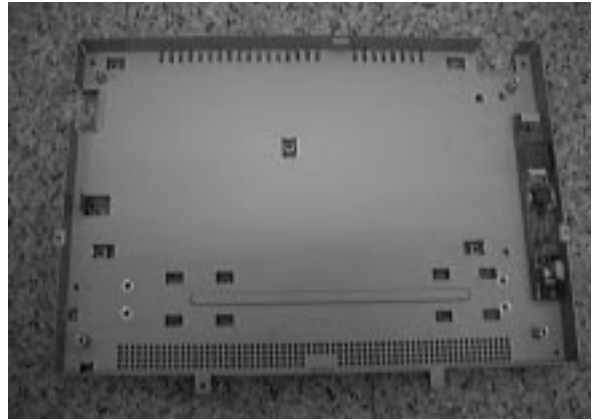

Figure 5-7

14. Remove 2 screws between Rear Bracket and Inverter PCB.
15. Remove the Interface wire on the Rear Side of Panel.

### 5-1-3 Stand Disassembly

1. Stand the stand assembly with the base close to you.



Figure 5-8



2. Make a little gap between stand assembly and Rear Cover with a '-' screw driver. And pry Rear Cover off stand assembly with the finger.



Figure 5-9

3. Remove the 10 screws from the stand assembly.

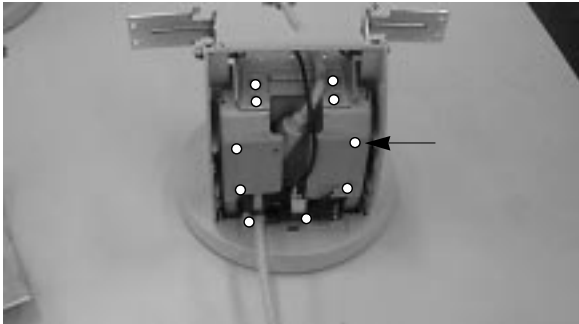

Figure 5-10

4. Remove the hinge, neck front, PCB, signal cable.

5. Remove the screw and washer on the base of the stand.



Figure 5-11

6. Remove the Stand Base and Stand Top.

## 5-2 Replacement Order of Lamp Assemblies (13.3")

---

1. Disconnect lamp lead-connector from the inverter.

\* Replacement of lamp assemblies should be done at the power off state and recommended clean bench condition.

2. Remove a screw which is used to hold a lamp assembly on.

3. Replace lamp assemblies.
4. Assemble new lamp assembly according to the counter order.

## 5-3 Replacement Order of Lamp Assemblies (15")

---

1. Disconnect lamp lead-connectors from the inverter.  
(2EA)

\* Replacement of lamp assemblies should be done at the power off state and recommended clean bench condition.

2. Remove 2 screws which are used to hold the lamp assemblies on.

3. Replace 2 lamp assemblies.
4. Assemble new lamp assemblies according to the counter order.

## **5-4 Reassembly**

---

Reassembly procedures are in the reverse order of Disassembly procedures.

## 6 Troubleshooting

- Notes:**
- Before troubleshooting, setup the PC's display as below.
    - Resolution: 1024 x 768
    - H-frequency: 48 kHz
    - V-frequency: 60 Hz
  - If no picture appears, make sure the power cord is correctly connected.
  - Check the following circuits.
    - No raster appears: Audio PCB, SMPS PCB, Main PCB (SyncMaster 330TFT/550TFT)  
Stand PCB, Main PCB (SyncMaster 331TFT/531TFT)
    - 12V develop but no screen: Main PCB
    - 12V does not develop: Audio PCB, SMPS PCB (SyncMaster 330TFT/530TFT)  
Main PCB (SyncMaster 331TFT/531TFT)
  - If you push and hold the "EXIT" button for more than 5 seconds, the monitor automatically turns back to the factory preset.

### 6-1 No Power

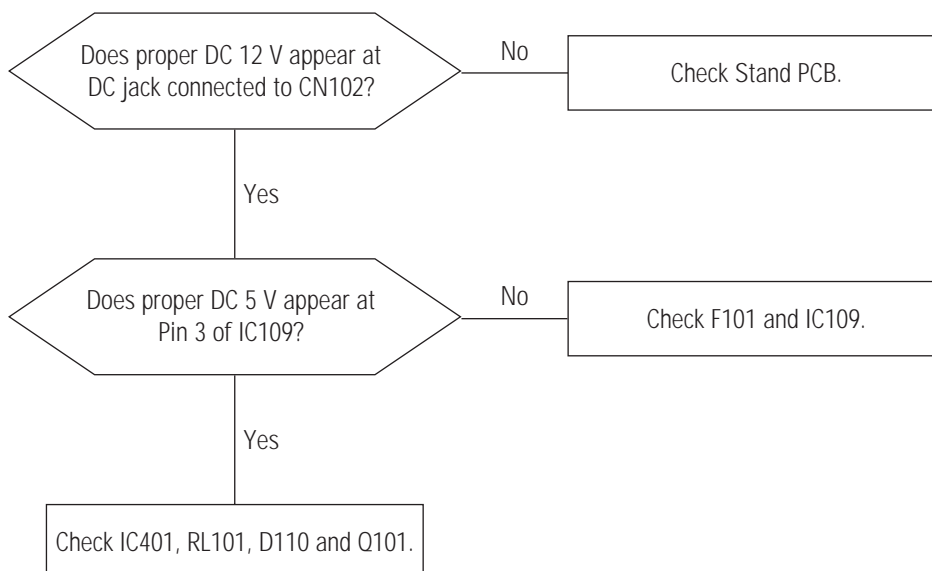

## 6-2 No Video

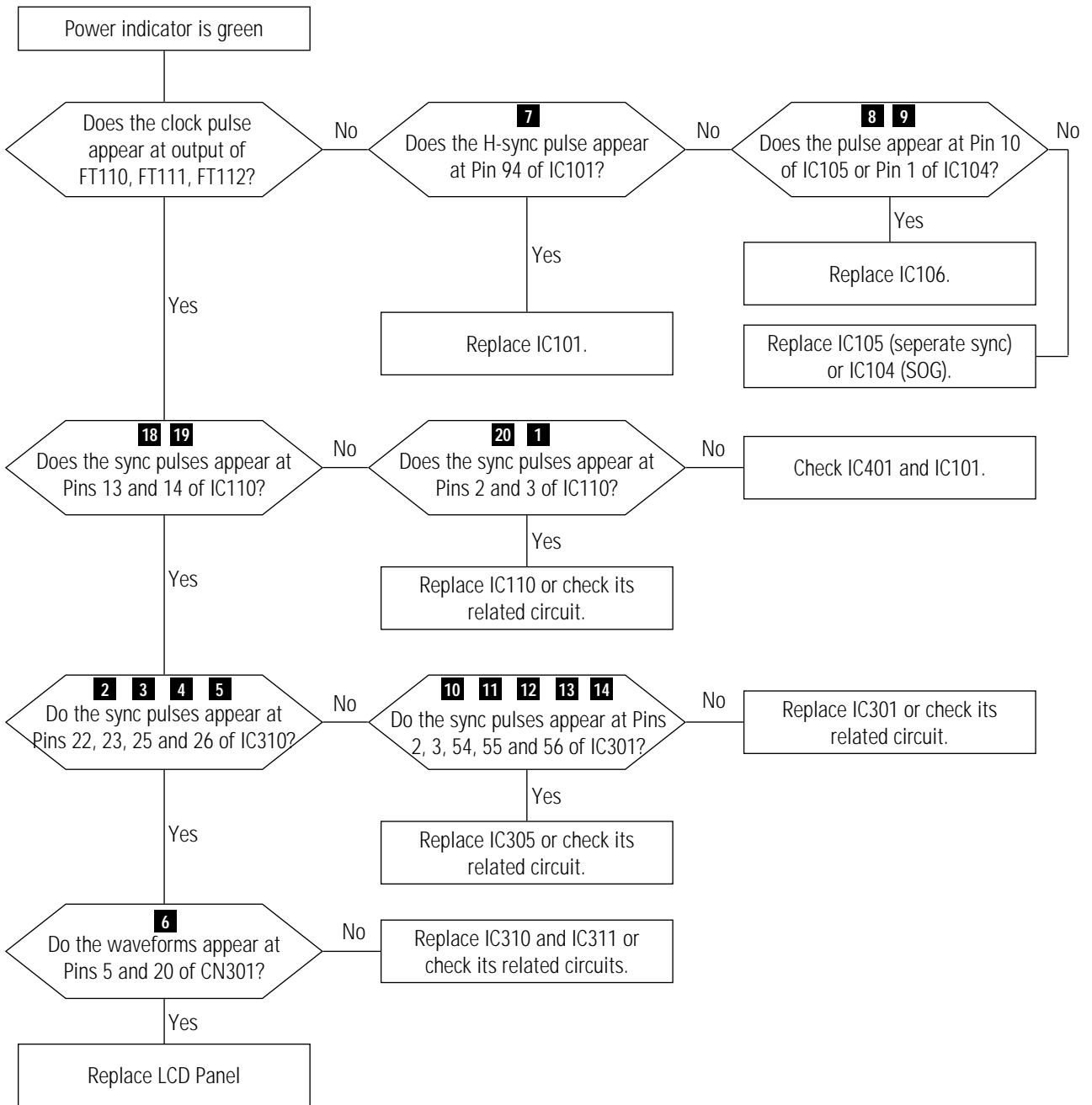

**WAVEFORMS**

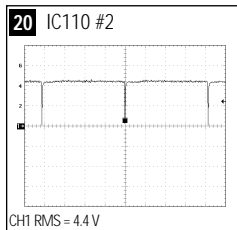
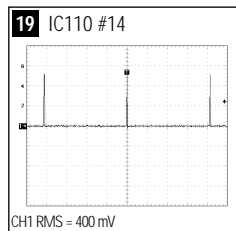
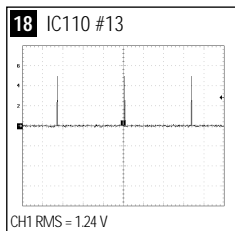
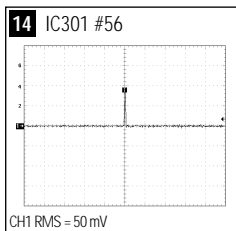
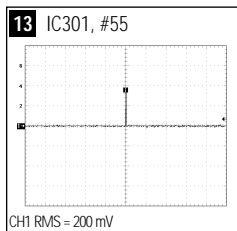
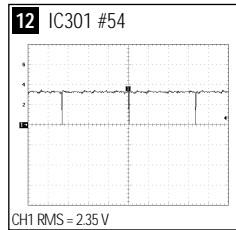
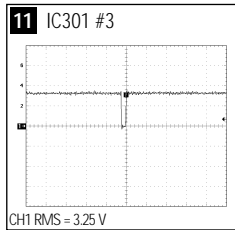
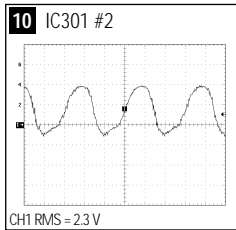
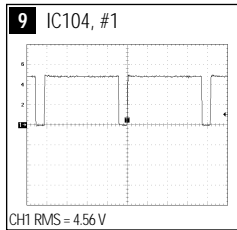
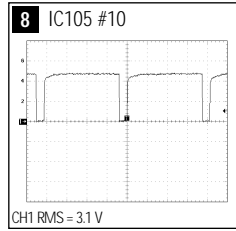
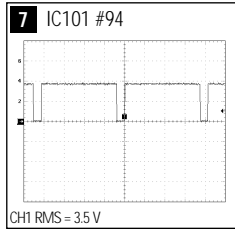
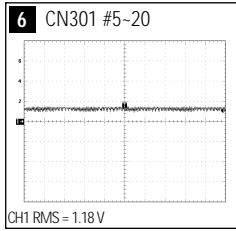
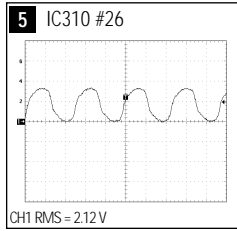
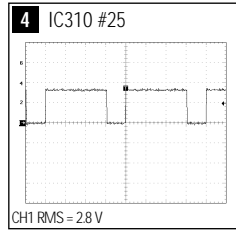
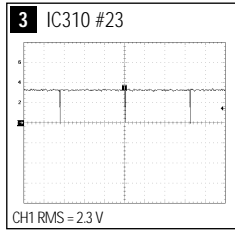
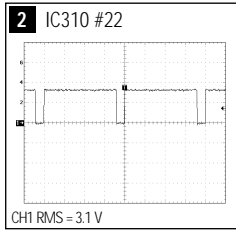
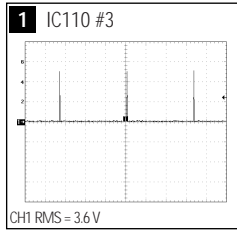

### 6-3 No Video of Alternate Vertical Line

One or more even or odd vertical lines do not display.

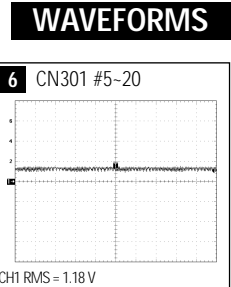
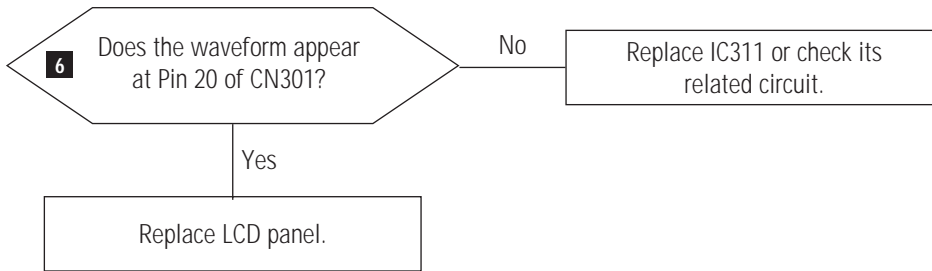

### 6-4 No OSD

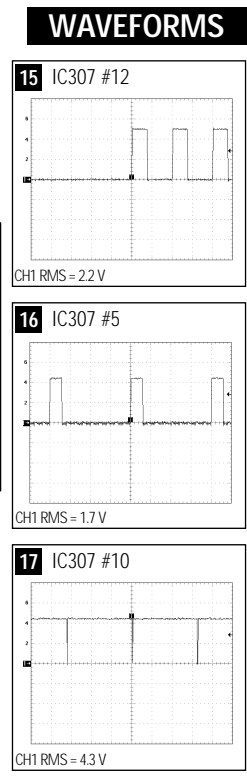
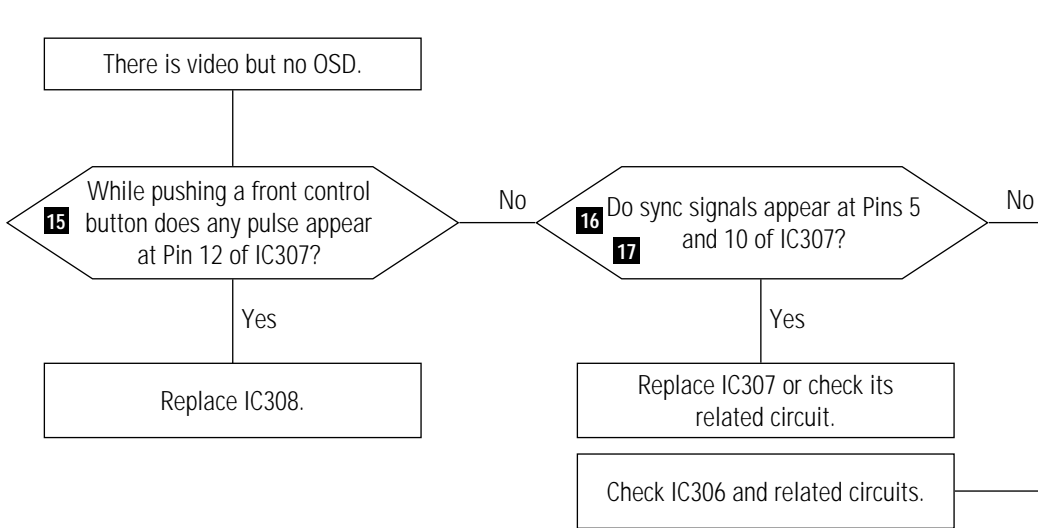

### 6-5 User Controls Don't Work

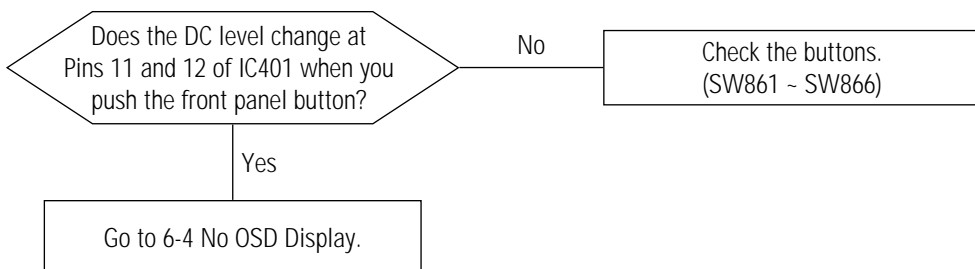



## 6-6 No Sound (SyncMaster 330TFT/530TFT)

---

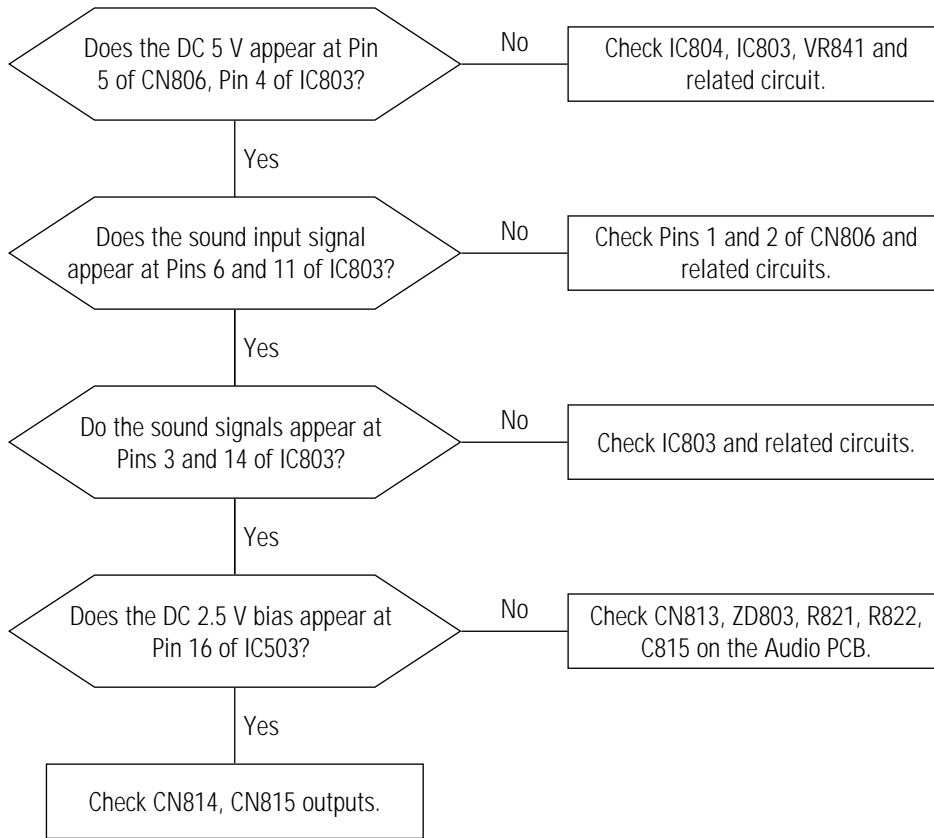

### 6-7 Microphones Don't Work (SyncMaster 330TFT/530TFT)

---

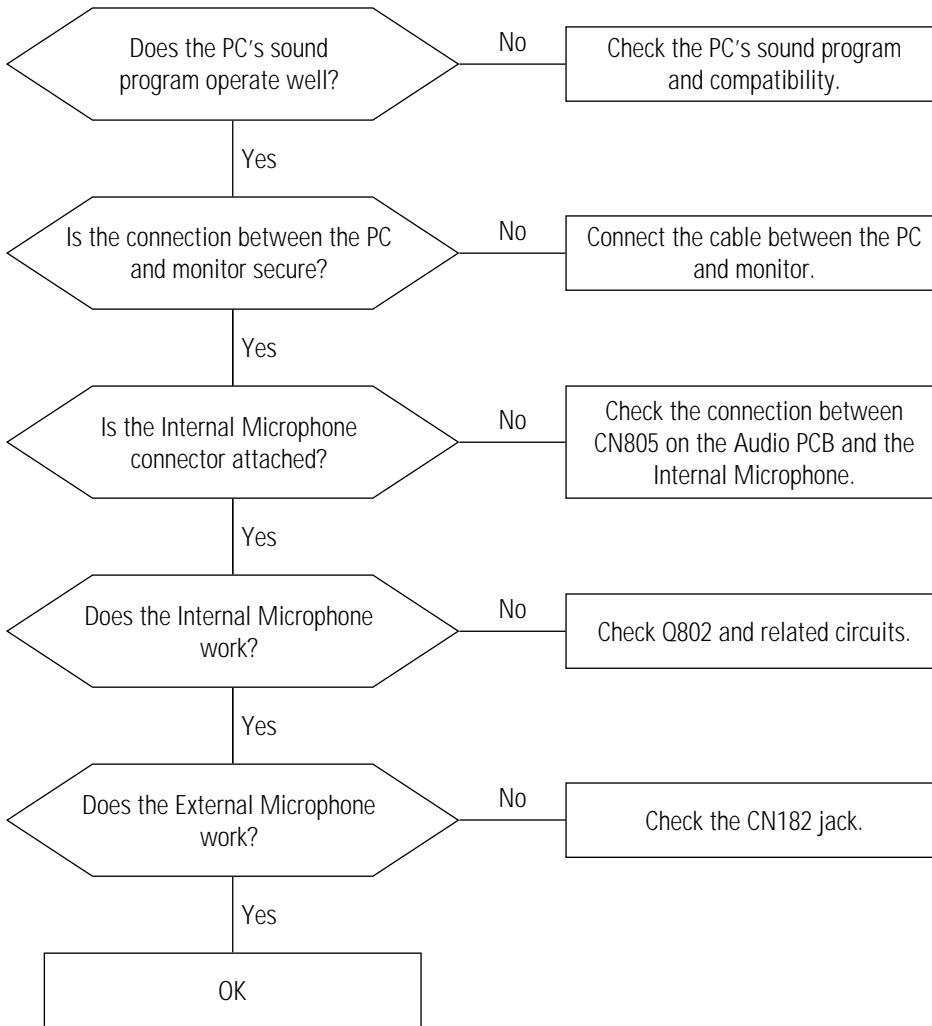

### 6-8 Headphones Don't Work (SyncMaster 330TFT/530TFT)

---

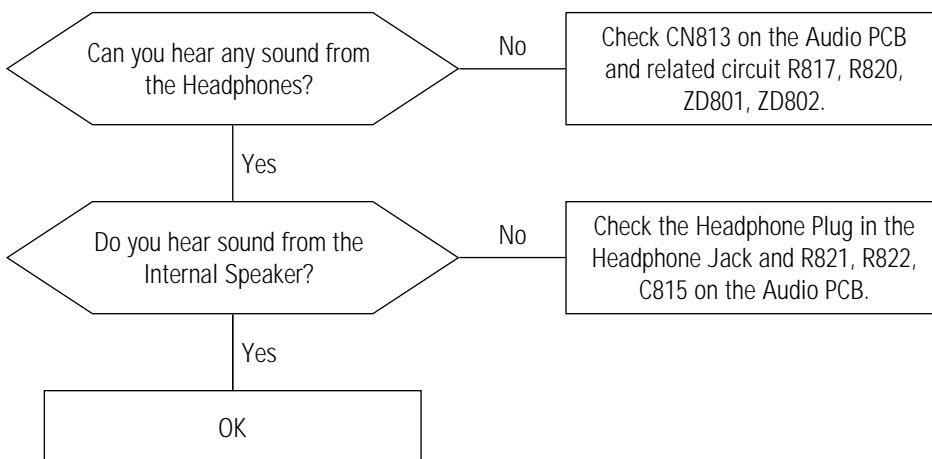

## 9 Electrical Parts List

### 9-1 Main PCB Parts

Loc. No.	Code No.	Description	Specification	Remarks
BD101	2703-001334	INDUCTOR-SMD	1.5uH,10%,2x1.25x0.85mm	
BD102	2703-001334	INDUCTOR-SMD	1.5uH,10%,2x1.25x0.85mm	
BD103	2703-001334	INDUCTOR-SMD	1.5uH,10%,2x1.25x0.85mm	
BD104	2703-001334	INDUCTOR-SMD	1.5uH,10%,2x1.25x0.85mm	
BD105	2703-001334	INDUCTOR-SMD	1.5uH,10%,2x1.25x0.85mm	
C100	2203-000260	C-CERAMIC,CHIP	10nF,10%,50V,X7R,TP,2012	
C101	2402-000168	C-AL,SMD	100uF,20%,16V,TP,8x6.3	
C102	2203-000260	C-CERAMIC,CHIP	10nF,10%,50V,X7R,TP,2012	
C103	2402-000168	C-AL,SMD	100uF,20%,16V,TP,8x6.3	
C104	2203-000260	C-CERAMIC,CHIP	10nF,10%,50V,X7R,TP,2012	
C105	2402-000168	C-AL,SMD	100uF,20%,16V,TP,8x6.3	
C106	2402-000168	C-AL,SMD	100uF,20%,16V,TP,8x6.3	
C107	2203-000239	C-CERAMIC,CHIP	100pF,5%,50V,NPO,TP,2012	
C108	2203-000239	C-CERAMIC,CHIP	100pF,5%,50V,NPO,TP,2012	
C109	2203-000260	C-CERAMIC,CHIP	10nF,10%,50V,X7R,TP,2012	
C110	2203-000203	C-CERAMIC,CHIP	100nF,10%,16V,X7R,TP,2012	
C111	2203-000203	C-CERAMIC,CHIP	100nF,10%,16V,X7R,TP,2012	
C112	2203-000203	C-CERAMIC,CHIP	100nF,10%,16V,X7R,TP,2012	
C113	2203-000203	C-CERAMIC,CHIP	100nF,10%,16V,X7R,TP,2012	
C114	2203-000203	C-CERAMIC,CHIP	100nF,10%,16V,X7R,TP,2012	
C115	2404-000123	C-TA,CHIP	10uF,20%,16V,TP,6032,2.9mm	
C116	2203-000260	C-CERAMIC,CHIP	10nF,10%,50V,X7R,TP,2012	
C117	2203-000203	C-CERAMIC,CHIP	100nF,10%,16V,X7R,TP,2012	
C118	2203-000260	C-CERAMIC,CHIP	10nF,10%,50V,X7R,TP,2012	
C119	2203-000203	C-CERAMIC,CHIP	100nF,10%,16V,X7R,TP,2012	
C120	2203-000260	C-CERAMIC,CHIP	10nF,10%,50V,X7R,TP,2012	
C121	2203-000203	C-CERAMIC,CHIP	100nF,10%,16V,X7R,TP,2012	
C122	2203-000260	C-CERAMIC,CHIP	10nF,10%,50V,X7R,TP,2012	
C123	2203-000609	C-CERAMIC,CHIP	22nF,10%,50V,X7R,TP,2012	
C124	2203-000260	C-CERAMIC,CHIP	10nF,10%,50V,X7R,TP,2012	
C125	2203-000609	C-CERAMIC,CHIP	22nF,10%,50V,X7R,TP,2012	
C126	2203-000260	C-CERAMIC,CHIP	10nF,10%,50V,X7R,TP,2012	
C127	2203-000609	C-CERAMIC,CHIP	22nF,10%,50V,X7R,TP,2012	
C128	2203-000137	C-CERAMIC,CHIP	1.5nF,10%,50V,NPO,TP,2012	
C129	2203-000260	C-CERAMIC,CHIP	10nF,10%,50V,X7R,TP,2012	
C130	2203-000260	C-CERAMIC,CHIP	10nF,10%,50V,X7R,TP,2012	
C131	2203-000260	C-CERAMIC,CHIP	10nF,10%,50V,X7R,TP,2012	
C132	2203-000260	C-CERAMIC,CHIP	10nF,10%,50V,X7R,TP,2012	
C133	2203-000260	C-CERAMIC,CHIP	10nF,10%,50V,X7R,TP,2012	
C134	2203-000260	C-CERAMIC,CHIP	10nF,10%,50V,X7R,TP,2012	
C135	2203-000260	C-CERAMIC,CHIP	10nF,10%,50V,X7R,TP,2012	
C136	2203-000260	C-CERAMIC,CHIP	10nF,10%,50V,X7R,TP,2012	
C137	2203-000203	C-CERAMIC,CHIP	100nF,10%,16V,X7R,TP,2012	
C138	2203-000260	C-CERAMIC,CHIP	10nF,10%,50V,X7R,TP,2012	
C139	2203-000203	C-CERAMIC,CHIP	100nF,10%,16V,X7R,TP,2012	

9 Electrical Parts List

Loc. No.	Code No.	Description	Specification	Remarks
C140	2203-000260	C-CERAMIC,CHIP	10nF,10%,50V,X7R,TP,2012	
C141	2203-000203	C-CERAMIC,CHIP	100nF,10%,16V,X7R,TP,2012	
C142	2203-000844	C-CERAMIC,CHIP	39nF,10%,50V,X7R,TP,2012	
C143	2203-000953	C-CERAMIC,CHIP	470pF,5%,50V,NPO,TP,2012	
C144	2203-000203	C-CERAMIC,CHIP	100nF,10%,16V,X7R,TP,2012	
C145	2203-000260	C-CERAMIC,CHIP	10nF,10%,50V,X7R,TP,2012	
C146	2203-000260	C-CERAMIC,CHIP	10nF,10%,50V,X7R,TP,2012	
C147	2203-000203	C-CERAMIC,CHIP	100nF,10%,16V,X7R,TP,2012	
C148	2203-000260	C-CERAMIC,CHIP	10nF,10%,50V,X7R,TP,2012	
C149	2203-000203	C-CERAMIC,CHIP	100nF,10%,16V,X7R,TP,2012	
C150	2203-000260	C-CERAMIC,CHIP	10nF,10%,50V,X7R,TP,2012	
C151	2203-000203	C-CERAMIC,CHIP	100nF,10%,16V,X7R,TP,2012	
C152	2203-000595	C-CERAMIC,CHIP	220pF,5%,50V,NPO,TP,2012	
C153	2203-000595	C-CERAMIC,CHIP	220pF,5%,50V,NPO,TP,2012	
C154	2203-000595	C-CERAMIC,CHIP	220pF,5%,50V,NPO,TP,2012	
C155	2203-000595	C-CERAMIC,CHIP	220pF,5%,50V,NPO,TP,2012	
C156	2203-001002	C-CERAMIC,CHIP	47pF,5%,50V,NPO,TP,2012	
C157	2203-000203	C-CERAMIC,CHIP	100nF,10%,16V,X7R,TP,2012	
C158	2203-000203	C-CERAMIC,CHIP	100nF,10%,16V,X7R,TP,2012	
C159	2402-000168	C-AL,SMD	100uF,20%,16V,TP,8x6.3	
C160	2203-000203	C-CERAMIC,CHIP	100nF,10%,16V,X7R,TP,2012	
C161	2203-000203	C-CERAMIC,CHIP	100nF,10%,16V,X7R,TP,2012	
C163	2203-000260	C-CERAMIC,CHIP	10nF,10%,50V,X7R,TP,2012	
C165	2404-000256	C-TA,CHIP	47uF,20%,16V,TP,7343,7.3mm	
C166	2409-001004	C-ORGANIC	100uF,20%,16V,LL,BK,8x10.5mm,3	
C167	2402-000168	C-AL,SMD	100uF,20%,16V,TP,8x6.3	
C168	2203-000260	C-CERAMIC,CHIP	10nF,10%,50V,X7R,TP,2012	
C169	2402-000168	C-AL,SMD	100uF,20%,16V,TP,8x6.3	
C170	2203-000260	C-CERAMIC,CHIP	10nF,10%,50V,X7R,TP,2012	
C172	2402-000168	C-AL,SMD	100uF,20%,16V,TP,8x6.3	
C173	2409-001004	C-ORGANIC	100uF,20%,16V,LL,BK,8x10.5mm,3	
C174	2404-000123	C-TA,CHIP	10uF,20%,16V,TP,6032,2.9mm	
C175	2404-000123	C-TA,CHIP	10uF,20%,16V,TP,6032,2.9mm	
C176	2402-000168	C-AL,SMD	100uF,20%,16V,TP,8x6.3	
C177	2409-001004	C-ORGANIC	100uF,20%,16V,LL,BK,8x10.5mm,3	
C180	2404-000123	C-TA,CHIP	10uF,20%,16V,TP,6032,2.9mm	
C181	2404-000123	C-TA,CHIP	10uF,20%,16V,TP,6032,2.9mm	
C182	2203-000260	C-CERAMIC,CHIP	10nF,10%,50V,X7R,TP,2012	
C183	2203-000203	C-CERAMIC,CHIP	100nF,10%,16V,X7R,TP,2012	
C184	2203-000260	C-CERAMIC,CHIP	10nF,10%,50V,X7R,TP,2012	
C185	2203-000203	C-CERAMIC,CHIP	100nF,10%,16V,X7R,TP,2012	
C186	2404-000123	C-TA,CHIP	10uF,20%,16V,TP,6032,2.9mm	
C187	2404-000123	C-TA,CHIP	10uF,20%,16V,TP,6032,2.9mm	
C188	2203-000203	C-CERAMIC,CHIP	100nF,10%,16V,X7R,TP,2012	
C189	2203-000260	C-CERAMIC,CHIP	10nF,10%,50V,X7R,TP,2012	
C190	2203-000203	C-CERAMIC,CHIP	100nF,10%,16V,X7R,TP,2012	
C195	2203-000260	C-CERAMIC,CHIP	10nF,10%,50V,X7R,TP,2012	

Loc. No.	Code No.	Description	Specification	Remarks
C196	2203-000260	C-CERAMIC,CHIP	10nF,10%,50V,X7R,TP,2012	
C201	2203-000455	C-CERAMIC,CHIP	1nF,5%,50V,NPO,TP,2012	
C202	2203-000203	C-CERAMIC,CHIP	100nF,10%,16V,X7R,TP,2012	
C203	2203-000455	C-CERAMIC,CHIP	1nF,5%,50V,NPO,TP,2012	
C204	2203-000203	C-CERAMIC,CHIP	100nF,10%,16V,X7R,TP,2012	
C301	2203-000203	C-CERAMIC,CHIP	100nF,10%,16V,X7R,TP,2012	
C302	2203-000203	C-CERAMIC,CHIP	100nF,10%,16V,X7R,TP,2012	
C303	2203-000203	C-CERAMIC,CHIP	100nF,10%,16V,X7R,TP,2012	
C304	2203-000203	C-CERAMIC,CHIP	100nF,10%,16V,X7R,TP,2012	
C305	2203-000203	C-CERAMIC,CHIP	100nF,10%,16V,X7R,TP,2012	
C306	2203-000203	C-CERAMIC,CHIP	100nF,10%,16V,X7R,TP,2012	
C307	2203-000203	C-CERAMIC,CHIP	100nF,10%,16V,X7R,TP,2012	
C308	2203-000203	C-CERAMIC,CHIP	100nF,10%,16V,X7R,TP,2012	
C309	2203-000203	C-CERAMIC,CHIP	100nF,10%,16V,X7R,TP,2012	
C310	2203-000203	C-CERAMIC,CHIP	100nF,10%,16V,X7R,TP,2012	
C311	2203-000203	C-CERAMIC,CHIP	100nF,10%,16V,X7R,TP,2012	
C312	2203-000203	C-CERAMIC,CHIP	100nF,10%,16V,X7R,TP,2012	
C313	2203-000203	C-CERAMIC,CHIP	100nF,10%,16V,X7R,TP,2012	
C314	2203-000203	C-CERAMIC,CHIP	100nF,10%,16V,X7R,TP,2012	
C315	2203-000203	C-CERAMIC,CHIP	100nF,10%,16V,X7R,TP,2012	
C316	2203-000203	C-CERAMIC,CHIP	100nF,10%,16V,X7R,TP,2012	
C317	2203-000203	C-CERAMIC,CHIP	100nF,10%,16V,X7R,TP,2012	
C318	2203-000203	C-CERAMIC,CHIP	100nF,10%,16V,X7R,TP,2012	
C319	2203-000203	C-CERAMIC,CHIP	100nF,10%,16V,X7R,TP,2012	
C320	2203-000203	C-CERAMIC,CHIP	100nF,10%,16V,X7R,TP,2012	
C321	2203-000203	C-CERAMIC,CHIP	100nF,10%,16V,X7R,TP,2012	
C322	2203-000203	C-CERAMIC,CHIP	100nF,10%,16V,X7R,TP,2012	
C323	2203-001723	C-CERAMIC,CHIP	4.7pF,5%,50V,NPO,TP,2012	
C324	2203-000203	C-CERAMIC,CHIP	100nF,10%,16V,X7R,TP,2012	
C325	2203-000203	C-CERAMIC,CHIP	100nF,10%,16V,X7R,TP,2012	
C326	2203-000203	C-CERAMIC,CHIP	100nF,10%,16V,X7R,TP,2012	
C327	2203-000203	C-CERAMIC,CHIP	100nF,10%,16V,X7R,TP,2012	
C328	2203-000203	C-CERAMIC,CHIP	100nF,10%,16V,X7R,TP,2012	
C329	2203-000203	C-CERAMIC,CHIP	100nF,10%,16V,X7R,TP,2012	
C330	2203-000203	C-CERAMIC,CHIP	100nF,10%,16V,X7R,TP,2012	
C331	2203-000203	C-CERAMIC,CHIP	100nF,10%,16V,X7R,TP,2012	
C332	2203-000203	C-CERAMIC,CHIP	100nF,10%,16V,X7R,TP,2012	
C333	2203-000203	C-CERAMIC,CHIP	100nF,10%,16V,X7R,TP,2012	
C334	2203-000203	C-CERAMIC,CHIP	100nF,10%,16V,X7R,TP,2012	
C335	2203-000203	C-CERAMIC,CHIP	100nF,10%,16V,X7R,TP,2012	
C336	2203-000203	C-CERAMIC,CHIP	100nF,10%,16V,X7R,TP,2012	
C337	2203-000203	C-CERAMIC,CHIP	100nF,10%,16V,X7R,TP,2012	
C338	2203-000203	C-CERAMIC,CHIP	100nF,10%,16V,X7R,TP,2012	
C339	2203-000203	C-CERAMIC,CHIP	100nF,10%,16V,X7R,TP,2012	
C340	2203-000203	C-CERAMIC,CHIP	100nF,10%,16V,X7R,TP,2012	
C341	2203-000203	C-CERAMIC,CHIP	100nF,10%,16V,X7R,TP,2012	
C342	2203-000203	C-CERAMIC,CHIP	100nF,10%,16V,X7R,TP,2012	

9 Electrical Parts List

Loc. No.	Code No.	Description	Specification	Remarks
C343	2203-000203	C-CERAMIC,CHIP	100nF,10%,16V,X7R,TP,2012	
C344	2203-000203	C-CERAMIC,CHIP	100nF,10%,16V,X7R,TP,2012	
C345	2203-000203	C-CERAMIC,CHIP	100nF,10%,16V,X7R,TP,2012	
C346	2203-000203	C-CERAMIC,CHIP	100nF,10%,16V,X7R,TP,2012	
C347	2203-000203	C-CERAMIC,CHIP	100nF,10%,16V,X7R,TP,2012	
C348	2203-000203	C-CERAMIC,CHIP	100nF,10%,16V,X7R,TP,2012	
C349	2203-000203	C-CERAMIC,CHIP	100nF,10%,16V,X7R,TP,2012	
C350	2203-000203	C-CERAMIC,CHIP	100nF,10%,16V,X7R,TP,2012	
C351	2203-000203	C-CERAMIC,CHIP	100nF,10%,16V,X7R,TP,2012	
C352	2203-000203	C-CERAMIC,CHIP	100nF,10%,16V,X7R,TP,2012	
C353	2203-000203	C-CERAMIC,CHIP	100nF,10%,16V,X7R,TP,2012	
C354	2203-000203	C-CERAMIC,CHIP	100nF,10%,16V,X7R,TP,2012	
C355	2203-000203	C-CERAMIC,CHIP	100nF,10%,16V,X7R,TP,2012	
C356	2203-000203	C-CERAMIC,CHIP	100nF,10%,16V,X7R,TP,2012	
C357	2203-000203	C-CERAMIC,CHIP	100nF,10%,16V,X7R,TP,2012	
C358	2203-000203	C-CERAMIC,CHIP	100nF,10%,16V,X7R,TP,2012	
C359	2203-000203	C-CERAMIC,CHIP	100nF,10%,16V,X7R,TP,2012	
C360	2203-000203	C-CERAMIC,CHIP	100nF,10%,16V,X7R,TP,2012	
C361	2203-000203	C-CERAMIC,CHIP	100nF,10%,16V,X7R,TP,2012	
C362	2203-000203	C-CERAMIC,CHIP	100nF,10%,16V,X7R,TP,2012	
C363	2203-000203	C-CERAMIC,CHIP	100nF,10%,16V,X7R,TP,2012	
C364	2404-000123	C-TA,CHIP	10uF,20%,16V,TP,6032,2.9mm	
C365	2203-000203	C-CERAMIC,CHIP	100nF,10%,16V,X7R,TP,2012	
C366	2203-000203	C-CERAMIC,CHIP	100nF,10%,16V,X7R,TP,2012	
C367	2203-000818	C-CERAMIC,CHIP	33pF,5%,50V,NPO,TP,2012	
C368	2203-000818	C-CERAMIC,CHIP	33pF,5%,50V,NPO,TP,2012	
C369	2404-000151	C-TA,CHIP	1uF,20%,16V,TP,3216	
C370	2404-000151	C-TA,CHIP	1uF,20%,16V,TP,3216	
C371	2404-000123	C-TA,CHIP	10uF,20%,16V,TP,6032,2.9mm	
C372	2203-000260	C-CERAMIC,CHIP	10nF,10%,50V,X7R,TP,2012	
C373	2404-000123	C-TA,CHIP	10uF,20%,16V,TP,6032,2.9mm	
C374	2203-000203	C-CERAMIC,CHIP	100nF,10%,16V,X7R,TP,2012	
C377	2404-000123	C-TA,CHIP	10uF,20%,16V,TP,6032,2.9mm	
C378	2203-000260	C-CERAMIC,CHIP	10nF,10%,50V,X7R,TP,2012	
C379	2404-000123	C-TA,CHIP	10uF,20%,16V,TP,6032,2.9mm	
C380	2203-000260	C-CERAMIC,CHIP	10nF,10%,50V,X7R,TP,2012	
C381	2404-000123	C-TA,CHIP	10uF,20%,16V,TP,6032,2.9mm	
C382	2203-000260	C-CERAMIC,CHIP	10nF,10%,50V,X7R,TP,2012	
C383	2404-000123	C-TA,CHIP	10uF,20%,16V,TP,6032,2.9mm	
C384	2203-000260	C-CERAMIC,CHIP	10nF,10%,50V,X7R,TP,2012	
C385	2404-000123	C-TA,CHIP	10uF,20%,16V,TP,6032,2.9mm	
C386	2203-000260	C-CERAMIC,CHIP	10nF,10%,50V,X7R,TP,2012	
C387	2404-000123	C-TA,CHIP	10uF,20%,16V,TP,6032,2.9mm	
C388	2203-000260	C-CERAMIC,CHIP	10nF,10%,50V,X7R,TP,2012	
C389	2203-000203	C-CERAMIC,CHIP	100nF,10%,16V,X7R,TP,2012	
C390	2203-000203	C-CERAMIC,CHIP	100nF,10%,16V,X7R,TP,2012	
C391	2203-000455	C-CERAMIC,CHIP	1nF,5%,50V,NPO,TP,2012	

Loc. No.	Code No.	Description	Specification	Remarks
C392	2203-000203	C-CERAMIC,CHIP	100nF,10%,16V,X7R,TP,2012	
C393	2203-000455	C-CERAMIC,CHIP	1nF,5%,50V,NPO,TP,2012	
C394	2203-000203	C-CERAMIC,CHIP	100nF,10%,16V,X7R,TP,2012	
C395	2203-000455	C-CERAMIC,CHIP	1nF,5%,50V,NPO,TP,2012	
C396	2203-000203	C-CERAMIC,CHIP	100nF,10%,16V,X7R,TP,2012	
C397	2203-000455	C-CERAMIC,CHIP	1nF,5%,50V,NPO,TP,2012	
C398	2203-000203	C-CERAMIC,CHIP	100nF,10%,16V,X7R,TP,2012	
C401	2203-000260	C-CERAMIC,CHIP	10nF,10%,50V,X7R,TP,2012	
C402	2404-000123	C-TA,CHIP	10uF,20%,16V,TP,6032,2.9mm	
C403	2203-000260	C-CERAMIC,CHIP	10nF,10%,50V,X7R,TP,2012	
C404	2404-000123	C-TA,CHIP	10uF,20%,16V,TP,6032,2.9mm	
C405	2203-000455	C-CERAMIC,CHIP	1nF,5%,50V,NPO,TP,2012	
C406	2404-000123	C-TA,CHIP	10uF,20%,16V,TP,6032,2.9mm	
C407	2203-000203	C-CERAMIC,CHIP	100nF,10%,16V,X7R,TP,2012	
C408	2402-000168	C-AL,SMD	100uF,20%,16V,TP,8x6.3	
C409	2404-000123	C-TA,CHIP	10uF,20%,16V,TP,6032,2.9mm	
C410	2203-000260	C-CERAMIC,CHIP	10nF,10%,50V,X7R,TP,2012	
C411	2203-000203	C-CERAMIC,CHIP	100nF,10%,16V,X7R,TP,2012	
C412	2404-000123	C-TA,CHIP	10uF,20%,16V,TP,6032,2.9mm	
C413	2203-000555	C-CERAMIC,CHIP	20pF,5%,50V,NPO,TP,2012	
C414	2203-000555	C-CERAMIC,CHIP	20pF,5%,50V,NPO,TP,2012	
C415	2404-000123	C-TA,CHIP	10uF,20%,16V,TP,6032,2.9mm	
C416	2203-000260	C-CERAMIC,CHIP	10nF,10%,50V,X7R,TP,2012	
C417	2203-000239	C-CERAMIC,CHIP	100pF,5%,50V,NPO,TP,2012	
C418	2203-000260	C-CERAMIC,CHIP	10nF,10%,50V,X7R,TP,2012	
C419	2404-000123	C-TA,CHIP	10uF,20%,16V,TP,6032,2.9mm	
CFT302	2901-001115	FILTER-EMI SMD	50VDC,500mADC,20pF,3.1x	
CFT317	2901-001112	FILTER-EMI SMD	50VDC,1.0ADC,85pF+-20%	
CFT318	2901-001115	FILTER-EMI SMD	50VDC,500mADC,20pF,3.1x	
CFT319	2901-001112	FILTER-EMI SMD	50VDC,1.0ADC,85pF+-20%	
CIS	BN13-10001D	IC-HYBRID/INVERTER	LXB310T,SIC180,IN	
CL101	BN27-20001C	COIL-SMD	105UH,20%,SMD,TAPING	
CL102	BN27-20001A	COIL-CHOKE	53.0UH,20%,DR10*5,TRAY	
CN101	3701-001117	CONNECTOR-DSUB	26P,2R,FEMALE,ANGLE,AU	
CN102	3722-000117	JACK-DC POWER	3P,3.5mm,AG,BLK,NO	
CN103	3711-000556	CONNECTOR-HEADER	BOX,12P,1R,1.25mm,SMD-A	
CN103_PANEL	BN39-40001B	CBF-HARNESS	12P/6P,100MM,BLU/WHT/BLK,UL1	13.3"
	BN39-40001G	CBF-HARNESS	12P,200MM,BLU/WHT/RED,UL1571	15"
CN301	3711-003161	CONNECTOR-HEADER	BOX,20P,1R,1.25mm,ANGLE	
CN301_PANEL	BN39-40001K	CBF-HARNESS	20P,200MM,BLK,UL2835,AWG28(2	13.3"
	BN39-40001J	CBF-HARNESS	20P,170MM,BLK,UL2835,AWG28-20C	15"
CN401	3711-001031	CONNECTOR-HEADER	BOX,6P,1R,2.50mm,ANGLE	
CN401_CN861	BN39-40001E	CBF-HARNESS	6P,280MM,BLK,UL2464,AWG24-6C	
D101	0401-000191	DIODE-SWITCHING	MMBD4148,50V,DL-35,TP	
D102	0401-000191	DIODE-SWITCHING	MMBD4148,50V,DL-35,TP	
D103	0401-000191	DIODE-SWITCHING	MMBD4148,50V,DL-35,TP	
D104	0401-000191	DIODE-SWITCHING	MMBD4148,50V,DL-35,TP	

9 Electrical Parts List

Loc. No.	Code No.	Description	Specification	Remarks
D105	0401-000191	DIODE-SWITCHING	MMBD4148,50V,DL-35,TP	
D106	0401-000191	DIODE-SWITCHING	MMBD4148,50V,DL-35,TP	
D109	0401-000191	DIODE-SWITCHING	MMBD4148,50V,DL-35,TP	
D110	0401-000191	DIODE-SWITCHING	MMBD4148,50V,DL-35,TP	
D113	0402-000016	DIODE-RECTIFIER	UF5404,400V,3A,DO-201AD	
D114	0402-000016	DIODE-RECTIFIER	UF5404,400V,3A,DO-201AD	
D401	0401-000191	DIODE-SWITCHING	MMBD4148,50V,DL-35,TP	
D402	0401-000191	DIODE-SWITCHING	MMBD4148,50V,DL-35,TP	
D403	0401-000191	DIODE-SWITCHING	MMBD4148,50V,DL-35,TP	
D404	0401-000191	DIODE-SWITCHING	MMBD4148,50V,DL-35,TP	
F101	3601-001061	FUSE-SMD	125V,10A,FAST ACTING,CERAMIC,6	
FT101	2901-001114	FILTER-EMI SMD	25VDC,2.0ADC,100nF,3.2x	
FT102	2901-001114	FILTER-EMI SMD	25VDC,2.0ADC,100nF,3.2x	
FT103	2901-001114	FILTER-EMI SMD	25VDC,2.0ADC,100nF,3.2x	
FT120	2901-001114	FILTER-EMI SMD	25VDC,2.0ADC,100nF,3.2x	
FT122	2901-000172	FILTER-EMI ON BOARD	50V,10A,-,12x11x13	
FT301	2901-001114	FILTER-EMI SMD	25VDC,2.0ADC,100nF,3.2x	
FT306	2901-001114	FILTER-EMI SMD	25VDC,2.0ADC,100nF,3.2x	
FT307	2901-001114	FILTER-EMI SMD	25VDC,2.0ADC,100nF,3.2x	
FT308	2901-001114	FILTER-EMI SMD	25VDC,2.0ADC,100nF,3.2x	
FT309	2901-001114	FILTER-EMI SMD	25VDC,2.0ADC,100nF,3.2x	
FT310	2901-001114	FILTER-EMI SMD	25VDC,2.0ADC,100nF,3.2x	
FT311	2901-001114	FILTER-EMI SMD	25VDC,2.0ADC,100nF,3.2x	
FT312	2901-001114	FILTER-EMI SMD	25VDC,2.0ADC,100nF,3.2x	
FT313	2901-001114	FILTER-EMI SMD	25VDC,2.0ADC,100nF,3.2x	
FT314	2901-001114	FILTER-EMI SMD	25VDC,2.0ADC,100nF,3.2x	
FT315	2901-001114	FILTER-EMI SMD	25VDC,2.0ADC,100nF,3.2x	
FT316	2901-001114	FILTER-EMI SMD	25VDC,2.0ADC,100nF,3.2x	
FT320	2901-001113	FILTER-EMI SMD	25VDC,0.2A,35pF+-20%,2x	
FT321	2901-001113	FILTER-EMI SMD	25VDC,0.2A,35pF+-20%,2x	
FT322	2901-001113	FILTER-EMI SMD	25VDC,0.2A,35pF+-20%,2x	
FT323	2901-001113	FILTER-EMI SMD	25VDC,0.2A,35pF+-20%,2x	
FT324	2901-001113	FILTER-EMI SMD	25VDC,0.2A,35pF+-20%,2x	
FT325	2901-001113	FILTER-EMI SMD	25VDC,0.2A,35pF+-20%,2x	
FT326	2901-001113	FILTER-EMI SMD	25VDC,0.2A,35pF+-20%,2x	
FT327	2901-001113	FILTER-EMI SMD	25VDC,0.2A,35pF+-20%,2x	
FT328	2901-001113	FILTER-EMI SMD	25VDC,0.2A,35pF+-20%,2x	
FT329	2901-001113	FILTER-EMI SMD	25VDC,0.2A,35pF+-20%,2x	
FT330	2901-001113	FILTER-EMI SMD	25VDC,0.2A,35pF+-20%,2x	
FT331	2901-001113	FILTER-EMI SMD	25VDC,0.2A,35pF+-20%,2x	
FT332	2901-001113	FILTER-EMI SMD	25VDC,0.2A,35pF+-20%,2x	
FT333	2901-001113	FILTER-EMI SMD	25VDC,0.2A,35pF+-20%,2x	
FT334	2901-001113	FILTER-EMI SMD	25VDC,0.2A,35pF+-20%,2x	
FT335	2901-001113	FILTER-EMI SMD	25VDC,0.2A,35pF+-20%,2x	
FT390	2901-001114	FILTER-EMI SMD	25VDC,2.0ADC,100nF,3.2x	
FT404	2901-001114	FILTER-EMI SMD	25VDC,2.0ADC,100nF,3.2x	
IC101	1002-001099	IC-A/D CONVERTER	TDA8752,8BIT,QFP,100P	



Loc. No.	Code No.	Description	Specification	Remarks
IC102	1203-000001	IC-POSI.FIXED REG.	7805,TO-220,3P,PLAS	
IC103	1203-000001	IC-POSI.FIXED REG.	7805,TO-220,3P,PLAS	
IC104	1204-000292	IC-VIDEO SYSTEM	LM1881M,SOP,8P,150MIL,PL	
IC105	0803-000117	IC-TTL	74F14,INVERTER,SOP,14P,150MIL	
IC106	0803-000122	IC-TTL	74F125,BUFFER,SOP,14P,150MIL,Q	
IC107	1203-001448	IC-POSI.FIXED REG.	2596,TO-263,5P,PLAS	
IC108	1203-001447	IC-POSI.FIXED REG.	2596,TO-263,5P,PLAS	
IC109	1203-000001	IC-POSI.FIXED REG.	7805,TO-220,3P,PLAS	
IC110	BN13-10001B	IC-ASIC	LXB530T,DLY-D1,SOP,16P,H/V POS	
IC115	1203-001538	IC-POSI.ADJUST REG.	431,SOT-89,3P,PLAS	
IC301	1205-001407	IC-BUFFER	GMFC1,QFP,208P,PLASTIC,3.6V	
IC302	1105-001165	IC-DRAM	416S1020B,2x512Kx16BIT,SOP,50P	
IC303	1105-001165	IC-DRAM	416S1020B,2x512Kx16BIT,SOP,50P	
IC304	1105-001165	IC-DRAM	416S1020B,2x512Kx16BIT,SOP,50P	
IC305	0904-001222	IC-GRAPHIC CONT.	GMZ1,QFP,208P,65MHz	
IC306	0801-000757	IC-CMOS LOGIC	74FCT244,BUFFER,SOP,20P,30	
IC307	1204-001251	IC-OSD PROCESSOR	MC141544DWR2,SOP,24P,15	
IC308	0802-001038	IC-BICMOS LOGIC	74FCT573T,TRANSPARENT LA	
IC309	0505-001170	FET-SILICON	SI9933ADY-T1,P,-20V,3.4A,0.0	
IC310	1003-001023	IC-VFD	DS90CF561,DIP,48P,600MIL,SINGL	
IC311	1003-001023	IC-VFD	DS90CF561,DIP,48P,600MIL,SINGL	
IC401	0903-001063	IC-MICROCONTROLLER	72E75,8BIT,DIP,42P,60	
IC401_SOCKET	3704-001071	SOCKET-IC	42P,DIP,SN,1.778mm	
IC402	1203-001109	IC-VOL. DETECTOR	7045,SOT-89,3P,PLASTI	
IC403	1103-001009	IC-EEPROM	24LC211,128X8BIT,DIP,8P,300MIL	
IC404	1103-001086	IC-EEPROM	24LC08B,256x8BIT,DIP,8P,300MIL	
IC405	BN13-10001A	IC-ASIC	LXB320T,A40MX04-PL44C,PLCC,44P	
IC406	0803-000122	IC-TTL	74F125,BUFFER,SOP,14P,150MIL,Q	
IC803	1201-001269	IC-AUDIO AMP	4863,DIP,16P,300MIL,DUAL	
IC804	1203-001161	IC-POSI.FIXED REG.	2576,TO-220,5P,PLAS	
L102	2703-001070	INDUCTOR-SMD	100uH,10%,4.5x3.2x3.2mm	
L151	2703-001070	INDUCTOR-SMD	100uH,10%,4.5x3.2x3.2mm	
L152	2703-001070	INDUCTOR-SMD	100uH,10%,4.5x3.2x3.2mm	
L153	2703-001070	INDUCTOR-SMD	100uH,10%,4.5x3.2x3.2mm	
L160	2703-001070	INDUCTOR-SMD	100uH,10%,4.5x3.2x3.2mm	
L170	2703-001070	INDUCTOR-SMD	100uH,10%,4.5x3.2x3.2mm	
L171	2703-001070	INDUCTOR-SMD	100uH,10%,4.5x3.2x3.2mm	
L172	2703-001070	INDUCTOR-SMD	100uH,10%,4.5x3.2x3.2mm	
L301	2703-001070	INDUCTOR-SMD	100uH,10%,4.5x3.2x3.2mm	
L302	2703-001070	INDUCTOR-SMD	100uH,10%,4.5x3.2x3.2mm	
L303	2703-001070	INDUCTOR-SMD	100uH,10%,4.5x3.2x3.2mm	
L403	2703-001070	INDUCTOR-SMD	100uH,10%,4.5x3.2x3.2mm	
L406	2703-001070	INDUCTOR-SMD	100uH,10%,4.5x3.2x3.2mm	
L407	2703-001070	INDUCTOR-SMD	100uH,10%,4.5x3.2x3.2mm	
Q101	0504-000152	TR-DIGITAL	KSR2101,PNP,200MW,4.7K-4.7K,S	
Q301	0501-000342	TR-SMALL SIGNAL	KSC1623-Y,NPN,200mW,SOT-	
Q302	0501-000342	TR-SMALL SIGNAL	KSC1623-Y,NPN,200mW,SOT-	

9 Electrical Parts List

Loc. No.	Code No.	Description	Specification	Remarks
Q401	0501-000342	TR-SMALL SIGNAL	KSC1623-Y,NPN,200mW,SOT-	
R101	2007-001166	R-CHIP	75ohm,5%,1/10W,DA,TP,2012	
R102	2007-001166	R-CHIP	75ohm,5%,1/10W,DA,TP,2012	
R103	2007-001166	R-CHIP	75ohm,5%,1/10W,DA,TP,2012	
R104	2007-000781	R-CHIP	33ohm,5%,1/10W,DA,TP,2012	
R105	2007-000781	R-CHIP	33ohm,5%,1/10W,DA,TP,2012	
R106	2007-000781	R-CHIP	33ohm,5%,1/10W,DA,TP,2012	
R107	2007-000493	R-CHIP	2.2Kohm,5%,1/10W,DA,TP,2012	
R110	2007-000290	R-CHIP	100ohm,5%,1/10W,DA,TP,2012	
R115	2007-000593	R-CHIP	22ohm,5%,1/10W,DA,TP,2012	
R116	2007-000593	R-CHIP	22ohm,5%,1/10W,DA,TP,2012	
R117	2007-001118	R-CHIP	680ohm,5%,1/10W,DA,TP,2012	
R118	2007-000593	R-CHIP	22ohm,5%,1/10W,DA,TP,2012	
R124	2007-000593	R-CHIP	22ohm,5%,1/10W,DA,TP,2012	
R125	2007-000593	R-CHIP	22ohm,5%,1/10W,DA,TP,2012	
R127	2007-000300	R-CHIP	10Kohm,5%,1/10W,DA,TP,2012	
R128	2007-000290	R-CHIP	100ohm,5%,1/10W,DA,TP,2012	
R129	2007-000822	R-CHIP	390ohm,5%,1/10W,DA,TP,2012	
R130	2007-000290	R-CHIP	100ohm,5%,1/10W,DA,TP,2012	
R131	2007-000290	R-CHIP	100ohm,5%,1/10W,DA,TP,2012	
R132	2007-000029	R-CHIP	0ohm,5%,1/10W,DA,TP,2012	
R134	2007-000300	R-CHIP	10Kohm,5%,1/10W,DA,TP,2012	
R135	2007-000029	R-CHIP	0ohm,5%,1/10W,DA,TP,2012	
R137	2007-000872	R-CHIP	4.7Kohm,5%,1/10W,DA,TP,2012	
R138	2007-000872	R-CHIP	4.7Kohm,5%,1/10W,DA,TP,2012	
R140	2007-000029	R-CHIP	0ohm,5%,1/10W,DA,TP,2012	
R190	2007-000029	R-CHIP	0ohm,5%,1/10W,DA,TP,2012	
R191	2007-000029	R-CHIP	0ohm,5%,1/10W,DA,TP,2012	
R192	2007-001113	R-CHIP	680Kohm,5%,1/10W,DA,TP,2012	
R193	2007-000029	R-CHIP	0ohm,5%,1/10W,DA,TP,2012	
R194	2007-000872	R-CHIP	4.7Kohm,5%,1/10W,DA,TP,2012	
R301	2007-000468	R-CHIP	1Kohm,5%,1/10W,DA,TP,2012	
R302	2007-000468	R-CHIP	1Kohm,5%,1/10W,DA,TP,2012	
R303	2007-000290	R-CHIP	100ohm,5%,1/10W,DA,TP,2012	
R305	2007-000300	R-CHIP	10Kohm,5%,1/10W,DA,TP,2012	
R306	2007-000290	R-CHIP	100ohm,5%,1/10W,DA,TP,2012	
R307	2007-000290	R-CHIP	100ohm,5%,1/10W,DA,TP,2012	
R308	2007-000282	R-CHIP	100Kohm,5%,1/10W,DA,TP,2012	
R309	2007-000282	R-CHIP	100Kohm,5%,1/10W,DA,TP,2012	
R310	2007-000300	R-CHIP	10Kohm,5%,1/10W,DA,TP,2012	
R311	2007-000282	R-CHIP	100Kohm,5%,1/10W,DA,TP,2012	
R312	2007-000300	R-CHIP	10Kohm,5%,1/10W,DA,TP,2012	
R316	2007-000766	R-CHIP	330ohm,5%,1/10W,DA,TP,2012	
R317	2007-000572	R-CHIP	220ohm,5%,1/10W,DA,TP,2012	
R401	2007-000941	R-CHIP	47Kohm,5%,1/10W,DA,TP,2012	
R402	2007-000941	R-CHIP	47Kohm,5%,1/10W,DA,TP,2012	
R403	2007-000941	R-CHIP	47Kohm,5%,1/10W,DA,TP,2012	

Loc. No.	Code No.	Description	Specification	Remarks
R404	2007-000941	R-CHIP	47Kohm,5%,1/10W,DA,TP,2012	
R405	2007-000941	R-CHIP	47Kohm,5%,1/10W,DA,TP,2012	
R406	2007-000941	R-CHIP	47Kohm,5%,1/10W,DA,TP,2012	
R407	2007-000941	R-CHIP	47Kohm,5%,1/10W,DA,TP,2012	
R408	2007-000941	R-CHIP	47Kohm,5%,1/10W,DA,TP,2012	
R409	2007-000941	R-CHIP	47Kohm,5%,1/10W,DA,TP,2012	
R410	2007-000872	R-CHIP	4.7Kohm,5%,1/10W,DA,TP,2012	
R411	2007-000872	R-CHIP	4.7Kohm,5%,1/10W,DA,TP,2012	
R412	2007-000941	R-CHIP	47Kohm,5%,1/10W,DA,TP,2012	
R413	2007-000941	R-CHIP	47Kohm,5%,1/10W,DA,TP,2012	
R415	2007-000941	R-CHIP	47Kohm,5%,1/10W,DA,TP,2012	
R416	2007-000941	R-CHIP	47Kohm,5%,1/10W,DA,TP,2012	
R417	2007-000290	R-CHIP	100ohm,5%,1/10W,DA,TP,2012	
R418	2007-000290	R-CHIP	100ohm,5%,1/10W,DA,TP,2012	
R419	2007-000290	R-CHIP	100ohm,5%,1/10W,DA,TP,2012	
R420	2007-000290	R-CHIP	100ohm,5%,1/10W,DA,TP,2012	
R421	2007-000290	R-CHIP	100ohm,5%,1/10W,DA,TP,2012	
R422	2007-000290	R-CHIP	100ohm,5%,1/10W,DA,TP,2012	
R423	2007-000290	R-CHIP	100ohm,5%,1/10W,DA,TP,2012	
R424	2007-000290	R-CHIP	100ohm,5%,1/10W,DA,TP,2012	
R425	2007-000290	R-CHIP	100ohm,5%,1/10W,DA,TP,2012	
R426	2007-000290	R-CHIP	100ohm,5%,1/10W,DA,TP,2012	
R427	2007-000300	R-CHIP	10Kohm,5%,1/10W,DA,TP,2012	
R429	2007-000290	R-CHIP	100ohm,5%,1/10W,DA,TP,2012	
R431	2007-000401	R-CHIP	150ohm,5%,1/10W,DA,TP,2012	
R432	2007-000290	R-CHIP	100ohm,5%,1/10W,DA,TP,2012	
R433	2007-000290	R-CHIP	100ohm,5%,1/10W,DA,TP,2012	
R436	2007-000290	R-CHIP	100ohm,5%,1/10W,DA,TP,2012	
R437	2007-000290	R-CHIP	100ohm,5%,1/10W,DA,TP,2012	
R438	2007-000290	R-CHIP	100ohm,5%,1/10W,DA,TP,2012	
R439	2007-000290	R-CHIP	100ohm,5%,1/10W,DA,TP,2012	
R440	2007-000290	R-CHIP	100ohm,5%,1/10W,DA,TP,2012	
R441	2007-000290	R-CHIP	100ohm,5%,1/10W,DA,TP,2012	
R442	2007-000290	R-CHIP	100ohm,5%,1/10W,DA,TP,2012	
R443	2007-000290	R-CHIP	100ohm,5%,1/10W,DA,TP,2012	
R444	2007-000290	R-CHIP	100ohm,5%,1/10W,DA,TP,2012	
R445	2007-000290	R-CHIP	100ohm,5%,1/10W,DA,TP,2012	
R447	2007-000290	R-CHIP	100ohm,5%,1/10W,DA,TP,2012	
R448	2007-000290	R-CHIP	100ohm,5%,1/10W,DA,TP,2012	
R449	2007-000468	R-CHIP	1Kohm,5%,1/10W,DA,TP,2012	
R450	2007-000686	R-CHIP	3.3Kohm,5%,1/10W,DA,TP,2012	
R451	2007-000686	R-CHIP	3.3Kohm,5%,1/10W,DA,TP,2012	
R452	2007-000468	R-CHIP	1Kohm,5%,1/10W,DA,TP,2012	
R455	2007-000477	R-CHIP	1Mohm,5%,1/10W,DA,TP,2012	
R456	2007-000572	R-CHIP	220ohm,5%,1/10W,DA,TP,2012	
R457	2007-000290	R-CHIP	100ohm,5%,1/10W,DA,TP,2012	
R458	2007-000290	R-CHIP	100ohm,5%,1/10W,DA,TP,2012	

9 Electrical Parts List

Loc. No.	Code No.	Description	Specification	Remarks
R459	2007-000409	R-CHIP	15Kohm,5%,1/10W,DA,TP,2012	
R460	2007-000409	R-CHIP	15Kohm,5%,1/10W,DA,TP,2012	
R461	2007-000290	R-CHIP	100ohm,5%,1/10W,DA,TP,2012	
R462	2007-000290	R-CHIP	100ohm,5%,1/10W,DA,TP,2012	
R463	2007-000290	R-CHIP	100ohm,5%,1/10W,DA,TP,2012	
R464	2007-000300	R-CHIP	10Kohm,5%,1/10W,DA,TP,2012	
R465	2007-000941	R-CHIP	47Kohm,5%,1/10W,DA,TP,2012	
RA101	2011-000002	R-NETWORK	22ohm,5%,1/16W,L,CHIP,8P,TP	
RA102	2011-000002	R-NETWORK	22ohm,5%,1/16W,L,CHIP,8P,TP	
RA103	2011-000002	R-NETWORK	22ohm,5%,1/16W,L,CHIP,8P,TP	
RA104	2011-000002	R-NETWORK	22ohm,5%,1/16W,L,CHIP,8P,TP	
RA105	2011-000002	R-NETWORK	22ohm,5%,1/16W,L,CHIP,8P,TP	
RA106	2011-000002	R-NETWORK	22ohm,5%,1/16W,L,CHIP,8P,TP	
RA107	2011-001015	R-NETWORK	1Kohm,5%,1/16W,L,CHIP,8P,TP	
RA108	2011-001015	R-NETWORK	1Kohm,5%,1/16W,L,CHIP,8P,TP	
RA109	2011-001015	R-NETWORK	1Kohm,5%,1/16W,L,CHIP,8P,TP	
RA110	2011-001015	R-NETWORK	1Kohm,5%,1/16W,L,CHIP,8P,TP	
RA111	2011-001015	R-NETWORK	1Kohm,5%,1/16W,L,CHIP,8P,TP	
RA112	2011-001015	R-NETWORK	1Kohm,5%,1/16W,L,CHIP,8P,TP	
RA301	2011-000002	R-NETWORK	22ohm,5%,1/16W,L,CHIP,8P,TP	
RA302	2011-000002	R-NETWORK	22ohm,5%,1/16W,L,CHIP,8P,TP	
RA303	2011-000002	R-NETWORK	22ohm,5%,1/16W,L,CHIP,8P,TP	
RA304	2011-000002	R-NETWORK	22ohm,5%,1/16W,L,CHIP,8P,TP	
RA305	2011-000002	R-NETWORK	22ohm,5%,1/16W,L,CHIP,8P,TP	
RL101	3501-000322	RELAY-POWER	5V,200mW,8A,1FormA1B,10mS,10	
SW301	3408-001027	SWITCH-SLIDE	30VDC,0.3A,1C2P,<OFF-ON>	
VR843	2101-001041	VR-ROTARY	50Kohm,20%,1/20W, TOP	
X301	2804-001217	OSCILLATOR-CLOCK	67MHz,100ppm,10TTL & CM	
X302	2804-001164	OSCILLATOR-CLOCK	85MHz,100ppm,10TTL(15pF	
X401	2801-003611	CRYSTAL-UNIT	24MHz,30ppm,28-AAA,20pF,50o	
ZD101	0403-000579	DIODE-ZENER	BZX84C5V1,5.1V,5%,330mW,SOT-	
ZD102	0403-000579	DIODE-ZENER	BZX84C5V1,5.1V,5%,330mW,SOT-	
ZD103	0403-000579	DIODE-ZENER	BZX84C5V1,5.1V,5%,330mW,SOT-	
ZD104	0403-000579	DIODE-ZENER	BZX84C5V1,5.1V,5%,330mW,SOT-	
ZD105	0403-000579	DIODE-ZENER	BZX84C5V1,5.1V,5%,330mW,SOT-	
ZD401	0403-000579	DIODE-ZENER	BZX84C5V1,5.1V,5%,330mW,SOT-	

## 9-2 Sub PCB Parts

Loc. No.	Code No.	Description	Specification	Remarks
BD801	3301-000011	CORE-FERRITE BEAD	AA,3.5x1.0x5.7mm,1500,2375G	
BD802	3301-000011	CORE-FERRITE BEAD	AA,3.5x1.0x5.7mm,1500,2375G	
BD803	3301-000011	CORE-FERRITE BEAD	AA,3.5x1.0x5.7mm,1500,2375G	
C801	2401-000164	C-AL	1000uF,20%,25V,WT,12.5x20mm,5m	
C802	2201-000177	C-CERAMIC,DISC	10nF,10%,50V,Y5P,12.5X4.0,5,TP	
C803	2301-000016	C-FILM,PEF	22nF,5%,100V,7.2x4.5x9.0mm,5mm	
C804	2401-000613	C-AL	1uF,20%,50V,WT,5x11mm,5mm,TP	
C810	2305-000624	C-FILM,MPEF	330nF,10%,100V,5mm,TP	
C811	2305-000624	C-FILM,MPEF	330nF,10%,100V,5mm,TP	
C812	2305-000624	C-FILM,MPEF	330nF,10%,100V,5mm,TP	
C813	2301-000184	C-FILM,PEF	1nF,10%,100V,5.3x10mm,5mm,TP	
C814	2401-000613	C-AL	1uF,20%,50V,WT,5x11mm,5mm,TP	
C815	2401-001334	C-AL	470nF,20%,50V,GP,5x11mm,2mm,TP	
C816	2401-000310	C-AL	100uF,20%,25V,GP,8x11.5mm,3.5m	
C820	2401-000042	C-AL	100uF,20%,16V,GP,6.3x7mm,2.5mm	
C841	2301-000012	C-FILM,PEF	2.2nF,5%,100V,10.5x12.5x6.5,5m	
C842	2301-000012	C-FILM,PEF	2.2nF,5%,100V,10.5x12.5x6.5,5m	
C843	2301-000016	C-FILM,PEF	22nF,5%,100V,7.2x4.5x9.0mm,5mm	
C844	2301-000016	C-FILM,PEF	22nF,5%,100V,7.2x4.5x9.0mm,5mm	
C845	2301-000016	C-FILM,PEF	22nF,5%,100V,7.2x4.5x9.0mm,5mm	
C846	2301-000016	C-FILM,PEF	22nF,5%,100V,7.2x4.5x9.0mm,5mm	
C847	2301-000380	C-FILM,PEF	10nF,5%,50V,TP,6.5x3mm,5mm	
C848	2301-000380	C-FILM,PEF	10nF,5%,50V,TP,6.5x3mm,5mm	
C849	2301-000380	C-FILM,PEF	10nF,5%,50V,TP,6.5x3mm,5mm	
C850	2301-000380	C-FILM,PEF	10nF,5%,50V,TP,6.5x3mm,5mm	
CN801	3721-001006	PLUG-AC POWER	3P,10/24mm,SN	
CN803	3722-000117	JACK-DC POWER	3P,3.5MM,AG,BLK,NO	
CN804	3711-000211	CONNECTOR-HEADER	1WALL,3P,1R,3.96MM,STRAIGHT,SN	
CN805	3711-003942	CONNECTOR-HEADER	BOX,2P,1R,2mm,STRAIGHT,SN	
CN806	3711-003843	CONNECTOR-HEADER	BOX,8P,1R,2mm,STRAIGHT,SN	
CN806_CN841	BN39-40001C	CBF-HARNESS	8P,110MM,BLU/RED/WHT,UL1007	
CN808	3722-001009	JACK-PHONE	3P/2C,3.6PI,AG,BLK	
CN809	3722-001009	JACK-PHONE	3P/2C,3.6PI,AG,BLK	
CN810	3722-001101	JACK-USB	4P/2C,8.38mm,AU,IVR,#22-28	
CN811	3722-001051	JACK-DIN	4P,5.12mm,AU,NTR	
CN812	3722-001055	JACK-PHONE	5P/2C,3.6mm,AG,BLK,#16-22	
CN813	3722-001055	JACK-PHONE	5P/2C,3.6mm,AG,BLK,#16-22	
CN814	3711-003942	CONNECTOR-HEADER	BOX,2P,1R,2mm,STRAIGHT,SN	
CN815	3711-003942	CONNECTOR-HEADER	BOX,2P,1R,2mm,STRAIGHT,SN	
CN816	3711-000262	CONNECTOR-HEADER	1WALL,5P,1R,3.96mm,ANGLE,SN	
CN841	3711-003846	CONNECTOR-HEADER	BOX,8P,1R,2mm,ANGLE,SN	
CN861	3711-001031	CONNECTOR-HEADER	BOX,6P,1R,2.50mm,ANGLE,SN	
CN862	3711-000058	CONNECTOR-HEADER	BOX,4P,1R,2.5mm,ANGLE,SN	
CN862_CN881	BN39-40001D	CBF-HARNESS	4P,80MM,BLU/RED/WHT,UL1007,A	
CN881	3711-000058	CONNECTOR-HEADER	BOX,4P,1R,2.5mm,ANGLE,SN	
CN882	BN39-40001F	CBF-HARNESS	50MM,BLK,UL1015,AWG18,ST71	
D801	0402-000016	DIODE-RECTIFIER	UF5404,400V,3A,DO-201AD	



9 Electrical Parts List

Loc. No.	Code No.	Description	Specification	Remarks
D802	0401-000005	DIODE-SWITCHING	1N4148,75V,150mA,500mW,4nS,DO-	
IC803	1201-001269	IC-AUDIO AMP	4863,DIP,16P,300MIL,DUAL,PLA	
IC804	1203-001161	IC-POSI.FIXED REG.	2576,TO-220,5P,PLASTIC,4.9/5	
L801	BH27-20344D	COIL-CHOKE	50UH,10%,DR8*8,TAPING	
OP881	0601-001036	LED	ROUND,GRN/YEL,4.75mm,565/585nm	
Q802	0501-000586	TR-NPN,KSC945,TO-92,EBC	0.25W,60V,50V,5V,0.15A	
R809	2001-000464	R-CARBON	2.4Kohm,5%,1/6W,AA,TP,1.8x3.2m	
R810	2001-000043	REF-CF,1K,5%,1/6W	150V,-1300 TO +350PPM,R-AXIAL	
R811	2001-000029	REF-CF,100,5%,1/6W	150V,-1300 TO +350PPM/C,R-AXIAL	
R812	2001-000029	REF-CF,100,5%,1/6W	150V,-1300 TO +350PPM/C,R-AXIAL	
R813	2001-000067	R-CARBON	10Kohm,5%,1/6W,AA,TP,1.8x3.2mm	
R814	2001-000059	R-CARBON	5.6Kohm,5%,1/6W,AA,TP,1.8x3.2m	
R815	2001-000496	R-CARBON	20Kohm,5%,1/6W,AA,TP,1.8x3.2mm	
R816	2001-000484	R-CARBON	200Kohm,5%,1/6W,AA,TP,1.8x3.2m	
R817	2001-000029	REF-CF,100,5%,1/6W	150V,-1300 TO +350PPM/C,R-AXIAL	
R818	2001-000496	R-CARBON	20Kohm,5%,1/6W,AA,TP,1.8x3.2mm	
R819	2001-000484	R-CARBON	200Kohm,5%,1/6W,AA,TP,1.8x3.2m	
R820	2001-000029	REF-CF,100,5%,1/6W	150V,-1300 TO +350PPM/C,R-AXIAL	
R821	2001-000086	R-CARBON	100Kohm,5%,1/6W,AA,TP,1.8x3.2m	
R822	2001-000086	R-CARBON	100Kohm,5%,1/6W,AA,TP,1.8x3.2m	
R841	2001-000040	R-CARBON	470ohm,5%,1/6W,AA,TP,1.8x3.2mm	
R842	2001-000040	R-CARBON	470ohm,5%,1/6W,AA,TP,1.8x3.2mm	
R843	2001-000496	R-CARBON	20Kohm,5%,1/6W,AA,TP,1.8x3.2mm	
R844	2001-000496	R-CARBON	20Kohm,5%,1/6W,AA,TP,1.8x3.2mm	
R845	2001-000059	R-CARBON	5.6Kohm,5%,1/6W,AA,TP,1.8x3.2m	
R846	2001-000059	R-CARBON	5.6Kohm,5%,1/6W,AA,TP,1.8x3.2m	
R861	2001-000067	R-CARBON	10Kohm,5%,1/6W,AA,TP,1.8x3.2mm	
R862	2001-000104	R-CARBON	1.2Kohm,5%,1/6W,AA,TP,1.8x3.2m	
R863	2001-000104	R-CARBON	1.2Kohm,5%,1/6W,AA,TP,1.8x3.2m	
R864	2001-000059	R-CARBON	5.6Kohm,5%,1/6W,AA,TP,1.8x3.2m	
R865	2001-000069	R-CARBON	12Kohm,5%,1/6W,AA,TP,1.8x3.2mm	
R866	2001-000067	R-CARBON	10Kohm,5%,1/6W,AA,TP,1.8x3.2mm	
R867	2001-000562	R-CARBON	27Kohm,5%,1/6W,AA,TP,1.8x3.2mm	
R868	2001-000069	R-CARBON	12Kohm,5%,1/6W,AA,TP,1.8x3.2mm	
R869	2001-000051	R-CARBON	2.7Kohm,5%,1/6W,AA,TP,1.8x3.2m	
R881	2001-000040	R-CARBON	470ohm,5%,1/6W,AA,TP,1.8x3.2mm	
R882	2001-000404	R-CARBON	180ohm,5%,1/6W,AA,TP,1.8x3.2mm	
SW841	3403-001048	SWITCH-PUSH	30V,100mA,DPDT,ON-OFF	
SW861	3404-000243	SWITCH-TACT	15V,20mA,160gf+-50gf,6x3.4mm,S	
SW862	3404-000243	SWITCH-TACT	15V,20mA,160gf+-50gf,6x3.4mm,S	
SW863	3404-000243	SWITCH-TACT	15V,20mA,160gf+-50gf,6x3.4mm,S	
SW864	3404-000243	SWITCH-TACT	15V,20mA,160gf+-50gf,6x3.4mm,S	
SW865	3404-000243	SWITCH-TACT	15V,20mA,160gf+-50gf,6x3.4mm,S	
SW866	3404-000243	SWITCH-TACT	15V,20mA,160gf+-50gf,6x3.4mm,S	
SW881	3404-000243	SWITCH-TACT	15V,20mA,160gf+-50gf,6x3.4mm,S	
VR841	2101-001040	VR-ROTARY	50Kohm,20%,1/30W,SIDE	
VR842	2101-001041	VR-ROTARY	50Kohm,20%,1/20W,TOP	

Loc. No.	Code No.	Description	Specification	Remarks
VR843	2101-001041	VR-ROTARY	50Kohm,20%,1/20W,TOP	
ZD801	0403-000003	DIODE-ZENER	UZ8.2BL,8.2V,7.7-8.2V,500mW,DO	
ZD802	0403-000003	DIODE-ZENER	UZ8.2BL,8.2V,7.7-8.2V,500mW,DO	
ZD803	0403-000003	DIODE-ZENER	UZ8.2BL,8.2V,7.7-8.2V,500mW,DO	
ZD861	0403-000003	DIODE-ZENER	UZ8.2BL,8.2V,7.7-8.2V,500mW,DO	
ZD862	0403-000003	DIODE-ZENER	UZ8.2BL,8.2V,7.7-8.2V,500mW,DO	

**Others**

Loc. No.	Code No.	Description	Specification	Remarks
LCD	BH07-10050E	LCD	LT133XM-101,303*223*13,TFT,STR	
	BN07-10001A	LCD	LT150X1-102,368*275*20	
P/CORD	BH39-10007A	CBF POWER CORD	DET,250V/6A,H05VV-F,LP-34	
	BH39-10340F	CBF POWER CORD	DET,H05VV-F,250V/10A,IV27,1830MM	
	BH39-10307W	CBF POWER CORD	VCTF,IVY,1830MM,N,LP-54	
S/CABLE	BH39-20001A	CBF-SIGNAL	DET,2100MM,15P/26P,IVORY,UL299	
SPEAKER	BN30-10001A	SPEAKER-UNIT	1.5W,4ohm,84+-2db,500Hz,500	
ADAPTOR	BN94-80001B	ASS'Y,ADAPTOR	13.3",15"	
PROCESS-PBA UNIT	BN94-30001D	ASS'Y,PCB	13.3",SAMSUNG	
	BN94-30001E	ASS'Y,PCB	15",SAMSUNG	
	BN94-30001H	ASS'Y,PCB	MCF3811TA,SIEMENS	
B/D ASS'Y CODE	BN98-10001E	ASS'Y,PCB/MAIN	13.3",SAMSUNG	
	BN98-10001F	ASS'Y,PCB/MAIN	15",SAMSUNG	
	BN98-10001J	ASS'Y,PCB/MAIN	MCF3811TA,SIEMENS	
	BN98-90001D	ASS'Y,PCB/MISC	13.3",15",SAMSUNG	





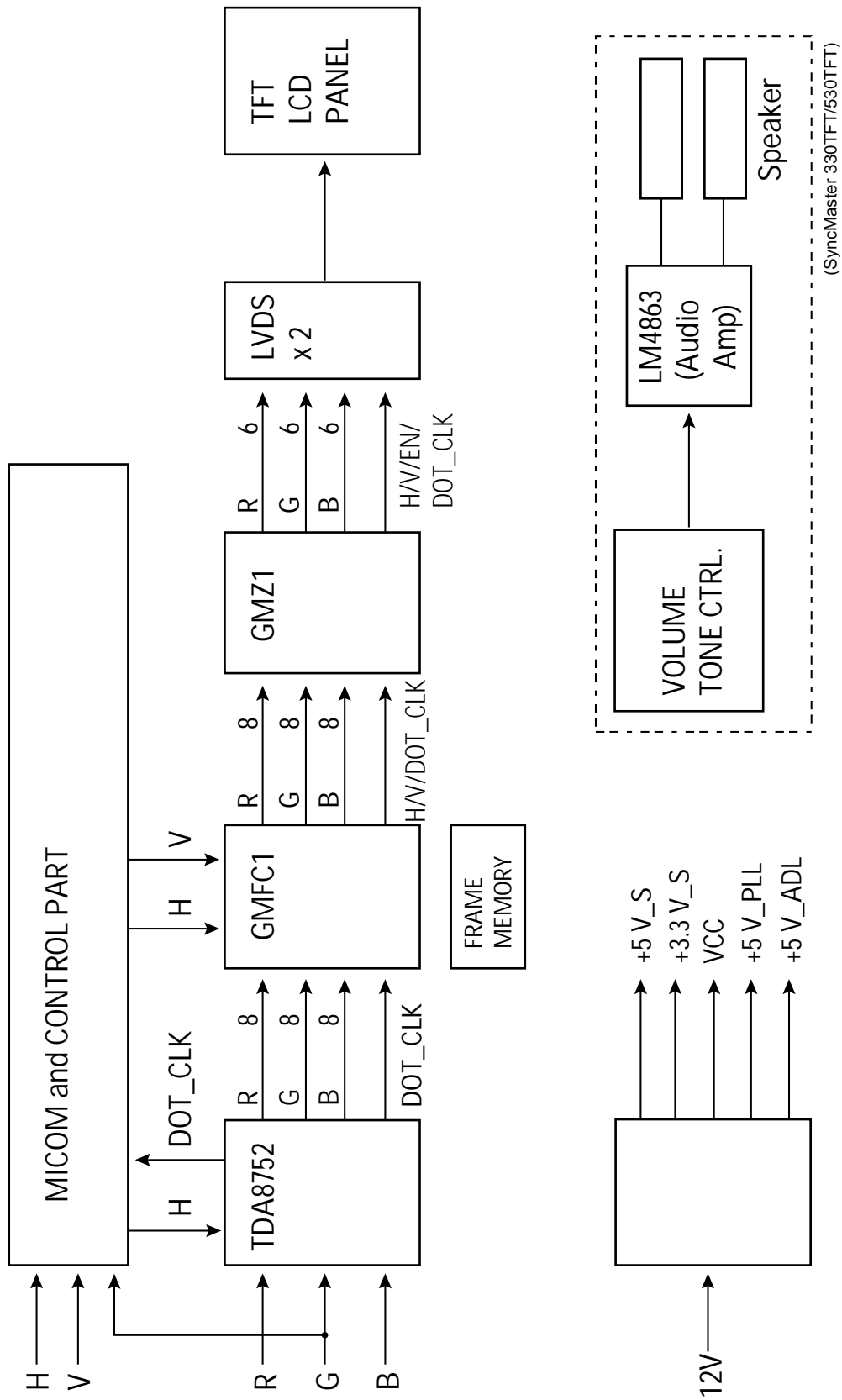

# 8 Block Diagram



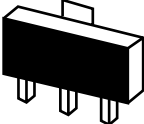
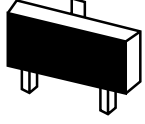
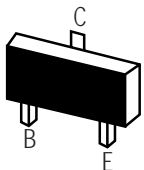
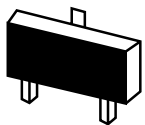
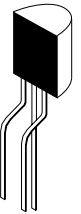
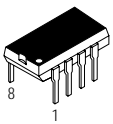
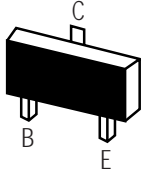
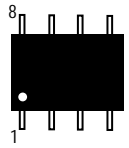
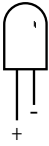
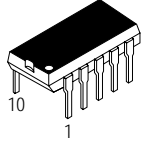

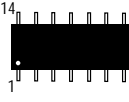
## Memo

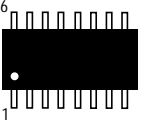
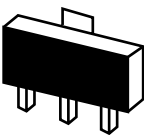
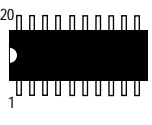
### 10-2 Semiconductor Lead Identification

PARTS	TYPE NO.	REF. NO.	PARTS	TYPE NO.	REF. NO.
	431	D115		BZX84C5V1	ZD101, ZD102, ZD103, ZD104, ZD105, ZD401
	KSC1623	Q301, Q302, Q401		MMBD4148	D101, D102, D103, D104, D105, D106, D109, D110, D401, D402, D403, D404
	KSC945	Q801, Q802		24LC08B	IC404
				24LC211	IC403
	KSR2101	Q101		S19933ADY-T1	IC309
				LM1881M	IC104
	LED	OP881		LM2596	IC107, IC108
				LM2596S	IC804
	KA7805	IC102, IC103, IC109		74F14	IC105
				74F125	IC106
	LM2576	IC805		LM4863	IC803
				MC34067P	IC110
				MC141544-DWR2	IC307-
	7045	IC402		74FCT244	IC306
				74FCT573M	IC308

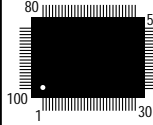
10 PCB Diagrams

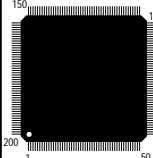
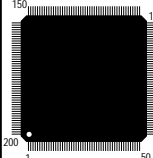
PARTS	TYPE NO.	REF. NO.	PARTS	TYPE NO.	REF. NO.
	DS90CF561	IC310, IC311		TDA8752	IC101
	416S1020B	IC302, IC303, IC304		GMFC1	IC301
				GMZ1	IC305

# 11 Wiring Diagram

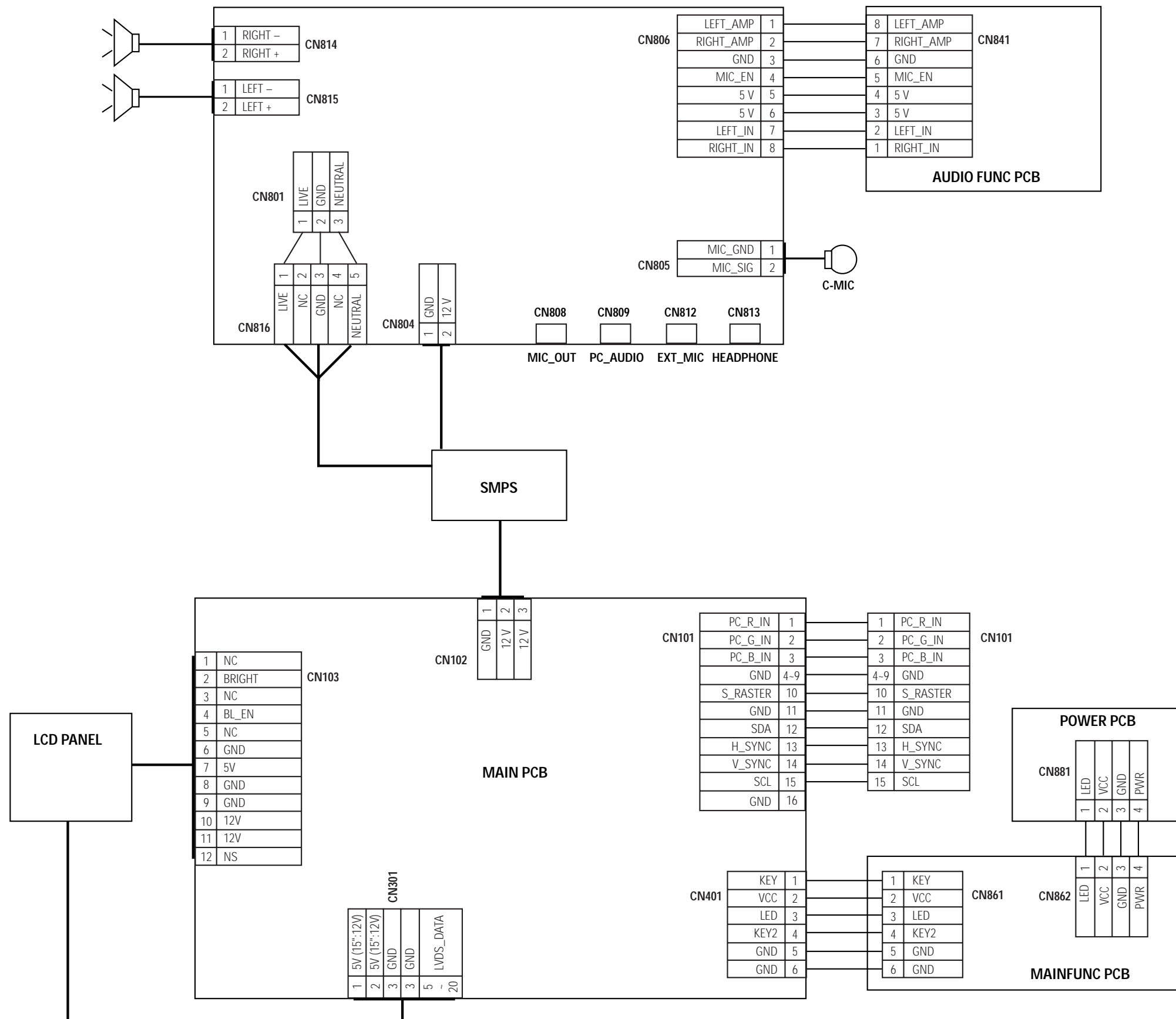

# 12 Schematic Diagrams

## 12-1 DAC & IO Part Schematic Diagram

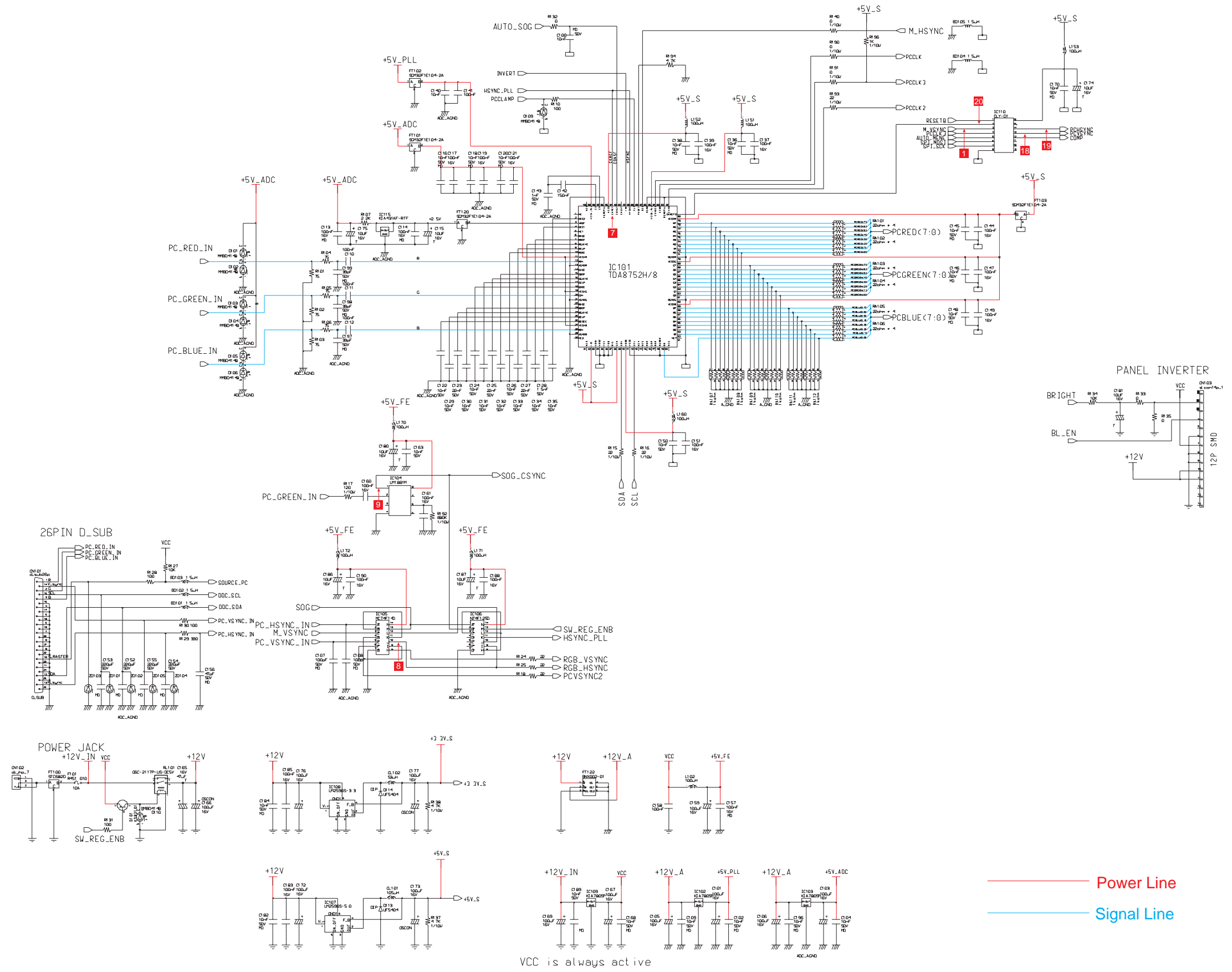

Table 12-1. IC102

pin #	MODES
	1024 x 768 / 85 Hz
1	12
2	GND
3	5

Unit: Vrms

Table 12-2. IC103

pin #	MODES
	1024 x 768 / 85 Hz
1	12
2	GND
3	5

Unit: Vrms

Table 12-3. IC107

pin #	MODES
	1024 x 768 / 85 Hz
1	12
2	5
3	GND
4	5
5	GND

Unit: Vrms

Table 12-4. IC108

pin #	MODES
	1024 x 768 / 85 Hz
1	12
2	3.3
3	GND
4	3.3
5	GND

Unit: Vrms

Table 12-5. IC109

pin #	MODES
	1024 x 768 / 85 Hz
1	12
2	GND
3	5

Unit: Vrms

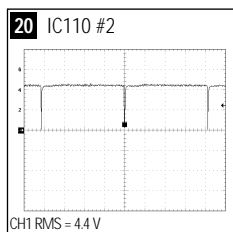
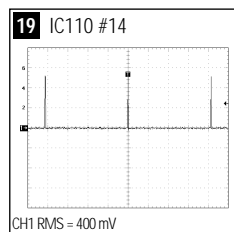
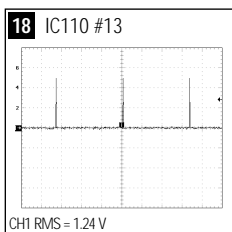
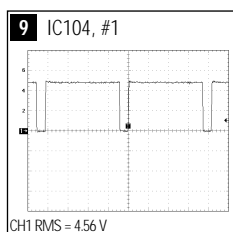
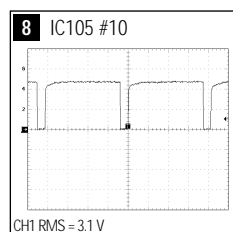
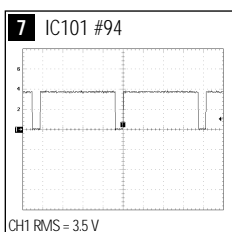
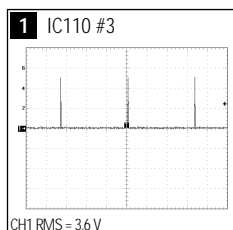

12-2 ZOOM & FRC Part Schematic Diagram

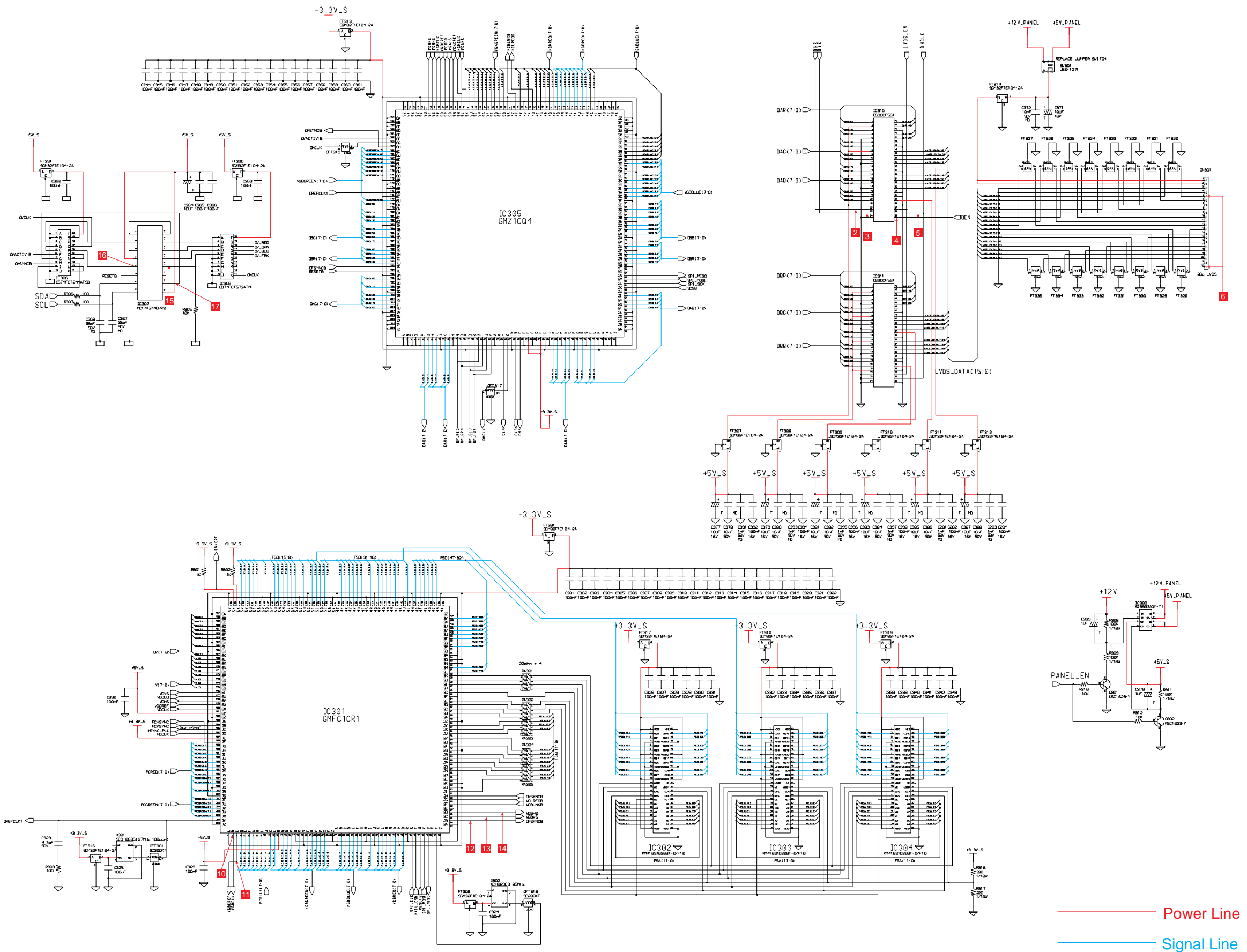
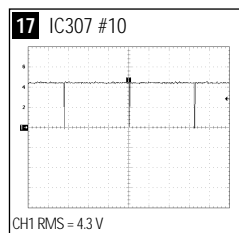
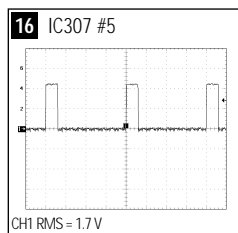
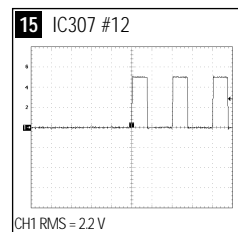
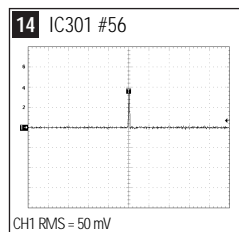
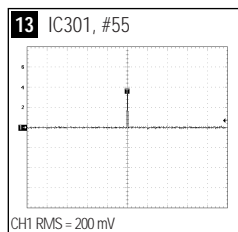
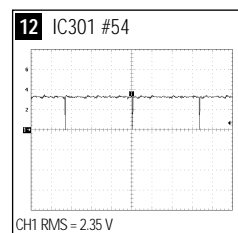
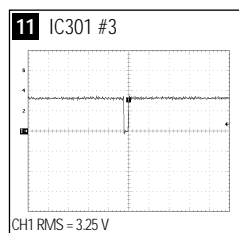
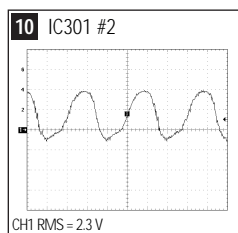
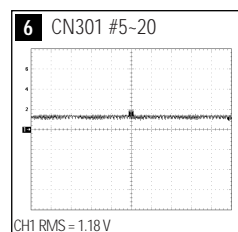
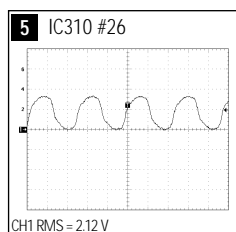
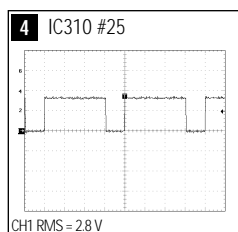
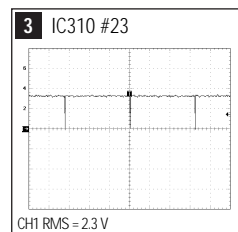
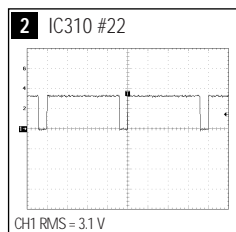



Table 12-6. IC309

pin #	MODES
	1024 x 768 / 85 Hz
1	11.96
2	5.90
3	4.99
4	5.8 mV
5	4.99
6	4.99
7	11.95
8	11.95

Unit: Vrms



### 12-3 Micom Part Schematic Diagram

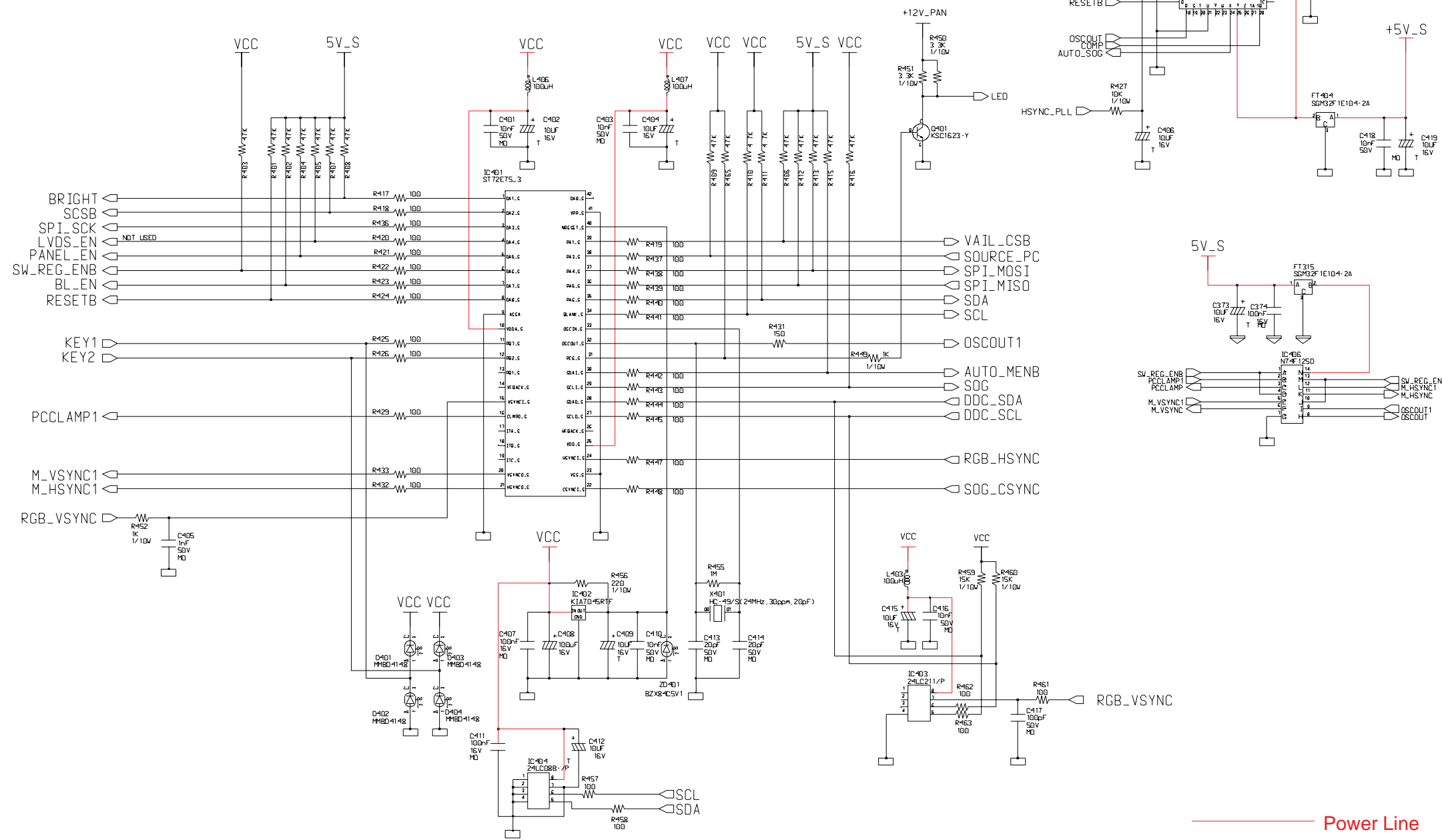
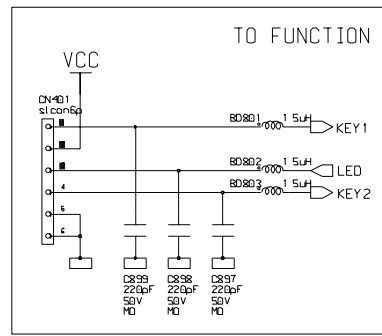

Table 12-7. IC401

pin #	MODES		pin #	MODES	
	1024 x 768 / 85 Hz			1024 x 768 / 85 Hz	
1	59.8 mV		22	3.44	
2	5		23	GND	
3	5		24	4.16	
4	5		25	5.01	
5	4.62		26	4.97	
6	0.457		27	4.46	
7	4.91		28	4.43	
8	5		29	4.78	
9	GND		30	4.77	
10	5.03		31	14.07	
11	5.02		32	2.226	
12	5.02		33	2.238	
13	NC		34	5.03	
14	NC		35	5.03	
15	4.94		36	4.96	
16	93.7 mV		37	4.96	
17	3.217		38	52.7 mV	
18	4.97		39	4.96	
19	5.01		40	4.87	
20	63.0 mV		41	GND	
21	0.476		42	9.7 mV	

Unit: Vrms

Table 12-8. IC403

pin #	MODES	
	1024 x 768 / 85 Hz	
1	NC	
2	NC	
3	NC	
4	GND	
5	4.43	
6	4.46	
7	4.87	
8	5.03	

Unit: Vrms

Table 12-9. IC404

pin #	MODES	
	1024 x 768 / 85 Hz	
1	GND	
2	GND	
3	GND	
4	GND	
5	5.03	
6	5.03	
7	GND	
8	5.03	

Unit: Vrms

### 12-4 Sub Part Schematic Diagram

Table 12-10. IC803

pin#	MODES	
	1024 x 768 / 85 Hz	
1	GND	
2	GND	
3	Signal (+2.5 V Bias)	
4	5	
5	Signal (+2.5 V Bias)	
6	Input Signal (+2.5 V Bias)	
7	GND	
8	2.5	
9	2.5	
10	2.5	
11	Input Signal (+2.5 V Bias)	
12	Signal (+2.5 V Bias)	
13	5	
14	Signal (+2.5 V Bias)	
15	GND	
16	2.5 V (Headphone : 5 V)	

Unit: Vrms

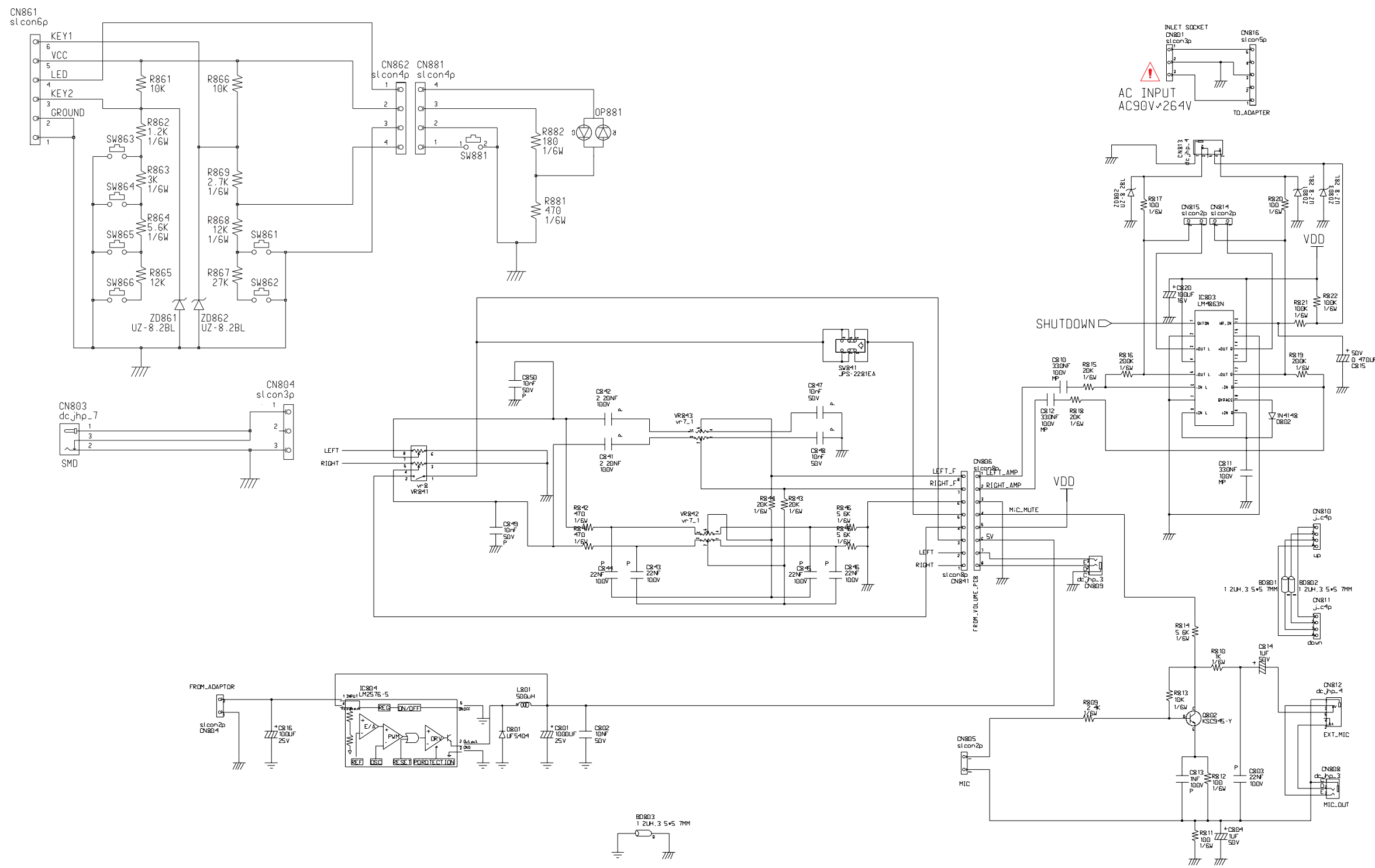

## Memo