

## Philips LCD Monitor Electronic User's Manual

[Home](#)

[safety and  
troubleshooting](#)

[about this  
manual](#)

[product  
information](#)

[installing your  
monitor](#)

[on-screen  
display](#)

[customer care  
and warranty](#)

[glossary](#)

[download  
& print](#)

### LCD Monitor **150S5**



- Safety Precautions and Maintenance
- Installation Locations
- FAQs
- Troubleshooting
- Regulatory Information
- Other Related Information

## Safety and Troubleshooting Information

---

### Safety precautions and maintenance



**WARNING: Use of controls, adjustments or procedures other than those specified in this documentation may result in exposure to shock, electrical hazards and/or mechanical hazards.**

Read and follow these instructions when connecting and using your computer monitor:

- Unplug the monitor if you are not going to use it for an extensive period of time.
- Unplug the monitor if you need to clean it with a slightly damp cloth. The screen may be wiped with a dry cloth when the power is off. However, never use alcohol, solvents or ammonia-based liquids.
- Consult a service technician if the monitor does not operate normally when you have followed the instructions in this manual.
- The casing cover should be opened only by qualified service personnel.
- Keep the monitor out of direct sunlight and away from stoves or any other heat source.
- Remove any object that could fall into the vents or prevent proper cooling of the monitor's electronics.
- Do not block the ventilation holes on the cabinet.
- Keep the monitor dry. To avoid electric shock, do not expose it to rain or excessive moisture.
- When positioning the monitor, make sure the power plug and outlet are easily accessible.
- If turning off the monitor by detaching the power cable or DC power cord, wait for 6 seconds before attaching the power cable or DC power cord for normal operation.
- To avoid the risk of shock or permanent damage to the set, do not expose the monitor to rain or excessive moisture.
- **IMPORTANT:** Always activate a screen saver program during your application. If a still image in high contrast remains on the screen for an extended period of time, it may leave an 'after-image' or 'ghost image' on front of the screen. This is a well-known phenomenon that is caused by the shortcomings inherent in LCD technology. In most cases, the after-image will disappear gradually over a period of time after the power has been switched off. Be aware, that the after-image symptom cannot be repaired and is not covered under warranty.

Consult a service technician if the monitor does not operate normally when the operating instructions given in this manual have been followed.

[RETURN TO TOP OF THE PAGE](#)

---

### Installation Locations

- Avoid exposure to heat and extreme cold.
- Do not store or use the LCD monitor in locations exposed to heat, direct sunlight or extreme cold.
- Avoid moving the LCD monitor between locations with large temperature differences. Choose a site that falls within the following temperature and humidity ranges.
  - Temperature: 5-40°C 41-104°F
  - Humidity: 20-80% RH
- Do not subject the LCD monitor to severe vibration or high impact conditions. Do not place the LCD monitor in the trunk of a car.
- Take care not to mishandle this product by either knocking or dropping it during operation or transportation.
- Do not store or use the LCD monitor in locations where there is a high level of humidity or in dusty environments. Do not allow water or other liquids to spill on or into the LCD monitor.

[RETURN TO TOP OF THE PAGE](#)

- [About This Guide](#)
- [Notational Descriptions](#)

## About This Manual

---

### About This Guide

This electronic user's guide is intended for anyone who uses the Philips LCD Monitor. It describes the LCD monitor's features, setup, operation and other important information. Its contents are identical to the information in our printed version.

It includes the following sections:

- [Safety and Troubleshooting Information](#) provides tips and solutions for common problems as well as other related information you may need.
- About This Electronic User's Manual gives an overview of information included, along with notation icon descriptions and other documentation for your reference.
- [Product Information](#) gives an overview of the monitor's features as well as the technical specifications for this monitor.
- [Installing Your Monitor](#) describes the initial setup process and gives an overview of how to use the monitor.
- [On-Screen Display](#) provides information on adjusting the settings on your monitor.
- [Customer Care and Warranty](#) contains a list of worldwide Philips Consumer Information Centers along with help desk phone numbers and information on the warranty applicable to your product.
- [Glossary](#) defines technical terms.
- [Download and Print Option](#) transfers this entire manual to your hard drive for easy reference.

[RETURN TO TOP OF THE PAGE](#)

---

### Notational Descriptions

The following subsections describe notational conventions used in this document.

#### Notes, Cautions and Warnings

Throughout this guide, blocks of text may be accompanied by an icon and printed in bold or italic type. These blocks contain notes, cautions or warnings. They are used as follows:



**NOTE:** This icon indicates important information and tips that help you make better use of your computer system.



**CAUTION:** This icon indicates information that tells you how to avoid either potential damage to hardware or loss of data.



**WARNING:** This icon indicates the potential for bodily harm and tells you how to avoid the problem.

Some warnings may appear in alternate formats and may not be accompanied by an icon. In such cases, the specific presentation of the warning is mandated by the relevant regulatory authority.

[RETURN TO TOP OF THE PAGE](#)

---

©2004 Koninklijke Philips Electronics NV

All rights reserved. Reproduction, copying, use, modification, hiring, renting, public performance, transmission and/or broadcasting in whole or in part is prohibited without written consent of Philips Electronics NV

- SmartManage
- Product Features
- Technical Specifications
- Resolution & Preset Modes
- Philips Pixel Defect Policy
- Automatic Power Saving
- Physical Specification
- Pin Assignment
- Product Views
- Physical Function

## Product Information

### Product Features

#### 150S5

- **Best Total Cost of Ownership solution**
  - Lower power consumption ~ Less cost: up to 20% power savings than industry average
  - Kensington anti-theft lock ~ Added security prevents theft by locking monitor in place
- **Outstanding front of screen performance**
  - Fast response time ~ Get the job done quicker with fast response time
  - XGA, 1024 x 768 resolution ~ Accurate color displaying with high resolution 1024x768 XGA
  - sRGB ready ~ What you see is what you get: Display matches printout
- **Great Convenience**
  - Embedded power supply ~ Power supply built into monitor
  - VESA mounting hole ~ VESA mounting pattern for easy wall mounting your display
  - FlexiHolder ~ Flexible card, photo, and notes holder to increase efficiency

[RETURN TO TOP OF THE PAGE](#)

### Technical Specifications\*

<b>LCD PANEL</b>	
• Type	TFT LCD
• Screen size	15" visual
• Pixel Pitch	0.297 x 0.297 mm
• LCD Panel type	1024 x 768 pixels R.G.B. vertical stripe Anti-glare polarizer, hard coated
• Effective viewing area	304.1 x 228.1 mm
• Display Colors	16.7M colors
<b>SCANNING</b>	
Vertical refresh rate	56 Hz-76 Hz
Horizontal Frequency	30 kHz-61 kHz

**VIDEO**

• Video dot rate	80 MHz
• Input impedance	
- Video	75 ohm
- Sync	2K ohm
• Input signal levels	700m Vpp
• Sync input signal	Separate sync Composite sync Sync on green
• Sync polarities	Positive and negative
• Input Frequency	XGA           Hsync 48- 61 kHz, Vsync 60 - 76 Hz (N.I.) SVGA         Hsync 35- 50 kHz, Vsync 56 - 75 Hz (N.I.) VGA           Hsync 31- 38 kHz, Vsync 60 - 76 Hz (N.I.)
• Video interface	Analog (D-Sub)

**Optical characteristics**

• Contrast ratio	400:1 (typ.)
• Brightness	250 cd/m <sup>2</sup> (typ.)
• Peak contrast angle	6 o'clock
• White Chromaticity	x: 0.283 y: 0.297 (at 9300°K) x: 0.313 y: 0.329 (at 6500°K) x: 0.313 y: 0.329 (at sRGB)
• Viewing Angle (C/R>10)	Upper ≥45° (typ.) Lower ≥55° (typ.) Left ≥65° (typ.) Right ≥65° (typ.)
• Response time	≤16 ms (typ.)

**sRGB**

sRGB is a standard for ensuring correct exchange of colors between different devices (e.g. digital cameras, monitors, printers, scanners, etc.)

Using a standard unified color space, sRGB will help represent pictures taken by an sRGB compatible device correctly on your sRGB enabled Philips monitors. In that way, the colors are calibrated and you can rely on the correctness of the colors shown on your screen.

Important with the use of sRGB is that the brightness and contrast of your monitor is fixed to a predefined setting as well as the color gamut. Therefore it is important to select the sRGB setting in the monitor's OSD.

To do so, open the OSD by pressing the OK button on the front of your monitor. Use the down button to go to Adjust Color and press OK again. Then move the down button to go to sRGB and press OK again.

Exit this OSD.

After this, please do not change the brightness or contrast setting of your monitor. If you change either of these, the monitor will exit the sRGB mode and go to a color temperature setting of 6500K.

For more information on sRGB, please visit: [www.srgb.com](http://www.srgb.com)

*\* This data is subject to change without notice.*

[RETURN TO TOP OF THE PAGE](#)

---

## Resolution & Preset Modes

- Maximum          1024 x 768 at 75 Hz
- 
- Recommended      1024 x 768 at 60 Hz

### 14 user definable modes

### 14 factory preset modes:



H. freq (kHz)	Resolution	V. freq (Hz)
31.469	640*350	70.086
31.469	720*400	70.087
31.469	640*480	59.940
35.000	640*480	67.000
37.861	640*480	72.809
37.500	640*480	75.000
35.156	800*600	56.250
37.879	800*600	60.317
48.077	800*600	72.188
46.875	800*600	75.000
49.700	832*624	75.000
48.363	1024*768	60.004
56.476	1024*768	70.069
60.023	1024*768	75.029

[RETURN TO TOP OF THE PAGE](#)

### Automatic Power Saving

If you have VESA DPMS compliance display card or software installed in your PC, the monitor can automatically reduce its power consumption when not in use. If an input from a keyboard, mouse or other input device is detected, the monitor will 'wake up' automatically. The following table shows the power consumption and signaling of this automatic power saving feature:

Power Management Definition					
VESA Mode	Video	H-sync	V-sync	Power Used	LED color
ON	Active	Yes	Yes	< 20 W	Green
OFF	Blanked	No	No	< 1 W	Amber

This monitor is ENERGY STAR® compliant. As an ENERGY STAR® Partner, PHILIPS has determined that this product meets the ENERGY STAR® guidelines for energy efficiency.

[RETURN TO TOP OF THE PAGE](#)

## Physical Specifications

• Dimension (WxHxD) *	342 x 364 x 170 mm (incl. Pedestal)
• Weight	3.6 Kg
• Tilt	-5° ~ 25°
• Power supply	100 — 240 VAC, 50/60 Hz
• Power consumption	18 W* (typ.)
• Temperature	5° C to 40° C (operating) -20° C to 60° C (storage)
• Relative humidity	20% to 80%
• System MTBF	50K hours (CCFL 30K hours)
• Cabinet color	150S5FG: Light Gray 150S5FB: Black 150S5FS: Silver

\* *This data is subject to change without notice.*

\* *Resolution 1024x768, standard size, brightness max., contrast 50%, full white pattern, without audio/USB.*

[RETURN TO TOP OF THE PAGE](#)

## Pin Assignment

The 15-pin D-sub connector (male) of the signal cable:

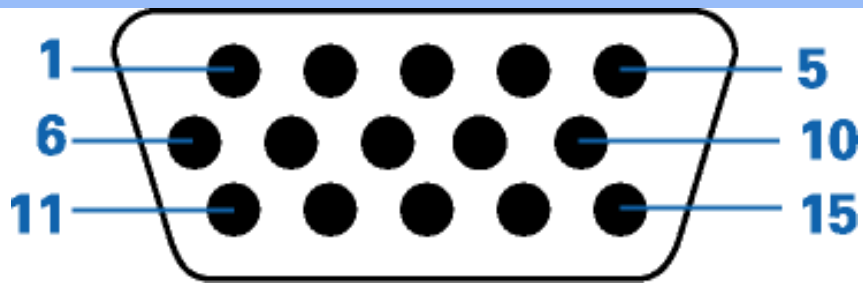

Pin No.	Assignment		Pin No.	Assignment
1	Red video input		9	DDC +5V
2	Green video input/SOG		10	Logic ground
3	Blue video input		11	Ground
4	Ground		12	Serial data line (SDA)
5	Cable detect		13	H. Sync / H+V
6	Red video ground		14	V. Sync
7	Green video ground		15	Data clock line (SCL)
8	Blue video ground			

[RETURN TO TOP OF THE PAGE](#)

## Product Views

Follow the links to see various views of the monitor and its components.

[Front View Product Description](#)

[RETURN TO TOP OF THE PAGE](#)

## Physical Function

1) Tilt

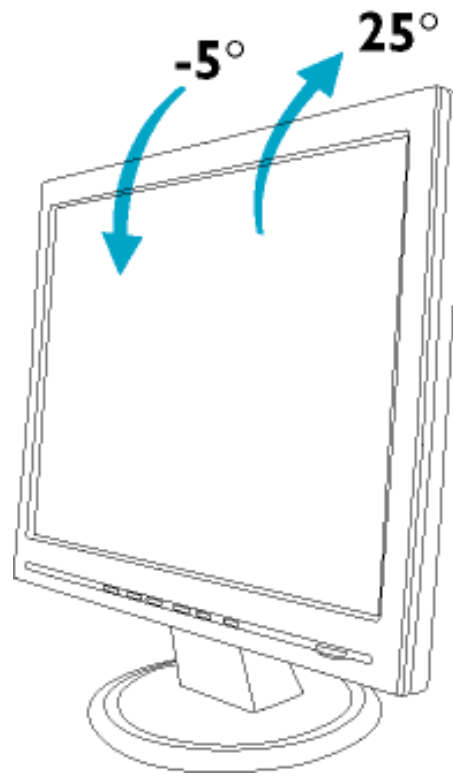

[RETURN TO TOP OF THE PAGE](#)

## Installing Your LCD Monitor

- Front View
- Product Description
- Connecting to Your PC
- The Base
- Getting Started
- Optimizing Performance

### Front View Product Description

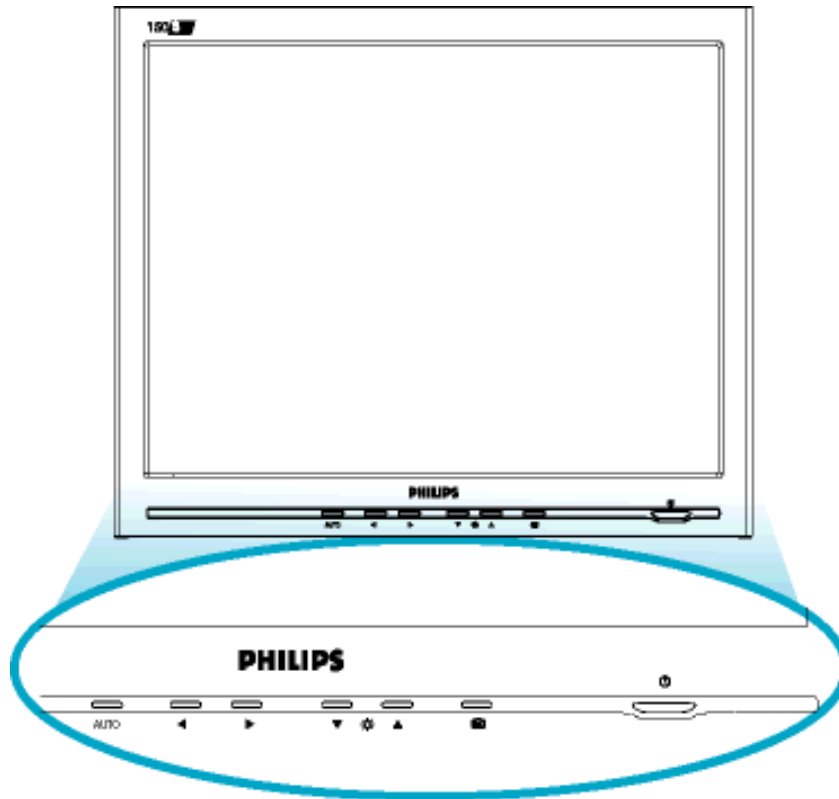

UP and DOWN buttons are used when adjusting the OSD of your monitor.



LEFT and RIGHT buttons, like the UP and DOWN buttons, are also used in adjusting the OSD of your monitor.



BRIGHTNESS hotkey. When the UP and DOWN arrow buttons are pressed, the adjustment controls for the BRIGHTNESS will show up.



OK button which when pressed will take you to the OSD controls.



POWER button switches your monitor on.

**AUTO**

Automatically adjust the horizontal position, vertical position, phase and clock setting.

[RETURN TO TOP OF THE PAGE](#)

## Rear View

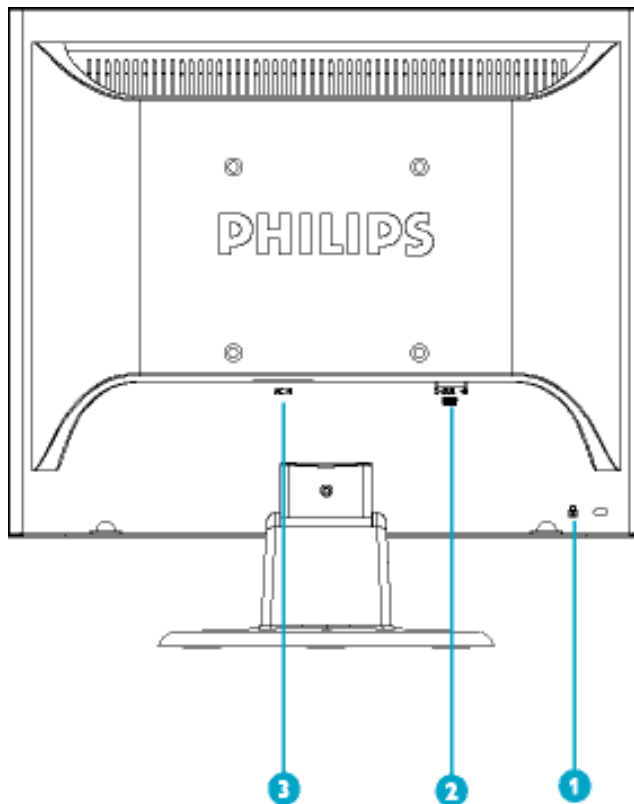

- 1 Kensington anti-thief lock
- 2 VGA input
- 3 AC power input

[RETURN TO TOP OF THE PAGE](#)

---

## Optimizing Performance

- For best performance, ensure that your display settings are set at 1024x768, 60Hz.



**Note:** You can check the current display settings by pressing the 'OK' button once. Go into the Product Information. The current display mode is shown on the item called RESOLUTION.

- You can also install the [Flat Panel Adjust \(FP Adjust\) program](#), a program for getting the best performance out of your monitor. This is included on this CD. Step-by-step instructions are provided to guide you through the installation process. Click on the link to know more about this program.

More about  [FP\\_setup04.exe](#)

[RETURN TO TOP OF THE PAGE](#)

- Description of the On-Screen Display
- The OSD Tree

## On-Screen Display

---

### Description of the On Screen Display

#### *What is the On-Screen Display?*

This is a feature in all Philips LCD monitors. It allows an end user to adjust screen performance of the monitors directly through an on-screen instruction window. The user interface provides user-friendliness and ease-of-use when operating the monitor.

#### *Basic and simple instruction on the control keys.*

When you press the **OK** button on the front control of your monitor, the On-Screen Display (OSD) Main Controls window will pop up and you can then start making adjustments to your monitor's various features. Use the ◀▶ or the ▲▼ keys to make your adjustments.



[RETURN TO TOP OF THE PAGE](#)

---

### The OSD Tree

Below is an overall view of the structure of the On-Screen Display. You can use this as a reference when you want to work your way around the different adjustments later on.



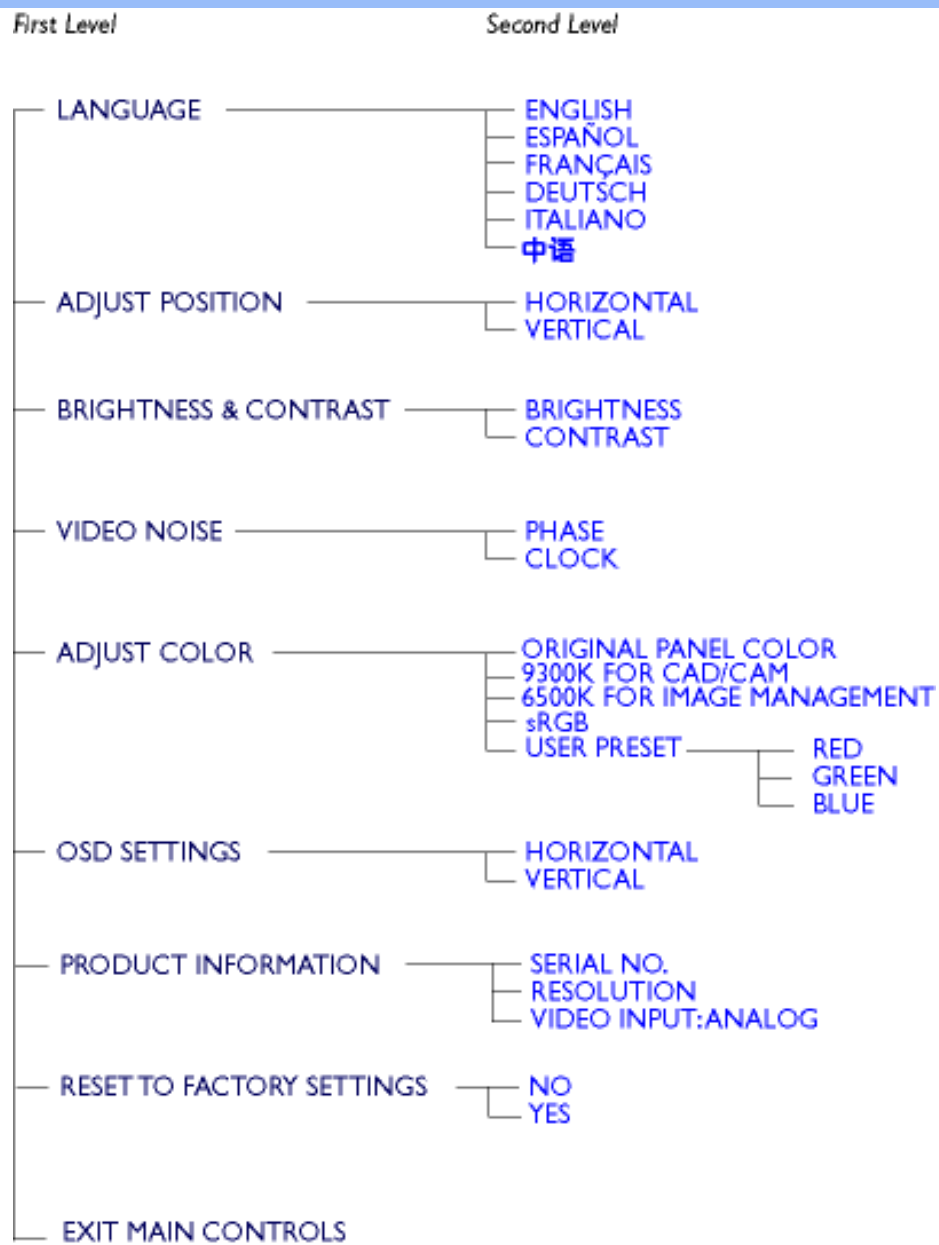

RETURN TO TOP OF THE PAGE

## Customer Care & Warranty

PLEASE SELECT YOUR COUNTRY/AREA TO REVIEW DETAILS OF YOUR WARRANTY COVERAGE

**WESTERN EUROPE:** Austria • Belgium • Cyprus • Denmark • France • Germany • Greece • Finland • Ireland • Italy • Luxembourg • the Netherlands • Norway • Portugal • Sweden • Switzerland • Spain • United Kingdom

**EASTERN EUROPE:** Czech Republic • Hungary • Poland • Russia • Slovakia • Slovenia • Turkey

**LATIN AMERICA:** Antilles • Argentina • Brasil • Chile • Colombia • Mexico • Paraguay • Peru • Uruguay • Venezuela

**NORTH AMERICA:** Canada • USA

**PACIFIC:** Australia • New Zealand

**ASIA:** Bangladesh • China • Hong Kong • India • Indonesia • Japan • Korea • Malaysia • Pakistan • Philippines • Singapore • Taiwan • Thailand

**AFRICA:** Morocco • South Africa

**MIDDLE EAST:** Dubai • Egypt

---

# Glossary

A B C D E F G H I J K L M N O P Q R S T U V W X Y Z

---

## C

### *Color temperature*

A way of describing the color of a radiating source in terms of the temperature (in degrees Kelvin) of a black body radiating with the same dominant frequency as the source.

Most Philips monitors offer the possibility of setting the color temperature to any desired value.

[RETURN TO TOP OF THE PAGE](#)

---

## D

### *D-SUB*

Your monitor comes with a D-Sub cable.

### *Digital Visual Interface (DVI)*

The Digital Visual Interface (DVI) specification provides a high-speed digital connection for visual data types that is display technology independent. The interface is primarily focused at providing a connection between a computer and its display device. The DVI specification meets the needs of all segments of the PC industry (workstation, desktop, laptop, etc.) and will enable these different segments to unite around one monitor interface specification.

The DVI interface enables:

1. Reduce signal loss and video noise in signal due to less signal conversion.
2. Independent from display technology, and can be used on LCD, Plasma, LCOS, etc.
3. Plug and play through hot plug detection, EDID and DDC2B.
4. Digital and Analog support in a single connector (DVI-I only).

[RETURN TO TOP OF THE PAGE](#)

---

## E

### *Energy Star Computers Program*

An energy conservation program launched by the US Environmental Protection Agency (EPA), promotes the manufacture and marketing of energy-efficient office automation equipment. Companies joining this program, must be willing to commit themselves to manufacture one or more products capable of going into a low -power state (< 30 W) either after a period of inactivity, or after a predetermined time selected by the user.

[RETURN TO TOP OF THE PAGE](#)

---

## L

### *LCD Liquid Crystal Display*

An alphanumeric display, using the unique properties of liquid crystal, to form characters. The latest flat-panel displays, contains a matrix of hundreds or thousands of individual LCD cells that generate text and colorful graphics on a screen. They consume little power, though they do require external lighting to make them legible to the user.

[RETURN TO TOP OF THE PAGE](#)

---

**V**

*Vertical refresh rate*

Expressed in Hz, it is the number of frames (complete pictures) written to the screen every second.

[RETURN TO TOP OF THE PAGE](#)

## Download and Print

---

- Installing your LCD monitor driver
- Download and Printing Instructions
- Installing FPadjust Program

### Installing Your LCD monitor driver

#### *System requirements:*

- PC running Windows 95, Windows® 98, Windows® 2000 , Windows® Me, Windows® XP or later
- Find your driver ".inf/.icm/.cat" at : /PC/drivers/

**Read the "Driver\_install02.txt" file before installing.**

---

This page provides an option to read the manual in .pdf format. PDF files can be downloaded into your hard disk, then viewed and printed with Acrobat Reader or through your browser.

If you do not have Adobe® Acrobat Reader installed, click on the link to install the application.  
[Adobe® Acrobat Reader for PC](#) / [Adobe® Acrobat Reader for Mac](#).

#### ***Download instructions:***

To download the file:

1. Click-and-hold your mouse over the icon below. (Windows® 95/98/2000/Me/XP users right-click)

Download



150B5.pdf

Download



150S5.pdf

2. From the menu that appears, choose 'Save Link As...', 'Save Target As...' or 'Download Link to Disk'.

3. Choose where you would like to save the file; click 'Save' (if prompted to save as either 'text' or 'source', choose 'source').

### ***Printing instructions:***

To print the manual:

1. With the manual file open, follow your printer's instructions and print the pages you need.

[RETURN TO TOP OF THE PAGE](#)

---

### **Installing FPadjust Program**

The FP Adjust program generates alignment patterns which will help you adjust monitor settings such as CONTRAST, BRIGHTNESS, HORIZONTAL & VERTICAL POSITION, PHASE and CLOCK.

#### *System requirements:*

- PC running Windows® 95, Windows® 98, Windows® 2000, Windows® Me, Windows® XP or later

#### *To install [FPadjust Program](#):*

- Click on the link or icon to install FPadjustment Program.  
**or**
- Click-and-hold your mouse over the icon. (Win95/98/2000/Me/XP users right-click)

**Download**  [FP\\_setup04.exe](#)

- From the menu that appears, choose 'Save Link As...', 'Save Target As...' or 'Download Link to Disk'.
- Choose where you would like to save the file; click 'Save' (if prompted to save as either 'text' or 'source', choose 'source').
- Exit your browser and install the FPadjust Program.

**Read the "[FP\\_Readme04.txt](#)" file before installing.**

[RETURN TO TOP OF THE PAGE](#)



- Safety and Troubleshooting
- General FAQs
- Screen Adjustments
- Compatibility with Other Peripherals
- LCD Panel Technology
- Ergonomics, Ecology and Safety Standards
- Troubleshooting
- Regulatory Information
- Other Related Information

## FAQs (Frequently Asked Questions)

---

### General FAQs

**Q:** When I install my monitor what should I do if the screen shows 'Cannot display this video mode'?

**A:** Recommended video mode for Philips 15": 1024x768 @60Hz.

1. Unplug all cables, then connect your PC to the monitor that you used previously.
  2. In the Windows Start Menu, select Settings/Control Panel. In the Control Panel Window, select the Display icon. Inside the Display Control Panel, select the 'Settings' tab. Under the setting tab, in box labeled 'desktop area', move the sidebar to 1024x768 pixels (15").
  3. Open 'Advanced Properties' and set the Refresh Rate to 60Hz, then click OK.
  4. Restart your computer and repeat step 2 and 3 to verify that your PC is set at 1024x768@60Hz (15").
  5. Shut down your computer, disconnect your old monitor and reconnect your Philips LCD monitor.
  6. Turn on your monitor and then turn on your PC.
- 

**Q:** What should I do when screen shows: THIS IS 85HZ OVERDRIVE, CHANGE COMPUTER DISPLAY INPUT TO 1024 x 768 @60HZ?

**A:** It means the signal input from your PC is 85Hz -- outside the range that the monitor can display. New Generation LCD intelligent monitor capabilities temporarily override the overscan, providing you with 10 minutes to reset timing to recommended settings.

Here's how:

Go to your Windows Start menu. Select *Settings*, then *Control Panel*. Select *Display*. Move to *Settings* and click on the *Advanced* button. Under *Adaptor*, change the refresh rate to 56~75.

You have 10 minutes to complete the operation; if you do not complete within 10 minutes, power off and re-power on monitor to enter changes.

---

**Q:** What does 'refresh rate' mean in connection with an LCD monitor?

**A:** The refresh rate is of much less relevance for LCD monitors. LCD monitors display a stable, flicker-free image at 60Hz. There is no visible difference between 85Hz and 60Hz.

---

**Q:** What are the .inf and .icm files on the CD-ROM? How do I install the drivers (.inf and .icm)?

**A:** These are the driver files for your monitor. Follow the instructions in your user manual to install the drivers. Your computer may ask you for monitor drivers (.inf and .icm files) or a driver disk when you first install your monitor. Follow the instructions to insert the driver disk (either floppy or CD-ROM) included in this package. Monitor drivers (.inf and .icm files) will be installed automatically.

---

**Q:** How do I adjust the resolution?

**A:** Your video card/graphic driver and monitor together determine the available resolutions. You can select the desired resolution under Windows® 95/98 with the 'Display properties/ Settings' control panel.

---

**Q:** What if I get lost when I am making monitor adjustments?

**A:** Simply press the OSD button, then select 'Reset' to recall all of the original factory settings.

---

**Q:** What is the Auto function?

**A:** The *AUTO adjustment* key restores the optimal screen position, phase and clock settings at the press of a single button – without the need to navigate through OSD menus and control keys.

---

**Q:** My Monitor has no power (Power LED does not light up). What should I do?

**A:** Make sure the AC power cord is connected to the Monitor.

---

**Q:** Will the LCD monitor accept an Interlace signal?

**A:** No. If an Interlace signal is used, the screen displays both odd and even horizontal scanning lines at the same time, thus distorting the picture.

---

**Q:** What does the Refresh Rate mean for LCD?

**A:** Unlike CRT display technology, in which the speed of the electron beam is swept from the top to the bottom of the screen determines flicker, an active matrix display uses an active element (TFT) to control each individual pixel and the refresh rate is therefore not really applicable to LCD technology.

---

**Q:** Will the LCD screen be resistant to scratches?

**A:** A protective coating is applied to the surface of the LCD, which is durable to a certain extent (approximately up to the hardness of a 2H pencil). In general, it is recommended that the panel surface is not subject to any excessive shocks or scratches. An optional protective cover with greater scratch resistance is also available.

---

**Q:** How should I clean the LCD surface?

**A:** For normal cleaning, use a clean, soft cloth. For extensive cleaning, please use isopropyl alcohol. Do not use other solvents such as ethyl alcohol, ethanol, acetone, hexane, etc.

---

**Q:** Can the Philips LCD Monitor be mounted on the wall or used as a touch panel?

**A:** Yes. Philips LCD monitors have this optional feature. The standard VESA mount holes on the back cover allows the user to mount the Philips monitor on any VESA standard ARM or accessories. Touch panels are being developed for future applications. Check with your Philips sales representative for more information.

[RETURN TO TOP OF THE PAGE](#)

---

## Screen Adjustments

**Q:** What is the FPadjust program on the CD-ROM?

**A:** The FPadjust program generates alignment patterns that help you adjust monitor settings such as Contrast, Brightness, Horizontal Position, Vertical Position, Phase and Clock for optimal performance.

---

**Q:** When I install my monitor, how do I get the best performance from the monitor?

**A:**

1. For best performance, make sure your display settings are set at 1024x768@60Hz for 15".  
Note: You can check the current display settings by pressing the OSD OK button once.  
The current display mode is shown in product information in OSD main controls.
  2. To install the Flat Panel Adjust (FPadjust) program located on the monitor setup CD-ROM, open the CD-ROM and double-click the FP\_setup04.exe icon. This will install FP Adjust automatically and place a shortcut on your desktop.
  3. Run FPadjust by double clicking the shortcut. Follow the instructions step by step to optimize image performance with your system's video controller.
- 

**Q: How do LCDs compare to CRTs in terms of radiation?**

**A: Because LCDs do not use an electron gun, they do not generate the same amount of radiation at the screen surface.**

[RETURN TO TOP OF THE PAGE](#)

---

### **Compatibility with other Peripherals**

**Q: Can I connect my LCD monitor to any PC, workstation or Mac?**

**A: Yes. All Philips LCD monitors are fully compatible with standard PCs, Macs and workstations. You may need a cable adapter to connect the monitor to your Mac system. Please contact your dealer/retailer for more information.**

---

**Q: Are Philips LCD monitors Plug-and-Play?**

**A: Yes, the monitors are Plug-and-Play compatible with Windows® 95, 98, 2000 and the PC98/99 platforms.**

---

**Q: What is USB (Universal Serial Bus)?**

**A: Think of USB as a smart plug for PC peripherals. USB automatically determines resources (like driver software and bus bandwidth) required by peripherals. USB makes necessary resources available without user intervention. There are three main benefits of USB. USB eliminates "case anxiety," the fear of removing the computer case to install circuit board cards -- that often requires adjustment of complicated IRQ settings -- for add-on peripherals. USB does away with "port gridlock." Without USB, PCs are normally limited to one printer, two Com port devices (usually a mouse and modem), one Enhanced Parallel Port add-on (scanner or video camera, for example), and a joystick. More and more**

peripherals for multimedia computers come on the market every day. With USB, up to 127 devices can run simultaneously on one computer. USB permits "hot plug-in." No need to shut down, plug in, reboot and run set up to install peripherals. No need to go through the reverse process to unplug a device. Bottom line: USB transforms today's "Plug-and-Pray" into true Plug-and-Play!

---

**Q:** What is a USB hub ?

**A:** A USB hub provides additional connections to the Universal Serial Bus. A hub's upstream port connects a hub to the host, usually a PC. Multiple downstream ports in a hub allows connection to another hub or device, such as a USB keyboard, camera or printer.

[RETURN TO TOP OF THE PAGE](#)

---

## LCD Panel Technology

**Q:** What is a Liquid Crystal Display?

**A:** A Liquid Crystal Display (LCD) is an optical device that is commonly used to display ASCII characters and images on digital items such as watches, calculators, portable game consoles, etc. LCD is the technology used for displays in notebooks and other small computers. Like light-emitting diode and gas-plasma technologies, LCD allows displays to be much thinner than cathode ray tube (CRT) technology. LCD consumes much less power than LED and gas-displays because it works on the principle of blocking light rather than emitting it.

---

**Q:** How are LCDs made?

**A:** LCDs are created from two glass plates separated from each other at a distance of a few microns. The plates are filled with liquid crystal and then sealed together. The top plate is colored with an RGB pattern to make the color filter. Polarizers are then glued to both plates. This combination is sometimes called 'glass' or 'cell.' The LCD cell is assembled into a 'module' by adding the backlight, driver electronics and frame.

---

**Q:** What is polarization ?

**A:** Polarization is basically directing light to shine in one direction. Light is electromagnetic waves. Electric and magnetic fields oscillate in a direction perpendicular to the propagation of the light beam. The direction of these fields is called the 'polarization direction'. Normal or non-polarized light has fields in several directions; polarized light has a field in only one

direction.

---

**Q:** What differentiates passive matrix LCDs from active matrix LCDs?

**A:** An LCD is made with either a passive matrix or an active matrix display grid. An active matrix has a transistor located at each pixel intersection, requiring less current to control the luminance of a pixel. For this reason, the current in an active matrix display can be switched on and off more frequently, improving the screen refresh time (your mouse pointer will appear to move more smoothly across the screen, for example). The passive matrix LCD has a grid of conductors with pixels located at each intersection in the grid.

---

**Q:** How does a TFT LCD Panel work?

**A:** On each column and row of the TFT LCD panel, a data source drive and a gate drive are attached, respectively. The TFT drain of each cell is connected to the electrode. The molecular arrangement of liquid crystal elements differ according to whether it is impressed with voltage or not. It varies the direction of polarized light and the amount of light by letting it through different arrays of liquid crystal elements. When two polarized filters are arranged vertically on a polarized light pole, the light that passes through the upper polarized panel is turned 90 degrees along with the spiral structure of the liquid crystal molecules and goes through the polarized filter at the bottom. When impressed with voltage, liquid crystal molecules are arranged vertically from the original spiral structure and the direction of the light is not turned through 90 degrees. In this case, light that comes through the top polarized panel may not go through the polarized panel at the bottom.

---

**Q:** What are the advantages of TFT LCD compared with CRT?

**A:** In a CRT monitor, a gun shoots electrons and general light by colliding polarized electrons on fluorescent glass. Therefore, CRT monitors basically operate with an analog RGB signal. A TFT LCD monitor is a device that displays an input image by operating a liquid crystal panel. The TFT has a fundamentally different structure than a CRT: Each cell has an active matrix structure and independent active elements. A TFT LCD has two glass panels and the space between them is filled with liquid crystal. When each cell is connected with electrodes and impressed with voltage, the molecular structure of the liquid crystal is altered and controls the amount of inlet lighting to display images. A TFT LCD has several advantages over a CRT, since it can be very thin and no flickering occurs because it does not use the scanning method.

---

**Q:** Why is vertical frequency of 60Hz optimal for an LCD monitor?

**A:** Unlike a CDT monitor, the TFT LCD panel has a fixed resolution. For example, an XGA monitor has 1024x3 (R, G, B) x 768 pixels and a higher resolution may not be available without additional software processing. The panel is designed to optimize the display for a

65MHz dot clock, one of the standards for XGA displays. Since the vertical/horizontal frequency for this dot clock is 60Hz/48kHz, the optimum frequency for this monitor is 60Hz.

---

**Q:** What kind of wide-angle technology is available? How does it work?

**A:** The TFT LCD panel is an element that controls/displays the inlet of a backlight using the dual-refraction of a liquid crystal. Using the property that the projection of inlet light refracts toward the major axis of the liquid element, it controls the direction of inlet light and displays it. Since the refraction ratio of inlet light on liquid crystal varies with the inlet angle of the light, the viewing angle of a TFT is much narrower than that of a CDT. Usually, the viewing angle refers to the point where the contrast ration is 10. Many ways to widen the viewing angle are currently being developed and the most common approach is to use a wide viewing angle film, which widens the viewing angle by varying the refraction ratio. IPS (In Plane Switching) or MVA (Multi Vertical Aligned) is also used to give a wider viewing angle.

---

**Q:** Why is there no flicker on an LCD Monitor?

**A:** Technically speaking, LCDs do flicker, but the cause of the phenomenon is different from that of a CRT monitor -- and it has no impact of the ease of viewing. Flickering in an LCD monitor relates to usually undetectable luminance caused by the difference between positive and negative voltage. On the other hand, CRT flickering that can irritate the human eye occurs when the on/off action of the fluorescent object becomes visible. Since the reaction speed of liquid crystal in an LCD panel is much slower, this troublesome form of flickering is not present in an LCD display.

---

**Q:** Why is an LCD monitor virtually free of Electro Magnetic Interference?

**A:** Unlike a CRT, an LCD monitor does not have key parts that generate Electro Magnetic Interference, especially magnetic fields. Also, since an LCD display utilizes relatively low power, its power supply is extremely quiet.

---

[RETURN TO TOP OF THE PAGE](#)

---

## **Ergonomics, Ecology and Safety Standards**

**Q:** What is the CE mark?

**A:** The CE (Conformité Européenne) mark is required to be displayed on all regulated products offered for sale on the European market. This 'CE' mark means that a product complies with the relevant European Directive. A European Directive is a European 'Law' that relates to health, safety, environment and consumer protection, much the same as the U.

## S. National Electrical Code and UL Standards.

---

**Q:** Does the LCD monitor conform to general safety standards?

**A:** Yes. Philips LCD monitors conform to the guidelines of MPR-II and TCO 99/03 standards for the control of radiation, electromagnetic waves, energy reduction, electrical safety in the work environment and recyclability. The specification page provides detailed data on safety standards.

*More information is provided in the [Regulatory Information](#) section.*

[RETURN TO TOP OF THE PAGE](#)





# Troubleshooting



- Safety and Troubleshooting
- FAQs

- Common Problems
- Imaging Problems
- Regulatory Information
- Other Related Information

This page deals with problems that can be corrected by the user. If the problem still persists after you have tried these solutions, contact your nearest Philips dealer.

Common Problems	
Having this problem?	Check these items
No Picture (Power LED not lit)	<ul style="list-style-type: none"> <li>• Make sure the power cord is plugged into the power outlet and into the back of the monitor.</li> <li>• First, ensure that the power button on the front of the monitor is in the OFF position, then press it to the ON position.</li> </ul>
No Picture (Power LED is amber or yellow)	<ul style="list-style-type: none"> <li>• Make sure the computer is turned on.</li> <li>• Make sure the signal cable is properly connected to your computer.</li> <li>• Check to see if the monitor cable has bent pins.</li> <li>• The Energy Saving feature may be activated</li> </ul>
Screen says 	<ul style="list-style-type: none"> <li>• Make sure the monitor cable is properly connected to your computer. (Also refer to the Quick Set-Up Guide).</li> <li>• Check to see if the monitor cable has bent pins.</li> <li>• Make sure the computer is turned on.</li> </ul>
Screen says 	<ul style="list-style-type: none"> <li>• Make sure the vertical sync of input signal is within the range of 56 ~ 75 Hz.</li> <li>• Change the refresh rate to 56~75Hz within 10 minutes.</li> <li>• Re-power on monitor to start over again if you failed to change the refresh rate within 10 minutes.</li> </ul>
AUTO button not working properly	<ul style="list-style-type: none"> <li>• The Auto Function is designed for use on standard Macintosh or IBM-compatible PCs running Microsoft Windows.</li> <li>• It may not work properly if using nonstandard PC or video card.</li> </ul>

## Imaging Problems

<p>Display position is incorrect</p>	<ul style="list-style-type: none"> <li>● Press the Auto button.</li> <li>● Adjust the image position using the Horizontal Position and/or Vertical Position in OSD Main Controls.</li> </ul>
<p>Image vibrates on the screen</p>	<ul style="list-style-type: none"> <li>● Check that the signal cable is properly connected to the graphics board or PC.</li> </ul>
<p>Vertical flicker appears</p> 	<ul style="list-style-type: none"> <li>● Press the Auto button.</li> <li>● Eliminate the vertical bars using the Clock Adjustment of VIDEO NOISE in OSD Main Controls.</li> </ul>
<p>Horizontal flicker appears</p> 	<ul style="list-style-type: none"> <li>● Press the Auto button.</li> <li>● Eliminate the horizontal bars using the Phase Adjustment of VIDEO NOISE in OSD Main Controls.</li> </ul>
<p>The screen is too bright or too dark</p>	<ul style="list-style-type: none"> <li>● Adjust the contrast and brightness on OSD Main Controls. (The backlight of the LCD monitor has a fixed life span. When the screen becomes dark or begins to flicker, please contact your dealer).</li> </ul>
<p>An after-image appears</p>	<ul style="list-style-type: none"> <li>● If an image remains on the screen for an extended period of time, it may be imprinted in the screen and leave an after-image. This usually disappears after a few hours</li> </ul>
<p>An after-image remains after the power has been turned off.</p>	<ul style="list-style-type: none"> <li>● This is characteristic of liquid crystal and is not caused by a malfunction or deterioration of the liquid crystal. The after-image will disappear after a period of time.</li> </ul>

Green, red, blue, dark, and white dots remains

- The remaining dots are normal characteristic of the liquid crystal used in today's technology.

For further assistance, refer to the [Consumer Information Centers](#) list and contact your local Philips distributor.

[RETURN TO TOP OF THE PAGE](#)

- TCO'99 Information
- TCO'99 Environmental Requirements
- TCO'03 Information
- Recycling Information for Customers
- CE Declaration of Conformity
- Energy Star Declaration
- Federal Communications Commission (FCC) Notice (U. S. Only)
- Commission Federale de la Communication (FCC Declaration)
- EN 55022 Compliance (Czech Republic Only)
- VCCI Class 2 Notice (Japan Only)
- MIC Notice (South Korea Only)
- Polish Center for Testing and Certification Notice
- North Europe (Nordic Countries) Information
- BSMI Notice (Taiwan Only)
- Ergonomie Hinweis (nur Deutschland)

## Regulatory Information

### TCO '99 Information



**Congratulations!** You have just purchased a TCO '99 approved and labeled product! Your choice has provided you with a product developed for professional use. Your purchase has also contributed to reducing the burden on the environment and also to the further development of environmentally adapted electronics products.

#### *Why do we have environmentally labeled computers?*

In many countries, environmental labeling has become an established method for encouraging the adaptation of goods and services to the environment. The main problem, as far as computers and other electronics equipment are concerned, is that environmentally harmful substances are used both in the products and during their manufacture. Since it is not so far possible to satisfactorily recycle the majority of electronics equipment, most of these potentially damaging substances sooner or later enter nature.

There are also other characteristics of a computer, such as energy consumption levels, that are important from the viewpoints of both the work (internal) and natural (external) environments. Since all methods of electricity generation have a negative effect on the environment (e.g. acidic and climate-influencing emissions, radioactive waste), it is vital to save energy. Electronics equipment in offices is often left running continuously and thereby consumes a lot of energy.

#### *What does labeling involve?*

This product meets the requirements for the TCO'99 scheme which provides for international and environmental labeling of personal computers. The labeling scheme was developed as a joint effort by the TCO (The Swedish Confederation of Professional Employees), Svenska Naturskyddsforeningen (The Swedish Society for Nature Conservation) and Statens Energimyndighet (The Swedish National Energy Administration).

Approval requirements cover a wide range of issues: environment, ergonomics, usability, emission of electric and magnetic fields, energy consumption and electrical and fire safety.

The environmental demands impose restrictions on the presence and use of heavy metals, brominated and chlorinated flame retardants, CFCs (freons) and chlorinated solvents, among other things. The product must be prepared for recycling and the manufacturer is obliged to have an environmental policy which must be adhered to in each country where the company implements its operational policy.

The energy requirements include a demand that the computer and/or display, after a certain period of inactivity, shall reduce its power consumption to a lower level in one or more stages. The length of time to reactivate the computer shall be reasonable for the user.

Labeled products must meet strict environmental demands, for example, in respect of the reduction of electric and magnetic fields, physical and visual ergonomics and good usability.

- Philips End-of-Life Disposal Information for UK only
- Troubleshooting Other Related Information
- Frequently Asked Questions (FAQs)

Below you will find a brief summary of the environmental requirements met by this product. The complete environmental criteria document may be ordered from:

TCO Development

SE-114 94 Stockholm, Sweden

Fax: +46 8 782 92 07

Email (Internet): [development@tco.se](mailto:development@tco.se)

*Current information regarding TCO'99 approved and labeled products may also be obtained via the Internet, using the address: <http://www.tco-info.com/>*

[RETURN TO TOP OF THE PAGE](#)

---

## Environmental Requirements

### *Flame retardants*

Flame retardants are present in printed circuit boards, cables, wires, casings and housings. Their purpose is to prevent, or at least to delay the spread of fire. Up to 30% of the plastic in a computer casing can consist of flame retardant substances. Most flame retardants contain bromine or chloride, and those flame retardants are chemically related to another group of environmental toxins, PCBs. Both the flame retardants containing bromine or chloride and the PCBs are suspected of giving rise to severe health effects, including reproductive damage in fish-eating birds and mammals, due to the bio-accumulative\* processes. Flame retardants have been found in human blood and researchers fear that disturbances in fetus development may occur.

The relevant TCO'99 demand requires that plastic components weighing more than 25 grams must not contain flame retardants with organically bound bromine or chlorine. Flame retardants are allowed in the printed circuit boards since no substitutes are available.

### **Cadmium\*\***

Cadmium is present in rechargeable batteries and in the color-generating layers of certain computer displays. Cadmium damages the nervous system and is toxic in high doses. The relevant TCO'99 requirement states that batteries, the color-generating layers of display screens and the electrical or electronics components must not contain any cadmium.

### **Mercury\*\***

Mercury is sometimes found in batteries, relays and switches. It damages the nervous system and is toxic in high doses. The relevant TCO'99 requirement states that batteries may not contain any mercury. It also demands that mercury is not present in any of the electrical or electronics components associated with the labeled unit.

### **CFCs (freons)**

The relevant TCO'99 requirement states that neither CFCs nor HCFCs may be used during the manufacture and assembly of the product. CFCs (freons) are sometimes used for washing printed circuit boards. CFCs break down ozone and thereby damage the ozone layer in the stratosphere, causing increased reception on earth of ultraviolet light with increased risks e.g. skin cancer (malignant melanoma) as a consequence.

#### **Lead\*\***

Lead can be found in picture tubes, display screens, solders and capacitors. Lead damages the nervous system and in higher doses, causes lead poisoning. The relevant TCO'99 requirement permits the inclusion of lead since no replacement has yet been developed.

**\* Bio-accumulative is defined as substances which accumulate within living organisms.**

**\*\* Lead, Cadmium and Mercury are heavy metals which are bio-accumulative.**

[RETURN TO TOP OF THE PAGE](#)

---

### **TCO'03 Information**

**(Optional, only available for TCO'03 version)**



#### **Congratulations!**

The display you have just purchased carries the TCO'03 Displays label. This means that your display is designed, manufactured and tested according to some of the strictest quality and environmental requirements in the world. This makes for a high performance product, designed with the user in focus that also minimizes the impact on our natural environment.

Some of the features of the TCO'03 Display requirements.

#### **Ergonomics**

- Good visual ergonomics and image quality in order to improve the working environment for the user and to reduce sight and strain problems. Important parameters are luminance, contrast, resolution, reflectance, colour rendition and image stability.

#### **Energy**

- Energy-saving mode after a certain time-beneficial both for the user and the environment
- Electrical safety

### Emissions

- Electromagnetic fields
- Noise emissions

### Ecology

- The product must be prepared for recycling and the manufacturer must have a certified environmental management system such as EMAS or ISO 14 000
- Restrictions on
  - chlorinated and brominated flame retardants and polymers
  - heavy metals such as cadmium, mercury and lead.

The requirements included in this label have been developed by TCO Development in co-operation with scientists, experts, users as well as manufacturers all over the world. Since the end of the 1980s TCO has been involved in influencing the development of IT equipment in a more user-friendly direction. Our labelling system started with displays in 1992 and is now requested by users and IT-manufacturers all over the world.

For more information, please visit  
[www.tcodevelopment.com](http://www.tcodevelopment.com)

**RETURN TO TOP OF THE PAGE**

---

### Recycling Information for Customers

Philips establishes technically and economically viable objectives to optimize the environmental performance of the organization's product, service and activities.

From the planning, design and production stages, Philips emphasizes the important of making products that can easily be recycled. At Philips, end-of-life management primarily entails participation in national take-back initiatives and recycling programs whenever possible, preferably in cooperation with competitors.

There is currently a system of recycling up and running in the European countries, such as The Netherlands, Belgium, Norway, Sweden and Denmark.

In U.S.A., Philips Consumer Electronics North America has contributed funds for the Electronic Industries Alliance (EIA) Electronics Recycling Project and state recycling initiatives for end-of-life electronics products from household sources. In addition, the Northeast Recycling Council (NERC) - a multi-state non-profit organization focused on promoting recycling market development - plans to implement a recycling program.

In Asia Pacific, Taiwan, the products can be taken back by Environment Protection Administration (EPA) to follow the IT product recycling management process, detail can be found in web site [www.epa.gov.tw](http://www.epa.gov.tw)

For help and service, please contact [Consumers Information Center](#) or [F1rst Choice Contact](#)

[Information Center](#) in each country or the following team of Environmental specialist can help.

Mr. Job Chiu - Environment manager  
Philips Electronics Industries (Taiwan) Ltd, Monitor Business Unit  
E-mail: [job.chiu@philips.com](mailto:job.chiu@philips.com)  
Tel: +886 (0) 3 454 9839

Mr. Maarten ten Houten - Senior Environmental Consultant  
Philips Consumer Electronics  
E-mail: [marten.ten.houten@philips.com](mailto:marten.ten.houten@philips.com)  
Tel: +31 (0) 40 27 33402

Mr. Delmer F. Teglas  
Philips Consumer Electronics North America  
E-mail: [butch.teglas@philips.com](mailto:butch.teglas@philips.com)  
Tel: +1 865 521 4322

[RETURN TO TOP OF THE PAGE](#)

---

## **CE Declaration of Conformity**

Philips Consumer Electronics declare under our responsibility that the product is in conformity with the following standards

- EN60950:2000 (Safety requirement of Information Technology Equipment)
- EN55022:1998 (Radio Disturbance requirement of Information Technology Equipment)
- EN55024:1998 (Immunity requirement of Information Technology Equipment)
- EN61000-3-2:1995 (Limits for Harmonic Current Emission)
- EN61000-3-3:1995 (Limitation of Voltage Fluctuation and Flicker)

following provisions of directives applicable

- 73/23/EEC (Low Voltage Directive)
  - 89/336/EEC (EMC Directive)
  - 93/68/EEC (Amendment of EMC and Low Voltage Directive)
- and is produced by a manufacturing organization on ISO9000 level.

The product also comply with the following standards

- ISO9241-3, ISO9241-7, ISO9241-8 (Ergonomic requirement for Visual Display)
- ISO13406-2 (Ergonomic requirement for Flat panels)
- GS EK1-2000 (GS specification)
- prEN50279:1998 (Low Frequency Electric and Magnetic fields for Visual Display)
- MPR-II (MPR:1990:8/1990:10 Low Frequency Electric and Magnetic fields)
- TCO'95, TCO'99, TCO'03 (Requirement for Environment Labelling of Ergonomics, Energy, Ecology and Emission, TCO: Swedish Confederation of Professional Employees) for TCO versions

[RETURN TO TOP OF THE PAGE](#)

---

## **Energy Star Declaration**



## PHILIPS 150S5FG/150S5FB/150S5FS

This monitor is equipped with a function for saving energy which supports the VESA Display Power Management Signaling (DPMS) standard. This means that the monitor must be connected to a computer which supports VESA DPMS to fulfill the requirements in the NUTEK specification 803299/94. Time settings are adjusted from the system unit by software.

NUTEK	VESA State	LED Indicator	Power Consumption
Normal operation	ON	Green	< 20 W
Power Saving Alternative 2 One step	OFF	Amber	< 1 W



As an ENERGY STAR® Partner, PHILIPS has determined that this product meets the ENERGY STAR® guidelines for energy efficiency.



**We recommend you switch off the monitor when it is not in use for quite a long time.**

[RETURN TO TOP OF THE PAGE](#)

### Federal Communications Commission (FCC) Notice (U.S. Only)



This equipment has been tested and found to comply with the limits for a Class B digital device, pursuant to Part 15 of the FCC Rules. These limits are designed to provide reasonable protection against harmful interference in a residential installation. This equipment generates, uses and can radiate radio frequency energy and, if not installed and used in accordance with the instructions, may cause harmful interference to radio communications. However, there is no guarantee that interference will not occur in a particular installation. If this equipment does cause harmful interference to radio or television reception, which can be determined by turning the equipment off and on, the user is encouraged to try to correct the interference by one or more of the following measures:

- Reorient or relocate the receiving antenna.
- Increase the separation between the equipment and receiver.
- Connect the equipment into an outlet on a circuit different from that to which the receiver is connected.
- Consult the dealer or an experienced radio/TV technician for help.



Changes or modifications not expressly approved by the party responsible for compliance could void the user's authority to operate the equipment.

Use only RF shielded cable that was supplied with the monitor when connecting this monitor to a computer device.

To prevent damage which may result in fire or shock hazard, do not expose this appliance to rain or excessive moisture.

THIS CLASS B DIGITAL APPARATUS MEETS ALL REQUIREMENTS OF THE CANADIAN INTERFERENCE-CAUSING EQUIPMENT REGULATIONS.

[RETURN TO TOP OF THE PAGE](#)

---

### **Commission Federale de la Communication (FCC Declaration)**



Cet équipement a été testé et déclaré conforme aux limites des appareils numériques de class B, aux termes de l'article 15 Des règles de la FCC. Ces limites sont conçues de façon à fournir une protection raisonnable contre les interférences nuisibles dans le cadre d'une installation résidentielle. CET appareil produit, utilise et peut émettre des hyperfréquences qui, si l'appareil n'est pas installé et utilisé selon les consignes données, peuvent causer des interférences nuisibles aux communications radio. Cependant, rien ne peut garantir l'absence d'interférences dans le cadre d'une installation particulière. Si cet appareil est la cause d'interférences nuisibles pour la réception des signaux de radio ou de télévision, ce qui peut être décelé en fermant l'équipement, puis en le remettant en fonction, l'utilisateur pourrait essayer de corriger la situation en prenant les mesures suivantes:

- Réorienter ou déplacer l'antenne de réception.
- Augmenter la distance entre l'équipement et le récepteur.
- Brancher l'équipement sur un autre circuit que celui utilisé par le récepteur.
- Demander l'aide du marchand ou d'un technicien chevronné en radio/télévision.



Toutes modifications n'ayant pas reçu l'approbation des services compétents en matière de conformité est susceptible d'interdire à l'utilisateur l'usage du présent équipement.

N'utiliser que des câbles RF armés pour les connections avec des ordinateurs ou périphériques.

CET APPAREIL NUMERIQUE DE LA CLASSE B RESPECTE TOUTES LES EXIGENCES DU REGLEMENT SUR LE MATERIEL BROUILLEUR DU CANADA.

[RETURN TO TOP OF THE PAGE](#)

---

### **EN 55022 Compliance (Czech Republic Only)**

This device belongs to category B devices as described in EN 55022, unless it is specifically stated that it is a Class A device on the specification label. The following applies to devices in Class A of EN 55022 (radius of protection up to 30 meters). The user of the device is obliged to take all steps necessary to remove sources of interference to telecommunication or other devices.

Pokud není na typovém štítku počítače uvedeno, že spadá do třídy A podle EN 55022, spadá automaticky do třídy B podle EN 55022. Pro zařízení zařazená do třídy A (chranné pásmo 30m) podle EN 55022 platí následující. Dojde-li k rušení telekomunikačních nebo jiných zařízení je uživatel povinen provést taková opatření, aby rušení odstranil.

[RETURN TO TOP OF THE PAGE](#)

### VCCI Notice (Japan Only)

This is a Class B product based on the standard of the Voluntary Control Council for Interference (VCCI) for Information technology equipment. If this equipment is used near a radio or television receiver in a domestic environment, it may cause radio Interference. Install and use the equipment according to the instruction manual.

Class B ITE



この装置は、情報処理装置等電波障害自主規制協議会 (VCCI) の基準に基づくクラス B 情報技術装置です。この装置は家庭環境で使用することを目的としていますが、この装置がラジオやテレビジョン受信機に近接して使用されると、受信障害を引き起こすことがあります。取扱説明書に従って正しい取り扱いをして下さい。

[RETURN TO TOP OF THE PAGE](#)

### MIC Notice (South Korea Only)

Class B Device

장치 종류	사용자 안내문
B급 기기	이 장치는 가정용으로 전자파 적합등록을 한 장치로서 주거지역에서는 물론 모든 지역에서 사용할 수 있습니다.



Please note that this device has been approved for non-business purposes and may be used in any environment, including residential areas.

[RETURN TO TOP OF THE PAGE](#)

---

### **Polish Center for Testing and Certification Notice**

The equipment should draw power from a socket with an attached protection circuit (a three-prong socket). All equipment that works together (computer, monitor, printer, and so on) should have the same power supply source.

The phasing conductor of the room's electrical installation should have a reserve short-circuit protection device in the form of a fuse with a nominal value no larger than 16 amperes (A).

To completely switch off the equipment, the power supply cable must be removed from the power supply socket, which should be located near the equipment and easily accessible.

A protection mark "B" confirms that the equipment is in compliance with the protection usage requirements of standards PN-93/T-42107 and PN-89/E-06251.

## ***Wymagania Polskiego Centrum Badań i Certyfikacji***

Urządzenie powinno być zasilane z gniazda z przyłączonym obwodem ochronnym (gniazdo z kołkiem). Współpracujące ze sobą urządzenia (komputer, monitor, drukarka) powinny być zasilane z tego samego źródła.

Instalacja elektryczna pomieszczenia powinna zawierać w przewodzie fazowym rezerwową ochronę przed zwarciami, w postaci bezpiecznika o wartości znamionowej nie większej niż 16A (amperów).

W celu całkowitego wyłączenia urządzenia z sieci zasilania, należy wyjąć wtyczkę kabla zasilającego z gniazdka, które powinno znajdować się w pobliżu urządzenia i być łatwo dostępne.

Znak bezpieczeństwa "B" potwierdza zgodność urządzenia z wymaganiami bezpieczeństwa użytkowania zawartymi w PN-93/T-42107 i PN-89/E-06251.

## ***Pozostałe instrukcje bezpieczeństwa***

- Nie należy używać wtyczek adapterowych lub usuwać kołka obwodu ochronnego z wtyczki. Jeżeli konieczne jest użycie przedłużacza to należy użyć przedłużacza 3-żyłowego z prawidłowo połączonym przewodem ochronnym.
- System komputerowy należy zabezpieczyć przed nagłymi, chwilowymi wzrostami lub spadkami napięcia, używając eliminatora przepięć, urządzenia dopasowującego lub bezzakłóceniewego źródła zasilania.
- Należy upewnić się, aby nic nie leżało na kablach systemu komputerowego, oraz aby kable nie były umieszczone w miejscu, gdzie można byłoby na nie nadeptywać lub potykać się o nie.
- Nie należy rozlewać napojów ani innych płynów na system komputerowy.
- Nie należy wpychać żadnych przedmiotów do otworów systemu komputerowego, gdyż może to spowodować pożar lub porażenie prądem, poprzez zwarcie elementów wewnętrznych.
- System komputerowy powinien znajdować się z dala od grzejników i źródeł ciepła. Ponadto, nie należy blokować otworów wentylacyjnych. Należy unikać kładzenia luznych papierów pod komputer oraz umieszczania komputera w ciasnym miejscu bez możliwości cyrkulacji powietrza wokół niego.

[RETURN TO TOP OF THE PAGE](#)

---

## **North Europe (Nordic Countries) Information**

Placering/Ventilation

### **VARNING:**

FÖRSÄKRA DIG OM ATT HUVUDBRYTARE OCH UTTAG ÄR LÄTÅTKOMLIGA, NÄR DU STÄLLER DIN UTRUSTNING PÅPLATS.

Placering/Ventilation

### **ADVARSEL:**

SØRG VED PLACERINGSFOR, AT NETLEDNINGENS STIK OG STIKKONTAKT ER NEMT TILGÆNDELIGE.

Paikka/Ilmankierto

**VAROITUS:**

SISOITA LAITE SITOEN, ETTÄ VERKKOJOHTO VOIDAAN TARVITTAESSA HELPOSTI IRROTTAA PISTORASIESTA.

Plassering/Ventilasjon

**ADVARSEL:**

NÅR DETTE UTSTYRET PLASSERES, MÅ DU PASSE PÅ AT KONTAKTENE FOR STØMTILFØRSEL ER LETTE Å NÅ.

[RETURN TO TOP OF THE PAGE](#)

---

**BSMI Notice (Taiwan Only)**

符合乙類資訊產品之標準

[RETURN TO TOP OF THE PAGE](#)

---

**Ergonomie Hinweis (nur Deutschland)**

Der von uns gelieferte Farbmonitor entspricht den in der "Verordnung über den Schutz vor Schäden durch Röntgenstrahlen" festgelegten Vorschriften.

Auf der Rückwand des Gerätes befindet sich ein Aufkleber, der auf die Unbedenklichkeit der Inbetriebnahme hinweist, da die Vorschriften über die Bauart von Störstrahlern nach Anlage III  $\alpha$  5 Abs. 4 der Röntgenverordnung erfüllt sind.

Damit Ihr Monitor immer den in der Zulassung geforderten Werten entspricht, ist darauf zu achten, daß

1. Reparaturen nur durch Fachpersonal durchgeführt werden.
2. nur original-Ersatzteile verwendet werden.
3. bei Ersatz der Bildröhre nur eine bauartgleiche eingebaut wird.

Aus ergonomischen Gründen wird empfohlen, die Grundfarben Blau und Rot nicht auf dunklem Untergrund zu verwenden (schlechte Lesbarkeit und erhöhte Augenbelastung bei zu geringem Zeichenkontrast wären die Folge).

Der arbeitsplatzbezogene Schalldruckpegel nach DIN 45 635 beträgt 70dB (A) oder weniger.



**ACHTUNG: BEIM AUFSTELLEN DIESES GERÄTES DARAUFGAHTEN, DAß NETZSTECKER UND NETZKABELANSCHLUß LEICHT ZUGÄNGLICH SIND.**

[RETURN TO TOP OF THE PAGE](#)

---

### End-of-Life Disposal

Your new monitor contains materials that can be recycled and reused. Specialized companies can recycle your product to increase the amount of reusable materials and to minimize the amount to be disposed of.

Please find out about the local regulations on how to dispose of your old monitor from your local Philips dealer.

#### **(For customers in Canada and U.S.A.)**

This product may contain lead and/or mercury. Dispose of in accordance to local-state and federal regulations.

For additional information on recycling contact [www.eia.org](http://www.eia.org) (Consumer Education Initiative)

[RETURN TO TOP OF THE PAGE](#)

---

### Information for UK only

**WARNING - THIS APPLIANCE MUST BE EARTHED.**

#### **Important:**

This apparatus is supplied with an approved moulded 13A plug. To change a fuse in this type of plug proceed as follows:

1. Remove fuse cover and fuse.
2. Fit new fuse which should be a BS 1362 5A,A. S.T.A. or BSI approved type.
3. Refit the fuse cover.

If the fitted plug is not suitable for your socket outlets, it should be cut off and an appropriate 3-

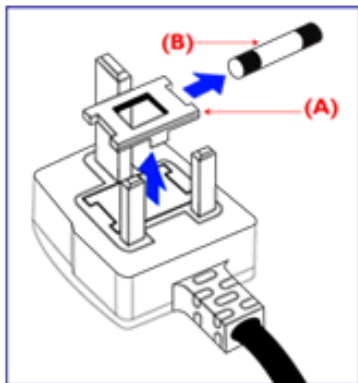

pin plug fitted in its place.

If the mains plug contains a fuse, this should have a value of 5A. If a plug without a fuse is used, the fuse at the distribution board should not be greater than 5A.

Note: The severed plug must be destroyed to avoid a possible shock hazard should it be inserted into a 13A socket elsewhere.

### How to connect a plug

The wires in the mains lead are coloured in accordance with the following code:

BLUE - "NEUTRAL" ("N")

BROWN - "LIVE" ("L")

GREEN & YELLOW - "EARTH" ("E")

1. The GREEN AND YELLOW wire must be connected to the terminal in the plug which is marked with the letter "E" or by the Earth symbol  $\perp$  or coloured GREEN or GREEN AND YELLOW.

2. The BLUE wire must be connected to the terminal which is marked with the letter "N" or coloured BLACK.

3. The BROWN wire must be connected to the terminal which marked with the letter "L" or coloured RED.

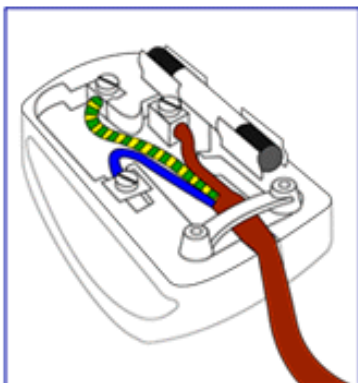

Before replacing the plug cover, make certain that the cord grip is clamped over the sheath of the lead - not simply over the three wires.

[RETURN TO TOP OF THE PAGE](#)



- Safety and Troubleshooting
- FAQs

## Other Related Information

---

- Troubleshooting
- Regulatory Information
- Information for Users in the U.S
- Information for Users Outside the U.S

### Information for Users in the U. S.

*For units set at 115 V :*

Use a UL Listed Cord Set consisting of a minimum 18 AWG, Type SVT or SJT three conductor cord a maximum of 15-feet long and a parallel blade, grounding type attachment plug rated 15 A, 125 V.

*For units set at 230 V:*

Use a UL Listed Cord Set consisting of a minimum 18 AWG, Type SVT or SJT three conductor cord a maximum of 15-feet long and a tandem blade, grounding type attachment plug rated 15 A, 250 V.

---

### Information for Users outside the U.S.

*For units set at 230 V:*

Use a Cord Set consisting of a minimum 18 AWG cord and grounding type attachment plug rated 15 A, 250 V. The Cord Set should have the appropriate safety approvals for the country in which the equipment will be installed and / or be marked HAR.

[RETURN TO TOP OF THE PAGE](#)

- Product Information
- Philips Pixel Defect Policy
- SmartManage Introduction
- SmartManage Features and Benefits
- Philips SmartControl
- Q&A

## SmartManage

---

### Introduction

Philips SmartManage is an advanced solution for users, corporate users in particular, to manage their Philips monitors as part of the asset management environment. The solution includes three essential components, Philips SmartManage Administrator, and Philips SmarControl and Agent.



Philips SmartManage is a joint developed solution between Philips and Altiris Inc.

### SmartManage Features and Benefits

The Philips SmartManage is a working console for IT management to gather monitors assets information, run asset report, control assets security, monitor assets security, and issue instant messages to monitor users.

The Philips SmartManage contains the following major features:

1. Provide an additional security measure for corporate users to ensure their investments.
2. Power saving feature to reduce utility cost and manpower to turn on/off monitors.
3. SmartControl provides an extra way to adjust the performance and settings of the monitors.
4. Built-in asset reports reduce audit/maintenance manpower, cycle time, and costs.

For more information of Philips SmartManage, please contact with Philips sales representatives in your country.

### Philips SmartControl

The SmartControl and SmartManage Agent are deployed and installed in computers using Philips monitors. So the monitors and PC can interact with the Administrator's inquiries.

#### 1. Requirement

- All graphic cards with nVIDIA and ATI graphic chipsets which support DDC/CI interface
- Microsoft Windows 2000 and XP operation systems.
- All Philips monitors supporting DDC/CI interface

## 2. Installation

How to download "SmartControl Installation " file:

1. Visit [http:// www.philips.com](http://www.philips.com)
2. Select "your country"
3. Click into "PC stuff or monitors" page
4. Select "Manuals/drivers"
5. Enter "Download" page
6. Select "SmartControl Installation", and you can download SmartControl and its driver for installation.

Please follow the guidance in the SmartControl installation program.

## 3. Accessing SmartControl

- Right click on the desktop of your PC, and select **Properties** from the shortcut menu pops up.
- Click on **Settings** tab, and click on **Advanced** button.
- Click **Philips SmartControl** tab.

## 4. SmartControl Options

- **Display and Sound**  
By moving the sliding bar toward left or right, users will be able to adjust brightness, contrast, volume (if applicable), video noise (not applicable when using DVI-D input), and color temperatures.

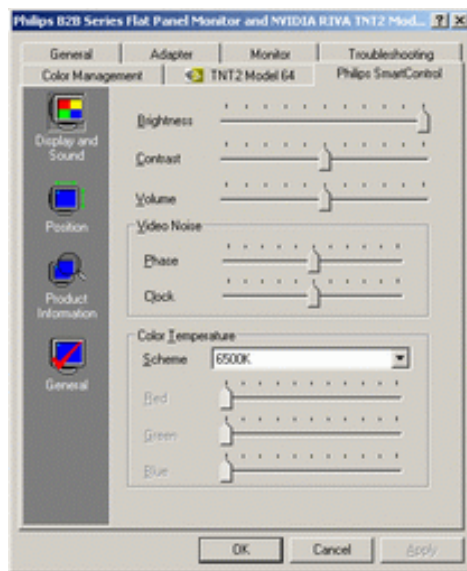

- **Position**  
Users can adjust the horizontal and vertical position of the screen by moving the sliding bar left and right. This function is disabled when using DVI-D (digit) input.

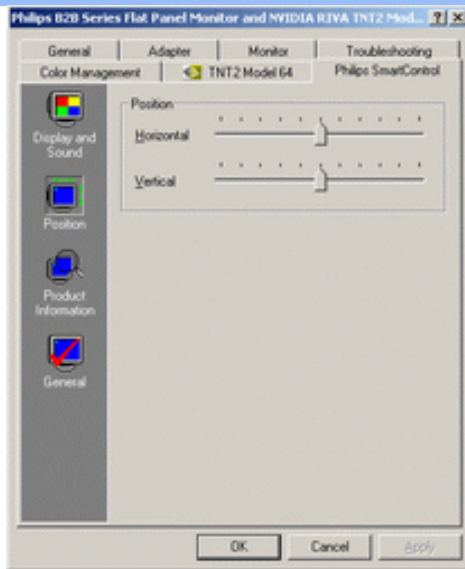

- **Product Information**

Click Product Information in the left pane to view the product information stored in the monitor's memory.

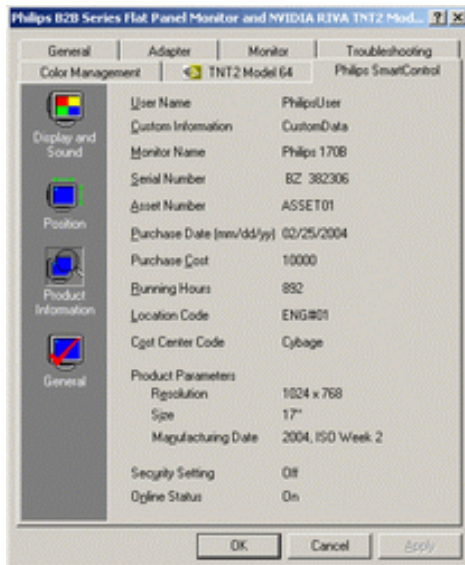

- **General**

Click on general, users will be able to know some general information such as driver information, device information and monitor control.

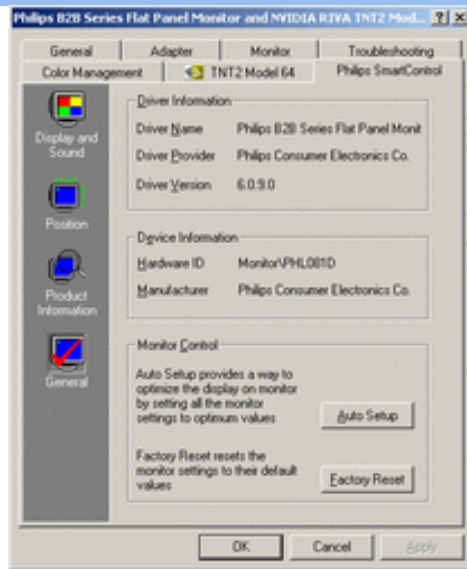

Within monitor control, users can click on Auto Setup to achieve optimum performance or click on factory reset to reset the parameters of the monitor. Such choices are disabled when using DVI-D (digit) input.

## Q&A

**Q1.** What is the difference between SmartManage, SmartControl?

**A.** SmartManage is a remote management/control software for IT managers to manage monitors across the network

SmartControl is a control panel extension, which helps users to adjust monitor performances and settings by a software interface, instead of the hardware buttons at the front bezel of the monitors.

**Q2.** I change the monitor on a PC to a different one and the SmartControl becomes un-usable, what do I do?

**A.** Restart your PC and see if SmartControl can work. Otherwise, you will need to remove and re-install SmartControl to ensure proper driver is installed.

**Q3.** The SmartControl functions well at the beginning, but it is not workable, what can I do?

**A.** If the following actions were executed, the monitor driver may need to be re-installed.

- Change video graphic adapter to another one
- Update video driver
- Activities on OS, such as service pack or patch
- Run Windows Update and updated monitor and/or video driver
- Windows was booted with the monitor power off or disconnected.

To find out, please right click My Computer and click on Properties->Hardware-> Device Manager. If you see "Plug and Play Monitor" shows under Monitor, then you need to re-install. Simply remove SmartControl and re-install it.

**Q4.** After installing SmartControl, when clicking on SmartControl tab, nothing shows up after a while or a failure message shows, what happened?

**A.** It might be your graphic adaptor is not compatible with the SmartControl. If your graphic adaptor is one of the above mentioned brands, try to download the most updated graphic adaptor driver from corresponding companies' web site. Install the driver. Remove SmartControl, and re-install it once more.

If it is still not working, we are sorry that the graphic adaptor is not supported. Please pay attention to Philips' web site for any updated SmartControl driver available.

**Q5.** When I click on Product Information, only partial information is shown, what happened?

**A.** It might be your graphic card adaptor driver is not the most updated version which fully supporting DDC/CI interface. Please try to download the most updated graphic adaptor driver from corresponding companies' web site. Install the driver. Remove SmartControl, and re-install it once more.

[RETURN TO TOP OF THE PAGE](#)

- SmartManage

## Philips Pixel Defect Policy

- Product

- Features

- Technical

- Specifications

- Resolution & Preset Modes

- Automatic Power Saving

- Physical Specification

- Pin Assignment

- Product Views

### Philips' Flat Panel Monitors Pixel Defect Policy

Philips strives to deliver the highest quality products. We use some of the industry's most advanced manufacturing processes and practice stringent quality control. However, pixel or sub pixel defects on the TFT LCD panels used in flat panel monitors are sometimes unavoidable. No manufacturer can guarantee that all panels will be free from pixel defects, but Philips guarantees that any monitor with an unacceptable number of defects will be repaired or replaced under warranty. This notice explains the different types of pixel defects and defines acceptable defect levels for each type. In order to qualify for repair or replacement under warranty, the number of pixel defects on a TFT LCD panel must exceed these acceptable levels. For example, no more than 0.0004% of the sub pixels on a 15" XGA monitor may be defective. Furthermore, Philips sets even higher quality standards for certain types or combinations of pixel defects that are more noticeable than others. This policy is valid worldwide.

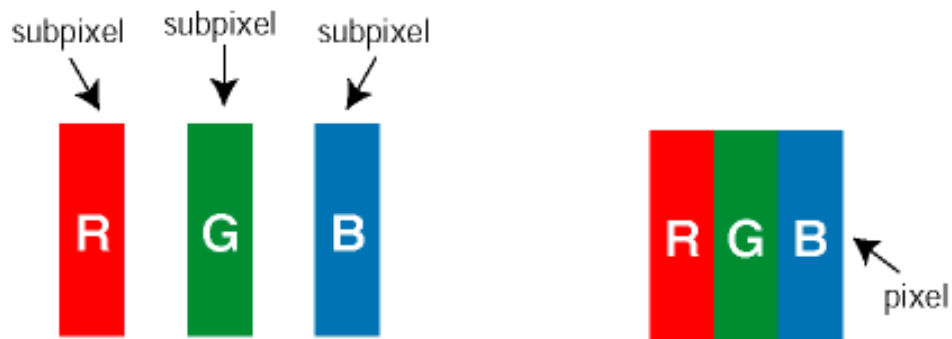

#### Pixels and Sub pixels

A pixel, or picture element, is composed of three sub pixels in the primary colors of red, green and blue. Many pixels together form an image. When all sub pixels of a pixel are lit, the three colored sub pixels together appear as a single white pixel. When all are dark, the three colored sub pixels together appear as a single black pixel. Other combinations of lit and dark sub pixels appear as single pixels of other colors.

#### Types of Pixel Defects

Pixel and sub pixel defects appear on the screen in different ways. There are two categories of pixel defects and several types of sub pixel defects within each category.

**Bright Dot Defects** Bright dot defects appear as pixels or sub pixels that are always lit or 'on'. These are the types of bright dot defects:

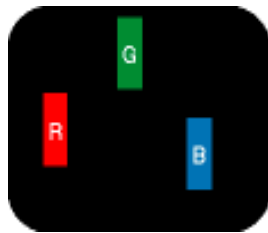

One lit red, green or blue sub pixel

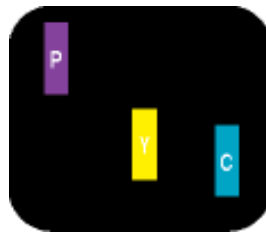

Two adjacent lit sub pixels:

- Red + Blue = Purple
- Red + Green = Yellow
- Green + Blue = Cyan (Light Blue)

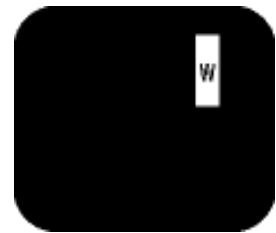

Three adjacent lit sub pixels (one white pixel)

**Black Dot Defects** Black dot defects appear as pixels or sub pixels that are always dark or 'off'. These are the types of black dot defects:

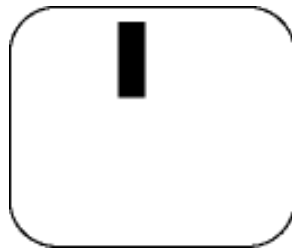

One dark sub pixel

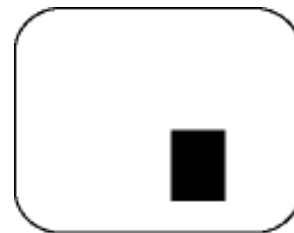

Two or three adjacent dark sub pixels

### Proximity of Pixel Defects

Because pixel and sub pixels defects of the same type that are near to one another may be more noticeable, Philips also specifies tolerances for the proximity of pixel defects.

### Pixel Defect Tolerances

In order to qualify for repair or replacement due to pixel defects during the warranty period, a TFT LCD panel in a Philips flat panel monitor must have pixel or sub pixel defects exceeding the tolerances listed in the following tables.

BRIGHT DOT DEFECTS	ACCEPTABLE LEVEL	
<i>MODEL</i>	<b>150B5</b>	<b>150S5</b>
1 lit subpixel	0	4 or fewer
2 adjacent lit subpixels	0	2 or fewer



3 adjacent lit subpixels (one white pixel)	0	0
Distance between two bright dot defects*	0	15 mm or more
Total bright dot defects of all types	0	4 or fewer

BLACK DOT DEFECTS	ACCEPTABLE LEVEL	
	150B5	150S5
MODEL		
1 dark subpixel	4 or fewer	4 or fewer
2 adjacent dark subpixels	1 or fewer	2 or fewer
3 adjacent dark subpixels	0	0
Distance between two black dot defects*	15 mm or more	15 mm or more
Total black dot defects of all types	4 or fewer	4 or fewer

TOTAL DOT DEFECTS	ACCEPTABLE LEVEL	
	150B5	150S5
MODEL		
Total bright or black dot defects of all types	4 or fewer	5 or fewer

Note:

\* 1 or 2 adjacent sub pixel defects = 1 dot defect

All Philips monitors are ISO13406-2 Compliant







[RETURN TO TOP OF THE PAGE](#)

## Connecting to Your PC

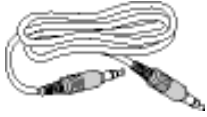
- Front View
- Product Description
- Accessory Pack
- Connecting to Your PC
- Getting Started
- Optimizing Performance
- The base

### Accessory Pack

Unpack all the parts.

Item	Description
	<p><b>1)</b> Audio in Cable (Option only available for Multimedia version) (color lime)</p>
	<p><b>2)</b> Microphone out Cable (Option only available for Multimedia version)(color pink)</p>
	<p><b>3)</b> Power Cable (socket may differ for different countries)</p>
	<p><b>4)</b> Macintosh Adapter (optional)</p>
	<p><b>5)</b> VGA Signal Cable</p>
	<p><b>6)</b> E-DFU package with Quick Setup Guide and CD-ROM.</p>

[RETURN TO TOP OF THE PAGE](#)

## Connecting to Your PC

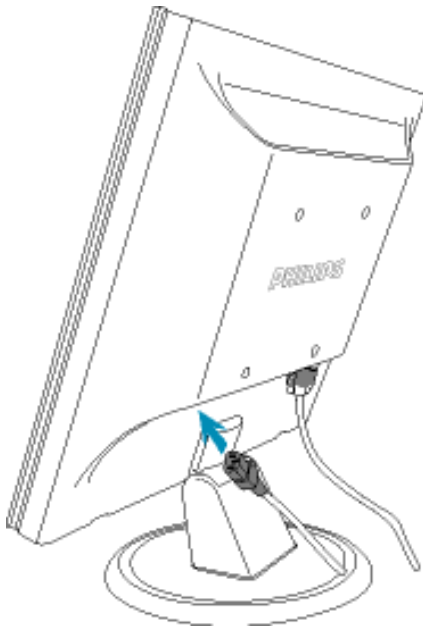

1) Plug the power cord into monitor firmly.

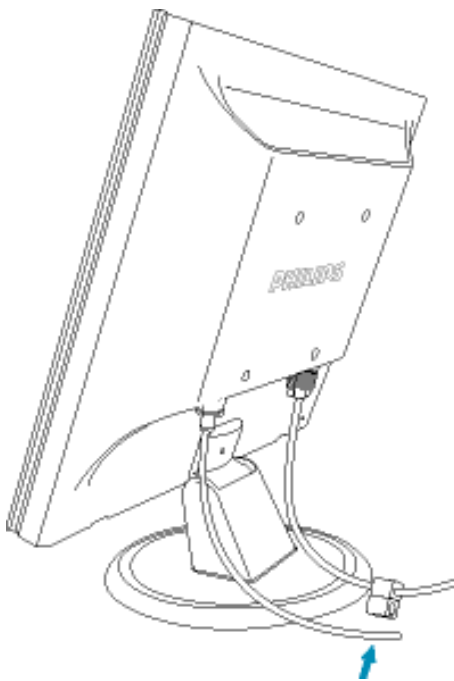

2) Clip the power cord and signal cable together for cable management.

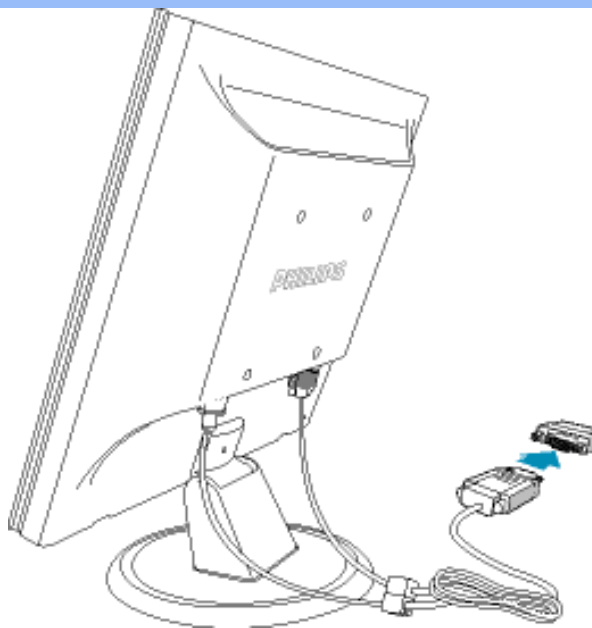

**Note:** If you use an Apple Macintosh, you need to connect the special Mac adapter to one end of the monitor signal cable.

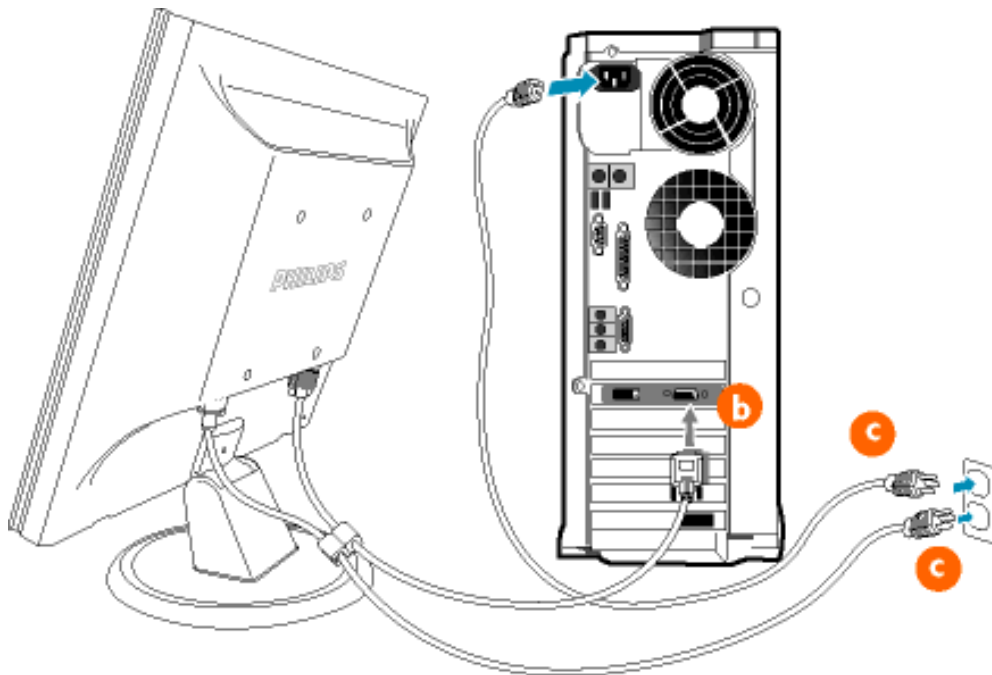

## 2) Connect to PC

- (a) Turn off your computer and unplug its power cable.
- (b) Connect the monitor signal cable to the video connector on the back of your computer.
- (c) Plug the power cord of your computer and your monitor into a nearby outlet.
- (d) Turn on your computer and monitor. If the monitor displays an image, installation is complete.

[RETURN TO TOP OF THE PAGE](#)

## The Base

- Front View
- Product Description
- Accessory Pack
- Connecting to your PC
- Getting Started
- Optimizing Performance
- **Unfold the Base**
- **Fold the Base**
- Remove the Base

### Unfold and Fold the Base

#### Unfold the Base

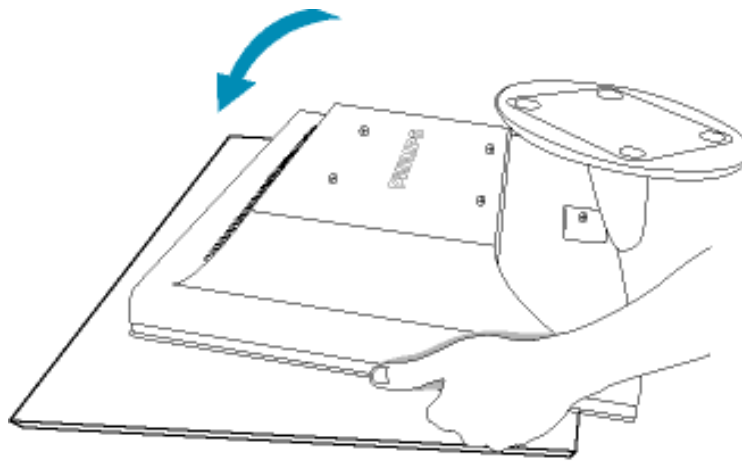

Safe surface

1) Put monitor face down on the safe surface.



2) Pull up the base.

#### Fold the Base

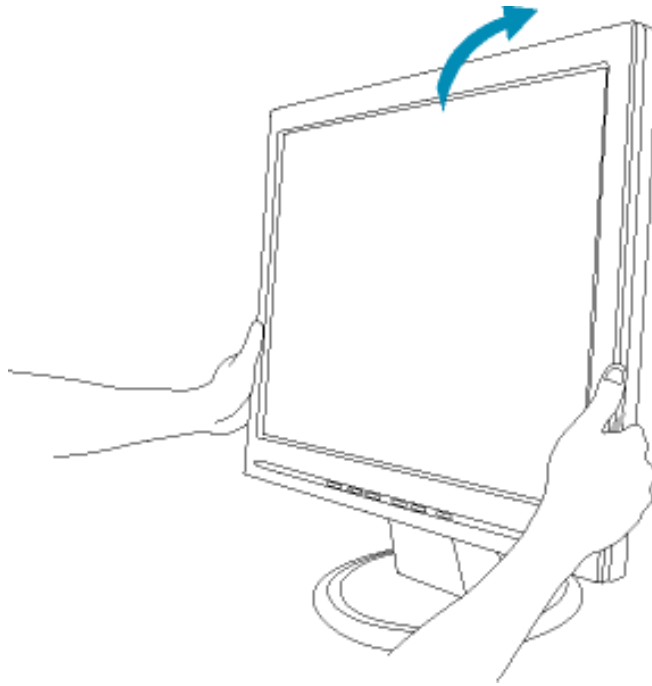

**1)** Push down the head of monitor.

[RETURN TO TOP OF THE PAGE](#)

---

## Remove the Base

### Condition:

- for VESA standard mounting applications

**1)** Remove the screw and then

remove the top cover.

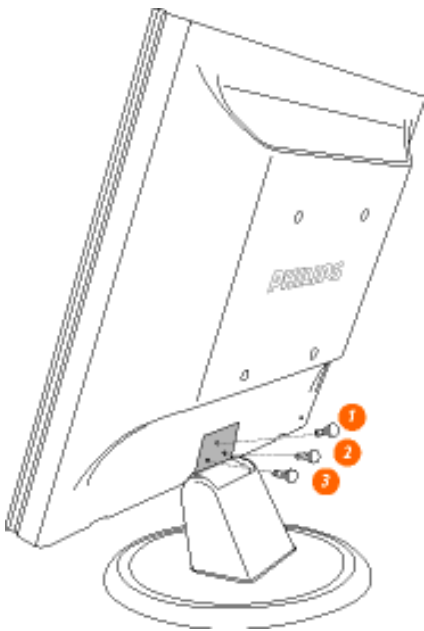
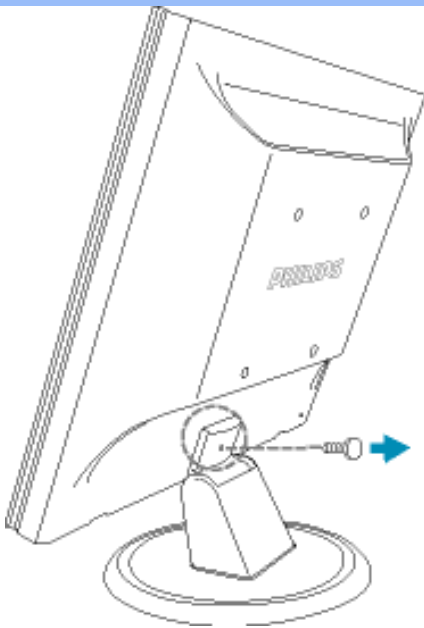

2) Remove the 3 screws and then remove the base from the LCD monitor.

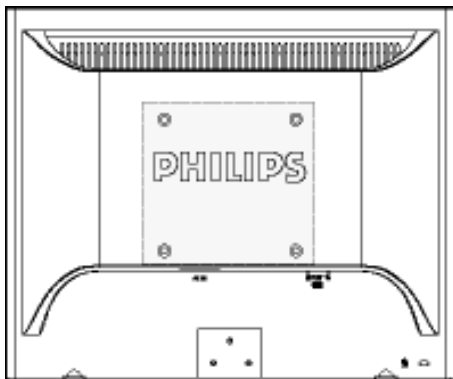

**Note:** This monitor accepts a 100mmx100mm VESA-Compliant mounting interface.

[RETURN TO TOP OF THE PAGE](#)





## Your LCD Monitor :

- Front View Product Description
- Setting Up and Connecting Your Monitor
- Getting Started
- Optimizing Performance

# Getting Started

---

## Getting Started

### Use the information file ( .inf) for Windows® 95/98/2000/Me/XP or later

The built-in VESA DDC2B feature in Philips Monitors supports Plug & Play requirements for Windows® 95/98/2000/Me/XP. This information file ( .inf) should be installed in order that your Philips monitor can be enabled from the 'Monitor' dialog box in Windows® 95/98/2000/Me/XP and the Plug & Play application can be activated. The installation procedure based on Windows® '95 OEM Release 2 , 98 , Me, XP and 2000 is specified as follows.

#### For Windows® 95

1. Start Windows® '95
2. Click on the 'Start' button, point to 'Settings', and then click on 'Control Panel'.
3. Double click on the 'Display' Icon.
4. Select the 'Settings' tab then click on 'Advanced...'
5. Select the 'Monitor' button, point to 'Change...' then click on 'Have Disk...'
6. Click on the 'Browse...' button, select the appropriate drive F: ( CD-ROM Drive) then click on the 'OK' button.
7. Click on the 'OK' button then select your monitor model and click on 'OK'.
8. Click on the 'Close' button.

#### For Windows® 98

1. Start Windows® 98
2. Click on the 'Start' button, point to 'Settings', and then click on 'Control Panel'.
3. Double click on the 'Display' Icon.
4. Select the 'Settings' tab then click on 'Advanced...'
5. Select the 'Monitor' button, point to 'Change...' then click on 'Next'
6. Select 'Display a list of all the drivers in a specific location, so you can choose the driver you want.' then click on 'Next' and then click on 'Have Disk...'
7. Click on the 'Browse...' button, select the appropriate drive F: ( CD-ROM Drive) then click on the 'OK' button.
8. Click on the 'OK' button then select your monitor model and click on the 'Next' button.
9. Click on the 'Finish' button then the 'Close' button.

#### For Windows® Me

1. Start Windows® Me
2. Click on the 'Start' button, point to 'Settings', and then click on 'Control Panel'.
3. Double click on the 'Display' Icon.
4. Select the 'Settings' tab then click on 'Advanced...'
5. Select the 'Monitor' button, then click on 'Change...' button.

6. Select 'Specify the location of the driver(Advanced)' and click on the 'Next' button.
7. Select 'Display a list of all the drivers in a specific location, so you can choose the driver you want', then click on 'Next' and then click on 'Have Disk...'.  
8. Click on the 'Browse...' button, select the appropriate drive F: ( CD-ROM Drive) then click on the 'OK' button.
9. Click on the 'OK' button, select your monitor model and click on the 'Next' button.
10. Click on 'Finish' button then the 'Close' button.

### For Windows® 2000

1. Start Windows® 2000
2. Click on the 'Start' button, point to 'Settings', and then click on 'Control Panel'.
3. Double click on the 'Display' Icon.
4. Select the 'Settings' tab then click on 'Advanced...'.  
5. Select 'Monitor'
  - If the 'Properties' button is inactive, it means your monitor is properly configured. Please stop installation.
  - If the 'Properties' button is active. Click on 'Properties' button. Please follow the steps given below.
6. Click on 'Driver' and then click on 'Update Driver...' then click on the 'Next' button.
7. Select 'Display a list of the known drivers for this device so that I can choose a specific driver', then click on 'Next' and then click on 'Have disk...'.  
8. Click on the 'Browse...' button then select the appropriate drive F: ( CD-ROM Drive).
9. Click on the 'Open' button, then click on the 'OK' button.
10. Select your monitor model and click on the 'Next' button.
11. Click on the 'Finish' button then the 'Close' button.  
If you can see the 'Digital Signature Not Found' window, click on the 'Yes' button.

### For Windows® XP

1. Start Windows® XP
2. Click on the 'Start' button and then click on 'Control Panel'.
3. Select and click on the category 'Printers and Other Hardware'
4. Click on the 'Display' Item.
5. Select the 'Settings' tab then click on the 'Advanced' button.
6. Select 'Monitor' tab
  - If the 'Properties' button is inactive, it means your monitor is properly configured. Please stop installation.
  - If the 'Properties' button is active, click on 'Properties' button.  
Please follow the steps below.
7. Click on the 'Driver' tab and then click on 'Update Driver...' button.
8. Select the 'Install from a list or specific location [advanced]' radio button and then click on the 'Next' button.
9. Select the 'Don't Search. I will choose the driver to install' radio button. Then click on the 'Next' button.
10. Click on the 'Have disk...' button, then click on the 'Browse...' button and then select the appropriate drive F: (CD-ROM Drive).
11. Click on the 'Open' button, then click the 'OK' button.
12. Select your monitor model and click on the 'Next' button.
  - If you can see the 'has not passed Windows® Logo testing to verify its compatibility with Windows® XP' message, please click on the 'Continue Anyway' button.
13. Click on the 'Finish' button then the 'Close' button.
14. Click on the 'OK' button and then the 'OK' button again to close the Display\_Properties

dialog box.

If your Windows® 95/98/2000/Me/XP version is different or you need more detailed installation information, please refer to Windows® 95/98/2000/Me/XP user's manual.

[RETURN TO TOP OF THE PAGE](#)

## Your Philips F1rst Choice Warranty

**Thank you for purchasing this Philips monitor.**



All Philips monitors are designed and manufactured to high standards and deliver high-quality performance, ease of use and ease of installation. Should you encounter any difficulties while installing or using this product, please contact the Philips helpdesk directly to benefit from your Philips F1rst Choice Warranty. This three-year service warranty entitles you to a swap model on-site if your monitor turns out to be faulty or defective. Philips aims at a swap within 48 hours of your call being received.

### What is covered?

The Philips F1rst Choice Warranty applies within Andorra, Austria, Belgium, Cyprus, Denmark, France, Germany, Greece, Finland, Ireland, Italy, Liechtenstein, Luxembourg, Monaco, the Netherlands, Norway, Portugal, Sweden, Switzerland, Spain and the United Kingdom and only for monitors originally designed, manufactured, approved and/or authorized for usage within these countries.

Warranty coverage begins as from the day you buy your monitor. *For three years thereafter*, your monitor will be swapped by at least an equivalent monitor in case of defects provided for under the warranty coverage.

The swap monitor remains yours and Philips keeps the defective/original monitor. For the swap monitor the warranty period remains equal to that of your original monitor, being 36 months as from the purchase date of your original monitor.

### What is excluded?

The Philips F1rst Choice Warranty applies provided the product is handled properly for its intended use, in accordance with its operating instructions and upon presentation of the original invoice or cash receipt, indicating the date of purchase, dealer's name and model and production number of the product.

The Philips F1rst Choice Warranty may not apply if:

- The documents have been altered in any way or made illegible;
- The model or production number on the product has been altered, deleted, removed or made illegible;
- Repairs or product modifications and alterations have been executed by unauthorized service organizations or persons;
- Damage is caused by accidents including but not limited to lightning, water or fire, misuse or neglect;

- Reception problems caused by signal conditions or cable or antenna systems outside the unit;
- Defects caused by abuse or misuse of the monitor;
- Product requires modification or adaptation to enable it to comply with local or national technical standards, which apply in countries for which the product was not originally designed, manufactured, approved and/or authorized. Therefore always check whether a product can be used in a specific country.
- Note that products that are not originally designed, manufactured, approved and/or authorized for usage within the Philips F1rst Choice countries, do not apply to the Philips F1rst Choice Warranty. In these cases the Philips global warranty terms are valid.

### Just a click away

In case of any problems, we advise you to read the operating instructions carefully or go to the [www.philips.com/support](http://www.philips.com/support) website for additional support.

### Just a phone call away

In order to avoid unnecessary inconvenience, we advise you to read the operating instructions carefully or go to the [www.philips.com/support](http://www.philips.com/support) website for additional support before contacting the Philips helpdesk.

To solve your problem quickly, please prepare the following details before contacting the Philips helpdesk:

- Philips type number
- Philips serial number
- Purchase date (copy of purchase may be required)
- PC environment Processor:
  - 286/386/486/Pentium Pro/Internal memory
  - Operating system (Windows, DOS, OS/2, MAC)
  - Fax/Modem/Internet program?
- Other cards installed

Having the following information available will also help speed up the process:

- Your proof of purchase indicating: date of purchase, dealer name, model and product serial number.
- The full address to which the faulty monitor has to be collected and the swap model should be delivered.

Philips' customer help desks are located worldwide. Click here to access the [F1rst Choice Contact Information](#).

Or you can reach us via:

Website: <http://www.philips.com/support>



## Your International Guarantee

Dear Customer,

Thank you for purchasing this Philips product which has been designed and manufactured to the highest quality standards.

If, unfortunately, something should go wrong with this product Philips guarantees free of charge labor and replacement parts irrespective of the country where it is repaired during a period of 12 months from date of purchase. This international Philips guarantee complements the existing national guarantee obligations to you of dealers and Philips in the country of purchase and does not affect your statutory rights as a customer.

The Philips guarantee applies provided the product is handled properly for its intended use, in accordance with its operating instructions and upon presentation of the original invoice or cash receipt, indicating the date of purchase, dealer's name and model and production number of the product.

The Philips guarantee may not apply if:

- the documents have been altered in any way or made illegible;
- the model or production number on the product has been altered, deleted, removed or made illegible;
- repairs or product modifications and alterations have been executed by unauthorized service organizations or persons;
- damage is caused by accidents including but not limited to lightning, water or fire, misuse or neglect.

Please note that the product is not defective under this guarantee in the case where modifications become necessary in order for the product to comply with local or national technical standards which apply in countries for which the product was not originally designed and/or manufactured. Therefore always check whether a product can be used in a specific country.

In case your Philips product is not working correctly or is defective, please contact your Philips dealer. In the event you require service whilst in another country a dealer address can be given to you by the Philips Consumer Help Desk in that country, the telephone and fax number of which can be found in the relevant part of this booklet.

In order to avoid unnecessary inconvenience, we advise you to read the operating instructions carefully before contacting your dealer. If you have questions which your dealer cannot answer or any related question please contact the [Philips Consumer Information Centers](#) or via:

Website: <http://www.philips.com>





## LIMITED WARRANTY (Computer Monitor)

Click here to access the [Warranty Registration Card](#).

### One Year Exchange\*

*\*Product will be exchanged with a new or renewed to original specifications unit within two business days for the first year.*

### WHO IS COVERED?

You must have proof of purchase to receive warranty service. A sales receipt or other document showing that you purchased the product as new is considered proof of purchase.

### WHAT IS COVERED?

Warranty coverage begins the day you buy your product. *For one year thereafter*, all parts will be repaired or replaced, and labor is free. All parts, including repaired and replaced parts, are covered only for the original warranty period. When the warranty on the original product expires, the warranty on all replaced and repaired products and parts also expires.

### WHAT IS EXCLUDED?

Your warranty does not cover:

- labor charges for installation or setup of the product, adjustment of customer controls on the product, and installation or repair of systems outside of the product.
- product repair and/or part replacement because of misuse, accident, unauthorized repair or other cause not within the control of Philips Consumer Electronics.
- a product that requires modification or adaptation to enable it to operate in any country other than the country for which it was designed, manufactured, approved and/or authorized, or repair of products damaged by these modifications.
- incidental or consequential damages resulting from the product. (Some states do not allow the exclusion of incidental or consequential damages, so the above exclusion may not apply to you. This includes, but is not limited to, prerecorded material, whether copyrighted or not copyrighted.)

- a product used for commercial or institutional purposes.
- a product that has been modified from the original design.

### **Where IS SERVICE AVAILABLE?**

Warranty service is available in all countries where the product is officially distributed by Philips Consumer Electronics. In countries where Philips Consumer Electronics does not distribute the product, the local Philips service organization will attempt to provide service (although there may be a delay if the appropriate spare parts and technical manual(s) are not readily available).

### **Where CAN I GET MORE INFORMATION and HOW CAN I OBTAIN SERVICE?**

For more information, contact the Philips Customer Care Center by calling (877) 835-1838 (U.S.A. customers only) or (919) 573-7855.

### ***Before Requesting Service...***

Please check your owner's manual before requesting service. Adjustments of the controls discussed there may save you a service call.

### **TO GET WARRANTY SERVICE IN U.S.A., PUERTO RICO OR U.S. VIRGIN ISLANDS...**

Contact the Philips Customer Care Center phone number listed below for product assistance and procedures for servicing:

*Philips Customer Care Center*

*877) 835-1838 or (919) 573-7855*

*(In U.S.A., Puerto Rico and U.S. Virgin Islands, all implied warranties, including implied warranties of merchantability and fitness for a particular purpose, are limited in duration to the duration of this express warranty. But, because some states do not allow limitations on how long an implied warranty may last, this limitation may not apply to you.)*

### **TO GET WARRANTY SERVICE IN CANADA...**

Please contact Philips at:

[\(800\) 479-6696](tel:8004796696)

One year free parts and one year free labor will be provided at Philips Canada depot or any one of its authorized service centers.

**REMEMBER... Please record the model and serial numbers found on the product below.**

**MODEL #** \_\_\_\_\_

**SERIAL #** \_\_\_\_\_

*This warranty gives you specific legal rights. You may have other rights which vary from state/province to state/province.*

Philips Customer Care Center, P. O. Box 2976, Longview, TX 75601

Phones	Kitchen Appliances	Household Products	Personal Care
Cordless Phones <	Blending and Juicing <	Household Accessories <	Baby Care <
Faxes <	Coffee Makers and Kettles <	Irons <	Health and Well-Being <
Mobile Phones >	Food Processing and Mixing >	Vacuum Cleaners >	Men`s Grooming >
Mobile Phone Accessories >	Frying and Grilling >	Other >	Oral Care >
Other >	Kitchen Scales >		Woman`s Beauty >
	Toasting and Snacking >		
	Other >		

### Philips General

Computers >
Other >

© Royal Philips Electronics All rights reserved Privacy Policy - Terms of Use

## First Choice Contact Information

### Telephone numbers:

Austria	01 546 575 603	Luxembourg	026 84 3000
Belgium	02 275 0701	Netherlands	053 482 9800
Cyprus (Greek)	800 92256	Norway	22 70 82 50
Denmark	35 25 87 61	Portugal	0800 831 363
France	03 8717 0033	Sweden	08 632 0016
Germany	0696 698 4712	Switzerland	02 23 10 21 16
Greece	00800 3122 1223	Spain	09 17 45 62 46
Finland	09 2290 1908	United Kingdom	0207 949 0069
Ireland	01 601 1161		
Italy	02 48 27 11 53		

## Consumer Information Centers

Antilles • Argentina • Australia • Bangladesh • Brasil • Canada • Chile • China • Colombia • Czech Republic • Dubai • Egypt • Hong Kong • Hungary • India • Indonesia • Korea • Malaysia • Mexico • Morocco • New Zealand • Pakistan • Paraguay • Peru • Philippines • Poland • Russia • Singapore • Slovakia • Slovenia • South Africa • Taiwan • Thailand • Turkey • Uruguay • Venezuela

### Eastern Europe

#### CZECH REPUBLIC

Xpectrum  
Lužná 591/4  
CZ - 160 00 Praha 6  
Phone: 800 100 697  
Email: info@xpectrum.cz  
www.xpectrum.cz

#### HUNGARY

Serware Szerviz  
Vizimolnár u. 2-4  
HU - 1031 Budapest  
Phone: +36 1 2426331  
Email: inbox@serware.hu  
www.serware.hu

#### SLOVAKIA

Datalan Servisne Stredisko  
Puchovska 8  
SK - 831 06 Bratislava  
Phone: +421 2 49207155  
Email: servis@datalan.sk

## SLOVENIA

PC HAND

Brezovce 10

SI - 1236 Trzin

Phone: +386 1 530 08 24

Email: servis@pchand.si

## POLAND

Zolter

ul.Zytnia 1

PL - 05-500 Piaseczno

Phone:+48 22 7501766

Email: servmonitor@zolter.com.pl

www.zolter.com.pl

## RUSSIA

Phone: +7 095 961-1111

Phone: 8-800-200-0880

Web-site: www.philips.ru

## TURKEY

Türk Philips Ticaret A.S.

Yukari Dudullu Org.San.Bolgesi

2.Cadde No:22

34776-Umraniye/Istanbul

Phone: (0800)-261 33 02

## Latin America

### ANTILLES

Philips Antillana N.V.

Kaminda A.J.E. Kusters 4

Zeelandia, P.O. box 3523-3051

Willemstad, Curacao

Phone: (09)-4612799

Fax : (09)-4612772



## ARGENTINA

Philips Antillana N.V.  
Vedia 3892 Capital Federal  
CP: 1430 Buenos Aires  
Phone: (011)-4544 2047

## BRASIL

Philips da Amazônia Ind. Elet. Ltda.  
Av. Luis Carlos Berrini,  
1400 - Sao Paulo -SP  
Phone: 0800-701-0203

## CHILE

Philips Chilena S.A.  
Avenida Santa Maria 0760  
P.O. box 2687 Santiago de Chile  
Phone: (02)-730 2000  
Fax : (02)-777 6730

## COLOMBIA

Industrias Philips de Colombia  
S.A.-Division de Servicio  
CARRERA 15 Nr. 104-33  
Bogota, Colombia  
Phone:(01)-8000 111001 (toll free)  
Fax : (01)-619-4300/619-4104

## MEXICO

Consumer Information Centre  
Norte 45 No.669  
Col. Industrial Vallejo  
C.P.02300, -Mexico, D.F.  
Phone: (05)-3687788 / 9180050462  
Fax : (05)-7284272

## PARAGUAY

Philips del Paraguay S.A.  
Avenida Artigas 1513  
Casilla de Correos 605  
Asuncion  
Phone: (021)-211666  
Fax : (021)-213007

## PERU

Philips Peruana S.A.  
Customer Desk  
Comandante Espinar 719  
Casilla 1841  
Limab18  
Phone: (01)-2136200  
Fax : (01)-2136276

## URUGUAY

Ind.Philips del Uruguay S.A.  
Luis Alberto de Herrera 1248  
Customer Help Desk  
11300 Montevideo  
Phone: (02)-6281111  
Fax : (02)-6287777

## VENEZUELA

Industrias Venezolanas Philips S.A.  
Apartado Postal 1167  
Caracas 1010-A  
Phone: (02) 2377575  
Fax : (02) 2376420

Canada

## CANADA

Philips Electronics Ltd.  
281 Hillmount Road  
Markham, Ontario L6C 2S3  
Phone: (800) 479-6696

## Pacific

## AUSTRALIA

Philips Consumer Service.  
Customer Information Centre.  
3 Figtree Drive  
Homebush Bay NSW 2140  
Phone: CIC: 1300-363 391     PCE Service: 1300-361 392 (toll free)  
Fax : +61 2 9947 0063

## NEW ZEALAND

Philips New Zealand Ltd.  
Consumer Help Desk  
2 Wagener Place, Mt. Albert  
P.O. box 1041  
Auckland  
Phone: 0800 477 999 (toll free)  
Fax : 0800 288 588 (toll free)

## Asia

## BANGLADESH

Philips Service Centre  
100 Kazi Nazrul Islam  
Avenue Kawran Bazar C/A  
Dhaka-1215  
Phone: (02)-812909  
Fax : (02)-813062

## CHINA

### BEIJING

Beijing Authorized Service Centre.  
Consumer Information Centre  
Building 6, West Street  
Chong Wen Men, Beijing, Jin Bang Co. Led.  
100051 BEIJING

### GUANGZHOU

Philips Authorized Service Centre  
801 Dong Feng Road East  
Guangzhou 510080

### SHANGHAI

Philips Service Logistic Centre  
Consumer Information Centre  
P.O.Box 002-027, Nextage Department Store  
Puding New District  
200002 SHANGHAI

Philips Authorized Service Centre  
Consumer Information Centre  
148 Fu Jian Road M  
200001 Shanghai

Phone: 800 820 5128 (toll free)  
Fax: 21-656 10647

## HONG KONG

Philips Hong Kong Limited  
Consumer Information Centre  
16/F Hopewell Centre  
17 Kennedy Road, WANCHAI  
Phone: 2619 9663  
Fax : 2481 5847

## INDIA

Phone: 91-20-712 2048 ext: 2765  
Fax: 91-20-712 1558

**BOMBAY**  
Philips India  
Customer Relation Centre  
Bandbox House  
254-D Dr. A Besant Road, Worli  
Bombay 400 025

**CALCUTTA**  
Customer Relation Centre  
7 justice Chandra Madhab Road  
Calcutta 700 020

**MADRAS**  
Customer Relation Centre  
3, Haddows Road  
Madras 600 006

**NEW DELHI**  
Customer Relation Centre  
68, Shivaji Marg  
New Dehli 110 015

## INDONESIA

Philips Group of Companies in Indonesia  
Consumer Information Centre  
Jl.Buncit Raya Kav. 99-100  
12510 Jakarta  
Phone: (021)-794 0040 / 798 4255 ext: 1612  
Fax : (021)-794 7511 / 794 7539

## KOREA

Philips Korea Ltd.  
Philips House  
C.P.O. box 3680  
260-199, Itaewon-Dong.  
Yongsan-Ku, Seoul 140-202  
Phone:080-600-6600 (Local toll free)  
Fax : (02)-709-1245

## MALAYSIA

Philips Malaysia Sdn. Berhad  
Service Dept.  
No.51,sect.13 Jalan University.  
46200 Petaling Jaya, Selagor.  
P.O.box 12163  
50768 Kuala Lumpur.  
Phone: (03)-7950 5501/02  
Fax : (03)-7954 8504

## PAKISTAN

KARACHI  
Philips Electrical Ind. of Pakistan  
Consumer Information Centre  
F-54, S.I.T.E, P.O.Box 7101  
75730 KARACHI

Philips Consumer Service Centre  
168-F, Adamjee Road  
Rawalpindi Cantt

Phone: (021)-7731927  
Fax : (021)-7721167

## PHILIPPINES

Philips Electronics and Lighting Inc.  
106 Valero St., Salcedo Village  
Makati, Metro Manilla.  
Phone: (02)-888 05 72  
Domestic toll free: 1-800-10-PHILIPS or 1-800-10-744 5477  
Fax : (02)-888 05 71

## SINGAPORE

Philips Singapore Private Ltd.  
Consumer Service Dept.  
Lorong 1, Toa Payoh., P.O. box 340  
Singapore 1231  
Phone: 6882 3999  
Fax : 6250 8037

## TAIWAN

Philips Taiwan Ltd.  
Consumer Information Centre  
13F, No. 3-1 Yuan Qu St., Nan Gang Dist.,  
Taipei 115, Taiwan  
Phone: 0800-231-099  
Fax : (02)-3789-2641

## THAILAND

Philips Electronics (Thailand) Ltd.  
Philips Service Centre  
209/2 Sanpavut Road,  
Bangna, Bangkok 10260  
Phone : (02)-652 8652  
Fax : (02)-614 3531

Africa

## MOROCCO

Philips Electronique Maroc  
304,BD Mohamed V  
Casablanca  
Phone: (02)-302992  
Fax : (02)-303446

## SOUTH AFRICA

South African Philips.  
S.V. Div. 195 Main R.D.  
Martindale., Johannesburg  
P.O.box 58088  
Newville 2114  
Phone: +27 11 471 5000  
Fax : +27 11 471 5020

## Middle East

### DUBAI

Philips Middle East B.V.  
Consumer Information Centre  
P.O.Box 7785  
DUBAI  
Phone: (04)-335 3666  
Fax : (04)-335 3999

### EGYPT

Philips Egypt  
Consumer Information Centre  
10, Abdel Rahman El Rafei  
Mohandessin - Cairo, P.O.Box 242  
DOKKI  
Phone: (02)-3313993  
Fax : (02)-3492142



