

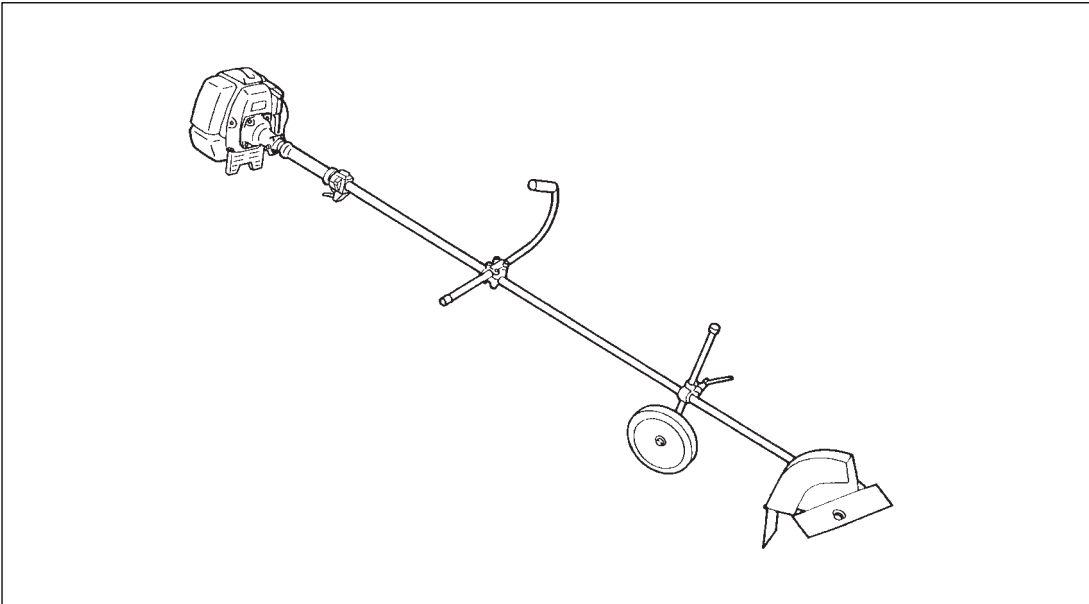

OWNER/OPERATOR MANUAL

STICK EDGERS

HE2601



! WARNING !
The engine exhaust from this product contains chemicals known to the State of California to cause cancer, birth defects or other reproductive harm.

Thank you for purchasing a RedMax product.
Before using our products, please read this manual carefully to understand the proper use of your unit.

APPLICABLE SERIAL NUMBERS :
DRIVE UNIT 000000 and up ENGINE UNIT 900101 and up



Read this manual carefully to understand all safety precautions, controls, proper operation and maintenance of your RedMax stick edgers. Failure to do so could result in serious injury.



SAFETY FIRST

Instructions contained in warnings within this manual marked with a  symbol concern critical points which must be taken into consideration to prevent possible serious bodily injury, and for this reason you are requested to read all such instructions carefully and follow them without fail.

Note that there may be times when warning seals peel off or become soiled and impossible to read. If this happens, you should contact the dealer from which you purchased the product to order new seals and affix the new seal(s) in the required location(s).

■ Notes on types of warnings



Instructions labeled as shown at left, concern critical steps or procedures which must be followed in order to prevent accidents which could lead to serious bodily injury or death. This mark is used to indicate instructions which must be followed without exception.



Instructions labeled as shown at left concern steps or procedures which, if not followed correctly, could lead to mechanical failure, breakdown, or damage.



Used to label supplementary instructions designed to provide hints or directions useful in the use of the product.

CONTENTS

SAFETY PRECAUTIONS	2
PROPER AND SAFE OPERATION OF YOUR STICK EDGER	
WORK GEAR AND CLOTHING	
WARNINGS CONSIDERING HANDLING OF FUEL	
THINGS TO CHECK BEFORE USING YOUR STICK EDGER	
THINGS TO CHECK BEFORE STARTING UP THE ENGINE	
AVOID NOISE PROBLEM	
THINGS TO BE CAREFUL ABOUT WHEN USING YOUR STICK EDGER	
NOTES ON CARE AND MAINTENANCE OF YOUR STICK EDGER	
SET UP	7
FUEL	8
HOW TO MIX FUEL	
FUELING THE UNIT	
OPERATION	9
ADJUSTING HANDLE POSITION	
ADJUSTING WHEEL HEIGHT	
STARTING ENGINE	
STOPPING ENGINE	
ADJUSTING IDLING SPEED	
HOW TO USE ..	11
MAINTENANCE	12
BE SURE TO CHECK THE FOLLOWING BEFORE USING YOUR STICK EDGER	
REGULAR MAINTENANCE INSPECTION	
AIR FILTER	
FUEL FILTER	
SPARK PLUG	
MUFFLER	
SPARK ARRESTER	
GEAR CASE	
INTAKE AIR COOLING VENT	
PROCEDURES TO BE PERFORMED AFTER EVERY 100 HOURS OF USE	
STORAGE	15
SPECIFICATIONS	16
PARTS LIST	17



Safety Precautions

■ IN ORDER TO ENSURE PROPER AND SAFE OPERATION OF YOUR STICK EDGER

- Read this Owner/Operator Manual carefully. Be sure you understand how to operate this unit properly before you use it. Failure to do so could result in serious injury.



- Be sure to keep this manual handy so that you may refer to it later whenever any questions arise. Also note that you are requested to contact the dealer from whom you purchased the product for assistance in the event that you have any questions which cannot be answered herein.
 - Always be sure to include this manual when selling, lending, or otherwise transferring the ownership of this product.
- This product has been designed for use in edging and it should never be used for any other purpose since doing so could result in unforeseen accidents and injuries occurring.
 - This product is equipped with extremely sharp blades, and when used improperly these blades can be extremely dangerous. For this reason, you should never use this stick edger when under the influence of alcohol, when suffering from exhaustion or lack of sleep, when suffering from drowsiness as a result of having taken cold medicine, or at any other time when a possibility exists that your judgment might be impaired or that you might not be able to operate the stick edger properly and in a safe manner. Also be sure never to allow children or anyone unable to fully understand the directions given in this manual to use this stick edger.



- Avoid running the engine indoors. The exhaust gases contain harmful carbon monoxide.

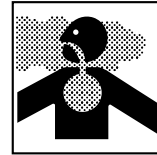

- Never use your stick edger under circumstances like those described below:
 1. When the ground is slippery or when other conditions exist which might make it not possible to maintain a steady posture while using the stick edger.
 2. At night, at times of heavy fog, or at any other times when your field of vision might be limited and it would be difficult to gain a clear view of the area where the stick edger is to be used to ensure safety.
 3. During rain storms, during lightning storms, at times of strong or gale-force winds, or at any other times when weather conditions might make it unsafe to use this product.
- When using this product for the first time, before beginning actual work, take the stick edger to a wide, clear, open space, turn on the power, and practice handling the stick edger until you are sure that you will be able to handle it properly in actual operation.
- Lack of sleep, tiredness, or physical exhaustion results in lower attention spans, and this in turn leads to accidents and injury. When planning your work schedule, allow plenty of time to perform the work of edging and allow plenty of time for rest. Limit the amount of time over which the stick edger is to be used continuously to somewhere around 30~40 minutes per session, and take 10~20 minutes of rest between work sessions. Also try to keep the total amount of work performed in a single day under 2 hours or less.



Safety Precautions

■ WORK GEAR AND CLOTHING

- When using your stick edger, always be sure to wear strong, durable, work clothing; shirts should be long-sleeved shirts and pants should be full-length pants reaching down to the ankles.
- Always be sure to wear a helmet and face protector when using your stick edger.
- When using your stick edger, always be sure to wear thick work gloves to protect your hands and non-slip-sole work boots to prevent you from slipping. Never use your stick edger when wearing pants with loose cuffs, when wearing sandals, or when barefoot.
- When using your stick edger for an extended period of time, you should wear ear protectors to protect yourself from loss of hearing from overexposure to high levels of sound.

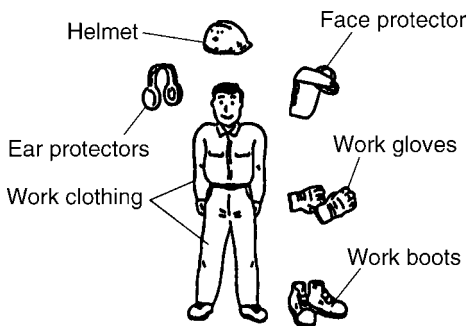

■ WARNINGS CONSIDERING HANDLING OF FUEL

- The engine of the RedMax stick edger is designed to run on a mixed fuel which contains highly flammable gasoline. This fuel is highly flammable and you should never store cans of fuel or refill the tank of the stick edger in any place where there is a boiler, stove, wood fire, electrical sparks, welding sparks, or any other source of heat or fire which might ignite the fuel.



- Smoking while operating the stick edger or refilling its fuel tank is extremely dangerous. Always be sure to keep lit cigarettes away from the stick edger at all times.
- When refilling the tank always turn off the engine first and take a careful look around to make sure that there are no sparks or open flames anywhere nearby before refueling.
- If any fuel spillage occurs during refueling, always be sure to use a dry rag to wipe any fuel which has been spilled onto the stick edger before turning the engine back on again.
- After refueling, screw the fuel cap back tightly onto the fuel tank and then carry the stick edger to a spot 10 feet (3m) or more away from where it was refueled before turning on the engine.



Safety Precautions

■ THINGS TO CHECK BEFORE USING YOUR STICK EDGER

- Before beginning work, look around carefully to get a feel for the shape of the land and whether or not there are any obstacles which might get in the way while working, and remove any obstacles which can be cleared away before beginning work.
- The area within a perimeter of 50 feet (15m) of the person using the stick edger should be considered a hazardous area into which no one should enter while the stick edger is in use, and when necessary yellow warning rope, warning signs, or some other form of warnings should be placed around the perimeter of the area. When work is to be performed simultaneously by two or more persons, care should also be taken to constantly look around or otherwise check for the presence and locations of other people using stick edgers within the work area so as to maintain a distance between each person sufficient to ensure safety.
- Before beginning work, each component of the stick edger should be checked to make sure that it is in proper working order and to make sure that there are no loose screws or bolts, fuel leaks, ruptures, dents, or any other problems which might interfere with safe operation. Be especially careful at this time to check that there is nothing wrong with the blades or with the joints by which the blades are attached to the stick edger.
- Never use the stick edger when the blades have been worn down severely or when there is any sort of damage which has occurred to the blade mechanism.
- Check to make sure that the handle grip and the protective cover have not come loose before using the stick edger.

■ THINGS TO CHECK BEFORE STARTING UP THE ENGINE

- Take a careful look around to make sure that no obstacles exist within a perimeter of 15 feet (5m) or less around the stick edger before starting the engine.

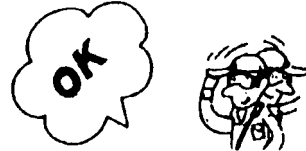

- The RedMax stick edger is equipped with a centrifugal clutch mechanism which causes the cutting blades to begin to rotate as soon as the engine is started by putting the throttle into the start position. When starting the engine, place the body of the stick edger onto the ground in a flat clear area and hold it firmly in place so as to ensure that neither the blades nor the throttle come into contact with any obstacles when the engine starts up.
- Never place the throttle into the high speed position when starting the engine.
- After starting up the engine, check to make sure that the blades stop rotating when the throttle is moved fully back to its original position. If the blades continue to rotate even after the throttle has been moved fully back, turn off the engine and take the unit to your authorized Red Max servicing dealer for repair.

■ AVOID NOISE PROBLEM

NOTE

Check and follow the local regulations as to sound level and hours of operations for stick edger.

- In general, operate stick edgers between 8a.m. and 5p.m. on week days and 9a.m. to 5p.m. weekends. Avoid using stick edger late at night and/or early in the morning.



Safety Precautions

■ THINGS TO BE CAREFUL ABOUT WHEN USING YOUR STICK EDGER

- When using your stick edger, grip the handles of the stick edger firmly with both hands, place your feet slightly apart (slightly further apart than the width of your shoulders) so that your weight is distributed evenly across both legs, and always be sure to maintain a steady, even posture while working.
- Maintain the speed of the engine at the level required to perform edging work, and never raise the speed of the engine above the level necessary.
- Always be sure never to allow other persons to come within the work area while edging.
- Be especially careful not to slip if it is raining or if rain has just stopped, as the ground is likely to be slippery at such times.
- Guard against hazardous situations at all times. Warn adults to keep pets and children away from the area. Establish a safe method for gaining your attention during operation. Be careful if you are approached.
- If someone calls out or otherwise interrupts you while working, always be sure to turn off the engine before turning around.
- Keep operation area clear of all persons, particularly small children and pets. Injury may result from flying debris.
- Never touch the spark plug or plug cord while the engine is in operation. Doing so may result in being subjected to an electrical shock.



- Never touch the muffler, spark plug, or other metallic parts of the engine while the engine is in operation or immediately after shutting down the engine. These metallic parts reach high temperatures during operation and doing so could result in serious burns.



- When you finish edging in one location and wish to continue work in another spot, turn off the engine, and turn the stick edger so that the blades face away from your body before carrying it to the new location.
- Never transport the stick edger over rough roads over long distances without first removing all fuel from the fuel tank, as doing so might cause fuel to leak from the tank as a result of shocks absorbed during transport.
- Never operate the stick edger without the blade guard in place.
- Do not use the stick edger for any job that is not recommended by the manufacturer.
- Should the stick edger start to vibrate abnormally, stop the engine immediately and check the blade and other parts for the cause.
- Avoid using the stick edger near rocks, gravel, stones and similar material that could be scattered and cause risk of injury or serious damage.
- Use the stick edger only in daylight or good artificial light.
- Do not use any accessory or attachment other than those bearing the RedMax mark and recommended for the unit.



Safety Precautions

■ NOTES ON CARE AND MAINTENANCE OF YOUR STICK EDGER

- In order to maintain your stick edger in proper working order, perform the maintenance and checking operations described in this manual at regular intervals. In the event that any parts must be replaced or any maintenance or repair work not described in this manual must be performed, please contact a representative from the store nearest RedMax authorized servicing dealer for assistance.
- Under no circumstances should you ever take apart the stick edger or alter it in any way. Doing so might result in the stick edger becoming damaged during operation or the stick edger becoming unable to operate properly.
- Always be sure to turn off the engine before performing any maintenance or checking procedures.
- When sharpening, removing, or reattaching the blades, be sure to wear thick, sturdy gloves and use only proper tools and equipment to prevent injury.
- When replacing blades or any other parts or when replacing the oil or any lubricants, always be sure to use only RedMax products or products which have been certified by RedMax for use with the RedMax stick edger.

Set up

1. Insert the shaft tube into the clutch housing, then align the positioning holes and screw in the lock screw. Tighten the clamp bolts.

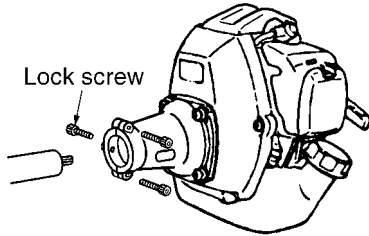

2. Insert the driveshaft into the clutch drum, then attach the gearbox to the shaft tube as aligning the positioning holes. Wipe out grease on the tube and the inside of the gearbox. Screw in the lock screw and fasten the clamp bolt firmly.

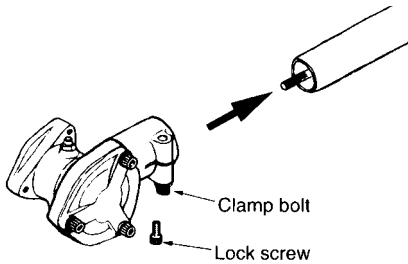

3. Install the blade guard to the gear case with the provided 3 screws, then clamp it to the shaft tube with 2 screws.

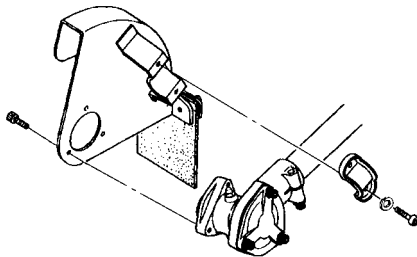

4. Place the blade between the cutter holders (A) and (B) while locking the gear shaft by putting the bar, one of the tools provided, through the key holes on the holder(A) and the gearcase. Use the socket and the screwdriver as shown in the picture below to tighten the blade mounting bolt.

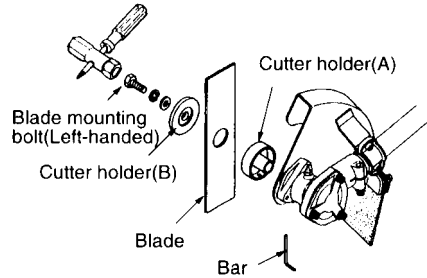

5. Split the bracket and install the wheel assembly to the shaft tube and clamp at a position best for your job.

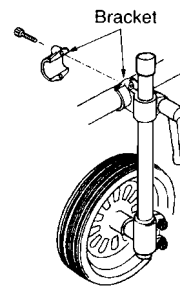

6. Install the J-shaped handle to the shaft tube and clamp at a position best for your job.

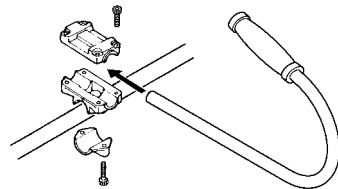

7. Open the air cleaner cover and connect the throttle cable to the carburetor. Put on the cap to the joint to secure the connection.

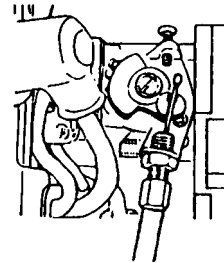

8. Connect the switch wires between the engine and the main unit. Pair the wires of the same color.

Fuel

⚠ WARNING

- **Gasoline is very flammable. Avoid smoking or bringing any flame or sparks near fuel. Make sure to stop the engine and allow it cool before refueling the unit. Select outdoor bare ground for fueling and move at least 3m(10ft) away from the fueling stop before starting the engine.**



- The RedMax engines are lubricated by oil specially formulated for air-cooled 2-cycle gasoline engine use. If RedMax oil is not available. Use an anti-oxidant added quality oil expressly labeled for air-cooled 2-cycle engine use.

RECOMMENDED MIXING RATIO GASOLINE 32:OIL 1

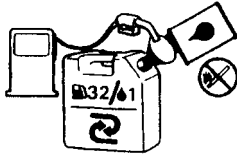

- **Exhaust emission are controlled by the fundamental engine parameters and components(eq., carburation, ignition timing and port timing) without addition of any major hardware or the introduction of an inert material during combustion.**

32:1 MIXING CHART

GASOLINE	gal.	1	2	3	4	5
2-CYCLE OIL	fl.oz	4	8	12	16	20

GASOLINE	liter	1	2	3	4	5
2-CYCLE OIL	ml	32	64	96	128	160

- These engines are certified to operate on unleaded gasoline.
- Make sure to use gasoline with a minimum octane number of 90 ROZ(USA/Canada : pump octane min.87)
- Unleaded gasoline is recommended to reduce the contamination of the air for the sake of your health and the environment.

- Poor quality gasolines or oils may damage sealing rings, fuel lines or fuel tank of the engine.

■ HOW TO MIX FUEL

1. Measure out the quantities of gasoline and oil to be mixed.
2. Put some of the gasoline into a clean, approved fuel container.
3. Pour in all of the oil and agitate well.
4. Pour in the rest of gasoline and agitate again for at least one minute.
5. Put a clear indication on the outside of the container to avoid mixing up with gasoline or other containers.
6. Indicate the contents on outside of container for easy identification.

■ FUELING THE UNIT

1. Untwist and remove the fuel cap. Rest the cap on a dustless place.
2. Put fuel into the fuel tank to 80% of the full capacity.
3. Fasten the fuel cap securely and wipe up any fuel spillage around the unit.

⚠ WARNING

1. Select bare ground for fueling.
2. Move at least 10 feet (3 meters) away from the fueling point before starting the engine.
3. Stop the engine before refueling the unit.

FOR YOUR ENGINE LIFE, AVOID;

1. **FUEL WITH NO OIL(RAW GASOLINE)** – It will cause severre damage to the internal engine parts very quickly.
2. **GASOHOL** – It can cause deterioration of rubber and/or plastic parts and disruption of engine lubrication.
3. **OIL FOR 4-CYCLE ENGINE USE or WATER COOLED 2-CYCLE ENGINE USE** – It can cause spark plug fouling, exhaust port blocking, or piston ring sticking.
4. **Mixed fuels which have been left unused for a period of one month or more** may clog the carburetor or result in the engine failing to operate properly.

Operation

The RedMax stick edger Model HE2601 is designed for edging lawn in gardens, parks, roadsides and so on.

Before starting the engine, take the operating position and adjust the handle position and the wheel height as necessary.

■ ADJUSTING HANDLE POSITION

- Loosen the handle bracket screws and reposition the handle to your best operating position. Re-tighten the screws.

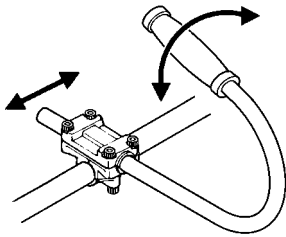

■ ADJUSTING WHEEL HEIGHT

- Loosen the clamp lever and change the wheel height to obtain desired cutting depth.

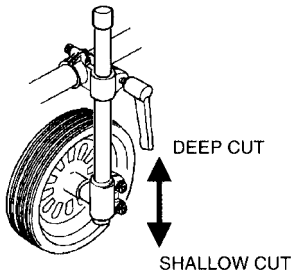

- Never adjust wheel height with the engine running.

■ STARTING ENGINE

1. Rest the unit on a flat, firm place. Keep the blade off the ground and clear of the surrounding as it will start rotating upon starting of the engine.
2. Pump the priming pump until fuel flows out in the clear tube.



3. Move the choke lever upward to close the choke.

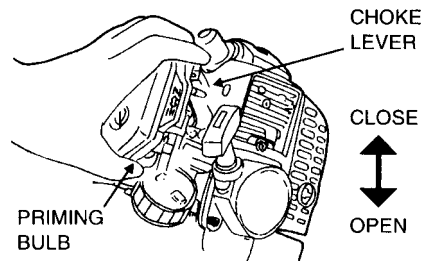

4. Set the ignition switch to the "start" position. While pulling the throttle lever, push the set button, and release the throttle, then the throttle lever is in to the "start" position.

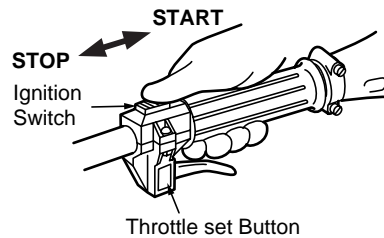

Operation

5. While pulling the throttle trigger with the little finger of your left hand, pull the starter rope.

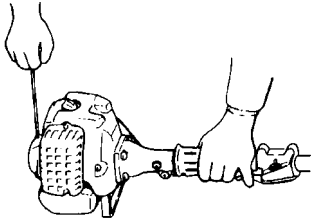

NOTE

- Avoid pulling the rope to its end or returning it by releasing the knob. Such actions can cause starter failures.
6. When the engine has started, move the choke lever gradually downward to open the choke.
 7. Allow the engine to warm up for a half minute before starting operation.

NOTE

1. When restarting the engine immediately after stopping it, leave the choke open.
2. Overchoking can make the engine hard to start due to excess fuel. When the engine failed to start after several attempts, open the choke and repeat pulling the rope, or remove the spark plug and dry it.

■ STOPPING ENGINE

1. Release the throttle trigger and run the engine for a half minute.
2. Shift the ignition switch to the STOP position.

NOTE

- Except for an emergency, avoid stopping the engine with the trigger pulled on.

■ ADJUSTING IDLING SPEED

1. When the engine tends to stop frequently at idling mode, turn the adjusting screw clock-wise.
2. When the cutting head keeps rotating after releasing the trigger, turn the adjusting screw counter-clockwise.

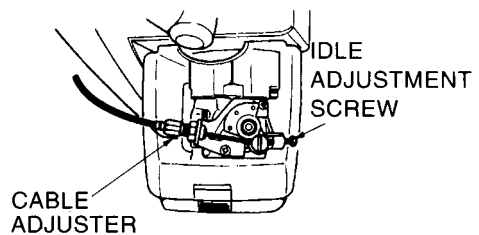

NOTE

1. After setting up the unit, check play of the throttle cable. The normal play is between .04" and .08" (1mm and 2mm).
2. Warm up the engine before adjusting the idling speed.

How to use

⚠ WARNING

1. Always wear eye protection such as safety goggles. Never lean over the rotating cutting head. Rocks or other debris could be thrown into eyes and face and cause serious personal injury.
2. Keep the blade guard and the mud guard attached in place at all times when the unit is operated.
3. Before starting a job, check the area and remove all obstacles and objects that could be thrown by the blade.
4. Do not adjust the wheel height or try to remove anything entangled to the blade with the engine running.

1. Before starting the engine, adjust the wheel height for desired cutting depth (See page 9).
2. Before starting a job, plan your direction of travel so that you can always hold the edger on your right side and can walk on a hard surface as much as possible.
3. When starting to edge, run the engine at full throttle, and slowly have the blade cut into the edge groove.

NOTE

- Do not use the HE2601 to make a new groove into the ground. Such usage will not be covered by RedMax Warranty.

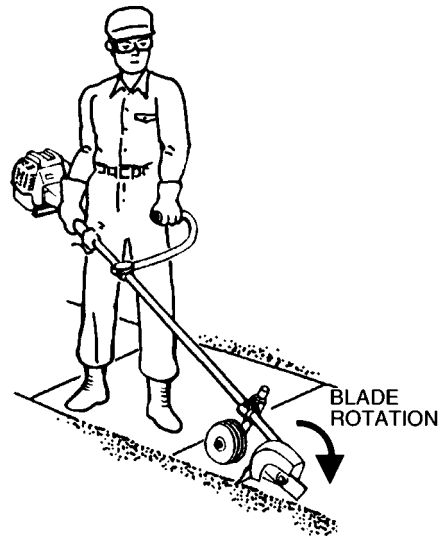

Maintenance

⚠ WARNING

- Always be sure to stop the engine before inspecting the stick edger for problems or performing maintenance.
- Never alter the stick edger or take the engine apart.
- When replacing parts, always be sure to use only RedMax products or products which have been certified by RedMax for use with the RedMax stick edger.
- Things to check before using stick edger

■ BE SURE TO CHECK THE FOLLOWING BEFORE USING YOUR STICK EDGER

Item to be checked			Response
1	Edging mechanism	<ul style="list-style-type: none"> • See if attachment is loose • Check if edges of blades are dull 	<ul style="list-style-type: none"> • Tighten screws and bolts • Sharpen or replace blades
2	Throttle	<ul style="list-style-type: none"> • Stiff and difficult to move 	<ul style="list-style-type: none"> • Repair or replace
3	Throttle wire	<ul style="list-style-type: none"> • Too loose, too tight • Stiff and difficult to move 	<ul style="list-style-type: none"> • Adjust • Repair or replace
4	Engine attachment	<ul style="list-style-type: none"> • See if fittings are loose 	<ul style="list-style-type: none"> • Tighten fittings
5	Fuel tank	<ul style="list-style-type: none"> • See if attachment is loose • See if fuel pipe is damaged • See if cap packing is damaged 	<ul style="list-style-type: none"> • Tighten screws and bolts • Replace • Replace
6	Muffler	<ul style="list-style-type: none"> • See if attachment is loose 	<ul style="list-style-type: none"> • Tighten screws and bolts

■ REGULAR MAINTENANCE INSPECTION

Check the stick edger for damage or problems at the intervals shown below.

Item to be checked	Interval (number of hours)				Comments
	20	25	50	100	
Engine					
Remove grit from cylinder fins		√			
Clean air filter element		√			
Clean and adjust spark plugs		√			distance of 0.25" (0.65mm)
Clean fuel tank			√		
Tighten cylinder bolts				√	
Tighten engine fittings				√	
Decarbonize muffler				√	
Main body					
Lubricate gear case	√				
Remove grit from clutch drums				√	

Maintenance

⚠ WARNING

- Make sure that the engine has stopped and is cool before performing any service to the stick edger. Contact with moving cutting head or hot muffler may result in a personal injury.

■ AIR FILTER

- The air filter, if clogged, will reduce the engine performance. Monthly check and clean the filter element in warm, soapy water as required. Dry completely before installing. If the element is broken or shrunk, replace with a new one.

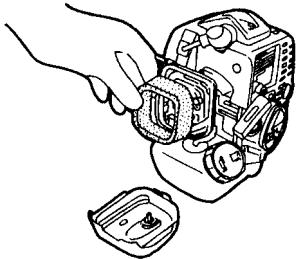

■ FUEL FILTER

- When the engine runs short of fuel supply, check the fuel cap and the fuel filter for blockage.

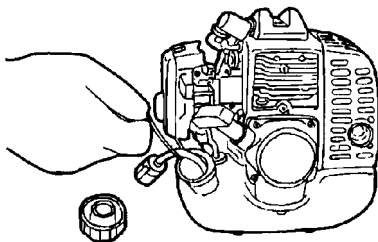

■ SPARK PLUG

- Starting failure and mis-firing are often caused by a fouled spark plug. Periodically clean the spark plug and check that the spark gap is in the correct range.

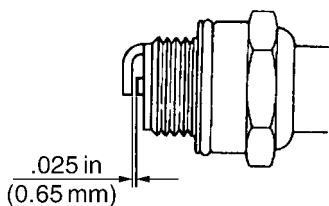

- REPLACEMENT PLUG IS A CHAMPION RCJ6Y OR THE EQUIVALENT, SUCH AS BOSCH WR8E OR NGK BR6S.

IMPORTANT

- Note that using any spark plugs other than those designated may result in the engine failing to operate properly or in the engine becoming overheated and damaged.
- To install the spark plug, first turn the plug until it is finger tight, then tighten it a quarter turn more with a socket wrench.

■ MUFFLER

⚠ WARNING

- Inspect periodically, the muffler for loose fasteners, any damage or corrosion. If any sign of exhaust leakage is found, do not use the stick edger and have it repaired immediately.
- Note that failing to do so may result in the engine catching on fire.

■ SPARK ARRESTER

- The muffler is equipped with a spark arrester to prevent red hot carbon from flying out of the exhaust outlet. Periodically inspect and clean as necessary with a wire brush. In the State of California it is required by law (Section 4442 of the California Public Resources Code) to equip a spark arrester when a gas powered tool is used in any forest covered, brush covered, or grass covered unimproved land.

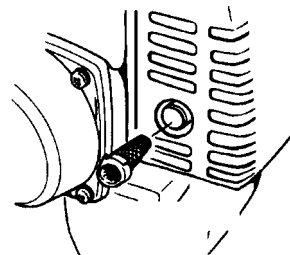

Maintenance

■ GEAR CASE

- The reduction gears are lubricated by multipurpose, lithium-based grease in the gear case. At every 20 hours of use, supply the gear case with new grease.

Remove the cutter holders before installing new grease to arrange for old grease to exit.

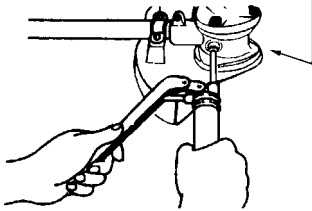

NOTE

- When removing and installing the cutter holder(a), use care not to allow any dirt and dust entering in to the gear case.

■ INTAKE AIR COOLING VENT

⚠ WARNING

- **Never touch the cylinder, muffler, or spark plugs with your bare hands immediately after stopping the engine. The engine can become very hot when in operation, and doing so could result in severe burns.**
- **When checking the stick edger to make sure that it is okay before using it, check the area around the muffler and remove any wood chips or leaves which have attached themselves to the stick edger. Note that failing to do so could cause the muffler to become overheated, and that this in turn could cause the stick edger to catch on fire. Always make sure that the muffler is clean and free of wood chips, leaves, and other waste before use.**
- Check the intake air cooling vent and the area around the cylinder cooling fins after

every 25 hours of use for blockage, and remove any waste which has attached itself to the stick edger. Note that it is necessary to remove the plug guard shown in the picture below in order to be able to view the upper part of the cylinder.

IMPORTANT

- If waste gets stuck and causes blockage around the intake air cooling vent or between the cylinder fins, it may cause the engine to overheat, and that in turn may cause mechanical failure on the part of the stick edger.

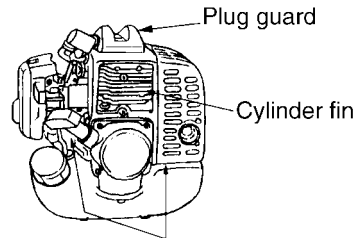

Intake air cooling vent (back)

■ PROCEDURES TO BE PERFORMED AFTER EVERY 100 HOURS OF USE

1. Remove the muffler, insert a screwdriver into the vent, and wipe away any carbon buildup. Wipe away any carbon buildup on the muffler exhaust vent at the same time.

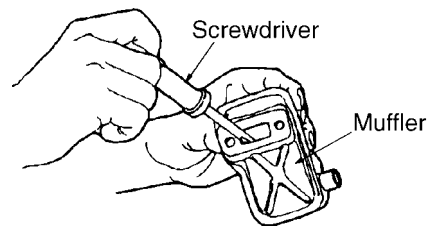

2. Tighten all screws, bolts, and fittings.
3. Check to see if any oil or grease has worked its way in between the clutch lining and drum, and if it has wipe it away using oil-free, lead-free gasoline.

Storage

Old fuel left in the carburetor may cause starting failure. Before storing the unit, empty the fuel tank and drain the carburetor with the priming pump equipped on it.

Specifications

Model..... RedMax stick edger HE2601
Overall size(LxWxH)..... 72.4x18.1x15.1(in) / 1.8x0.4x0.3(m)
Dry weight..... 14.5(lbs) / 7.2(kg)
Engine Type..... Air-cooled 2-stroke gasoline
 Model Zenoah G26L
 Displacement 25.4(cc)
 Max. output..... 1.3(HP)at 7500rpm
 Fuel Mixture(Gasoline 32:Oil 1)
 Carburetor Walbro Diaphragm type
 Spark plug Champion RCJ6Y
Fuel tank capacity 25.3(fl.oz) / 0.7(ℓ)
Transmission..... Centrifugal clutch, Rigid driveshaft, Bevel gears(Angle:90 deg.)
Reduction ratio..... 2.538(33.13)
Cutting head rotating direction Clockwise(View against blade)
Blade length..... 7.87(in) / 200(mm)
Use for Lawn edging

Specifications are subject to change without notice.

STICK EDGERS

HE2601

NOTE :

1. Use KOMATSU ZENOAH genuine parts as specified in the parts list for repair and/or replacement.
2. KOMATSU ZENOAH does not warrant the machines, which have been damaged by the use of any parts other than those specified by the company.
3. When placing parts orders for repair and/or replacement, check if the model name and the serial number are applicable to those specified in the parts list, then use parts number described in the parts list.
4. The contents described in the parts list may change due to improvement.
5. The parts for the machine shall be supplied seven (7) years after the machine is discontinued. [It is possible that some specific parts may be subject to change of their delivery term and list price within the limit of ten (7) years after the machine is discontinued. It is also possible that some parts may be available even after the limit of seven (7) years.]

APPLICABLE SERIAL NUMBERS :

NOV. 1999

DRIVE UNIT 000000 and up

ENGINE UNIT 900101 and up

Parts List

Fig.1 DRIVE UNIT HE2601 (S/N 000000 and up)

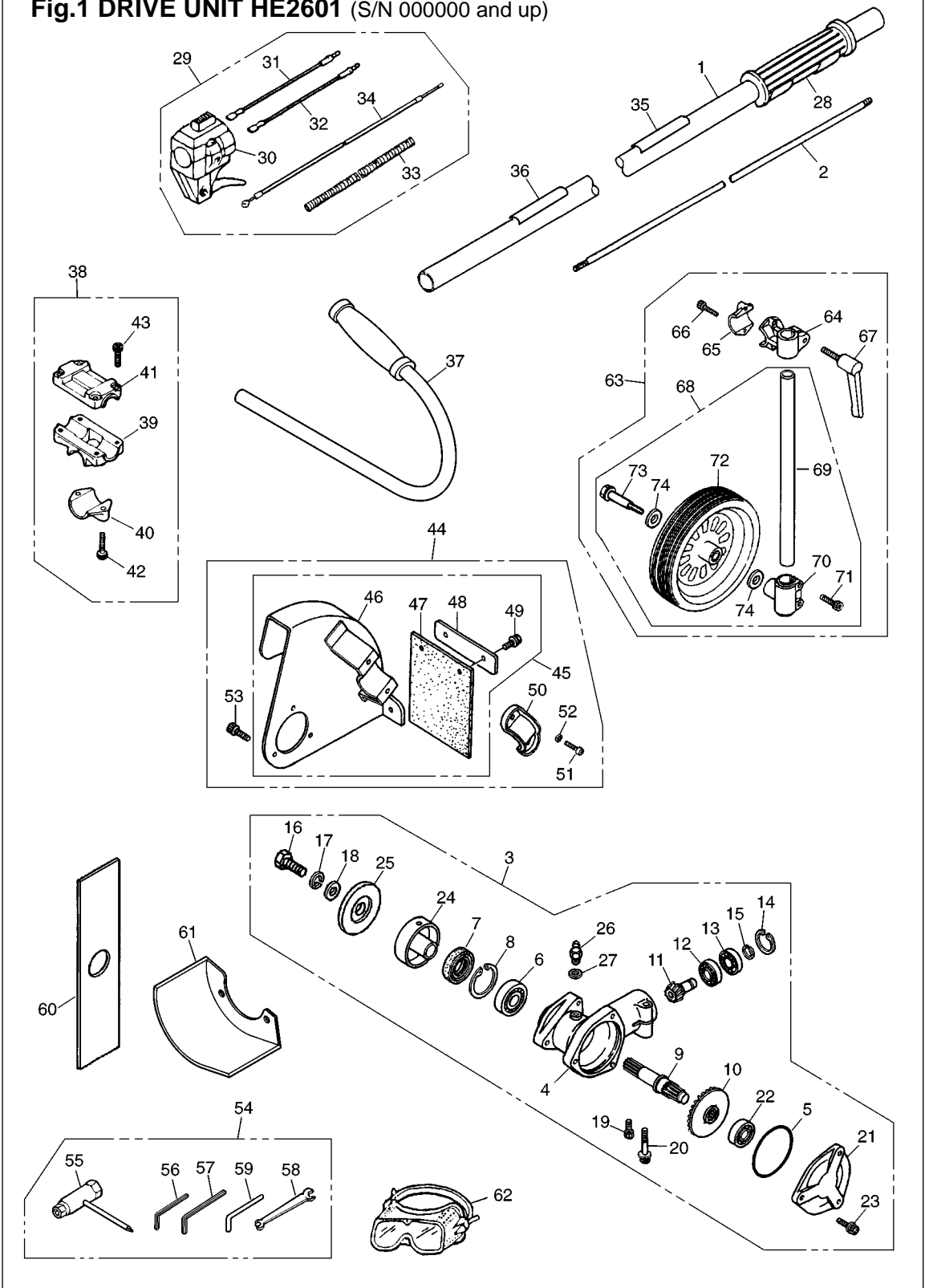

Fig.1 DRIVE UNIT HE2601 (S/N 00000 and up)

Key#	Description	Part Number	Q'ty	Key#	Description	Part Number	Q'ty
1	PIPE-COMP	T3052-12100	1	51	• BOLT	01252-30618	2
2	SHAFT	3520-12212	1	52	• WASHER	0290-20615	2
3	GEARCASE-ASS'Y	6367-13000	1	53	• BOLT	3350-31470	3
4	• GEARCASE	6367-13110	1	54	TOOL-SET	T3052-91000	1
5	• O-RING	6367-13150	1	55	• SOCKET	T3051-91310	1
6	• BEARING	06000-06201	1	56	• WRENCH	09007-00425	1
7	• SEAL	3180-13141	1	57	• WRENCH	09007-00528	1
8	• RING	04065-03212	1	58	• SPANNER	3540-91120	1
9	• SHAFT	3541-13212	1	59	• BAR	3540-91110	1
10	• GEAR	6367-13130	1	60	BLADE	6367-15110	1
11	• PINION	6367-13140	1	61	COVER	T3052-13610	1
12	• BEARING	06000-00609	1	62	GOGGLE	T3002-91190	1
13	• BEARING	06001-00609	1	63	WHEEL-ASS'Y	T3052-25000	1
14	• RING	04065-02412	1	64	• BRACKET	6367-15230	1
15	• RING	3210-13330	1	65	• CAP-L	3583-14121	1
16	• BOLT	3579-33260	1	66	• BOLT	01252-30522	2
17	• WASHER	3310-43210	1	67	• LEVER	3956-15340	1
18	• WASHER	01643-30823	1	68	• WHEEL-S-ASS'Y	T3052-25100	1
19	• BOLT	01252-30512	1	69	•• PIPE	6367-15210	1
20	• BOLT	3540-13260	1	70	•• BRACKET	3808-15230	1
21	• COVER	6367-13120	1	71	•• BOLT	01252-30625	2
22	• BEARING	06000-06000	1	72	•• WHEEL	6367-25150	1
23	• BOLT	3350-31470	3	73	•• BOLT	01010-81060	1
24	• HOLDER (A)	3541-13241	1	74	•• WASHER	01642-21016	2
25	• HOLDER (B)	3541-13251	1				
26	• FITTING	3199-13350	1				
27	• WASHER	01641-20608	1				
28	GRIP	3577-32141	1				
29	LEVER-COMP	T3002-12200	1				
30	• LEVER	6110-14410	1				
31	• CORD (A)	T3002-12220	1				
32	• CORD (B)	T3002-12230	1				
33	• TUBE	T3002-12240	1				
34	• CABLE-COMP	T3002-83100	1				
35	NAME-PLATE	T3052-12510	1				
36	CAUTION-PLATE	6425-12552	1				
37	HANDLE-COMP	6367-14200	1				
38	BRACKET-ASS'Y	3583-14101	1				
39	• BRACKET	3583-14111	1				
40	• CAP-L	3583-14121	1				
41	• CAP-U	3257-14192	1				
42	• BOLT	01252-30522	2				
43	• BOLT	01252-30525	4				
44	GUARD-ASS'Y	6367-24000	1				
45	• GUARD-COMP	6367-24100	1				
46	•• GUARD	6367-24110	1				
47	•• PLATE	6367-24120	1				
48	•• PLATE	6367-24131	1				
49	•• BOLT	0225-30512	2				
50	• CLAMP	5807-24120	1				

Parts List

Fig.2 ENGINE UNIT HE2601 (S/N 900101 and up)

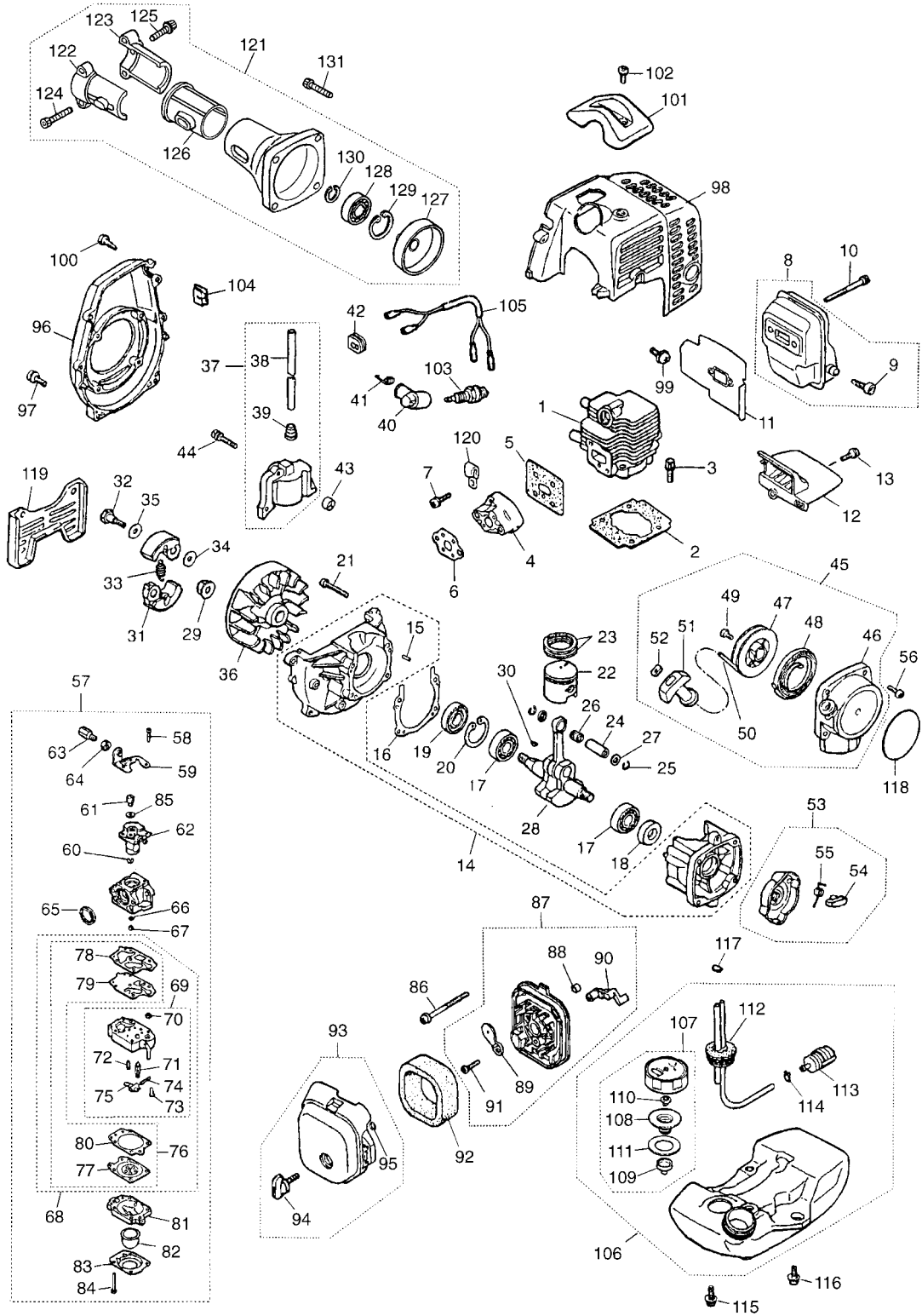

Fig.2 ENGINE UNIT HE2601 (S/N 900101 and up)

Key#	Description	Part Number	Q'ty	Key#	Description	Part Number	Q'ty
1	CYLINDER	5911-12110	1	67	• JET	5500-81251	1
2	GASKET, base	5500-12212	1	68	• Rebuilt Kit	5602-06030	1
3	BOLT	1850-12130	2	69	•• Body ASS'Y	1850-81450	1
4	INSULATOR	1920-13162	1	70	••• Screen	_____	—
5	GASKET, insulator	5500-13121	1	71	••• Valve	_____	—
6	GASKET, carburetor	5500-13131	1	72	••• Spring	_____	—
7	SCREW	0263-90520	2	73	••• Screw	_____	—
8	MUFFLER ASS'Y	5850-15100	1	74	••• Pin	_____	—
9	• ARRESTER	1601-15120	1	75	••• Lever	_____	—
10	BOLT	01252-30550	2	76	•• Gasket kit	5602-06020	1
11	GASKET, muffler	5910-15211	1	77	••• Washer	_____	—
12	PLATE, muffler	5500-15220	1	78	••• Gasket, pump	_____	—
13	SCREW	0263-90416	1	79	••• Diaphragm, pump	_____	—
14	CRANKCASE COMP.	5500-21100	1	80	••• Gasket, diaphragm	_____	—
15	• PIN	2629-21130	3	81	• BODY, purge	1850-81490	1
16	GASKET, case	5500-21141	1	82	• PUMP, priming	1751-81510	1
17	BEARING	06030-06001	2	83	• COVER, pump	1850-81520	1
18	OIL SEAL	2169-21210	1	84	• SCREW	1850-81530	4
19	OIL SEAL	1850-21220	1	85	• WASHER	5500-81160	1
20	SNAP RING	04065-02812	1	86	SCREW	0263-30555	2
21	SCREW	01252-30530	4	87	BODY ASS'Y	5500-82102	1
22	PISTON	5910-41110	1	88	• SLEEVE	1970-82190	2
23	RING	5910-41210	2	89	• PLATE, choke	5500-82131	1
24	PIN	1600-41310	1	90	• LEVER, choke	5500-82140	1
25	SNAP RING	1260-41320	2	91	• SCREW	2630-33610	1
26	BEARING	1140-41330	1	92	ELEMENT	5500-82171	1
27	WASHER	1101-41340	2	93	COVER ASS'Y	5600-82202	1
28	CRANKSHAFT COMP.	5500-42001	1	94	• KNOB	5500-82221	1
29	NUT	1650-43230	1	95	• RING	5500-82230	1
30	KEY	1000-43240	1	96	COVER, fan	5501-31111	1
31	SHOE, clutch	1140-51111	2	97	SCREW	0263-90520	4
32	SCREW	1140-51250	2	98	COVER, engine	5580-32112	1
33	SPRING	1970-51221	1	99	SCREW	1850-32160	1
34	WASHER	1140-51230	2	100	SCREW	1900-31410	2
35	WASHER	1970-51241	2	101	GUARD, plug	5500-32210	1
36	ROTOR	5501-71110	1	102	SCREW	0263-90514	1
37	COIL ASS'Y	5501-71201	1	103	SPARKPLUG	5602-73110	1
38	• CORD	5500-71220	1	104	GROMMET	1852-72121	1
39	• CAP	2616-71320	1	105	CORD COMP.	5500-73201	1
40	CAP, plug	1900-72111	1	106	TANK ASS'Y	5911-85002	1
41	SPRING	1900-72120	1	107	• CAP ASS'Y	5601-85200	1
42	GROMMET	5500-72130	1	108	•• HOLDER	5601-85230	1
43	SPACER	1260-71261	2	109	•• CAP, holder	5600-85240	1
44	BOLT	3310-72150	2	110	•• VALVE	5600-85250	1
45	RECOIL ASS'Y	5500-75100	1	111	•• PACKING	5500-85220	1
46	• CASE COMP.	5500-75110	1	112	• PIPE COMP.	5911-85300	1
47	• REEL	1850-75120	1	113	• FILTER ASS'Y	5500-85400	1
48	• SPRING, spiral	1850-75130	1	114	• CLIP	1260-85460	1
49	• SCREW	1850-75151	1	115	SCREW	5500-85510	2
50	• ROPE	1850-75160	1	116	SCREW	5910-85510	1
51	• KNOB	1140-75320	1	117	CLIP	1950-86120	1
52	• PLATE, stopper	5500-75170	1	118	LABEL	T1078-91120	1
53	PULLEY ASS'Y	1850-75201	1	119	STAND	1897-31911	1
54	• RATCHET	1850-75221	1	120	CLAMP	1140-72231	1
55	• SPRING	1850-75230	1	121	HOUSING-ASS'Y	T3051-11000	1
56	SCREW	0263-90416	4	122	• BRACKET(A)	6470-31211	1
57	CARBURETOR ASS'Y	5911-81000	1	123	• BRACKET(B)	6470-31221	1
58	• SCREW	1752-81110	2	124	• BOLT	01252-30530	2
59	• BRACKET	5500-81120	1	125	• BOLT	01252-31514	1
60	• RING	1751-81130	1	126	• CUSHION	6470-31230	1
61	• SWIVEL	1881-81140	1	127	• DRUM	6460-12111	1
62	• VALVE ASS'Y	_____	1	128	• BEARING	06004-06001	1
63	• SCREW, adjuster	1918-81170	1	129	• SNAPRING	04065-02812	1
64	• NUT, adjuster	1751-81180	1	130	• SNAPRING	04064-01210	1
65	• RING	1881-81130	1	131	BOLT	6468-91150	4
66	• O-RING	1751-81240	1				

CALIFORNIA EMISSION CONTROL WARRANTY STATEMENT
YOUR WARRANTY RIGHTS AND OBLIGATIONS

The California Air Resources Board and KOMATSU ZENOAH are pleased to explain the **emission control system warranty** on your **1995 and later** small off-road engine. In California, new small off-road engines must be designed, built and equipped to meet the state's stringent anti-smog standards. KOMATSU ZENOAH must warrant the emission control system on your small off-road engine for the periods of time listed below provided there has been no abuse, neglect or improper maintenance of your small off-road engine.

Your emission control system may include parts such as the carburetor and the ignition system.

Where a warrantable condition exists, KOMATSU ZENOAH will repair your small off-road engine at no cost to you including diagnosis, parts and labor.

Manufacturer's warranty coverage:

The 1995 and later small off-road engines are warranted for **two years**. If any emission-related part on your engine is defective, the part will be repaired or replaced by KOMATSU ZENOAH.

Owner's warranty responsibilities:

– As the small off-road engine owner, you are responsible for the performance of the **required maintenance listed in your owner's manual**. KOMATSU ZENOAH recommends that you retain all receipts covering maintenance on your small off-road engine, but KOMATSU ZENOAH can not deny warranty solely for the lack of receipts or for your failure to ensure the performance of all scheduled maintenance.

– As the small off-road engine owner, you should be aware, however, that KOMATSU ZENOAH may deny you warranty coverage if your small off-road engine or a part has failed due to abuse, neglect, improper maintenance or unapproved modification.

– You are responsible for presenting your small off-road engine to a KOMATSU ZENOAH distribution center as soon as a problem exists. The warranty repairs should be completed in a reasonable amount of time, not to exceed **30 days**.

If you have any questions regarding your warranty rights and responsibilities, you should contact KOMATSU ZENOAH AMERICA INC. at (770)-381-5147 or you can write to

KOMATSU ZENOAH AMERICA INC.
4344 Shackelford Road Suite 500
Norcross, Georgia 30093

**Red Max STICK EDGER
MODEL HE2601
2-YEAR LIMITED WARRANTY**

EMISSION-RELATED PARTS, FOR TWO (2) YEARS FROM THE DATE OF ORIGINAL DELIVERY OF THE MODEL HE2601, UNIT, KOMATSU ZENOAH AMERICA INC. (THE COMPANY), THROUGH ANY RedMax DEALER, WILL REPAIR OR REPLACE, FREE OF CHARGE, FOR THE ORIGINAL AND EACH SUBSEQUENT PURCHASER, ANY PART OR PARTS FOUND TO BE DEFECTIVE IN MATERIAL AND/OR WORKMANSHIP. EMISSION-RELATED PARTS ARE:

**THE CARBURETOR ASSY, COIL ASSY, ROTOR, SPARKPLUG,
AIR FILTER, FUEL FILTER, INTAKE MANIFOLD, AND THE GASKETS**

ALL OTHER PARTS EXCEPT ABOVE PARTS, FOR TWO (2) YEARS OF HOME USE [ONE (1) YEAR FOR ANY OTHER USE] FROM THE DATE OF ORIGINAL ANY DELIVERY OF THE MODEL HE2601 UNIT, THE COMPANY, THROUGH ANY RedMax DEALER, WILL REPAIR OR REPLACE, FREE OF CHARGE, FOR THE ORIGINAL PURCHASER, ANY PART OF PARTS FOUND TO BE DEFECTIVE IN MATERIAL AND/OR WORKMANSHIP. **THIS IS THE EXCLUSIVE REMEDY.**

THE PURCHASER SHALL BEAR COSTS OF TRANSPORTING THE UNIT TO AND FROM THE RedMax DEALER.

THE PURCHASER SHALL NOT BE CHARGED FOR DIAGNOSTIC LABOR WHICH LEADS TO THE DETERMINATION THAT A WARRANTED PART IS DEFECTIVE, IF THE DIAGNOSTIC WORK IS PERFORMED AT THE RedMax DEALER.

THE PURCHASER OR OWNER IS RESPONSIBLE FOR THE PERFORMANCE OF THE REQUIRED MAINTENANCE AS DEFINED BY THE MANUFACTURER IN THE OWNER/OPERATOR MANUAL.

ANY WARRANTED PART WHICH IS NOT SCHEDULED FOR REPLACEMENT AS REQUIRED MAINTENANCE, OR WHICH IS SCHEDULED ONLY FOR REGULAR INSPECTION TO THE EFFECT OF "REPAIR OR REPLACE AS NECESSARY" SHALL BE WARRANTED FOR THE WARRANTY PERIOD. ANY WARRANTED PART WHICH IS TIME UP TO THE FIRST SCHEDULED REPLACEMENT POINT FOR THE PART.

ANY REPLACEMENT PART THAT IS EQUIVALENT IN PERFORMANCE AND DURABILITY MAY BE USED IN NON-WARRANTY MAINTENANCE OR REPAIRS, AND SHALL NOT REDUCE THE WARRANTY OBLIGATION OF THE COMPANY.

THE COMPANY IS LIABLE FOR DAMAGES TO OTHER ENGINE COMPONENTS CAUSED BY THE FAILURE OF A WARRANTED PARTS STILL UNDER WARRANTY.

THE WARRANTY DOES NOT APPLY TO THOSE UNITS WHICH HAVE BEEN DAMAGED BY NEGLIGENCE OF INSTRUCTION LISTED IN THE OWNER/OPERATOR MANUAL FOR PROPER USE AND MAINTENANCE OF THE UNITS, ACCIDENT MISHANDLING, ALTERATION, ABUSE, IMPROPER LUBRICATION, USE OF ANY PARTS OR ACCESSORIES OTHER THAN THOSE SPECIFIED BY THE COMPANY, OR OTHER CAUSES BEYOND THE COMPANY'S CONTROL.

THIS WARRANTY DOES NOT COVER THOSE PARTS REPLACED BY NORMAL WEAR OR HARMLESS CHANGES IN THEIR APPEARANCE.

THERE ARE NO OTHER EXPRESS WARRANTIES.

IMPLIED WARRANTIES INCLUDING THOSE OF MERCHANTABILITY AND FITNESS FOR A PARTICULAR PURPOSE **ARE LIMITED** TO TWO (2) YEARS OF HOME USE [ONE (1) YEAR FOR ANY OTHER USE] FROM THE ORIGINAL DELIVERY DATE.

LIABILITIES FOR INCIDENTAL OR CONSEQUENTIAL DAMAGE UNDER ANY AND ALL WARRANTIES ARE EXCLUDED.

SOME STATES DO NOT ALLOW LIMITATION ON HOW LONG AN IMPLIED WARRANTY LASTS OR EXCLUSION OR LIMITATION OF INCIDENTAL OR CONSEQUENTIAL DAMAGES, SO THE ABOVE LIMITATION OR EXCLUSION MAY NOT APPLY TO YOU.

THIS WARRANTY GIVES YOU SPECIFIC LEGAL RIGHTS, AND YOU MAY ALSO HAVE OTHER RIGHTS WHICH VARY FROM STATE TO STATE.

IF YOU NEED TO OBTAIN INFORMATION ABOUT THE NEAREST SERVICE CENTER, PLEASE CALL KOMATSU ZENOAH AMERICA INC. AT (770)-381-5147.

IMPORTANT: YOU WILL RECEIVE A WARRANTY REGISTRATION CARD AT TIME OF PURCHASE. PLEASE FILL OUT THE CARD AND SEND IT TO RedMax / KOMATSU ZENOAH AMERICA WITHIN SEVEN (7) DAYS. BE SURE TO KEEP A COPY FOR YOUR RECORDS.



RedMax[®]

KOMATSU ZENOAH AMERICA INC.
4344 Shackelford Road Suite 500
Norcross, Georgia 30093



KOMATSU ZENOAH AMERICA INC.
4344 Shackleford Road Suite 500
Norcross, Georgia 30093