

DAEWOO

ELECTRONICS

HELPLINE NUMBER : 01189 252577

With your query, please quote the page number, reference number and model number

DSC-3210EGB

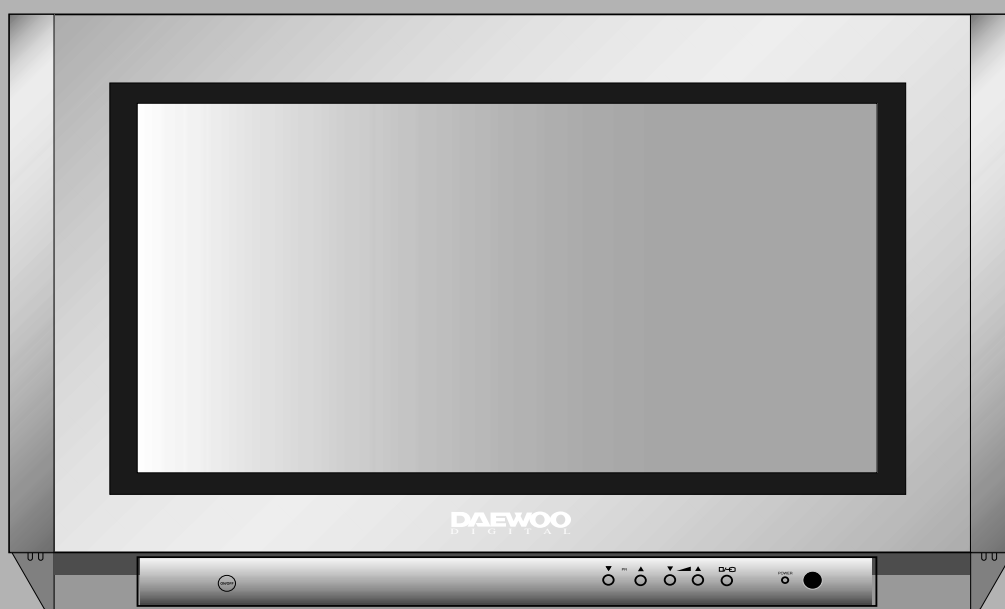

SET-UP MANUAL

Colour Television

ADDITIONAL INFORMATION FOR TV'S SOLD IN GREAT BRITAIN

The appliance is supplied with a moulded three pin mains plug fitted with 5Amp fuse. Should the fuse require replacement, it must be replaced with a fuse rated at 5 amp and approved by ASTA or BSI to BS1362.

The plug contains a removable fuse cover that must be refitted when the fuse is replaced. In the event of the fuse cover being lost or damaged, the plug must not be used until a replacement cover has been obtained. Replacement fuse covers can be purchased from your nearest electrical dealer and must be the same colour as the original.

If the moulded mains plug is unsuitable for the socket outlet in your home or is removed for any other reasons, then the fuse should be removed and the cut off plug disposed of safely to prevent the hazard of electric shock.

There is a danger of electric shock if the cut off plug is inserted into any socket outlet. If a replacement plug is to be fitted, please observe the wiring code shown below. The wires in the mains lead are coloured in the accordance with the following code:

Blue-neutral









Brown-live

As the colours of the wires in the mains lead of this appliance may not correspond with the coloured markings identifying the terminals in your plug, proceed as follows:

The wire which is coloured blue must be connected to the terminal which is marked with the letter N or coloured black. The wire which is coloured brown must be connected to the terminal which is marked with the letter L or coloured red.

Do not make any connections to the terminal in the plug which is marked by the letter E by the safety earth symbol or coloured green or green and yellow.

CONTENT

	REMOTE CONTROL & TV CONNECTIONS.....	3
	IMPORTANT SAFEGUARDS.....	4
	INSTALLATION.....	4
	START UP.....	5
	CONNECTING EXTERNAL EQUIPMENT.....	5
	DAILY USE.....	6
	MENUS DESCRIPTION.....	8
	TELETEXT.....	11



REMOTE CONTROL & TV CONNECTIONS

LOCAL CONTROL

Front

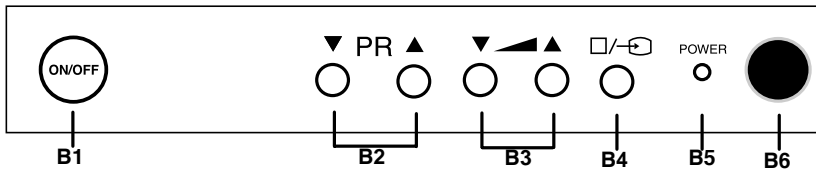

Side

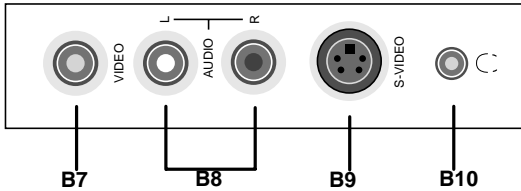

- | | | | |
|-----------|-------------------------|------------|----------------------------|
| B1 | MAIN POWER button | B6 | REMOTE sensor |
| B2 | PROGRAM UP/DOWN buttons | B7 | VIDEO INPUT socket |
| B3 | VOLUME UP/DOWN buttons | B8 | AUDIO INPUT (L + R) socket |
| B4 | TV / AV button | B9 | PANEL S-VIDEO jack |
| B5 | STAND-BY indicator | B10 | HEADPHONE socket |

Rear

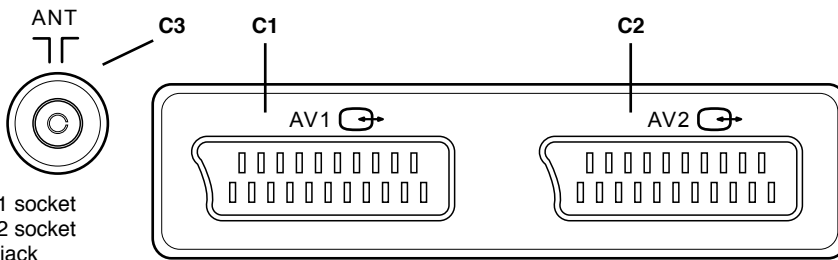

- | | |
|-----------|----------------|
| C1 | SCART 1 socket |
| C2 | SCART 2 socket |
| C3 | AERIAL jack |

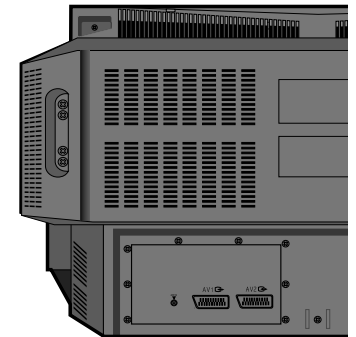
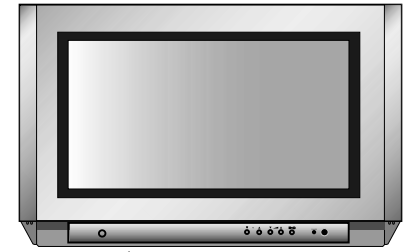

REMOTE CONTROL UNIT

TV mode

- | | |
|------------|----------------------------|
| A1 | POWER |
| A2 | SOUND MUTE |
| A3 | NUMBER 0..9 |
| A4 | SLEEP |
| A5 | TV / AV |
| A6 | PROGRAM UP (CURSOR UP) |
| A7 | VOLUME DOWN (CURSOR LEFT) |
| A8 | . |
| A9 | . |
| A10 | . |
| A11 | SKIP |
| A12 | MOVE |
| A13 | 3D(SOUND EFFECT) |
| A14 | MODE |
| A15 | ZOOM |
| A16 | RECALL |
| A17 | NORMAL |
| A18 | OK |
| A19 | MENU |
| A20 | VOLUME UP (CURSOR RIGHT) |
| A21 | PROGRAM DOWN (CURSOR DOWN) |
| A22 | TV > TELETEXT |
| A23 | . |
| A24 | . |
| A25 | . |
| A26 | DELETE |

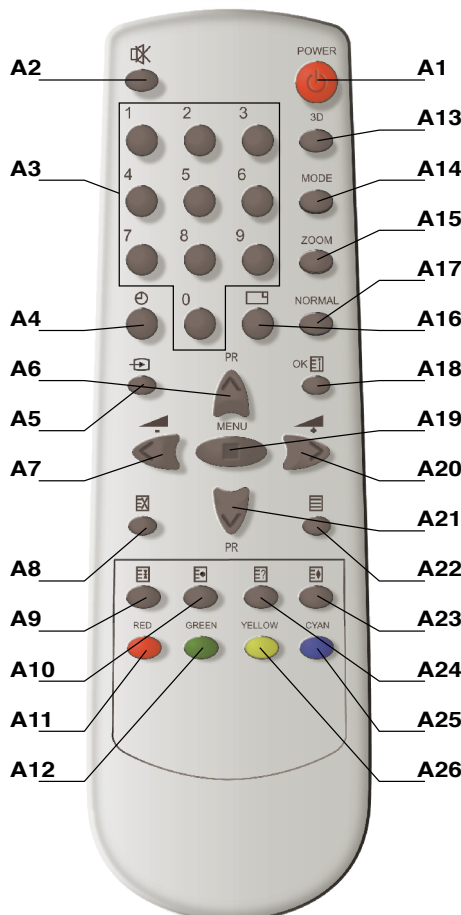

TELETEXT mode

- | | |
|------------|--------------------------|
| A1 | POWER |
| A2 | SOUND MUTE |
| A3 | NUMBER 0..9 |
| A4 | . |
| A5 | . |
| A6 | PAGE UP |
| A7 | VOLUME DOWN BRIGHT. DOWN |
| A8 | CANCEL |
| A9 | PAGE HOLD |
| A10 | SUBPAGE |
| A11 | RED |
| A12 | GREEN |
| A13 | . |
| A14 | . |
| A15 | . |
| A16 | . |
| A17 | . |
| A18 | INDEX |
| A19 | MENU |
| A20 | VOL./ BRIGHT. SELECTION |
| A21 | VOLUME UP BRIGHT. UP |
| A22 | PAGE DOWN |
| A23 | TELETEXT > TV |
| A24 | HEIGHT |
| A25 | REVEAL |
| A26 | CYAN |
| A27 | YELLOW |



IMPORTANT SAFEGUARDS



WATER AND MOISTURE

Never install the set in the following places: In a wet basement, bathroom. Do not place any container with liquid on the set. Do not expose the set to dripping or splashing water.



HEAT

Never place the set near heat sources. Never put a naked flame, such as a candle, on the top of TV set.



VENTILATION

Do not cover the ventilations openings in the cabinet and never place the set in a confined space such as in a bookcase or built-in cabinet unless proper ventilation is provided. Leave a minimum 10 cm gap all around the unit.



OBJECT ENTRY

Do not insert foreign objects, such as needles and coins, in the ventilation openings.



LIGHTNING STRIKING

You should disconnect the set from the mains and the aerial system during thunderstorms.



CLEANING

Unplug the set from the mains while cleaning.



AFTER MOVING THE SET

If the set is moved or turned, the MAIN POWER button must be switched off for at least 15 minutes in order to take out colour patches on the screen.



INSTALLATION

Batteries

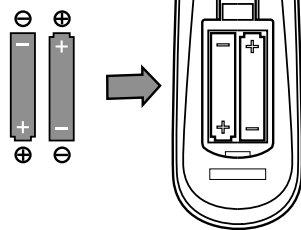

Open remote control battery compartment (at the rear) and insert two 1.5V type AAA batteries. Warning: be careful to respect battery polarities.

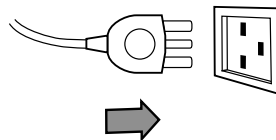

Insert the main plug into a 230V 50Hz AC power socket.

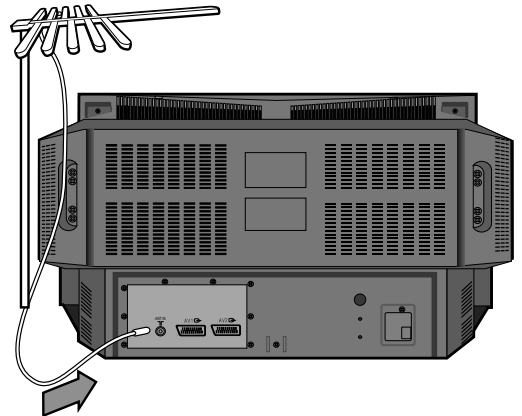

Connect aerial to aerial jack (C3).

SWITCHING ON AND OFF



Power on the TV set using front panel MAIN POWER button (B1). Select your preferred language from the LANGUAGE menu (see section START UP on page 5). Press the remote control MENU button (A19) to enter the main menu. Select Install menu to tune and memorise TV programs.





START UP

LANGUAGE MENU

The very first time that you turn on the TV, the LANGUAGE menu will appear on the screen. Its purpose is to enable you to select the language that will be used for all the OSD (On Screen Display) menus. The user must enter a choice of language before proceeding further.

The language entered at this stage can still be modified at any later time, by entering the FEATURES menu (see later section under MENU DESCRIPTION).

The descriptions used in the menu are those of the country code (e.g. GB = English, RUS = Russian etc).

LANGUAGE				
CZ	D	DK	E	F
FIN	GB	GR	H	I
N	NL	PL	RO	RUS
S	SK			

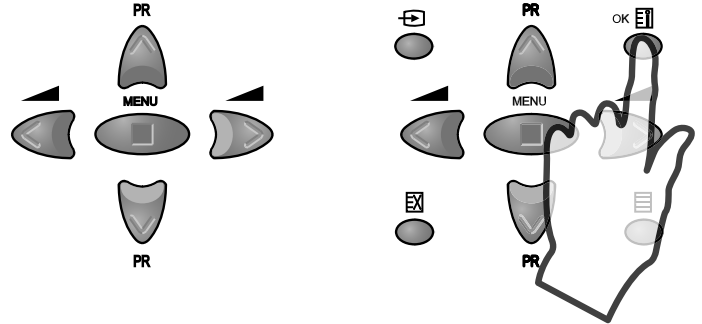

Selection is made by use of the remote control CURSOR UP (A6) / CURSOR DOWN (A21) keys and CURSOR RIGHT (A20) / LEFT (A7) keys.

Once you are satisfied with your selection, push the OK button (A18) to confirm your choice, after which the menu will disappear. The menu will never appear again.



CONNECTING EXTERNAL EQUIPMENT

The rear Scart 1 (C1), Scart 2 (C2) sockets and the side AV socket (B7) (B8) are three dedicated sockets to connect audio-video equipment.

Rear

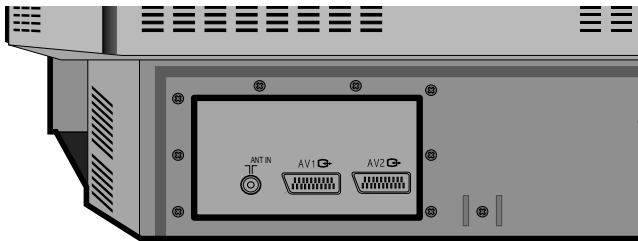

REAR SCART 1 SOCKET (AV1)

This socket (C1) has video / audio inputs and outputs. It is recommended to connect to this socket automatic AV switching equipment such as pay-TV decoders, video games, DVD players and most VCR's. In most cases, when connecting powered equipment to this socket, the TV set switches automatically to AV mode. If not, then use the TV/AV buttons (A5) or (B4) to select AV1.

REAR SCART 2 SOCKET (AV2)

This socket (C2) has video / audio inputs and outputs. Automatic AV switching equipment (for example most VCR's) can be connected to this socket. In most cases, when connecting powered equipment to this socket, the TV set switches automatically to AV mode. If not, then use the TV/AV buttons (A5) or (B4) to select AV2. You can also receive an S-VHS signal with REAR SCART2 socket, by selecting SVHS2 with the TV / AV buttons (A5) or (B4).

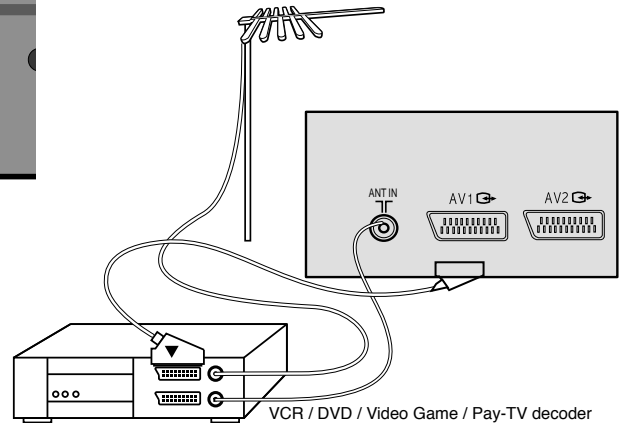

Important: If your video equipment does not have SCART socket(s), or if you wish to use only the aerial (RF) connection (not recommended), then you should make use of PR 00 on the TV set for best performance.

HEADPHONE SOCKET

To hear TV sound with headphones, insert a 3.5mm headphone plug into the headphone socket (B10). The speaker's sound will be automatically cut off.

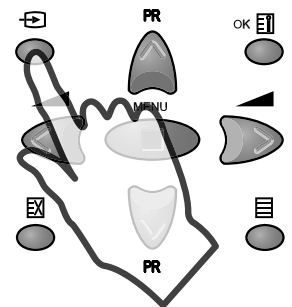

Side

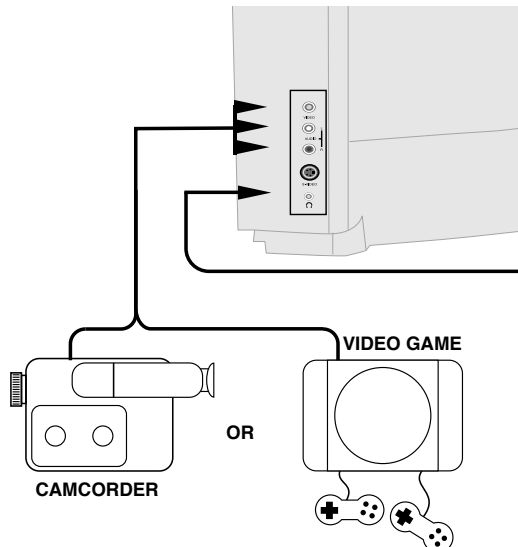

SIDE AV SOCKET (AV3)

The side AV socket (B7) - (B8) has audio and video inputs. To switch from TV to these inputs, use the TV / AV buttons (A5) or (B4) and select AV3.

SIDE S-VIDEO JACK

The side S-VIDEO jack (B9) has video inputs only. It is necessary to connect the audio inputs to socket (B8) in order to have audio and video. To switch from TV to these inputs, use the TV / AV buttons (A5) or (B4) and select SVHS3.

TV/AV SELECTION

Allows to switch between TV and external modes. By repeatedly pressing the remote control TV / AV (A5) or the TV front panel TV / AV (B4) button, the on-screen display is changed as shown AV1 > AV2 > SVHS2 > AV3 > SVHS3 > TV



DAILY USE

SWITCHING ON TV SET

1) If stand-by indicator (B5) is red, then the TV set is in stand-by mode.
You can switch on using the remote control POWER button (A1), the NUMBER 0...9 buttons (A3), or PROGRAM UP (A6) / DOWN (A21) buttons. The front panel PROGRAM UP/DOWN buttons (B2) can also be used.
Once on, the stand-by indicator turns to green and the picture appears on the screen.

2) If stand-by indicator (B5) is not lit, then the TV set is powered off.
You must press the TV set front panel MAIN POWER button (B1). If a picture does not appear, then the stand-by indicator will be red. In this case, use the remote control as indicated in 1).

3) If stand-by indicator (B5) is flashing red, and green then the TV set is in child-lock mode.
It is necessary to use the remote control POWER button (A1), NUMBER 0...9 buttons (A3), or PROGRAM UP (A6) / DOWN (A21) buttons. The front panel PROGRAM UP/DOWN buttons (B2) will not function.
Once on, the stand-by indicator turns to green and the picture appears on the screen.

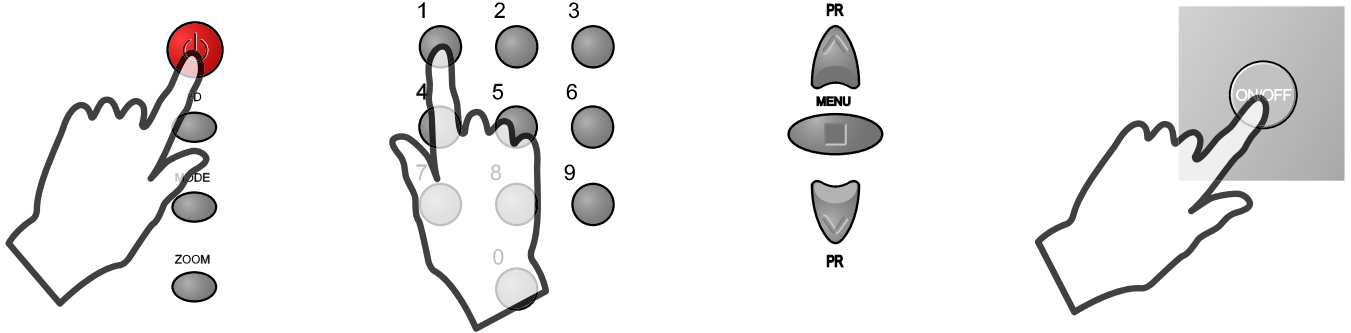

SWITCHING OFF TV SET

1) By pressing the remote control POWER button (A1), you can switch off to stand-by mode (low power consumption mode) which also allows quick restart by remote control (see above: SWITCHING ON TV SET).

2) Pressing the TV set front panel MAIN POWER button (B1), you can completely power off the TV set. In this case, you must use the same front panel POWER button (B1) to switch on again (see above: SWITCHING ON TV SET).

Remark: If a broadcast signal is not present after 30 minutes, the TV set will be automatically turned to stand-by mode.

PROGRAM SELECTION (FROM 0 TO 99)

Direct selection

Use the remote control NUMBER 0...9 buttons (A3).
For two digits program numbers, enter the second digit within 2 seconds.

Up / Down selection

Use the remote control PROGRAM UP (A6) / DOWN (A21) buttons or the TV set front panel PROGRAM UP / DOWN buttons (B2).

SOUND CONTROL

Volume adjustment

Use the remote control VOLUME UP (A20) / DOWN (A7) buttons or the TV set front panel VOLUME UP / DOWN buttons (B3).



Mute

Mute the sound by pressing the remote control SOUND MUTE button (A2).

Then, logo is displayed. The previous sound setting is returned after pressing the same button a second time.

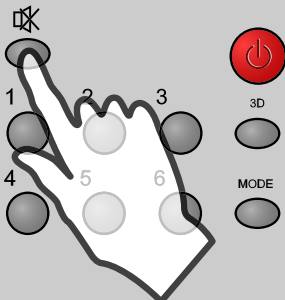

Mono forcing, dual language

- If you are unable to get good sound quality for a program due to poor reception, you can force a change from stereo to mono transmission by pressing the remote control MODE button (A14). Then the program status display indicates "MONO" (in red).

- On the other hand, during a program with dual language transmission, the MODE button (A14) allows you to toggle between the first and second language. The program status display will indicate "DUAL 1" or "DUAL 2" (plus NICAM according to the received signal).
- To return to initial state, press again the MODE button (A14).

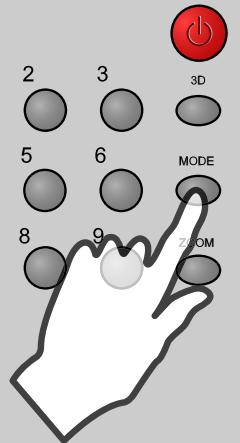

Sound effects

A SPATIAL sound effect is available, using the remote control 3D (A13) button.

The following display appears:

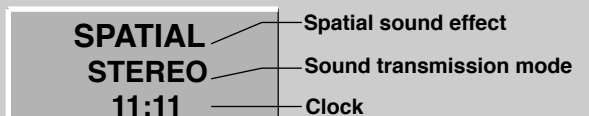

To return to initial sound effect, press again the 3D (A13) button.
The following display appears:

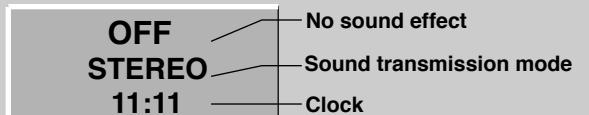

As an option, the sound effects PANORAMA, and VIRTUAL DOLBY are available with the same button.
For other adjustments (balance, equalizer, bass, treble), use the Sound menu (page8).