

Machine type: 10053

Lenovo IdeaCentre Q150 Series User Guide

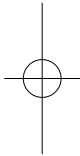

Version 1.0 2010.4

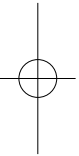

31044392



lenovo

ideacentre

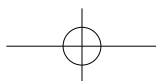

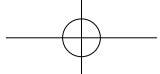

Important Safety Information

Before using this manual, it is important that you read and understand all of the related safety information for this product. Refer to the *Safety and Warranty Guide* you received with this product for the latest safety information. Reading and understanding this safety information reduces the risk of personal injury and damage to your product.



Danger: Beware of extremely hazardous or lethal situations.



Attention: Beware of possible damage to programs, devices, or data.



Note: Pay attention to this important information.

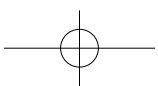
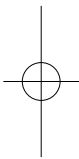
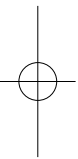
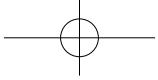

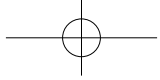

Contents

Important Safety Information

Chapter 1 Using the Computer Hardware	1
1.1 Front view.....	2
1.2 Rear view.....	3
1.3 Computer mount instruction.....	4
1.4 Setting the display resolution.....	6
1.5 Connecting your computer.....	6
Chapter 2 Recovery Wizard	11
Chapter 3 Using the Computer Software	15
3.1 CyberLink PowerDVD.....	17
3.2 McAfee Security Center.....	17
Chapter 4 System Maintenance and Recovery	19
4.1 Restoring the System.....	20
4.2 Backup and Restore.....	20
4.3 Cleaning Up the Disk.....	21
4.4 Checking For, and Correcting Disk Errors.....	21
4.5 Defragmenting the Disk(s).....	21
4.6 Performing Daily Maintenance Tasks.....	22
Chapter 5 Troubleshooting and Confirming Setup	23
5.1 Troubleshooting display problems.....	24
5.2 Troubleshooting audio problems.....	25
5.3 Troubleshooting software problems.....	26
5.4 Troubleshooting problems with Hard Disks.....	27
5.5 Special considerations for troubleshooting Windows.....	27

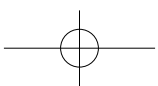
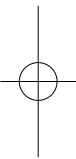
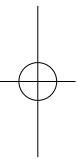
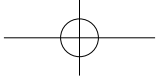

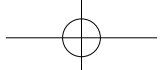

1

Chapter

Using the Computer Hardware

This chapter contains the following topics:

- Computer hardware introduction
- Information on computer connections

! **Note:** The descriptions in this chapter may vary from your computer setup, depending on computer models and configurations.

1

2

3

4

5

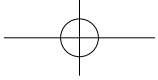

1.1 Front view



Attention: Ensure that none of the air vents on the computer are blocked. Blocked air vents can lead to overheating problems.

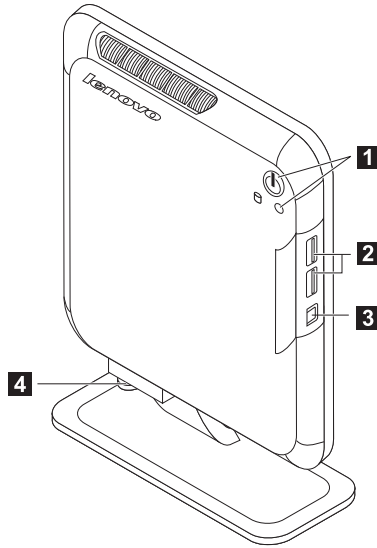

- | | |
|---|----------------------------|
| 1 Power button and power indicator | 3 S/P DIF connector |
| 2 USB2.0 ports (2) | 4 Base stand screw |

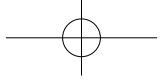

1.2 Rear view

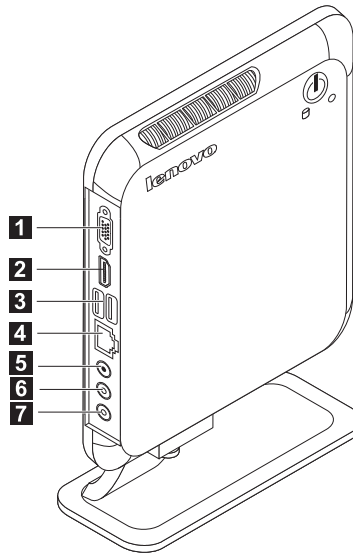

- 1** VGA port ~~or HDMI port~~
- 2** HDMI-OUT connector
- 3** USB2.0 ports(2)
- 4** Ethernet ports

- 5** Power socket
- 6** Audio line-out
- 7** Audio line-in

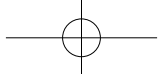

1.3 Computer mount instruction

The computer chassis can be placed in a vertical position.

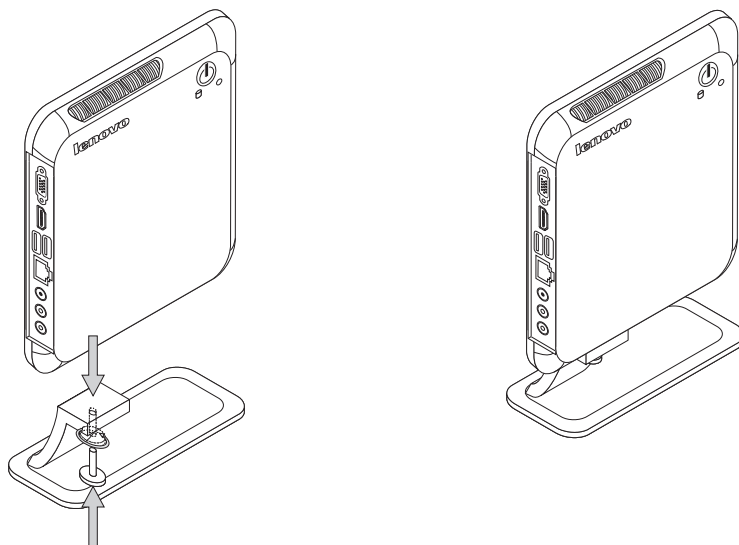

Installing the base stand

1. Attach the base stand to the unit.
2. Tighten the screw with your fingers.

! **Note:** Make sure to install the base stand before placing the chassis in a vertical position.

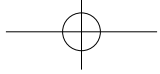

The computer chassis also can be mounted behind your TV or monitor. (Only some models have this metal bracket.)

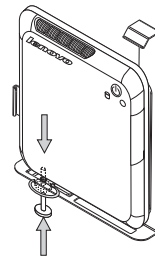
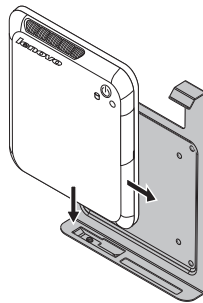
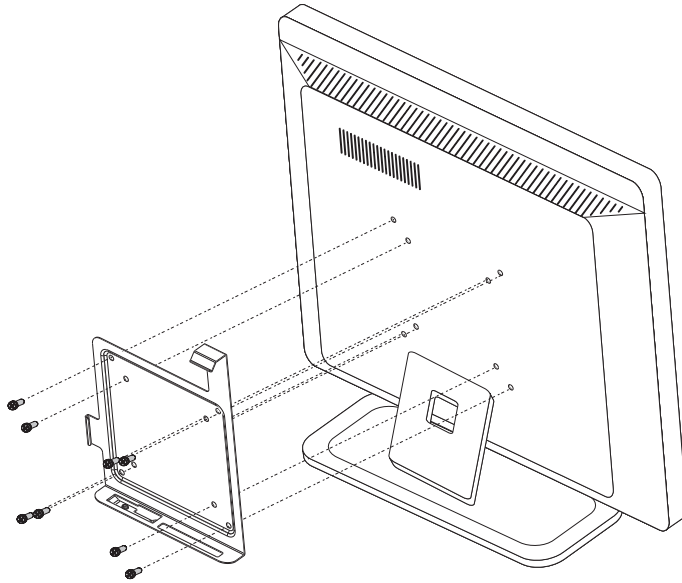

1. First, screw the metal bracket to the rear of TV or monitor.
2. Slide the computer into this metal bracket and screw the computer firmly to the Bracket.

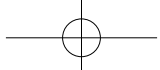

1.4 Setting the display resolution

1. When you connect the computer to your TV or monitor, adjust the display resolution to the optimum setting according to the instructions in your TV or monitor's user manual or after consulting with the supplier.
2. Adjusting the OS desktop size (when the OS desktop size is larger than the screen boundary):
 - IdeaCentre Q150: After configuring the display resolution of your TV or monitor, right-click the desktop anywhere except over an icon, then select NVIDIA control panel.

! **Note:** Use the Apply button to set the new resolution of your TV or monitor. If your TV or monitor does not support this new resolution, system will restore to the original resolution within 20 seconds.

Important:

IdeaCentre Q150:

- Set the refresh rate of your TV or monitor to less than 60 Hz to avoid damage to your TV or monitor.
- If no image is displayed on the TV or monitor after setting a new refresh rate, turn off your TV or monitor and wait for a moment before restarting.
- When connecting to a TV, please select the TV's appropriate input channel.

1.5 Connecting your computer

Use the following information when connecting your computer.

- Look for the small port/socket icons on the back of your computer. Match the cable ends to the icons.
- If your computer cables and port/socket panels have color-coded ports or sockets, match the color of the cable end with the color of the port or socket.

! **Note:** Your computer might not have all of the ports and sockets that are described in this section.

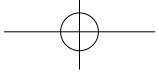

1.5.1 Connect the keyboard cable to the appropriate keyboard port (USB port). (Not all models are equipped with a keyboard.)

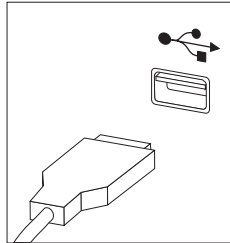

1.5.2 Connect the mouse cable to the appropriate mouse port (USB port). (Not all models are equipped with a mouse.)

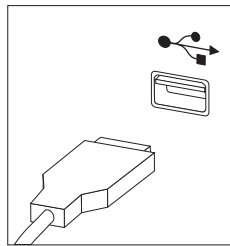

1.5.3 Connect the monitor cable to the monitor port on the computer.

- If you have a Video Graphics Array (VGA) Standard monitor, connect the cable to the port as shown.

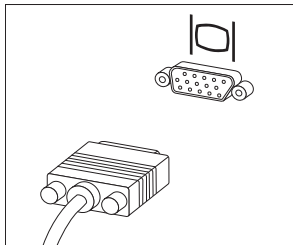

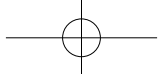

- If you have an HDMI monitor, connect the cable to the port as shown.

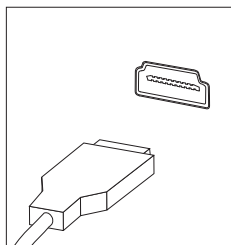

1.5.4 If you have audio devices, use the following information to connect them.

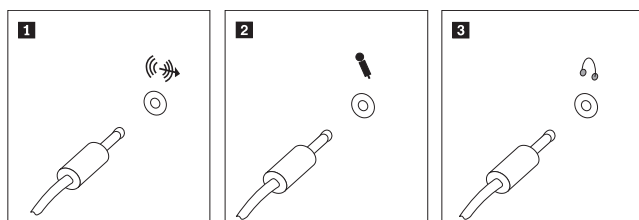

- 1 Audio line-out** This socket sends audio signals from the computer to external devices, such as powered stereo speakers.
- 2 Audio line-in** Use this socket to attach a microphone to your computer when you want to record sound or if you use speech-recognition software. This socket might be located on the front of the computer.

1.5.5 If you have *powered* speakers with an adapter:

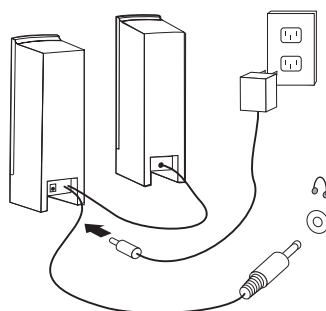

(This picture is only a sketch for guidance, it does not necessarily show actual speakers)

- a. Connect the cable that runs between the speakers, if necessary. On some

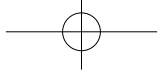

- speakers, this cable is permanently attached.
- b. Connect the adapter cable to the speaker, if necessary. On some speakers, this cable is permanently attached.
- c. Connect the speakers to audio line-out port on the computer.
- d. Connect the adapter to the power source.

1.5.6 If you have *powered* speakers without an adapter:

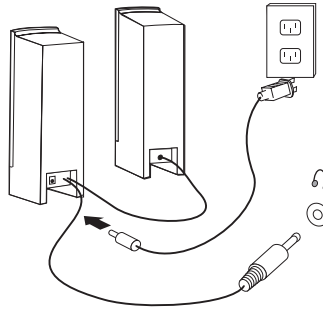

(This picture is only illustration. It is not necessarily meant to be a true representation of the speakers.)

- a. Connect the cable that runs between the speakers, if necessary. On some speakers, this cable is permanently attached.
- b. Connect the cable to the speaker, if necessary. On some speakers, this cable is permanently attached.
- c. Connect the speakers to the audio line-out port on the computer.
- d. Connect the plug to the power source.

! **Note:** Some models are not equipped with external speakers.

1.5.7 Connect any additional devices that you have. Your computer might not have all the ports/sockets shown.

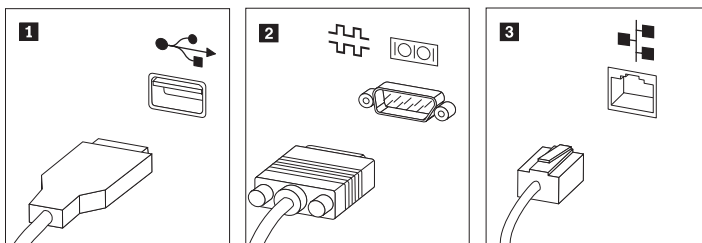

1 **USB** Use this port to attach a device that requires a USB connection.

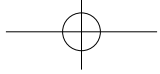

- 2 S-Video** Use this port to attach a television set that has an S-Video port.
- 3 Ethernet** Use this port to attach the computer to an Ethernet-type local area network (LAN).

1.5.8 Using S/P DIF output digital signals:

If you have external devices that support S/P DIF, you can use the S/P DIF port output high definition audio signal. Do the following before using S/P DIF output:

1. Connect the external device to the **S/P DIF** port.
2. Click **Start** → **Control Panel** → **Hardware and Sound** → **Manage audio devices**, from the pop up window choose **Playback** tab, choose **Digital Audio (S/P DIF)** as your playback device, click the **Apply** button save your change.

! **Note:** You may find no sound if you switch to a different external sound that device does not support S/P DIF, follow step 2 to choose a proper playback device.

1.5.9 Connect the power cables properly to earthed electrical outlets.

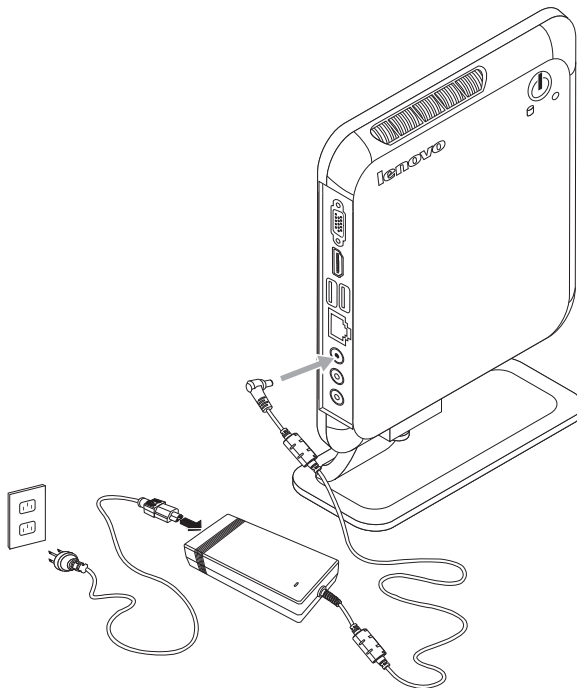

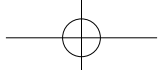

2

Chapter

Recovery Wizard

This chapter contains the following topics:

➤ Recovery Wizard



Attention: Using this program will result in loss of data.

1

2

3

4

5

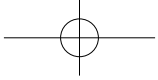

Recovery Wizard

Recovery Wizard will lead you through steps to recover your computer system. You can also return your computer to original factory configuration.

1. Turn on the computer. When the Lenovo logo appears, press the F2 key to launch the Windows Boot Manager. Then select **Windows Setup** to launch Recovery Wizard procedure.
2. The Welcome window appears.



- !** **Note:** All data under C: drive will be lost. You may backup all personal data before proceeding.

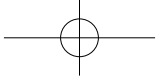

3. Click **Next**.

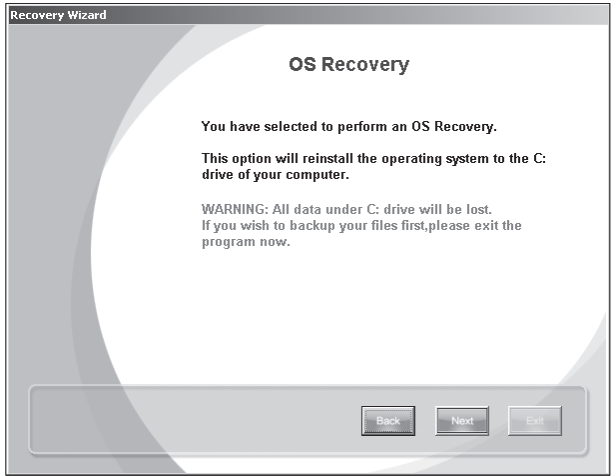

4. The recovery will take several minutes to complete.

! **Note:** Do not restart your computer while recovery is in progress.

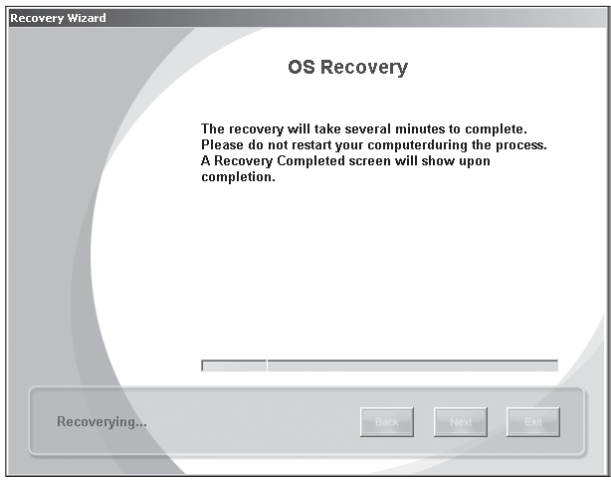

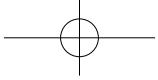

5. Click **Restart** or **Shutdown** to finish the recovery process.



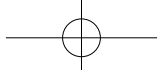

3

Chapter

Using the Computer Software

This chapter contains the following topics:

- Computer software instructions

! **Note:** The interface and functionality of these features may vary according to the software that was shipped with the computer model that you purchased.

1

2

3

4

5

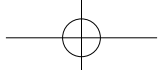

Instructions on how to play High Definition (HD) audio and video files

1. Video format

The standard product has no installation software or a plug-in for high definition audio and video players; although some models may come with audio and video software, it is not guaranteed that they will support all high definition audio and video formats. Therefore, if the user needs to play high definition audio and video or CD material, the user will need to purchase or download software or a plug-in from the internet that can play the corresponding audio or video files.

Because commercial audio and video files or files obtained via the internet do not yet have uniform production standards, if the user cannot play or has difficulty playing some of the audio and video files during normal operation, it does not necessarily mean there is a hardware or system problem; instead, the user is recommended to consult with the supplier or manufacturer concerning problems related to audio and video players, plugins and audio and video files.

IdeaCentre Q150 has been tested for playing high definition audio and video files of the following specifications: (the actual audio and video performance may be different according to differences in individual product configuration, software and hardware, as well as audio and video file formats)

Resolution	Video encoding format	Bit rate	Frame rate
1920x1080	VC-1	11Mbps	24fps
1920x1080	MPEG2	20Mbps	24fps
1920x1080	H.264	12Mbps	24fps

It also supports "NVIDIA(R) PureVideo(R)" technology. With this feature alone, Q150 is able to support hardware acceleration for 1080p video. Please go to the website below for more information.

http://www.nvidia.com/page/purevideo_HD.html

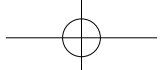

3.1 CyberLink PowerDVD

Cyberlink PowerDVD is a media player designed to play common audio and video files. It supports some High Definition (HD) audio and video files such as MPEG-2, VC-1, H.264 (Mpeg-4 AVC) video formats and AC3, AAC audio formats.

Cyberlink PowerDVD can be upgraded to support other audio or video formats. Please follow instructions for this which are included in the software program.

To launch the player:

Choose **All Programs** → **Lenovo PowerDVD9** → **CyberLink PowerDVD9** from the **Start** menu to launch the player.

Click the “?” icon to obtain more information about CyberLink PowerDVD9.

3.2 McAfee Security Center

McAfee VirusScan Center offers proactive PC security to prevent malicious attacks. It also provides security against multi-pronged attacks by combining anti-virus, anti-spyware and firewall technologies.

 **Note:** Connect to the Internet before activation.

3.2.1 Using McAfee Security Center

Choose **All Programs** → **McAfee** → **McAfee Security Center** from the **Start** menu to launch the antivirus software.

Or, Double click the **McAfee Security Center** on the desktop to launch the antivirus software.

3.2.2 Scanning for Viruses

Click **Scan** on the Security Center home page. Select a task on the Scan Options pane, Click **Start** to launch the scan program. Upon completion, the software will pop up a system scanning report, which lists all virus files detected, and you can then quarantine or delete them as required.

3.2.3 Check for updates

Click **Update** on the Security Center home page to check for updates.

 **Note:** Connect to the Internet before upgrading.

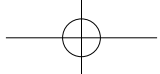

3.2.4 Help and Support

For more information on the operation of Security Center, see product help Information in the **Help** option. In the help document, you can learn more about McAfee Security Center operation and settings.

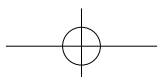
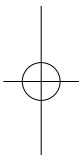
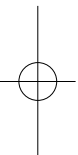

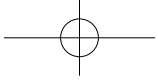

4

Chapter

System Maintenance and Recovery

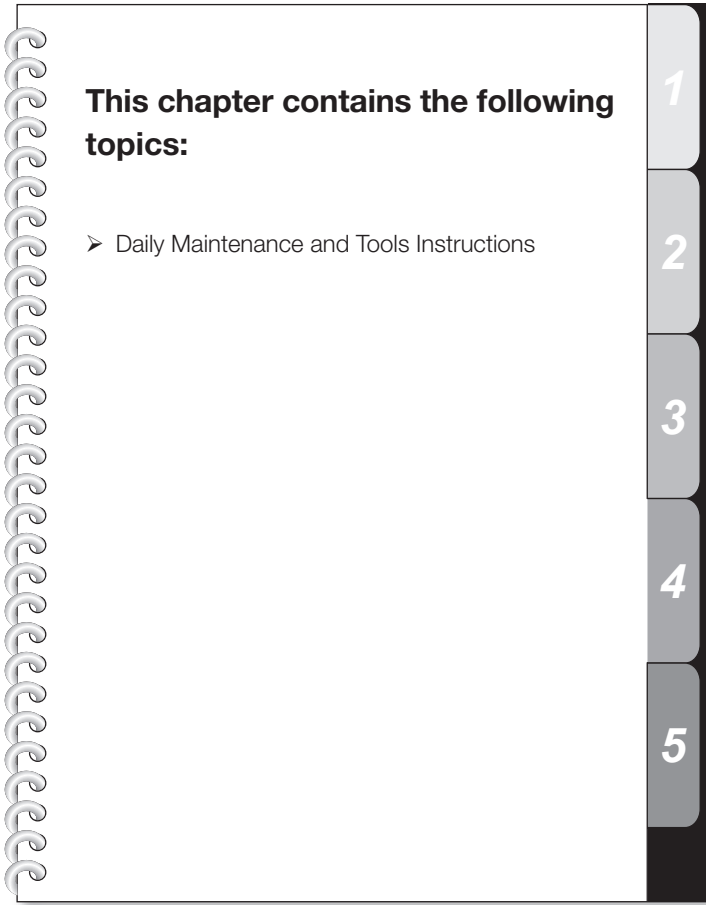

This chapter contains the following topics:

- Daily Maintenance and Tools Instructions

1

2

3

4

5

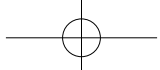

4.1 Restoring the System

The system can develop problems due to erroneous operation or the installation of additional software. If software problems develop in the originally installed software, you can restore the system by using system backup and restoration features.

! **Note:** The existing system settings will change after restoration. Check the settings of the restored system to ensure they match settings that may be critical to your needs.

Use the following procedure to restore the software to a known functional level:

1. Click **Start** → **All Programs** → **Accessories** → **System Tools** → **System Restore**.
2. Choose either the recommended restore point, or select a different recovery time from the pop-up box. Choose the latest date when the system was running properly.
Click **Next** to continue.
3. The system will start restoration. When all processes run to completion, the system displays a message informing you that the restore operation has completed successfully.

4.2 Backup and Restore

For security purposes, you can back up the system status before you install additional software, or otherwise modify system settings. To back up the system status, do the following:

For Windows XP user:

1. Click **Start** → **All Programs** → **Accessories** → **System Tools** → **Backup**.
2. Select the location for your backup. Click **Next** and follow the instructions to continue.

For Windows 7 user:

1. Click **Start** → **All Programs** → **Maintenance** → **Backup and Restore**.
2. Select the location for your backup. Click **Next** and follow the instructions to continue.

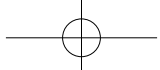

4.3 Cleaning Up the Disk

Do the following periodically to clean up the disks and possibly enhance your computer's performance:

1. Click **Start** → **All Programs** → **Accessories** → **System Tools** → **Disk Cleanup**.
2. Choose the disk you want to clean up.
3. Click the **OK** button to start the cleanup process.

4.4 Checking For, and Correcting Disk Errors

To properly maintain your system, you should periodically check for and fix hard disk errors by doing the following:

1. Right-click the icon for the hard disk drive (HDD) that you want to reorganize, then select **Properties** from the pop-up menu.
2. Select the **Tools** tab, and then click **Check Now**.
3. Check your inspection items for the disk and click **Start**.

 **Note:** You cannot start error checking until the computer is restarted and initialized.

4.5 Defragmenting the Disk(s)

Disk fragments are tiny unused storage areas scattered on the disk. The system cannot directly reutilize these "blank" spaces and system performance can decrease as system operations usually cause the number of unused storage gaps to increase. To defragment your disk storage, do the following:

1. Right-click the icon for the hard disk drive (HDD) that you want to reorganize, then select **Properties** from the pop-up menu.
2. Go to the **Tools** tab from disk **Properties** and select **Defragment Now**.
3. Select the time and scheme to be used by the defragging program, then start the defragmenting program. Depending on the amount of defragmentation on the hard disk drive, this procedure can take a long time (sometimes more than one hour).

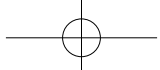

4.6 Performing Daily Maintenance Tasks

Cleaning the computer components

Because many of the computer components consist of sophisticated integrated circuit boards, it is very important to periodically clean around the computer to prevent dust buildup. The cleaning supplies you need in order to clean the components include: a vacuum cleaner, a soft cotton cloth, clear water (pure water preferred) and cotton swabs.



Attention: Before you clean your computer, disconnect the computer from the electrical outlet. Clean your computer with a soft cloth dampened with water. Do not use liquid or aerosol cleaners, which may contain flammable substances.



Note: To avoid damaging the computer or display, do not spray cleaning solution directly onto the display. Only use products specifically designed for cleaning displays, and follow the instructions that are included with the product.

The following are general methods for cleaning the components:

- You can use a soft cloth to remove dust on the surface of the computer, the monitor, the printer, the speakers and the mouse.
- You can use a vacuum cleaner to clean in otherwise inaccessible corners.
- To clean the keyboard thoroughly, shut down the computer and scrub it gently with a wet cloth.
- Do *not* use the keyboard until it is dry.

Do not do any of the following:

- Allow water to enter the computer
- Use a heavily dampened cloth
- Spray water directly onto the surface of the monitor or inside of computer.

Daily attention should be given to LCD monitors. Use a dry cloth daily to brush dust from the monitor and keyboard. Keep all surfaces clean and free of grease stains.

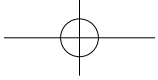

5

Chapter

Troubleshooting and Confirming Setup

This chapter contains the following topics:

- Troubleshooting and Problem Resolution

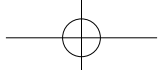

Solving problems

Follow these tips when you troubleshoot your computer:

- If you added or removed a part before the problem started, review the installation procedures and ensure that the part is correctly installed.
- If a peripheral device does not work, ensure that the device is properly connected.
- If an error message appears on the screen, write down the exact message. This message may help support personnel diagnose and fix the problem(s).
- If an error message occurs in a program, view the program's documentation.

 **Note:** The procedures in this document were written for Windows in default view mode, so they may not apply if you set your Lenovo® computer to Windows Classic view.

5.1 Troubleshooting display problems

Problem: Blank screen or no image is displayed on the monitor

Troubleshooting and problem resolution:

1. Check that the monitor has been turned on; if not, press the Power button.
2. Check to see if the monitor power cable is loose; if so, securely plug the power cable into the monitor.
3. Check that the signal cable to the monitor is securely connected to the computer graphics card port; if not, shut down the computer then securely connect the signal cable of the monitor.

Problem: You need to change the display property settings.

Setting display background and icon properties:

1. Right-click the desktop anywhere except over an icon, then select Personalize from the pop-up menu.
2. From here, select the appropriate options to:
 - Change the desktop background
 - Select a screen saver
 - Select colors and appearance options for icons and characters
 - Set resolution and colors using the Display Settings options.
3. Select **Display Settings** to set the resolution and colors.
Use the **Apply** button to set the new resolution of your TV or monitor. If your TV

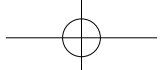

or monitor does not support this new resolution, the system will recovery to the original resolution within 20 seconds.

Set the refresh rate of your TV or monitor to less than 60 Hz to avoid damage to your TV or monitor.

If there is no image displayed on the TV or monitor after setting a new refresh rate, turn off your TV or monitor and wait for a moment before restarting.

For TV, you may switch the input style to another and then switch it back to make your TV display normally.

Problem: Ripple on screen

Troubleshooting and problem resolution:

1. Check for devices located less than one meter from the computer such as refrigerators, electric fans, electric dryers, UPSs, regulators, fluorescent lamps or other computers that may be generating magnetic interference.
2. Move any interfering devices away from the computer.
3. If the problem persists, consult your display devices supplier.

5.2 Troubleshooting audio problems

Problem: No sound from integrated speakers

Troubleshooting and problem resolution:

- Adjust the Windows volume control — double-click the speaker icon in the lower-right corner of your screen. Ensure that the volume is turned up and that the sound is not muted. Adjust the volume, bass, and treble controls to eliminate distortion.
- Reinstall the audio driver
- Disconnect any headphones from the headphone socket — sound from the speakers is automatically disabled when headphones are connected to the computer's side-panel headphone socket.
- Remove and reconnect the HDMI connector, restart the computer, and set the HDMI as the audio output mode (for example via the control panel)

! **Note:** IdeaCentre Q150 supports HDMI audio and video output. To learn more about HDMI, go to the web site at: <http://www.hdmi.com/>

Problem: No sound from headphones

Troubleshooting and problem resolution:

- Check the headphone cable connection — ensure that the headphone cable is

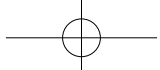

securely inserted into the headphone socket.

- Adjust the Windows volume control — click or double-click the speaker icon in the lower-right corner of your screen. Ensure that the volume is turned up and that the sound is not muted.
- Change audio device — click **Start** → **Control Panel** → **Hardware and Sound** → **Manage audio devices**, a **sound** window will pop out, click the **playback** tab to choose the proper playback device.

5.3 Troubleshooting software problems

Problem: You are unable to exit a running program normally.

Troubleshooting and problem resolution:

1. Open the **Task Manager** window by pressing **Ctrl, Alt** and **Delete** at the same time.
2. Select the **Application** tab, select the problematic program, and then click the **End Task** button.

Problem: You need to install or uninstall a program.

Problem resolution:

During installation never abort the install process by powering the system off or through other drastic means. This can cause system program disorder or even failure during system initialization.

During the uninstall process, never directly delete individual files or folders. This is harmful to the system, and might cause a system-wide malfunction.

Use the following procedure to properly uninstall programs:

For Windows XP user:

1. Back up all documents and system settings related to the program before removing it.
2. If the program has its own uninstaller, run it directly to uninstall the program.
3. If the program does not have its own uninstaller, then select Control Panel from Start menu.
4. From the **Control Panel**, choose **Add or Remove Programs**.
5. Find the applicable program in the Programs and Functions dialog box and then select **Change/Remove**.

For Windows 7 User:

1. Back up all documents and system settings related to the program before

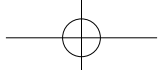

removing it.

2. If the program has its own uninstaller, run it directly to uninstall the program.
3. If the program does not have its own uninstaller, then select **Control Panel** from **Start** menu.
4. From the **Control Panel**, choose **Programs** → **Programs and Features**.
5. Find the applicable program in the Programs and Functions dialog box and then select **Uninstall/Change**.
6. Follow the displayed instructions to uninstall the software.

5.4 Troubleshooting problems with Hard Disks

Problem: The capacity of the hard disk, as indicated by the system, is less than the nominal capacity.

Troubleshooting and problem resolution: For computers equipped with the OneKey Recovery feature, the system recovery feature needs to occupy some hard disk space. This may account for the apparent hard disk capacity deficit.

Further Technical Explanation: The nominal capacity of the hard disk is expressed in the decimal system, 1000 bytes. But the actual hard disk capacity is expressed in the binary system as 1024 bytes (For example, a nominal capacity of 1GB is 1000MB, while the actual capacity of 1GB is 1024MB).

The capacity of the hard disk shown in Windows can be worked out according to the calculations in the following example:

The nominal capacity of the hard disk is 40GB, while its actual capacity should be: $40 \times 1000 \times 1000 \times 1000 / (1024 \times 1024 \times 1024) = 37\text{GB}$.

If the Service partition of 3GB - $3 \times 1000 \times 1000 \times 1000 / (1024 \times 1024 \times 1024) = 2.79\text{GB}$ is subtracted, the capacity of the hard disk shown in the system can be obtained.

The capacity of the hard disk as calculated using this method may be slightly different from the actual capacity due to the rounding of totals.

5.5 Special considerations for troubleshooting Windows

Record the following information that may be useful later when troubleshooting system problems:

1. The serial number of the software. The serial number is shipped labeled on the computer and is also provided separately by the manufacturer. The Help Center

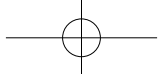

is unable to retrieve this number.

2. The drivers for this computer model support Windows XP or Windows 7 systems.
3. When you use the Windows Media Center to watch TV, pay particular attention to the following:
 - In the following two situations, you must re-save the channel list:
 - a. When you change your TV signal from digital to analog, your saved channel list for digital TV is deleted. When you want to watch digital TV again, you must create and save a new channel list.
 - b. When you change your TV signal from analog to digital, your saved channel list for analog TV is deleted. When you want to watch analog TV again, you must create and save a new channel list.
 - Before you can watch teletext programming, you must set the TV tuner input signal to analog.