

ProMix[®] 2KS/3KS Web Interfaces

313386D

EN

Installation and program setup instructions to allow communication between a PC and the ProMix[®] 2KS/3KS Electronic Proportioner, via an Ethernet. For professional use only.

Not for use in explosive atmospheres.

Basic Web Interface (supplied with ProMix 2KS/3KS EasyKey software)

Advanced Web Interface Kit 15V337 (Accessory)



Important Safety Instructions

Read all warnings and instructions in this manual and in your proportioning system manual. Save these instructions.

Advanced Web Interface Module Shown

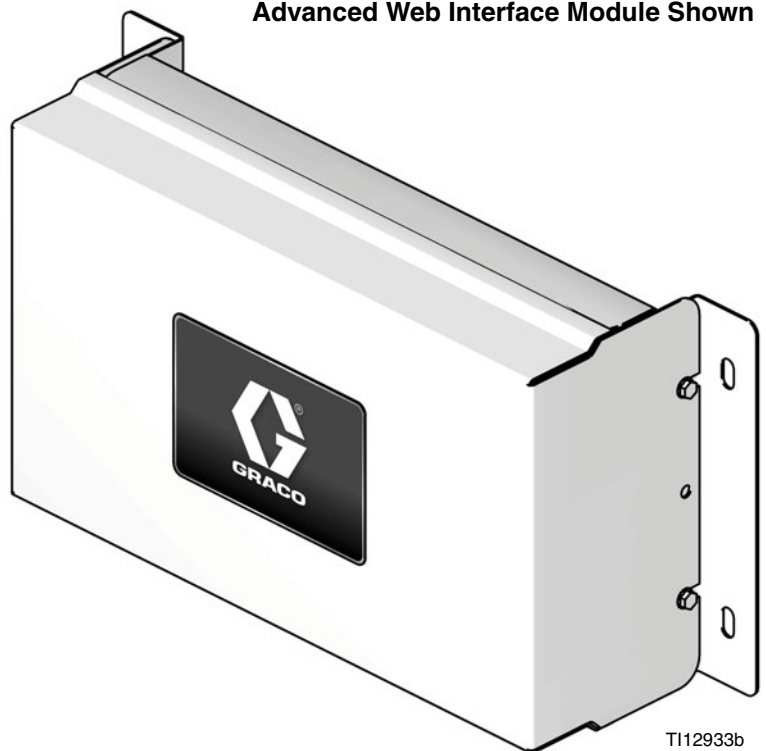

T112933b



Contents

Related Manuals	2	Set the Network Configuration	19
Warnings	3	AWI Screens	21
ProMix 2KS/3KS Basic Web Interface (BWI)	4	Network Tab	21
Installation	4	Materials Tab	22
Web Navigation Screens	8	Settings Tab	24
Install the Advanced Web Interface (AWI) Module 12		System Setup Screens	26
Overview	12	Replace AWI Board	36
Location	12	Parts	38
Mounting	12	15V337 Advanced Web Interface Module	38
Connect Module to EasyKey and PC	13	15V336 Advanced Web Interface Server Hub ..	39
Computer Configuration	16	Electrical Schematic	40
Set up an Automatic IP Address	16	Dimensions	41
System Initialization	16	Graco Standard Warranty	42
Password Recovery	18	Graco Information	42



Related Manuals

Component Manuals in English

Manual	Description
312775	ProMix 2KS Manual System Installation
312776	ProMix 2KS Manual System Operation
312777	ProMix 2KS Manual System Repair-Parts
312778	ProMix 2KS Automatic System Installation
312779	ProMix 2KS Automatic System Operation
312780	ProMix 2KS Automatic System Repair-Parts
313881	ProMix 3KS Installation (All Systems)
313882	ProMix 3KS Manual System Operation
313883	ProMix 3KS Repair-Parts (All Systems)
313885	ProMix 3KS Automatic System Operation
312781	Fluid Mix Manifold
312782	Dispense Valve
312783	Color Change Valve Stacks
312787	Color Change Module Kit
312784	Gun Flush Box Kits
310745	Gun Air Shutoff Kit
312786	Dump Valve and Third Purge Valve Kits
312785	Network Communication Kits
308778	G3000/G3000HR/G250/G250HR Flow Meter
310696	Coriolis Flow Meter
313212	Gun Flush Box Integration Kit
313290	Floor Stand Kit

Warnings

The following warnings are for the setup, use, grounding, maintenance, and repair of this equipment. The exclamation point symbol alerts you to a general warning and the hazard symbol refers to procedure-specific risk. Refer back to these warnings. Additional, product-specific warnings may be found throughout the body of this manual where applicable.

 WARNING	
	<p>EQUIPMENT MISUSE HAZARD</p> <p>Misuse can cause death or serious injury.</p> <ul style="list-style-type: none"> • Do not operate the unit when fatigued or under the influence of drugs or alcohol. • Do not exceed the maximum working pressure or temperature rating of the lowest rated system component. See Technical Data in all equipment manuals. • Use fluids and solvents that are compatible with equipment wetted parts. See Technical Data in all equipment manuals. Read fluid and solvent manufacturer's warnings. For complete information about your material, request MSDS forms from distributor or retailer. • Check equipment daily. Repair or replace worn or damaged parts immediately with genuine manufacturer's replacement parts only. • Do not alter or modify equipment. • Use equipment only for its intended purpose. Call your distributor for information. • Route hoses and cables away from traffic areas, sharp edges, moving parts, and hot surfaces. • Do not kink or over bend hoses or use hoses to pull equipment. • Keep children and animals away from work area. • Comply with all applicable safety regulations.
	<p>ELECTRIC SHOCK HAZARD</p> <p>Improper grounding, setup, or usage of the system can cause electric shock.</p> <ul style="list-style-type: none"> • Turn off and disconnect power at main switch before disconnecting any cables and before servicing equipment. • Connect only to grounded power source. • All electrical wiring must be done by a qualified electrician and comply with all local codes and regulations.

ProMix 2KS/3KS Basic Web Interface (BWI)

NOTE: Screen views in this manual are shown using Microsoft Windows XP.

NOTE: The ProMix 2KS/3KS Basic Web Interface (BWI) is supplied with all EasyKeys. To run the program, Java Version 6 Update 10 (or later) must be loaded on your computer. This is a free download.

Installation

1. Before connecting your computer to the EasyKey, verify that Java Version 6 Update 10 (or later) is loaded on your computer. To verify, go to Java.com using your Internet browser and click on “Do I Have Java?” for further information.
2. After verifying that Java is loaded on the computer, connect the computer directly to the EasyKey, using the 15G869 CAT5 ethernet crossover cable supplied with the EasyKey. See FIG. 1.

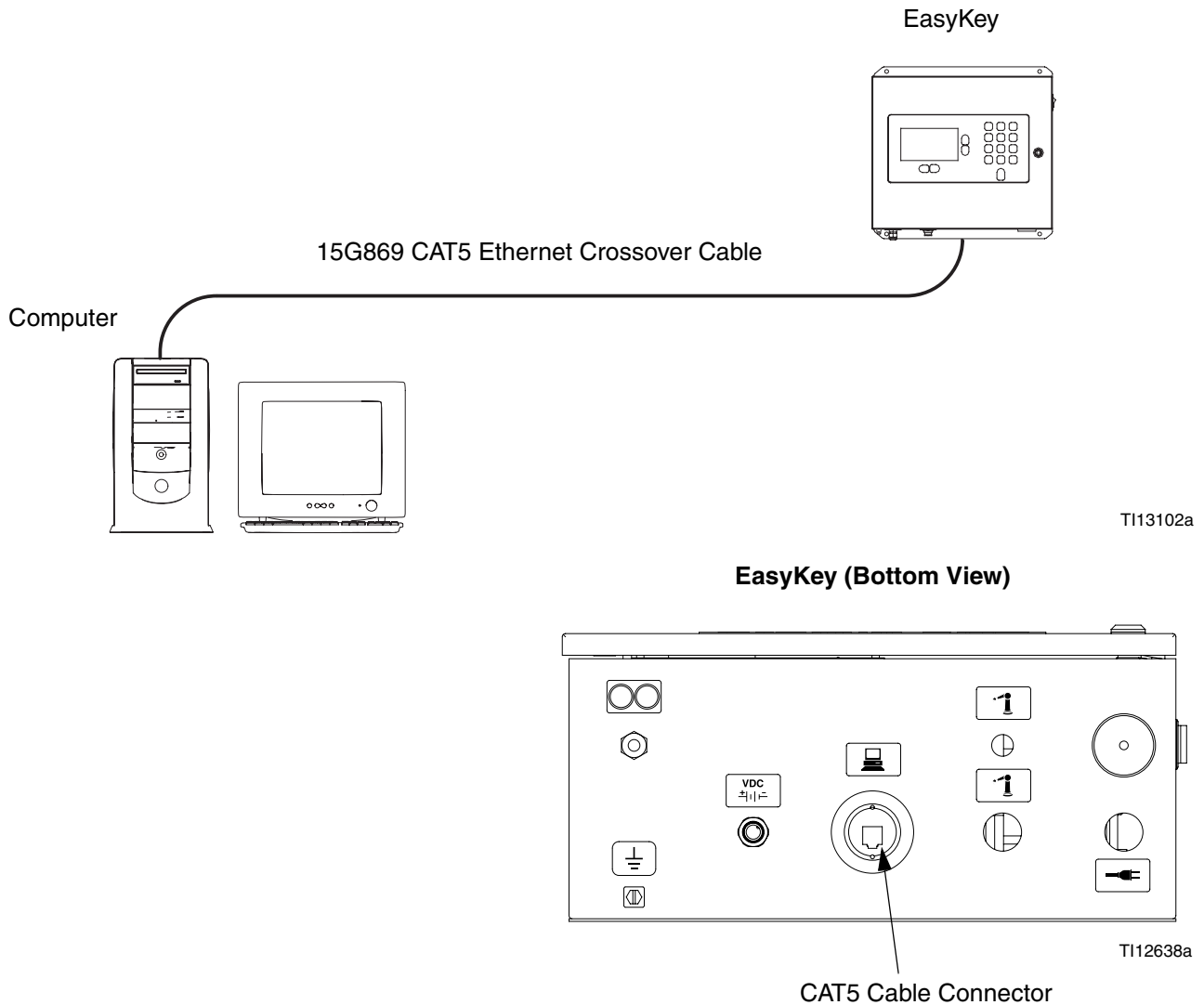

FIG. 1. ProMix 2KS/3KS Basic Web Interface Connection

3. Before running the BWI software you must manually assign an IP address to your computer:

a. On your computer, click on the Start button



to open the menu, then click

on Control Panel

b. See FIG. 2. Double click on Network Connections. Double click on Local Area Connection to open the Local Area Connection Status window. Click on Properties to open the Local Area Connection Properties window. See FIG. 3.

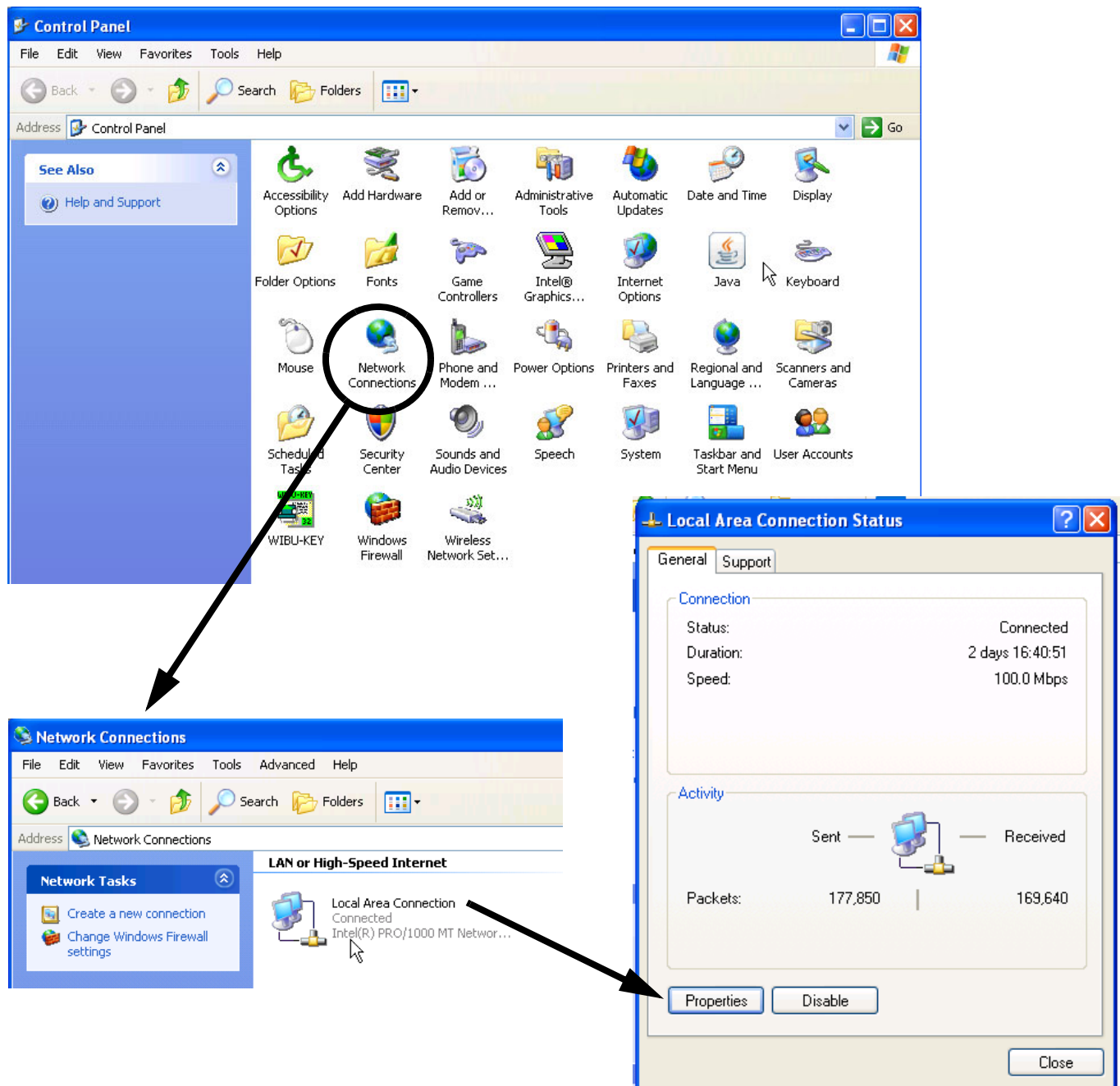

FIG. 2. Assign IP Address on Computer

- c. In the Local Area Connection Properties window, scroll to Internet Protocol (TCP/IP) and double click, to open the Internet Protocol (TCP/IP) Properties window. See FIG. 4.

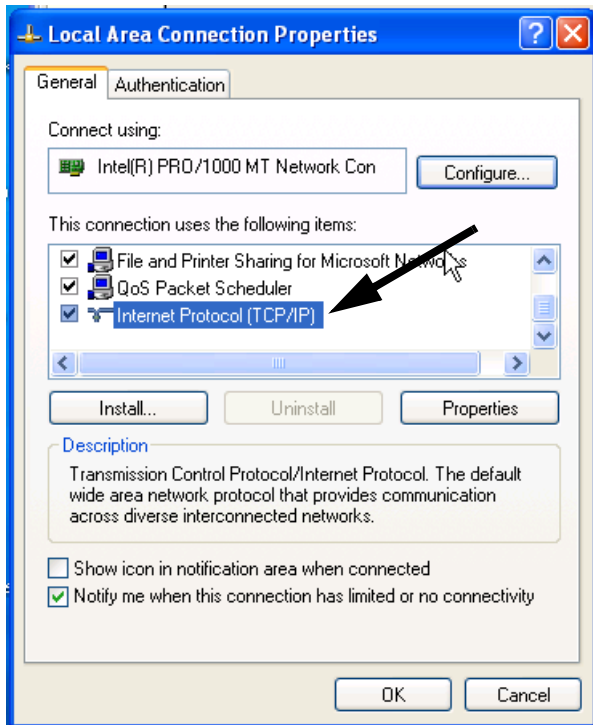

FIG. 3: Local Area Connection Properties Window

- d. See FIG. 4. Set to “Use the following IP address:”
- e. Type in the following IP address:
192.168.178.201

- f. Type in the following Subnet mask:
255.255.255.0

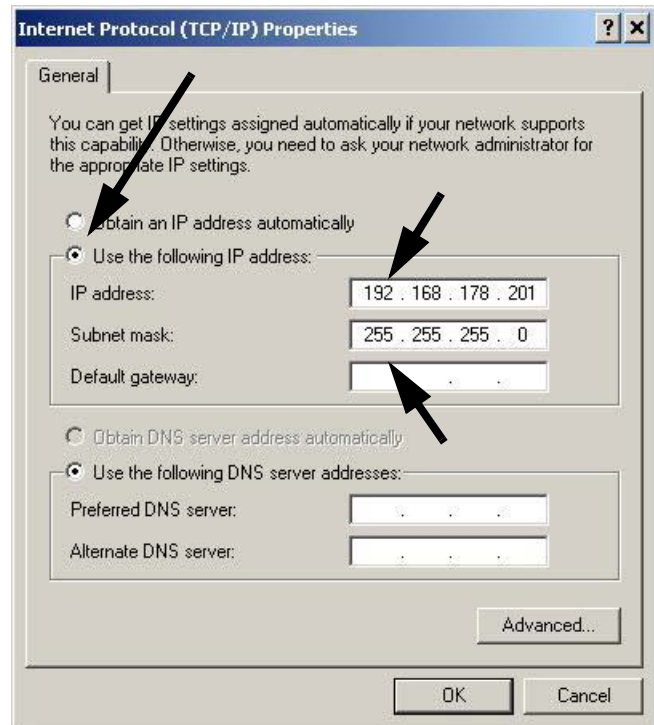

FIG. 4: Internet Protocol (TCP/IP) Window

NOTE: To reconnect to the user network, change the setting back to “Obtain an IP Address Automatically.”

- g. Click on OK to accept the changes and close the Internet Protocol (TCP/IP) Properties window.
- h. Click on OK to close the Local Area Connection Properties window.
- i. Close the Local Area Connection Status window and Network Connections window.

- On the EasyKey, go to System Configuration Screen 5 and write down the IP number assigned to that EasyKey (1-99). See FIG. 5.

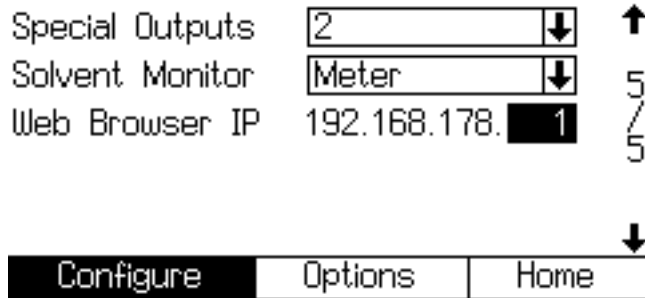

FIG. 5: System Configuration Screen 5

NOTE: Verify that the wireless connection is turned off (disabled) before performing step 5.

- Open Microsoft Internet Explorer (Start>All Programs>Internet Explorer).
- In the address area type http://192.168.178.____ (fill in the last digit with the EasyKey IP number recorded in step 4).
- Press Enter.
- Select Run when security screen appears. See FIG. 6.



FIG. 6: BWI Security Screen

- Main software screen appears. See FIG. 7.
 - If “Cannot Read Firmware” appears check for loose hardware connections.

- If “ProMix web interface requires Java to run” appears, verify that Java Version 6 Update 10 (or later) is loaded on your computer. See page 4.

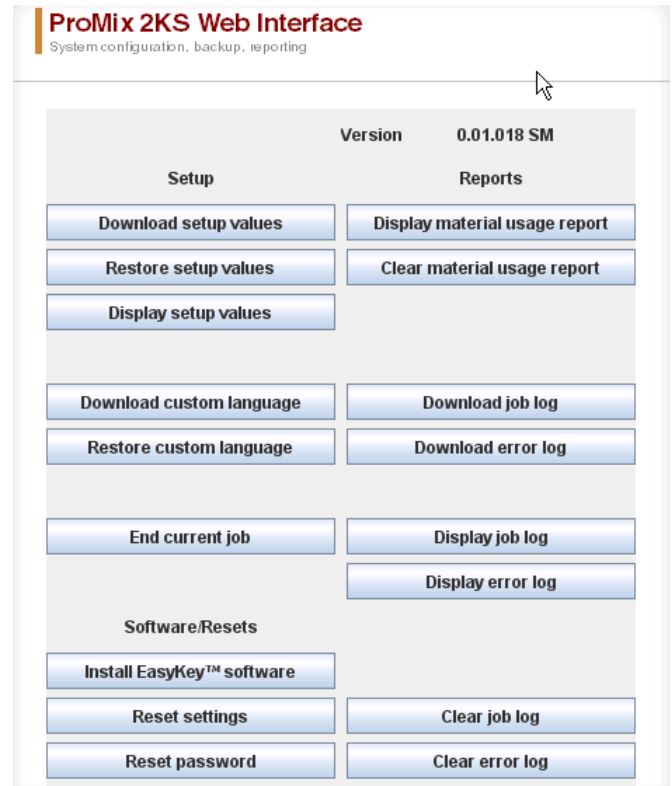

FIG. 7. Main BWI Screen

Web Navigation Screens

From the main BWI screen (see FIG. 7) the operator can select Setup, Software/Resets, or Reports.

NOTE: Before running the BWI program, check the EasyKey Status screen to ensure that the system is in Standby.

Setup

Download setup values - saves the ProMix 2KS/3KS configuration to the PC. This file can be opened and edited using Microsoft Excel, or used to set up multiple systems.

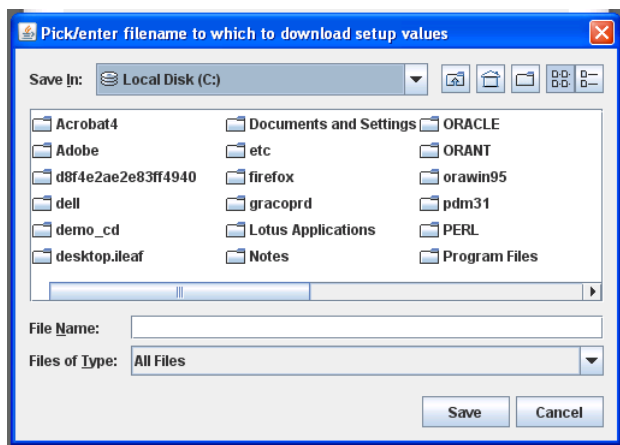

FIG. 8: Download Setup Values

Restore setup values - allows files to be uploaded and restored to the ProMix 2KS/3KS.

Display setup values - indicates what values are currently being used for the system. Allows the operator to verify that the right values are being used. See FIG. 9.

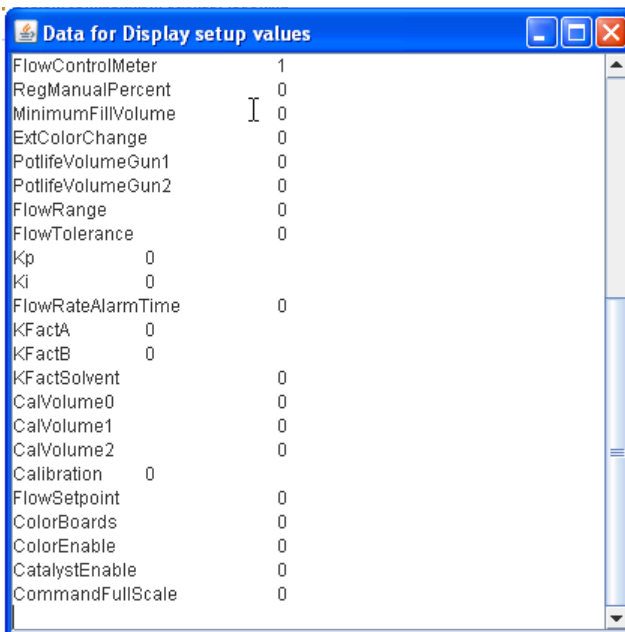

FIG. 9: Display Set Up

Download custom language - saves the current system language to the PC. See FIG. 10. This file is opened and a custom language added to the B column of the Excel file.

NOTE: Custom languages are limited to Ascii and Ascii extended characters and a maximum of 32 characters. Save the Excel file as a tab delineated file for uploading purposes.

Restore custom language - allows the custom language file to be uploaded to the ProMix 2KS/3KS.

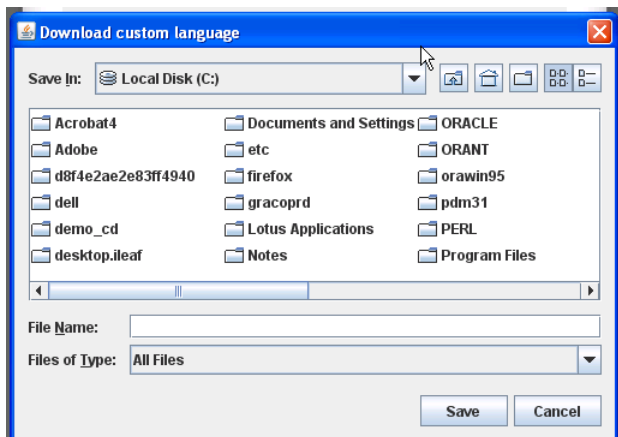

FIG. 10: Download Custom Language

End current job - ends a job and adds material to usage report. The screen will prompt for confirmation. See FIG. 11.

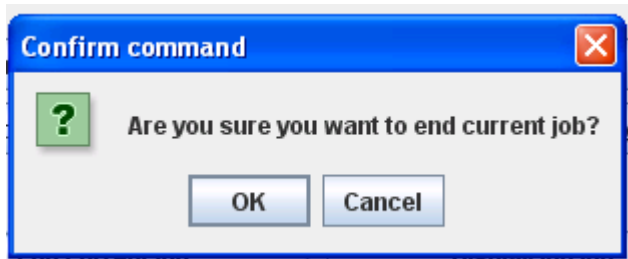

FIG. 11: End Current Job

Software/Resets

Install EasyKey software - installs firmware for the current device (approximately 6 minutes). See FIG. 12.

NOTE: If using the Graco Gateway in your system, disconnect its cable from the EasyKey before updating the ProMix 2KS/3KS software.

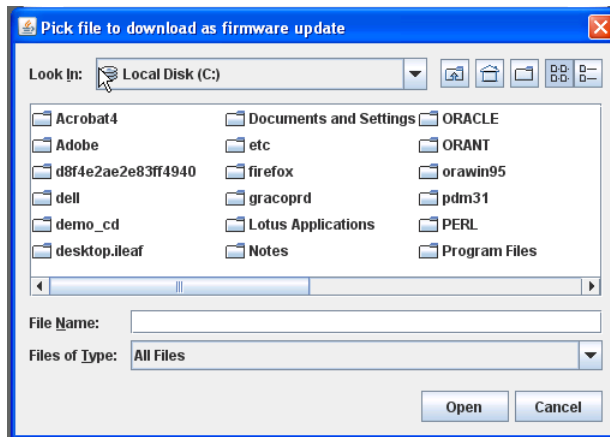

FIG. 12: Install EasyKey Software

Reset settings - places system back to factory default mode. The screen will prompt for confirmation. See FIG. 13.

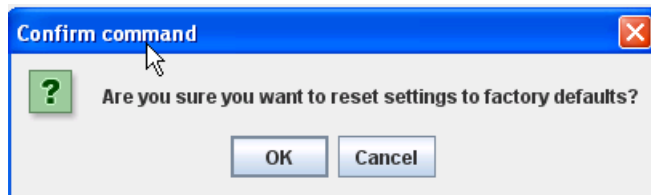

FIG. 13: Reset Settings

Reset password - clears password if lost or forgotten. The screen will prompt for confirmation. See FIG. 13.

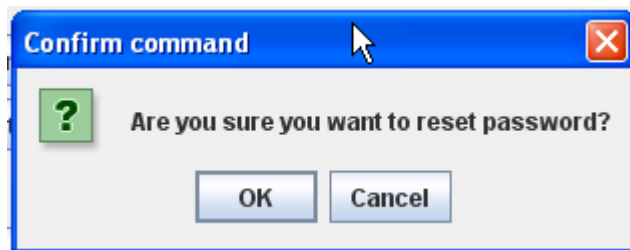

FIG. 14: Reset Password

Reports

NOTE: Display material usage report - shows the material sprayed from the ProMix 2KS/3KS. See FIG. 15.

Valve	Total (cc)	Description
1	0	Color 1
2	0	Color 2
3	0	Color 3
4	0	Color 4
5	0	Color 5
6	0	Color 6
7	0	Color 7
8	0	Color 8
9	0	Color 9
10	0	Color 10
11	0	Color 11
12	0	Color 12
13	0	Color 13
14	0	Color 14
15	0	Color 15
16	0	Color 16
17	0	Color 17
18	0	Color 18
19	0	Color 19
20	0	Color 20

FIG. 15: Display Material Usage Report

Clear material usage report - deletes the material usage from the display.

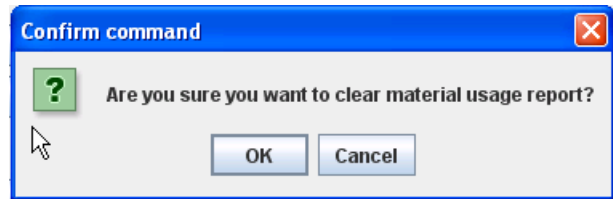

FIG. 16: Clear Material Usage Report

Download job log - downloads the job log to the PC.

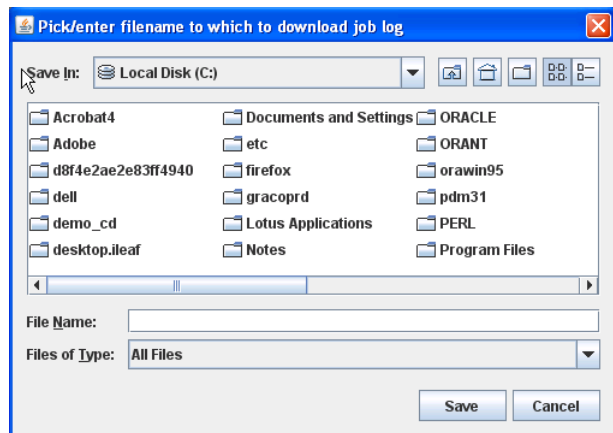

FIG. 17: Download Job Log

Download error log - downloads the error log to the PC.

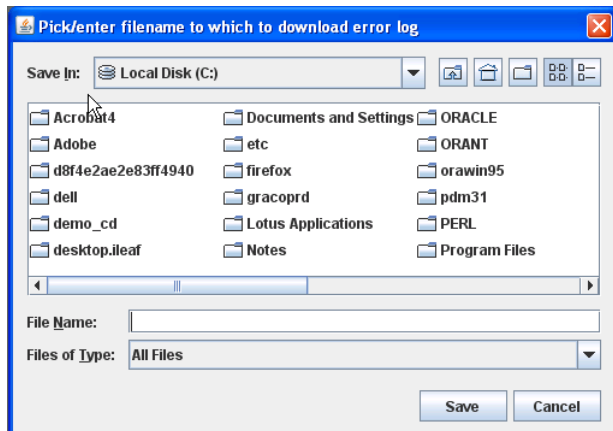

FIG. 18: Download Error Log

Display job log - displays the job number, date, time, recipe, ratio, target, volumes, grand totals, and any errors that occurred during the job. See FIG. 22.

Display error log - displays the number of alarms, date, time, recipe and what the error was. See FIG. 19.

Alarm	Date	Time	Recipe	Error
001	12-11-2008	12:14:30	0	E17
002	12-11-2008	08:52:38	0	E19
003	12-11-2008	08:52:30	0	E17
004	12-11-2008	08:52:38	0	E19
005	12-11-2008	08:49:39	255	E16
006	12-11-2008	08:44:18	0	E17
007	12-11-2008	08:44:18	0	E19
008	12-11-2008	08:42:30	0	E17
009	11-11-2008	21:34:35	0	E19

FIG. 19: Display Error Log

Clear job log - deletes the jobs from the display. The screen will prompt for confirmation. See FIG. 20.

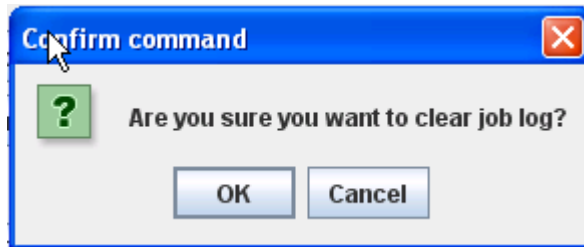

FIG. 20: Clear Job Log

Clear error log - deletes the errors from the display. The screen will prompt for confirmation. See FIG. 21.

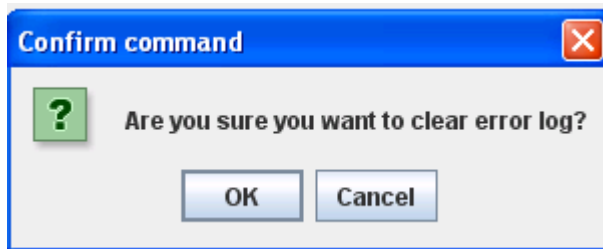

FIG. 21: Clear Error Log

Index	Job	Date	Time	Recipe	Ratio	Target	Vol A	Vol B	Vol Solvent
<p>NOTE: For ProMix 3KS, a column will appear for Vol C.</p> <p>Scroll to right to view Grand Totals and Errors</p>									

FIG. 22: Display Job Log

Install the Advanced Web Interface (AWI) Module

Overview

The Graco Advanced Web Interface (AWI) Accessory allows communication between multiple ProMix 2KS/3KS and a PC over an Ethernet, enabling users to monitor the ProMix 2KS/3KS, view and change system setup parameters, and create reports.

NOTE: Screen views in this manual are shown using Microsoft Windows XP.

Location

The AWI module may be installed in a local ProMix network (see FIG. 25) or in a LAN network (see FIG. 26).

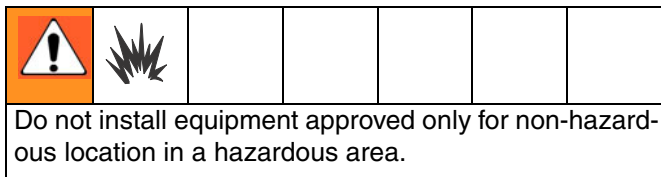

Install the module near the EasyKey, in a non-hazardous area.

Mounting

1. See **Dimensions**, page 41.
2. Ensure that the wall and mounting hardware are strong enough to support the weight of the equipment, fluid, hoses, and stress caused during operation.
3. Using the equipment as a template, mark the mounting holes on the wall at a convenient height for the operator and so equipment is easily accessible for maintenance.
4. Drill mounting holes in the wall. Install anchors as needed.
5. Bolt equipment securely.

Connect Module to EasyKey and PC

NOTICE

To avoid damaging circuit board when servicing, wear grounding strap on wrist and ground appropriately.

1. Shut off ProMix 2KS/3KS power (0 position). FIG. 23. Also shut off power at main circuit breaker.

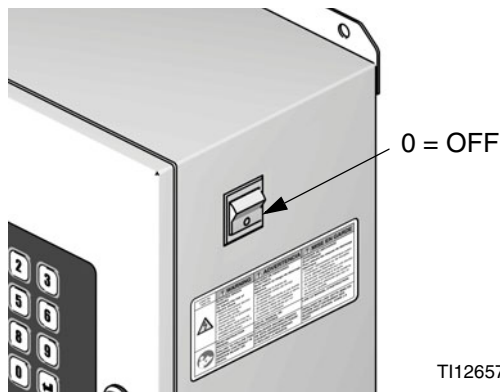
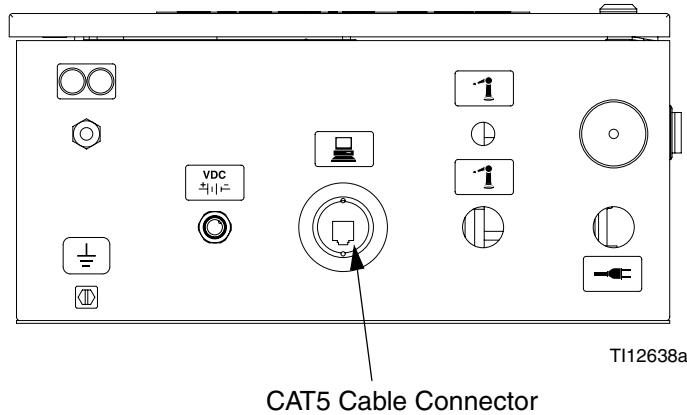

FIG. 23: Power Off

2. Run a CAT5 cable from the EasyKey connector through the grommet and connect it to any port in the AWI module. Connect another CAT5 cable from the AWI module to the PC. See FIG. 24.
3. Plug in the module power cord.

NOTE: Multiple AWI server hubs can be connected to the AWI master module in series. See FIG. 25. Order Part No. 15V336 Hub, see page 39.

EasyKey (Bottom View)



Advanced Web Interface Module

Connect CAT5 Cables to any ports on module

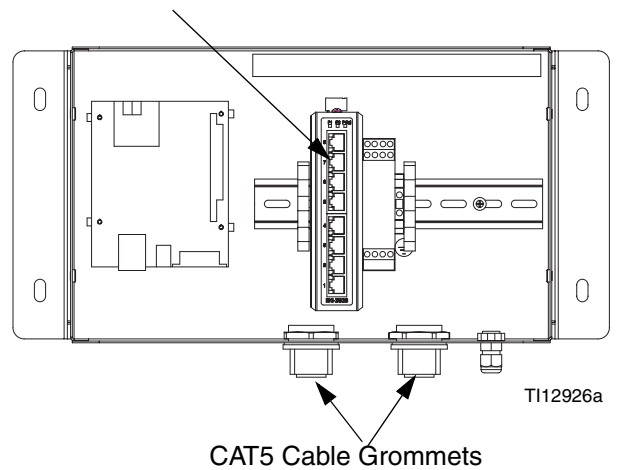
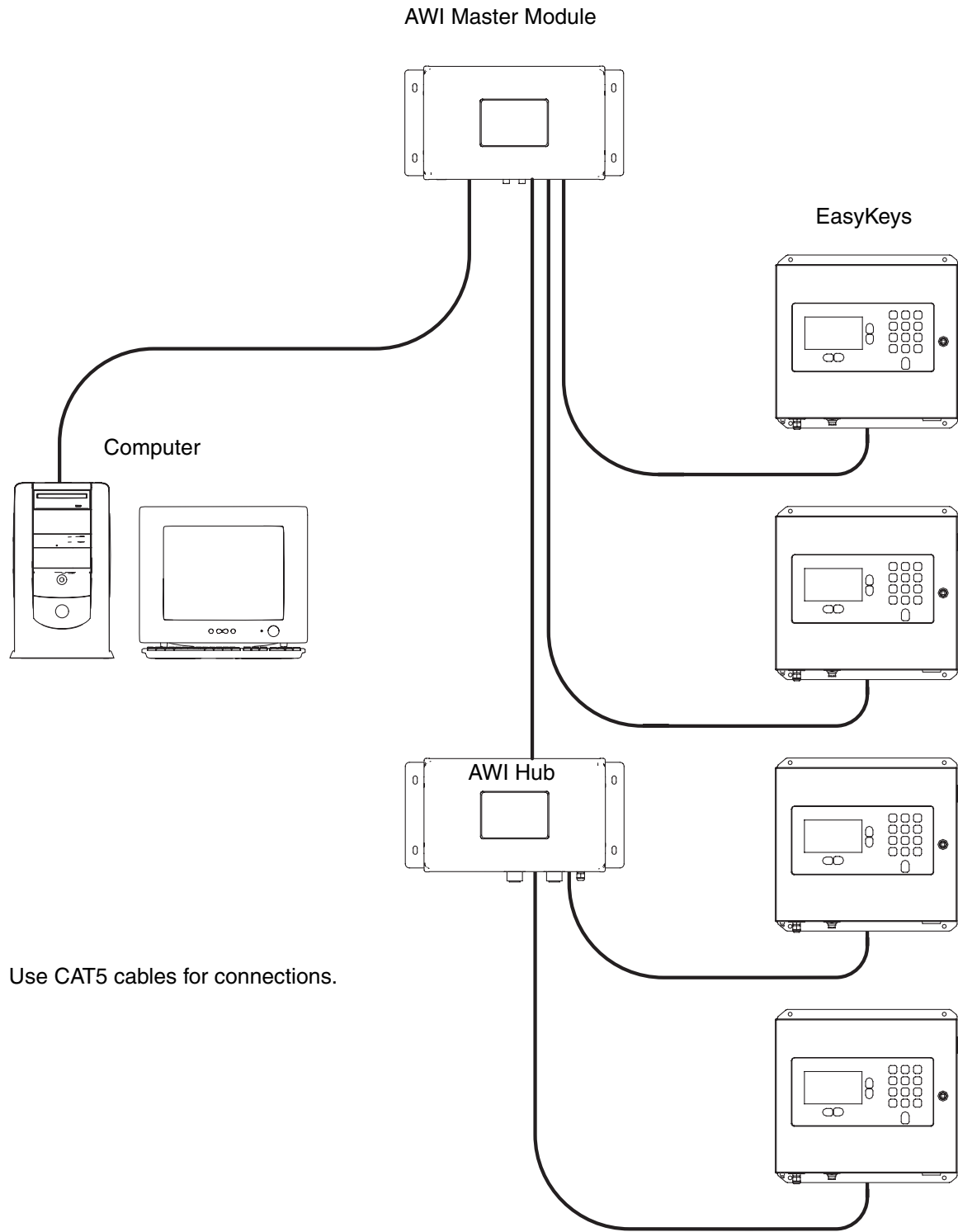

FIG. 24: EasyKey and Module Cable Connection Points



Use CAT5 cables for connections.

TI13065a

Fig. 25: ProMix Network Typical Installation

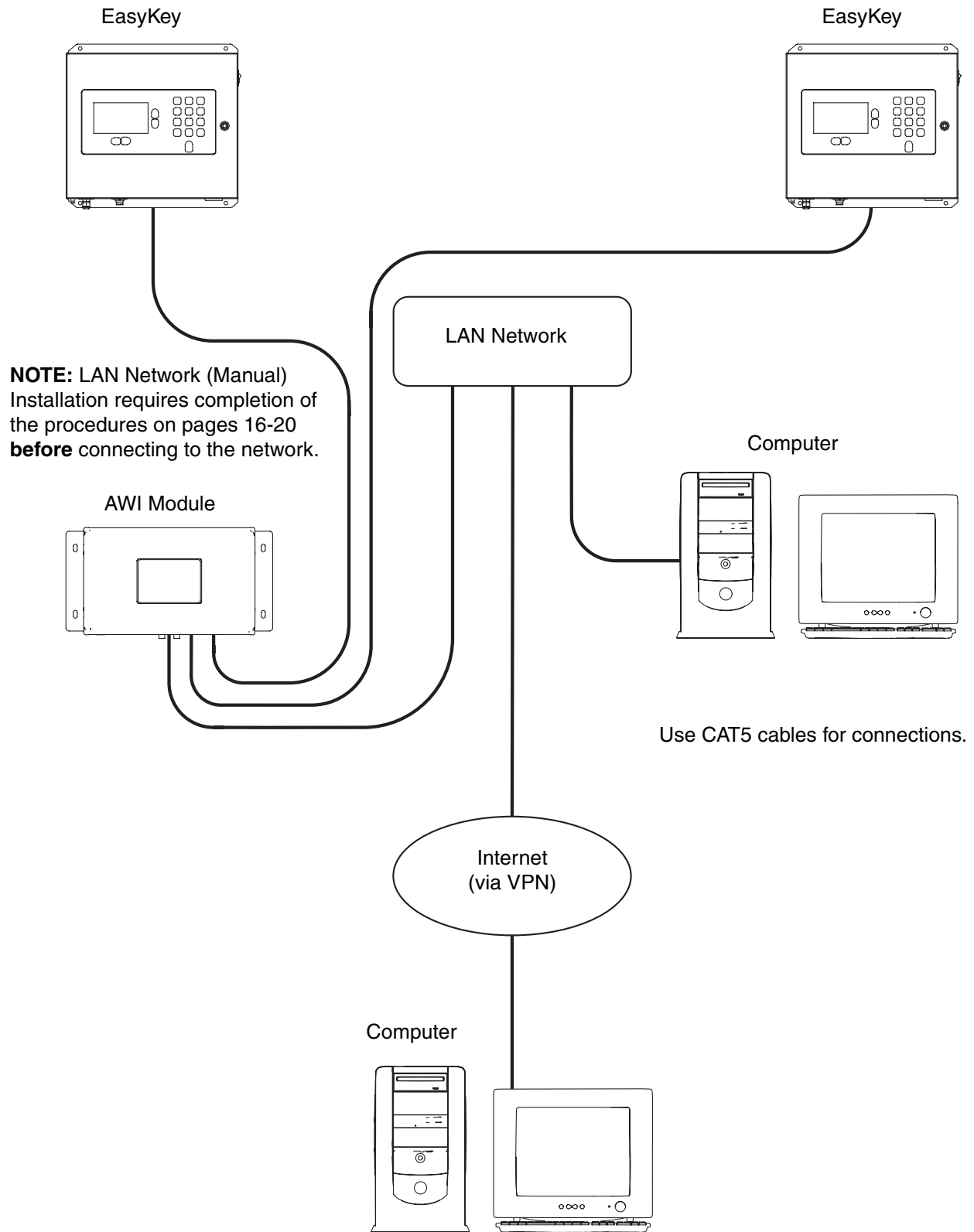

TI13064b

FIG. 26: LAN Network (Manual) Typical Installation

Computer Configuration

Set up an Automatic IP Address

See FIG. 27. On your computer, go to Control Panel>Network Connections>Local Area Connection>Properties>Internet Protocol (TCP/IP). Verify that “Obtain an IP address automatically” is selected in the TCP/IP Properties window. If not, set it as shown. Click OK and close out of the Control Panel.

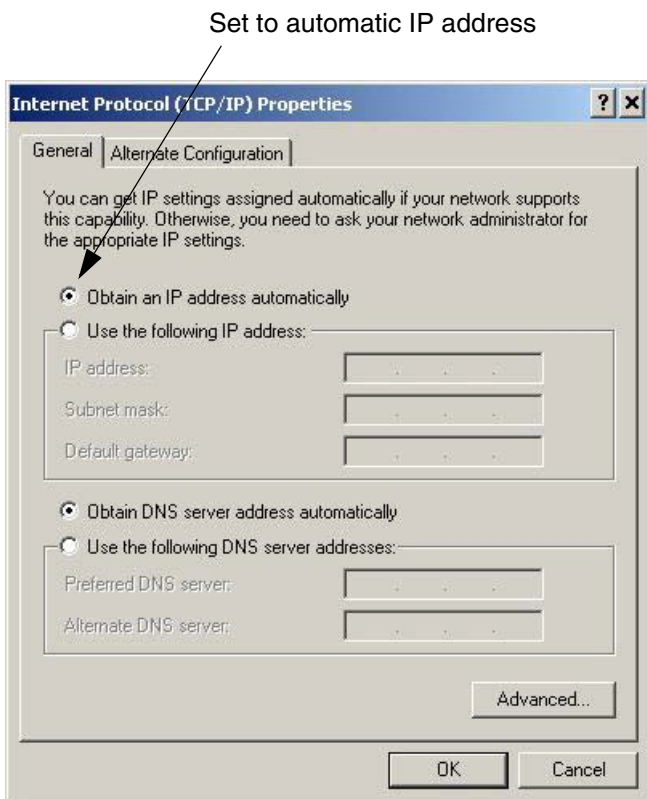

FIG. 27. Set Automatic IP Address

System Initialization

NOTE: System initialization must be done by an administrator. This process is only required when the system is first started.

NOTE: Verify that the wireless connection is turned off (disabled) before performing step 1.

1. Open a browser. Firefox 3.0 or above is preferred. Microsoft Internet Explorer 6.0 or above is also acceptable.
2. *Applies to Firefox only:* To operate in a ProMix 2KS/3KS network with Firefox, you must turn off the Proxy setting on your browser. In your Firefox browser, go to Tools>Options>Advanced>Network tab>Connection Settings. Click “No proxy.” See FIG. 28.

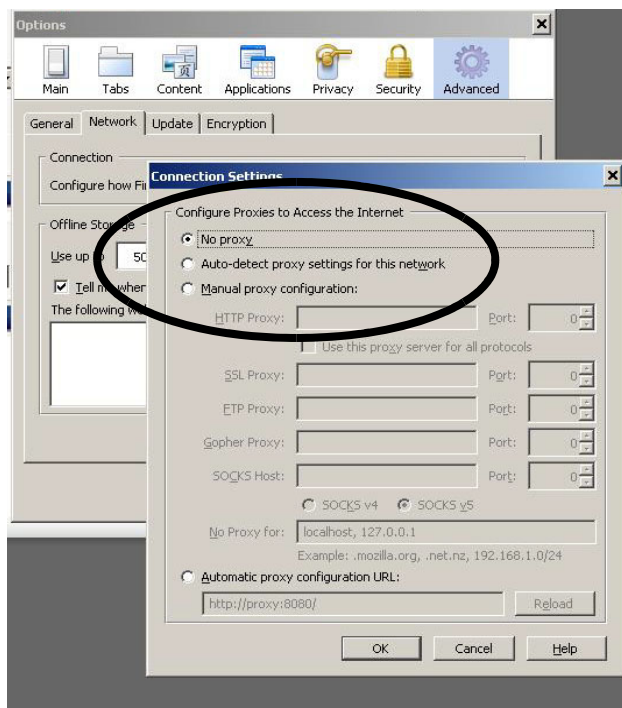

FIG. 28. Turn Off Proxy Setting (Firefox only)

3. Type **http://gracoawi:** in the browser address bar, and press Enter.

- The Welcome screen will appear. See FIG. 29. Click Next.



FIG. 29. System Initialization Step 1

- The Security screen will appear. See FIG. 30. The administrator must fill in all fields. Click Next.



FIG. 30. System Initialization Step 2

- Initialization is complete. See FIG. 31. Click Finish.



FIG. 31. System Initialization Step 3

- The Login screen will appear. See FIG. 32. Type in the login name and password you entered in step 5. Click Sign in. The Network screen will appear. See page 21.



FIG. 32. Login Screen

Password Recovery

1. If you type in the wrong password, sign in will be blocked. See FIG. 33. Click on the block icon  to initiate the password recovery sequence.



Click on block icon

FIG. 33. Sign in Blocked

2. See FIG. 34. The system will prompt you for your login name. Type in the name you entered in step 5 on page 17, then click Next.

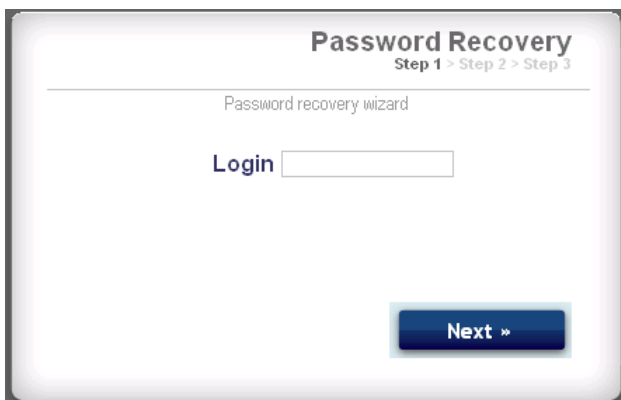

FIG. 34. Password Recovery Step 1

3. The system will then ask the secret question you entered in step 5. Type in the answer, then click Next.

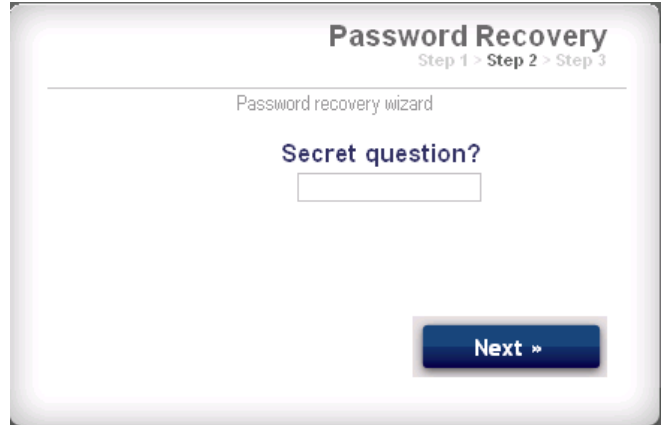

FIG. 35. Password Recovery Step 2

4. If the answer matches the one entered in step 5, the system will prompt you for a new password. Enter the new password twice, then click Next. The system will return to the Login screen, FIG. 32.

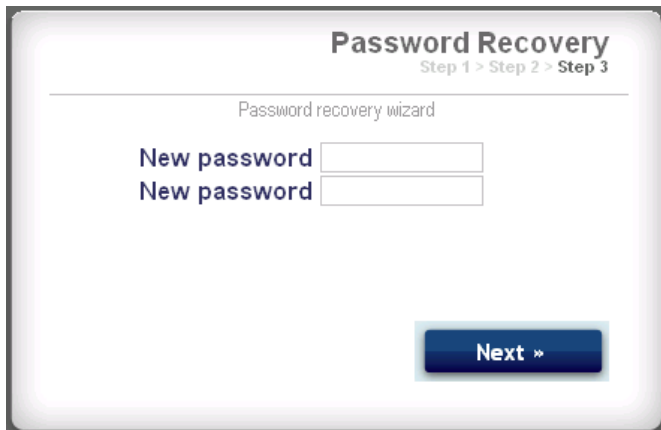

FIG. 36. Password Recovery Step 3

Set the Network Configuration

ProMix 2KS/3KS Network Configuration

In a ProMix 2KS/3KS network, the AWI module is connected to an EasyKey and a personal computer. Up to 100 EasyKeys may be connected in the network. See FIG. 25.

To select a ProMix 2KS/3KS network, go to the Settings tab and select ProMix network. See FIG. 37.

Click Save.

Turn off the Proxy setting (Firefox only). See page 16.

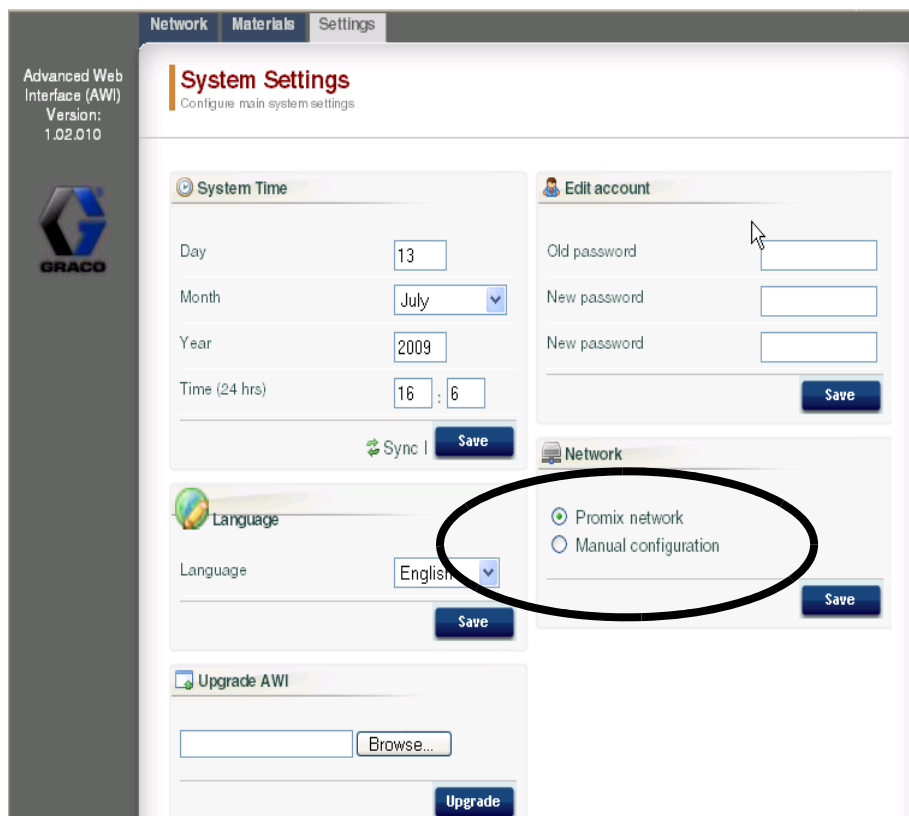

FIG. 37. ProMix 2KS/3KS Network Setting

LAN Network (Manual) Configuration

See FIG. 26. A LAN network (manual) configuration enables you to work through a local network. Up to 100 EasyKeys may be connected in the network. The EasyKeys and AWI Module **must** be on the same sub-network. The EasyKeys can be connected to any LAN drop.

NOTE: To change to a LAN (manual) configuration, you must first connect to the AWI via the ProMix 2KS/3KS network. See pages 16-17 for instructions and FIG. 25 for cable connections.

To select a LAN (manual) configuration, go to the Settings tab and select Manual configuration. You will be required to enter IP, gateway, and Netmask addresses. Contact your IS system administrator for assistance. See FIG. 38.

NOTE: Use a new IP address to access the AWI; this replaces gracoawi (for LAN network systems only).

NOTE: Once Save is clicked, the AWI will disconnect the user computer. Reconnect the AWI and computer as shown in FIG. 26. Reconfigure the user computer to match the new LAN configuration. You can then login to the AWI using the newly assigned IP address.

Click Save to apply the change.

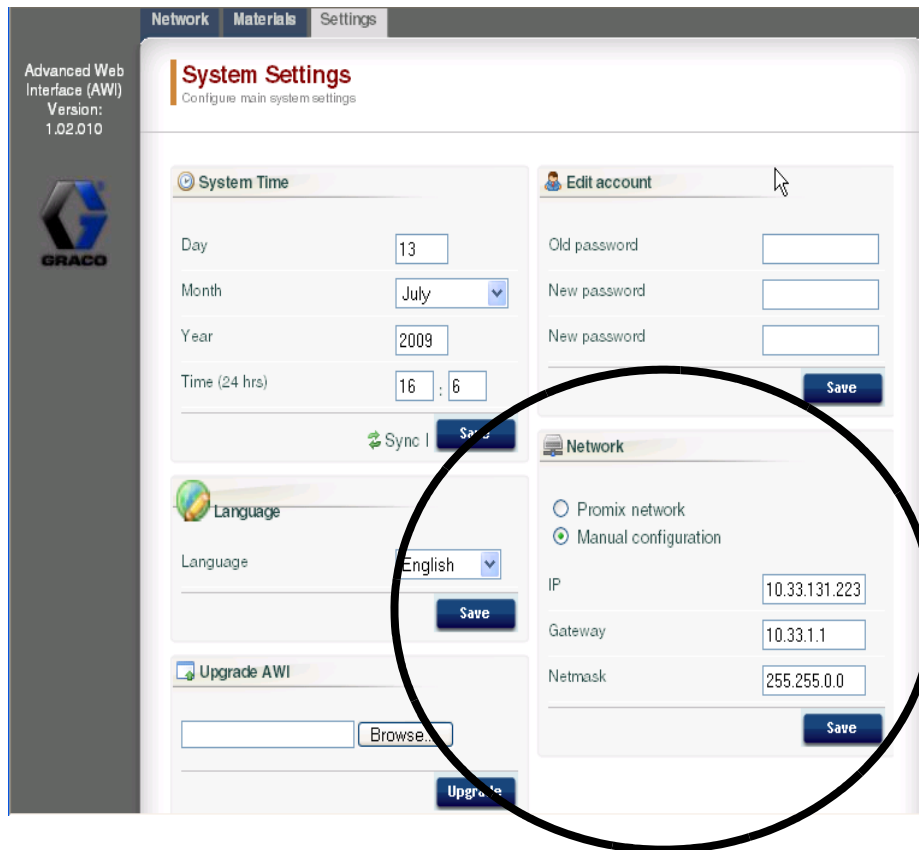

FIG. 38. LAN Network Setting

AWI Screens

This section describes how to use the AWI screens to access and make changes to system settings and recipes. For complete information about these settings and their effects, see the Setup section in the system operation manual.

Network Tab

Use the Network tab to select the desired EasyKey. See FIG. 39.

Each EasyKey must have a unique name and IP address. See the Configuration Screen in FIG. 46 to set the Station name (1-99).

Click on the desired EasyKey to access the setup screens for that device.

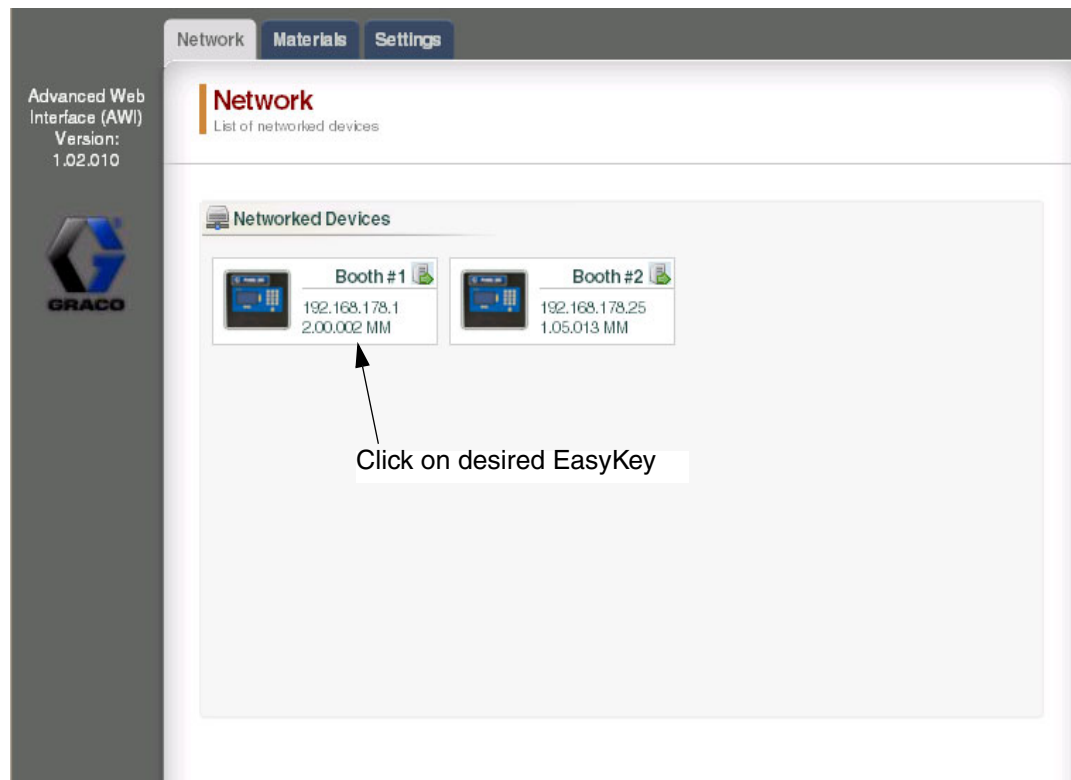



FIG. 39. Network Tab

Materials Tab

Use the Materials tab to enter information on Volatile Components (VOC) and Hazardous Air Pollutants (HAP) for each material being used in your system, for material reporting. This information, and the manufacturer's part no., are available on the MSDS sheet provided by the material manufacturer. See FIG. 40.

VOC values may be set at Lbs/Gal or Gram/Liter as desired, using the pulldown menu.

To add a new material, click the Plus  button. Enter the values in the new data fields.

To delete a material, click the Minus  button.

To save your changes, click . A checkmark (✓) will appear when the save is complete.

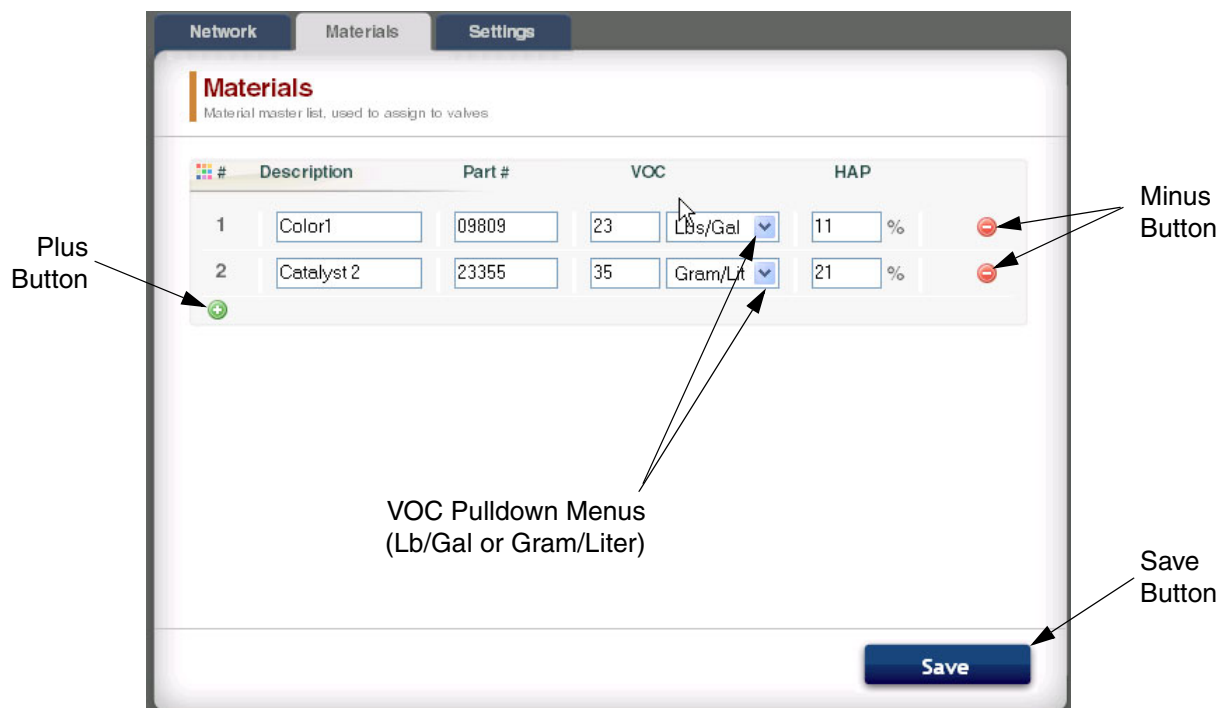



FIG. 40. Materials Tab

Settings Tab

Use the Settings tab to configure the main system settings (Time, Language, Upgrade AWI, and Edit Accounts).

NOTE: FIG. 41 shows the Settings screen when you log in as a user. FIG. 42 shows the Settings screen when you log in as a system administrator.

Set Time

To synchronize the time settings on all networked Pro-Mix 2KS/3KS devices, click the Sync  Sync button. The change will take place in approximately one minute.

Set Language

Set the desired language of the screen text, using the pull-down menu. Select English (default), Spanish, French, German, Italian, Dutch, Japanese (Kanji), Korean, and Chinese (Simplified).

Upgrade AWI Software

To upgrade AWI, first download the latest version of AWI software to your computer. Contact your Graco distributor for information.

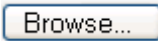
Use the Browse  button to locate the file on your computer. Highlight the filename.

Click on the Upgrade  button to start the upgrade.

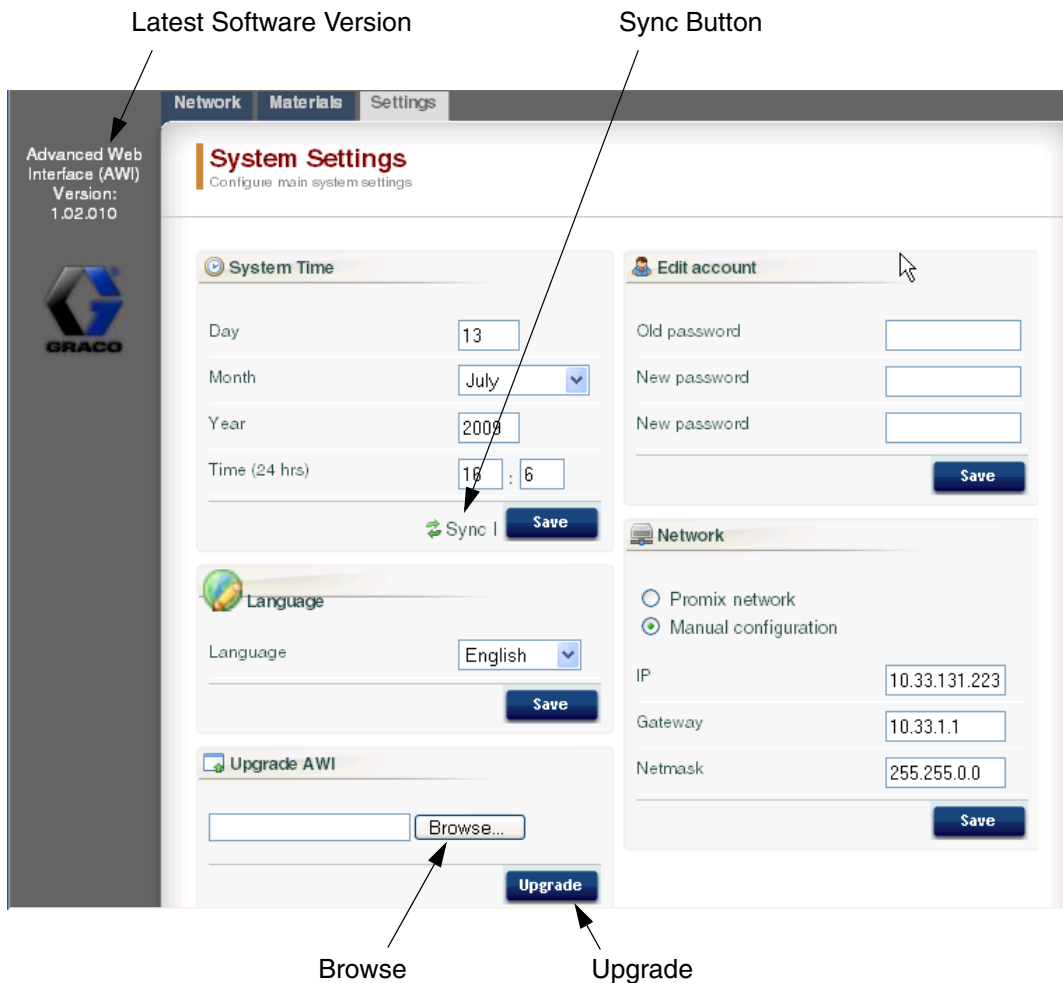







FIG. 41. System Settings Tab (User Screen Shown)

Edit Account Information

NOTE: Account information can only be entered by a system administrator. See FIG. 42.

- To add a new account, click the Add User  button. Enter the information in the data fields. Click . A checkmark (✓) will appear in the top right corner when the save is complete.

- To edit an existing account, click the Edit User  button. Enter the information in the data fields. Click . A checkmark (✓) will appear the top right corner when the save is complete.
- To delete an existing account, click the Delete User  button.

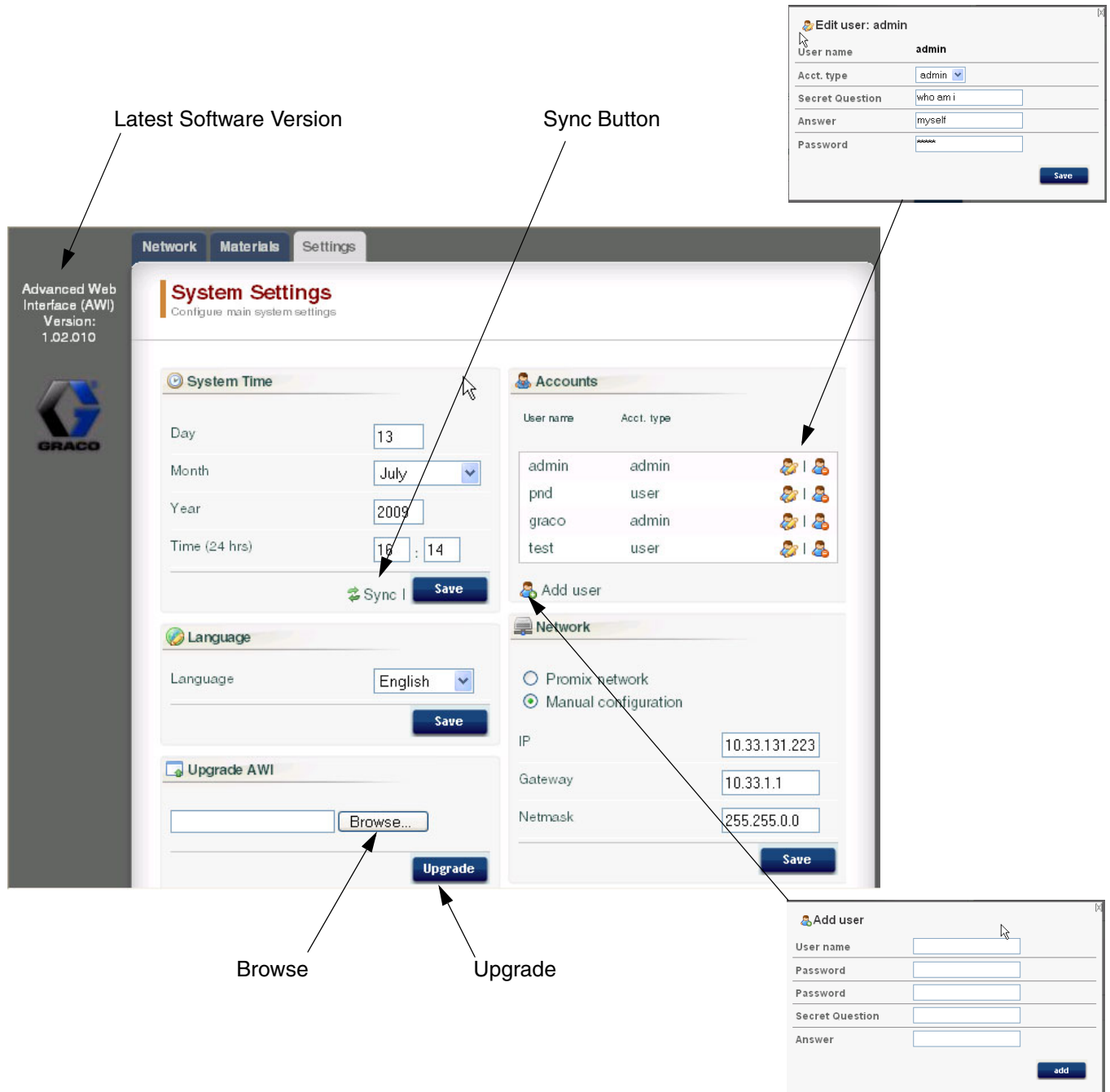
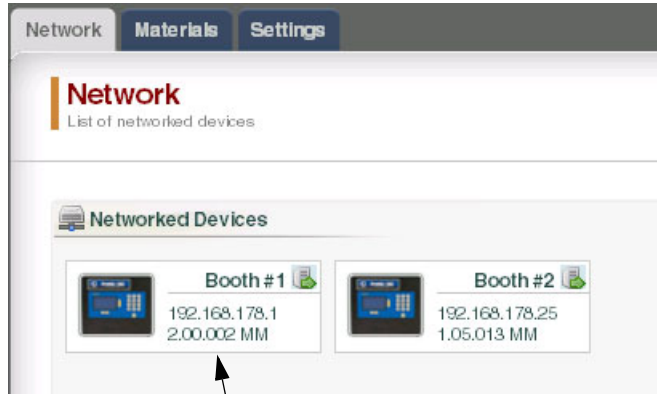

FIG. 42. System Settings Tab (Admin Screen Shown)

System Setup Screens

To view the system setup screens, go to the Network tab and click on the desired EasyKey to access the setup screens for that device. See FIG. 43.



Click on desired EasyKey

FIG. 43. Open Device

Monitor Tab

Select the Monitor tab to view data from the EasyKey Status screen, in real time. See FIG. 44.

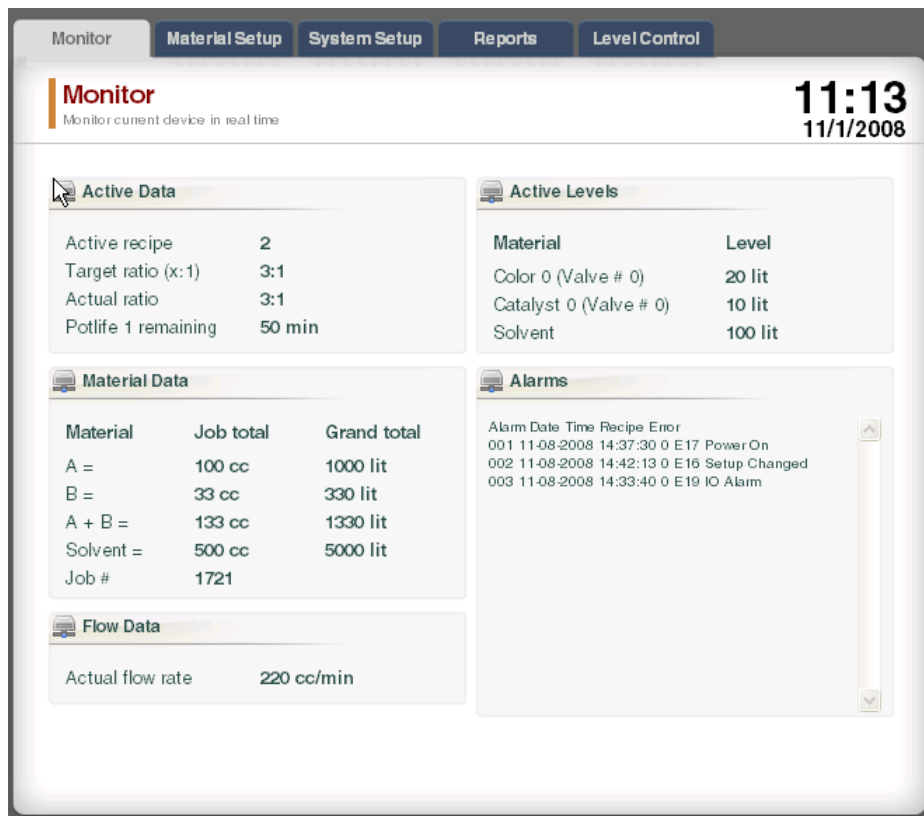
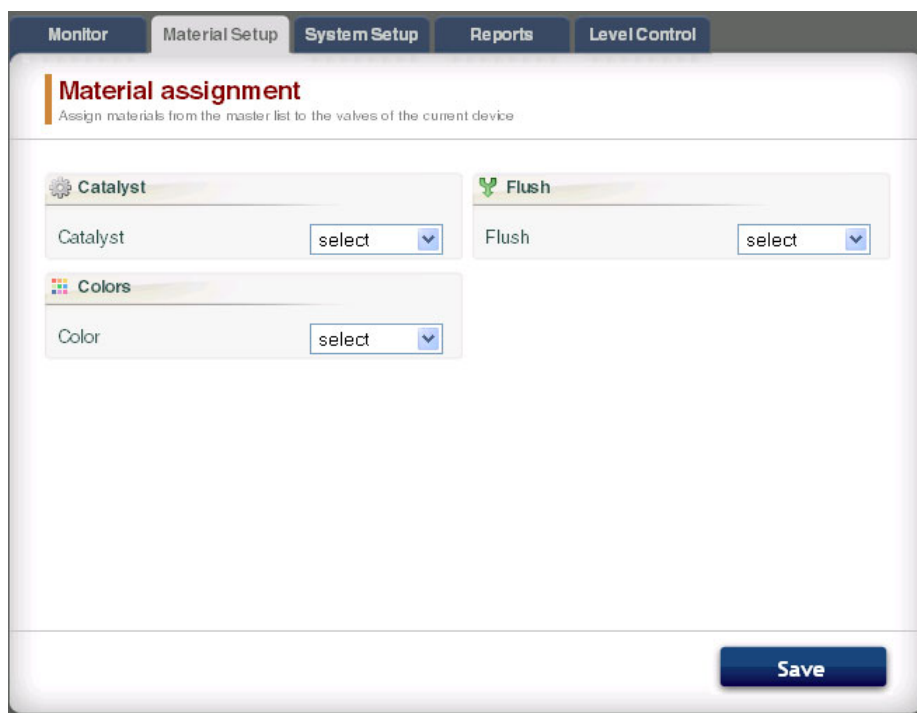

FIG. 44. Monitor Tab

Material Setup Tab

Go to the Material Setup tab to assign a catalyst, color, reducer (on 3KS) and flush material for the valves of the active device, using the pulldown menus. For 2KS, each device may include up to 30 color valves, 4 catalyst valves, and solvent flush valves. For 3KS, each device may include up to 25 color valves, 4 catalyst valves, 4 reducer valves, and solvent flush valves. The materials listed in each pulldown menu were established under the **Materials Tab** on page 22. See FIG. 45.

To save your changes, click . A checkmark (✓) will appear when the save is complete.



Monitor Material Setup System Setup Reports Level Control

Material assignment

Assign materials from the master list to the valves of the current device

Catalyst
Catalyst select

Flush
Flush select

Colors
Color select



Save

FIG. 45. Material Setup Tab

System Setup Tab

The Setup tab has three editable screens:

- The **Configuration** screen corresponds to the System Configuration screens of the EasyKey. See FIG. 46. For complete information about these settings and their effects, see the Setup section in the system operation manual.
- The **Advanced** screen corresponds to the Advanced Setup screens of the EasyKey. See FIG. 47. For complete information about these settings and their effects, see the Setup section in the system operation manual.
- The **Recipe** screen corresponds to the Recipe Setup screens of the EasyKey. See FIG. 48. For complete information about these settings and their effects, see the Setup section in the system operation manual.

Use the arrow buttons   to view the previous or the next recipe, or enter the recipe number and press Enter.

Click on the Chart button  to create a timing chart of the active recipe. See FIG. 49.

To save your changes, click . A checkmark (✓) will appear when the save is complete.

NOTE: Changes made on the EasyKey screen before clicking  will be overwritten by the AWI data.

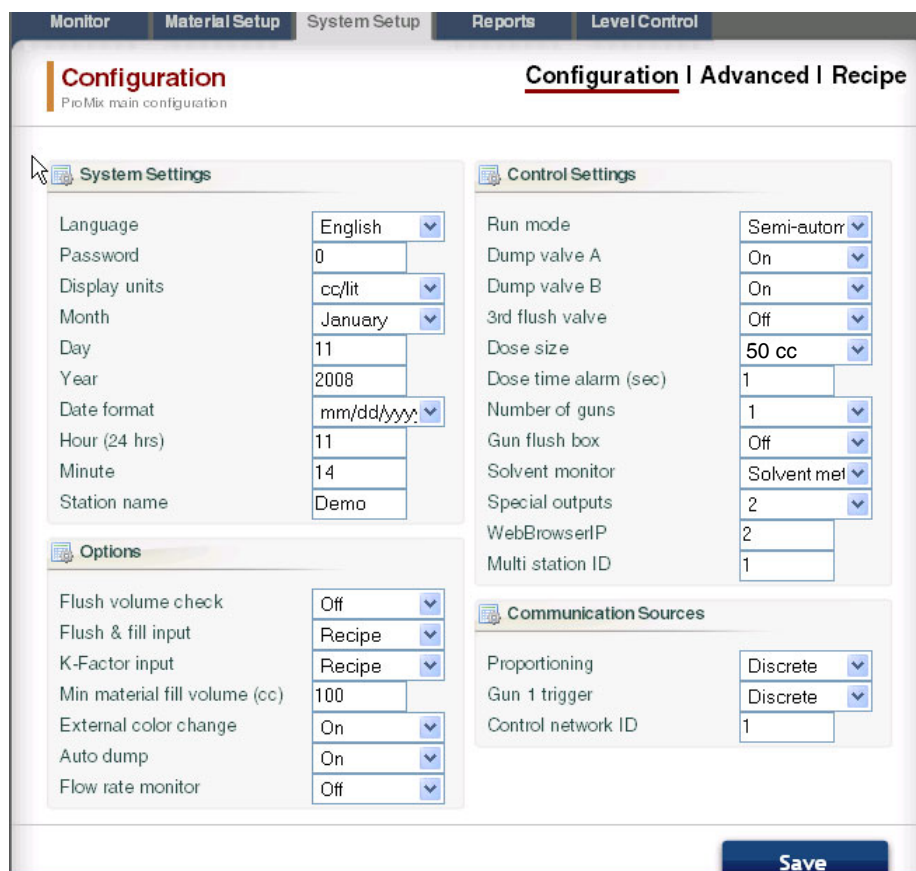

Section	Setting	Value
System Settings	Language	English
	Password	0
	Display units	cc/lit
	Month	January
	Day	11
	Year	2008
	Date format	mm/dd/yyyy
	Hour (24 hrs)	11
	Minute	14
	Station name	Demo
Control Settings	Run mode	Semi-autom
	Dump valve A	On
	Dump valve B	On
	3rd flush valve	Off
	Dose size	50 cc
	Dose time alarm (sec)	1
	Number of guns	1
	Gun flush box	Off
	Solvent monitor	Solvent mel
	Special outputs	2
Options	Flush volume check	Off
	Flush & fill input	Recipe
	K-Factor input	Recipe
	Min material fill volume (cc)	100
	External color change	On
Communication Sources	Proportioning	Discrete
	Gun 1 trigger	Discrete
WebBrowserIP		2
Multi station ID		1
Control network ID		1

FIG. 46. System Setup Tab, Configuration Screen

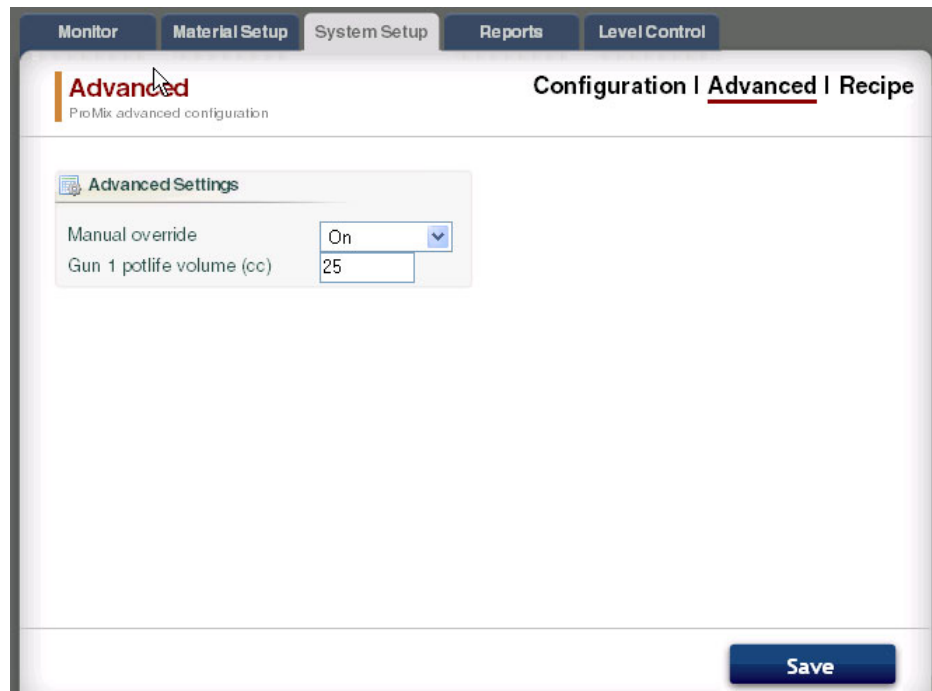
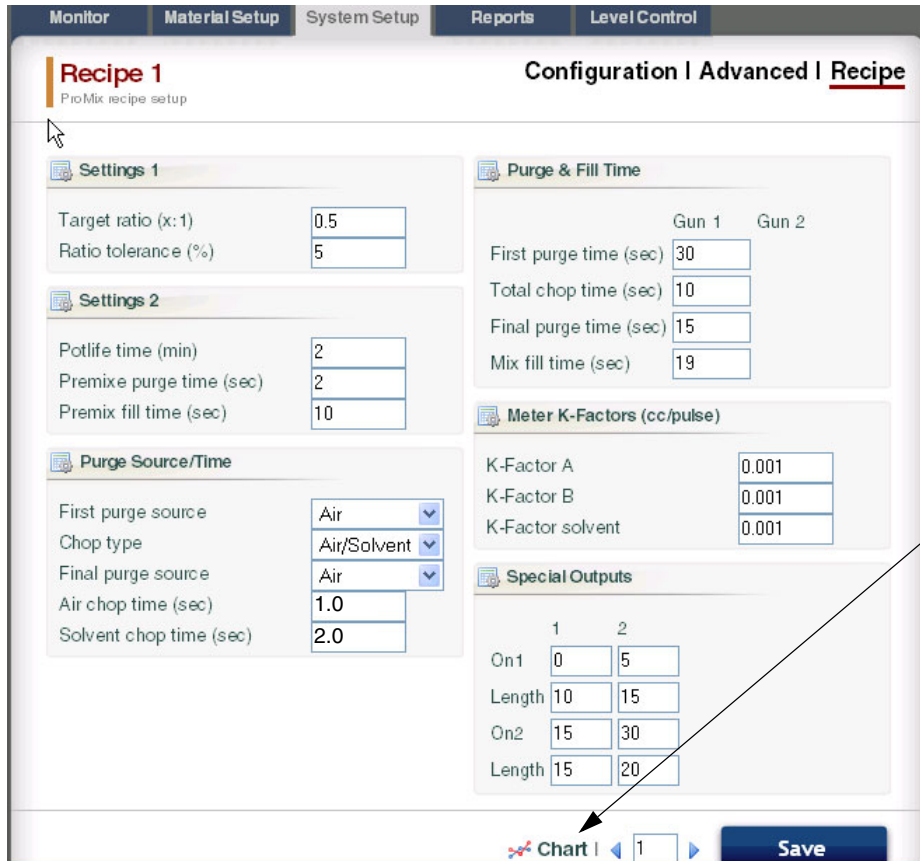

FIG. 47. System Setup Tab, Advanced Screen



Click to create a recipe timing chart. See FIG. 49.

FIG. 48. System Setup Tab, Recipe Screen

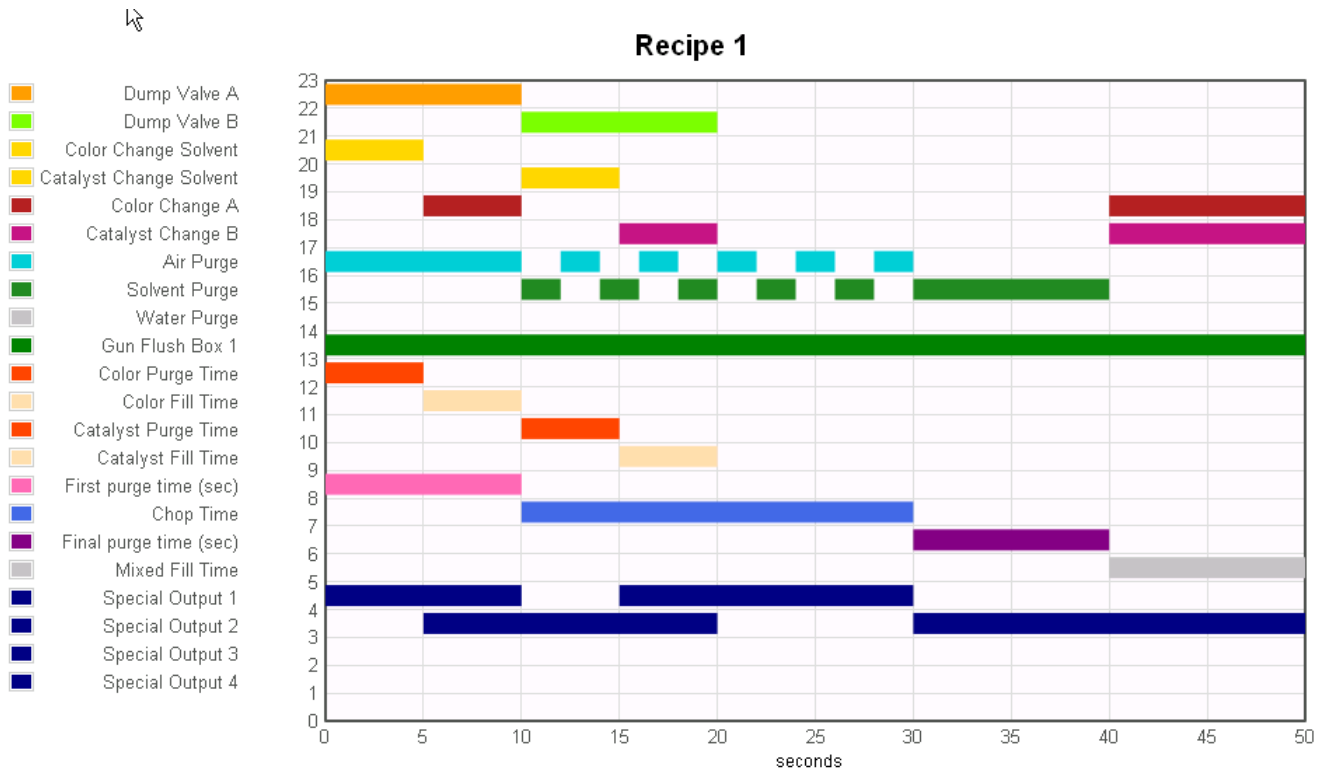

FIG. 49. Sample Recipe Timing Chart

Reports Tab

The Reports tab enables you to produce three reports:

- Material Report
- Job Report
- Alarm Report

Select which of the three reports you want to create.

Click the desired output format CSV TXT for the report:

- CSV (can be imported into Microsoft Excel).
- TXT (straight text).

Click the Create button **Create** to generate the report.

Material Report

See FIG. 50. The Material Report compiles VOC and HAP data for all recipes and jobs using a material, and the total amount of material used. The material must be assigned to a valve to be included in the report (see page 27).

Click the Reset button **Reset** to begin a new report cycle (usually monthly).

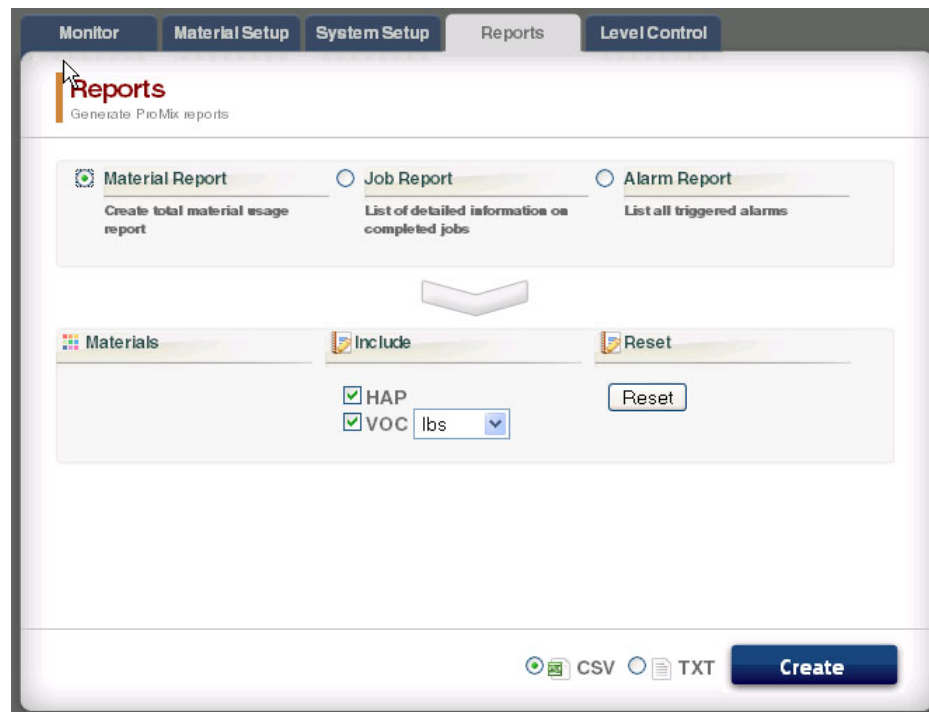



FIG. 50. Material Report Screen

Job Report

See FIG. 51. The Job Report provides detailed information on all completed jobs within a designated time period.

Select the information desired by clicking on the box to the left of each parameter.

Set the time frame by using the Calendar buttons  to the right of each date box.

NOTE: The dates use the day/month/year format.

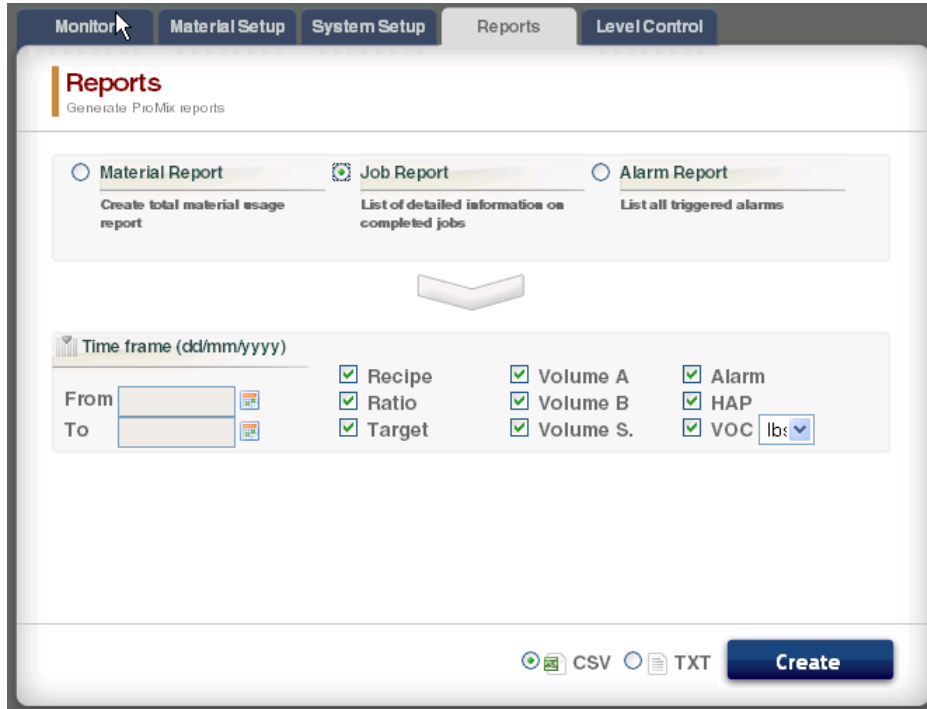



FIG. 51. Job Report Screen

Alarm Report

See FIG. 52. The Alarm Report lists all alarms triggered within a designated time period.

Set the time frame by using the Calendar buttons  to the right of each date box.

NOTE: The dates use the day/month/year format.

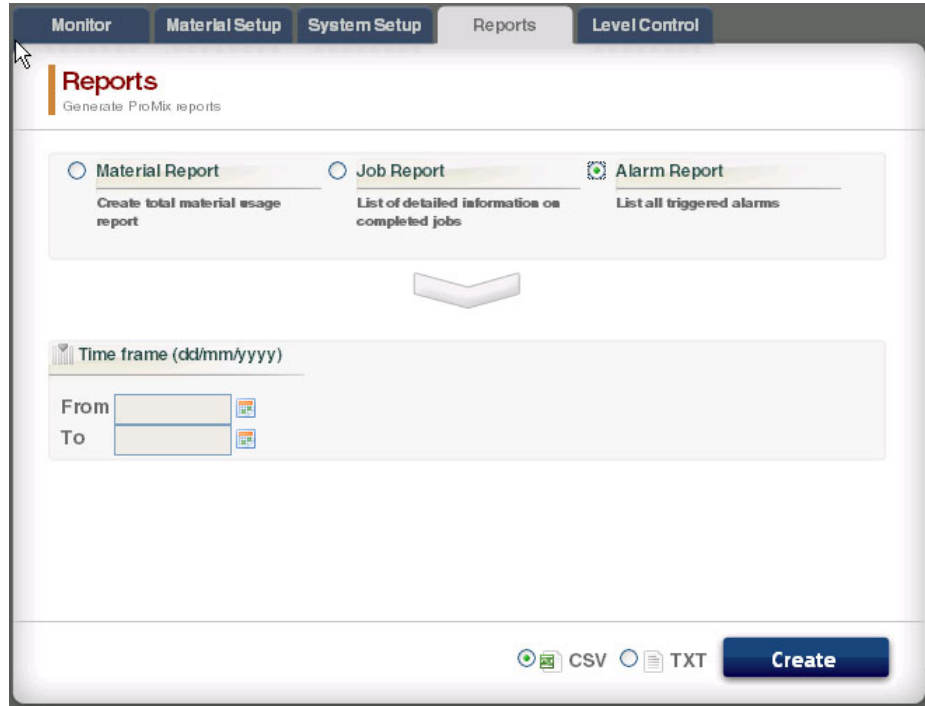

Monitor Material Setup System Setup Reports Level Control

Reports

Generate ProMix reports

Material Report
Create total material usage report

Job Report
List of detailed information on completed jobs

Alarm Report
List all triggered alarms

Time frame (dd/mm/yyyy)

From 

To 

CSV TXT

FIG. 52. Alarm Report Screen

Level Control Tab

See FIG. 53. The Level Control Tab allows you to input the supply tank volume of the materials and the level at which an alarm should be triggered.

The alarm function may be turned on or off for each material valve.

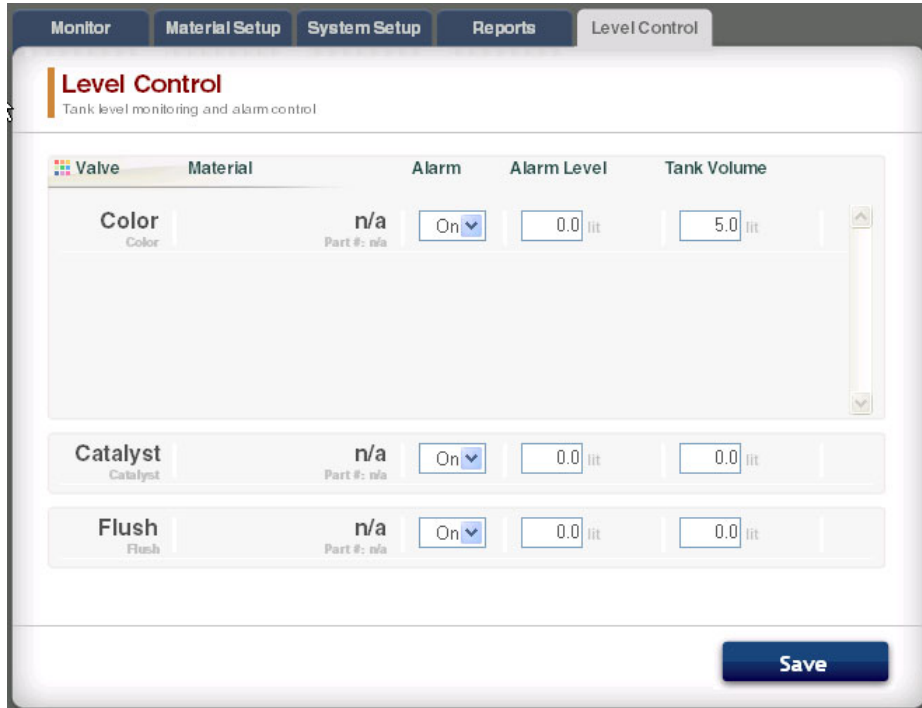

FIG. 53. Level Control Tab

Sidebar

See FIG. 54. The Sidebar relates to the EasyKey being monitored. It has four links to related screens:

- Save - saves the current device configuration into a file.

- Restore - restores configurations of the device from a file.
- Copy (Sync Settings)- copies the configuration of this device into other devices.
- Install Firmware - install firmware for the current device (approximately 5 minutes).

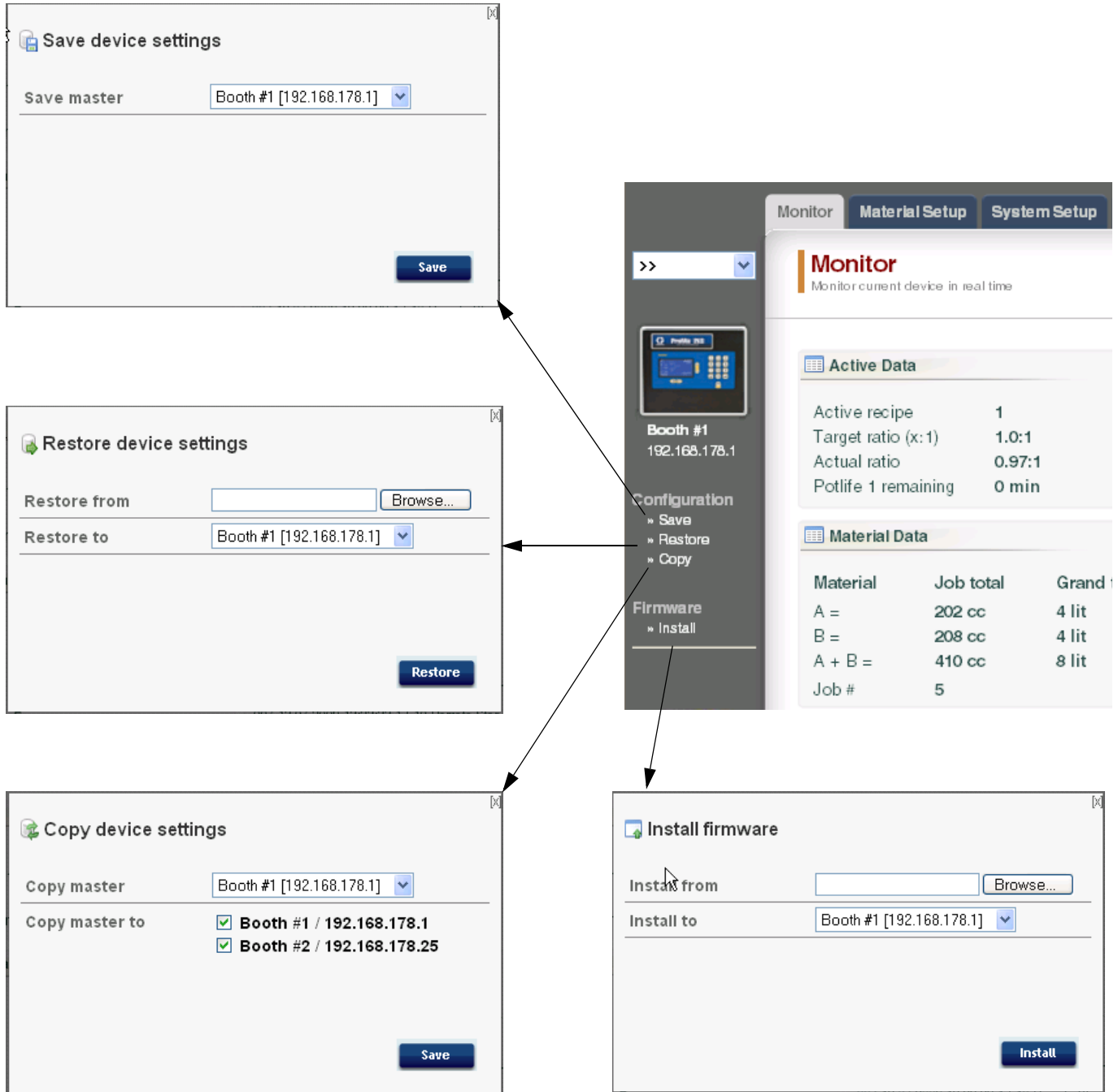



FIG. 54. Sidebar and Related Screens

Replace AWI Board

						
<ul style="list-style-type: none">• To avoid electric shock, turn off EasyKey power before servicing.• Shut off power at main circuit breaker.• All electrical wiring must be done by a qualified electrician and comply with all local codes and regulations.• Read Warnings, page 3.						

NOTICE

To avoid damaging circuit board when servicing, wear Part No. 112190 grounding strap on wrist and ground appropriately.

1. Shut off ProMix 2KS/3KS power (0 position).
2. Shut off power at main circuit breaker.
3. Open the AWI module.
4. Disconnect the cable (15) and wires (17, 18) from the board (22). FIG. 55.
5. Remove the screws (21) and board (22).
6. Install the new board. Reconnect the cable (15) and wires (17, 18).

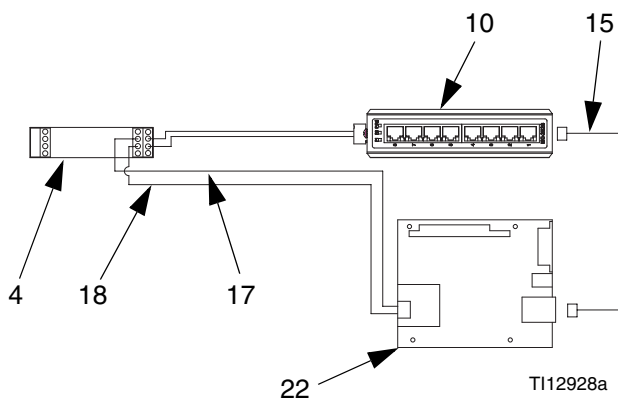
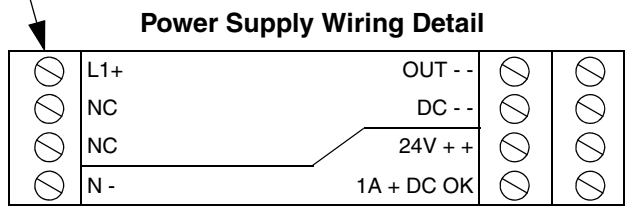
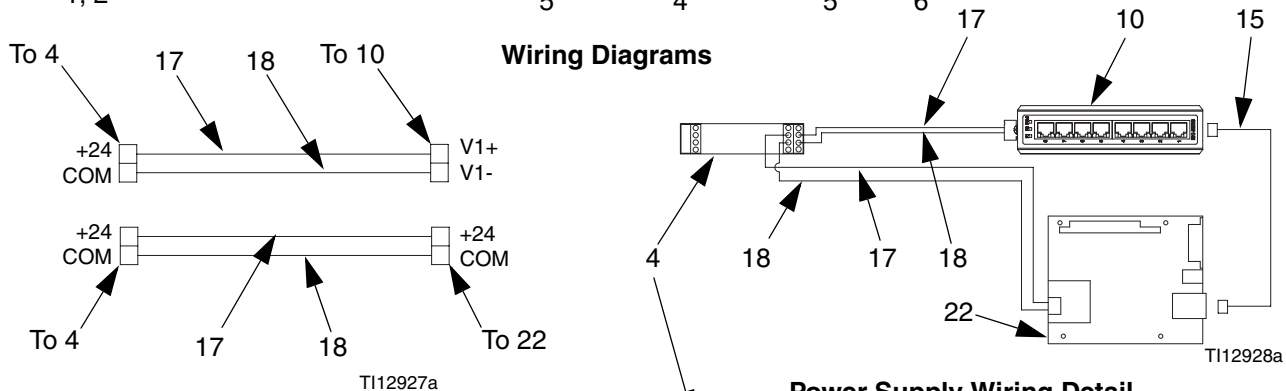
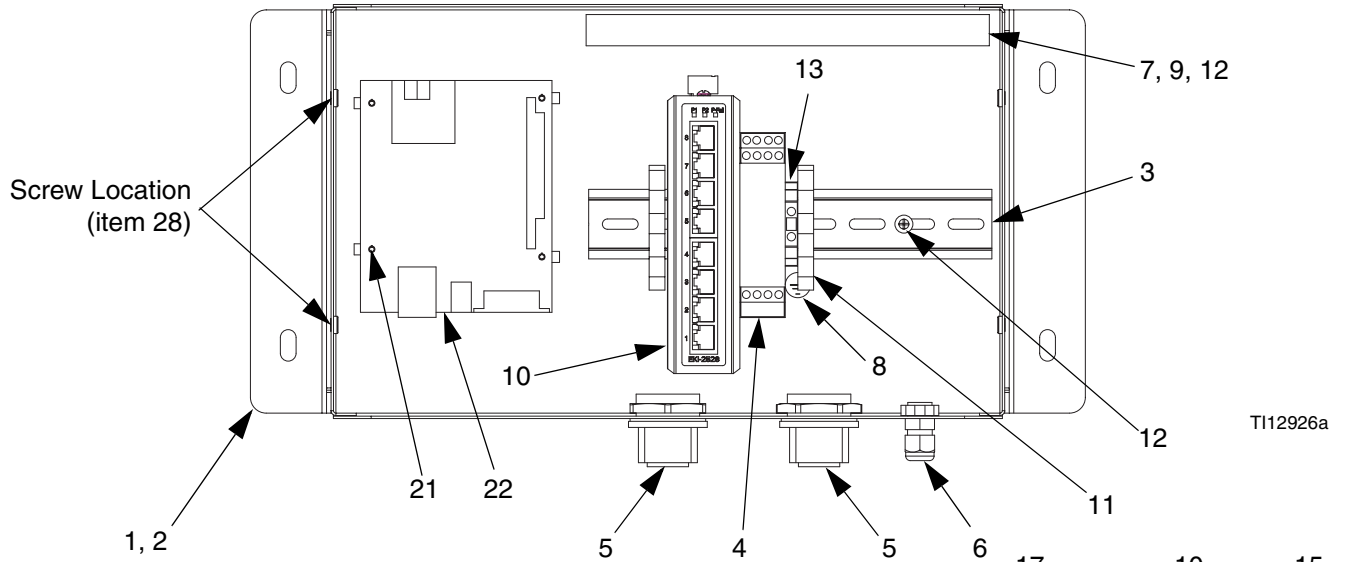

FIG. 55. Replace AWI Board

Parts

15V337 Advanced Web Interface Module



Ref. No.	Part No.	Description	Qty
1	15V339	PANEL, back	1
2	15T752	COVER	1
3	n/a	DIN RAIL	1
4	120369	POWER SUPPLY, 24 Vdc	1
5	15V345	GROMMET, cable entry	2
6	111987	CONNECTOR, strain relief	1
7	n/a	WIREWAY	1
8	186620	LABEL, ground	1
9	n/a	COVER, wireway	1
10	15V342	SWITCH, ethernet	1
11	120838	BLOCK, clamp end	2

Ref. No.	Part No.	Description	Qty
12	103833	SCREW, machine	4
13	112443	BLOCK, terminal, ground	1
15	121994	CABLE, CAT5	1
17	n/a	WIRE, copper, 16 ga.; 9 in. (230 mm)	1
18	n/a	WIRE, copper, 16 ga; 9 in. (230 mm)	1
21	15V340	STANDOFF, board	4
22	258355	BOARD, server	1
28	n/a	SCREW, machine, serrated hex-head	4

Parts labeled n/a are not available separately.

15V336 Advanced Web Interface Server Hub

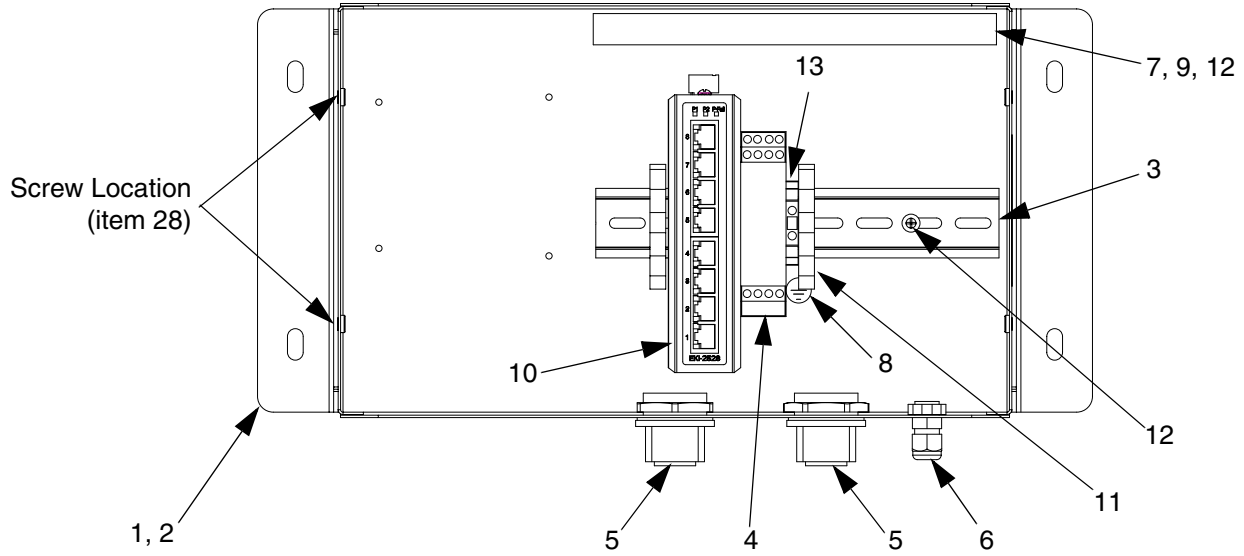

TI13204a

Wiring Diagrams

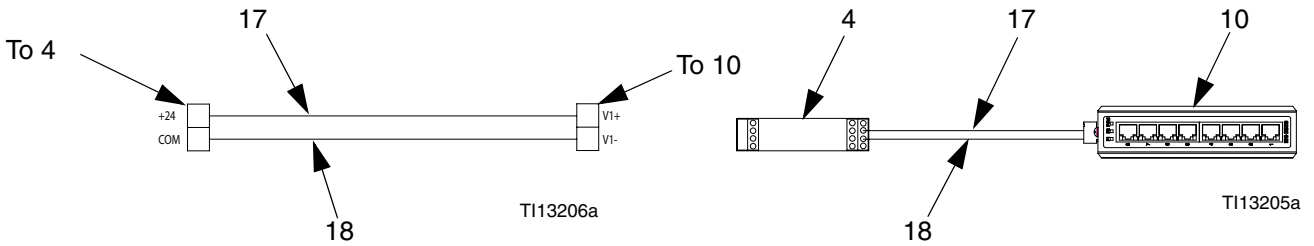

TI13206a

TI13205a

Ref. No.	Part No.	Description	Qty	Ref. No.	Part No.	Description	Qty
1	15V339	PANEL, back	1	10	15V342	SWITCH, ethernet	1
2	15T752	COVER	1	11	120838	BLOCK, clamp end	2
3	n/a	DIN RAIL	1	12	103833	SCREW, machine	4
4	120369	POWER SUPPLY, 24 Vdc	1	13	112443	BLOCK, terminal, ground	1
5	15V345	GROMMET, cable entry	2	17	n/a	WIRE, copper, 16 ga.; 9 in. (230 mm)	1
6	111987	CONNECTOR, strain relief	1	18	n/a	WIRE, copper, 16 ga; 9 in. (230 mm)	1
7	n/a	WIREWAY	1	28	n/a	SCREW, machine, serrated hex-head	4
8	186620	LABEL, ground	1				
9	n/a	COVER, wireway	1				

Parts labeled n/a are not available separately.

Electrical Schematic

Non-Hazardous Area

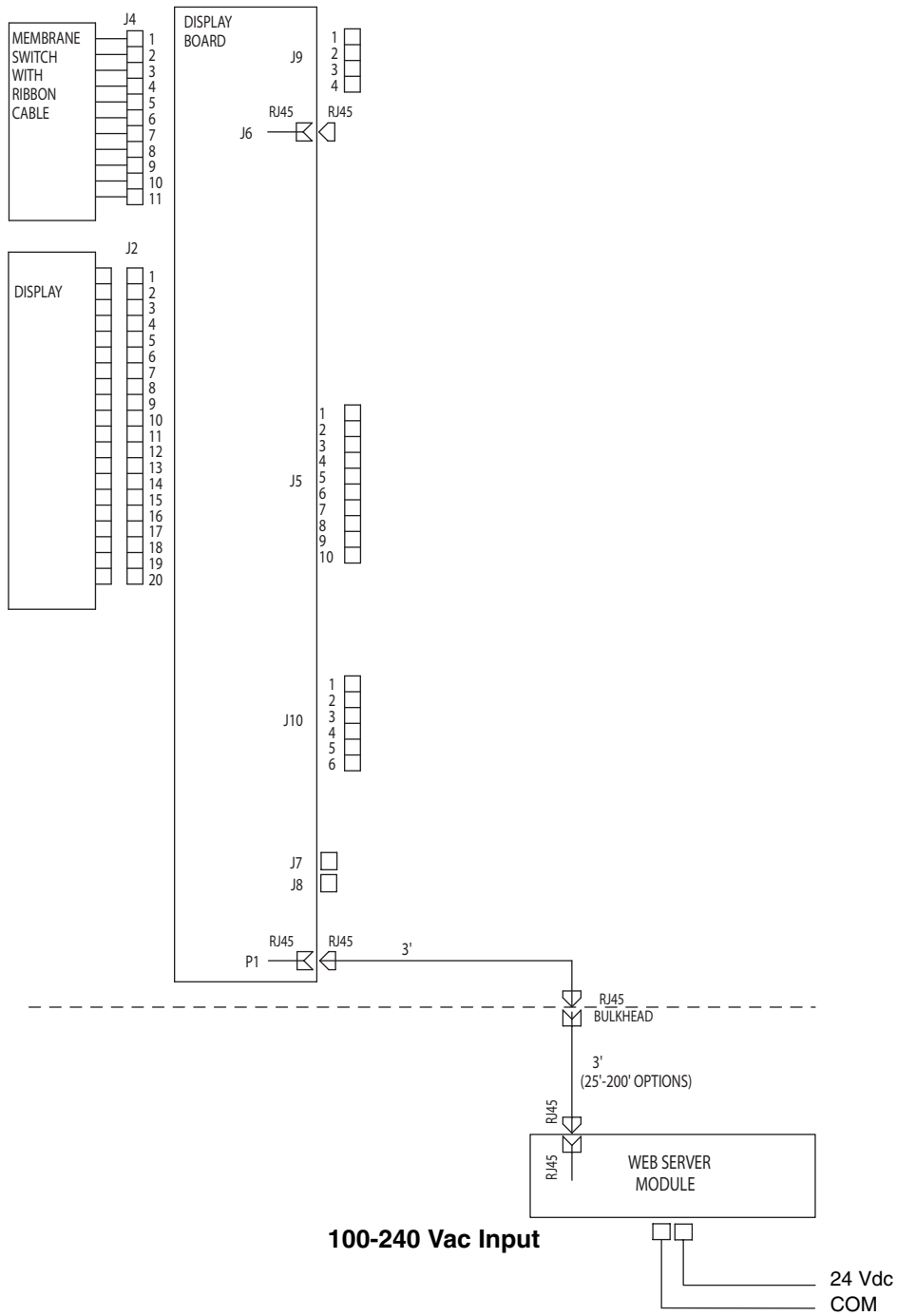

Dimensions

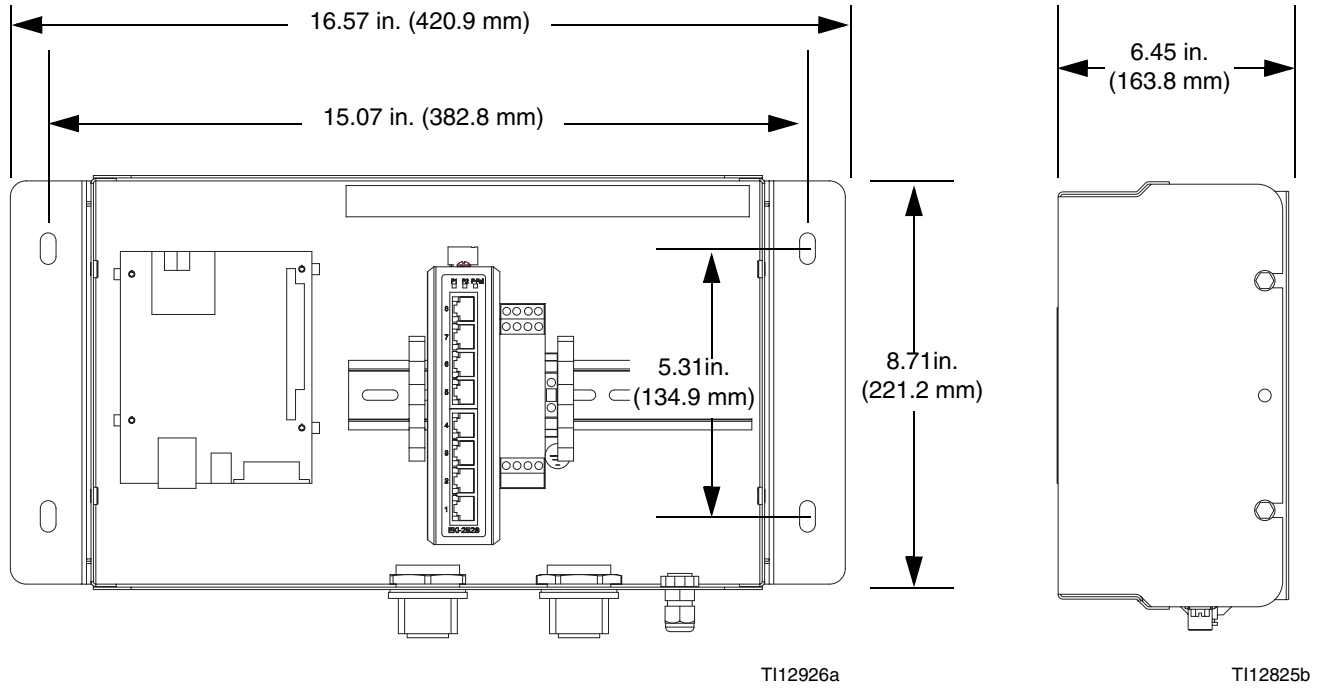

Graco Standard Warranty

Graco warrants all equipment referenced in this document which is manufactured by Graco and bearing its name to be free from defects in material and workmanship on the date of sale to the original purchaser for use. With the exception of any special, extended, or limited warranty published by Graco, Graco will, for a period of twelve months from the date of sale, repair or replace any part of the equipment determined by Graco to be defective. This warranty applies only when the equipment is installed, operated and maintained in accordance with Graco's written recommendations.

This warranty does not cover, and Graco shall not be liable for general wear and tear, or any malfunction, damage or wear caused by faulty installation, misapplication, abrasion, corrosion, inadequate or improper maintenance, negligence, accident, tampering, or substitution of non-Graco component parts. Nor shall Graco be liable for malfunction, damage or wear caused by the incompatibility of Graco equipment with structures, accessories, equipment or materials not supplied by Graco, or the improper design, manufacture, installation, operation or maintenance of structures, accessories, equipment or materials not supplied by Graco.

This warranty is conditioned upon the prepaid return of the equipment claimed to be defective to an authorized Graco distributor for verification of the claimed defect. If the claimed defect is verified, Graco will repair or replace free of charge any defective parts. The equipment will be returned to the original purchaser transportation prepaid. If inspection of the equipment does not disclose any defect in material or workmanship, repairs will be made at a reasonable charge, which charges may include the costs of parts, labor, and transportation.

THIS WARRANTY IS EXCLUSIVE, AND IS IN LIEU OF ANY OTHER WARRANTIES, EXPRESS OR IMPLIED, INCLUDING BUT NOT LIMITED TO WARRANTY OF MERCHANTABILITY OR WARRANTY OF FITNESS FOR A PARTICULAR PURPOSE.

Graco's sole obligation and buyer's sole remedy for any breach of warranty shall be as set forth above. The buyer agrees that no other remedy (including, but not limited to, incidental or consequential damages for lost profits, lost sales, injury to person or property, or any other incidental or consequential loss) shall be available. Any action for breach of warranty must be brought within two (2) years of the date of sale.

GRACO MAKES NO WARRANTY, AND DISCLAIMS ALL IMPLIED WARRANTIES OF MERCHANTABILITY AND FITNESS FOR A PARTICULAR PURPOSE, IN CONNECTION WITH ACCESSORIES, EQUIPMENT, MATERIALS OR COMPONENTS SOLD BUT NOT MANUFACTURED BY GRACO. These items sold, but not manufactured by Graco (such as electric motors, switches, hose, etc.), are subject to the warranty, if any, of their manufacturer. Graco will provide purchaser with reasonable assistance in making any claim for breach of these warranties.

In no event will Graco be liable for indirect, incidental, special or consequential damages resulting from Graco supplying equipment hereunder, or the furnishing, performance, or use of any products or other goods sold hereto, whether due to a breach of contract, breach of warranty, the negligence of Graco, or otherwise.

FOR GRACO CANADA CUSTOMERS

The Parties acknowledge that they have required that the present document, as well as all documents, notices and legal proceedings entered into, given or instituted pursuant hereto or relating directly or indirectly hereto, be drawn up in English. Les parties reconnaissent avoir convenu que la rédaction du présente document sera en Anglais, ainsi que tous documents, avis et procédures judiciaires exécutés, donnés ou intentés, à la suite de ou en rapport, directement ou indirectement, avec les procédures concernées.

Graco Information

For the latest information about Graco products, visit www.graco.com.

TO PLACE AN ORDER, contact your Graco distributor or call to identify the nearest distributor.

Phone: 612-623-6921 **or Toll Free:** 1-800-328-0211 **Fax:** 612-378-3505

*All written and visual data contained in this document reflects the latest product information available at the time of publication.
Graco reserves the right to make changes at any time without notice.*

Original instructions. This manual contains English. MM 313386

Graco Headquarters: Minneapolis

International Offices: Belgium, China, Japan, Korea

GRACO INC. AND SUBSIDIARIES • P.O. BOX 1441 • MINNEAPOLIS, MN 55440-1441 • USA

Copyright 2008, Graco Inc. All Graco manufacturing locations are registered to ISO 9001.

www.graco.com
Revised 09/2011