

User's Guide



Shop online at

omega.com[®]

Ω OMEGA[®]

omega.com

e-mail: info@omega.com

For latest product manuals:

omegamanual.info

ISO 9001
CERTIFIED
CORPORATE QUALITY

STAMFORD, CT

ISO 9002
CERTIFIED
CORPORATE QUALITY

MANCHESTER, UK

PTC900/PTC901 Panel-Mount Programmable Timer and Real-Time Clock



OMEGAnet® Online Service omega.com	Internet e-mail info@omega.com
---	---

Servicing North America:

U.S.A.: One Omega Drive, P.O. Box 4047
ISO 9001 Certified Stamford, CT 06907-0047
TEL: (203) 359-1660 FAX: (203) 359-7700
e-mail: info@omega.com

Canada: 976 Bergar
Laval (Quebec) H7L 5A1, Canada
TEL: (514) 856-6928 FAX: (514) 856-6886
e-mail: info@omega.ca

For immediate technical or application assistance:

U.S.A. and Canada: Sales Service: 1-800-826-6342/1-800-TC-OMEGA®
Customer Service: 1-800-622-2378/1-800-622-BEST®
Engineering Service: 1-800-872-9436/1-800-USA-WHEN®

Mexico: En Español: (001) 203-359-7803 e-mail: espanol@omega.com
FAX: (001) 203-359-7807 info@omega.com.mx

Servicing Europe:

Czech Republic: Frystatska 184, 733 01 Karviná, Czech Republic
TEL: +420 (0)59 6311899 FAX: +420 (0)59 6311114
Toll Free: 0800-1-66342
e-mail: info@omegashop.cz

Germany/Austria: Daimlerstrasse 26, D-75392 Deckenpfronn, Germany
TEL: +49 (0)7056 9398-0 FAX: +49 (0)7056 9398-29
Toll Free in Germany: 0800 639 7678
e-mail: info@omega.de

United Kingdom: One Omega Drive, River Bend Technology Centre
ISO 9002 Certified Northbank, Irlam, Manchester
M44 5BD United Kingdom
TEL: +44 (0)161 777 6611 FAX: +44 (0)161 777 6622
Toll Free in United Kingdom: 0800-488-488
e-mail: sales@omega.co.uk

It is the policy of OMEGA Engineering, Inc. to comply with all worldwide safety and EMC/EMI regulations that apply. OMEGA is constantly pursuing certification of its products to the European New Approach Directives. OMEGA will add the CE mark to every appropriate device upon certification.

The information contained in this document is believed to be correct, but OMEGA accepts no liability for any errors it contains, and reserves the right to alter specifications without notice.

WARNING : These products are not designed for use in, and should not be used for, human applications.



- 6-DIGIT 0.56" RED SUNLIGHT READABLE DISPLAY
- 4 SEPARATE DISPLAYS (Timer, Counter, Real-Time Clock, and Date)
- CYCLE COUNTING CAPABILITY
- PROGRAMMABLE FUNCTION KEYS/USER INPUTS
- FOUR SETPOINT ALARM OUTPUTS (W/Plug-in card)
- COMMUNICATIONS AND BUS CAPABILITIES (W/Plug-in card)
- PC SOFTWARE AVAILABLE FOR METER CONFIGURATION
- NEMA 4X/IP65 SEALED FRONT BEZEL

GENERAL DESCRIPTION

The PTC900 (Timer) and PTC901 (Clock/Timer) offer many features and performance capabilities to suit a wide range of industrial applications. Both can function as an Elapsed Timer or Preset Timer, while the PTC901 also offers Real-Time Clock with Date capability. The Plug-in option cards allow the opportunity to configure the meter for the present application, while providing easy upgrades for future needs.

Both units can function as an Elapsed Time Indicator. By using two separate signal inputs and 23 selectable timer ranges, the meters can be programmed to meet most any timing application. With the addition of a Plug-in Setpoint card, they can easily become a dual or quad output preset timer.

The PTC901 can also operate as a Real-Time Clock (RTC), with the Real-Time Clock Card already installed. The meter is capable of displaying time in 12 or 24-hour time formats. The 12-hour format can be displayed in hours and minutes, with or without an AM/PM indication or in hours, minutes, and seconds. The 24-hour format can be displayed in hours and minutes or in hours, minutes, and seconds. The PTC901 is also capable of a calendar display in which the day, month and/or year can be displayed. The meter will recognize leap years, and can automatically adjust for Daylight Savings Time. The Real-Time Clock has the ability to externally synchronize with other PTC901 meters to provide a uniform display network throughout the plant.

If the application calls for both a Preset Timer and a Real-Time Clock at the same time, the PTC901 can handle this requirement as well. The meter provides up to four different displays, accessed via front panel push buttons or external inputs. The displays are Timer (TMR), which displays the current timer value; Count (CNT), which displays the current cycle counter value; Date (DAT), which displays the current programmed date; and Real-Time Clock, which displays the current time. A battery-backed Real-Time Clock plug-in card is provided with the PTC901. This card, which includes a lithium coin-cell battery, will maintain the time and date when main power is removed.

The meters accept inputs from a variety of sources including switch contacts and outputs from CMOS or TTL circuits. The input can be configured to trigger on the edge or level of the incoming pulse. Internal jumpers are available to allow the selection for sinking inputs (active low) or sourcing inputs (active high).

The front panel keys and three user inputs are programmable to perform various meter functions. One of the functions includes exchanging parameter lists, allowing for two separate listings of setpoint values, timer start/stop values, counter start/stop values and RTC daily on and off values.

The meters can have up to four setpoint outputs, determined by the optional plug-in cards. The setpoint plug-in cards provide dual FORM-C relays (5A), quad FORM-A relays (3A) or either quad sinking or quad sourcing open collector logic outputs. The outputs can be assigned to the timer, counter, RTC date, and RTC time. The outputs can also be independently configured to suit a variety of control and alarm requirements.

Plug-in cards can also provide serial communications. These include RS232, RS485, and Modbus. Display values, setpoint alarm values and setpoint states can be controlled through serial communications. With the RS232 or RS485 communication card installed, it is possible to configure the meter using a Windows® based program. The meter configuration data can be saved to a file for later recall.

Once the meters have been initially configured, the parameter list may be locked out from further modification entirely, or the setpoint, timer start/stop values, counter start/stop values, RTC time SET, and Display Intensity can be made accessible. This lockout is possible through a security code or user input.

The meters have been specifically designed for harsh industrial environments. With a NEMA 4X/IP65 sealed bezel and extensive testing to meet CE requirements, the meter provides a tough yet reliable application solution.

SAFETY SUMMARY

All safety related regulations, local codes and instructions that appear in this literature or on equipment must be observed to ensure personal safety and to prevent damage to either the instrument or equipment connected to it. If equipment is used in a manner not specified by the manufacturer, the protection provided by the equipment may be impaired.

Do not use this unit to directly command motors, valves, or other actuators not equipped with safeguards. To do so can be potentially harmful to persons or equipment in the event of a fault to the unit.



CAUTION: Risk of Danger.
Read complete instructions prior to installation and operation of the unit.



CAUTION: Risk of electric shock.

DIMENSIONS In inches (mm)

Note: Recommended minimum clearance (behind the panel) for mounting clip installation is 2.1" (53.4) H x 5" (127) W.

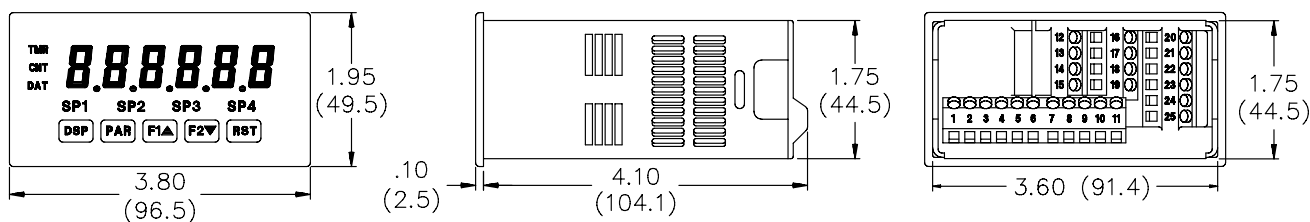

TABLE OF CONTENTS

General Meter Specifications	4	Wiring the Meter	7
Optional Plug-In Cards and Accessories	5	Reviewing the Front Buttons and Display	10
Installing the Meter	6	Programming the Meter	11
Setting the Jumpers	6	Factory Service Operations	26
Installing Plug-In Cards	7	Programming Overview	29

GENERAL METER SPECIFICATIONS

- DISPLAY:** 6 digit, 0.56" (14.2 mm) red sunlight readable or standard green LED
- POWER:**
 - AC Versions (PTC901, PTC900):
 - AC Power: 85 to 250 VAC, 50/60 Hz, 18 VA
 - Isolation: 2300 Vrms for 1 min. to all inputs and outputs. (300 V working)
 - DC Versions (PTC901-LV, PTC900-LV):
 - DC Power: 11 to 36 VDC, 14 W
 - (Derate operating temperature to 40°C if operating <15 VDC and three Plug-in cards are installed)
 - AC Power: 24 VAC, ± 10%, 50/60 Hz, 15 VA
 - Isolation: 500 Vrms for 1 min. to all inputs and outputs (50 V working)
- SENSOR POWER:** 12 VDC, ±10%, 100 mA max. Short circuit protected.
- ANNUNCIATORS:**

TMR - Timer Display	SP1 - Setpoint 1 Output
CNT - Cycle Counter Display	SP2 - Setpoint 2 Output
DAT - Real-Time Clock Date Display	SP3 - Setpoint 3 Output
- Real-Time Clock Time Display	SP4 - Setpoint 4 Output
- KEYPAD:** 3 programmable function keys, 5 keys total.
- TIMER DISPLAY:**
 - Timer Range: 23 Selectable Ranges
 - Timing Accuracy: ± 0.01%
 - Minimum Digit Resolution: 0.001 Sec.
 - Maximum Least Significant Digit Resolution: 1 Hr.
 - Maximum Display: 999999
- CYCLE COUNTER DISPLAY:**
 - Counter Range: 0 to 999999
 - Digit Resolution: 1 cycle
 - Maximum Count Rate: 50 Hz
- REAL-TIME/DATE DISPLAY (PTC901):**
 - Real-Time Display: 5 display formats
 - Hr/Min/Sec (12 or 24 Hr. format); Hr/Min (24 Hr.); Hr/Min (12 Hr. with or without AM/PM indication)
 - Date Display: 7 display formats
 - Month/Day or Day/Month (numeric or 3-letter Month format);
 - Month/Day/Year or Day/Month/Year (all numeric);
 - Day of Week/Day (3-letter Day of Week format)
- REAL-TIME CLOCK CARD:** Field replaceable plug-in card
 - Time Accuracy: ± 5 secs./Month (1 min./year) with end-user calibration
 - Battery: Lithium 2025 coin cell
 - Battery Life Expectancy: 10 yrs. typical
 - Synchronization Interface: Two-wire multi-drop network (RS485 hardware), 32 units max., operates up to 4000 ft.
 - Isolation To Timer & User Input Commons: 500 Vrms for 1 min.
 - Working Voltage: 50 V. Not isolated from all other commons.
- TIMER INPUTS A and B:**
 - Logic inputs configurable as Current Sinking (active low) or Current Sourcing (active high) via a single plug jumper.
 - Current Sinking (active low): $V_{IL} = 0.9 \text{ V max.}$, 22K Ω pull-up to +12 VDC.
 - Current Sourcing (active high): $V_{IH} = 3.6 \text{ V min.}$, 22K Ω pull-down, Max. Continuous Input: 30 VDC.
 - Timer Input Pulse Width: 1 msec min.
 - Timer Start/Stop Response Time: 1 msec max.
 - Filter: Software filtering provided for switch contact debounce. Filter enabled or disabled through programming.
 - If enabled, filter results in 50 msec start/stop response time for successive pulses on the same input terminal.
- USER INPUTS:** Three programmable user inputs
 - Logic inputs configurable as Current Sinking (active low) or Current Sourcing (active high) through a single plug jumper.
 - Current Sinking (active low): $V_{IL} = 0.9 \text{ V max.}$, 22K Ω pull-up to +12 VDC.
 - Current Sourcing (active high): $V_{IH} = 3.6 \text{ V min.}$, 22K Ω pull-down, Max. Continuous Input: 30 VDC.
 - Isolation To Timer Input Common: Not isolated
 - Response Time: 10 msec
- MEMORY:** Non-volatile E²PROM retains all programming parameters and display values.
- ENVIRONMENTAL CONDITIONS:**
 - Operating Temperature Range: 0 to 50°C (0 to 45°C with all three plug-in cards installed)
 - Storage Temperature Range: -40 to 60°C
 - Operating and Storage Humidity: 0 to 85% max. RH non-condensing
 - Vibration According to IEC 68-2-6: Operational 5 to 150 Hz, in X, Y, Z direction for 1.5 hours, 2 g's.
 - Shock According to IEC 68-2-27: Operational 25 g (10g relay), 11 msec in 3 directions.
 - Altitude: Up to 2000 meters
- CERTIFICATIONS AND COMPLIANCE:**
 - SAFETY**
 - UL Recognized Component, File # E313607, UL61010A-1, CSA C22.2 No. 61010-1
 - Recognized to U.S. and Canadian requirements under the Component Recognition Program of Underwriters Laboratories, Inc.
 - UL Listed, File # E313547, UL508, CSA C22.2 No. 14-M95
 - LISTED by Und. Lab. Inc. to U.S and Canadian safety standards
 - Type 4X Enclosure rating (Face only), UL50
 - IEC 61010-1, EN 61010-1: Safety requirements for electrical equipment for measurement, control, and laboratory use, Part 1.
 - IP65 Enclosure rating (face only), IEC 529
 - IP20 Enclosure rating (rear of unit), IEC 529
 - ELECTROMAGNETIC COMPATIBILITY**
 - Immunity to EN 50082-2**

Electrostatic discharge	EN 61000-4-2	Level 3; 8 Kv air
Electromagnetic RF fields	EN 61000-4-3	Level 3; 10 V/m 80 MHz - 1 GHz
Fast transients (burst)	EN 61000-4-4	Level 4; 2 Kv I/O Level 3; 2 Kv power
RF conducted interference	EN 61000-4-6	Level 3; 10 V/rms 150 KHz - 80 MHz
 - Emissions to EN 50081-1**

RF interference	EN 55022	Enclosure class B Power mains class B
-----------------	----------	--
- CONNECTIONS:** High compression, cage-clamp terminal block
 - Wire Strip Length: 0.3" (7.5 mm)
 - Wire Gauge: 30-14 AWG copper wire
 - Torque: 4.5 inch-lbs (0.51 N-m) max.
- CONSTRUCTION:** This meter is rated for NEMA 4X/IP65 outdoor use. IP20 Touch safe. Installation Category II, Pollution Degree 2. One piece bezel/case. Flame resistant. Synthetic rubber keypad. Panel gasket and mounting clip included.
- WEIGHT:** 10.1 oz. (286 g)

OPTIONAL PLUG-IN CARDS AND ACCESSORIES



WARNING: Disconnect all power to the unit before installing Plug-in cards.

Adding Option Cards

The PTC900/PTC/901 series meters can be fitted with up to three optional plug-in cards. The details for each plug-in card can be reviewed in the specification section below. Only one card from each function type can be installed at one time. The function types include Setpoint Alarms (LDP6-CDS), Communications (LDP6-CDC), and Real-Time Clock Card (LDP6-RTC). The plug-in cards can be installed initially or at a later date.

COMMUNICATION CARDS (LDP6-CDC)

A variety of communication protocols are available for the PTC900/PTC/901 series. Only one of these cards can be installed at a time. When programming the unit via the Windows® based software program, the RS232 or RS485 Cards must be used.

LDP6-CDC10 - RS485 Serial (Terminal) LDP6-CDC1C - RS485 (Connector)
LDP6-CDC20 - RS232 Serial (Terminal) LDP6-CDC2C - RS232 (Connector)
LDP6-CDC40 - Modbus (Terminal) LDP6-CDC4C - Modbus (Connector)

SERIAL COMMUNICATIONS CARD

Type: RS485 or RS232

Isolation To Sensor & User Input Commons: 500 Vrms for 1 min.

Working Voltage: 50 V. Not Isolated from all other commons.

Data: 7/8 bits

Baud: 300 to 19,200

Parity: No, Odd or Even

Bus Address: Selectable 0 to 99, Max. 32 meters per line (RS485)

Transmit Delay: Selectable for 2 to 50 msec or 50 to 100 msec (RS485)

MODBUS CARD

Type: RS485; RTU and ASCII MODBUS modes

Isolation To Sensor & User Input Commons: 500 Vrms for 1 minute.

Working Voltage: 50 V. Not isolated from all other commons.

Baud Rates: 300 to 38,400.

Data: 7/8 bits

Parity: No, Odd, or Even

Addresses: 1 to 247.

Transmit Delay: Programmable; See Transmit Delay explanation.

PROGRAMMING SOFTWARE

DP6-SOFT is a Windows® based program that allows configuration of the PTC900/PTC/901 meters from a PC. This software offers standard drop-down menu commands, that make it easy to program the meter. The PTC900/PTC/901 program can then be saved in a PC file for future use. A serial plug-in card is required to program the meter using the software.

SETPOINT CARDS (LDP6-CDS)

The PTC900/PTC/901 series has 4 available setpoint alarm output plug-in cards. Only one of these cards can be installed at a time. (Logic state of the outputs can be reversed in the programming.) These plug-in cards include:

LDP6-CDS10 - Dual Relay, FORM-C, Normally open & closed
LDP6-CDS20 - Quad Relay, FORM-A, Normally open only
LDP6-CDS30 - Isolated quad sinking NPN open collector
LDP6-CDS40 - Isolated quad sourcing PNP open collector

DUAL RELAY CARD

Type: Two FORM-C relays

Isolation To Timer & User Input Commons: 2300 Vrms for 1 min.

Working Voltage: 240 Vrms

Contact Rating:

One Relay Energized: 5 amps @ 120/240 VAC or 28 VDC (resistive load),
1/8 HP @120 VAC, inductive load

Total current with both relays energized not to exceed 5 amps

Life Expectancy: 100 K cycles min. at full load rating. External RC snubber extends relay life for operation with inductive loads

Response Time: 5 msec. nominal with 3 msec. nominal release

Timed Output Accuracy: ±0.01% -10 msec.

QUAD RELAY CARD

Type: Four FORM-A relays

Isolation To Timer & User Input Commons: 2300 Vrms for 1 min.

Working Voltage: 250 Vrms

Contact Rating:

One Relay Energized: 3 amps @ 250 VAC or 30 VDC (resistive load), 1/10
HP @ 120 VAC, inductive load

Total current with all four relays energized not to exceed 4 amps

Life Expectancy: 100K cycles min. at full load rating. External RC snubber extends relay life for operation with inductive loads

Response Time: 5 msec. nominal with 3 msec. nominal release

Timed Output Accuracy: ±0.01% -10 msec.

QUAD SINKING OPEN COLLECTOR CARD

Type: Four isolated sinking NPN transistors.

Isolation To Timer & User Input Commons: 500 Vrms for 1 min.

Working Voltage: 50 V. Not Isolated from all other commons.

Rating: 100 mA max @ $V_{SAT} = 0.7 V$ max. $V_{MAX} = 30 V$

Response Time: 400 µsec. nominal with 2 msec. nominal turnoff

Timed Output Accuracy: ±0.01% -10 msec.

QUAD SOURCING OPEN COLLECTOR CARD

Type: Four isolated sourcing PNP transistors.

Isolation To Timer & User Input Commons: 500 Vrms for 1 min.

Working Voltage: 50 V. Not Isolated from all other commons.

Rating: Internal supply: 24 VDC ± 10% , 30 mA max. total

External supply: 30 VDC max., 100 mA max. each output

Response Time: 400 µsec. nominal with 2 msec. nominal turnoff

Timed Output Accuracy: ±0.01% -10 msec.

1.0 INSTALLING THE METER

Installation

The meter meets NEMA 4X/IP65 requirements for indoor use when properly installed. The meter is intended to be mounted into an enclosed panel. Prepare the panel cutout to the dimensions shown. Remove the panel latch from the meter. Slide the panel gasket over the rear of the meter to the back of the bezel. The meter should be installed fully assembled.

Insert the meter into the panel cutout.

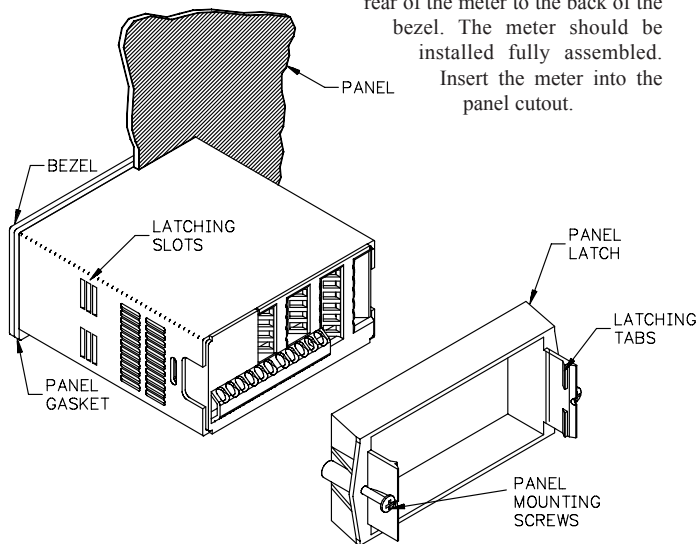

While holding the meter in place, push the panel latch over the rear of the meter so that the tabs of the panel latch engage in the slots on the case. The panel latch should be engaged in the farthest forward slot possible. To achieve a proper seal, tighten the latch screws evenly until the meter is snug in the panel (Torque to approximately 7 in-lbs [79N-cm]). Do not over-tighten the screws.

Installation Environment

The meter should be installed in a location that does not exceed the operating temperature and provides good air circulation. Placing the meter near devices that generate excessive heat should be avoided.

The bezel should only be cleaned with a soft cloth and neutral soap product. Do NOT use solvents. Continuous exposure to direct sunlight may accelerate the aging process of the bezel.

Do not use tools of any kind (screwdrivers, pens, pencils, etc.) to operate the keypad of the meter.

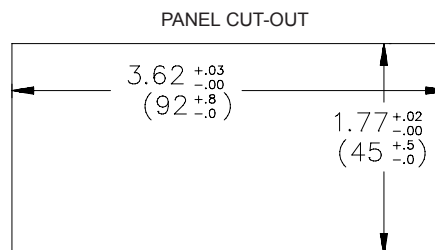

2.0 SETTING THE JUMPERS

To access the jumpers, remove the meter base from the meter case by firmly squeezing and pulling back on the side rear finger tabs. This should lower the latch below the case slot (which is located just in front of the finger tabs). It is recommended to release the latch on one side, then start the other side latch.



Warning: Exposed line voltage exists on the circuit boards. Remove all power to the meter and load circuits before accessing inside of the meter.

Timer Input Logic Jumper

One jumper is used for the logic state of both timer inputs. Select the proper position to match the input being used.

User Input Logic Jumper

One jumper is used for the logic state of all user inputs. If the user inputs are not used, it is not necessary to check or move this jumper.

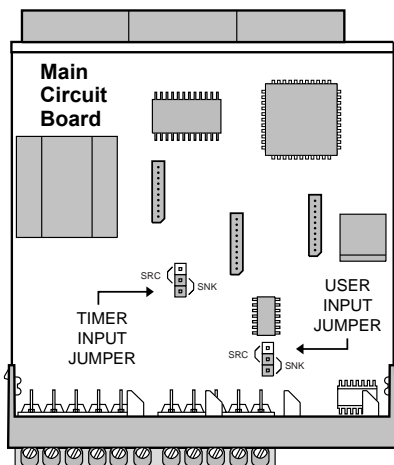

JUMPER SELECTIONS

The \cap indicates factory setting.

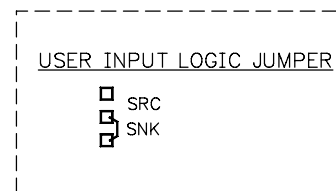
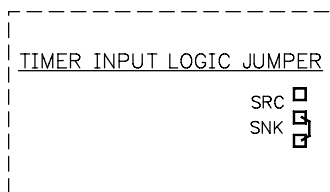

↓ REAR TERMINALS ↓

3.0 INSTALLING PLUG-IN CARDS

The Plug-in cards are separately purchased optional cards that perform specific functions. These cards plug into the main circuit board of the meter. The Plug-in cards have many unique functions when used with the meters.



CAUTION: The Plug-in card and main circuit board contain static sensitive components. Before handling the cards, discharge static charges from your body by touching a grounded bare metal object. Ideally, handle the cards at a static controlled clean workstation. Also, only handle the cards by the edges. Dirt, oil or other contaminants that may contact the cards can adversely affect circuit operation.

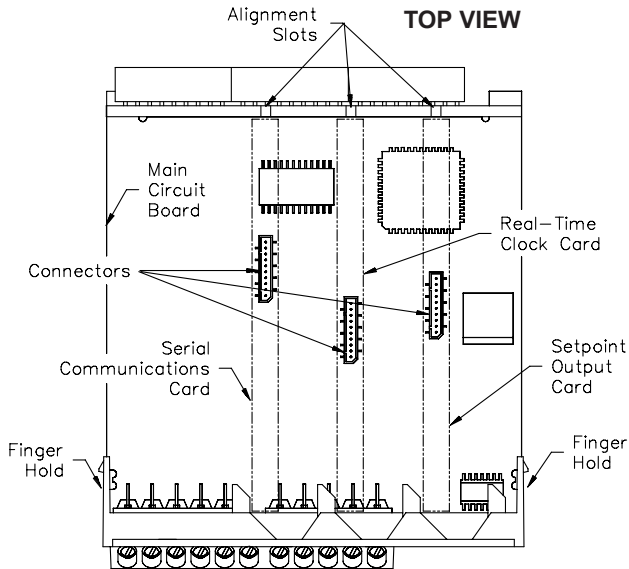

To Install:

1. With the case open, locate the Plug-in card connector for the card type to be installed. The types are keyed by position with different main circuit board connector locations. When installing the card, hold the meter by the rear terminals and not by the front display board.*
2. Install the Plug-in card by aligning the card terminals with the slot bay in the rear cover. Be sure the connector is fully engaged and the tab on the Plug-in card rests in the alignment slot on the display board.
3. Slide the meter base back into the case. Be sure the rear cover latches fully into the case.
4. Apply the Plug-in card label to the bottom side of the meter. Do Not Cover the vents on the top surface of the meter. The surface of the case must be clean for the label to adhere properly. Apply the label to the area designated by the large case label.

Quad Sourcing Open Collector Output Card Supply Select

* If installing the Quad sourcing Plug-in Card (LDP6-CDS40), set the jumper for internal or external supply operation before continuing.

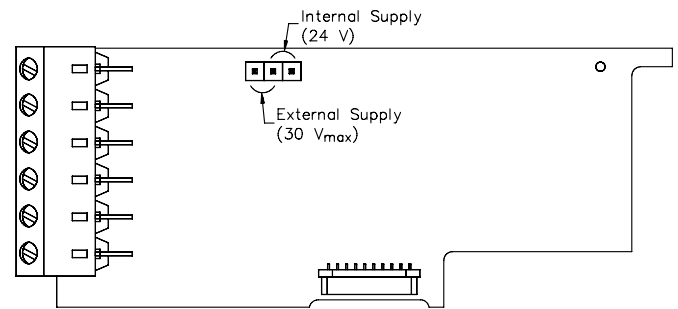

4.0 WIRING THE METER

WIRING OVERVIEW

Electrical connections are made via screw-clamp terminals located on the back of the meter. All conductors should conform to the meter's voltage and current ratings. All cabling should conform to appropriate standards of good installation, local codes and regulations. It is recommended that the power supplied to the meter (DC or AC) be protected by a fuse or circuit breaker.

When wiring the meter, compare the numbers embossed on the back of the meter case against those shown in wiring drawings for proper wire position. Strip the wire, leaving approximately 0.3" (7.5 mm) bare lead exposed (stranded wires should be tinned with solder.) Insert the lead under the correct screw-clamp terminal and tighten until the wire is secure. (Pull wire to verify tightness.) Each terminal can accept up to one #14 AWG (2.55 mm) wire, two #18 AWG (1.02 mm), or four #20 AWG (0.61 mm).

EMC INSTALLATION GUIDELINES

Although this meter is designed with a high degree of immunity to Electro-Magnetic Interference (EMI), proper installation and wiring methods must be followed to ensure compatibility in each application. The type of the electrical noise, source or coupling method into the meter may be different for various installations. The meter becomes more immune to EMI with fewer I/O connections. Cable length, routing, and shield termination are very important and can mean the difference between a successful or troublesome installation. Listed below are some EMC guidelines for successful installation in an industrial environment.

1. The meter should be mounted in a metal enclosure, which is properly connected to protective earth.
2. Use shielded (screened) cables for all Signal and Control inputs. The shield (screen) pigtail connection should be made as short as possible. The connection point for the shield depends somewhat upon the application. Listed below are the recommended methods of connecting the shield, in order of their effectiveness.
 - a. Connect the shield only at the panel where the unit is mounted to earth ground (protective earth).

- b. Connect the shield to earth ground at both ends of the cable, usually when the noise source frequency is above 1 MHz.
 - c. Connect the shield to common of the meter and leave the other end of the shield unconnected and insulated from earth ground.
3. Never run Signal or Control cables in the same conduit or raceway with AC power lines, conductors feeding motors, solenoids, SCR controls, and heaters, etc. The cables should be ran in metal conduit that is properly grounded. This is especially useful in applications where cable runs are long and portable two-way radios are used in close proximity or if the installation is near a commercial radio transmitter.
 4. Signal or Control cables within an enclosure should be routed as far as possible from contactors, control relays, transformers, and other noisy components.
 5. In extremely high EMI environments, the use of external EMI suppression devices, such as ferrite suppression cores, is effective. Install them on Signal and Control cables as close to the unit as possible. Loop the cable through the core several times or use multiple cores on each cable for additional protection. Install line filters on the power input cable to the unit to suppress power line interference. Install them near the power entry point of the enclosure. The following EMI suppression devices (or equivalent) are recommended:

Ferrite Suppression Cores for signal and control cables:

Fair-Rite # 0443167251
 TDK # ZCAT3035-1330A
 Steward # 28B2029-0A0

Line Filters for input power cables:

Schaffner # FN610-1/07
 Schaffner # FN670-1.8/07
 Corcom # 1 VR3

Note: Reference manufacturer's instructions when installing a line filter.

6. Long cable runs are more susceptible to EMI pickup than short cable runs. Therefore, keep cable runs as short as possible.
7. Switching of inductive loads produces high EMI. Use of snubbers across inductive loads suppresses EMI.

4.1 POWER WIRING

AC Power

Terminal 1: VAC
Terminal 2: VAC

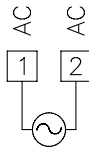

DC Power

Terminal 1: +VDC
Terminal 2: -VDC

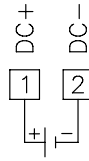

4.2 TIMER INPUT WIRING

Before connecting the wires, the Timer Input logic jumper should be verified for proper position.

Two Wire Proximity, Current Source

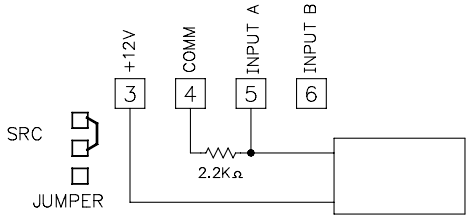

Current Sinking Output

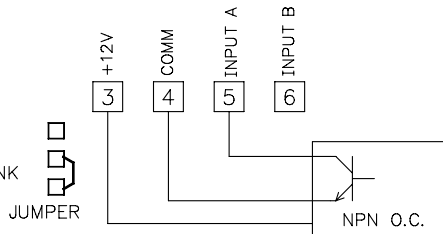

Current Sourcing Output

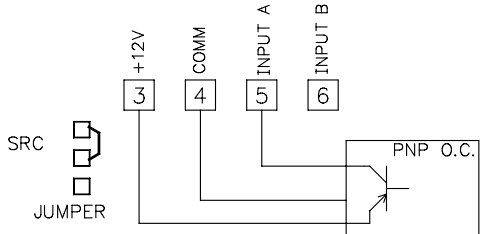

Switch or Isolated Transistor; Current Sink

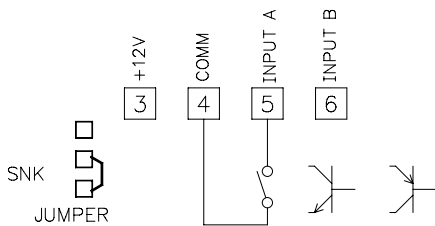

Switch or Isolated Transistor; Current Source

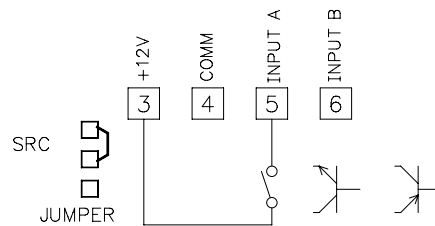

Interfacing With TTL

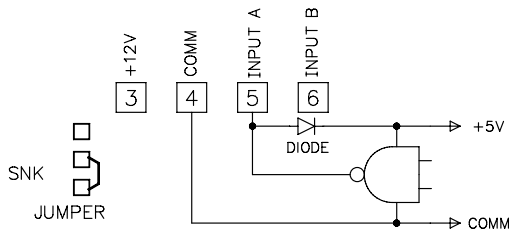

Emitter Follower; Current Source

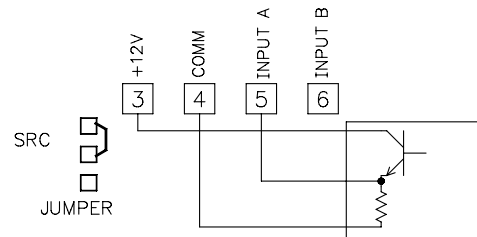

CAUTION: Timer Input common is NOT isolated from User Input common. In order to preserve the safety of the meter application, the timer input common must be suitably isolated from hazardous live earth referenced voltage; or input common must be at protective earth ground potential. If not, hazardous voltage may be present at the User Inputs and User Input Common terminals. Appropriate considerations must then be given to the potential of the User Input Common with respect to earth ground; and the common of the isolated plug-in cards with respect to input common.

4.3 USER INPUT WIRING

Before connecting the wires, the Timer Input logic jumper should be verified for proper position. When the user input is configured for cycle count, in module 4, the count input should be wired between terminals 7 & 10.

Sinking Logic

Terminals 7-9 } Connect external switching device between the
Terminal 10 } appropriate User Input terminal and User Comm.

The user inputs of the meter are internally pulled up to +12 V with 22 KΩ resistance. The input is active when it is pulled low (<0.9 V).

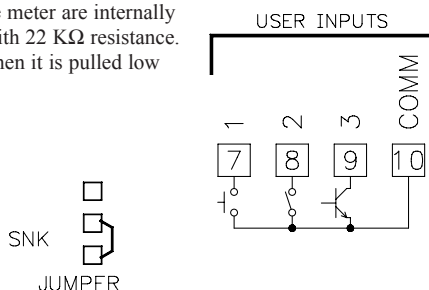

Sourcing Logic

Terminals 7-9: + VDC through external switching device

Terminal 10: -VDC through external switching device

The user inputs of the meter are internally pulled down to 0 V with 22 KΩ resistance. The input is active when a voltage greater than 3.6 VDC is applied.

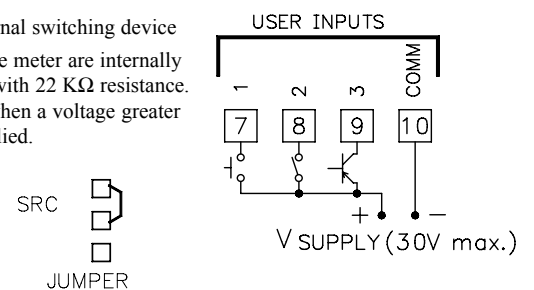

4.4 SETPOINT (ALARMS) WIRING

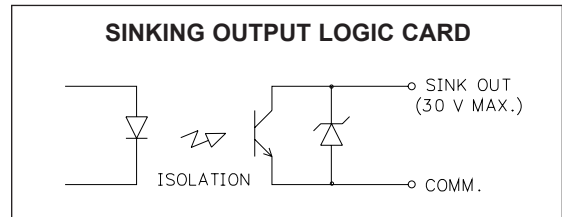
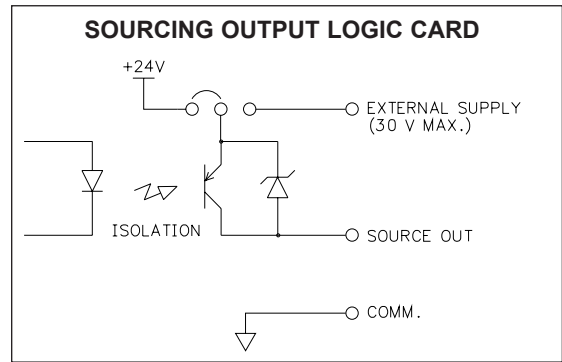
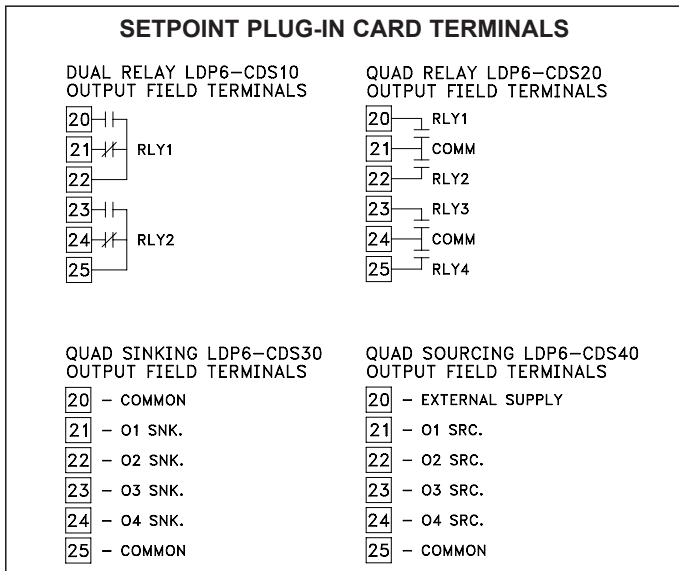

4.5 SERIAL COMMUNICATION WIRING

RS232 Communications

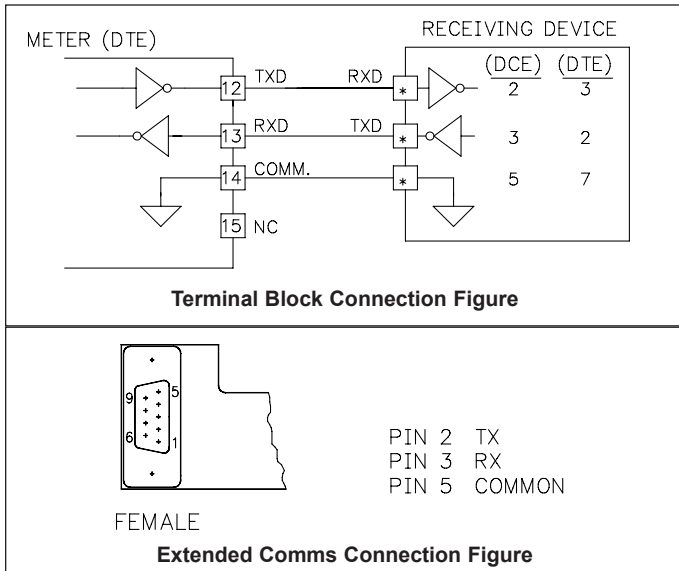

RS232 is intended to allow two devices to communicate over distances up to 50 feet. Data Terminal Equipment (DTE) transmits data on the Transmitted Data (TXD) line and receives data on the Received Data (RXD) line. Data Computer Equipment (DCE) receives data on the TXD line and transmits data on the RXD line. The meter emulates a DTE. If the other device connected to the meter also emulates a DTE, the TXD and RXD lines must be interchanged for communications to take place. This is known as a null modem connection. Most printers emulate a DCE device while most computers emulate a DTE device.

Some devices cannot accept more than two or three characters in succession without a pause in between. In these cases, the meter employs a busy function.

As the meter begins to transmit data, the RXD line (RS232) is monitored to determine if the receiving device is "busy". The receiving device asserts that it is busy by setting the RXD line to a space condition (logic 0). The meter then suspends transmission until the RXD line is released by the receiving device.

RS485 Communications

The RS485 communication standard allows the connection of up to 32 devices on a single pair of wires, distances up to 4,000 ft. and data rates as high as 10M baud. The same pair of wires is used to both transmit and receive data. RS485 is therefore always half-duplex, that is, data cannot be received and transmitted simultaneously.

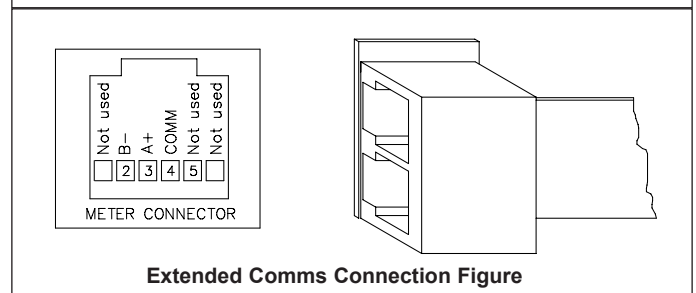
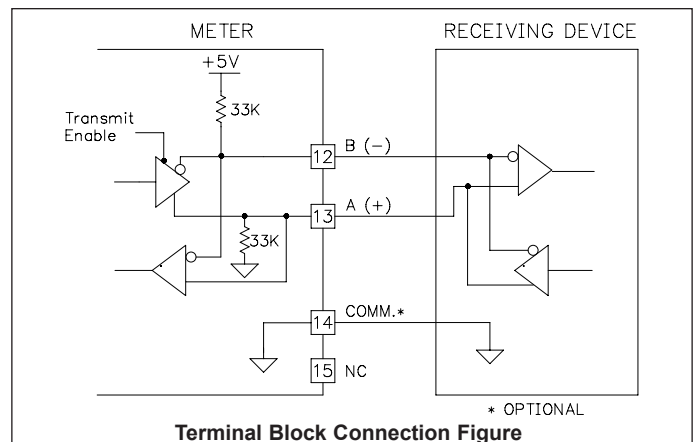

4.6 REAL-TIME CLOCK WIRING (PTC901)

Time synchronization between multiple PTC901 meters can be accomplished through a hardware interface on the Real-Time Clock option card. This RS485 type interface allows connection of up to 32 PTC901 meters in a two-wire multidrop network, at distances up to 4000 ft.

In a synchronization network, one PTC901 meter is programmed as the Host, while all other meters are programmed as Slaves. Once every hour, the Host meter outputs a time synchronization pulse onto the network. Upon receiving the synchronization pulse, each Slave meter automatically adjusts the minutes and seconds of its RTC Time setting to synchronize with the Host.

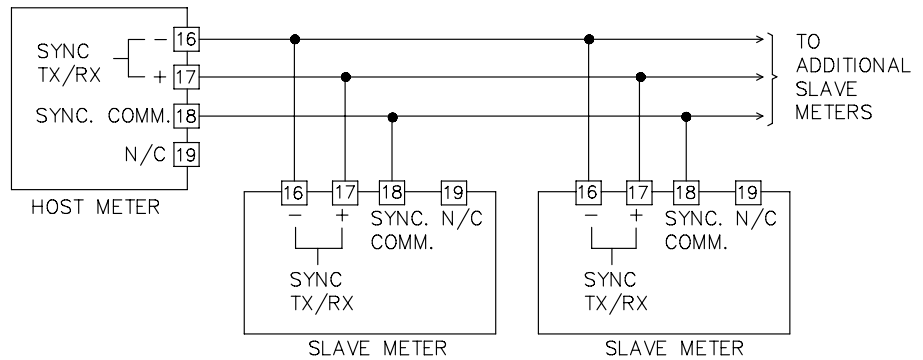

Real-Time Clock Synchronization Figure

5.0 REVIEWING THE FRONT BUTTONS AND DISPLAY

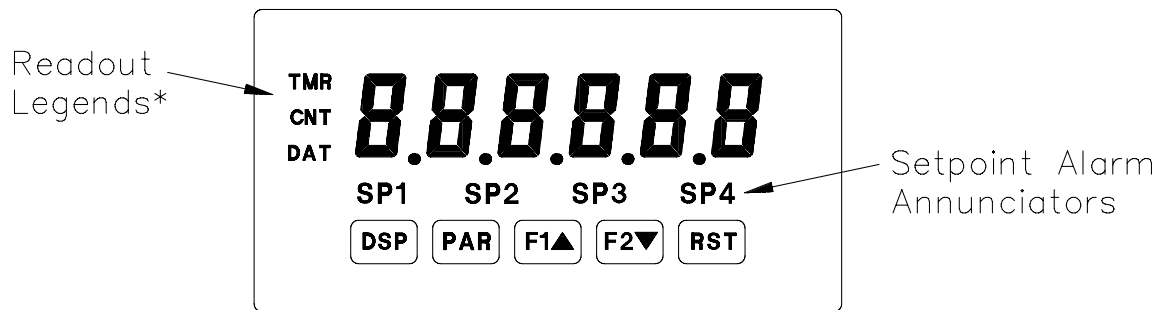

KEY DISPLAY MODE OPERATION

DSP	Index display through Timer, Cycle Counter, Date, and Time
PAR	Access Programming Mode
F1▲	Function key 1; hold for 3 seconds for Second Function 1 **
F2▼	Function key 2; hold for 3 seconds for Second Function 2 **
RST	Reset (Function key) ***

PROGRAMMING MODE OPERATION

	Exit programming and return to Display Mode
	Store selected parameter and index to next parameter
	Increment selected parameter value or selections
	Decrement selected parameter value or selections
	Selects digit location in parameter values

* Cycle counter and Real-Time Clock displays are locked out in Factory Settings.

** Factory setting for the F1 and F2 keys is NO mode.

*** Factory setting for the RST key is *dr 5t - E* (Reset Display)

6.0 PROGRAMMING THE METER

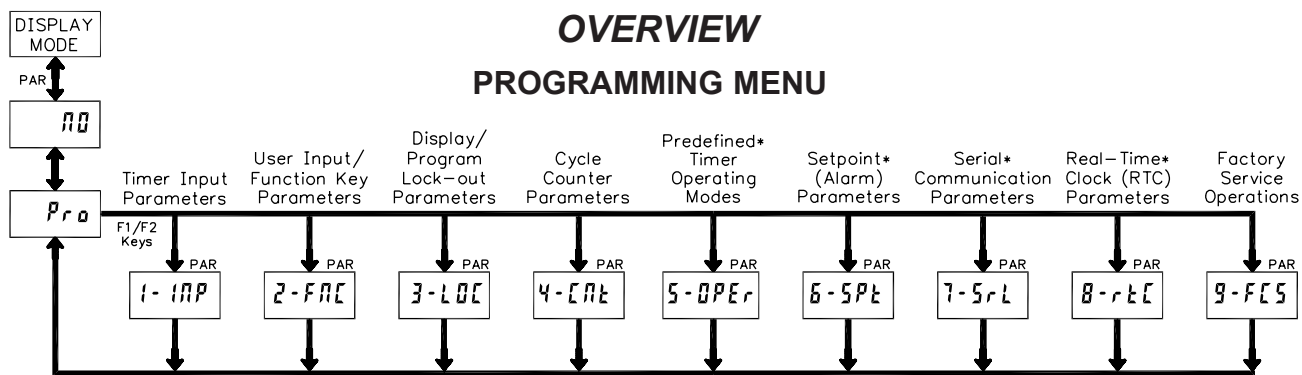

* Only accessible with appropriate plug-in card.

DISPLAY MODE

The meter normally operates in the Display Mode. In this mode, the meter displays can be viewed consecutively by pressing the **DSP** key. The annunciators to the left of the display indicate which display is currently shown; Timer (TMR), Cycle Counter (CNT), or Date (DAT). The Time Display for the Real-Time Clock is shown with no annunciator. Any of these displays can be locked from view through programming. (See Module 3.)

PROGRAMMING MODE

Two programming modes are available.

Full Programming Mode permits all parameters to be viewed and modified.

Upon entering this mode, the front panel keys change to Programming Mode operations. This mode should not be entered while a process is running, since the meter timing functions and User Input response may not operate properly while in Full Programming Mode.

Quick Programming Mode permits only certain parameters to be viewed and/or modified. When entering this mode, the front panel keys change to Programming Mode operations, and all meter functions continue to operate properly. Quick Programming Mode is configured in Module 3. The Display Intensity Level "d-LEU" parameter is only available in the Quick Programming Mode when the security code is non-zero. For a description, see Module 9—Factory Service Operations. Throughout this document, Programming Mode (without Quick in front) always refers to "Full" Programming Mode.

PROGRAMMING TIPS

The Programming Menu is organized into nine modules. (See above.) These modules group together parameters that are related in function. It is recommended to begin programming with Module 1 and proceed through each

module in sequence. Note that Modules 5 through 8 are only accessible when the appropriate plug-in option card is installed. If lost or confused while programming, press the **DSP** key to exit programming mode and start over. When programming is complete, it is recommended to record the meter settings on the Parameter Value Chart and lock-out parameter programming with a User Input or lock-out code. (See Modules 2 and 3 for lock-out details.)

FACTORY SETTINGS

Factory Settings may be completely restored in Module 9. This is a good starting point if encountering programming problems. Throughout the module description sections which follow, the factory setting for each parameter is shown below the parameter display. In addition, all factory settings are listed on the Parameter Value Chart following the programming section.

ALTERNATING SELECTION DISPLAY

In the module description sections which follow, the dual display with arrows appears for each programming parameter. This is used to illustrate the display alternating between the parameter (top display) and the parameter's Factory Setting (bottom display). In most cases, selections or value ranges for the parameter will be listed on the right.

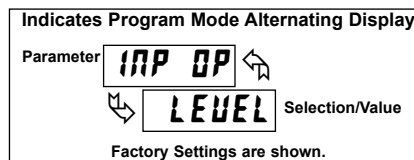

STEP BY STEP PROGRAMMING INSTRUCTIONS:

PROGRAMMING MODE ENTRY (PAR KEY)

The Programming Mode is entered by pressing the **PAR** key. If this mode is not accessible, then meter programming is locked by either a security code or a hardware lock. (See Modules 2 and 3 for programming lock-out details.)

MODULE ENTRY (ARROW & PAR KEYS)

Upon entering the Programming Mode, the display alternates between **Pr o** and the present module (initially **00**). The arrow keys (**F1▲** and **F2▼**) are used to select the desired module, which is then entered by pressing the **PAR** key.

PARAMETER (MODULE) MENU (PAR KEY)

Each module has a separate parameter menu. These menus are shown at the start of each module description section which follows. The **PAR** key is pressed to advance to a particular parameter to be changed, without changing the programming of preceding parameters. After completing a module, the display will return to **Pr o 00**. From this point, programming may continue by selecting and entering additional modules. (See **MODULE ENTRY** above.)

PARAMETER SELECTION ENTRY (ARROW & PAR KEYS)

For each parameter, the display alternates between the parameter and the present selection or value for that parameter. For parameters which have a list of selections, the arrow keys (**F1▲** and **F2▼**) are used to sequence through the list until the desired selection is displayed. Pressing the **PAR** key stores and activates the displayed selection, and also advances the meter to the next parameter.

NUMERICAL VALUE ENTRY (ARROW, RST & PAR KEYS)

For parameters which require a numerical value entry, the arrow keys can be used to increment or decrement the display to the desired value. When an arrow key is pressed and held, the display automatically scrolls up or scrolls down. The longer the key is held, the faster the display scrolls.

In addition, the **RST** key can be used in combination with the arrow keys to enter numerical values. The **RST** key is pressed to select a specific digit to be changed, which blinks when selected. Once a digit is selected, the arrow keys are used to increment or decrement that digit to the desired number. The **RST** key is then pressed again to select the next digit to be changed. This "select and set" sequence is repeated until each digit is displaying the proper number. Pressing the **PAR** key stores and activates the displayed value, and also advances the meter to the next parameter.

PROGRAMMING MODE EXIT (DSP KEY or PAR KEY at Pr o 00)

The Programming Mode is exited by pressing the **DSP** key (from anywhere in the Programming Mode) or the **PAR** key (with **Pr o 00** displayed). This will commit any stored parameter changes to memory and return the meter to the Display Mode. If a parameter was just changed, the **PAR** key should be pressed to store the change before pressing the **DSP** key. (If power loss occurs before returning to the Display Mode, verify recent parameter changes.)

6.1 MODULE 1 - TIMER INPUT PARAMETERS (1-17P)

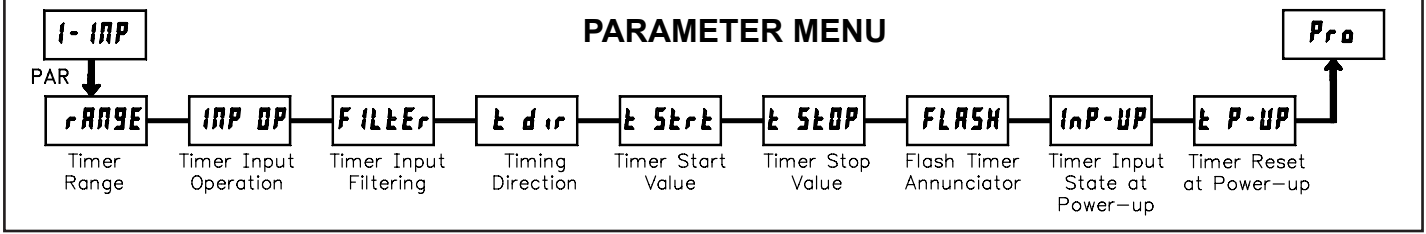

Module 1 is the programming module for the Timer Input Parameters. In the Display Mode, the TMR annunciator indicates the Timer display is currently being shown. An **EXCHANGE PARAMETER LISTS** feature, which includes the Timer Start and Timer Stop Values, is explained in Module 2.

TIMER RANGE



23 TIMER RANGE SELECTIONS
(5 = SEC; M = MIN; H = HR; d = DAY)

RANGE SELECTION	MAXIMUM DISPLAY	DISPLAY RESOLUTION	RANGE SELECTION	MAXIMUM DISPLAY	DISPLAY RESOLUTION
SECONDS					
555555	999999	1 SEC	MMMM55	999959	1 SEC
555555	999999	0.1 SEC	MM5555	999599	0.1 SEC
555555	999999	0.01 SEC	M55555	995999	0.01 SEC
555555	999999	0.001 SEC	M55555	959999	0.001 SEC
MINUTES					
MMMMMM	999999	1 MIN	MMMM55	999599	1 MIN
MMMMMM	999999	0.1 MIN	MM55MM	999599	0.1 MIN
MMMMMM	999999	0.01 MIN	M55MMM	995999	0.01 MIN
MMMMMM	999999	0.001 MIN	M55MMM	959999	0.001 MIN
HOURS					
HHHHHH	999999	1 HR	HHMM55	995959	1 SEC
HHHHHH	999999	0.1 HR	HM5555	959599	0.1 SEC
HHHHHH	999999	0.01 HR	DAYS/HOURS/MINUTES		
HHHHHH	999999	0.001 HR	ddMMMM	992359	1 MIN

TIMER INPUT OPERATION

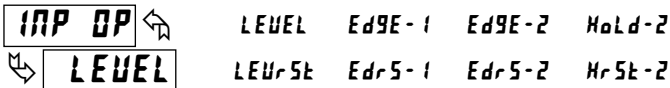

This parameter determines how the Timer Input Signals affect the "Run/Stop" status of the Timer. The timing diagrams below reflect a Sinking input setup (active low). A Sourcing input setup (active high) is available through plug jumper selection (see Section 2.0). In this case, the logic levels of the timing diagrams would be inverted.

The Timer can also be stopped using a Timer Stop Value or a Setpoint. This type of Stop condition is cleared when a Timer Reset occurs, or another start edge is applied.

For **LEVEL** and **Ed9E-1** operation, Input B provides a level active Timer Inhibit function. This function is also available through a User Input (see Module 2). Timing diagrams are shown below for "**LEVEL**" through "**HoLd-2**" modes. The "**LEUrSt**" through "**MrSt-2**" modes are identical except the timer display value is also reset at "Time Start" edges. In the "**HoLd-2**" and "**MrSt-2**" modes, the timer display value remains held and only updates when a Timer Start (Input A) or Timer Stop (Input B) edge occurs.

LEVEL, LEUrSt *

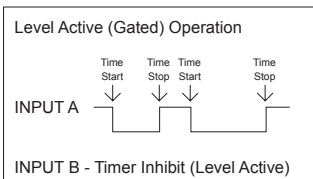

Ed9E-1, Edr5-1 *

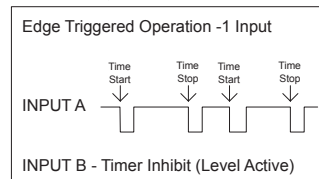

* - Timer is reset at Time Start edge.

Ed9E-2, Edr5-2 *

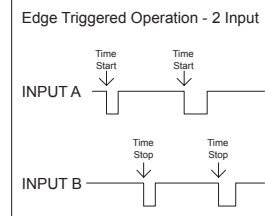

HoLd-2, MrSt-2 *

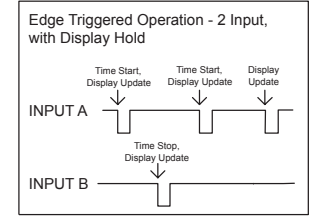

* - Timer is reset at Time Start edge.

TIMER INPUT FILTERING

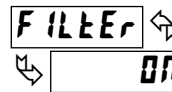

Provides a 50 msec debounce for the Timer Inputs (A and B). Select **ON** when using relays or switch contacts as a signal source.

TIMING DIRECTION

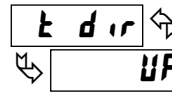

Timing direction can be reversed through a User Input. (See Module 2.)

TIMER START VALUE

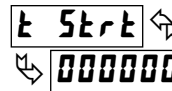

The Timer returns to this value whenever a Timer Reset occurs. The value is entered in the same display format as the Timer Range selected. Non-zero values are normally used for "timing down" applications, but they can also provide an "offset" value when timing up.

TIMER STOP VALUE

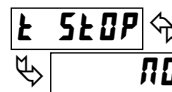

The Timer stops when this value is reached, regardless of the signal levels on the Timer Inputs. Selecting **YES** will display the **VALUE** sub-menu where the Stop Value can be set or changed. The Stop Value is entered in the same display format as the Timer Range selected. This Stop condition is cleared when a Timer Reset occurs. Select **NO** if a Stop Value is not being used.



FLASH TIMER ANNUNCIATOR



This parameter allows the Timer annunciator (TMR) to flash when the Timer is running or stopped/inhibited. Select **NO** if a flashing indicator is not desired.

TIMER RESET AT POWER-UP



The Timer can be programmed to Reset at each meter power-up.

TIMER INPUT STATE AT POWER-UP



Determines the "Run/Stop" State of the Timer at Power-up. This parameter does not apply to **LEVEL** timer input operation.

STOP - Timer Stopped at power-up, regardless of prior run/stop state

SAME - Timer assumes the same run/stop state it was in prior to power-down

6.2 MODULE 2 - USER INPUT AND FRONT PANEL FUNCTION KEY PARAMETERS (2-FNC)

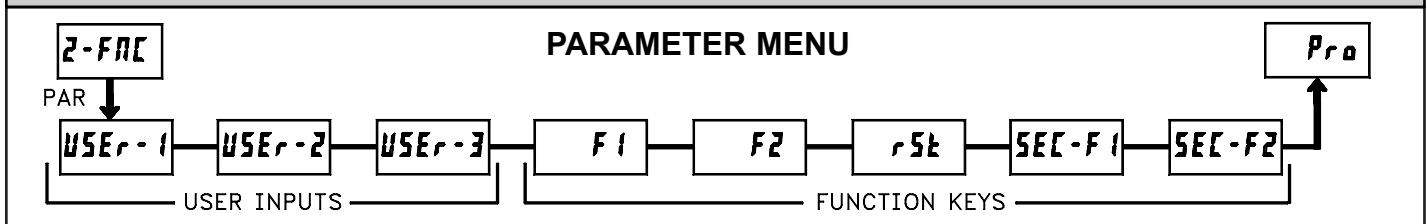

Module 2 is the programming module for the rear terminal User Inputs and front panel Function Keys.

Three rear terminal User Inputs are individually programmable to perform specific meter control functions. While in the Display Mode, the function is executed when the User Input transitions to the active state. Refer to the User Input specifications for active state response times. Certain User Input functions are disabled in "Full" Programming Mode. User Inputs should be programmed while in the inactive state.

Three front panel Function Keys, **F1**, **F2** and **RST**, are also individually programmable to perform specific meter control functions. While in the Display Mode, the primary function is executed when the key is pressed. Holding the **F1** or **F2** Function Keys for three seconds executes a secondary function. It is possible to program a secondary function without a primary function. The front panel key functions are disabled in both Programming Modes.

In most cases, if more than one User Input and/or Function Key is programmed for the same function, the maintained (level active) functions will be performed while at least one of those User Inputs or Function Keys are activated. The momentary (edge triggered) functions are performed every time any of those User Inputs or Function Keys transition to the active state.

Some functions have a sublist of parameters, which appears when **PAR** is pressed at the listed function. A sublist provides yes/no selection for Display Values or Setpoints which pertain to the programmed function. The function will only be performed on the parameters entered as **YES** in the sublist. If a User Input or Function Key is configured for a function with a sublist, then that sublist will need to be scrolled through each time, in order to access any parameters for the User Inputs or Function Keys which follow.

NO FUNCTION



With this selection, NO function is performed. This is the factory setting for all user inputs and function keys except the Reset (**RST**) Key.

PROGRAMMING MODE LOCK-OUT

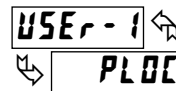

Programming Mode is locked-out, as long as activated (maintained action). In Module 3, certain parameters can be setup where they are still accessible during Programming Mode Lock-out. A security code can be configured to allow complete programming access during User Input lock-out. This parameter does not apply to the function keys. Program only one user input for this function.

EXCHANGE PARAMETER LISTS



Two lists of parameter entries are available for the Timer/Counter Start and Stop Values; Setpoint On/Off and Time-Out Values; and Setpoint Daily On/Off Occurrence (for Real-Time Clock option). The two lists are named **L15E-A** and **L15E-B**. If a User Input is used to select the list, then **L15E-A** is selected when the User Input is in the inactive state and **L15E-B** is selected when the User Input is in the active state (maintained action). If a front panel Function Key is used to select the list, then the list will toggle for each key press (momentary action). The display will only indicate which list is active when the list is changed or when entering any Programming Mode.

To program the values for **L15E-A** and **L15E-B**, first complete the programming of all the parameters. Exit programming and switch to the other list. Re-enter programming and enter the Timer/Counter Start and Stop Values (**E STrk**, **t SStOP**, **E STrk**, **E SStOP**), and if applicable, the Setpoint On/Off and Time-Out Values (**SP-1**, **SP-2**, **SP-3**, **SP-4**, **SPDF-1**, **SPDF-2**, **SPDF-3**, **SPDF-4**, **tOUT-1**, **tOUT-2**, **tOUT-3**, **tOUT-4**), and the Setpoint Daily On/Off Occurrence (**d ON-1**, **d ON-2**, **d ON-3**, **d ON-4**, **dOFF-1**, **dOFF-2**, **dOFF-3**, **dOFF-4**). If any other parameters are changed, the other list values must be reprogrammed. Program only one user input for this function.

Note: When downloading a software program containing List A/B, make sure that both the software and meter have the same list active. The active list in a software program is the one being displayed in Input Setup and/or Setpoint Alarms category.

DISPLAY SELECT (Level Active)

USER-1
dSEL-L

When active (maintained action), the meter continuously scrolls through all displays that are not “locked-out” in the Display mode. (See Module 3 for Display Lock-out details.) A sub-menu provides Scrolling Speed selection.

SPEED
2.5 SEC 5 SEC

DISPLAY SELECT (Edge Triggered)

USER-1
dSEL-E

When activated (momentary action), the meter advances to the next display that is not “locked-out” in the Display mode. (See Module 3 for Display Lock-out details.)

DISPLAY RESET (Level Active)

USER-1
drSt-L

When active (maintained action), the meter continually resets only the currently shown display. If the RTC Time or Date is displayed, this function applies to the **Outputs** assigned to the RTC, and does not Reset the actual RTC Time or Date display. (See Module 6 for details on Output Assignment and Output Reset with Display Reset.)

DISPLAY RESET (Edge Triggered)

USER-1
drSt-E

When activated (momentary action), the meter resets **only** the currently shown display. This is the factory setting for the Reset (**RST**) key. If the RTC Time or Date is displayed, this function applies to the **Outputs** assigned to the RTC, and does not Reset the actual RTC Time or Date display. (See Module 6 for details on Output Assignment and Output Reset with Display Reset.)

MAINTAINED RESET (Level Active)

USER-1
rSt-L

When active (maintained action), the meter continually resets the displays entered as **YES** in the sublist. The sublist appears when the **PAR** key is pressed. This function does not apply to the RTC Time or Date displays.

DISPLAY	DESCRIPTION	FACTORY
t-dSP	Timer	NO
C-dSP	Cycle Counter	NO

MOMENTARY RESET (Edge Triggered)

USER-1
rSt-E

When activated (momentary action), the meter resets the displays entered as **YES** in the sublist. Function does not apply to RTC Time or Date displays.

DISPLAY	DESCRIPTION	FACTORY
t-dSP	Timer	NO
C-dSP	Cycle Counter	NO

DISPLAY HOLD (Level Active)

USER-1
d-HOLD

When active (maintained action), the meter “freezes” the display values entered as **YES** in the sublist, while normal meter operation continues internally. Program only one user input for this function.

DISPLAY	DESCRIPTION	FACTORY
t-dSP	Timer	NO
C-dSP	Cycle Counter	NO
rEt-d	RTC Date	NO
rEt-t	RTC Time	NO

DISPLAY HOLD and RESET (Level Active Reset)

USER-1
HrSt-L

When activated, the meter “freezes” the display values entered as **YES** in the sublist, before performing an internal **Maintained Reset** on the selected displays. This function does not apply to the RTC Time or Date displays.

DISPLAY	DESCRIPTION	FACTORY
t-dSP	Timer	NO
C-dSP	Cycle Counter	NO

DISPLAY HOLD and RESET (Edge Triggered Reset)

USER-1
HrSt-E

When activated, the meter “freezes” the display values entered as **YES** in the sublist, before performing an internal **Momentary Reset** on the selected displays. This function does not apply to the RTC Time or Date displays. Program only one user input for this function.

DISPLAY	DESCRIPTION	FACTORY
t-dSP	Timer	NO
C-dSP	Cycle Counter	NO

INHIBIT (Level Active)

USER-1
INH Lt

When active (maintained action), timing and counting ceases for the displays entered as **YES** in the sublist. The inhibit function is not a **t StEt** or **C StOP** event in Setpoint programming. This function does not apply to RTC Time or Date displays. Program only one user input for this function.

DISPLAY	DESCRIPTION	FACTORY
t-dSP	Timer	NO
C-dSP	Cycle Counter	NO

CHANGE DIRECTION (Level Active)

USER-1
Ch-dir

When active (maintained action), the timing or counting direction for the display entered as **YES** in the sublist, will be reversed from the direction set by the Timing Direction (**t-dir**) and/or Counting Direction (**C-dir**) parameters in Modules 1 and 4. (Program only one User Input per display for this function.) This function does not apply to RTC Time or Date displays.

DISPLAY	DESCRIPTION	FACTORY
t-dSP	Timer	NO
C-dSP	Cycle Counter	NO

CHANGE DISPLAY INTENSITY LEVEL



When activated (momentary action), the display intensity changes to the next intensity level (of 4). The four levels correspond to Display Intensity Level (*d-LEU*) settings of 0, 3, 8 & 15. The intensity level, when changed via the User Input/Function Key, is not retained at power-down, unless Quick Programming or Full Programming mode is entered and exited. The unit will power-up at the last saved intensity level.

Note: The next two parameters only appear when an RS232 or RS485 Serial Communications Card is installed in the meter.

PRINT REQUEST



When activated, the meter issues a block print through the serial port. The specific values transmitted during a print request are selected with the Print Options parameter in Module 7. For User Inputs (level active), the meter transmits blocks repeatedly as long as the input is active. For Function Keys, (edge triggered) only one block is transmitted per key press.

PRINT REQUEST and RESET (Edge Triggered)



When activated (momentary action), the meter first issues a block print through the serial port, and then performs a *Momentary Reset* on the displays entered as *YES* in the sublist. The specific values transmitted in the print block are selected with the Print Options parameter in Module 7. Only one transmit and reset occurs per User Input activation or Function Key press.

DISPLAY	DESCRIPTION	FACTORY
<i>t-dSP</i>	Timer	<i>NO</i>
<i>C-dSP</i>	Cycle Counter	<i>NO</i>

Note: The remaining parameters only appear when a Setpoint Card is installed in the meter.

OUTPUT HOLD (Level Active)



When active (maintained action), the meter "holds" (maintains) the present output state for all Setpoints entered as *YES* in the sublist. Does not apply to Output Set and Reset User Inputs. Program only one user input for this function.

DISPLAY	DESCRIPTION	FACTORY
<i>SP-1</i>	Setpoint 1	<i>NO</i>
<i>SP-2</i>	Setpoint 2	<i>NO</i>
<i>SP-3</i>	Setpoint 3	<i>NO</i>
<i>SP-4</i>	Setpoint 4	<i>NO</i>

OUTPUT SET (Level Active)



When activated (maintained action), the meter continually activates the output for all Setpoints entered as *YES* in the sublist.

DISPLAY	DESCRIPTION	FACTORY
<i>SP-1</i>	Setpoint 1	<i>NO</i>
<i>SP-2</i>	Setpoint 2	<i>NO</i>
<i>SP-3</i>	Setpoint 3	<i>NO</i>
<i>SP-4</i>	Setpoint 4	<i>NO</i>

OUTPUT SET (Edge Triggered)



When activated (momentary action), the meter activates the output for all Setpoints entered as *YES* in the sublist.

DISPLAY	DESCRIPTION	FACTORY
<i>SP-1</i>	Setpoint 1	<i>NO</i>
<i>SP-2</i>	Setpoint 2	<i>NO</i>
<i>SP-3</i>	Setpoint 3	<i>NO</i>
<i>SP-4</i>	Setpoint 4	<i>NO</i>

OUTPUT RESET (Level Active)



When activated (maintained action), the meter continually deactivates the output for all Setpoints entered as *YES* in the sublist.

DISPLAY	DESCRIPTION	FACTORY
<i>SP-1</i>	Setpoint 1	<i>NO</i>
<i>SP-2</i>	Setpoint 2	<i>NO</i>
<i>SP-3</i>	Setpoint 3	<i>NO</i>
<i>SP-4</i>	Setpoint 4	<i>NO</i>

OUTPUT RESET (Edge Triggered)



When activated (momentary action), the meter deactivates the output for all Setpoints entered as *YES* in the sublist.

DISPLAY	DESCRIPTION	FACTORY
<i>SP-1</i>	Setpoint 1	<i>NO</i>
<i>SP-2</i>	Setpoint 2	<i>NO</i>
<i>SP-3</i>	Setpoint 3	<i>NO</i>
<i>SP-4</i>	Setpoint 4	<i>NO</i>

6.3 MODULE 3 - DISPLAY AND PROGRAM LOCK-OUT PARAMETERS (3-LOC)

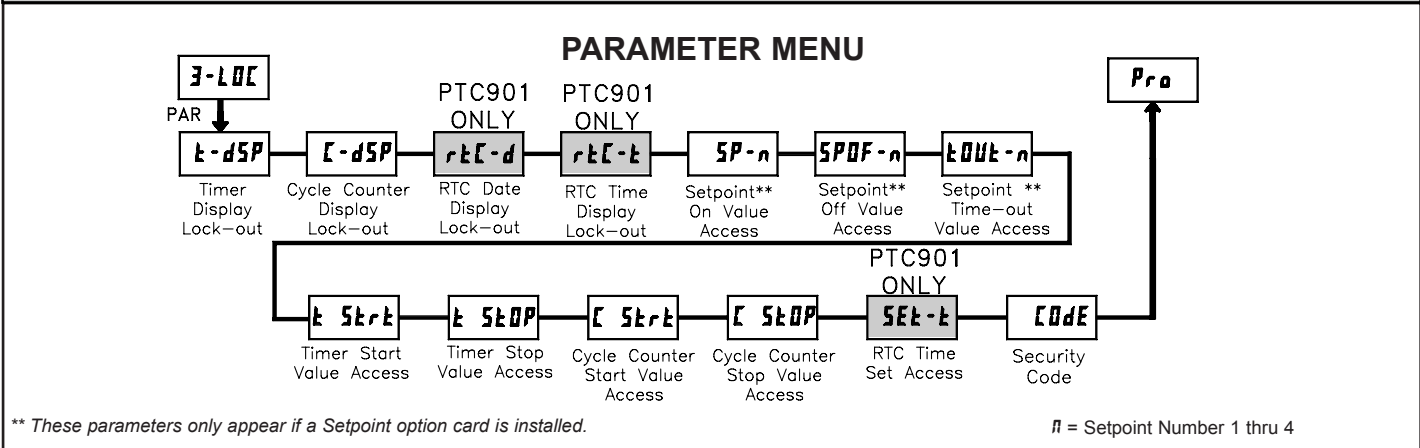

Module 3 is the programming module for setting the Display Lock-out Parameters and the “Quick Programming Mode” Value Access Parameters. In the Quick Programming mode, after the PROGRAM LOCKOUT PARAMETERS and before the Security Code (CODE), a Display Intensity Level (d-LEU) parameter is available when the security code is non-zero. It allows the display intensity to be set to 1 of 16 levels (0-15).

DISPLAY LOCK-OUT PARAMETERS

When operating in the Display Mode, the meter displays can be viewed consecutively by repeatedly pressing the DSP key. The annunciators to the left of the display indicate which display is currently shown. Timer (TMR), Cycle Counter (CNT), or Date (DAT). The Time Display for the Real-Time Clock is shown with no annunciator. Any of these displays can be locked from view with the DISPLAY LOCK-OUT parameters. Using these parameters, each display can be programmed for “Read” or “Lock” defined as follows:

SELECTION	DISPLAY	DESCRIPTION
Read	rEd	Visible in Display Mode
Lock	LOC	Not visible in Display Mode

TIMER DISPLAY LOCK-OUT CYCLE COUNTER DISPLAY LOCK-OUT

PTC901: REAL-TIME CLOCK DATE/TIME DISPLAY LOCK-OUT



These displays can be programmed for rEd or LOC. When a particular meter function is not used, the Display Lock-out should be set to LOC for that display.

PROGRAM LOCK-OUT PARAMETERS (VALUE ACCESS)

“Full” Programming Mode permits all parameters to be viewed and modified. This programming mode can be locked with a Security Code and/or a User Input. When locked, and the PAR key is pressed, the meter enters a Quick Programming Mode. In this mode, access to Setpoint Values, Timer & Cycle Counter Start/Stop Values, and Time Setting for the Real-Time Clock can be programmed for “Read”, “Enter”, or “Lock” defined as follows:

SELECTION	DISPLAY	DESCRIPTION
Read	rEd	Visible, not changeable, in Quick Programming Mode
Enter	ENt	Visible and changeable in Quick Programming Mode
Lock	LOC	Not visible in Quick Programming Mode

SETPOINT 1 to 4 VALUE ACCESS ** (n = 1 thru 4)

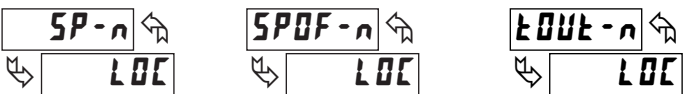

Setpoint Values for SP1 thru SP4 can be programmed for rEd, ENt, or LOC. SPOF-n and tOUT-n are only displayed when they apply to the Setpoint Action (REt-n) programmed for that particular Setpoint. (See Module 6 for details.)

TIMER & CYCLE COUNTER START/STOP VALUE ACCESS

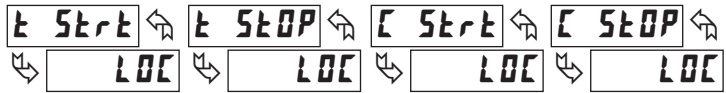

Timer & Counter Start/Stop Values can be programmed for rEd, ENt, or LOC.

PTC901: REAL-TIME CLOCK TIME SETTING ACCESS



This parameter can be programmed for ENt or LOC. Selecting ENt allows setting or changing the RTC Time in Quick Programming mode.

SECURITY CODE



Entry of a non-zero value will cause the CODE prompt to appear when trying to access the “Full” Programming Mode. Access will only be allowed after entering a matching security code or the universal unlock code of 222. With this lock-out, a User Input would not have to be used for the Program Lock-out function. Note however, the Security Code lock-out is overridden when an User Input, configured for Program Lock-out (PLOC), is not active (See Chart.)

PROGRAMMING MODE ACCESS

SECURITY CODE	USER INPUT SELECTION	USER INPUT STATE	MODE WHEN “PAR” KEY IS PRESSED	FULL PROGRAMMING MODE ACCESS
0	not PLOC	————	Full Programming	Immediate access
not 0	not PLOC	————	Quick Programming	After Quick Programming with correct Security code entry
not 0	PLOC	Active	Quick Programming	After Quick Programming with correct Security code entry
not 0	PLOC	Not Active	Full Programming	Immediate access
0	PLOC	Active	Quick Programming	No access
0	PLOC	Not Active	Full Programming	Immediate access

Throughout this bulletin, Programming Mode (without Quick in front) always refers to “Full” Programming.

6.4 MODULE 4 - CYCLE COUNTER PARAMETERS (4-CNT)

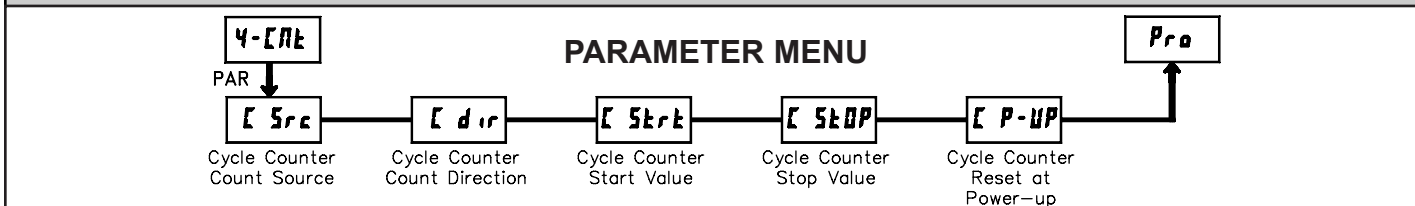

Module 4 is the programming module for the Cycle Counter Parameters. In the Display Mode, the CNT annunciator indicates the Cycle Counter display is currently being shown. An **EXCHANGE PARAMETER LISTS** feature, which includes the Cycle Counter Start and Stop Values, is explained in Module 2.

CYCLE COUNTER COUNT SOURCE

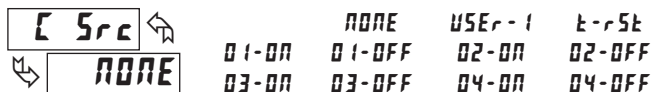

This parameter selects the source from which a count is added to or subtracted from the Cycle Counter. Select **NONE** if the Cycle Counter is not being used, which will exit the module and bypass the remaining parameters.

When **USER-1** is selected, a count is generated each time the User 1 Input is activated. When selected as the count source, User Input 1 can still be programmed to perform a User Function described in Module 2, if desired. In this case, the Cycle Counter would be counting the number of times the particular User Function occurred.

The Timer Reset (**t-rSt**) selection generates a count when either a manual or automatic reset occurs. (See Module 6 for programming Automatic Resets.)

The Output ON/OFF selections generate a count when the chosen output either activates or deactivates. These selections only appear when a Setpoint Card is installed. O3 and O4 selections only appear for Quad Setpoint cards.

CYCLE COUNTER COUNTING DIRECTION



Counting direction can be reversed through a User Input. (See Module 2.)

CYCLE COUNTER START VALUE



The Cycle Counter returns to this value whenever a Cycle Counter Reset occurs. Non-zero values are normally used for “down counting” applications, but they can also provide an “offset” value when counting up.

CYCLE COUNTER STOP VALUE



The Cycle Counter stops counting when this value is reached, regardless of the operation of the Timer. Selecting **YES** will display the **VALUE** sub-menu where the Stop Value can be set or changed. The Stop condition is cleared when a Cycle Counter Reset occurs. Select **NO** if a Stop Value is not used.



CYCLE COUNTER RESET AT POWER-UP



The Cycle Counter can be programmed to Reset at each meter power-up.

6.5 MODULE 5 - TIMER OPERATING MODES (5-OPER)

This module can only be accessed if a Setpoint Card is installed.

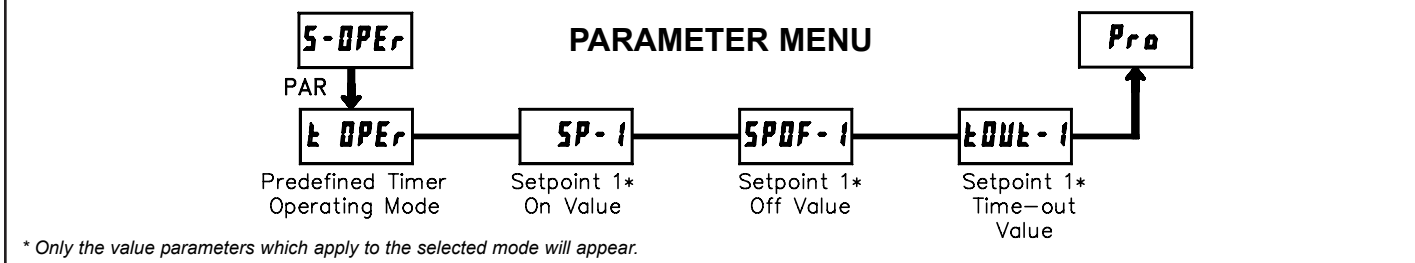

* Only the value parameters which apply to the selected mode will appear.

PREDEFINED TIMER OPERATING MODE

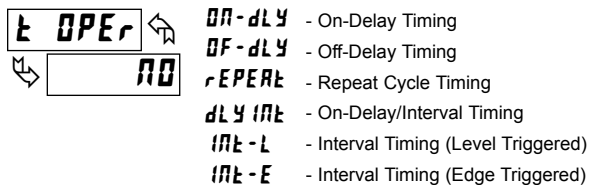

This parameter is used to select Predefined Operating Modes for the Timer. These modes cover a variety of timing applications frequently encountered in industrial control processes. When using a Predefined mode, the operator needs only to set the actual Setpoint On/Off or Time-out values for the particular application. However, each programming parameter will still be accessible, in order to make modifications to the predefined settings if desired.

The Predefined modes control the activation and deactivation of Output 1, in relation to Start and Reset signals applied to the Timer inputs. (See timing diagrams which follow.) When a selection other than **NO** is chosen, the parameters for Setpoint 1 (**SP-1**) in Module 6 are automatically configured to implement the selected operating mode. For some modes, parameters in Modules 1 and 2 are also automatically configured to properly implement the predefined mode. Refer to the chart shown with the timing diagrams for the specific parameters loaded for each predefined mode. Also, note the specific external wiring or plug jumper settings required for some modes.

The Setpoint On/Off or Time-out values for the specific application should be entered directly in Module 5 after selecting the operating mode. Only the value parameters which apply to the selected mode are displayed. These values can also be entered through Module 6, Setpoint (Alarm) Parameters, if desired.

Select **NO** if not using a Predefined Operating Mode, in which case Setpoint parameters must all be individually programmed for the particular application.

Timing Diagrams for Predefined Timer Operating Modes

NOTE: Input A is shown as a Sourcing input (active high). If a Sinking input (active low) is used, the logic levels for Input A would be inverted.

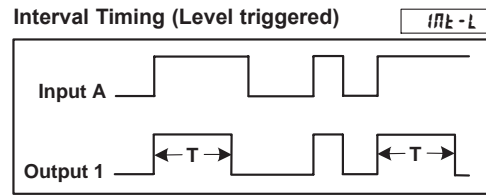
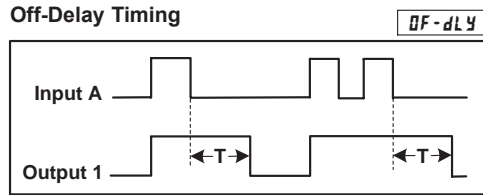
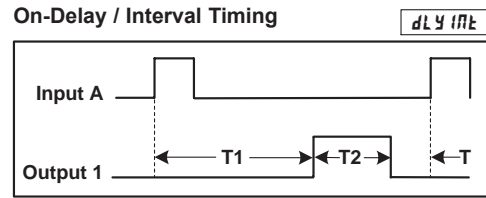
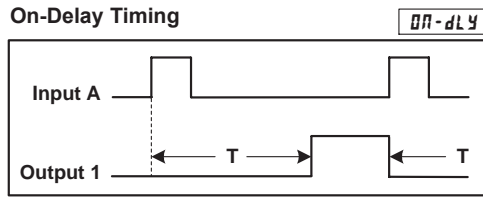

The input signal must be wired to both the Input A and User Input 1 terminals. The Timer Input plug jumper and the User Input plug jumper must both be set to the same position (either both SNK or both SRC).

The input signal must be wired to both the Input A and User Input 1 terminals. The Timer Input plug jumper and the User Input plug jumper must be set to opposite positions (one SNK, one SRC) and the Input signal must be a current sinking type (i.e. pulls input to common).

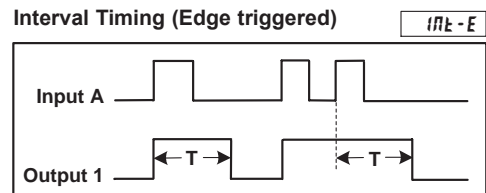
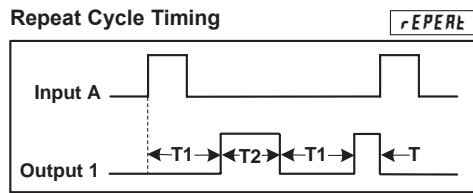

Parameter Settings for Predefined Timer Operating Modes

MODULE 1 - Timer Input Parameters (1-INP)

DISPLAY	PARAMETER	<u>ON-dLY</u>	<u>OF-dLY</u>	<u>rEPEAt</u>	<u>dLY INt</u>	<u>INt-L</u>	<u>INt-E</u>
<u>INP OP</u>	Timer Input Operation	<u>Edr5-2</u>	<u>Edr5-2</u>	<u>Edr5-2</u>	<u>Edr5-2</u>	<u>LEUr5t</u>	<u>Edr5-2</u>

MODULE 2 - User Input Parameters (2-FRt)

DISPLAY	PARAMETER	<u>ON-dLY</u>	<u>OF-dLY</u>	<u>rEPEAt</u>	<u>dLY INt</u>	<u>INt-L</u>	<u>INt-E</u>
<u>USEr-1</u>	User Input 1	N/A	<u>r5t-L</u>	N/A	N/A	<u>Or5t-E</u>	N/A
<u>r5t</u>	Reset Key	<u>NO</u>	<u>NO</u>	<u>NO</u>	<u>NO</u>	<u>(SP1-YES)</u> <u>NO</u>	<u>NO</u>

MODULE 6 - Setpoint Parameters (6-SPt)

DISPLAY	PARAMETER	<u>ON-dLY</u>	<u>OF-dLY</u>	<u>rEPEAt</u>	<u>dLY INt</u>	<u>INt-L</u>	<u>INt-E</u>
<u>SPSEL</u>	Setpoint Select	<u>SP-1</u>	<u>SP-1</u>	<u>SP-1</u>	<u>SP-1</u>	<u>SP-1</u>	<u>SP-1</u>
<u>ASP-1</u>	Setpoint Assignment	<u>t-dSP</u>	<u>t-dSP</u>	<u>t-dSP</u>	<u>t-dSP</u>	<u>t-dSP</u>	<u>t-dSP</u>
<u>Act-1</u>	Setpoint Action	<u>LARtCH</u>	<u>ON-OFF</u>	<u>ON-OFF</u>	<u>t-OUt</u>	<u>ON-OFF</u>	<u>t-OUt</u>
<u>OUt-1</u>	Output Logic	<u>NOr</u>	<u>NOr</u>	<u>NOr</u>	<u>NOr</u>	<u>NOr</u>	<u>NOr</u>
<u>ON-1</u>	Setpoint On	<u>URLUE</u>	<u>t-5t-rt</u>	<u>URLUE</u>	<u>URLUE</u>	<u>t-5t-rt</u>	<u>t-5t-rt</u>
<u>SP-1</u>	Setpoint On Value	T*	N/A	T1*	T1*	N/A	N/A
<u>OFF-1</u>	Setpoint Off	N/A	<u>URLUE</u>	<u>URLUE</u>	N/A	<u>URLUE</u>	N/A
<u>SPOF-1</u>	Setpoint Off Value	N/A	T*	T2*	N/A	T*	N/A
<u>tOUt-1</u>	Time-out Value	N/A	N/A	N/A	T2*	N/A	T*
<u>t5tP-1</u>	Timer Stop	<u>NO</u>	<u>0-OFF</u>	<u>NO</u>	<u>0-OFF</u>	<u>0-OFF</u>	<u>0-OFF</u>
<u>AutO-1</u>	Timer/Counter Auto Reset	<u>NO</u>	<u>NO</u>	<u>0-OFF</u>	<u>NO</u>	<u>NO</u>	<u>NO</u>
<u>Or5d-1</u>	Output Reset w/display Reset	<u>NO</u>	<u>NO</u>	<u>NO</u>	<u>NO</u>	<u>NO</u>	<u>NO</u>
<u>Lt-1</u>	Setpoint Annunciator	<u>NOr</u>	<u>NOr</u>	<u>NOr</u>	<u>NOr</u>	<u>NOr</u>	<u>NOr</u>
<u>P-UP-1</u>	Power-up State	<u>OFF</u>	<u>OFF</u>	<u>OFF</u>	<u>OFF</u>	<u>OFF</u>	<u>OFF</u>

* Refer to timing diagrams. These parameters are the actual Setpoint On/Off or Time-Out values set by the user for the specific application.

6.6 MODULE 6 - SETPOINT (ALARM) PARAMETERS (6-5Pt)

This module can only be accessed if a Setpoint Card is installed.

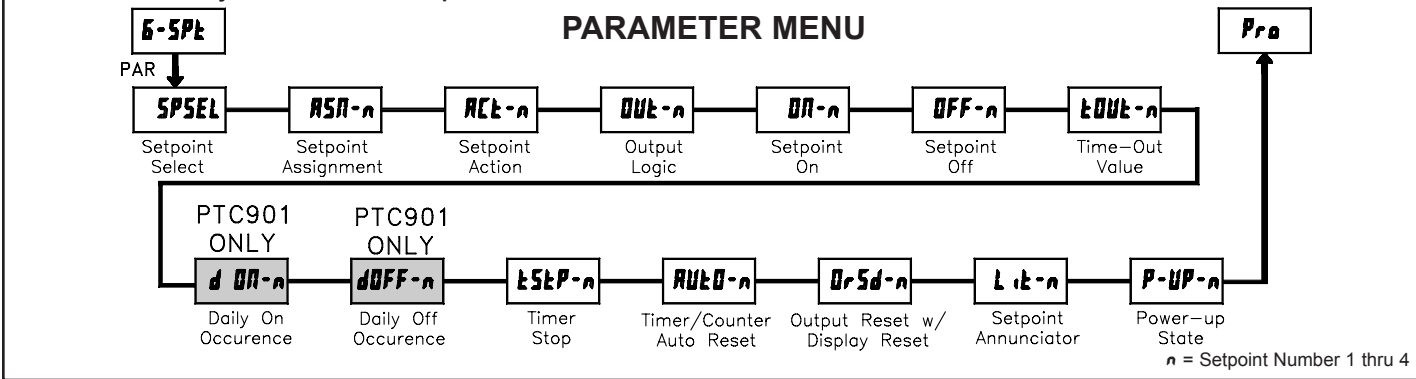

Module 6 is the programming module for the Setpoint (Alarm) Output Parameters. This programming module can only be accessed if a Setpoint card is installed. Depending on the card installed, there will be two or four Setpoint outputs available. The Setpoint Assignment and Setpoint Action parameters determine the applicable Setpoint features, and dictate which subsequent parameters will appear for the Setpoint being programmed.

This section of the bulletin replaces the bulletin shipped with the Dual and Quad Setpoint plug-in cards. Discard the separate bulletin when using Setpoint plug-in cards with the PTC901 and PTC900.

SETPOINT SELECT



Select the Setpoint (alarm) output to be programmed. This provides access to the parameters for that particular Setpoint. The “n” in the following parameter displays, reflects the chosen Setpoint number (1 thru 4). After the chosen Setpoint is programmed, the display returns to **SPSEL NO**. Select the next Setpoint to be programmed and continue this sequence for each Setpoint. Select **NO** to exit the module. **SP-3** and **SP-4** apply to Quad Setpoint cards only.

SETPOINT ASSIGNMENT



Select the meter display to which the Setpoint is assigned: Timer (**t-dSP**), Cycle Counter (**t-dSP**), Real-Time Clock Date display (**rtk-d**) or Real-Time Clock Time display (**rtk-t**). (The **rtk-d** and **rtk-t** selections only appear if a Real-Time Clock option card is installed.)

By selecting **NONE**, the Setpoint is not assigned to a specific display. However, the output can still be activated (set) and deactivated (reset) by various “events”. Such events include the Timer starting or stopping, or another Setpoint output turning On or Off. The output can also be set and reset through a User Input function or through serial communications.

SETPOINT ACTION



This parameter determines the mode for output *deactivation* as shown below. Output *activation* is controlled by the **SETPOINT ON** parameter setting.

DISPLAY	DESCRIPTION	OUTPUT DEACTIVATES
LATCH	Latched Output Mode	At Reset (Manual or Automatic)
t-OUT	Timed Output Mode	After “Time-Out Value” Elapses
ON-OFF	On-Off Output Mode	Based on “Setpoint Off” Setting

The **t-OUT** and **ON-OFF** selections are not available when Setpoint is assigned to **rtk-d**.

OUTPUT LOGIC



Normal Output Logic (**NOR**) turns the output “on” when activated and “off” when deactivated. Reverse Output Logic (**REV**) turns the output “off” when activated and “on” when deactivated.

SETPOINT ON

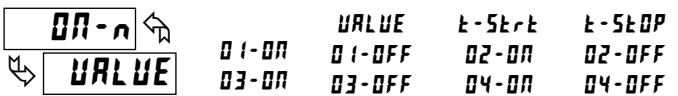

This parameter determines when the Setpoint output will activate. Output activation can occur at a specific Setpoint Value (**VALUE**) or can be triggered by various “events”, as shown in the parameter list. Such events include the Timer starting (**t-Start**) or stopping (**t-Stop**), or by the action (event) that causes another Setpoint output to turn On or Off. When programmed for an event, the Setpoint must not be used as the Setpoint On event for another Setpoint.

Selecting **VALUE** displays a sub-menu where the Setpoint value is entered. The Setpoint value is based on the meter display to which the Setpoint is assigned (**ASN-n**). When assigned to the Timer or Cycle Counter, the Setpoint value is entered in the same format as the assigned display. When assigned to the Real-Time Clock Date Display (**rtk-d**), the date value is entered in month.day.year format (**mmddyy**). When assigned to the Real-Time Clock Time Display (**rtk-t**), the Setpoint value is always entered in **HH-MM** format (Hours-Minutes with AM/PM selection). In Setpoint One-shot mode (See Daily On Occurrence), the One-shot Setpoint is enabled (armed) by scrolling the AM/PM digit until the 2nd digit decimal point is lit.



SETPOINT OFF

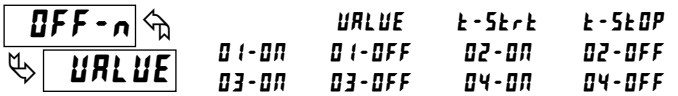

The Setpoint Off parameter only appears when the Setpoint Action (**ACT-n**) is programmed for On-Off Output mode (**ON-OFF**). In this mode, this parameter determines when the Setpoint output will deactivate. Output deactivation can occur at a specific Setpoint Off Value (**VALUE**) or can be triggered by various “events”, as shown in the parameter list. Such events include the Timer starting (**t-Start**) or stopping (**t-Stop**), or by the action (event) that causes another Setpoint output to turn On or Off. When programmed for an event, the Setpoint must not be used as the Setpoint Off event for another Setpoint.

Selecting **VALUE** will display a sub-menu where the Setpoint Off value is entered. The Setpoint Off value is based on the meter display to which the Setpoint is assigned (**ASN-n**). When assigned to the Timer or Cycle Counter, the value is entered in the same format as the assigned display. When assigned to the Real-Time Clock Date Display (**rtk-d**), the date value is entered in month.day.year format (**mmddyy**). When assigned to the Real-Time Clock Time Display (**rtk-t**), the value is always entered in **HH-MM** format (Hours-Minutes with AM/PM selection).



TIME-OUT VALUE



000002 to 995999

The Time-Out Value only appears when the Setpoint Action (**Act-n**) is programmed for Timed Output mode (**t-OUT**). In this mode, the Time-Out Value is the Setpoint Output time duration, from activation to deactivation. This value is always entered in minutes, seconds, and hundredths of seconds format. The maximum Time-Out Value is 99 minutes 59.99 seconds.

TIMER STOP

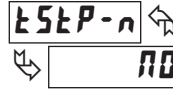

NO 0-ON 0-OFF

Timer stops when the Setpoint output activates (**0-ON**) or deactivates (**0-OFF**). Select **NO** if the output should not affect the Timer Run/Stop status.

Stopping the Timer as a result of this parameter does not constitute a **t-StOP** condition (event) for the Setpoint On or Setpoint Off parameters.

PTC901: DAILY ON OCCURRENCE



NO YES

This parameter only appears when the Setpoint is assigned (**ASP-n**) to the Real-Time Clock Time display (**rLE-t**). This parameter determines the days of the week when the Setpoint output will activate.

Selecting **YES** displays a sublist for choosing the days of the week. On all days entered as **YES** in the sublist, the output will activate. On all days entered as **NO**, the output will not activate. The output activation is repetitive, and will occur every week on the chosen day(s).

DISPLAY	DESCRIPTION	FACTORY
Sun	Sunday	NO
Mon	Monday	YES
Tue	Tuesday	YES
Wed	Wednesday	YES
Thu	Thursday	YES
Fri	Friday	YES
Sat	Saturday	NO

Setpoint One-Shot Mode

If all days are set to **NO**, the Setpoint will operate in “One-shot” mode. When a One-shot setpoint is enabled (armed), the setpoint output will activate at the set time and disable itself from activating again. To enable or re-enable a one-shot alarm, go to the Setpoint value entry display and press the Up or Dn key repeatedly while the AM/PM digit is selected (flashing). When the 2nd digit decimal point is lit, the Setpoint is enabled. The Setpoint enable status is saved at power-down. The enable state of the Setpoint is not affected or changed when the Parameter List is exchanged.

The setpoint will turn off (de-activate) as programmed per the Setpoint Action selected. If **0n-OFF** mode is selected, program all the Daily Off days to **YES** to have the Setpoint turn off at the next Daily Off Occurrence. The One-shot status can also be viewed or set from the Setpoint Off value entry display.

TIMER/COUNTER AUTO RESET



NO 0-ON 0-OFF

When the Setpoint output activates (**0-ON**) or deactivates (**0-OFF**), the meter automatically resets the Setpoint Assignment display (**ASP-n**). Select **NO** if the Setpoint output should not cause the assigned display to reset. Does not apply to manual activations or deactivations by user input, function key, or serial communications.

OUTPUT RESET WITH DISPLAY RESET

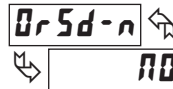

NO YES

When **YES** is selected, the Setpoint output will reset when the Setpoint Assignment display (**ASP-n**) resets. Select **NO** if the Setpoint output should not reset when the assigned display resets.

SETPOINT ANNUNCIATOR

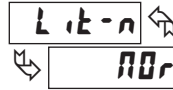

NOr rEU FLASH OFF

This parameter controls the illumination of the LED annunciator for the corresponding Setpoint output (**SPn**) as follows:

- Normal (**NOr**) – Annunciator displayed when output is “on” (activated)
- Reverse (**rEU**) – Annunciator displayed when output is “off” (deactivated)
- Flash (**FLASH**) – Annunciator and display flashes when output is “on” (activated)
- Off (**OFF**) – Annunciator disabled

PTC901: DAILY OFF OCCURRENCE



NO YES

This parameter only appears when the Setpoint is assigned (**ASP-n**) to the Real-Time Clock Time display (**rLE-t**) and when the Setpoint Action (**Act-n**) is programmed for On-Off Output mode (**0n-OFF**). In this mode, this parameter determines the days of the week when the Setpoint output will deactivate.

Selecting **YES** displays a sublist for choosing the days of the week. On all days entered as **YES** in the sublist, the output will deactivate. On all days entered as **NO**, the output will not deactivate. The output deactivation is repetitive, and will occur every week on the chosen day(s).

DISPLAY	DESCRIPTION	FACTORY
Sun	Sunday	NO
Mon	Monday	YES
Tue	Tuesday	YES
Wed	Wednesday	YES
Thu	Thursday	YES
Fri	Friday	YES
Sat	Saturday	NO

SETPOINT POWER-UP STATE



OFF ON SAUE

Determines the on/off state of the Setpoint output at power-up. Regardless of output logic setting (normal or reverse).

- OFF** – Deactivates the Setpoint output at power-up
- ON** – Activates the Setpoint output at power-up
- SAUE** – Restores the output to the state it was in prior to power-down

6.7 MODULE 7 - SERIAL COMMUNICATIONS PARAMETERS (7-5rL)

This module can only be accessed if a Serial Communications Card is installed.

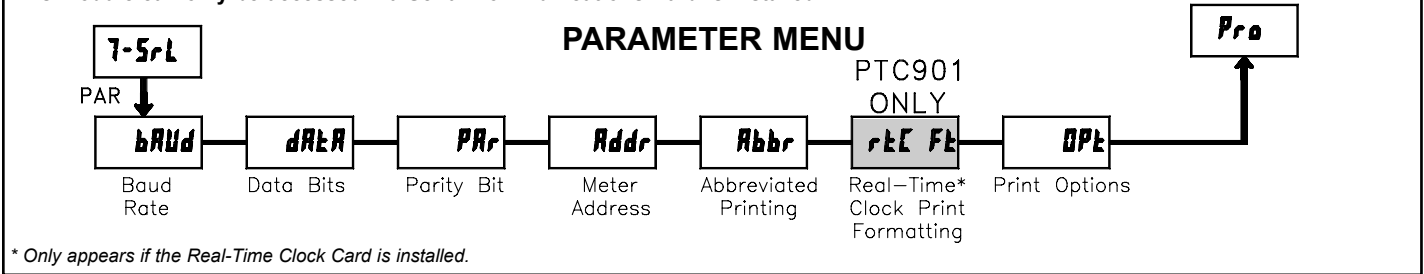

Module 7 is the programming module for the Serial Communications Parameters. These parameters are used to match the serial settings of the meter with those of the host computer or other serial device, such as a terminal or printer. This programming module can only be accessed if an RS232 or RS485 Serial Communications card is installed.

This section also includes an explanation of the commands and formatting required for communicating with the meter. In order to establish serial communications, the user must have host software that can send and receive ASCII characters. For serial hardware and wiring details, refer to section 4.5 Serial Communication Wiring.

This section of the PTC900/PTC901 bulletin replaces the bulletin shipped with the RS232 and RS485 serial communications plug-in cards. Discard the separate bulletin when using those serial plug-in cards with the PTC900/PTC901. Also, this section does NOT apply to the Modbus communication cards. For details on the operation of the Fieldbus cards, refer to the bulletin shipped with each card.

BAUD RATE

bAUd ←

↵

300	600	1200	2400
4800	9600	19200	

Set the baud rate to match the other serial communications equipment on the serial link. Normally, the baud rate is set to the highest value at which all the serial equipment are capable of transmitting and receiving data.

DATA BITS

dRtR ←

↵

7 8

Select either 7- or 8-bit data word lengths. Set the word length to match the other serial communications equipment on the serial link.

PARITY BIT

PRr ←

↵

NO Odd EVEN

This parameter only appears when the Data Bits parameter is set to a 7-bit data word length. Set the parity bit to match that of the other serial communications equipment on the serial link. The meter ignores parity when receiving data and sets the parity bit for outgoing data. If parity is set to NO, an additional stop bit is used to force the frame size to 10 bits.

METER ADDRESS

Addr ←

↵

00 to 99

Enter the serial meter (node) address. With a single meter, an address is not needed and a value of zero can be used. With multiple meters (RS485 applications), a unique 2 digit address number must be assigned to each meter.

Addresses 98 and 99 are reserved to configure a unit as a serial real-time clock master. See Serial Real-time Clock Master Addressing.

ABBREVIATED PRINTING

Abbr ←

↵

NO YES

This parameter determines the formatting of data transmitted from the meter in response to a Transmit Value (T) command or a Block Print Request (P) command. Select NO for a Full print transmission, which consists of the meter address, mnemonics, and parameter data. Select YES for abbreviated print transmissions, consisting of the parameter data only. This setting affects all the parameters selected in the PRINT OPTIONS. (Note: If the meter address is 00, the address will not be sent during a Full transmission.)

PTC901: REAL-TIME CLOCK PRINT FORMATTING

rTc Ft ←

↵

NO YES

This parameter determines the formatting of the Real-Time Clock (RTC) values transmitted from the meter in response to a Transmit Value (T) command or a Block Print Request (P) command. This parameter appears only when a Real-Time Clock plug-in option card is installed.

When YES is selected, RTC values are formatted as per the RTC Time and Date Display Formats programmed in Module 8. The Day of Week value is sent as a character string.

When NO is selected, the meter sends the RTC values as numeric data only. RTC Time/Date units are separated by a ".". The Day is sent as a single number as shown below.

- TIME - Hours (24-Hr. format), Minutes, Seconds (HHMMSS)
- DATE - Month, Day, Year (mmdyy)
- DAY - 1 = Sunday thru 7 = Saturday

PRINT OPTIONS

OPT ←

↵

This parameter selects the meter values transmitted in response to a Print Request. A Print Request is sometimes referred to as a block print because more than one parameter can be sent to a printer or computer as a block.

Selecting YES displays a sublist for choosing the meter parameters to appear in the block print. All parameters entered as YES in the sublist will be transmitted during a block print. Parameters entered as NO will not be sent.

DISPLAY	PARAMETER	FACTORY	MNEMONIC
t-dSP	Timer	YES	TMR
c-dSP	Cycle Counter	NO	CNT
rTc-d	RTC Date*	NO	DAT
rTc-t	RTC Time*	NO	TIM
SPt	Setpoint Values*	NO	SP1 SP2 SP3 SP4
SPtOF	Setpoint Off/Time-Out Values*	NO	SO1 SO2 SO3 SO4
StRStP	Timer/Cnt Start & Stop Values	NO	TST TSP CST CSP

* These values are plug-in card dependent.

SENDING SERIAL COMMANDS AND DATA

When sending commands to the meter, a string containing at least one command character must be constructed. A command string consists of a command character, a value identifier, numerical data (if writing data to the meter) followed by the command terminator character * or \$.

Command Chart

COMMAND	DESCRIPTION	NOTES
N	Node (Meter) Address Specifier	Address a specific meter. Must be followed by node address. Not required when address = 00.
T	Transmit Value (read)	Read a register from the meter. Must be followed by register ID character.
V	Value change (write)	Write to register of the meter. Must be followed by register ID character and numeric data.
R	Reset	Reset a register or output. Must be followed by register ID character
P	Block Print Request (read)	Initiates a block print output. Registers are defined in programming.

Command String Construction

The command string must be constructed in a specific sequence. The meter does not respond with an error message to invalid commands. The following procedure details construction of a command string:

1. The first characters consist of the Node Address Specifier (N) followed by a 1 or 2 character address number. The address number of the meter is programmable. If the node address is 0, this command and the node address itself may be omitted. The address suffix, “?” is the global broadcast address specifier. A command string that is sent with N? prefix will be accepted by all PAXCKs on the RS485 network (software code version 2.3 or greater). This is useful for setting all meters to the current time, date or day that may have unique meter addresses on a bus. It is important not to send (P)rint or (T)ransmit commands using N? prefix, as it will result in multiple meters responding at the same time. This is the only command that may be used in conjunction with other commands.
2. After the optional address specifier, the next character is the command character.
3. The next character is the Register ID. This identifies the register that the command affects. The P command does not require a Register ID character. It prints according to the selections made in print the options. If constructing a value change command (writing data), the numeric data is sent next.
4. All command strings must be terminated with the string termination characters * or \$. The meter does not begin processing the command string until this character is received. See Timing Diagram figure for differences between terminating characters.

*Note: On a change value command (V), if the command string is terminated with the * character, all values are stored in E²PROM memory. Values are not stored if the \$ terminator is used.*

Register Identification Chart

ID	VALUE DESCRIPTION	REGISTER NAME ¹	COMMAND ²	TRANSMIT DETAILS ³
A	Timer Value	TMR	T, V, R	6 digit
B	Cycle Counter Value	CNT	T, V, R	6 digit
C	RTC Time Value	TIM	T, V	6 digit
D	RTC Date Value	DAT	T, V	6 digit
E	Setpoint 1	SP1	T, V, R	6 digit
F	Setpoint 2	SP2	T, V, R	6 digit
G	Setpoint 3	SP3	T, V, R	6 digit
H	Setpoint 4	SP4	T, V, R	6 digit
I	Setpoint 1 Off Value	SO1	T, V	6 digit
J	Setpoint 2 Off Value	SO2	T, V	5 digit
K	Setpoint 3 Off Value	SO3	T, V	6 digit
L	Setpoint 4 Off Value	SO4	T, V	6 digit
M	Timer Start Value	TST	T, V	6 digit
O	Cycle Counter Start Value	CST	T, V	6 digit
Q	Timer Stop Value	TSP	T, V	6 digit
S	Cycle Counter Stop Value	CSP	T, V	6 digit
U	Auto/Man Register	MMR	T, V	0 - auto, 1 - manual
W	Day of Week Value	DAY	T, V	1 = Sun...7 = Sat
X	Setpoint Register	SOR	T, V	0 - not active, 1 - active

1. Register Names are also used as Register Mnemonics during full transmission.
2. The registers associated with the P command are set up in Print Options (Module 7).
3. Unless otherwise specified, the Transmit Details apply to both T and V Commands.

Command String Examples:

1. Address = 17, Write 350 to Setpoint 1
String: N17VE350\$
2. Address = 5, Cycle Counter value, response time of 50 to 100 msec. min.
String: N05TB*
3. Address = 0, Reset Timer value
String: RA*

Transmitting Data To the Meter

Numeric data sent to the meter must be limited to Transmit Details listed in the Register Identification Chart. Leading zeros are ignored. The meter ignores any decimal point and conforms the number to the scaled resolution. (ie. The meter's scaled decimal point position is set for 0.0 and 25 is written to a register. The value of the register is now 2.5. In this case, write a value of 250 to equal 25.0).

For RTC Time [C] and Date [D] Value:

Time - 24 Hours, Minutes, Seconds (HHMMSS)

Ex: 083000 = 8:30 AM, 144500 = 2:45 PM

Date - Month, Day, Year (mmddyy)

Ex: 123101 = December 31, 2001

Day - 1 = Sunday through 7 = Saturday

EX: 3 = Tuesday

Notes:

1. Since the meter does not issue a reply to value change commands, follow with a transmit value command for readback verification.
2. The date and day must be set separately.

Transmitting Data From the Meter

Data is transmitted from the meter in response to either a transmit command (T), a print block command (P) or User Function print request. The response from the meter is either a full field transmission or an abbreviated transmission. The meter response is established in Module 7.

Full Transmission (Rbbr = RD)

BYTE	DESCRIPTION
1, 2	2 byte Node (Meter) Address field [00-99]
3	<SP> (Space)
4-6	3 byte Register Mnemonic field
7-18	12 byte numeric data field: 6 bytes for number, up to 3 for decimal points.
19	<CR> (Carriage return)
20	<LF> (Line feed)
21	<SP> (Space) [*]
22	<CR> (Carriage return) [*]
23	<LF> (Line feed) [*]

^{*} These characters only appear in the last line of a block print.

The first two characters transmitted are the unit address. If the address assigned is 0, two spaces are substituted. A space follows the unit address field. The next three characters are the register mnemonic.

The numeric data is transmitted next. The numeric field is 12 characters long (decimal points are loaded depending on timer range selected). The data is right-aligned with leading spaces for any unfilled positions.

The end of the response string is terminated with <CR> and <LF>. When a block print is finished, an extra <SP>, <CR>, and <LF> are used to provide separation between the transmissions.

Abbreviated Transmission (Abbr = YE5)

BYTE	DESCRIPTION
1-12	12 byte data field, 6 bytes for number, up to 3 bytes for decimal points.
13	<CR> (Carriage return)
14	<LF> (Line feed)
15	<SP> (Space) [☆]
16	<CR> (Carriage return) [☆]
17	<LF> (Line feed) [☆]

[☆] These characters only appear in the last line of a block print.

The abbreviated response suppresses the address and register mnemonics, leaving only the numeric part of the response.

Note: Transmissions are formatted to match the way the parameter is displayed.

This includes setpoints.

Example: SP1 assigned to RTC. RTC format = 12:00 P.

SP1 printout = 12:00 P.

Meter Response Examples:

- Address = 17, full field response, Cycle Counter = 875
17 CNT 875 <CR><LF>
- Address = 0, full field response, Setpoint 2 = 250.5
SP2 250.5<CR><LF>
- Address = 0, abbreviated response, Setpoint 2 = 250, last line of block print
250<CR><LF><SP><CR><LF>

Auto/Manual Mode Register (MMR) ID: U

This register sets the controlling mode for the outputs. In Auto Mode (0) the meter controls the setpoint output. In Manual Mode (1) the outputs are defined by the registers SOR. When transferring from auto mode to manual mode, the meter holds the last output value (until the register is changed by a write). Each output may be independently changed to auto or manual. In a write command string (VU), any character besides 0 or 1 in a field will not change the corresponding output mode.

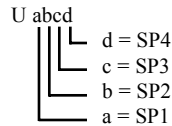

Example: VU0011 places SP3 and SP4 in manual.

Setpoint Output Register (SOR) ID: X

This register is used to view or change the states of the setpoint outputs. Reading from this register (TX) will show the present state of all the setpoint outputs. A "0" in the setpoint location means the output is inactive and a "1" means the output is active. The output logic parameter in Module 6 will affect the active logic state.

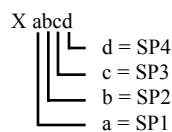

In Automatic Mode, the meter controls the setpoint output state. In Manual Mode, writing to this register (VX) will change the output state. Sending any character besides 0 or 1 in a field or if the corresponding output was not first in manual mode, the corresponding output value will not change.

Example: VX10* will result in output 1 active and output 2 inactive.

COMMAND RESPONSE TIME

The meter can only receive data or transmit data at any one time (half-duplex operation). During RS232 transmissions, the meter ignores commands while transmitting data, but instead uses RXD as a busy signal. When sending commands and data to the meter, a delay must be imposed before sending another command. This allows enough time for the meter to process the command and prepare for the next command.

Refer to the Timing Diagrams below. At the start of the time interval t_1 , the computer program prints or writes the string to the com port, thus initiating a transmission. During t_1 , the command characters are under transmission and at the end of this period, the command terminating character (*, \$) is received by the meter. The time duration of t_1 is dependent on the number of characters and baud rate of the channel.

$$t_1 = (10 \text{ times the \# of characters}) / \text{baud rate}$$

At the start of time interval t_2 , the meter starts the interpretation of the command and when complete, performs the command function. This time interval t_2 varies. If no response from the meter is expected, the meter is ready to accept another command.

If the meter is to reply with data, the time interval t_2 is controlled by the use of the command terminating character. The '*' terminating character results in a response time window of 50 msec. minimum and 100 msec. maximum. This allows sufficient time for the release of the sending driver on the RS485 bus. Terminating the command line with '\$' results in a response time window (t_2) of 2 msec. minimum and 50 msec. maximum. The faster response time of this terminating character requires that sending drivers release within 2 msec. after the terminating character is received.

At the beginning of time interval t_3 , the meter responds with the first character of the reply. As with t_1 , the time duration of t_3 is dependent on the number of characters and baud rate of the channel. At the end of t_3 , the meter is ready to receive the next command.

$$t_3 = (10 \text{ times the \# of characters}) / \text{baud rate}$$

SERIAL TIMING

COMMAND	COMMENT	PROCESS TIME (t_2)
R	Reset	2-50 msec.
V	Write	100-200 msec.
T	Transmit	2-50 msec. for \$ 50-100 msec. for *
P	Print	2-50 msec. for \$ 50-100 msec. for *

Timing Diagrams

NO REPLY FROM METER

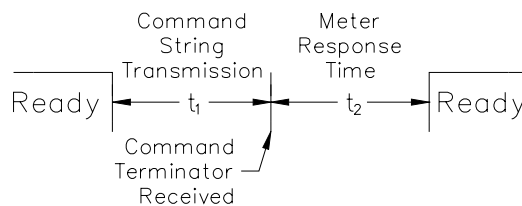

RESPONSE FROM METER

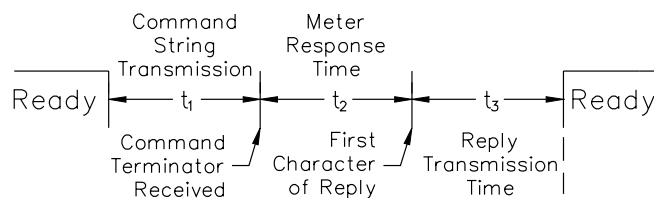

COMMUNICATION FORMAT

Data is transferred from the meter through a serial communication channel. In serial communications, the voltage is switched between a high and low level at a predetermined rate (baud rate) using ASCII encoding. The receiving device reads the voltage levels at the same intervals and then translates the switched levels back to a character.

The voltage level conventions depend on the interface standard. The table lists the voltage levels for each standard.

LOGIC	INTERFACE STATE	RS232*	RS485*
1	mark (idle)	TXD,RXD; -3 to -25 V	a-b < -200 mV
0	space (active)	TXD,RXD; +3 to +25 V	a-b > +200 mV

* Voltage levels at the Receiver

Data is transmitted one byte at a time with a variable idle period between characters. Each ASCII character is “framed” with a beginning start bit, an optional parity bit and one or more ending stop bits. The data format and baud rate must match that of other equipment in order for communication to take place. The figures list the data formats employed by the meter.

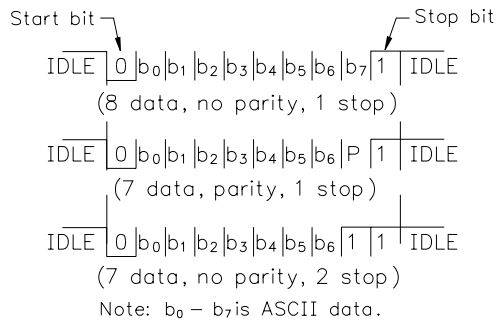

Character Frame Figure

Start Bit and Data Bits

Data transmission always begins with the start bit. The start bit signals the receiving device to prepare for reception of data. One bit period later, the least significant bit of the ASCII encoded character is transmitted, followed by the remaining data bits. The receiving device then reads each bit position as they are transmitted.

Parity Bit

After the data bits, the parity bit is sent. The transmitter sets the parity bit to a zero or a one, so that the total number of ones contained in the transmission (including the parity bit) is either even or odd. This bit is used by the receiver to detect errors that may occur to an odd number of bits in the transmission. However, a single parity bit cannot detect errors that may occur to an even number of bits. Given this limitation, the parity bit is often ignored by the receiving device. The meter ignores the parity bit of incoming data and sets the parity bit to odd, even or none (mark parity) for outgoing data.

Stop Bit

The last character transmitted is the stop bit. The stop bit provides a single bit period pause to allow the receiver to prepare to re-synchronize to the start of a new transmission (start bit of next byte). The receiver then continuously looks for the occurrence of the start bit. If 7 data bits and no parity is selected, then 2 stop bits are sent from the meter.

6.8 MODULE 8 - REAL-TIME CLOCK PARAMETERS (B-rtC) - PTC901

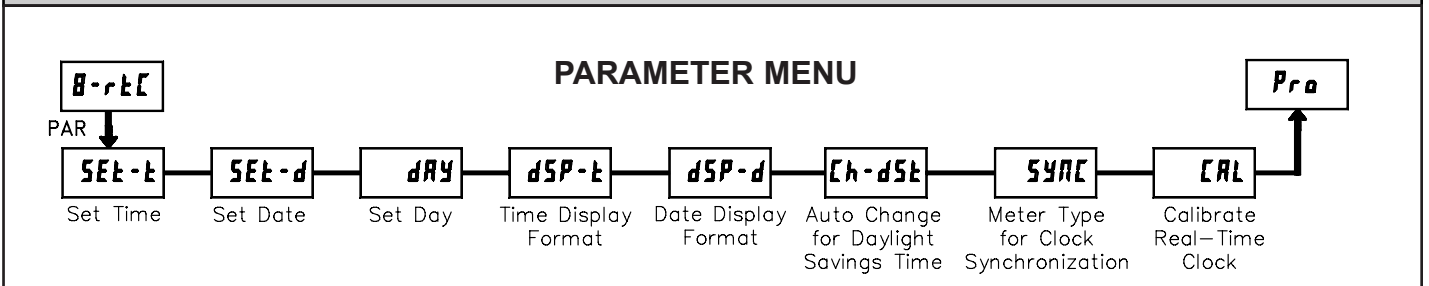

Module 8 is the programming module for the Real-Time Clock (RTC) Date and Time Parameters. In the Display Mode, the DAT annunciator indicates the RTC Date is currently being shown. The RTC Time display is shown with no annunciator. This programming module can only be accessed if a Real-Time Clock card is installed.

SET TIME



This parameter sets the Time for the Real-Time Clock. Selecting YES will display the sub-menu where the Time can be set or changed. The RTC Time is entered in “Hours-Minutes”, 12-hour format, with AM/PM indication. When the PAR key is pressed, the new Time is entered and begins running. The “Seconds” always start from 00 when the Time is entered. Select NO to advance to the next parameter without changing the Time.

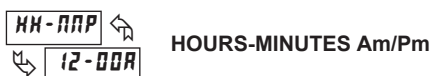

SET DATE



This parameter sets the Date for the Real-Time Clock. Selecting YES will display the sub-menu where the Date can be set or changed. The RTC Date is entered in “Month.Day.Year” format (two-digit values). When the PAR key is pressed, the new Date is entered. Select NO to advance to the next parameter without changing the Date.



SET DAY

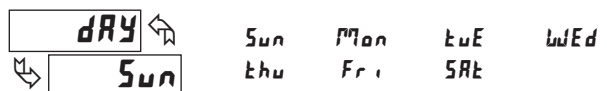

Set the Day of the week for the Real-Time Clock.

TIME DISPLAY FORMAT

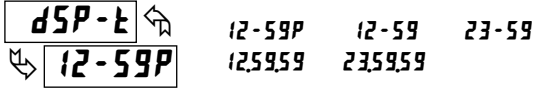

Select the format in which the Real-Time Clock Time will be displayed. The format selections depict the *range* for the RTC Time display, and DO NOT represent the *current* RTC Time. When the meter is operating in the Display Mode, the RTC Time display is shown with no annunciator.

DATE DISPLAY FORMAT

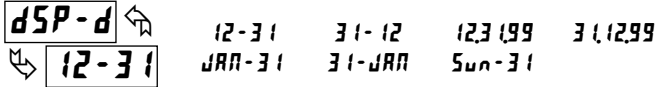

Select the format in which the Real-Time Clock Date will be displayed. The format selections depict the *range* for the RTC Date display, and DO NOT represent the *current* RTC Date. When the meter is operating in the Display Mode, the RTC Date display is indicated by the DAT annunciator.

AUTO CHANGE FOR DAYLIGHT SAVINGS TIME



Selecting **YES** allows the meter to automatically adjust the RTC Time for Daylight Savings Time. (Adjustment dates are U.S.A. standard only.) Avoid setpoints that occur during adjustment (Sundays 1 to 3 AM).

METER TYPE FOR CLOCK SYNCHRONIZATION



Time synchronization between multiple PTC901 meters can be accomplished through a hardware interface on the Real-Time Clock option card. This RS485 type interface allows connection of up to 32 PTC901 meters in a two-wire multidrop network, at distances up to 4000 ft. (See Section 4.6, Real-Time Clock Wiring).

In a Synchronization network, one PTC901 meter is programmed as the Host (**HOST**), while all other meters are programmed as Slaves (**SLAVE**). Once every hour (at 30 min. past the hour), the Host meter outputs a time synchronization pulse onto the network. Upon receiving the synchronization pulse, each Slave meter automatically adjusts the Minutes and Seconds of its RTC Time setting to synchronize with the Host. *Synchronization, using the Real-Time Clock Wiring, adjusts the Minutes and Seconds only, and does not change the Hours, AM/PM, Day or Date settings in the Slave meter's RTC.*

Full-time synchronization (hours, minutes and seconds) is possible for PAXCKs that are connected in an RS485 network (RS485 Serial Option cards required). In this configuration, one meter is designated as the Serial RTC Master by setting the meter's address as 98 or 99 (see Serial Real-time Clock Addressing in Master Module 7). Every hour (at 30 min past the hour), the Serial RTC Master / Host will transmit the full time (Hours, minutes, seconds) to all meters through the RS485 serial card wiring network. The time, date, or day will also be transmitted and updated in the Slaves when changed in the programming of the Serial RTC Master. Only one meter should be configured as Master and that meter should also be configured as the Host.

CALIBRATE REAL-TIME CLOCK

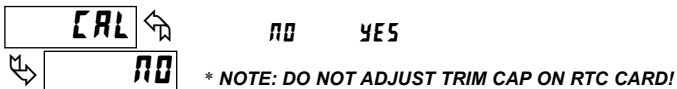

The Real-Time Clock circuit uses a crystal controlled oscillator for high accuracy timekeeping. The oscillator is factory calibrated* and optimized for 25°C ambient temperature operation. Since the PTC901 is designed to operate over a wide temperature range, and since the accuracy of a crystal oscillator varies with ambient temperature, some drift in the RTC time may be observed over an extended period. This is primarily seen in high or low temperature installations. To compensate for the wide operating temperature range, a calibration or "Offset" value can be entered, which effectively slows down or speeds up the clock to maintain accurate timekeeping.

To calibrate the RTC, install the meter in its normal operating environment, and set the time based on a known accurate reference (such as the WWV broadcast or the Atomic Clock reference which is available via the internet). After 30 days of normal operation, compare the RTC time to the reference, and note the amount of time gained or lost. Refer to the tables on the next page for the proper Offset value to enter, given the amount of time drift observed.



Selecting **YES** for the **CAL** parameter displays the **OFFSEt** sub-menu where the present Offset value can be viewed or changed. The tables below show the value to enter, given the amount of time gained or lost in a 30-day period.

Values 00 and 32 provide no Offset, and are not shown in the tables.

IF RTC CLOCK GAINED TIME: USE VALUE FROM THIS TABLE			
SECONDS GAINED IN 30 DAYS	ENTER THIS OFFSET VALUE	SECONDS GAINED IN 30 DAYS	ENTER THIS OFFSET VALUE
5	01	90	17
11	02	95	18
16	03	100	19
21	04	105	20
26	05	111	21
32	06	116	22
37	07	121	23
42	08	127	24
47	09	132	25
53	10	137	26
58	11	142	27
63	12	148	28
69	13	153	29
74	14	158	30
79	15	163	31
84	16		

IF RTC CLOCK LOST TIME: USE VALUE FROM THIS TABLE			
SECONDS LOST IN 30 DAYS	ENTER THIS OFFSET VALUE	SECONDS LOST IN 30 DAYS	ENTER THIS OFFSET VALUE
11	33	179	49
21	34	190	50
32	35	200	51
42	36	211	52
53	37	221	53
63	38	232	54
74	39	243	55
84	40	253	56
95	41	264	57
105	42	274	58
116	43	285	59
127	44	295	60
137	45	306	61
148	46	316	62
158	47	327	63
169	48		

6.9 MODULE 9 - FACTORY SERVICE OPERATIONS (9-F15)

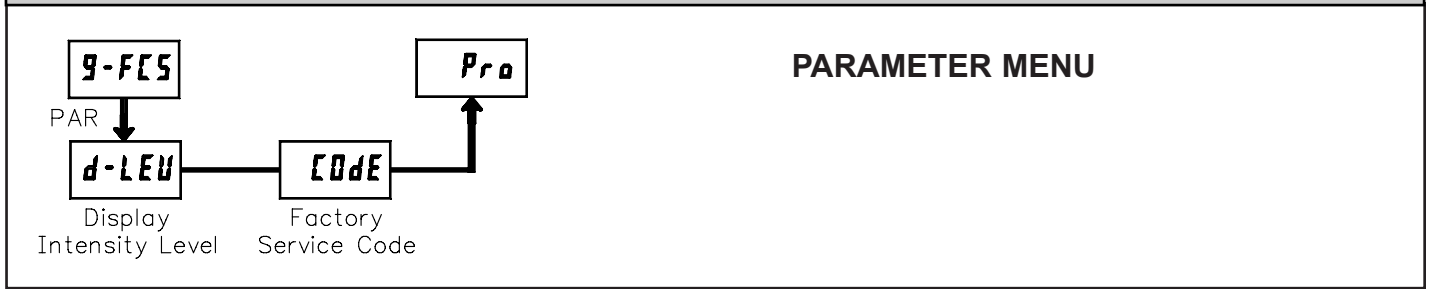

DISPLAY INTENSITY LEVEL

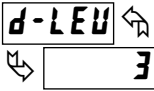

Enter the desired Display Intensity Level (0-15) by using the arrow keys. The display will actively dim or brighten as the levels are changed. This parameter also appears in Quick Programming Mode when enabled.

RESTORE FACTORY DEFAULTS

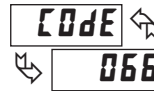

Use the **RST** and/or arrow keys to display **CODE 050** and press **PAR**. The meter will display **rESEt** and then returns to **CODE 050**. Press **DSP** key to return to the Display Mode. This will overwrite all programmed user settings with the Factory Default Settings shown in the Parameter Value Chart. For the PTC901, the Time and Date stored in the Real-Time Clock, as well as the RTC Claibration Offset value, are NOT overwritten by this parameter. However, the Time and Date Display Formats will revert back to the Factory Default Settings.

TROUBLESHOOTING

For further assistance, contact technical support at the appropriate company numbers listed.

PROBLEM	REMEDIES
NO DISPLAY	CHECK: Power level, power connections
PROGRAMMING LOCKED-OUT	CHECK: User input set for program lock-out function is in Active state ENTER: Security code requested
CERTAIN DISPLAYS ARE LOCKED-OUT	CHECK: Display Lock-out programming in Module 3
MODULES or PARAMETERS NOT ACCESSIBLE	CHECK: Corresponding plug-in card installation, Program Lock-out/ Value Access parameter programming in Module 3
TIMER NOT RUNNING	CHECK: Input wiring, Timer plug jumper setting, Timer input programming in Module 1, input signal level, Timer Inhibited by Input B or a user input
USER INPUT NOT WORKING PROPERLY	CHECK: User input wiring, user input plug jumper setting, user input signal level, user input programming in Module 2
OUTPUTS NOT WORKING PROPERLY	CHECK: Setpoint plug-in card installation, wiring, Setpoint programming in Module 6
REAL-TIME CLOCK NOT WORKING PROPERLY	CHECK: RTC plug-in card installation, RTC programming in Module 8, check for proper battery installation, replace battery. DO NOT ADJUST TRIM CAP ON RTC CARD!
SERIAL COMMUNICATIONS NOT WORKING	CHECK: Serial plug-in card installation, Serial wiring, Serial settings in Module 7, host settings
ERROR CODE (<i>Err 1-4</i>)	PRESS: Reset key (If unable to clear, contact factory.)

Shaded areas are model dependent.

PARAMETER VALUE CHART

Clock Timer

Programmer _____ Date _____

Meter# _____ Security Code _____

1- INP Timer Input Parameters

DISPLAY	PARAMETER	FACTORY SETTING	USER SETTING
rRNGE	TIMER RANGE	555555	_____
INP OP	TIMER INPUT OPERATION	LEVEL	_____
Filter	TIMER INPUT FILTERING	ON	_____
t dir	TIMING DIRECTION	UP	_____
t Start	TIMER START VALUE (A)	000000	_____
	TIMER START VALUE (B)*	000000	_____
t STOP	TIMER STOP (A & B*)	NO	_____
URLUE	TIMER STOP VALUE (A)	000000	_____
	TIMER STOP VALUE (B)*	000000	_____
FLASH	FLASH TIMER ANNUNCIATOR	NO	_____
INP-UP	TIMER INPUT STATE AT POWER-UP	STOP	_____
t P-UP	TIMER RESET AT POWER-UP	NO	_____

2-FNC User Input and Function Key Parameters

DISPLAY	PARAMETER	FACTORY SETTING	USER SETTING
USER-1	USER INPUT 1	NO	_____
USER-2	USER INPUT 2	NO	_____
USER-3	USER INPUT 3	NO	_____
F1	FUNCTION KEY 1	NO	_____
F2	FUNCTION KEY 2	NO	_____
rSt	RESET KEY	drSt-E	_____
SEC-F1	SECONDARY FUNCTION KEY F1	NO	_____
SEC-F2	SECONDARY FUNCTION KEY F2	NO	_____

3-LCK Display and Program Lock-out Parameters

DISPLAY	PARAMETER	FACTORY SETTING	USER SETTING
t-dSP	TIMER DISPLAY LOCK-OUT	rEd	_____
C-dSP	CYCLE COUNT DISPLAY LOCK-OUT	LCK	_____
rtC-d	RTC DATE DISPLAY LOCK-OUT	LCK	_____
rtC-t	RTC TIME DISPLAY LOCK-OUT	LCK	_____
SP-1	SP1 ON VALUE ACCESS	LCK	_____
SPDF-1	SP1 OFF VALUE ACCESS	LCK	_____
tOUT-1	SP1 TIME-OUT VALUE ACCESS	LCK	_____
SP-2	SP2 ON VALUE ACCESS	LCK	_____
SPDF-2	SP2 OFF VALUE ACCESS	LCK	_____
tOUT-2	SP2 TIME-OUT VALUE ACCESS	LCK	_____
SP-3	SP3 ON VALUE ACCESS	LCK	_____
SPDF-3	SP3 OFF VALUE ACCESS	LCK	_____
tOUT-3	SP3 TIME-OUT VALUE ACCESS	LCK	_____
SP-4	SP4 ON VALUE ACCESS	LCK	_____
SPDF-4	SP4 OFF VALUE ACCESS	LCK	_____
tOUT-4	SP4 TIME-OUT VALUE ACCESS	LCK	_____
t Start	TIMER START VALUE ACCESS	LCK	_____
t STOP	TIMER STOP ACCESS	LCK	_____
C Start	COUNTER START VALUE ACCESS	LCK	_____
C STOP	COUNTER STOP VALUE ACCESS	LCK	_____
SEt-t	RTC TIME SETTING ACCESS	LCK	_____
COdE	SECURITY CODE	000	_____

4-CNT Cycle Counter Parameters

DISPLAY	PARAMETER	FACTORY SETTING	USER SETTING
C Src	CYCLE COUNTER COUNT SOURCE	NONE	_____
C dir	CYC. CNTR. COUNTING DIRECTION	UP	_____
C Start	CYCLE COUNTER START VALUE (A)	000000	_____
	CYCLE COUNTER START VALUE (B)*	000000	_____
C STOP	CYCLE COUNTER STOP (A & B*)	NO	_____
URLUE	CYCLE COUNTER STOP VALUE (A)	000000	_____
	CYCLE COUNTER STOP VALUE (B)*	000000	_____
C P-UP	CYC. CNTR. RESET AT POWER-UP	NO	_____

5-OPER Timer Operating Modes

DISPLAY	PARAMETER	FACTORY SETTING	USER SETTING
t OPER	PREDEFINED TIMER OPER. MODE	NO	_____
SP-1	SETPOINT 1 ON VALUE	000000	_____
SPDF-1	SETPOINT 1 OFF VALUE	000 100	_____
tOUT-1	SETPOINT 1 TIME-OUT VALUE	000 100	_____

* See Module 2, Exchanging Parameter Lists, for details on programming this value.

Shaded areas are model dependent.

6 - SPt Setpoint (Alarm) Parameters

DISPLAY	PARAMETER	SP-1		SP-2		SP-3		SP-4	
		FACTORY SETTING	USER SETTING	FACTORY SETTING	USER SETTING	FACTORY SETTING	USER SETTING	FACTORY SETTING	USER SETTING
ASn-n	SETPOINT ASSIGNMENT	NONE		NONE		NONE		NONE	
Act-n	SETPOINT ACTION	LALCH		LALCH		LALCH		LALCH	
Out-n	OUTPUT LOGIC	NOr		NOr		NOr		NOr	
On-n	SETPOINT ON (A)	VALUE		VALUE		VALUE		VALUE	
	SETPOINT ON (B)*	VALUE		VALUE		VALUE		VALUE	
SP-n	SETPOINT ON VALUE (A)	000000		000000		000000		000000	
	SETPOINT ON VALUE (B)*	000000		000000		000000		000000	
OFF-n	SETPOINT OFF (A)	VALUE		VALUE		VALUE		VALUE	
	SETPOINT OFF (B)*	VALUE		VALUE		VALUE		VALUE	
SPDF-n	SETPOINT OFF VALUE (A)	000 100		000 100		000 100		000 100	
	SETPOINT OFF VALUE (B)*	000 100		000 100		000 100		000 100	
tOut-n	TIME-OUT VALUE (A)	000 100		000 100		000 100		000 100	
	TIME-OUT VALUE (B)*	000 100		000 100		000 100		000 100	
d On-n	DAILY ON OCCURRENCE (A)	Mon-Fri		Mon-Fri		Mon-Fri		Mon-Fri	
	DAILY ON OCCURRENCE (B)*	Mon-Fri		Mon-Fri		Mon-Fri		Mon-Fri	
d OFF-n	DAILY OFF OCCURRENCE (A)	Mon-Fri		Mon-Fri		Mon-Fri		Mon-Fri	
	DAILY OFF OCCURRENCE (B)*	Mon-Fri		Mon-Fri		Mon-Fri		Mon-Fri	
tStP-n	TIMER STOP	NO		NO		NO		NO	
RUtR-n	TIMER/COUNTER AUTO RESET	NO		NO		NO		NO	
OrSd-n	OUTPUT RESET W/DISPLAY RESET	NO		NO		NO		NO	
L t-n	SETPOINT ANNUNCIATOR	NOr		NOr		NOr		NOr	
P-UP-n	POWER-UP STATE	OFF		OFF		OFF		OFF	

7 - 5rL Serial Communication Parameters

DISPLAY	PARAMETER	FACTORY SETTING	USER SETTING
bRUd	BAUD RATE	9600	
dRtR	DATA BITS	7	
PRr	PARITY BIT	Odd	
Rddr	METER UNIT ADDRESS	00	
Rbbr	ABBREVIATED PRINTING	NO	
rtC Ft	REAL-TIME CLOCK PRINT FORMAT	YES	
OPt	PRINT OPTIONS		
t-dSP	TIMER DISPLAY	YES	
C-dSP	CYCLE COUNTER DISPLAY	NO	
rtC-d	RTC DATE DISPLAY	NO	
rtC-t	RTC TIME DISPLAY	NO	
SPnt	SETPOINT VALUES	NO	
SPntOF	SETPOINT OFF/ TIME-OUT VALUES	NO	

8 - rC Real-Time Clock Parameters

DISPLAY	PARAMETER	FACTORY SETTING	USER SETTING
dSP-t	TIME DISPLAY FORMAT	12-59P	
dSP-d	DATE DISPLAY FORMAT	12-31	
Ch-dSt	AUTO TIME CHANGE FOR D.S.T.	NO	
SYnC	SYNCHRONIZATION UNIT TYPE	SLAVE	
CRl	CALIBRATE REAL-TIME CLOCK		
OFFSEt	RTC CALIBRATION OFFSET VALUE	00	

9 - FCS Factory Service Parameters

DISPLAY	PARAMETER	FACTORY SETTING	USER SETTING
d-LEU	DISPLAY INTENSITY LEVEL	3	

* See Module 2, Exchanging Parameter Lists, for details on programming this value.

Shaded areas are model dependent.

PTC901 Application

A big application request has always been for Real-Time Clocks to display time throughout the plant. The challenge has been to keep all the various clock locations synchronized with the right time. With the new PTC901 Timer/Real-Time Clock this problem is history. You can install up to a maximum of 32 units. Simply select one of the units in the system as the host and the balance are programmed as slaves. The host will send out a synchronization pulse every hour to correct the time on any clock unit wired in the system.

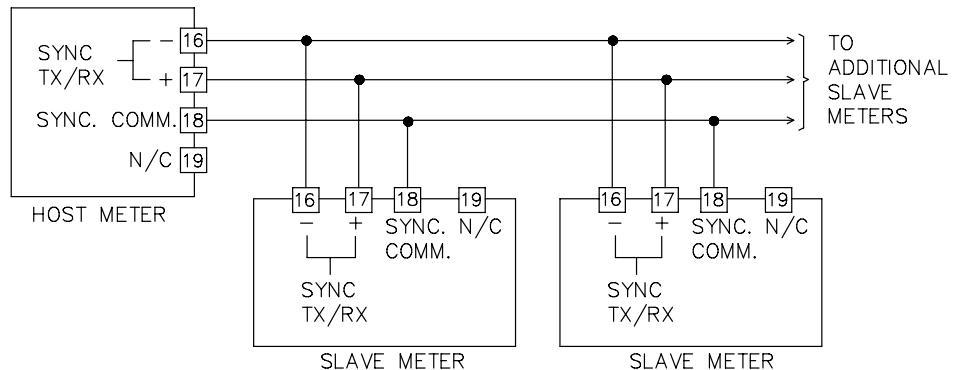

Real-Time Clock Synchronization Network

PART NUMBER INFORMATION

DESCRIPTION	PART NUMBERS
Timer, 85-250 VAC power	PTC900
Timer, 11-36 VDC/24 VAC power	PTC900-LV
Timer, 85-250 VAC power, green LED display	PTC900-GN
Timer, 11-36 VDC/24 VAC power, green LED display	PTC900-GN-LV
Real-Time Clock, 85-250 VAC power	PTC901
Real-Time Clock, 11-36 VDC/24 VAC power	PTC901-LV
Real-Time Clock, 85-250 VAC power, green LED display	PTC901-GN
Real-Time Clock, 11-36 VDC/24 VAC power, green LED display	PTC901-GN-LV

ACCESSORIES

DESCRIPTION	PART NUMBERS
Setpoint Alarms	
Dual Setpoint relay output Card	DP6-CDS10
Quad Setpoint relay output Card	DP6-CDS20
Quad Setpoint sinking open collector output Card	DP6-CDS30
Quad Setpoint sourcing open collector output Card	DP6-CDS40
Communications	
RS485 serial communications output card with terminal block	DP6-CDC10
Extended RS485 serial communications output card with dual RJ11 connectors	DP6-CDC1C
RS232 serial communications output card with terminal block	DP6-CDC20
Extended RS232 serial communications output card with 9-pin D connector	DP6-CDC2C
MODBUS communications output card with terminal block	DP6-CDC40
Extended MODBUS communications output card with dual RJ11 connectors	DP6-CDC4C
Real-Time Clock	
Real-Time Clock card	PTC9-RTC00

WARRANTY/DISCLAIMER

OMEGA ENGINEERING, INC. warrants this unit to be free of defects in materials and workmanship for a period of **25 months** from date of purchase. OMEGA's WARRANTY adds an additional one (1) month grace period to the normal **two (2) year product warranty** to cover handling and shipping time. This ensures that OMEGA's customers receive maximum coverage on each product.

If the unit malfunctions, it must be returned to the factory for evaluation. OMEGA's Customer Service Department will issue an Authorized Return (AR) number immediately upon phone or written request. Upon examination by OMEGA, if the unit is found to be defective, it will be repaired or replaced at no charge. OMEGA's WARRANTY does not apply to defects resulting from any action of the purchaser, including but not limited to mishandling, improper interfacing, operation outside of design limits, improper repair, or unauthorized modification. This WARRANTY is VOID if the unit shows evidence of having been tampered with or shows evidence of having been damaged as a result of excessive corrosion; or current, heat, moisture or vibration; improper specification; misapplication; misuse or other operating conditions outside of OMEGA's control. Components in which wear is not warranted, include but are not limited to contact points, fuses, and triacs.

OMEGA is pleased to offer suggestions on the use of its various products. However, OMEGA neither assumes responsibility for any omissions or errors nor assumes liability for any damages that result from the use of its products in accordance with information provided by OMEGA, either verbal or written. OMEGA warrants only that the parts manufactured by the company will be as specified and free of defects. OMEGA MAKES NO OTHER WARRANTIES OR REPRESENTATIONS OF ANY KIND WHATSOEVER, EXPRESSED OR IMPLIED, EXCEPT THAT OF TITLE, AND ALL IMPLIED WARRANTIES INCLUDING ANY WARRANTY OF MERCHANTABILITY AND FITNESS FOR A PARTICULAR PURPOSE ARE HEREBY DISCLAIMED. LIMITATION OF LIABILITY: The remedies of purchaser set forth herein are exclusive, and the total liability of OMEGA with respect to this order, whether based on contract, warranty, negligence, indemnification, strict liability or otherwise, shall not exceed the purchase price of the component upon which liability is based. In no event shall OMEGA be liable for consequential, incidental or special damages.

CONDITIONS: Equipment sold by OMEGA is not intended to be used, nor shall it be used: (1) as a "Basic Component" under 10 CFR 21 (NRC), used in or with any nuclear installation or activity; or (2) in medical applications or used on humans. Should any Product(s) be used in or with any nuclear installation or activity, medical application, used on humans, or misused in any way, OMEGA assumes no responsibility as set forth in our basic WARRANTY/DISCLAIMER language, and, additionally, purchaser will indemnify OMEGA and hold OMEGA harmless from any liability or damage whatsoever arising out of the use of the Product(s) in such a manner.

RETURN REQUESTS/INQUIRIES

Direct all warranty and repair requests/inquiries to the OMEGA Customer Service Department. BEFORE RETURNING ANY PRODUCT(S) TO OMEGA, PURCHASER MUST OBTAIN AN AUTHORIZED RETURN (AR) NUMBER FROM OMEGA'S CUSTOMER SERVICE DEPARTMENT (IN ORDER TO AVOID PROCESSING DELAYS). The assigned AR number should then be marked on the outside of the return package and on any correspondence.

The purchaser is responsible for shipping charges, freight, insurance and proper packaging to prevent breakage in transit.

FOR **WARRANTY** RETURNS, please have the following information available BEFORE contacting OMEGA:

1. Purchase Order number under which the product was PURCHASED,
2. Model and serial number of the product under warranty, and
3. Repair instructions and/or specific problems relative to the product.

FOR **NON-WARRANTY** REPAIRS, consult OMEGA for current repair charges. Have the following information available BEFORE contacting OMEGA:

1. Purchase Order number to cover the COST of the repair,
2. Model and serial number of the product, and
3. Repair instructions and/or specific problems relative to the product.

OMEGA's policy is to make running changes, not model changes, whenever an improvement is possible. This affords our customers the latest in technology and engineering.

OMEGA is a registered trademark of OMEGA ENGINEERING, INC.

© Copyright 2006 OMEGA ENGINEERING, INC. All rights reserved. This document may not be copied, photocopied, reproduced, translated, or reduced to any electronic medium or machine-readable form, in whole or in part, without the prior written consent of OMEGA ENGINEERING, INC.

Where Do I Find Everything I Need for Process Measurement and Control? **OMEGA...Of Course!** *Shop online at omega.com*

TEMPERATURE

- ☑ Thermocouple, RTD & Thermistor Probes, Connectors, Panels & Assemblies
- ☑ Wire: Thermocouple, RTD & Thermistor
- ☑ Calibrators & Ice Point References
- ☑ Recorders, Controllers & Process Monitors
- ☑ Infrared Pyrometers

PRESSURE, STRAIN AND FORCE

- ☑ Transducers & Strain Gages
- ☑ Load Cells & Pressure Gages
- ☑ Displacement Transducers
- ☑ Instrumentation & Accessories

FLOW/LEVEL

- ☑ Rotameters, Gas Mass Flowmeters & Flow Computers
- ☑ Air Velocity Indicators
- ☑ Turbine/Paddlewheel Systems
- ☑ Totalizers & Batch Controllers

pH/CONDUCTIVITY

- ☑ pH Electrodes, Testers & Accessories
- ☑ Benchtop/Laboratory Meters
- ☑ Controllers, Calibrators, Simulators & Pumps
- ☑ Industrial pH & Conductivity Equipment

DATA ACQUISITION

- ☑ Data Acquisition & Engineering Software
- ☑ Communications-Based Acquisition Systems
- ☑ Plug-in Cards for Apple, IBM & Compatibles
- ☑ Datalogging Systems
- ☑ Recorders, Printers & Plotters

HEATERS

- ☑ Heating Cable
- ☑ Cartridge & Strip Heaters
- ☑ Immersion & Band Heaters
- ☑ Flexible Heaters
- ☑ Laboratory Heaters

ENVIRONMENTAL MONITORING AND CONTROL

- ☑ Metering & Control Instrumentation
- ☑ Refractometers
- ☑ Pumps & Tubing
- ☑ Air, Soil & Water Monitors
- ☑ Industrial Water & Wastewater Treatment
- ☑ pH, Conductivity & Dissolved Oxygen Instruments