

# Luma 2

Heavy Duty Spring  
Roller Operated  
Projection Screen

by **DRAPER**

## Specifications—Luma 2 with AutoReturn

\_\_\_\_\_ projection screens, size \_\_\_\_\_ h. x \_\_\_\_\_ w.

wall/ceiling mounting. Case of 22 ga. steel, flat back design, with scratch-resistant white polyester finish. Viewing surface of ((GREENGUARD for Children and Schools certified Matt white) [optional Glass Beaded] [optional GREENGUARD for Children and Schools certified High Contrast Grey]), flame and mildew resistant.

Matt White and High Contrast Grey viewing surfaces shall qualify as low emitting and meet all of the requirements of the GREENGUARD for Children and Schools and GREENGUARD certification program, which are: emissions of total volatile organic compounds  $\leq 0.22$  mg/m<sup>3</sup>, formaldehyde  $\leq 0.0135$  ppm, total aldehydes  $\leq 0.043$  ppm, individual volatile organic compounds  $\leq 1/1000$  TLV and  $\leq 1/2$  chronic REL and total phthalates  $\leq 0.01$  mg/m<sup>3</sup>.

Note: Matt white and optional glass beaded surfaces up to 10' high will be seamless. Black Masking Borders-1 1/2" through 70" wide; 1 3/4" on 84" wide; 2" on larger screens (optional on AV format, standard on all others). Endcaps, finished to match case, to have integral roller brackets. Endcaps to form universal mounting brackets. Viewing surface mounted on a 1 3/4", 2 1/4" or 3" dia. roller, depending on screen size. AutoReturn roller to prevent screen from retracting uncontrolled into the case. Bottom of viewing surface forms a pocket for the dowel. Saddle and pull attached by screws.

## Please Check All Appropriate Selections

### Select Viewing Surface:

- GREENGUARD Children and Schools Certified Matt White
- Optional Glass Beaded
- Optional GREENGUARD Children and Schools Certified High Contrast Grey (Through 8' x 10' AV, 150" NTSC, 161" HDTV & 162" WideScreen)

### Optional Accessories:

- Mounting Brackets
  - 6" Bracket
  - 10"-14" Bracket (8' wide limit)
  - Adjustable Bracket (8' wide limit)
- Black Masking Borders—1 1/2" through 70" wide; 1 3/4" on 84" wide; 2" on larger screens (optional on AV format, standard on all others)
- Extra Screen Drop \* 1
  - Same color as viewing surface (standard on AV format screens)
  - Black (standard on all other formats)
- Length of total drop (including standard 12" on some sizes—see grid at right) <sup>1</sup>
- Optional Ceiling Opening Trim Kit for Recessed Installations\*
  - For case lengths through 102 1/2"
  - For case lengths over 102 1/2" and through 126 1/2"
  - For case lengths over 126 1/2" and through 174 1/2"
- Aluminum Operating Pole
  - 4' long
  - 6' long

\*Draper recommends 12" of extra drop when ordering a Ceiling Opening Trim Kit. The Luma 2 dowel is too long to retract through the trim kit slot.

## Methods of Installation (hardware by others)

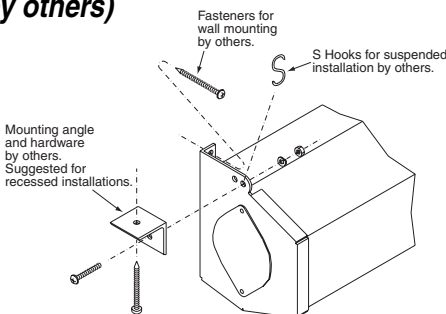

## Optional Ceiling Trim Kit

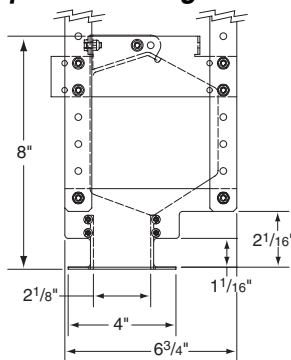

## Dimensions & Data

Size H x W	Case Length	Net Wt. (lbs.)	Qty.		
<b>AV Format</b>					
50" x 50"	52 1/2"	26			
60" x 60"	62 1/2"	29			
70" x 70"	72 1/2"	32			
84" x 84"	86 1/2"	33			
72" x 96"	98 5/8"	33			
96" x 96"	98 5/8"	37			
7' x 9'	111 1/4"	40			
9' x 9'	111 1/4"	45			
8' x 10'	123 1/4"	44			
10' x 10'	123 1/4"	50			
9' x 12'	147 1/4"	58			
12' x 12'	147 1/4"	69			
Nominal Diagonal	Image Area	Overall Size	Case Length	Net Wt. (lbs.)	Qty.
<b>NTSC Video Format (4:3)</b>					
100"	60" x 80"	64" x 83 1/2"	86 1/2"	35	
10'	69" x 92"	73" x 96"	98 5/8"	35	
11"	78" x 104"	83" x 108"	111 1/4"	39	
150"	87" x 116"	92" x 120"	123 1/4"	44	
15'	105" x 140"	109" x 144"	147 1/4"	58	
<b>HDTV Format (16:9)</b>					
92" <sup>1</sup>	45" x 80"	57" x 83 1/2"	86 1/2"	35	
106" <sup>1</sup>	52" x 92"	64" x 96"	98 5/8"	35	
119"	58" x 104"	62" x 108"	111 1/4"	38	
133"	65" x 116"	69" x 120"	123 1/4"	42	
161"	79" x 140"	84" x 144"	147 1/4"	57	
<b>WideScreen Format (1.85:1)</b>					
99"	47" x 87"	51" x 90"	91 5/8"	35	
108"	50" x 92"	54" x 96"	98 5/8"	35	
120"	56" x 104"	60" x 108"	111 1/4"	38	
132"	63" x 116"	67" x 120"	123 1/4"	43	
162"	76" x 140"	80" x 144"	147 1/4"	56	
<b>Custom Size</b>					

<sup>1</sup>These HDTV sizes include 12" black drop as standard.

Case size—5 3/16" H. x 5 1/4" W.

Brackets extend 5/8" above case

Also available in 2.35:1, 16:10 and 15:9 Formats. Contact Draper.

## Optional Mounting Brackets

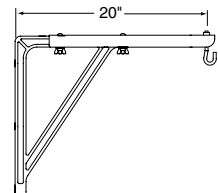
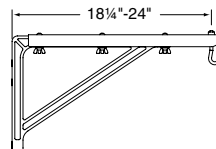
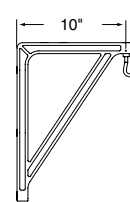
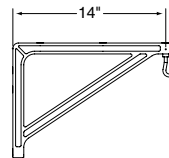
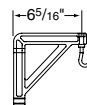

PROJECT: \_\_\_\_\_

ARCHITECT: \_\_\_\_\_

CONTRACTOR: \_\_\_\_\_

SUPPLIER: \_\_\_\_\_

DATE: \_\_\_\_\_ REVISED: \_\_\_\_\_

**DRAPER**®