

Panasonic®

AIR PURIFIER

Operating Instructions

Model No. **F-P15HU2** Model No. **F-P20HU1**

(Illustration is applied for F-P15HU2.)



To enable you to use the product correctly, please read these Instructions carefully.
Retain the Manual and refer to it when necessary.

Contents

Safety precautions	3
Parts identification	4
Functions of micro dust sensor	4
Before use	5
<hr/>	
To operate the unit	6
<hr/>	
Care and maintenance	7
Main unit	8
Air intake grille/ filter unit	8
Replacement of the filter	9
Filter frame	9
Micro dust sensor	10
<hr/>	
Troubleshooting	11
Specifications/Replacement filters	Back cover

Customer's Record

The model number and serial number of this product can be found on the side of the unit. Please note them in the space provided and keep for future reference.

MODEL NO. _____ SERIAL NUMBER _____

DATE OF PURCHASE _____ DEALER'S NAME _____

DEALER'S ADDRESS _____

TELEPHONE NUMBER _____



WARNING

This marking indicates that if the instruction is not followed, an accident resulting in death or serious injury may be caused.



CAUTION

This marking indicates that if the instruction is not followed, an accident resulting in injury or damage to property may be caused.



WARNING

1. Never attempt to disassemble, repair, or modify the product.
The product may catch fire or operate abnormally, resulting in injury.
If repairs are needed, contact your dealer.
2. The product must be used with outlet and wiring accessories within their ratings, and must not be powered by a power supply other than 120 V AC.
If the outlet and wiring ratings are exceeded, the heat generated may start a fire.
3. Do not immerse the product in water or splash water over it.
A short circuit or electric shock may be caused.
4. Insert the power plug in as far as it will go.
Incomplete insertion may cause a fire due to electric shock or heat generation.
Do not use damaged plugs or heat generation.
5. Do not handle the power plug with a wet hand.
An electric shock may be caused.
6. Do not damage the power cord or power plug.
(Do not damage the power cord, modify it, bring it close to any thermal device, bend it by force, twist it, pull it, put a heavy object on it, or bundle it.)
If these devices are used in a damaged condition, electric shock, short circuit, or fire may be caused.
If the cord or plug needs to be repaired, contact your dealer.
7. Before maintenance, be sure to unplug the power plug.
Sudden operation of the product may cause injury or electric shock.
8. When leaving the unit unattended for an extended period of time such as when going on vacation, leave the unit unplugged.



CAUTION

1. Do not use in places exposed to high temperature or humidity, or wet areas, such as a bathroom.
Electric leakage may occur, resulting in electric shock or a fire.
2. Do not use in greasy or oily environments such as the kitchen.
Premature clogging of the filter unit will result.
3. Do not use near open flame or flammable materials.
It may ignite and cause a fire.
4. Do not insert foreign objects such as pins or wires in the air intake grille, air outlet grille, or gaps.
5. Do not wipe with harsh chemicals such as benzine or thinner, or allow insecticide to come into contact with it.
6. When unplugging the power plug, grasp the power plug, not the power cord.
Such handling may cause a short circuit or wire breakage, resulting in a fire or electric shock.
7. This unit is not designed for wall mounting, do not attempt to mount it on any wall, it should be placed on a firm surface.

Parts Identification

Control panel

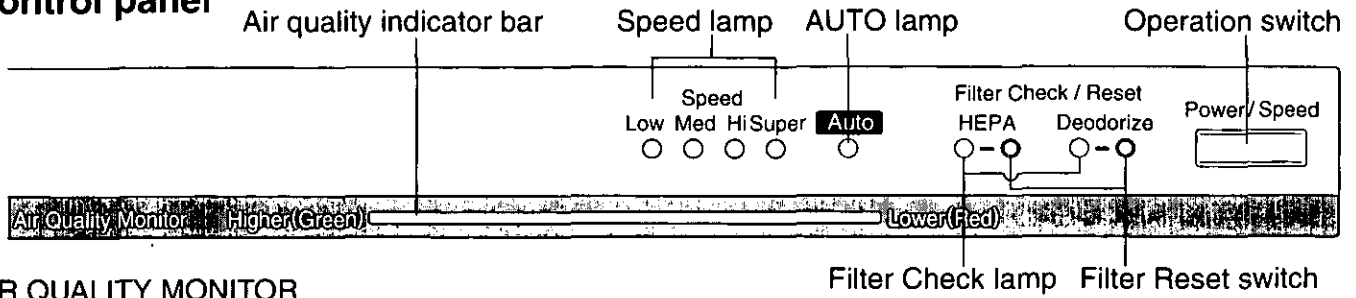

AIR QUALITY MONITOR

The level of airborne particulates passing through the micro dust sensor is shown by the illuminated green / red air quality indicator bar. A higher level of particulates in the air that pass through the sensor will be shown as RED color illumination on the indicator bar from low to high. When the indicator bar is illuminated green, no particulates are being detected through the sensor.

Note The air quality indicator bar is always illuminated as long as the unit is plugged into a wall outlet.

Front

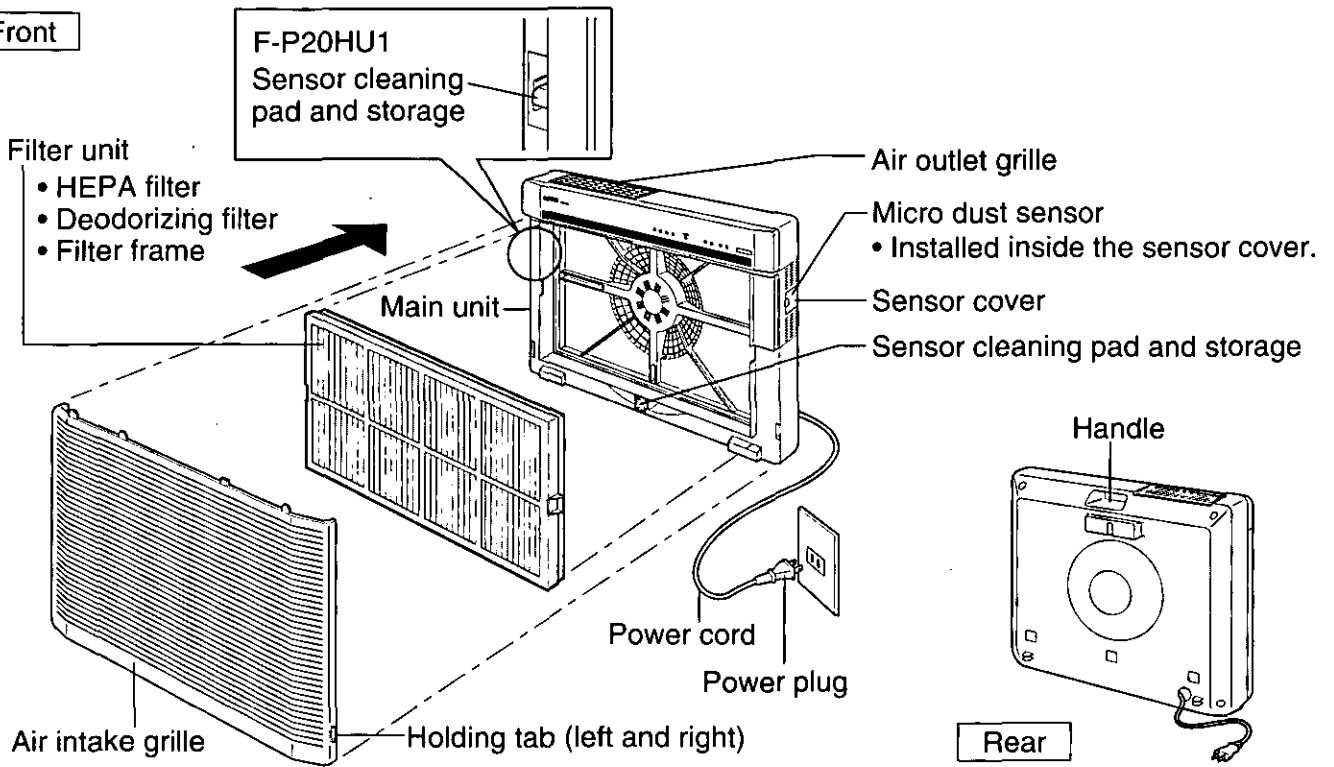

Functions of Micro dust sensor

The sensor is capable of detecting	The sensor will not detect
Tobacco smoke, pollen, oil mist, drops, dust, etc.	Alcohol, Gases

Note

- Airflow in the room may affect the micro dust sensor's operation. When the product is used near a humidifier or in places with a high level of soot, or when dusty air blows in from outdoors, air quality indicator bar may remain red continuously.
- The micro dust sensor will only detect particles which are airborne, in this case dust that has settled in room may not be detected unless it is disturbed by the movement of persons or pets in the room. In such places with minimal activity it is recommended that a manual fan speed setting be selected other than "Auto" for continuous air cleaning.
- Aerosol spray such as air freshener or furniture polish sprayed in the room may easily be detected by the micro dust sensor and thereby illuminate the air quality indicator bar completely red until the air has been cleared.

Before use

1. Install the filter unit.

Note

The filter unit is packaged with a plastic sheet which must be removed before use.

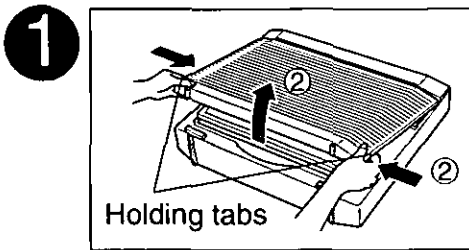

Remove the air intake grille.

- ① Lay the main unit down on a table.
- ② While pressing the left and right holding tabs, lift up and out grille as illustrated.

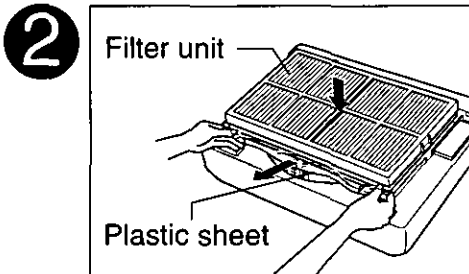

Remove the plastic sheet, and reinstall the filter unit onto the main unit.

- Install with the "Front" indicated on the side face of the filter frame at the top. (You will find a label to guide you.)

Note

Be sure to remove the plastic sheet as illustrated.

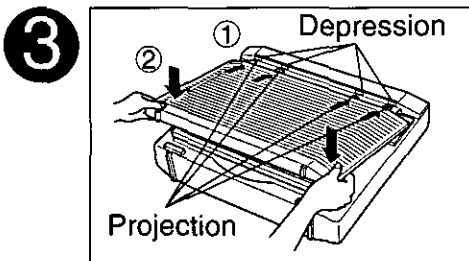

Reinstall the air intake grille.

- ① Align the top projections (4 places) with the depressions in the main unit.
- ② Press until the holding tabs lock.

2. Plug in the power plug

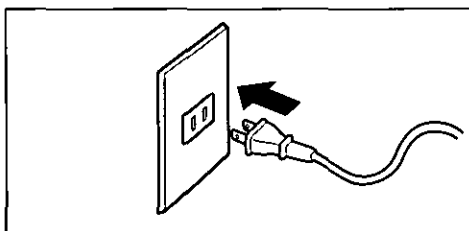

Note

- As long as the power plug is inserted in an electrical outlet, the unit is energized and the air quality indicator bar will be illuminated.
- In order to turn the unit completely off, it must be unplugged.

- This appliance has a polarized plug (one blade is wider than the other). To reduce the risk of electric shock, this plug is intended to fit in a polarized outlet only one way. If the plug does not fit fully in the outlet, reverse the plug. If it still does not fit, contact a qualified electrician. Do not attempt to defeat this safety feature.

3. Set the "HEPA" and "Deodorize" filter reset switch

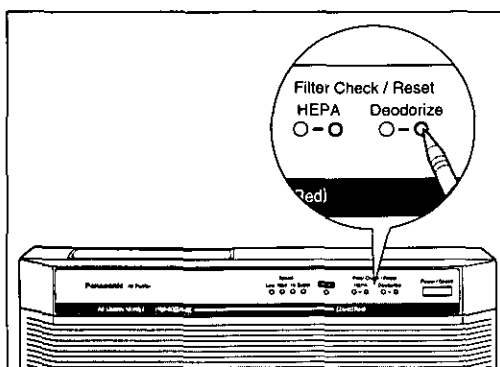

- Using a small narrow tip object press both "HEPA" and "Deodorize" filter switches through the small openings that is to the right of the indicator lamps.
- A beep will sound when each switch is pressed.
- An internal electronic counter will now start keeping the time that both filters are in use in order to illuminate the red indicator lamps when it comes time to replace the filters, approx. 3 years for the "HEPA" filter and approx. 1 year for the "Deodorize" filter (time may vary depending on usage).

To operate the unit

Control panel section

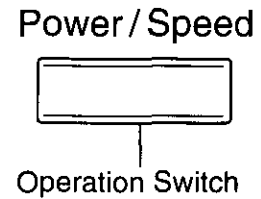
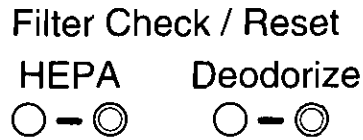
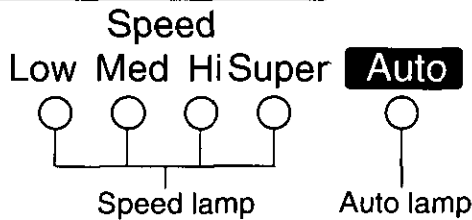

Power/Speed switch

This switch is a six position switch.
Each time this switch is pressed, the operation mode changes without stopping from Low to Med to Hi to Super, to automatic operation, to Monitor position. (On any operation mode other than Monitor position, the operation indicator lamp comes on to tell you which operation mode you've selected.)

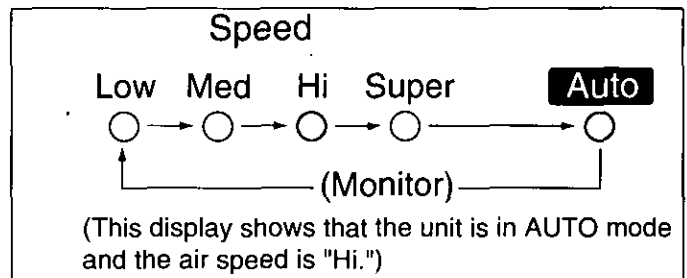

■ For Manual operation

Manually select the air speed (Low, Med, Hi, or Super) as desired.

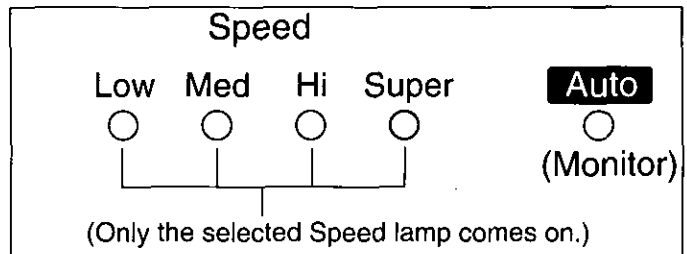

■ For Automatic operation

In "Auto" mode, the unit will detect the condition of the air passing through the micro dust sensor then automatically select the fan speed (Low, Med, Hi). (The AUTO lamp and the Air Speed lamp come on.)

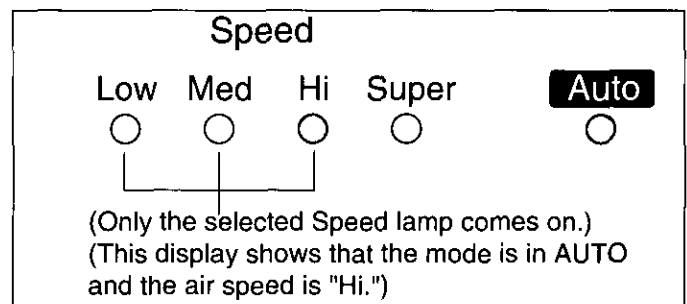

Note

- When in the AUTO mode, the air speed setting "Super" is not used.

Note

Do not use in place of a fan or kitchen range hood. If you do, the filter life may be considerably diminished or the product may suffer damage.

Care and maintenance

WARNING

Before maintenance, be sure to unplug the power plug.

Sudden unexpected operation of the product may cause injury or electric shock.

Note

Do not wipe with benzine or thinner.

This may cause damage to the unit.

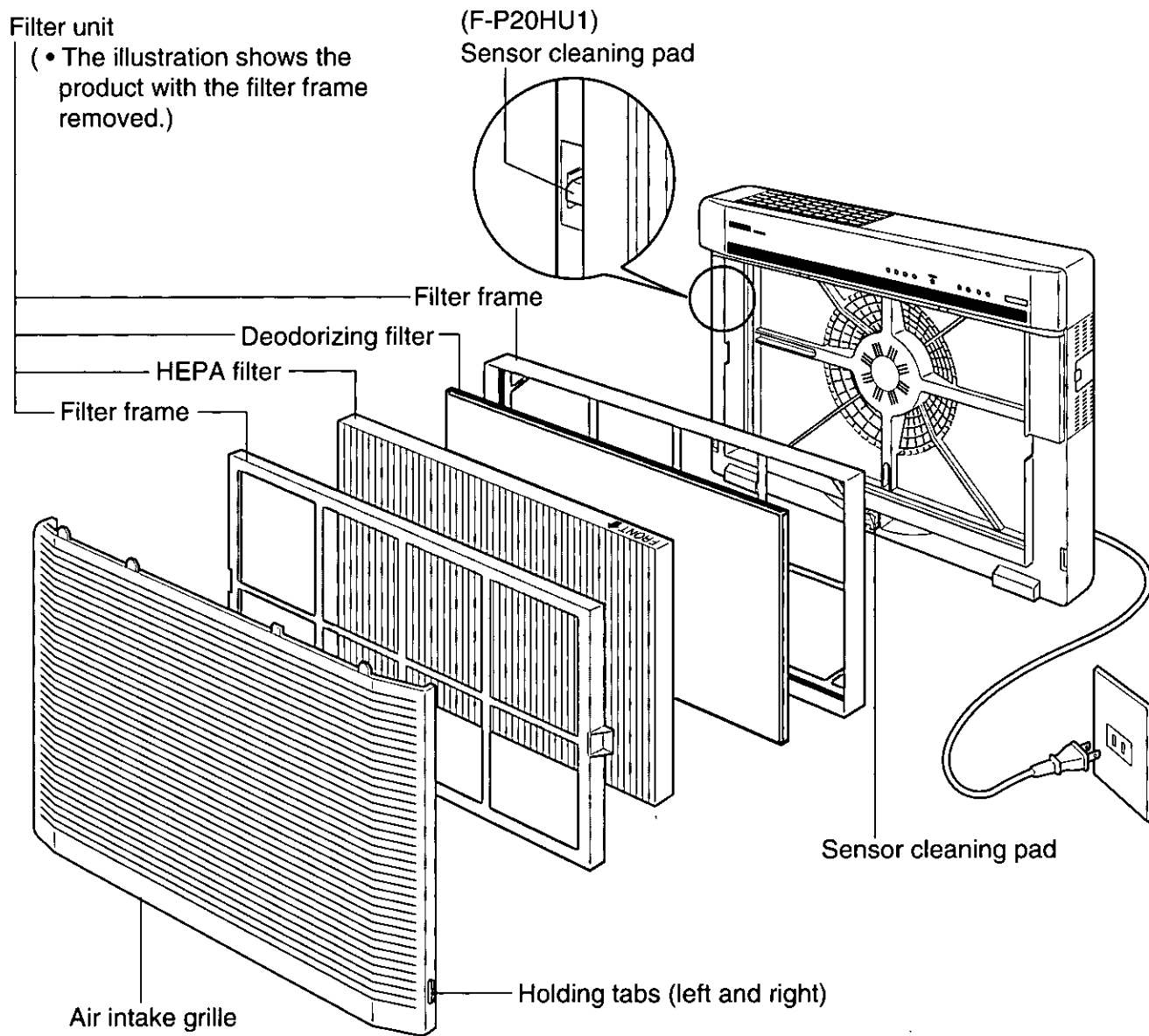

Care and maintenance

Main unit (once a month or so)

Dampen a soft cloth with lukewarm water or diluted neutral kitchen detergent and wring it out.

Wipe any stains off with the cloth and rub dry with another cloth.

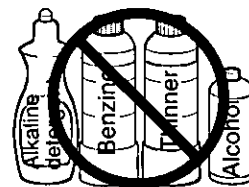

■ How to remove the air intake grille

- ① Lay the main unit down on a table.
- ② While pressing the left and right holding tabs, lift up and out grille as illustrated.

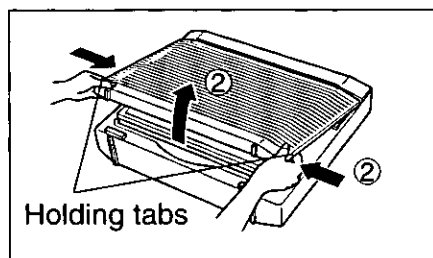

■ How to reinstall the air intake grille

- ① Align the top projections (4 places) with the depressions in the main unit.
- ② Press until the holding tabs lock.

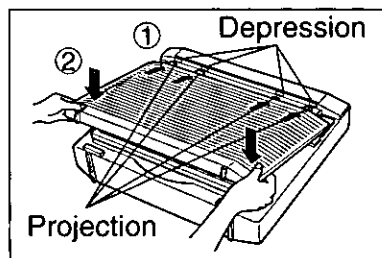

Air intake grille, filter unit (once a month or so)

1 Remove the air intake grille.

2 Clean the air intake grille.

- Use a vacuum cleaner with dusting brush.
- If stains are not completely removed, wash the air intake grille with water.

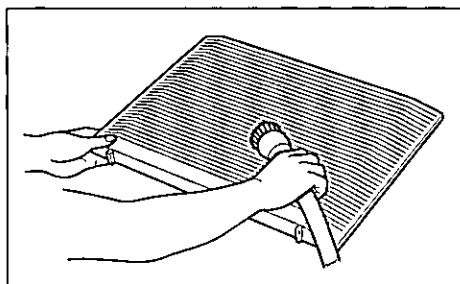

3 Wipe water off the grille with a soft cloth, and dry it completely.

4 Remove dust on the surface of the filter.

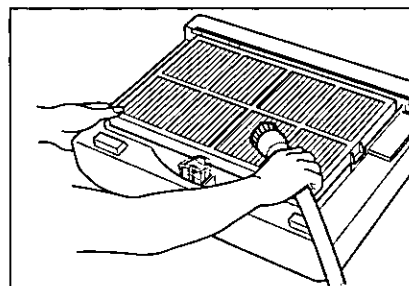

Note

- Lightly vacuum with dusting brush do not apply too much pressure. If you do, the HEPA filter may be damaged.
- Never wash the filter unit in water.

5 Reinstall the air intake grille.

Care and maintenance

■ General timetable for filter changes

- When it is obvious that odor or cigarette smoke is not quickly removed or the operating sound becomes louder than normal.

Note The time of filter replacement may vary depending on condition of use.

- New filters may be purchased through your local dealer or parts distributor using the following part numbers or call 1-800-332-5368 (PANASONIC SERVICE CENTER).

Model No.	F-P15HU2	F-P20HU1
HEPA filter	Part No. F-Y15XS	Part No. F-Y120XT
Deodorizing filter	Part No. F-Y55XS	Part No. F-Y520XT

Replacement of the filter

The HEPA filter and the deodorizing filter can be separately replaced.

■ General timetable for filter replacement

- | | |
|---------------------------|---|
| HEPA filter | <ul style="list-style-type: none">• When the filter check lamp's red light is on (about 3 years after pressing the reset switch)• Even when the lamp is on, operation will not stop. |
| Deodorizing filter | <ul style="list-style-type: none">• When the filter check lamp's red light is on (about 1 year after pressing the reset switch)• Even when the lamp is on, operation will not stop. |

■ How to replace the filter: Read the replacement instructions, on the replacement parts filter box.

After replacing any of the filters, plug in the power cord and reset the corresponding reset switch, (refer to "before use")

HEPA Filter replacement

- ➔ After replacement press the "HEPA" reset switch.

Deodorizing filter replacement

- ➔ After replacement press the "Deodorize" reset switch.

(A beep sound should be heard when each reset switch is pressed).

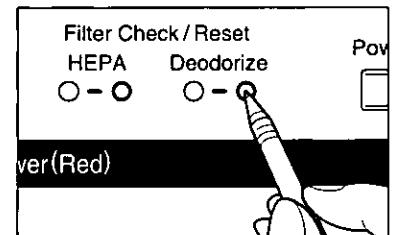

Filter frame

Wring out a soft cloth dampened with lukewarm water or a diluted neutral detergent for kitchen use. Wipe any stains off with the cloth and rub dry with another cloth.

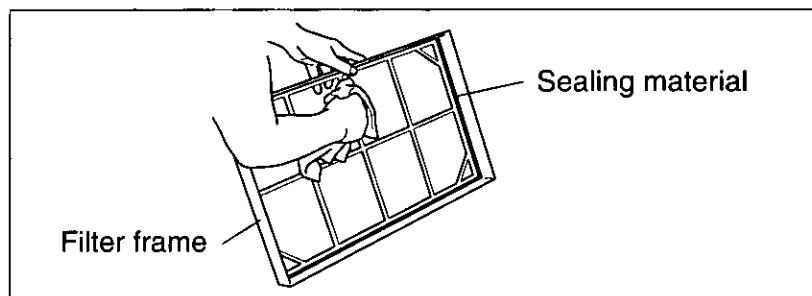

Note

- Do not rub the label too hard. (It will come off.)
- Do not scrub the sealing material (black) on the filter frame. (The sealing material will be damaged, resulting in loss of performance.)

Care and maintenance

Micro dust sensor

If dust accumulates on the micro dust sensor, the AIR QUALITY MONITOR may not be displayed correctly. Maintain it frequently even during the first year of use, depending on the operating environment.

1 Remove the sensor cover on the right side of the main unit.

- Press the hook to remove it.

Note

- Do not separate the black foam rubber attached to the inner surface of the sensor cover. If you do, sensitivity will be lost.

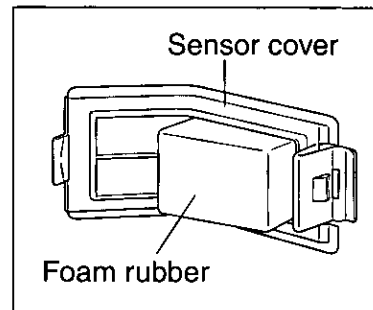
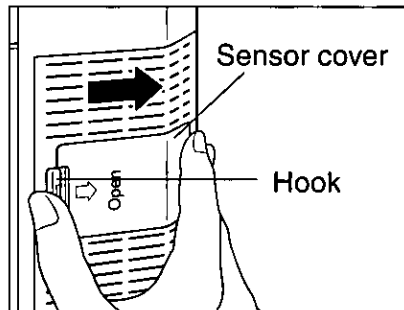

2 Remove the air intake grille and take out the cleaner.(Refer to Page 8.)

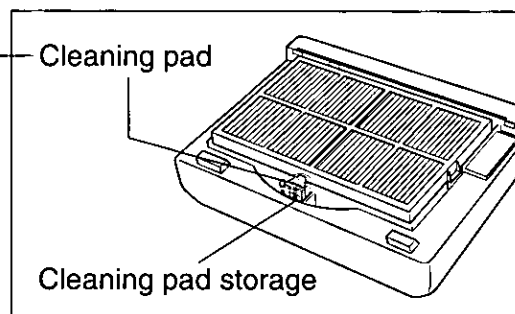
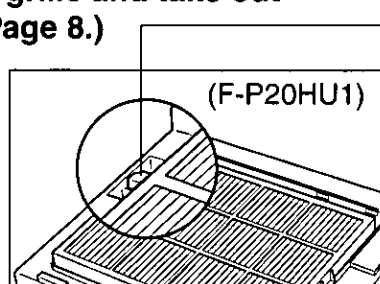

3 Clean the lenses (2 places) of the micro dust sensor with the cleaning pad.

- ① Insert the cleaning pad straight into the cleaning window.
- ② Remove any stains from the lenses (2 places) by rotating the cleaning pad in a side to side motion.

Cleaning pad

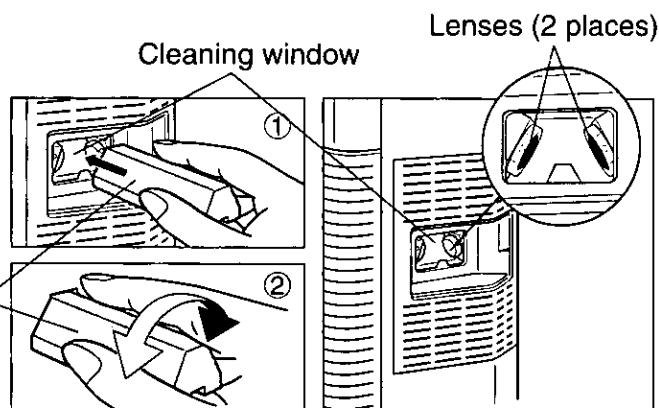

Note

- Do not use any detergent to maintain the lenses.
- Wipe carefully.
- If stains are not completely removed from the lenses with the cleaning pad, wipe them carefully with a commercial cotton swab.

4 Install the sensor cover back on the main unit.

- If you wash the stained cleaning pad with water, dry it thoroughly.

5 Place the cleaning pad in the storage area, and reinstall the air intake grille.

Troubleshooting

If a problem is encountered, investigate it by referring first to the table below. If you cannot correct it, unplug the power plug and consult an authorized service dealer.

Symptom	Check point	Page
The product does not operate.	Is the power plug disconnected from the outlet?	5
No air comes out. Abnormally loud operating sound.	Is the plastic sheet removed from the main unit? Remove the plastic sheet.	5
The product continues operating in the AUTO mode.	Is the air dusty? (excessive dust) Is dusty outside air getting in?	4
Odors are not removed.	Is the main unit or air intake grille dirty? Clean it. If the symptoms still remain unchanged, replace the Deodorizing filter with a new one.	8,9
Smoke is not removed. The operating sound is abnormally loud.	Is the filter full of dust? (clogged) Clean the HEPA filter. If the symptoms still remain unchanged, replace the HEPA filter with a new one.	8,9
The product is not activated by smoking. The product is not activated in spite of high levels of house dust.	Is the product installed where it is actually exposed to tobacco smoke and house dust? Install it in another place or use Continuous operation mode.	6
	Is the micro dust sensor dirty? Clean the micro dust sensor with the cleaning pad.	10
The air quality indicator bar stays green all the time.	Is there airborne dust in the air? This is normal when dust is settled in the room and is not disturbed by room activity.	4

Specifications/Replacement filters

Specifications

Model No.	F-P15HU2				F-P20HU1			
Power	120V AC / 60Hz							
Air speed levels	Super	Hi	Med	Low	Super	Hi	Med	Low
Power Consumption(W)	101	75	57	43	150	107	76	55
Air volume(CFM)	151.7	112.9	77.6	38.8	201.3	162.5	113	63.6
Cord length	8.2 ft							
Dimensions(H X W X D)	15 5/8" X 21 1/4" X 6"				18 3/4" X 22" X 6 5/8"			
Room size dimensions	Applicable room size 12ft X 18ft				Applicable room size 16ft X 20ft			
Weight	13.9 lbs				16.3 lbs			

- Power consumption when at rest: about 4.2 W.

Replacement filters

Model No.	F-P15HU2	F-P20HU1
HEPA filter	Part No. F-Y15XS	Part No. F-Y120XT
Deodorizing filter	Part No. F-Y55XS	Part No. F-Y520XT

- To order Replacement filters, call 1-800-332-5368.

Panasonic Consumer Electronics Company,
 Division of Matsushita Electric Corporation of America
 One Panasonic Way
 Secaucus, New Jersey 07094

Panasonic Sales Company, Division of
 Matsushita Electric of Puerto Rico, Inc. ("PSC")
 Ave. 65 de Infanteria, Km. 9.5
 San Gabriel Industrial Park, Carolina,
 Puerto Rico 00985
 Tel.(787)750-4300 Fax.(787)768-2910