

Color TV with built-in VCR

CCZ252AT

Owner's Manual

Important!
Return your **Warranty Registration**
Card within 10 days. See why **inside.**

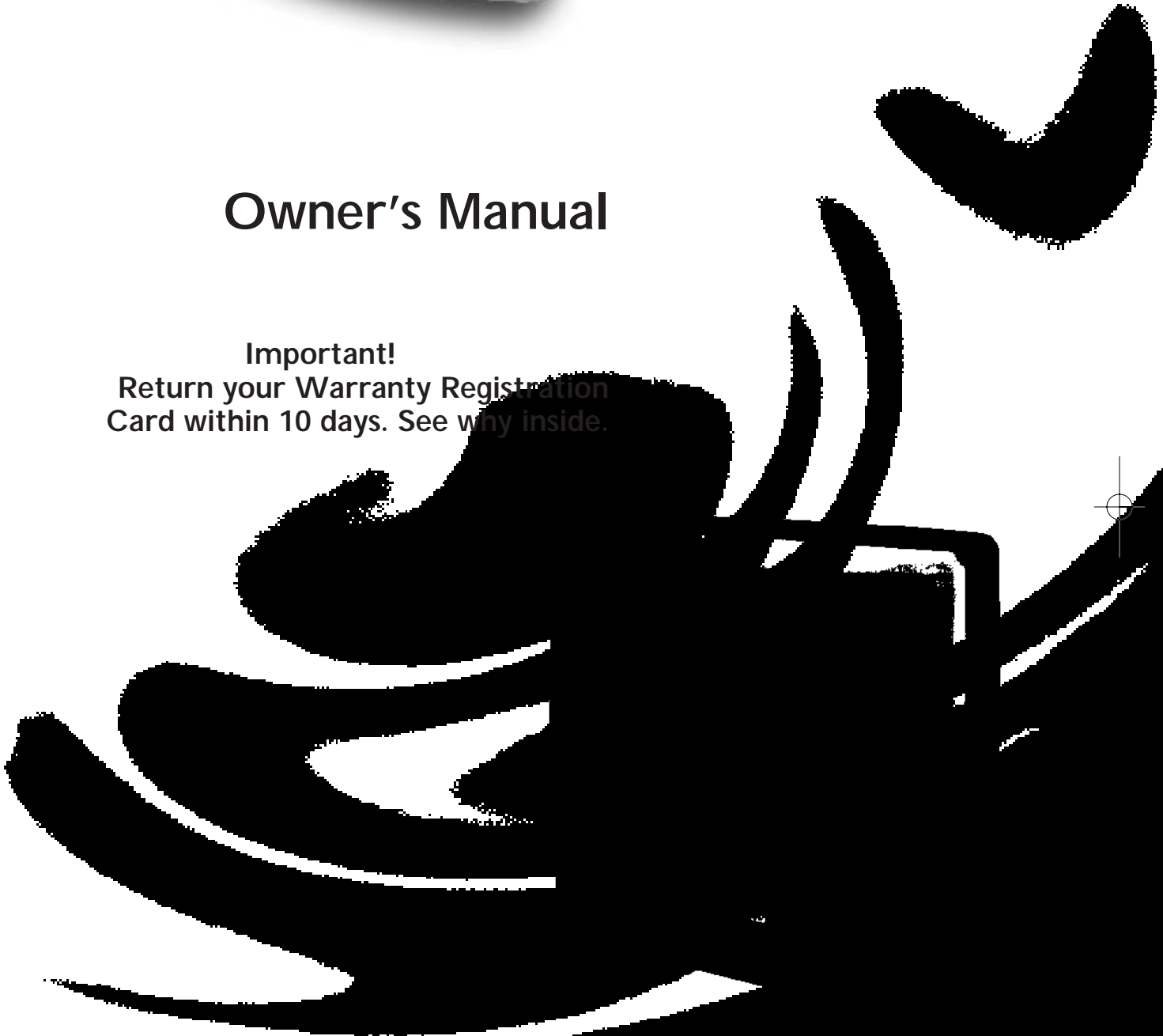

PHILIPS **MAGNAVOX**

Return your Warranty Registration card today to ensure you receive all the benefits you're entitled to.

Once your PHILIPS MAGNAVOX purchase is registered, you're eligible to receive all the privileges of owning a PHILIPS MAGNAVOX product. So complete and return the Warranty Registration Card enclosed with your purchase at once. And take advantage of these important benefits.

Warranty Verification

Registering your product within 10 days confirms your right to maximum protection under the terms and conditions of your PHILIPS MAGNAVOX warranty.

Owner Confirmation

Your completed Warranty Registration Card serves as verification of ownership in the event of product theft or loss.

Model Registration

Returning your Warranty Registration Card right away guarantees you'll receive all the information and special offers which you qualify for as the owner of your model.

PHILIPS MAGNAVOX



Congratulations on your purchase, and welcome to the "family!"

Dear PHILIPS MAGNAVOX product owner:

Thank you for your confidence in PHILIPS MAGNAVOX. You've selected one of the best-built, best-backed products available today. And we'll do everything in our power to keep you happy with your purchase for many years to come.

As a member of the PHILIPS MAGNAVOX "family," you're entitled to protection by one of the most comprehensive warranties and outstanding service networks in the industry.

What's more, your purchase guarantees you'll receive all the information and special offers for which you qualify, plus easy access to accessories from our convenient home shopping network.

And most importantly you can count on our uncompromising commitment to your total satisfaction.

All of this is our way of saying welcome-and thanks for investing in a PHILIPS MAGNAVOX product.

Sincerely,



Robert Minkhorst
President and Chief Executive Officer

P.S. Remember, to get the most from your PHILIPS MAGNAVOX product, you must return your Warranty Registration Card within 10 days. So please mail it to us right now!

Know these

safety symbols



⚡ This "bolt of lightning" indicates uninsulated material within your unit may cause an electrical shock. For the safety of everyone in your household, please do not remove product covering.

⚠ The "exclamation point" calls attention to features for which you should read the enclosed literature closely to prevent operating and maintenance problems.

WARNING: TO PREVENT FIRE OR SHOCK HAZARD, DO NOT EXPOSE THIS EQUIPMENT TO RAIN OR MOISTURE.

CAUTION: To prevent electric shock, match wide blade of plug to wide slot, and fully insert.

ATTENTION: Pour éviter les chocs électriques, introduire la lame la plus large de la fiche dans la borne correspondante de la prise et pousser jusqu'au fond.

For Customer Use

Enter below the Serial No. which is located on the rear of the cabinet. Retain this information for future reference.

Model No. _____
Serial No. _____

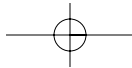

Introduction 3

Welcome to your TV/VCR owner's manual.

This manual has six sections: Setting Up Your TV/VCR; Description of Controls; Basic Operations; Recording Options; Playing Options; and Information You May Need. The instructions explain all of the TV/VCR's features, which are listed below.

Features

- A-B Repeat Play
- Automatic Channel Setup
- Automatic Operation Features
- Automatic Tracking Adjustment
- Closed Caption
- Daylight-Saving Time
- High Quality (HQ) System
- On-Screen displays in English or Spanish
- On-Screen Menu Programming, accessible with remote control or front panel buttons
- One-Touch Recording
- Real-Time Counter
- Remote Control
- Repeat Play
- Sleep Timer
- SmartClock™
- Special Effects Playback: Forward and Reverse Searching; Still
- Timer Recording

Safety Precautions

Warning: To prevent fire or shock hazard, do not expose this equipment to rain or moisture.

FCC Warning: Any unauthorized changes or modifications to this equipment void the user's authority to operate it.

This TV/VCR, equipped with a High Quality (HQ) system, is compatible with existing Video Home System (VHS) equipment.

Philips Consumer Electronics Company recommends that you use only video cassette tapes that have been tested and inspected for use in two, four, six, and eight hour VCRs, and which are labeled with the **VHS** mark. The use of tapes that have not been inspected for use in two, four, six, and eight hour VCRs may result in poor picture quality and excessive deposits on the video heads, which may not be covered by the warranty if damage occurs.

Note to the Cable TV System Installer: This reminder is provided to call the Cable TV system installer's attention to Article 820-40 of the National Electrical Code, which provides guidelines for proper grounding – in particular, specifying that the cable ground shall be connected to the grounding system of the building, as close to the point of cable entry as possible.

SmartClock™ is a trademark of Philips Consumer Electronics Company.
Copyright 1998 Philips Consumer Electronics Company. All rights reserved.

Helpful Hint

- Before doing anything else, record the TV/VCR's model and serial numbers in the spaces provided on page two. These numbers will help us assist you if you ever call for help.



4 Table of Contents

Setting Up Your TV/VCR

Introduction	3
Table of Contents	4
Before Using the TV/VCR	5
Hooking Up the TV/VCR	6 - 7
Turning On the TV/VCR	8
Language Selection	9
Automatic Channel Setup	10 - 11
Setting the Clock	12 - 17
Daylight-Saving Time	18
Time Zone	19

Description of Controls

Front Panel	20
Rear Panel	21
Remote Control Buttons	22 - 23
Adjusting the Picture Controls	24 - 25
On-Screen Status Displays	26
Reminder	27

Basic Operations

Playing	28
Recording	29

Recording Options

One-Touch Recording	30
Rerecording (Tape Duplication)	31
Timer Recording	32 - 35
Record Defeat	36

Playing Options

Setting the Sleep Timer	37
Closed Caption	38 - 39
Volume Bar	40
Repeat Play	41
A - B Repeat Play	42 - 43
Real-Time Counter Memory	44
Automatic Operation Features	45
Playback Options	46

Information You May Need

Specifications / Glossary	47
Helpful Hints	48 - 49
Limited Warranty	50
Index	51
Supplied Accessories	52

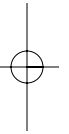
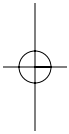



Before Using the TV/VCR 5

Putting Batteries in the Remote Control

1

Remove the battery compartment lid on the bottom of the remote control by sliding it in the direction of the arrow.

2

Place two AA batteries inside the battery compartment with their + and - ends aligned as indicated.

3

Replace the battery compartment lid.

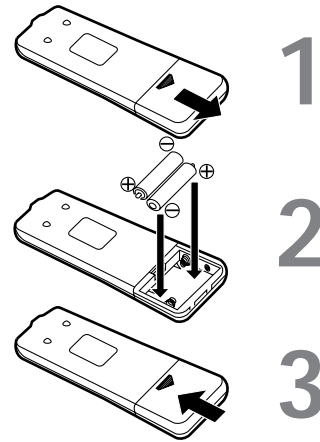

Using the Remote Control

- Point the remote control at the TV/VCR's remote sensor.
- Do not put objects between the remote control and the TV/VCR.

Erasure Prevention

Video cassette tapes have record tabs to ensure that recordings are not accidentally erased.

1

To prevent accidental erasure, break off the tab with a screwdriver.

2

To record again, cover the hole with cellophane tape.

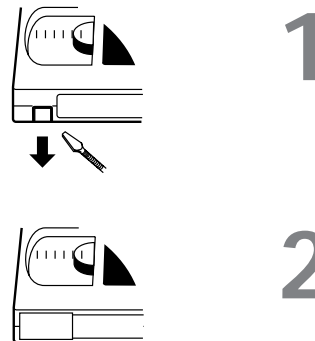

TV/VCR Maintenance

- In this TV/VCR, use only tapes with the **VHS** mark.
- Make sure any light adhesive stick-on notes are removed from the video cassette tape before putting the tape in the TV/VCR. Removable labels like these can jam the TV/VCR.
- Periodic maintenance is required to maintain your TV/VCR's excellent performance. This TV/VCR has an automatic head cleaning system. However, the video heads will eventually require cleaning or replacement. Cleaning or replacement of the video heads should be performed by an authorized service center.

Helpful Hints

- The remote control and its batteries are supplied.
- Do not mix alkaline and manganese batteries.
- Do not mix old and new batteries.

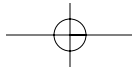

6 Hooking Up the TV/VCR

1

Hook up your TV/VCR using one of the connections shown.

A.

Hooking Up Your TV/VCR With a Cable Signal or Outdoor Antenna

Connect a Cable signal or an antenna to the ANT(enna) Jack.

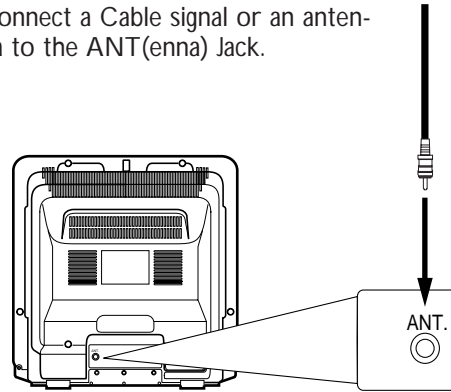

B.

Hooking Up Your TV/VCR With a Cable Box

To view any channel, set the TV/VCR to the Cable Box output channel (channel 03 or 04). Then, select channels at the Cable Box.

Connect the Cable signal to the IN Jack on the Cable Box.

Connect an RF coaxial cable (75-ohm, not supplied) to the OUT Jack on the Cable Box and to the ANT(enna) Jack on the TV/VCR.

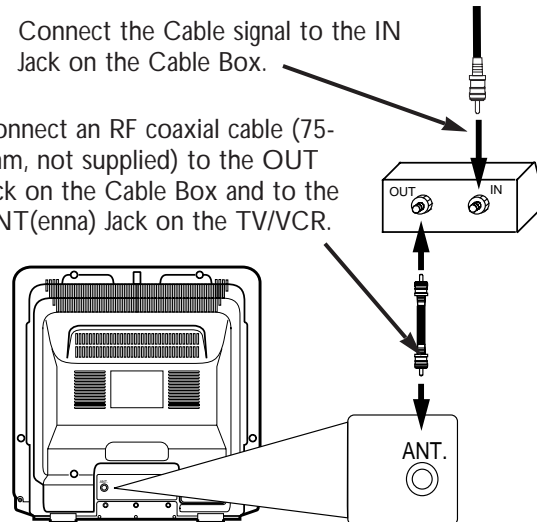

C.

Hooking Up Your TV/VCR With an Indoor Antenna

To install a rod antenna (not supplied), push the stem of the antenna into the antenna hole on the top of the TV/VCR. Connect the antenna wire to the ANT(enna) Jack on the back of the TV/VCR as shown. Extend the antenna and adjust its length, direction, and angle for the clearest picture.

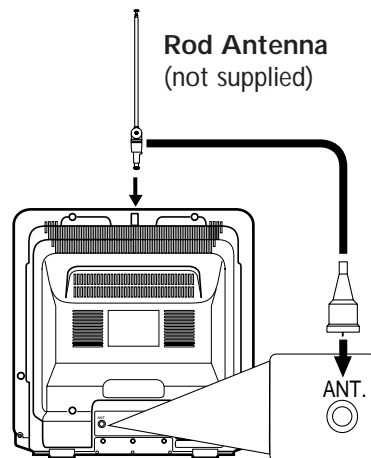

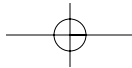

Hooking Up the TV/VCR (cont'd) 7

D.

Hooking Up Your TV/VCR to Another Video Source (VCR or Camcorder)

You may need this connection if you want to copy tapes. Details are on page 31.

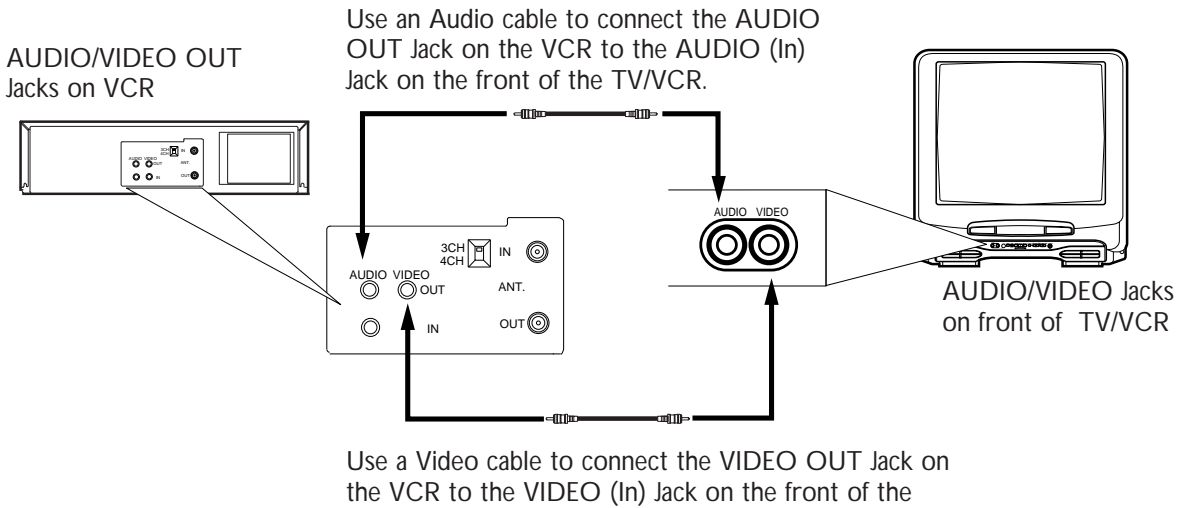

2

Plug in the TV/VCR.

3

Before you turn on the TV/VCR, go to page eight.

Helpful Hints

- Before connecting the rod antenna or coaxial cable to the ANT(enna) Jack, make sure the pin is not bent. If the pin is bent, straighten it as illustrated, then connect it to the ANT(enna) Jack.
- Audio and video cables are not supplied.

Crooked Pin

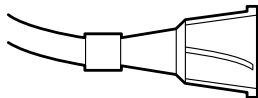

Straight Pin

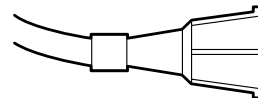

8 Turning On the TV/VCR

Before you turn on the TV/VCR, make sure there are batteries in the remote control and the TV/VCR is hooked up correctly. The instructions on this page work only when you turn on the TV/VCR for the first time.

1

Press the **POWER** button. The TV/VCR will come on and the screen shown below will appear.

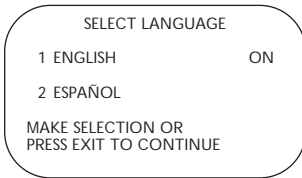

2

Press the **Number 1** button to select English on-screen displays or press the **Number 2** button to select Spanish on-screen displays.

3

Press the **STATUS/EXIT** button. The screen shown below will appear.

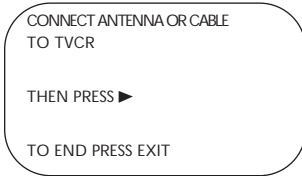

4

Press the **F.FWD/►** button to begin automatic channel setup. The TV/VCR will memorize all available channels. When channels are set, CHANNELS ARE SET will appear on-screen briefly. Then the TV/VCR will go to the lowest channel programmed.

5

Use the **CHANNEL ▲/▼** buttons or the **Number** buttons on the remote control to select a TV/VCR channel. Use the **VOLUME ▲/▼** buttons to adjust the sound.

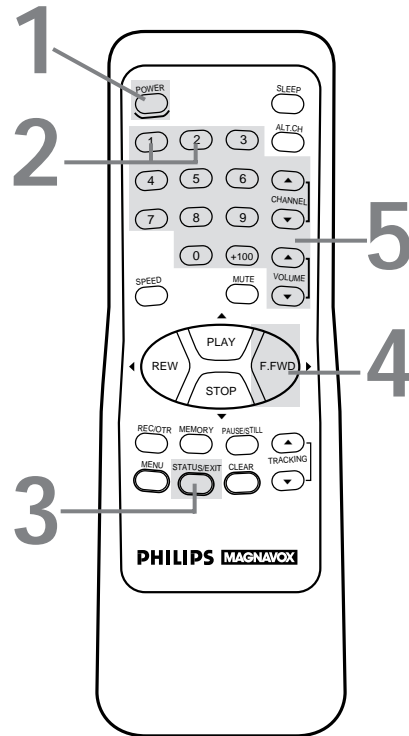

Helpful Hints

- If you do not see any on-screen displays when you turn on the TV/VCR, check your hookups, then try again. If you still do not see any on-screen displays, follow the steps on pages nine - 10 to select a language and set up channels.
- To skip step 2, press the STATUS/EXIT button. All on-screen displays will be in English. To skip step 4, press the STATUS/EXIT button. Channels will not be set up, and CHANNELS NOT SET will appear on-screen briefly.
- You cannot set up channels if you are using a Cable Box.
- Line Input mode will always be stored in the TV/VCR's memory as channel 00. When you select channel 00, A/V IN will appear on-screen briefly. Press the CHANNEL ▲/▼ buttons or Number buttons to select another channel.

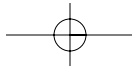

Language Selection 9

Follow the steps below to change the language of the on-screen displays.

1

Press the MENU button.

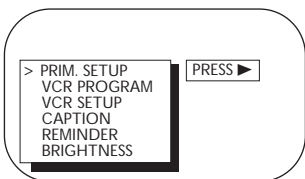

2

Press the PLAY/▲ button or the STOP/▼ button to select PRIM. SETUP. Then, press the F.FWD/▶ button.

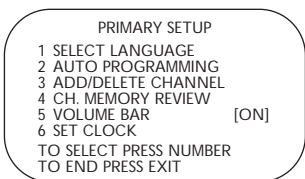

3

Press the Number 1 button to choose SELECT LANGUAGE.

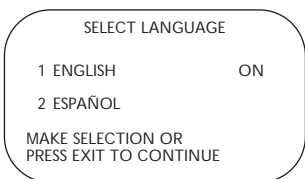

4

Press the Number 1 button if you want the on-screen displays in English. ON will appear to the right of ENGLISH on-screen. Or, press the Number 2 button if you want the on-screen displays in Spanish. SI will appear to the right of ESPAÑOL on-screen.

5

Press the STATUS/EXIT button.

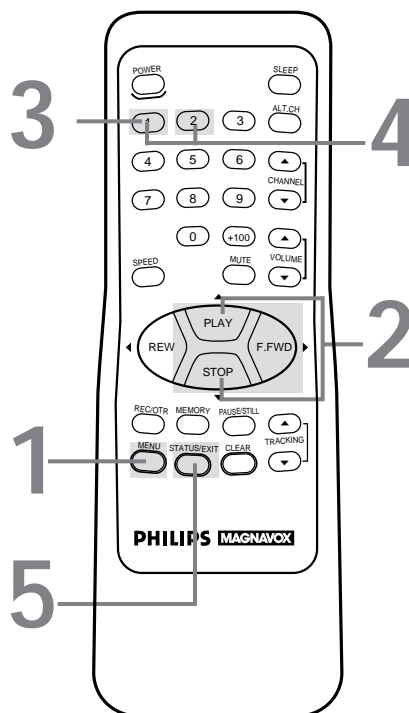

Helpful Hint

- If you accidentally select Spanish on-screen displays and need English on-screen displays:
 - 1) Press the MENU button.
 - 2) Press the PLAY/▲ button or the STOP/▼ button to select PREPARACION, then press the F.FWD/▶ button.
 - 3) Press the Number1 button to select SELECCION IDIOMA.
 - 4) Press the Number1 button to select ENGLISH.
 - 5) Press the STATUS/EXIT button.

10 Automatic Channel Setup

Although the TV/VCR may automatically memorize the channels you receive when you turn it on for the first time, you may set up channels again by following the steps below.

1

Press the MENU button.

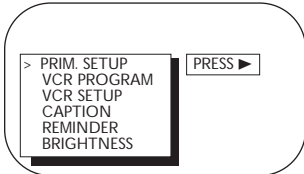

2

Press the PLAY/▲ button or the STOP/▼ button to select INPUT. Press the REW(ind)/◀ button or the F.FWD/▶ button until ANTENNA or CABLE (whichever you have) appears beside INPUT.

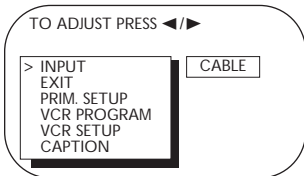

3

Press the STOP/▼ button repeatedly to select PRIM. SETUP, then press the F.FWD/▶ button.

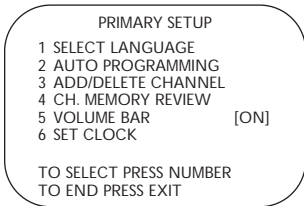

4

Press the Number 2 button to select AUTO PROGRAMMING. AUTO PROGRAMMING MEMORIZED CH... will appear on-screen. The TV/VCR will memorize all available channels.

5

Wait for a few minutes. When setup is complete, CHANNELS ARE SET will appear on-screen. Then the programming of the lowest channel number placed in the TV/VCR's memory will appear on-screen. Now, when you press the CHANNEL ▲/▼ buttons, you will scan only through channels you receive.

5

Wait for the TV/VCR to set up channels.

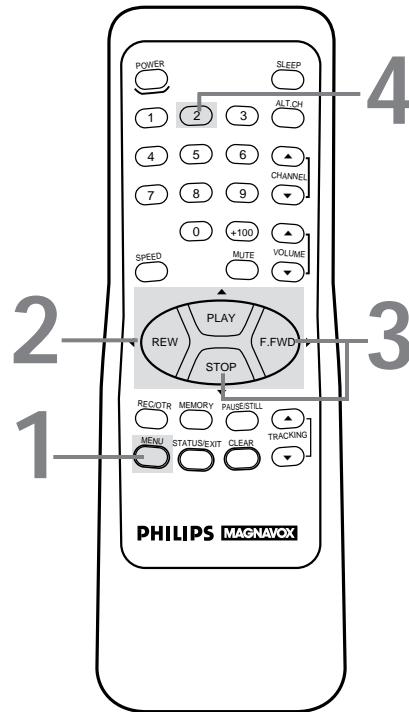

Helpful Hints

- Line Input mode will always be stored in the TV/VCR's memory as channel 00. You cannot delete it. To exit line input mode, press the CHANNEL ▲/▼ buttons or the Number buttons to select another channel.
- You cannot program channels when the TV/VCR is on channel 00 (A/V INPUT will appear beside INPUT at step 2). Select ANTENNA or CABLE at step 2.

Automatic Channel Setup (cont'd) 11

Adding/Deleting Channels

1

Press the MENU button.

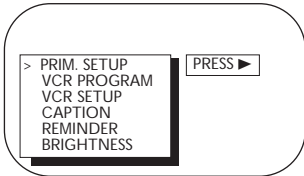

2

Press the PLAY/▲ button or the STOP/▼ button to select PRIM. SETUP, then press the F.FWD/► button.

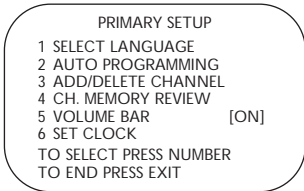

3

Press the Number 3 button to select ADD/DELETE CHANNEL.

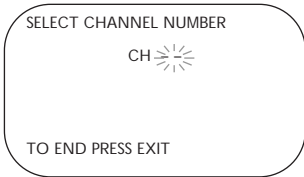

4

Press the Number buttons to enter the channel number you want to add or delete. You must enter a zero before single-digit channels.

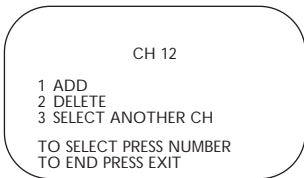

5

Within five seconds, press the Number 1 button to add that channel or the Number 2 button to delete that channel. If you do not make a choice within five seconds, you will return to the previous screen. (If you make a mistake, press the Number 3 button to select another channel.)

6

Press the STATUS/EXIT button.

Programming of the channel you added or deleted will appear.

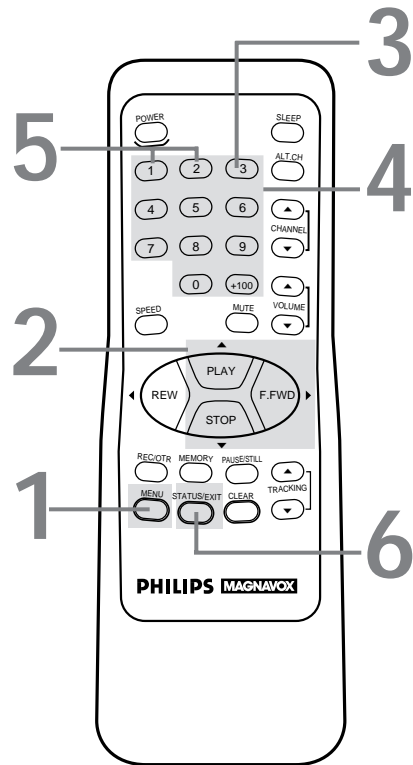

Helpful Hint

- To review the channels memorized by the TV/VCR, follow these steps.
 - 1) Press the MENU button.
 - 2) Press the PLAY/▲ button or the STOP/▼ button to select PRIM. SETUP. Press the F.FWD/► button.
 - 3) Press the Number 4 button to select CH. MEMORY REVIEW. A list of programmed channels will appear on-screen.
 - 4) If all the programmed channels don't fit on-screen, press the Number 1 button. If you do not press the Number 1 button within 10 seconds, the remaining channels will appear on-screen. (If there are no remaining channels, the previous menu will appear.) Or press the Number 2 button to see the previous screen of channels.
 - 5) Press the STATUS/EXIT button.

12 Setting the Clock

There are three ways to set the clock: Manually, with Automatic PBS Channel Selection, or with Manual PBS Channel Selection. With manual clock setting, you tell the TV/VCR the current time. With Automatic or Manual PBS Channel Selection, the TV/VCR gets the time from your local PBS station. If you use either Manual PBS Channel Selection or Automatic PBS Channel Selection, follow the steps on page 19 to have the TV/VCR maintain the clock according to your Time Zone.

To set the clock manually, follow the steps on pages 12 -13. To set the clock using Automatic PBS Channel Selection, follow the steps on pages 14 - 15. To set the clock using Manual PBS Channel Selection, follow the steps on pages 16 - 17.

Before you begin, make sure:

- The TV/VCR is hooked up and turned on.
- Channels are set up.
- You make each entry within 60 seconds of the previous entry. (If you do not, you may start again at step 1.)

Manual Clock Setting

1

Press the MENU button.

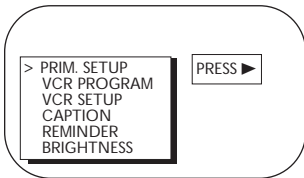

2

Press the PLAY/▲ button or the STOP/▼ button to select PRIM. SETUP. Then, press the F.FWD/▶ button.

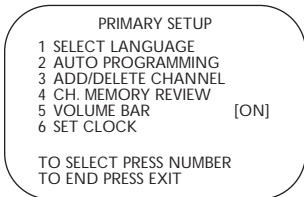

3

Press the Number 6 button to select SET CLOCK.

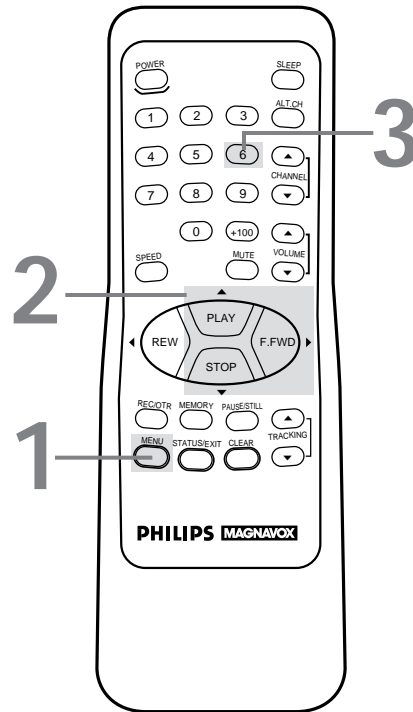
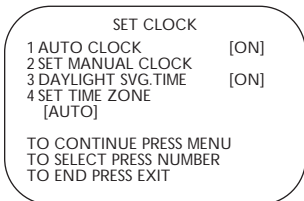

Helpful Hints

- Entries that do not match the TV/VCR's calendar will cause a question mark to appear on screen.
- To make corrections while you are setting the clock, press the CLEAR button until the space for the number you want to correct is flashing. Then enter the correct number.

Setting the Clock (cont'd) 13

4

Press the Number 2 button to select SET MANUAL CLOCK.

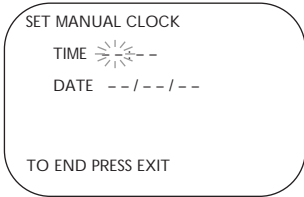

5

Press two Number buttons for the hour(s) and two Number buttons for the minute(s). Then press 1 for AM or 2 for PM. For example, for 9:30 PM, press 09, 30, 2.

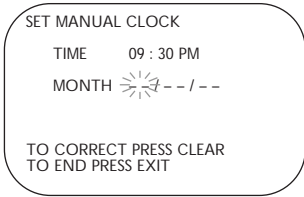

6

Press two Number buttons for the month, two Number buttons for the day, and two Number buttons for the year. For example, for July 1, 1998, press 07, 01, 98. The day of the week will appear automatically.

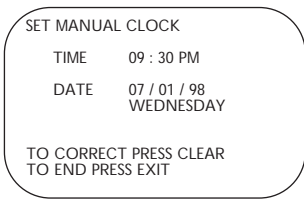

7

Press the STATUS/EXIT button.

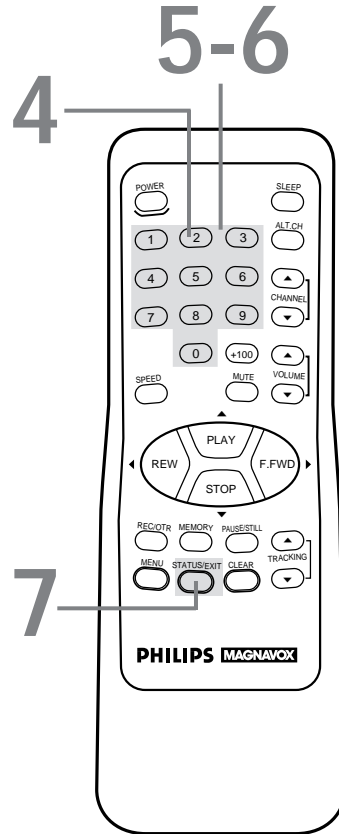

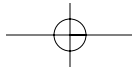

14 Setting the Clock (cont'd)

Automatic PBS Channel Selection

1

Press the MENU button.

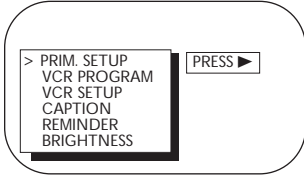

2

Press the PLAY/▲ button or the STOP/▼ button to select PRIM. SETUP. Then, press the F.FWD/▶ button.

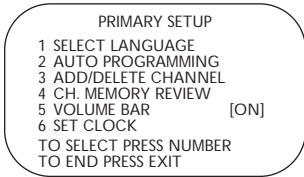

3

Press the Number 6 button to select SET CLOCK.

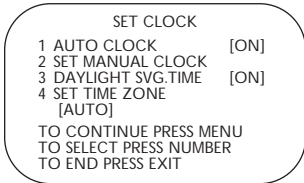

4

If ON appears beside AUTO CLOCK, press the MENU button. If OFF appears beside AUTO CLOCK, press the Number 1 button so that ON appears to the right of AUTO CLOCK, then press the MENU button.

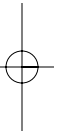
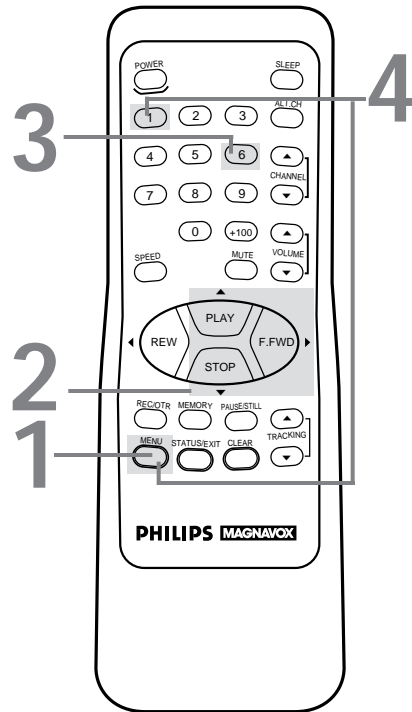
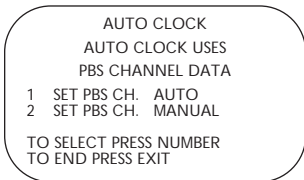

Setting the Clock (cont'd) 15

5

Press the Number 1 button to select SET PBS CH. AUTO.

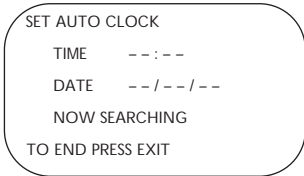

6

NOW SEARCHING flashes on the TV/VCR screen. However, you may see the message "PLEASE TURN OFF TO SET AUTO CLOCK PLEASE WAIT SEVERAL MINUTES." If this message appears, turn off the TV/VCR for a few minutes. When you turn on the TV/VCR, the time will be set. If the time is not set, repeat steps 1 - 5. Or, follow the steps on pages 12 - 13 to set the clock manually or pages 16 - 17 to set the clock with Manual PBS Channel Selection.

7

When the TV/VCR finds the PBS channel, the time will appear on-screen. Press the STATUS/EXIT button.

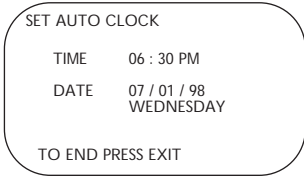

- If **CANNOT FIND CLOCK DATA** flashes on the TV/VCR screen, you will be prompted to turn off the TV/VCR. Turn off the TV/VCR. Leave it off for several minutes. When you turn on the TV/VCR again, the clock will be set.

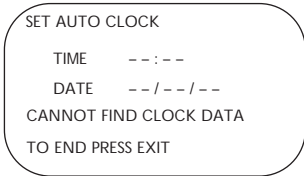

6

Wait for the TV/VCR to find the time.

5

7

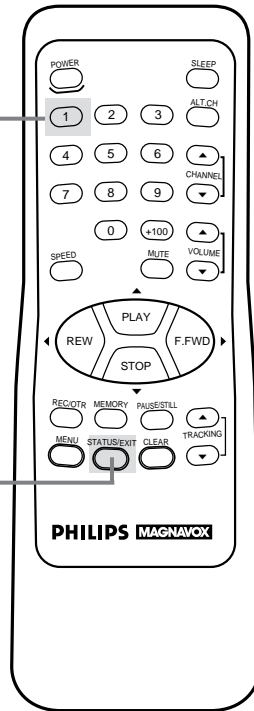

Helpful Hints

- To display the time, press the STATUS/EXIT button. A status display, which includes the time, will appear on the TV/VCR screen. Details are on page 26.
- You must turn off the TV/VCR for several minutes during automatic clock setting. If the clock is not set when you turn on the TV/VCR, repeat the steps for Automatic PBS Channel Selection. If the clock still is not set, set the clock manually.
- You cannot use the AUTO CLOCK feature if you don't receive a PBS channel that carries a time signal in your area. Set the clock manually.
- Cable Box users must set the clock manually.

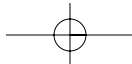

16 Setting the Clock (cont'd)

Manual PBS Channel Selection

1

Press the MENU button.

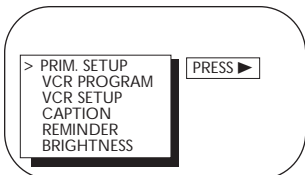

2

Press the PLAY/▲ button or the STOP/▼ button to select PRIM. SETUP. Then, press the F.FWD/▶ button.

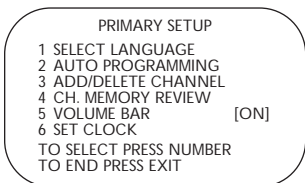

3

Press the Number 6 button to select SET CLOCK.

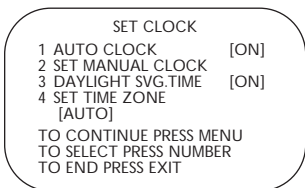

4

If ON appears beside AUTO CLOCK, press the MENU button. If OFF appears beside AUTO CLOCK, press the Number 1 button so that ON appears to the right of AUTO CLOCK, then press the MENU button.

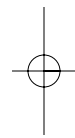
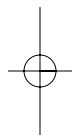
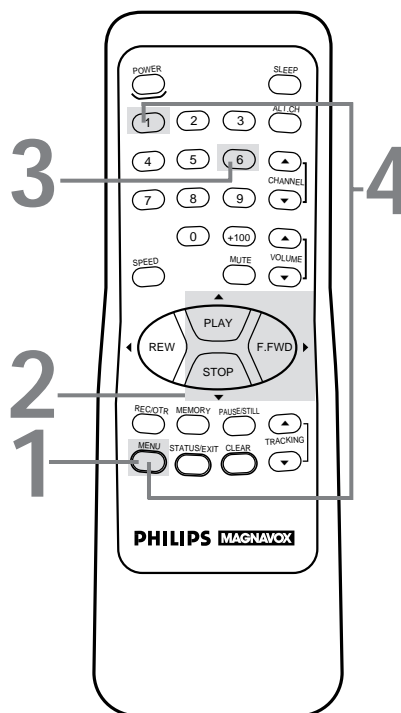
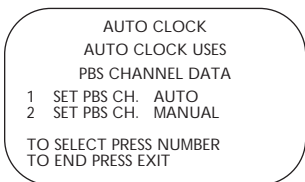

Setting the Clock (cont'd) 17

5

Press the Number 2 button to select SET PBS CH. MANUAL.

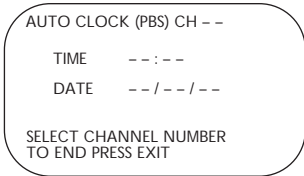

6

Use the Number buttons to enter your PBS station. If you make a mistake, press the CLEAR button, then enter the correct number.

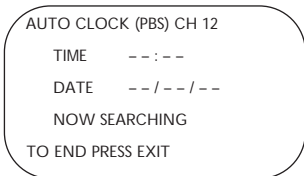

7

NOW SEARCHING flashes on the TV/VCR screen.

8

When the TV/VCR finds the clock data, the time will appear on-screen. Press the STATUS/EXIT button.

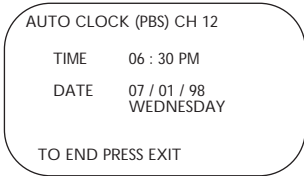

- If **CANNOT FIND CLOCK DATA** flashes on the TV/VCR screen and you know another PBS channel, press the Number 1 button to choose **SELECT NEW PBS CH.** Repeat step 6.
- If **CANNOT FIND CLOCK DATA** flashes on the TV/VCR screen and you do not know another channel, press the Number 2 button to select **SET PBS CH. AUTO.** The TV/VCR will search for the PBS channel automatically.
 - If the PBS channel is found, the time will appear on-screen. Press the STATUS/EXIT button.
 - If the PBS channel is not found, you will be prompted to turn off the TV/VCR. Leave it off for several minutes. When you turn on the TV/VCR again, the time will be set.

7

Wait for the TV/VCR to find the time.

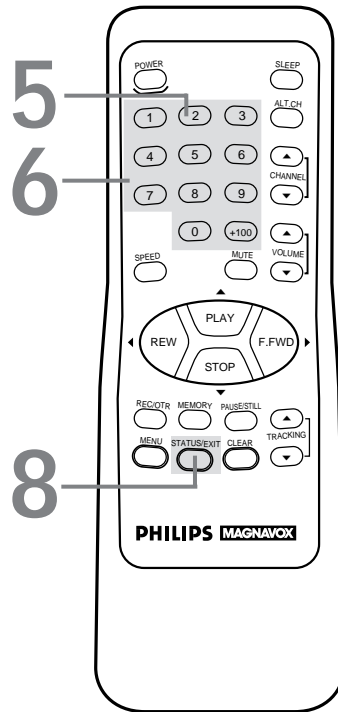

Helpful Hints

- If you have an Antenna hookup, you may select channels 2 - 69 at step 6. If you have a cable connection, you may select channels 1 - 125 at step 6. Details about available memorized channels are on page 11.
- To display the time, press the STATUS/EXIT button. A status display, which includes the time, will appear on the TV/VCR screen. Details are on page 26.

18 Daylight-Saving Time

When the Daylight-Saving Time feature is ON, the TV/VCR clock will automatically move forward one hour on the first Sunday in April and move back one hour on the last Sunday in October. To turn Daylight-Saving Time ON or OFF, follow the steps below.

1

Press the MENU button.

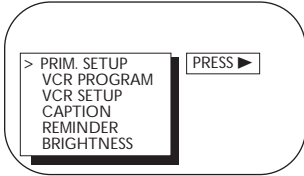

2

Press the PLAY/▲ button or the STOP/▼ button to select PRIM. SETUP. Then, press the F.FWD/► button.

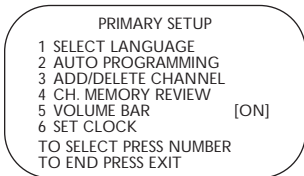

3

Press the Number 6 button to select SET CLOCK.

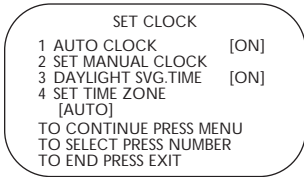

4

Press the Number 3 button so that ON or OFF appears beside DAYLIGHT SVG. TIME (Daylight-Saving Time).

5

Press the STATUS/EXIT button.

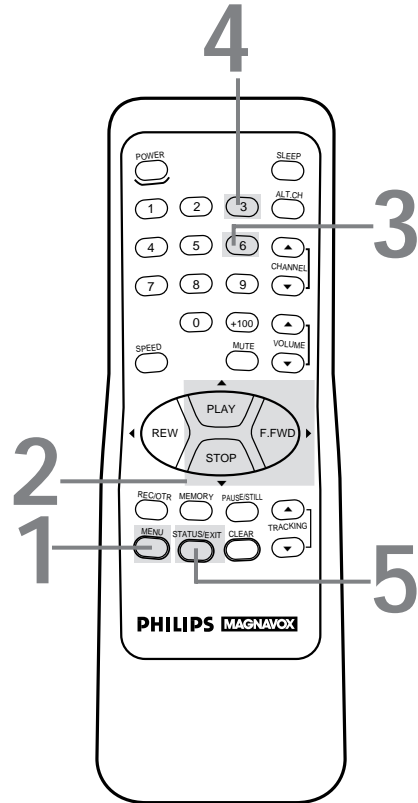

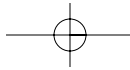

Time Zone 19

When you set the clock using AUTO CLOCK, specify a time zone so the TV/VCR will maintain the clock according to your time zone.

1

Press the MENU button.

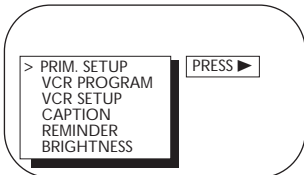

2

Press the PLAY/▲ button or the STOP/▼ button to select PRIM. SETUP. Then, press the F.FWD/▶ button.

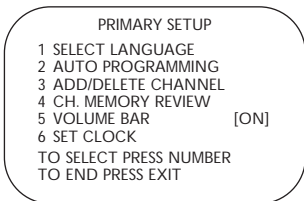

3

Press the Number 6 button to select SET CLOCK.

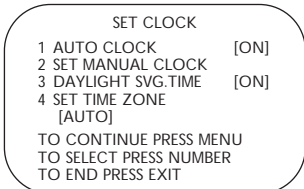

4

Press the Number 4 button to select SET TIME ZONE.

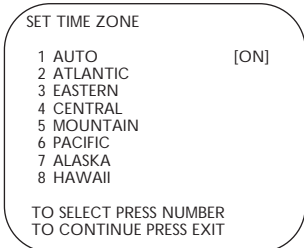

5

Press the Number button to select your time zone. ON will appear beside the selected time zone.

6

Press the STATUS/EXIT button twice.

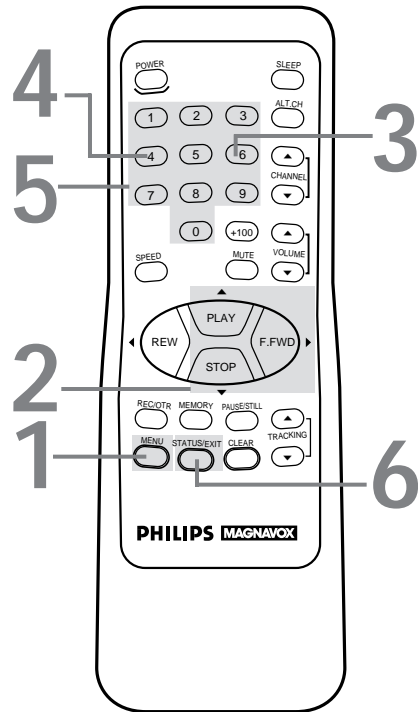

Helpful Hints

- If you select AUTO at step 5, the TV/VCR will set the clock according to the time zone data of the PBS station it finds.
- You cannot select SET TIME ZONE at step 4 if AUTO CLOCK is set to OFF.



20 Front Panel

Cassette Compartment

Insert a video cassette tape here.

STOP/EJECT Button

Press once to stop the tape. When playback is stopped, press to eject the tape. Press to select an item in the pop up menu.

POWER Button

Press to turn the power on or off.

Remote Sensor

Receives signal from your remote control so you can operate the TV/VCR from a distance.

VIDEO Jack

Connect this jack to the video out jack of a camcorder or a VCR. *Details are on page 31.*

AUDIO Jack

Connect this jack to the audio out jack of a camcorder or a VCR. *Details are on page 31.*

REC(ord) Light

Appears during a recording. It flashes when the TV/VCR power is turned off to set a timer recording or when a recording is paused.

REW(ind) Button

When tape playback is stopped, press to rewind the tape at high speed. During playback, press to rewind the tape while the picture stays on-screen. Press to change a setting of a pop up menu item (for example, to adjust the BRIGHTNESS setting).

PLAY Button

Press to play a tape. Also, press to release Search or Still mode and return to normal playback. *Details are on page 46.* Press to select an item in the pop up menu.

F.FWD Button

When tape playback is stopped, press to fast forward the tape at high speed. During playback, press to fast forward the tape while the picture stays on-screen. Press to change a setting of a pop up menu item (for example, to adjust the BRIGHTNESS setting).

REC(ord)/OTR Button

Press once to start a recording. *Details are on page 29.* Press repeatedly to start a One-Touch Recording (an immediate timed recording, 30 minutes to eight hours long) of the channel you are watching. *Details are on page 30.*

VOLUME ▲/▼ Buttons

Press to adjust the sound level. Press the CHANNEL ▲ button and the VOLUME ▼ button on the TV/VCR **at the same time** to display the pop up menu. Press again to remove the menu.

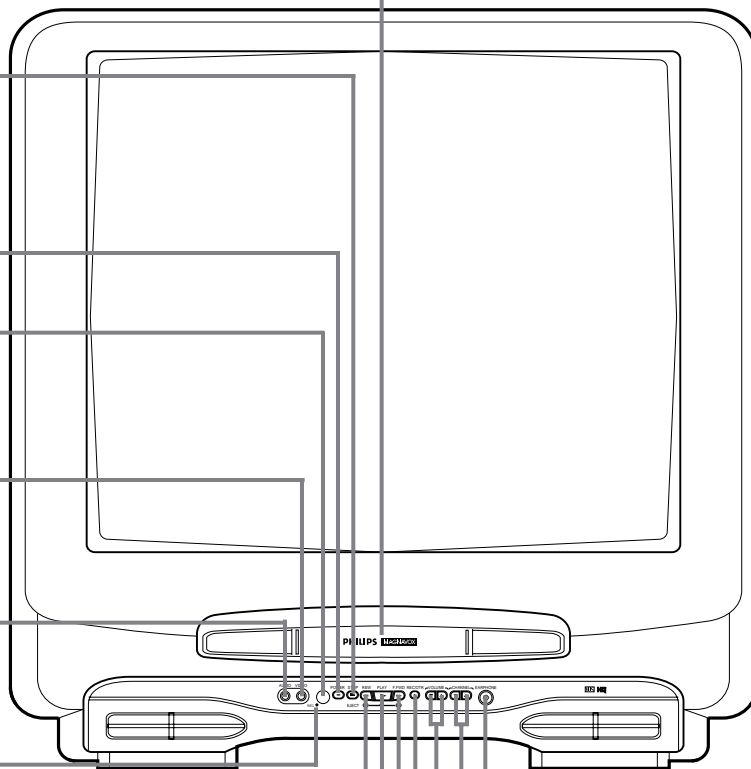

EARPHONE Jack

Connect headphones (not supplied) here for personal listening.

CHANNEL ▲/▼ Buttons

Press to scan through the TV/VCR channels. During tape playback, press to adjust the tracking. *Details are on page 45.*

Press the CHANNEL ▲ button and the VOLUME ▼ button on the TV/VCR **at the same time** to display the pop up menu. Press again to

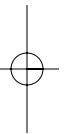
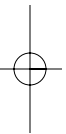

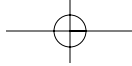

Rear Panel 21

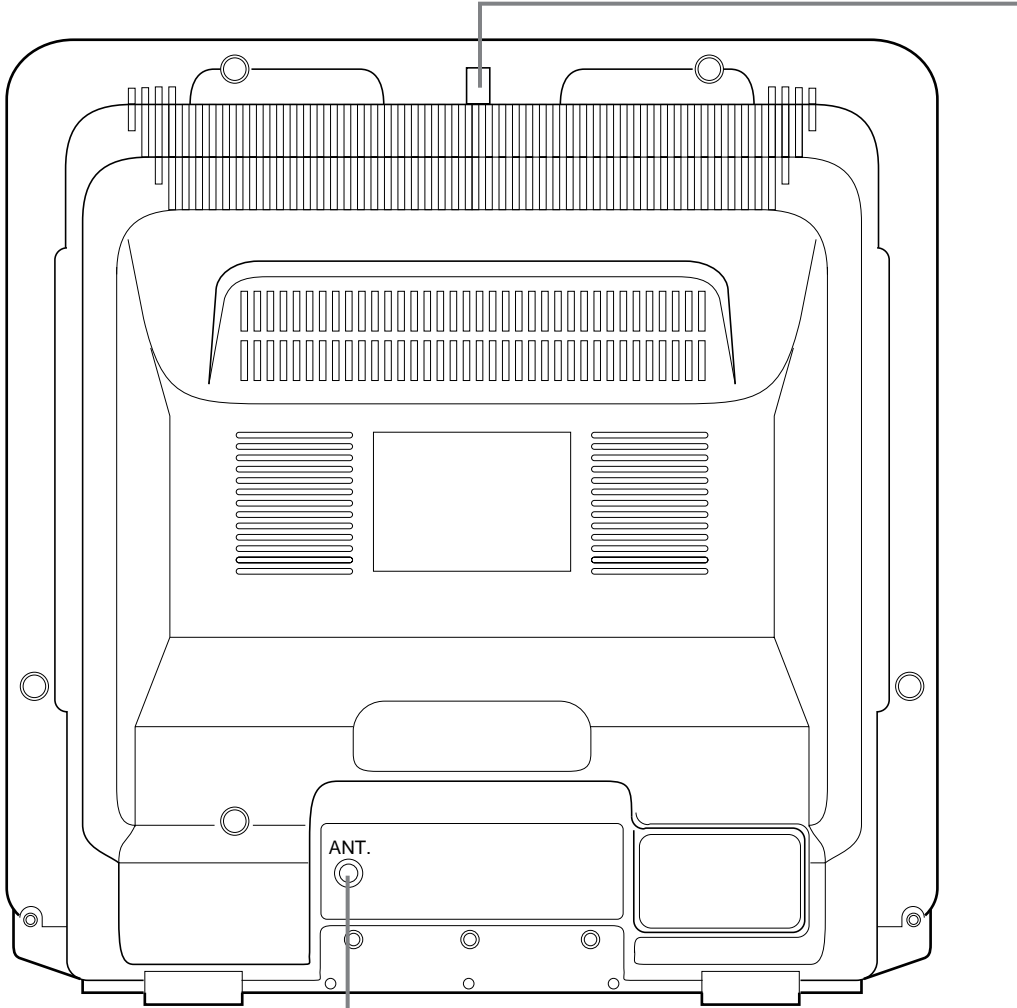

ANT(enna) Jack

Connect your antenna or cable here.
Details are on pages six - seven.

Antenna Hole

Connect the stem of an indoor rod antenna here. *Details are on page six.*

22 Remote Control Buttons

SLEEP Button

Press to set the sleep timer. *Details are on page 37.*

POWER Button

Press to turn on or off the TV/VCR.

Number Buttons

Use to select channels and to program TV/VCR functions (such as setting the clock).

● Channels 1 - 9

To select, press 0, then press the channel you want to select. For example, to select channel 7, press 0, 7.

● Channels 100 and above

To select, press the +100 button, then press the last two digits of the channel you want. For example, to select channel 117, press the +100 button, 1, 7.

SPEED Button

Press to select the recording speed (SP, LP, or SLP).

PLAY/▲ Button

Press to play a tape. *Details are on page 28.* Also, press to release Search or Still mode and return to normal playback. *Details are on page 46.* Press to select an item in the pop up menu.

REW(ind)/◀ Button

When tape playback is stopped, press to rewind the tape at high speed. During tape playback, press to rewind the tape while the picture stays on-screen. *Details are on page 46.*

Press to change a setting of a pop up menu item or to adjust the picture controls. *Details are on pages 24 - 25.*

REC(ord)/OTR Button

Press once to start a recording. *Details are on page 29.* Or, press repeatedly to start a One-Touch Recording (an immediate timed recording, 30 minutes to eight hours long) of the channel you are watching. *Details are on page 30.*

MENU Button

Press to display the pop up menu. You may also use the buttons on the front panel of the TV/VCR to access the pop up menu. *Details are on page 20.*

STATUS/EXIT Button

Press to see the status display. Press again to remove the status display. *Details are on page 26.*

Press to exit the on-screen menu.

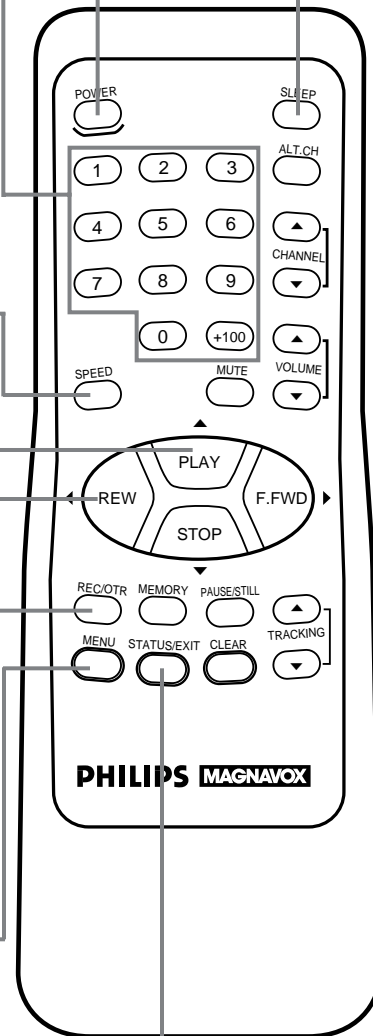

Remote Control Buttons (cont'd) 23

ALT. CH (Alternate Channel) Button

Press to return to the TV channel you were viewing immediately before switching to your current channel.

CHANNEL ▲/▼ Buttons

Press to scan through the TV/VCR's channels.

VOLUME ▲/▼ Buttons

Press to adjust the sound level. If you press the VOLUME ▲/▼ buttons when the sound is muted, the sound will be restored.

MUTE Button

Press to eliminate the TV/VCR's sound. Press again to return to the previous volume level.

F.FWD▶ Button

When tape playback is stopped, press to fast forward the tape at high speed. During tape playback, press to fast forward the tape while the picture stays on-screen. *Details are on page 46.*

Press to change the setting of an item in the on-screen menu or press to proceed to the next menu. Press to adjust the picture controls. *Details are on pages 24 - 25.*

STOP/▼ Button

Press to stop the tape. Press to select an item in the on-screen menu.

PAUSE/STILL Button

During recording, press to temporarily stop the recording. Press again to resume recording. *Details are on page 29.* You cannot pause a One-Touch Recording.

During tape playback, press to freeze the picture (still). Each time you press the PAUSE/STILL button, the noise lines will change position on-screen. *Details are on page 46.*

MEMORY Button

Press to memorize a tape position at which the real-time counter was set to 0:00:00. *Details are on page 44.* Or, press to memorize the start and end position on a tape when setting up A-B Repeat Play. *Details are on pages 42 - 43.*

CLEAR Button

Press to erase incorrect data when programming TV/VCR functions. Also, press to reset the real-time counter to 0:00:00. *Details are on page 44.*

TRACKING ▲/▼ Buttons

Press during tape playback to adjust the tracking. *Details are on page 45.*

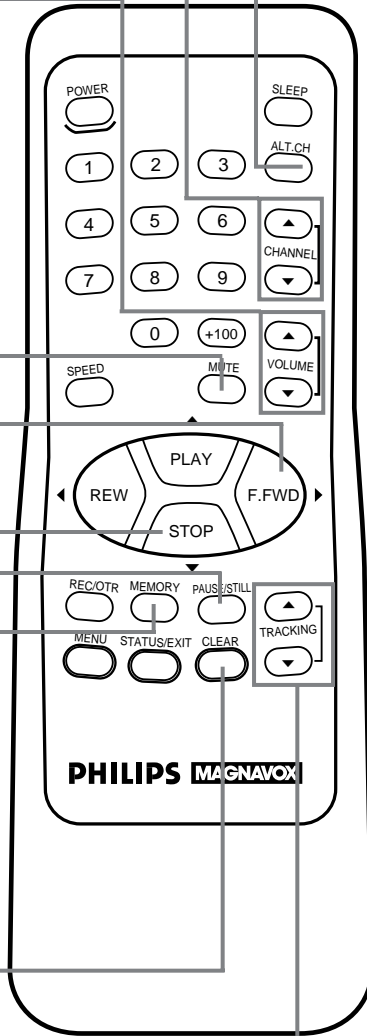

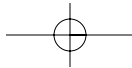

24 Adjusting the Picture Controls

Follow these steps to adjust the TV/VCR's brightness, picture, color, tint, and sharpness.

1

Press the MENU button.

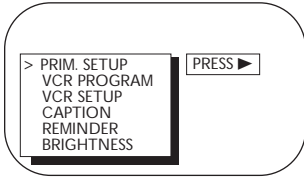

2

Press the PLAY/▲ button or the STOP/▼ button to select the desired control (BRIGHTNESS, for example).

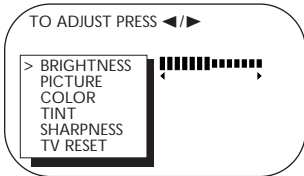

3

Press the REW(ind)/◀ button or the F.FWD/▶ button to adjust the picture control. (Refer to the chart on page 25.)

4

When you finish, press the STATUS/EXIT button.

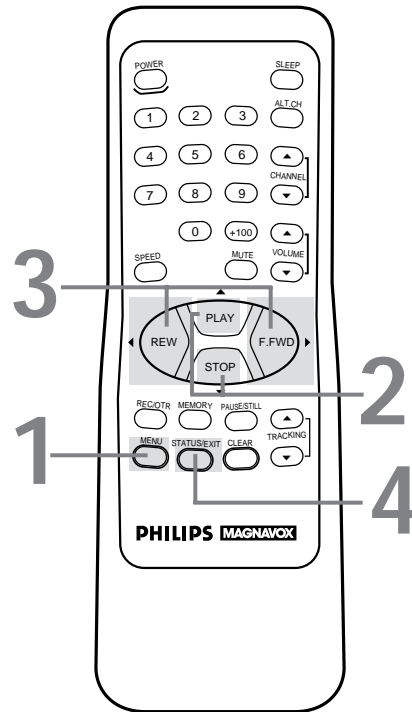

Helpful Hints

- The on-screen menus shown on page 25 will disappear if no adjustments are made within 60 seconds.
- The original settings will probably give you the best picture quality.
- To reset the picture controls to the original settings, press the MENU button, then press the PLAY/▲ button or the STOP/▼ button to select TV RESET, then press the F.FWD/▶ button. TV RESET COMPLETED will appear on-screen

Adjusting the Picture Controls (cont'd) 25

	Decrease	Increase
BRIGHTNESS	decreased brightness	increased brightness
PICTURE	decreased contrast	increased contrast
COLOR	paler	more brilliant
TINT	more purple	more green
SHARPNESS	softer	clearer

Press the REW(ind)/◀ button to decrease a picture control. Press the F.FWD▶ button to increase a picture control.

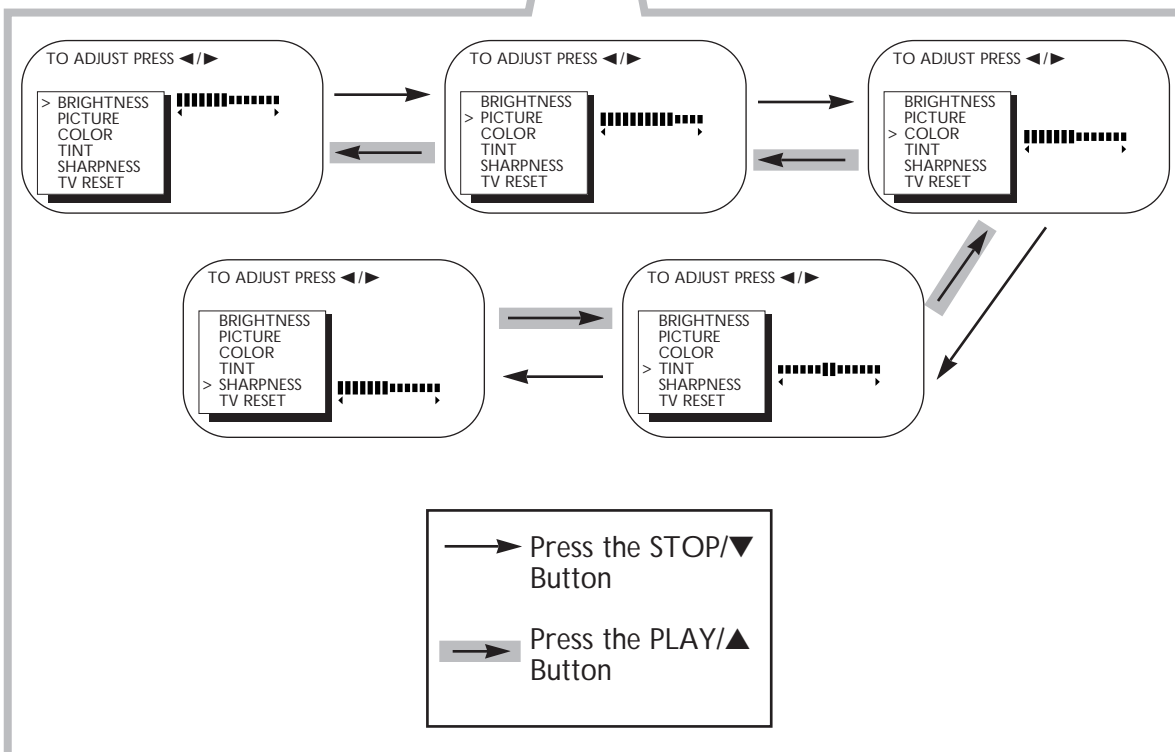
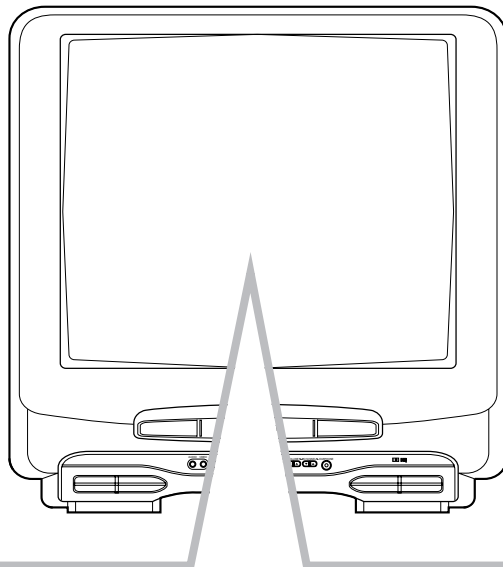



26 On-Screen Status Displays

A status display, which includes the current time, channel, and other information (see illustration of the status display at right), will appear when you press the STATUS/EXIT button or certain function buttons. You can bring up the status display at any time by pressing the STATUS/EXIT button. Remove the status display by pressing this button again. The contents of the status display may vary.

ON MODE:

- Whenever a function button (REW(ind)/◀, PLAY/▶, etc.) is pressed, the status display will appear for five seconds.

COUNTER ONLY MODE:

- When a function button (REW(ind)/◀, PLAY/▶, etc.) is pressed, the status display will appear for five seconds. After five seconds, only the counter will remain on-screen. To remove it, choose ON or OFF in the ON-SCREEN MODE menu. (There is an exception. When you press the STOP/▼ button, the status display will appear for five seconds, then disappear.)

OFF MODE:

- The status display will not appear when you press a function button. The channel number will appear briefly when you select a channel if channels are programmed.

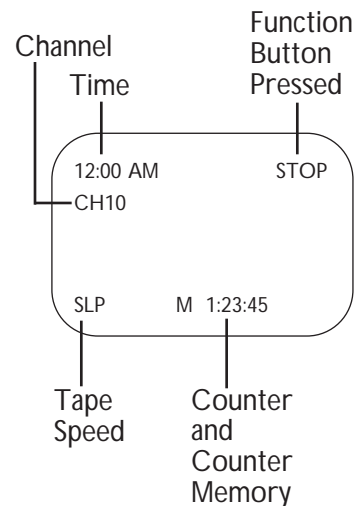

To choose an ON-SCREEN MODE, follow the steps below.

1

Press the MENU button.

2

Press the PLAY/▶ button or the STOP/▼ button to select VCR SETUP. Then, press the F.FWD/► button.

3

Press the Number 3 button to select ON-SCREEN MODE.

4

Press the Number 1 button to select ON, the Number 2 button to select COUNTER ONLY, or the Number 3 button to select OFF. Your selection will appear on-screen.

5

Press the STATUS/EXIT button.

Helpful Hints

- If the channel you select has no broadcast, the screen will be solid blue.
- You cannot view closed captions during recording or tape playback if COUNTER ONLY is selected at step 4. Details are on pages 38 - 39.

Reminder 27

The channel number will remain on-screen at all times when you set REMINDER to ON in the pop up menu. The exception is during tape playback, Forward and Reverse Searching, Still mode, and when closed captioning is selected (CAPTION in the pop up menu).

Set REMINDER to ON or OFF by following the steps below.

1

Press the MENU button.

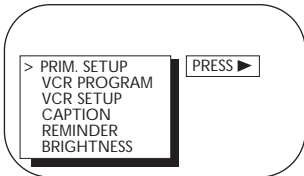

2

Press the PLAY/▲ button or the STOP/▼ button to select REMINDER.

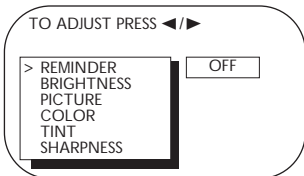

3

Press the REW(◀) button or the F.FWD(▶) button to select ON or OFF. Each press of the REW(◀) button or the F.FWD(▶) button turns REMINDER ON or OFF.

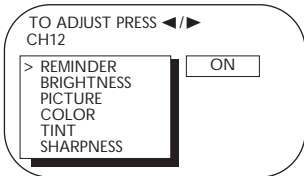

4

Press the STATUS/EXIT button.

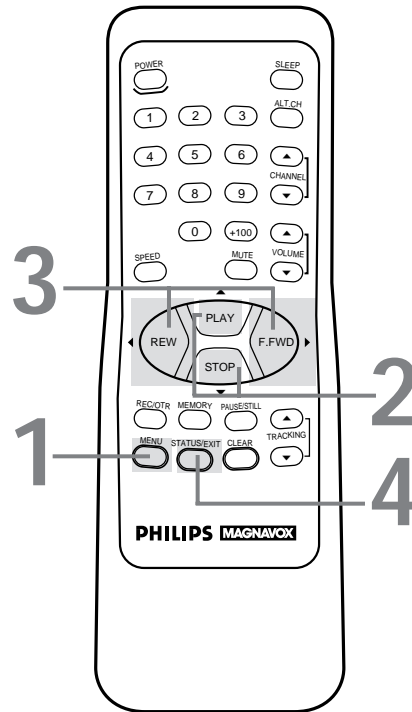

28 Playing

Follow the steps below to play a tape.

1

Insert a tape in the TV/VCR. The power will come on. If the tape's record tab has been removed, playback should start automatically.

2

If playback does not start automatically, press the PLAY/▲ button to start playback.

3

Press the STOP/▼ button on the remote control or the STOP/EJECT button on the TV/VCR once to stop playback.

4

Press the REW(ind)/◀ button to rewind the tape.

5

When the tape has finished rewinding, press the STOP/EJECT button on the TV/VCR to remove the tape.

1 Insert a tape in the TV/VCR.

5 Press the STOP/EJECT button on the TV/VCR.

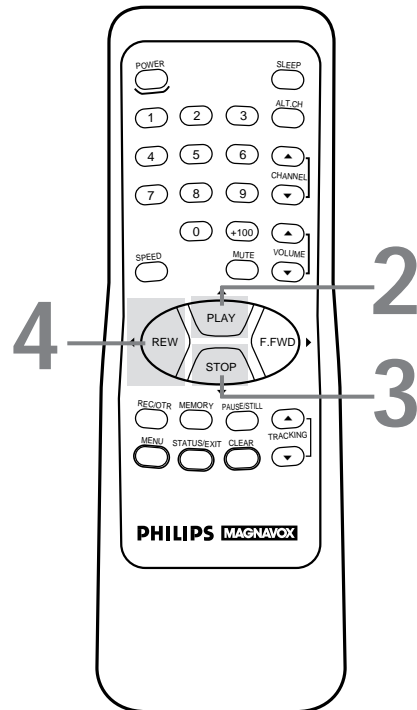

Helpful Hints

- If the tape you want to play is already in the TV/VCR, turn on the TV/VCR power, then press the PLAY/▲ button.
- Playback features and options are on pages 41 - 46.

Recording 29

Read and follow the steps below to record a TV program.

1

Place a tape with its record tab intact (see page five) in the TV/VCR. The power will come on. Or, if the tape is already in the TV/VCR, press the **POWER** button to turn on the TV/VCR.

2

Press the **SPEED** button until the desired tape speed appears on the TV/VCR screen. Details about tape speed are given below.

3

Use the **CHANNEL** ▲/▼ buttons or the **Number** buttons to select the channel to be recorded. (Channels cannot be changed during recording.)

4

Press the **REC(ord)/OTR** button once to start recording. The REC(ord) light will glow.

- If there is not a tape in the TV/VCR, NO CASSETTE flashes on-screen briefly.
- If the tape does not have a record tab, PROTECTED CASSETTE CANNOT RECORD flashes on-screen briefly. The TV/VCR will eject the tape. Insert another tape.

5

To pause the recording (for example, during commercials), press the **PAUSE/STILL** button. The REC(ord) light will flash. To resume recording, press the **PAUSE/STILL** button again or the **REC(ord)/OTR** button. The REC(ord) light will glow.

6

To stop recording, press the **STOP/▼** button.

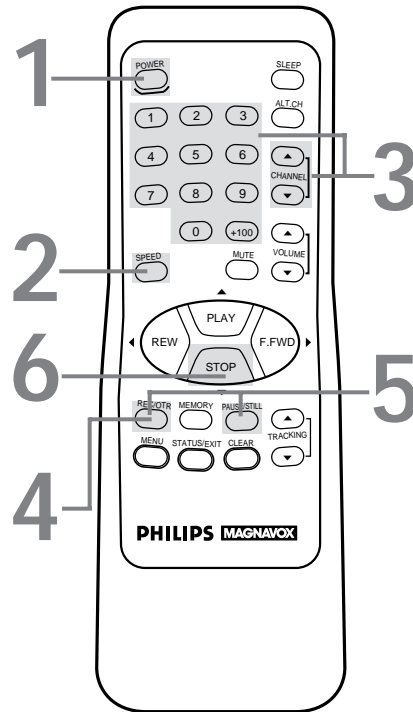

Tape Speeds
This chart shows the recording/playback time for three types of video cassettes (T160, T120, and T60). There are three playback speeds: SP, LP, and SLP. During playback, the TV/VCR selects the tape speed automatically. When recording, you can change the tape speed using the SPEED button (see page 22).

Tape Speed	Maximum Record/Playback Time			
	Type	T160	T120	T60
SP (Standard Play)		2 hrs. 40 mins.	2 hrs.	1 hr.
LP (Long Play)		5 hrs. 20 mins.	4 hrs.	2 hrs.
SLP (Super Long Play)		8 hrs.	6 hrs.	3 hrs.

Helpful Hints

- You cannot record one channel while watching another.
- Recording options are on pages 30 - 36.
- You cannot record if RECORD DEFEAT is set to ON. (REC DEFEATED will flash on-screen.) Details are on page 36.
- If you pause a recording for more than five minutes, the TV/VCR will switch to Stop mode automatically to protect the video cassette tape from damage.
- You can change the tape speed with the SPEED button while a recording is in progress, but some distortion may appear on the tape.

30 One-Touch Recording

The One-Touch Recording (OTR) function allows you to program an immediate timed recording from 30 minutes to eight hours long without setting the timer.

Before you begin, make sure:

- Channels are set up.
- There is a tape in the TV/VCR. The record tab must be intact.

1

Use the CHANNEL ▲/▼ buttons or the Number buttons to select the channel you want to record.

2

Press the SPEED button until the desired recording speed (SP, LP, or SLP) appears on-screen. Details are on page 29.

3

Press the REC(ord)/OTR button repeatedly until the desired recording length appears in the upper right corner of the screen. Recording will begin immediately. The REC(ord) light will appear.

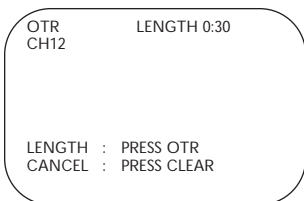

4

To stop an OTR before recording is finished, press the STOP/EJECT button on the TV/VCR.

Or, press the REC(ord)/OTR button, then press the CLEAR button, then press the STOP/▼ button on the remote control.

4

Press the STOP/EJECT button on the TV/VCR to stop the OTR.

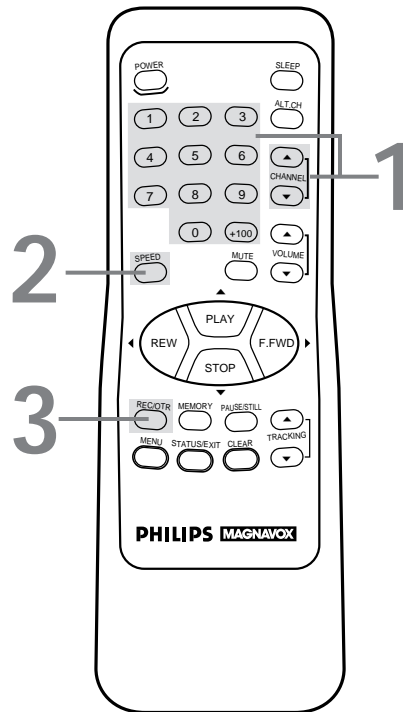

Helpful Hints

- To check the time remaining for an OTR after the OTR has been set, press the STATUS/EXIT button.
- To change the recording length while an OTR is in progress, press the REC(ord)/OTR button until the desired recording length appears on-screen.
- You can not pause an OTR.
- To cancel an OTR but continue recording, press the REC(ord)/OTR button, then press the CLEAR button.
- You cannot record if RECORD DEFEAT is set to ON. Details are on page 36.
- You can change the tape speed with the SPEED button while a recording is in progress, but some distortion may appear on the tape.
- If the end of the tape is reached during an OTR, recording will stop. The TV/VCR will eject the tape and shut itself off. The REC(ord) light may flash.

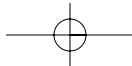

Rerecording (Tape Duplication) 31

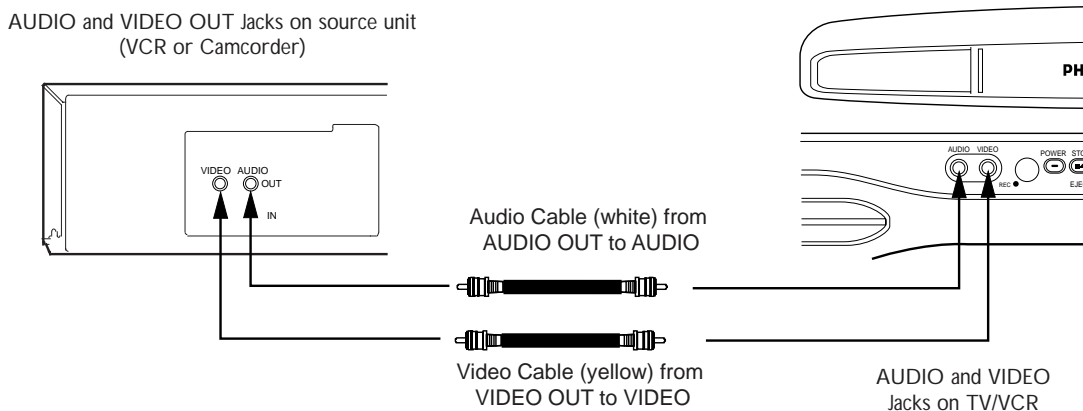

1

Make the connections shown above, using audio and video cables. (Make sure the source unit is connected to a power source.)

2

The source unit (VCR or camcorder) will play your tape. **Insert a prerecorded tape in the source unit.** If playback begins, press the STOP button on the unit.

3

The TV/VCR will record your tape. **Insert a blank tape in the TV/VCR.** Make sure the tape's record tab is intact. The TV/VCR power will turn on automatically.

4

Point the TV/VCR remote control at the TV/VCR. Press Number buttons 0, 0 so that A/V IN appears on-screen.

5

Point the TV/VCR remote control at the TV/VCR. Press the SPEED button until the desired tape speed (SP, LP, or SLP) appears on-screen.

6

Press the PLAY button on the source unit and the REC(ord)/OTR button on your TV/VCR at the same time. Copying will begin.

7

To stop copying, press the STOP/EJECT button on the TV/VCR, then stop the tape on the source unit (VCR or camcorder).

Helpful Hints

- To exit line input mode (A/V IN), press the Number buttons or the CHANNEL ▲/▼ buttons to select a channel other than 00.
- Unauthorized recording of copyrighted television programs, video tapes, or other materials may infringe on the rights of copyright owners and violate copyright laws.
- Different brands of equipment may operate differently.
- Make sure all connections are secure. Otherwise, you may not record both picture and sound.
- Audio and video cables are not included.

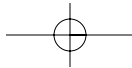

32 Timer Recording

Follow the steps below to program the TV/VCR to record TV programs while you're away from home. The TV/VCR will turn itself on, record, and turn itself off automatically. Before you begin, make sure:

- The clock is set. If not, CLOCK MUST BE SET appears.
- Channels are set up.
- There is a tape in the TV/VCR. (Make sure the tape's record tab is intact and the tape is long enough to record the program.)

Complete each step within 60 seconds of completing the previous step. If you don't, you may start again at step 1.

1

Press the MENU button.

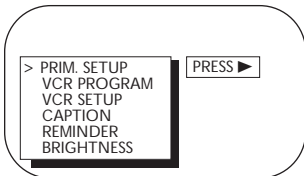

2

Press the PLAY/▲ button or the STOP/▼ button to select VCR PROGRAM, then press the F.FWD/▶ button.

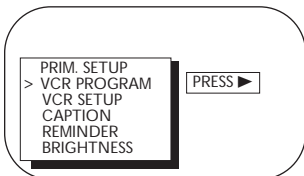

3

Select a once, daily or weekly recording.

- Press the Number 1 button to select ONCE. The TV/VCR will record a TV program on any day you choose, up to 12 months away.
- Press the Number 2 button to select DAILY. The TV/VCR will record from Monday through Friday – starting at the same time and recording the same channel for the same length of time every day.
- Press the Number 3 button to select WEEKLY. The TV/VCR will record the same channel on the same day, at the same time, and for the same length of time every week.

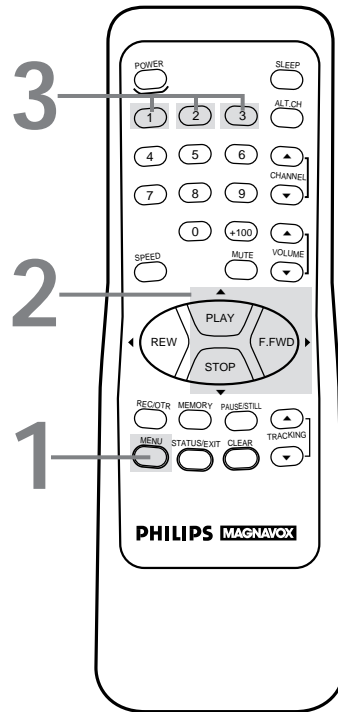
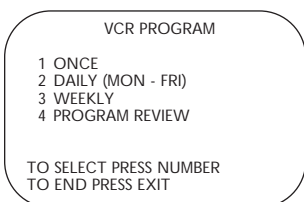

Helpful Hints

- If the power fails, programmed timer recordings will be restored when the clock is reset. (The clock will reset itself automatically if you are using the AUTO CLOCK feature. Details are on pages 14 - 17. If you are not using the AUTO CLOCK feature, reset the clock manually. Details are on pages 12 - 13.) The timer recording will not occur only if the timer recording was scheduled to take place during the power failure.
- You cannot set a timer recording if RECORD DEFEAT is set to ON. Details are on page 36.

Timer Recording (cont'd) 33

4

Use the Number buttons (1 - 8) to select a position in which to store the timer recording. Flashing numbers indicate an open position (one in which a timer recording has not yet been stored).

NOTE: If you select a number that has already been used to store a timer recording, PREVIOUSLY SET PROGRAM will appear on-screen for a few seconds. Then information about the program in that position will appear on-screen. If this happens, press the STATUS/EXIT button. Then use the Number buttons to select another position.

5

- If you are using an antenna or cable connection, enter the channel of the TV program you want to record (you must enter a 0 before all single-digit channels).
- If you are recording from line input, press 0, 0. A/V IN will appear on-screen.
- If you are recording using a Cable Box, enter the Cable Box output channel (03 or 04). Be sure to select the channel of the TV program at the Cable Box and leave the Cable Box on for the timer recording.

ONE TIME PROGRAM

PROGRAM 1
CHANNEL --

TO CORRECT PRESS CLEAR
TO END PRESS EXIT

6

Press two Number buttons for the hour(s) you want the recording to begin. Press two Number buttons for the minute(s) you want the recording to begin. Press 1 for AM or 2 for PM. For example, for 9:30 PM, press 09, 30, 2.

ONE TIME PROGRAM

PROGRAM 1
CHANNEL 10
TIME ON --:--

TO CORRECT PRESS CLEAR
TO END PRESS EXIT

7

Follow the instructions in step 6 to set the recording's stop time. (AM or PM will be set automatically.)

ONE TIME PROGRAM

PROGRAM 1
CHANNEL 10
TIME ON 09:30 PM
TIME OFF --:--

TO CORRECT PRESS CLEAR
TO END PRESS EXIT

Instructions continue on page 34.

4-7

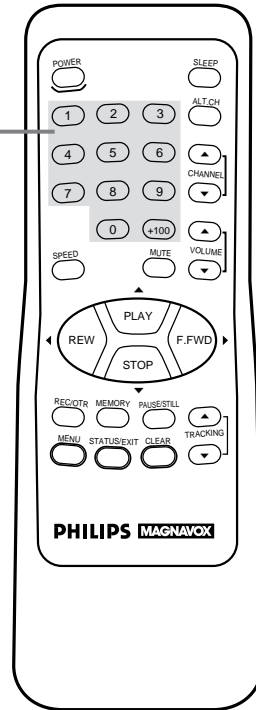

Helpful Hints

- If the numbers entered do not match the TV/VCR's calendar, the entry will be rejected and a question mark will appear on screen.
- To make corrections while you are programming a timer recording, press the CLEAR button until the cursor is flashing on the item you want to change. Then enter the correct information.

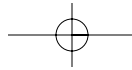

34 Timer Recording (cont'd)

8

Press the Number 1 button to record in SP speed, press the Number 2 button to record in LP speed, or press the Number 3 button to record in SLP speed. *Details about tape speed are on page 29.* You cannot use the (Tape) SPEED button at this time.

ONE TIME PROGRAM

PROGRAM 1
CHANNEL 10
TIME ON 09:30 PM
TIME OFF 11:00 PM
REC SPEED SLP
SP=1 LP=2 SLP=3

TO CORRECT PRESS CLEAR
TO END PRESS EXIT

9

Press two Number buttons for the month and two Number buttons for the day you want the program to record. For example, for July 10, 1998, press 07, 10. The day of the week and the year will be displayed automatically (you cannot program the TV/VCR to record more than one year in advance).

ONE TIME PROGRAM

PROGRAM 1
CHANNEL 10
TIME ON 09:30 PM
TIME OFF 11:00 PM
REC SPEED SLP
START DATE 07/10/98
FRIDAY

TO CORRECT PRESS CLEAR
TO END PRESS EXIT

10

Press the **STATUS/EXIT** button. PROGRAM WAS COMPLETED PLEASE TURN OFF FOR TIMER RECORDING will appear on-screen.

- If there is not a tape in the TV/VCR, PLEASE INSERT CASSETTE also appears on-screen.
- If there is a tape without a record tab in the TV/VCR, PLEASE REMOVE CASSETTE also appears on-screen. If this happens, insert a different tape.
- If PROGRAM NOT COMPLETED appears, start again at step 1.

11

Turn off the TV/VCR power. If you forget to turn off the TV/VCR, PLEASE TURN OFF FOR TIMER RECORDING appears on the TV/VCR screen two minutes before a timer recording starts.

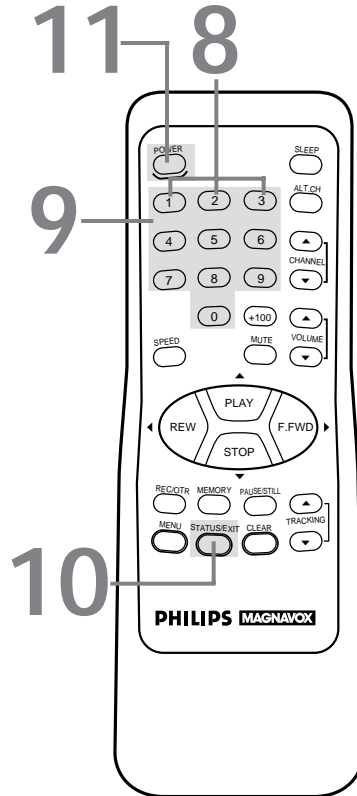

The TV/VCR must be off for a timer recording! Make sure there is a tape in the TV/VCR.

Helpful Hints

- The REC (ord) light may flash when you turn off the TV/VCR at step 11 if a tape is not in the TV/VCR.
- PROGRAM NOT COMPLETED / CLASH may appear on-screen when you finish setting a timer recording. This means that the timer recording you just programmed and another timer recording overlap, and thus the current timer recording will not be carried out.
- To stop a started timer recording, press the STOP/EJECT button on the TV/VCR.

Please see page 48 for more Helpful Hints.

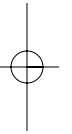
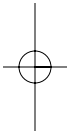

Timer Recording (cont'd) 35

Checking or Clearing Timer Recordings

1

With the TV/VCR on, press the MENU button.

2

Press the PLAY/▲ button or the STOP/▼ button to select VCR PROGRAM, then press the F.FWD/▶ button.

3

Press the Number 4 button to select PROGRAM REVIEW. The timer recording information for the program in the lowest numbered position will appear on-screen. If no timer recordings are programmed, nothing will happen when you press the Number 4 button.

4

Press the Number 1 button to display information about the next programmed timer recording. (If you do not press a button within 10 seconds, information about the next programmed timer recording will appear.) This will continue until all positions have been displayed. Then, the menu will disappear. You can exit the Program Review at any time by pressing the STATUS/EXIT button.

5

To cancel the timer recording displayed, press the CLEAR button. Either the display will disappear or information about other timer recordings will appear. If you do not press any other buttons, the display will disappear after all timer recordings have been displayed.

6

Repeat steps 1 - 4 to make sure you have cleared the correct position.

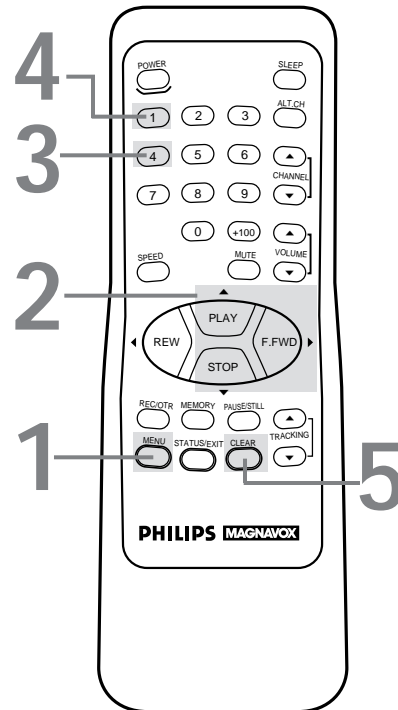



36 Record Defeat

Follow the steps below to prevent accidental recording.

1

Press the MENU button.

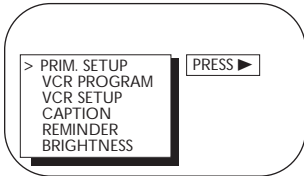

2

Press the PLAY/▲ button or the STOP/▼ button to select VCR SETUP, then press the F.FWD/▶ button.

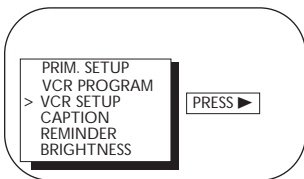

3

Press the Number 4 button so that ON appears beside RECORD DEFEAT.

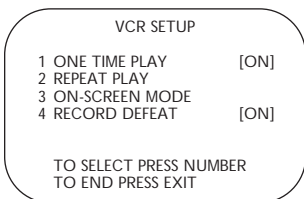

4

Press the STATUS/EXIT button.

5

Now, REC DEFEATED will flash on-screen when you press the REC(ord)/OTR button.

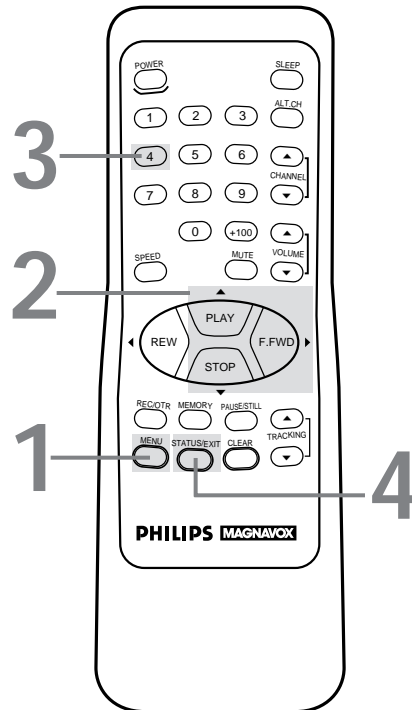
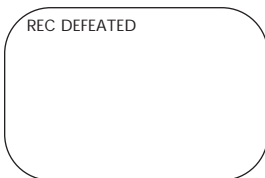

Helpful Hints

- If you set RECORD DEFEAT to ON after a timer recording has been set, the timer recording will not occur.
- You can not program a timer recording if RECORD DEFEAT is set to ON.
- To take the TV/VCR out of Record Defeat mode, repeat steps 1 - 2 above. At step 3, press the Number 4 button so that OFF appears beside RECORD DEFEAT on-screen. Press the STATUS/EXIT button.

Setting the Sleep Timer 37

Use the sleep timer to program the TV/VCR to shut off in a certain amount of time.

1

Press the **SLEEP** button. The sleep timer display will appear on-screen. (You can not set the sleep timer during a recording.)

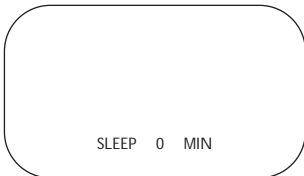

2

Within five seconds, press the **SLEEP** button repeatedly to select **30 minutes, 60 minutes, 90 minutes, or 120 minutes**. In a few seconds, the display will disappear. Then the TV/VCR will shut itself off after the specified amount of time. One minute before the TV/VCR shuts itself off, the seconds will count down on-screen.

GOOD NIGHT appears on the TV/VCR screen 10 seconds before the TV/VCR shuts itself off.

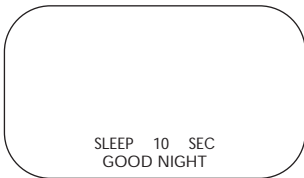

- To see how much time remains until the TV/VCR shuts itself off, press the **SLEEP** button once. The time remaining will appear on-screen briefly. You cannot do this during a recording.
- To cancel a sleep timer setting, press the **SLEEP** button until **0 MIN** appears on-screen. The on-screen display will disappear in a few seconds. You cannot cancel the sleep timer during a recording.

1-2

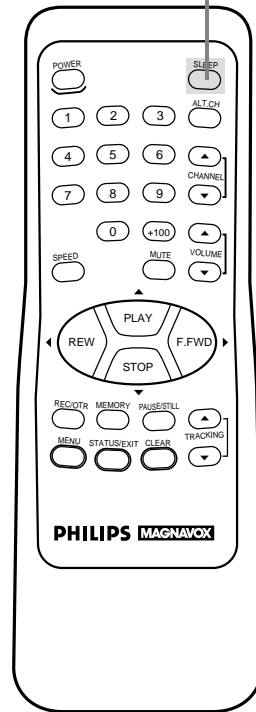

Helpful Hints

- Finish all recordings before the TV/VCR shuts itself off. If a recording is in progress, the sleep timer will be cancelled.
- A timer recording will not begin unless the TV/VCR power is off. Two minutes before a timer recording starts, **PLEASE TURN OFF FOR TIMER RECORDING** flashes on-screen. If you see this message, turn off the TV/VCR.
- If the power fails, you might lose the sleep timer setting.

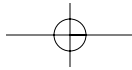

38 Closed Caption

When you watch a program that is being broadcast with closed captions, you can access on-screen boxes containing the program's dialogue (for example, what a character is saying), dialogue in a foreign language, or information (such as a channel guide, schedule, or announcements). Follow the steps below to select closed captions.

Not all TV programs and commercials are broadcast with closed captions. Similarly, all types of closed captions (second language, half-screen text, etc.) are not always broadcast. If closed captioning is not broadcast, you cannot receive it. This does not indicate a problem with the TV/VCR. Refer to your area's TV program listings for the shows offered with closed captions.

1

Press the MENU button.

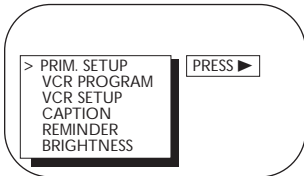

2

Press the PLAY/▲ button or the STOP/▼ button to select CAPTION.

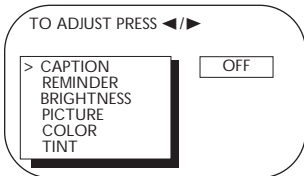

3

Press the REW(ind)/◀ button or the F.FWD/▶ button to select your desired mode.

The selected closed caption mode will appear beside CAPTION on-screen.

- CAPTION1 displays standard closed captions (what a character is saying).
- CAPTION2 displays foreign language closed captions (foreign language words showing what a character is saying).
- TEXT1 and TEXT2 display half-screen text (such as a channel guide, schedule, or announcement).
- OFF turns closed captions off. Captions will not appear on-screen.

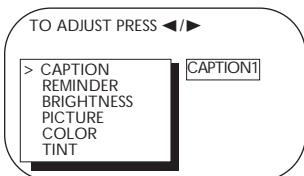

Example:
CAPTION1
 Menu
 Screen

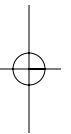
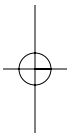
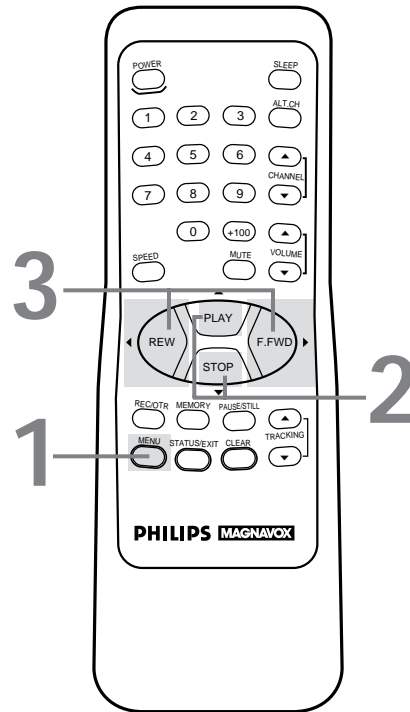

Closed Caption (cont'd) 39

4

Press the **STATUS/EXIT** button. The type of closed captions you selected at step 3 will appear on-screen.

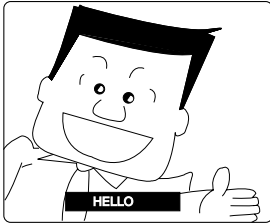

Standard Closed Captions

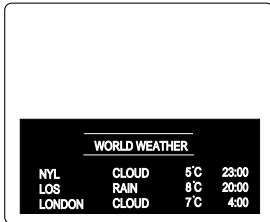

Half-screen text

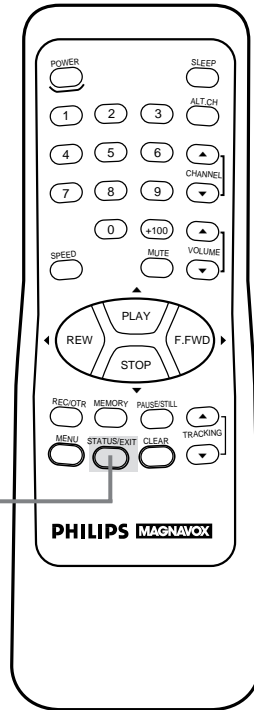

Helpful Hints

- You cannot view closed captions during recording or tape playback if COUNTER ONLY is set.
- Abbreviations, symbols, and other grammatical shortcuts are often used in order to keep pace with the on-screen action. This does not indicate a problem with the TV/VCR.
- To cancel closed captions, follow steps 1 - 2 on page 38. At step 3, press the REW(ind)/◀ button or the F.FWD/▶ button to select OFF. Press the STATUS/EXIT button.
- When you change channels, the closed captions may be delayed for a few seconds.
- When you adjust the volume or mute the volume, closed captions may be delayed for a few seconds.

40 Volume Bar

Usually, the volume bar appears when you press the VOLUME ▲/▼ buttons. If you do not need it, set the VOLUME BAR to OFF position. For example, when you watch a program that is being broadcast with closed captions, you may choose to set the VOLUME BAR to OFF so the captions can remain on-screen. The captions will remain on-screen even when you press the VOLUME ▲/▼ buttons or the MUTE button.

1

Press the MENU button.

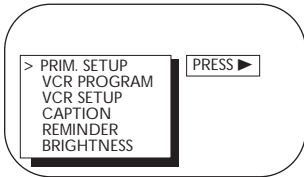

2

Press the PLAY/▲ button or the STOP/▼ button to select PRIM. SETUP. Then, press the F.FWD/► button.

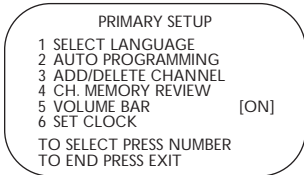

3

Press the Number 5 button so that OFF appears to the right of VOLUME BAR. Each press of the Number 5 button will turn the VOLUME BAR ON or OFF.

4

Press the STATUS/EXIT button.

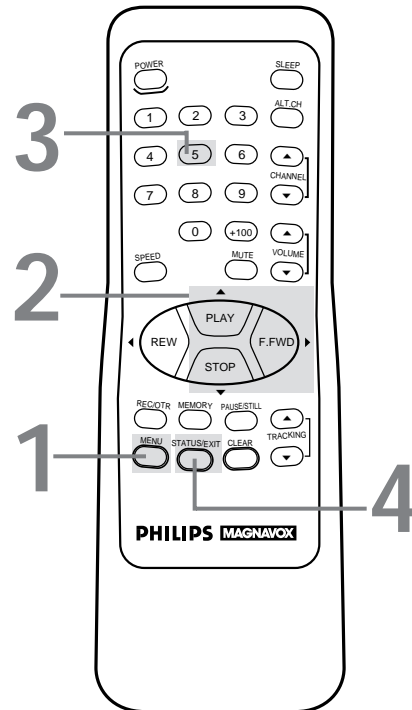

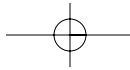

Repeat Play 41

Follow the steps below to program the TV/VCR to play a tape over and over.

1

Press the MENU button.

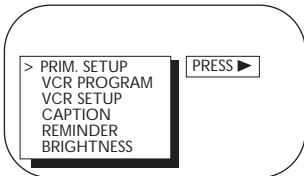

2

Press the PLAY/▲ button or the STOP/▼ button to select VCR SETUP, then press the F.FWD/▶ button.

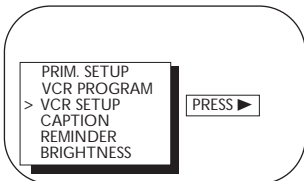

3

Press the Number 2 button so that ON appears beside REPEAT PLAY.

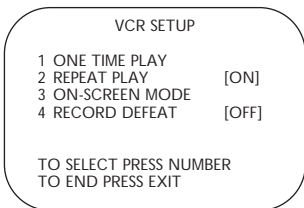

4

Press the STATUS/EXIT button. Now, when a tape has finished playing, the TV/VCR will rewind it and start playback again. (TV programming will appear while the tape is rewinding.)

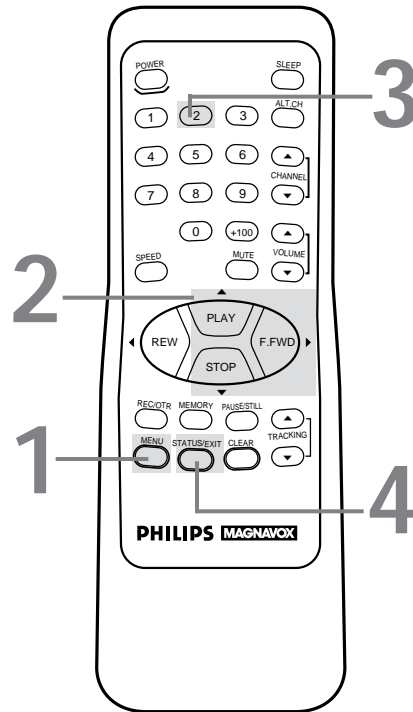

Helpful Hints

- The TV/VCR will stay in Repeat Play mode until you set ONE TIME PLAY to ON, even if the TV/VCR is turned off. To set ONE TIME PLAY to ON, follow steps 1 - 2 above. Then, press the Number 1 button so that ON appears beside ONE TIME PLAY. Press the STATUS/EXIT button.
- The real-time counter memory will not function during Repeat Play

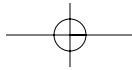

42 A - B Repeat Play

Follow the steps below to program the TV/VCR to play the material between two specified points (A and B) on a tape over and over again.

1

Insert a tape in the TV/VCR.

2

Press the MENU button.

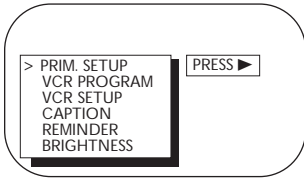

3

Press the PLAY/▲ button or the STOP/▼ button to select VCR SETUP, then press the F.FWD/► button.

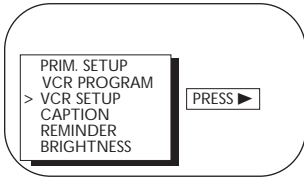

4

Press the Number 2 button repeatedly so that A-B appears beside REPEAT PLAY.

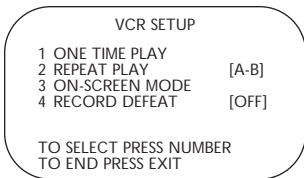

1 Insert a tape in the TV/VCR.

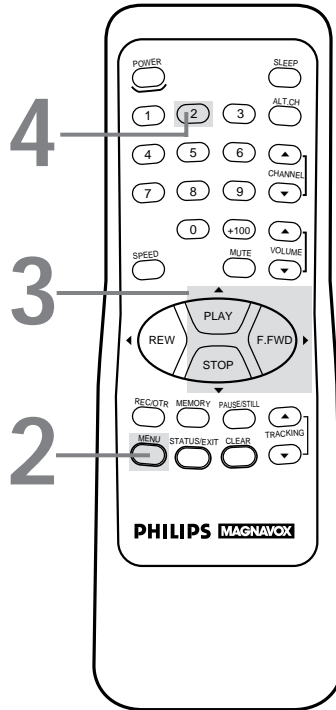

Helpful Hints

- To cancel A-B Repeat Play, set ONE TIME PLAY to ON. To set ONE TIME PLAY to ON, follow steps 1 - 3 above. Then, press the Number 1 button so that ON appears beside ONE TIME PLAY. Press the STATUS/EXIT button.
- The end position (B) must be later on the tape than the start position (A).

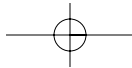

A - B Repeat Play (cont'd) 43

5

Press the **STATUS/EXIT** button to remove the display. A-B REPEAT will appear on-screen. Beneath it, the letter A will flash beside the real-time counter.

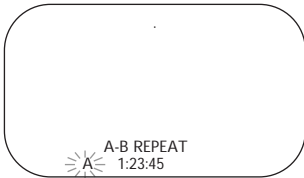

6

Play, fast forward, or rewind the tape to the position at which you want to begin playback. Stop the tape, then press the **MEMORY** button to set the start position (A). The flashing A will become a flashing B.

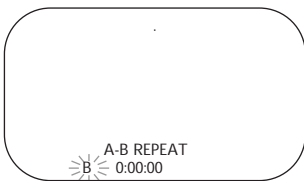

7

Play or fast forward the tape to the position at which you want playback to end. Stop the tape, then press the **MEMORY** button to set the end position (B).

- The length of time between the start position (A) and the end position (B) must be at least three minutes.

8

The TV/VCR will immediately rewind the tape to the start position (A) and repeat playback to the end position (B) over and over.

(TV programming will appear while the tape is rewinding.)

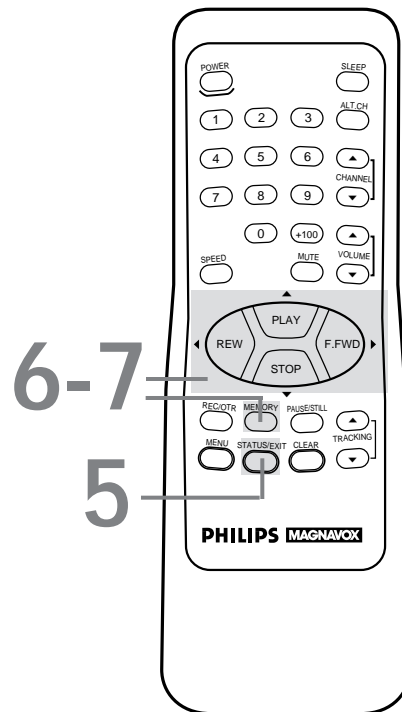

Helpful Hints

- The counter cannot be memorized or reset when you are using this feature.
- Positions A and B will be erased when a tape is ejected or when you press the REC(ord)/OTR button.
- A-B REPEAT will not appear on-screen at step 5 if a tape is not in the TV/VCR. NO CASSETTE will flash on-screen briefly.
- You cannot rewind or fast forward beyond points A or B when you are using this feature.

44 Real-Time Counter Memory

Follow the steps below to reset the real-time counter to zero at a tape location you want to refer to later.

1

Play, fast forward, or rewind a tape to the location that you would like to refer to later. Stop the tape.

2

Press the **STATUS/EXIT** button. The real-time counter will appear on-screen.

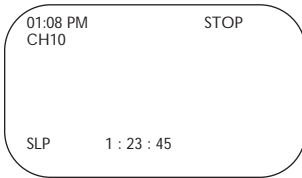

3

While the counter remains on-screen, press the **CLEAR** button to reset the real-time counter to zero.

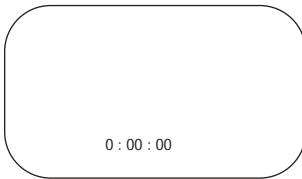

4

While the counter remains on-screen, press the **MEMORY** button so that **M** appears on-screen. To erase a real-time counter memory, press the **MEMORY** button so that the **M** disappears from the screen.

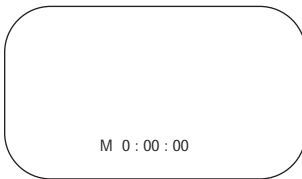

5

To go to a tape location where the real-time counter was reset to zero, press the **REW(ind)/◀** button or the **F.FWD/▶** button when playback is stopped. When the tape reaches the point at which the counter was set to zero, the tape will stop. Press the **PLAY/▲** button to watch the tape.

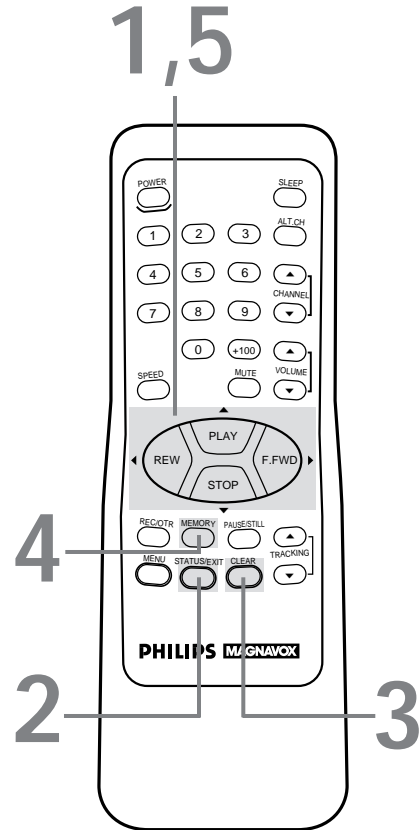

Helpful Hints

- The real-time counter memory will not function during Repeat Play mode. Details are on page 41.
- You may only set one real-time counter memory at a time. If you try to set the real-time counter to zero at a second location, the previous real-time counter to zero setting will be lost.

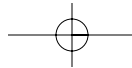

Automatic Operation Features 45

The following playback features will always operate.

Automatic Playback

When you put a tape in the TV/VCR, the power will come on automatically. If the tape's record tab is missing, playback will begin. If a timer recording is set, the power will not come on automatically when you insert a tape with the record tab intact. If a timer recording is set and the TV/VCR power is off, the TV/VCR will eject the tape if the record tab is missing.

Automatic Rewind, Eject, Off

When a tape is played, fast forwarded, or recorded to its end, the TV/VCR will rewind the tape, stop, turn itself off, and eject the tape. If a real-time counter memory is set, the TV/VCR will only rewind the tape to the point at which the counter was set to zero, then stop. The TV/VCR will not turn itself off or eject the tape.

Memory Rewind, Power Off

When the POWER button is pressed while the TV/VCR is rewinding a tape, REW → POWER OFF will appear on-screen. The TV/VCR will turn itself off when the tape has finished rewinding. If a real-time counter memory is set, the TV/VCR may only rewind the tape to the point at which the counter was set to zero, then turn itself off.

Tape Eject

A tape can be ejected with the TV/VCR power on or off (but the TV/VCR must be plugged in). If a timer recording is programmed, a tape can not be ejected when the power is off. Turn on the TV/VCR power, then eject the tape. Be sure to insert a tape and turn off the TV/VCR power for the timer recording.

Automatic Tracking Adjustment

The TV/VCR automatically adjusts the tracking to give you the best possible picture quality. With some recordings, however, you may get a better picture using the manual tracking controls (see below).

Manual Tracking

To adjust the tracking manually, press the CHANNEL ▲/▼ buttons on the TV/VCR or the TRACKING ▲/▼ buttons on the remote control.

Tracking returns to Automatic Tracking Adjustment when a tape is inserted or when the STOP/▼ button is pressed.

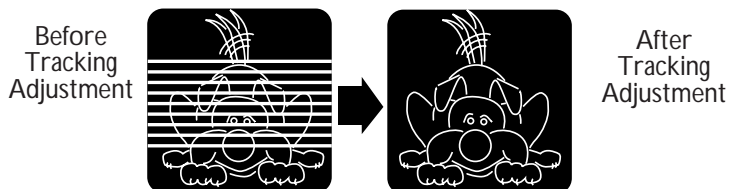

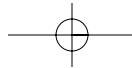

46 Playback Options

Forward and Reverse Searching (SP/LP/SLP)

1

During tape playback, press and release the F.FWD/▶ button or the REW(ind)/◀ button. A fast forward or reverse picture search will begin.

2

To return to normal playback, press the PLAY/▲ button.

Super High Speed Searching (LP/SLP)

1

During tape playback, press the F.FWD/▶ button or the REW(ind)/◀ button, then press again. The TV/VCR will now search in super high speed.

2

To return to normal playback, press the PLAY/▲ button.

Viewing a Still Picture

1

During tape playback, press the PAUSE/STILL button. A still picture will appear on-screen. The noise lines will move each time you press the PAUSE/STILL button.

2

To release the still picture and return to normal playback, press the PLAY/▲ button.

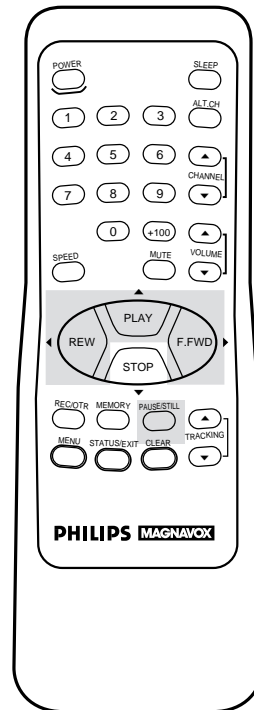

Helpful Hints

- Still mode will automatically switch to Stop mode after five minutes to protect the TV/VCR and the tape from damage.
- SP/LP/SLP means this feature will work with tapes recorded in Standard Play, Long Play, or Super Long Play. For details about tape speed, see page 29.
- LP/SLP means this feature will work with tapes recorded in Long Play and Super Long Play. For details on tape speed, see page 29.
- During forward and reverse searching, horizontal noise bars will appear on the TV/VCR screen.
- Tapes recorded in SLP will have the clearest Still picture.

Specifications / Glossary 47

Specifications

General

CRT: 25-inch in line gun
 Television system: NTSC-M
 Closed caption system: Section 15.119, FCC
 (Federal Communications Commission) Standard
 Video Heads: Two heads
 Tape width: 1/2 inch (12.65 mm)
 Tape speed
 SP: 33.35 mm/sec.
 LP: 16.67 mm/sec.
 SLP: 11.12 mm/sec.
 Operating Temperature: 41°F (5°C) to 104°F (40°C)
 Relative Humidity: 10% to 75%
 Power requirement: AC 120V, 60Hz
 Power consumption: 125W
 Sound output: 1W
 Dimensions:
 24-1/2" (H) x 25-1/32" (W) x 20-3/32" (D)
 622.5 mm x 636 mm x 510 mm
 Weight: 70.4 lbs (32 kg)

Tuner Broadcast Channels

VHF 2-13, UHF 14-69

Cable TV Channels

2 – 13
 Midband: A – 1
 Superband: J – W
 Hyperband: A-5 – A-1
 Special Channel: 5A
 Ultraband: 37 – 94, 100 – 125

Terminals

Antenna IN: VHF/UHF 75 ohms unbalanced
 Video IN: RCA connector
 Audio IN: RCA connector
 Earphone: 3.5 mm CES

Electrical Specifications

Video input level: 0.5~2.0Vp-p
 Audio input level: -10dBv
 Video S/N ratio
 SP: More than 42dBμ
 Audio S/N ratio
 SP: More than 38dB

Designs and specifications are subject to change without notice and without our legal obligation.

Glossary

AUDIO Jack: jack located on the front of the TV/VCR which is used to record audio from another source.

Automatic Channel Setup: process in which the TV/VCR scans all available channels and places the ones you receive in its memory. Then, when you push the CHANNEL ▲/▼ buttons, you only scan through channels you receive.

Bands: settings that allow you to tune channels.

- **Antenna** – VHF (very high frequency; channels 2 - 13) and UHF (ultra high frequency; channels 14 - 69).
- **Cable** – all standard channels can be received without a Cable Box.

Brightness: adjusting increases or decreases the brightness of the color on-screen.

Color: adjusting pales or brightens the TV/VCR color.

Dubbing: copying a tape using a VCR.

HQ: high quality; a feature in the TV/VCR circuitry which provides enhanced picture detail.

Line Input: The channel to which you set your TV/VCR during dubbing. The line input channel is always channel 00 (A/V IN). To exit line input mode, press the CHANNEL ▲/▼ buttons or the Number buttons to select another channel.

Mode: a TV/VCR operation.

OTR: One-Touch Recording; programming a timed recording that starts immediately and records for 30 minutes to eight hours, whichever you specify.

Picture: adjust to increase or decrease the contrast of the picture on-screen.

Sharpness: adjusting softens or clarifies the picture on the TV screen.

Tape Speeds: how fast the tape travels during playback or recording.

- **SP** (standard play) – fastest tape speed (recording time for a T120 tape is approximately two hours); best picture quality.
- **LP** (long play) – average tape speed (recording time for a T120 tape is approximately four hours).
- **SLP** (super long play) – slowest tape speed (recording time for a T120 tape is approximately six hours).

Tint: adjusting changes the tints of the picture on the TV/VCR from purple to green.

VCR: video cassette recorder.

VIDEO Jack: jack located on the front of the TV/VCR which is used to record video from another source.

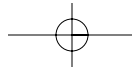

48 Helpful Hints

If you are having problems with your product, check this list of problems and possible solutions before requesting service. You may be able to solve the problem yourself.

If you need to call a customer service representative, please know the model number and serial number of your product before you call. This information is displayed on the back of the product. Also, please take a moment to identify the problem you are having, and be prepared to explain this to the representative. If you believe the representative will need to help you with operations, please stay near the product. Our representatives will be happy to assist you.

Location

For safe operation and satisfactory performance of your TV/VCR, remember the following:

- Shield it from direct sunlight and keep it away from sources of intense heat.
- Avoid dusty or humid places.
- Avoid places with insufficient ventilation. Do not block the ventilation openings at the top and bottom of the TV/VCR. Do not place the TV/VCR on a carpet, as this will block the ventilation openings.
- Avoid locations subject to strong vibrations.
- Do not place the TV/VCR near strong magnetic fields.
- Do not move the TV/VCR from a cold place to a hot place, or vice versa.
- Please do not use this TV/VCR under high temperature conditions.

Electrical Shock and Fire Hazards

- Do not handle the power cord with wet hands.
- Do not pull the power cord when disconnecting the TV/VCR from the AC (alternating current) wall outlet. Grasp it by the plug.
- If water is spilled on the TV/VCR, unplug the power cord immediately and take the TV/VCR to an authorized service center.
- Do not put your fingers or objects into the TV/VCR cassette compartment.
- Do not place anything on top of the TV/VCR.

Dew Warning (Moisture Condensation)

- Moisture may condense inside the unit when it is moved from a cold place to a warm place, after heating a cold room, or when the humidity is high. There is no warning that moisture has accumulated in your TV/VCR. If you try to play a tape in a TV/VCR in which moisture has accumulated, the tape and the TV/VCR could be damaged. If you think moisture may have accumulated inside the TV/VCR, keep the TV/VCR power on (but do not play a tape) for at least two hours. This will allow the TV/VCR to dry.

TV/VCR will not perform a timer recording.

- Make sure the recording start and stop times are set correctly (pages 32 - 35). Midnight is 12 a.m. Noon is 12 p.m.
- Make sure the TV/VCR power is off.
- Make sure the clock is set (pages 12 - 17).
- Make sure there is a tape in the TV/VCR. The tape must have a record tab.
- If the power fails, programmed timer recordings will be restored when the clock is reset. (The clock will reset itself automatically if you are using the AUTO CLOCK feature. Details are on pages 14 - 17. If you are not using the AUTO CLOCK feature, reset the clock manually. Details are on pages 12 - 13.) The timer recording will not occur only if the timer recording was scheduled to take place during the power failure.
- Make sure RECORD DEFEAT is set to OFF (page 36).

TV/VCR will not record.

- Make sure the tape has a record tab (page five).
- Make sure RECORD DEFEAT is set to OFF (page 36).
- Plug the power cord into an active AC outlet (page seven).
- Check your hookups (pages six - seven).
- Set up the channels (page 10).

TV/VCR has no power.

- Make sure the power plug is completely connected to an AC (alternating current) outlet.

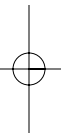

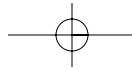

Helpful Hints (cont'd) 49

.....
The remote control is not available, or the remote control will not access the pop up menu.

- Use the buttons on the front panel of the TV/VCR to access the pop up menu (page 20). You can not enter numbers (for example, to program a timer recording) using the front panel buttons.

TV/VCR power shuts off after 15 minutes.

- To save energy, the TV/VCR will shut itself off after 15 minutes when it is on a channel that is not receiving a broadcast signal (for example, a station that has gone off the air for the night). This is normal.

Channel reception is poor.

- Check connections, then set up the channels again (page 10).

TV/VCR does not have a picture.

- Adjust the antenna (pages six - seven).
- Adjust the TV/VCR picture controls (pages 24 - 25).

TV/VCR has poor sound or no sound.

- Adjust the volume.
- Press the MUTE button to restore the volume.

Tape playback is poor or tape is destroyed.

- Adjust the tracking. *Details are on page 45.*
- If moisture has accumulated in your TV/VCR, keep the power on for at least two hours, but do not try to play a tape. *Details are on page 48.*

TV/VCR does not display closed captions.

- Cancel Counter Only mode. *Details are on page 26.*
- Make sure closed captioning is available for the program. Refer to the TV listings in your local newspaper.

Remote control does not operate TV/VCR.

- Aim the remote control directly at the TV/VCR's remote sensor. *Details are on pages five and 20.*
- Remove all obstacles between the remote control and the TV/VCR.
- Inspect and replace the batteries in the remote control. *Details are on page five.*

Number buttons won't work for channels above 69.

- Select CABLE from the INPUT section of the pop up menu, then let the TV/VCR set up the channels. *Details are on page 10.*

TV/VCR can't receive channels above 13.

- Select CABLE from the INPUT section of the pop up menu, then let the TV/VCR set up the channels. *Details are on page 10.*

A tape can't be inserted into the TV/VCR.

- Insert the tape window side up, with the record tab facing you.
- Make sure a tape isn't already in the TV/VCR by pressing the STOP/EJECT button on the TV/VCR.
- Gently push on the center of the tape. Never force a tape into the TV/VCR.
- If a timer recording is set and the TV/VCR power is off, the TV/VCR will eject the tape if the record tab is missing.

A tape can't be removed from the TV/VCR.

- Make sure the power plug is completely connected to an AC (alternating current) outlet.
- If a timer recording is programmed, turn on the TV/VCR power, then eject the tape. Be sure to insert a tape and turn off the TV/VCR power for the timer recording.

TV/VCR ejects the tape when you try to start a recording.

- Make sure the tape has a record tab. *Details are on page five.*

The cylinder rotates when tape playback is stopped.

- To enable the quick play mechanism, the cylinder will rotate for about five minutes. This is normal. The quick play mechanism switches the tape mechanism from Stop to Play in just one second.

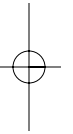
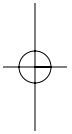



50 Limited Warranty

TV/VCR COMBINATION

90 Days Free Labor/One Year Free Parts Exchange (Two Years Free Exchange on Color Picture Tube)
 This product must be carried in for repair.

WHO IS COVERED?

You must have proof of purchase to receive warranty service. A sales receipt or other document showing that you purchased the product is considered proof of purchase.

WHAT IS COVERED?

Warranty coverage begins the day you buy your product. For 90 days thereafter, all parts will be repaired or replaced, and labor is free. From 90 days to one year from the day of purchase, all parts will be repaired or replaced, but you pay for all labor charges. From one to two years from the day of purchase, you pay for the replacement or repair of all parts except the picture tube, and for all labor charges. After two years from the day of purchase, you pay for the replacement or repair of all parts, and for all labor charges.

All parts, including repaired and replaced parts, are covered only for the original warranty period. When the warranty on the product expires, the warranty on all replaced and repaired parts also expires.

WHAT IS EXCLUDED?

Your warranty does not cover:

- labor charges for installation or setup of the product, adjustment of customer controls on the product, and installation or repair of antenna systems outside of the product.
- product repair and/or part replacement because of misuse, accident, unauthorized repair or other cause not within the control of Philips Consumer Electronics Company.
- reception problems caused by signal conditions or cable or antenna systems outside the unit.
- a product that requires modification or adaptation to enable it to operate in any country other than the country for which it was designed, manufactured, approved and/or authorized, or repair of products damaged by these modifications.
- incidental or consequential damages resulting from the product. (Some states do not allow the exclusion of incidental or consequential damages, so the above exclusion may not apply to you. This includes, but is not limited to, prerecorded material, whether copyrighted or not copyrighted.)
- damage caused by the use of non-VHS tapes or tapes that have not been tested and labeled for use in two, four, six, and eight hour VHS recorders.
- a product that is used for commercial or institutional purposes.

WHERE IS SERVICE AVAILABLE?

Warranty service is available in all countries where the product is officially distributed by Philips Consumer Electronics Company. In countries where Philips Consumer Electronics Company does not dis-

tribute the product, the local Philips service organization will attempt to provide service (although there may be a delay if the appropriate spare parts and technical manual(s) are not readily available).

MAKE SURE YOU KEEP...

Please keep your sales receipt or other document showing proof of purchase. Attach it to this owner's manual and keep both nearby. Also keep the original box and packing material in case you need to return your product.

BEFORE REQUESTING SERVICE...

Please check your owner's manual before requesting service. Adjustments of the controls discussed there may save you a service call.

TO GET WARRANTY SERVICE IN U.S.A., PUERTO RICO OR U.S. VIRGIN ISLANDS...

Take the product to a Philips factory service center (see enclosed list) or authorized service center for repair. When the product has been repaired, you must pick up the unit at the center. Centers may keep defective parts.

(In U.S.A., Puerto Rico and U.S. Virgin Islands, all implied warranties, including implied warranties of merchantability and fitness for a particular purpose, are limited in duration to the duration of this express warranty. But, because some states do not allow limitations on how long an implied warranty may last, this limitation may not apply to you.)

TO GET WARRANTY SERVICE IN CANADA...

Please contact Philips at:

1-800-661-6162 (French Speaking)
 1-800-363-7278 (English Speaking)

(In Canada, this warranty is given in lieu of all other warranties. No other warranties are expressed or implied, including any implied warranties of merchantability or fitness for a particular purpose. Philips is not liable under any circumstances for any direct, indirect, special, incidental or consequential damages, howsoever incurred, even if notified of the possibility of such damages.)

REMEMBER...

Please record below the model and serial numbers found on the product. Also, please fill out and mail your warranty registration card promptly. It will be easier for us to notify you if necessary.

MODEL # _____

SERIAL # _____

This warranty gives you specific legal rights. You may have other rights which vary from state to state.

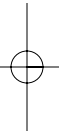
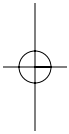

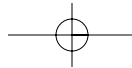

Index 51

-
- a-b repeat play42 - 43
 - accessories52
 - ant(enna) jack6, 21
 - audio jack20, 31
 - automatic
 - playback45
 - rewind45
 - batteries5
 - brightness, adjusting . . .24 - 25
 - cassette compartment20
 - channel
 - above 10022
 - adding11
 - deleting11
 - reviewing11
 - setup10
 - ▲/▼ buttons20, 23, 45
 - clear button23, 44
 - clock12 - 17
 - closed caption system . . .38 - 39
 - color, adjusting24 - 25
 - connections6 - 7, 31
 - contents, table of4
 - controls
 - remote22 - 23
 - tv/vcr20 - 21
 - counter only mode26
 - daylight-saving time18
 - duplication31
 - earphone jack20
 - erasure prevention5
 - fast forward search46
 - f.fwd button20, 23, 46
 - front panel20
 - glossary47
 - helpful hints48 - 49
 - hookups6 - 7, 31
 - language selection8, 9
 - line input mode10, 31, 47
 - long play29, 47
 - lp29, 47
 - memory
 - button23, 43 - 44
 - real-time counter44
 - rewind, power off45
 - menu
 - button22
 - front panel button access . .20
 - mute button23
 - number buttons22
 - on-screen-off mode26
 - on-screen-on mode26
 - on-screen status displays . . .26
 - one-touch recording30
 - pause/still button23, 46
 - picture, adjusting24 - 25
 - play button20, 22
 - playback options46
 - playing28
 - power
 - button20, 22
 - cord7
 - real-time counter memory . . .44
 - rear panel21
 - rec(ord)/otr button20, 22
 - rec(ord) light20
 - record defeat36
 - record tab5
 - recording29
 - reminder27
 - remote
 - control
 - buttons22 - 23
 - using5
 - sensor20
 - repeat play41
 - rerecording31
 - rew(ind) button20, 22, 46
 - rewinding46
 - safety precautions3
 - searching46
 - sensor (remote)20
 - sharpness, adjusting24 - 25
 - sleep timer37
 - slp29, 47
 - smartclock12 - 17
 - sp29, 47
 - standard play29, 47
 - status display26
 - status/exit button22
 - still picture46
 - stop button23
 - stop/eject button20
 - super high speed searching . . .46
 - super long play29, 47
 - table of contents4
 - tape
 - duplication31
 - speed29, 47
 - time
 - setting12 - 17
 - zone19
 - timer recording
 - cancelling35
 - reviewing35
 - setting32 - 34
 - tint, adjusting24 - 25
 - tracking45
 - video jack20, 31
 - volume bar40
 - warranty50

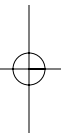
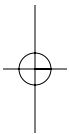

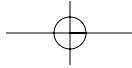

SUPPLIED ACCESSORIES

Check to be sure the items on this page are packed with your TV/VCR. These accessories are provided to help you use or set up your TV/VCR.

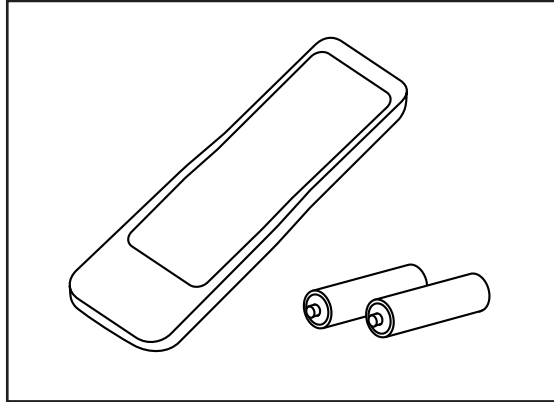

**Remote Control (4835 218 37216)
Two AA Batteries (4835 138 17012)**

If any of these items are not included, or if you need to replace an item, contact Philips Service Solutions Group at the address below.

***Philips Service Solutions Group
P.O. Box 967
Greeneville, TN 37744-0967***

Or, call 1-800-851-8885.