



---

# **ATI Radeon™ HD 2600 Series**

User's Guide

© 2007 Advanced Micro Devices, Inc. All rights reserved.

The contents of this document are provided in connection with Advanced Micro Devices, Inc. ("AMD") products. AMD makes no representations or warranties with respect to the accuracy or completeness of the contents of this publication and reserves the right to make changes to specifications and product descriptions at any time without notice. No license, whether express, implied, arising by estoppel or otherwise, to any intellectual property rights is granted by this publication. Except as set forth in AMD's Standard Terms and Conditions of Sale, AMD assumes no liability whatsoever, and disclaims any express or implied warranty, relating to its products including, but not limited to, the implied warranty of merchantability, fitness for a particular purpose, or infringement of any intellectual property right.

AMD's products are not designed, intended, authorized or warranted for use as components in systems intended for surgical implant into the body, or in other applications intended to support or sustain life, or in any other application in which the failure of AMD's product could create a situation where personal injury, death, or severe property or environmental damage may occur. AMD reserves the right to discontinue or make changes to its products at any time without notice.

Reproduction of this manual, or parts thereof, in any form, without the express written permission of Advanced Micro Devices, Inc. is strictly prohibited.

### **Trademarks**

AMD, the AMD Arrow logo, AMD Athlon, AMD Opteron and combinations thereof, AMD-XXXX, ATI and ATI product and product-feature names are trademarks of Advanced Micro Devices, Inc.

Microsoft is a registered trademark of Microsoft Corporation.

Other product names used in this publication are for identification purposes only and may be trademarks of their respective companies.

### **Disclaimer**

While every precaution has been taken in the preparation of this document, Advanced Micro Devices, Inc. assumes no liability with respect to the operation or use of AMD hardware, software or other products and documentation described herein, for any act or omission of AMD concerning such products or this documentation, for any interruption of service, loss or interruption of business, loss of anticipatory profits, or for punitive, incidental or consequential damages in connection with the furnishing, performance, or use of the AMD hardware, software, or other products and documentation provided herein.

Advanced Micro Devices, Inc. reserves the right to make changes without further notice to a product or system described herein to improve reliability, function or design. With respect to AMD products which this document relates, AMD disclaims all express or implied warranties regarding such products, including but not limited to, the implied warranties of merchantability, fitness for a particular purpose, and non-infringement.

### **Macrovision**

Apparatus Claims of U.S. Patent Nos. 4,631,603; 4,819,098; 4,907,093; 5,315,448; and 6,516,132. Licensed for limited viewing uses only.

This product incorporates copyright protection technology that is protected by US patents and other intellectual property rights. Use of this copyright protection technology must be authorized by Macrovision, and is intended for home and other limited viewing uses only unless otherwise authorized by Macrovision. Reverse engineering or disassembly is prohibited.

### **Documentation Updates**

AMD is constantly improving its product and associated documentation. To maximize the value of your AMD product, you should ensure that you have the latest documentation. AMD's documentation contains helpful installation/configuration tips and other valuable feature information.

## Important Safety Instructions

- **Read Instructions**—All the safety and operating instructions should be read before the product is operated.
- **Retain Instructions**—The safety and operating instructions should be retained for future reference.
- **Heed Warnings**—All warnings on the product and the operating instructions should be adhered to.
- **Compatibility**—This option card is for use only with IBM AT or compatible UL Listed personal computers that have Installation Instructions detailing user installation of card cage accessories.
- **Grounding**—For continued protection against risk of electric shock and fire, this accessory should be installed only in products equipped with a three-wire grounding plug, a plug having a third (grounding) pin. This plug will only fit into a grounding-type power outlet. This is a safety feature. If you are unable to insert the plug into the outlet, contact your electrician to replace the obsolete outlet. Do not defeat the safety purpose of the grounding-type plug.
- **Secure Attachment**—All card securement pins shall be completely tightened as to provide continuous bonding between the option card and the PC chassis.



# Contents

<b>Introduction</b> .....	<b>1</b>
System Requirements	1
<b>Installing the Graphics Card</b> .....	<b>3</b>
Before You Begin	3
Record the Serial and Part Numbers	3
Uninstall Old Graphics Drivers	4
Install the Graphics Card	5
<b>Installing and Configuring Displays</b> .....	<b>7</b>
Connections	7
Adapters	8
Supported Display Connections	8
Connecting and Configuring Displays	9
<b>Installing Software and Drivers</b> .....	<b>11</b>
<b>ATI Catalyst™ Control Center</b> .....	<b>13</b>
Help	14
<b>Using TV Display</b> .....	<b>15</b>
Viewing the PC Display on TV or HDTV	15
Connecting to a TV, VCR, or HDTV	16
Setting the Windows® Volume Control	29
Using the Avivo™ Video Converter	29
<b>CrossFire™</b> .....	<b>33</b>
Basic Requirements	33
Installing CrossFire™ Graphics Cards	33
Enabling CrossFire™	37

<b>Reference</b> .....	<b>39</b>
Troubleshooting	39
Determine the System Card Bus Type	42
Updating your AGP Motherboard/Chipset Drivers	43
Reinstalling Drivers	45
Product Registration	46
Customer Care	46
Additional Accessories	47
Compliance Information	48
<b>Index</b> .....	<b>51</b>

# Introduction

This guide will help you get your hardware and software installed. Use the ATI Catalyst™ Control Center to access the comprehensive help system, generate a problem report, and get the software version information.

## System Requirements

<b>Hardware</b>	<ul style="list-style-type: none"><li>• AMD Athlon® or Intel® Pentium® 4</li><li>• 512MB of system memory; 1GB or more for best performance.</li><li>• Optical drive for installation software (CD-ROM or DVD-ROM drive).</li><li>• A 350 Watt or better power supply.</li></ul>
<b>CrossFire™ Requirements</b>	<p>To implement an CrossFire™ configuration using the ATI Radeon™ HD 2600 Series PCIe™ graphics cards requires:</p> <ul style="list-style-type: none"><li>• A CrossFire™ certified motherboard with two (2) PCI Express® x16 slots and correct PCIe™ chipset driver</li><li>• A second ATI Radeon™ HD 2600 Series graphics card.</li><li>• Two CrossFire™ internal bridge interconnects.</li><li>• A specialized 550 watt or greater power supply. Consult your computer system manual to ensure the power supply is designed to accommodate a high-end graphics card with a peak dissipation above 150 watts.</li></ul> <p>For an up-to-date listing of CrossFire™ certified motherboards, see</p> <ul style="list-style-type: none"><li>• <a href="http://ati.amd.com/products/certification">ati.amd.com/products/certification</a></li></ul> <p>For an up-to-date listing of certified power supplies, see:</p> <ul style="list-style-type: none"><li>• <a href="http://ati.amd.com/certifiedpsu">ati.amd.com/certifiedpsu</a></li></ul>





# Installing the Graphics Card

This topic guides you through the installation of the graphics card.

## Before You Begin

Before you begin installing the graphics card, do the following.

- [Record the Serial and Part Numbers on page 3.](#)
- [Uninstall Old Graphics Drivers on page 4.](#)

When you have completed the above procedures, do the following:

- [Install the Graphics Card on page 5.](#)

## Record the Serial and Part Numbers

To register the graphics card, you need the serial number and part number printed on the graphics card.

- 1 Look for the serial number and part number on the graphics card.

**Note:** They are usually located on a sticker on the back of the card, and are shown in boldface and underlined in the illustration that follows.



S/N (01)0072741548020 (21) **000000 000000**



P/N **1028360100** 057805 MADE IN CHINA

Sample serial number and part number arrangement

- 2 Write down these numbers before installing the graphics card.

## Uninstall Old Graphics Drivers

To ensure successful installation of the graphics card driver, uninstall the graphic drivers for the existing graphics card before removing the graphics card from the computer.

Depending on the operating system, choose either the Windows® XP or Windows Vista® uninstall procedure:

- Uninstall old graphics drivers (Windows® XP) on page 4.
- Uninstall old graphics drivers (Windows Vista®) on page 4.

### ***Uninstall old graphics drivers (Windows® XP)***

- 1 With the current graphics card still in the computer, close all open applications.
- 2 From the Control Panel, select **Add/Remove Programs**.
- 3 Select the current graphics card drivers, and then click **Add/Remove**.  
The Wizard helps remove the current display drivers.

**Note:** If the previously installed graphics card has any additional software installed, it may also be removed at this point. For example, DVD player or multimedia applications.

- 4 Turn off the system after removing the drivers.

### ***Uninstall old graphics drivers (Windows Vista®)***

- 1 With the current graphics card still in the computer, close all open applications.
- 2 From Control Panel, double-click **Programs and Features**, and then select the graphics card driver from the list of software programs.
- 3 Click **Uninstall**.
- 4 If the **Programs and Features** uninstall confirmation dialog appears, click **Yes**.

**Note:** If the previously installed graphics card has any additional software installed, it may also be removed at this point. For example, DVD player or multimedia applications.

- 5 Turn off the system after removing the drivers.

## Install the Graphics Card

- 1 Make sure the computer, monitor, and other peripheral devices are off.
- 2 Unplug the computer power cord and disconnect cables from the back of the computer.

**Caution!** To avoid possible damage to the motherboard, wait approximately 20 seconds after unplugging the power cord before disconnecting a peripheral or removing a component from the motherboard.

- 3 Remove the computer cover.

If necessary, consult the computer manual for help removing the cover.

**Caution!** To avoid possible damage to the computer components, discharge your body's static electricity by touching the power supply case or the metal surface of the computer chassis.

- 4 Remove any existing graphics cards from the computer.



**Warning!** Some graphics cards can get hot while operating. Wait about five minutes after turning off the computer before touching the card.

- 5 Locate the appropriate slot for the graphics card and, if necessary, remove the metal back-plate cover.

**Note:** High-performance graphics cards require good airflow to prevent overheating. Ensure adequate airflow around the card.

- 6 Align the graphics card with the slot and press it in firmly until the card is fully seated.
- 7 Fasten the graphics card securely.
- 8 Make sure the cables are not interfering with anything inside the computer (for example, a cooling fan) and then replace the computer cover.
- 9 Reconnect any cables you have disconnected, connect the monitors, and then plug in the computer and monitor power cords.

**10** Turn on the monitor and then the computer.

**Note:** For troubleshooting information, see [Reference on page 39](#).

**Note:** For information on connecting monitors, see [Installing and Configuring Displays on page 7](#).

**Note:** If you are installing a CrossFire™ configuration, see [CrossFire™ on page 33](#).

# Installing and Configuring Displays

## Connections

The following illustrate the typical connections on the ATI Radeon™ HD 2600 Series graphics card. The connections available may vary between models of this series graphics card.

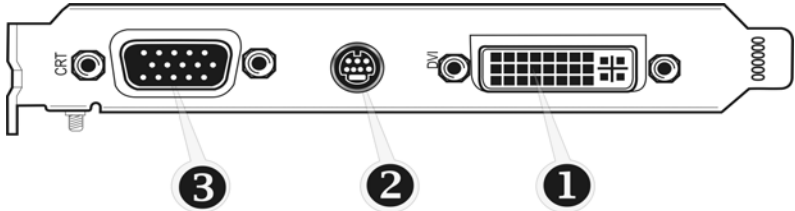

**Sample 1: ATI Radeon™ HD 2600 Series Connections**

---

### Legend

---

- |   |   |
|---|---|
| 1 | DVI-I Dual Link connection (Provides audio and video digital signals. It provides HDMI™ output that is compatible with most HDMI™ devices.) |
| 2 | S-Video connection (Video Out)  |
| 3 | SVGA connection   |
- 

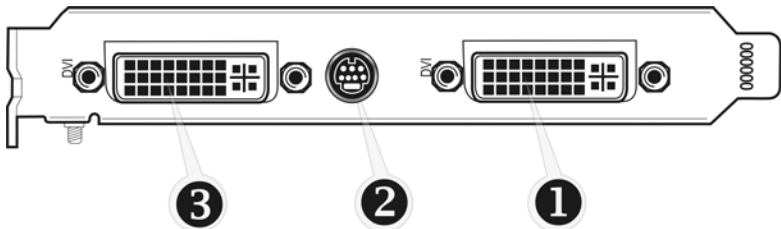

**Sample 2: ATI Radeon™ HD 2600 Series Connections**

---

### Legend





---

- |   |   |
|---|---|
| 1 | DVI-I Dual Link connection  |
| 2 | S-Video connection (Video Out)  |
| 3 | DVI-I Dual Link connection (Provides audio and video digital signals. It provides HDMI™ output that is compatible with most HDMI™ devices.) |
-

## Adapters

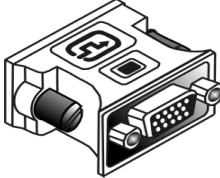
The following illustrates the adapters you can use to connect the graphics card to other display devices.

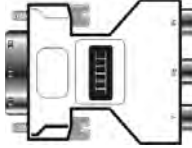
---

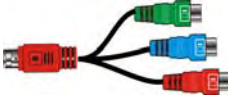
	<p>ATI DVI-to-VGA Adapter</p>
	<p>ATI DVI to HDMI™ Adapter The HDMI™ adapter is a proprietary adapter manufactured and sold by AMD approved manufacturers (like Wieson Technologies Co., Ltd.) that has a specific detection mechanism to allow properly configured graphics cards to pass HDMI™ signals through a DVI connection to an HDMI™ compliant device.</p>
	<p>ATI DVI-to-HDTV Adapter</p>
	<p>ATI 9-Pin Cable for Video Input/Video Output</p>
	<p>ATI 9-pin HDTV Output Cable</p>

---

## Supported Display Connections

To ensure the highest possible performance, only one display device is supported when CrossFire™ is active. When CrossFire™ is active other display devices connected to the other connections on both graphics cards are rendered inactive.

If additional displays are required when CrossFire™ is active, use either SurroundView™ (included on the installation CD, custom software install) or an additional graphics card.

The graphics card provides hardware support for DVI-I and VGA monitors, and HDMI™ HDTVs (using a DVI-to-HDMI™ adapter). It also provides TV output via the S-Video connection in composite, S-Video, and component TV formats.

The following table shows display configurations available when CrossFire™ is *not* enabled.

Display	Connections
Cathode ray tube analog display	<ul style="list-style-type: none"> <li>• SVGA connection and VGA cable</li> <li>• DVI-I connection and DVI-I-to-VGA adapter</li> </ul>
LCD display	<ul style="list-style-type: none"> <li>• DVI-I connection and DVI cable</li> <li>• DVI-I connection and DVI-I-to-VGA adapter</li> </ul>
TV	<ul style="list-style-type: none"> <li>• DVI cable and DVI-to-HDTV adapter and RCA cables</li> <li>• S-Video connection and S-Video cable</li> <li>• S-Video connection and ATI 9-Pin HDTV Output Cable and RCA cablest</li> </ul>
HDTV display	<ul style="list-style-type: none"> <li>• DVI connection and DVI cable</li> <li>• DVI cable and DVI-to-HDTV adapter and RCA cables</li> <li>• S-Video connection and ATI 9-Pin HDTV Output Cable and RCA cables</li> <li>• S-Video connection and S-Video cable</li> </ul>
HDMI™ HDTV	<ul style="list-style-type: none"> <li>• DVI connection and DVI-to-HDMI™ adapter and HDMI™ cable (PCI Express models only)</li> </ul>

## Connecting and Configuring Displays

### *Connect the monitor*

- 1 Make sure the computer and monitor are off.
- 2 Plug the monitor cables into their appropriate connectors.
- 3 Power on the monitors first and then restart that computer so that Windows® can detect the new hardware settings.

- 4 When the **New Hardware Found** Wizard appears, at the appropriate prompt insert the installation CD to load the drivers for the graphics card.

Once the drivers and software have been installed, configure the display.

### **Configure the display**

- 1 Navigate to the **Control Panel** and choose **Display**, or right-click on the desktop and choose **Properties**.
- 2 Choose the **Settings** tab and select the screen resolution and color depth that best suit your requirements and your display's performance.
- 3 Click **Advanced** and then select the **Monitor** tab.
- 4 Choose a refresh rate from the drop-down list.

**Caution!** Choosing a refresh rate unsupported by your display may damage your display. Consult your display's documentation if necessary.

- 5 Click **OK** to return to the desktop.

Once you have configured the main display you can configure any other displays that are connected.

- 6 To configure another display, do the following:
  - a) From the **Start** menu click **Control Panel**, and then click **Display**.
  - b) To access the basic multi-monitor configuration settings, click the **Settings** tab .
  - c) Select the **Monitor** icon identified by the number **2**.
  - d) Click **Extend my Windows desktop onto this monitor**.
  - e) Set the **Screen Resolution** and **Color Quality** as appropriate for the second monitor. Click **Apply** or **OK** to apply these new values.

**Note:** When using multiple monitors with the graphics card, one monitor will always be the **Primary** display. Any additional monitors will be designated as **Secondary**.

**Note:** You can also enable and configure multiple monitors using the ATI Catalyst™ Control Center.



# Installing Software and Drivers

Software is provided to take advantage of all the features of your ATI graphics card, including:

- Graphics card driver
- ATI Catalyst™ Control Center
- HydraVision™ software (included in the Custom install)
- SurroundView™ software (included in the Custom install)
- Avivo™ video converter software (included in the Custom install)

**Note:** To ensure you have access to all the new features and performance options, download the latest driver from [ati.amd.com/support/driver.html](http://ati.amd.com/support/driver.html).

## *Install the software*

To install or remove the drivers, you must have administrator rights or be logged on as a user with administrator rights.

Make sure your monitor cable is properly connected before you begin.

**Note:** The installation dialog displays in English if your operating system's language is not supported.

- 1 Insert the ATI installation CD into the computer.  
If Windows® runs the CD automatically, proceed to step 3.
- 2 Double-click the CD, double-click **ATISSETUP**, and then click **OK**.
- 3 Follow the on-screen instructions, and then select either **Express** or **Custom Install**.

**Note:** Not all software components are installed using the Express installation. Custom installation allows you to select individual software components for installation, such as HydraVision™ and the Avivo™ Video Converter.

**Tip!** If the installer fails to install the driver or you have a software conflict, you can download the latest software from [ati.amd.com/support/driver.html](http://ati.amd.com/support/driver.html) and then install it.



## ATI Catalyst™ Control Center

The ATI Catalyst™ Control Center is software that provides access to the display features of the graphics card. Use the ATI Catalyst™ Control Center to fine-tune your graphics settings, enable or disable connected display devices, and change the orientation of the desktop. Many features display previews of the changes before they are applied.

The ATI Catalyst™ Control Center offers two views:

- Basic View is a simplified view that includes wizards to get the inexperienced user up and running.
- Advanced View allows the experienced user to configure the complete feature set of the software.

You can customize the ATI Catalyst™ Control Center for easy access to the features you use most.

## Start ATI Catalyst™ Control Center

Start ATI Catalyst™ Control Center from one of the following access points:

Access Point	Instructions
<b>Windows® Desktop</b>	<ol style="list-style-type: none"> <li>1. Right-click the Windows® desktop.</li> <li>2. From the short menu, select <b>ATI Catalyst® Control Center</b>.</li> </ol>
<b>Windows® Start Menu</b>	From the Windows® task bar, click <b>Start</b> , and then select <b>Programs &gt; ATI Catalyst™ Control Center</b> .
<b>Windows® System Tray</b>	<ol style="list-style-type: none"> <li>1. Right-click the ATI icon in the Windows® System Tray.</li> <li>2. From the short menu, select <b>ATI Catalyst® Control Center</b>.</li> </ol>
<b>Desktop shortcut</b>	<p>When you first installed the ATI Catalyst® Control Center, the setup wizard provided you with the option of placing a shortcut on the desktop. If you chose this option, you can</p> <ul style="list-style-type: none"> <li>• Double-click the ATI Catalyst® Control Center desktop shortcut.</li> </ul>
<b>Predefined hot keys</b>	Press the predefined combination of keys, <b>Ctrl+Alt+C</b> to launch ATI Catalyst® Control Center, or you can define your own hot key sequence by using the ATI Catalyst® Control Center Hotkey Manager.

## Help

The ATI Catalyst™ Control Center Help provides conceptual information to help you understand the graphics technology implemented in the graphics card, and detailed instructions on how to optimize your graphics environment. You can also use the ATI Catalyst™ Control Center Help feature to access usage information, generate a problem report, and get the software version information.

### Access help

Right-click the Windows® desktop, select **ATI Catalyst™ Control Center**, choose **Advanced**, and then do either of the following:

- Press **F1** at any time to get specific help on the feature or aspect displayed.
- From the ATI Catalyst™ Control Center Dashboard, click **Help**.

# Using TV Display

These topics describe how to use the TV display feature of your graphics card.

- [Viewing the PC Display on TV or HDTV on page 15.](#)
- [Connecting to a TV, VCR, or HDTV on page 16.](#)
- [Connect to a European video device \(S-Video to SCART using composite video adapter\) on page 27.](#)
- [Using the Avivo™ Video Converter on page 29.](#)

## Viewing the PC Display on TV or HDTV

The graphics card has TV out capability. You can attach the graphics card to a TV and a monitor at the same time.

**Warning!** IMPORTANT INFORMATION for European Customers. Some PC monitors in Europe **cannot** be used simultaneously with TV display. When you enable TV display in Europe, the refresh rate for the monitor and TV is set to 50 Hz. Some monitors may not support this refresh rate **and could be damaged**.

Check the documentation supplied with the monitor to see if the monitor supports a refresh rate of 50 Hz. If the monitor does not support 50 Hz (or if you are not sure), do not use your monitor as a secondary display.

TV display is useful for giving presentations and watching movies, or playing games on a screen larger than a typical monitor. The following tips will help you get the most out of the TV out feature.

### ***Using a Monitor vs. Using TV Display***

Using the TV as the primary computer display can be useful; however, the display on the monitor may change or looked squashed. This distortion occurs because the display adjusts to fit the dimensions of the TV. To correct the monitor display, use the monitor control buttons to adjust its display size and position.

Some single-frequency monitors may not work with TV display enabled. If you experience problems when TV display is enabled, disable TV display to restore the monitor's display.

### ***Viewing Text on a TV***

A TV is designed primarily to show moving images. The large dot pitch of a TV will yield poor quality static images. The small text sizes commonly used for PC desktops can appear blurred or unclear on a TV. You can compensate for this degradation by using larger fonts.

### ***Using a TV as the Only Display***

If you plan to move the computer to a place where you are using TV display only, make sure that you have the TV display feature enabled prior to disconnecting the monitor.

The maximum display resolution for TV is 1024×768. Choosing a resolution higher than this will cause the TV display to disappear if it is the only display device.

### ***Using Games and Applications***

Some older games and applications may instruct the graphics card to run under a specific display mode. This may cause the TV display to turn off automatically or become scrambled (the PC monitor or LCD display will not be affected). The TV display will be restored once you exit the game or if you restart the computer.

## **Connecting to a TV, VCR, or HDTV**

You can connect the graphics card to a TV, HDTV, or VCR in several ways, depending on the inputs the TV supports. To ensure the highest quality graphics, choose the connection available that provides the best signal.

Connections supported, in descending order of quality:

- HDMI™ (available on PCI Express cards only)
- DVI (available on HDTV only)
- Component
- Composite
- S-Video

**Note:** If the TV has cable input only, connect the graphics card to the TV through a VCR or an RF modulator, which is available from most electronics stores.

**Note:** Copy-protected DVDs restrict playback to 480i and 480p modes.

**Note:** For maximum performance when watching DVD movies or playing computer games on the TV, find the mode and screen resolution that provide the best result, and use those settings exclusively.

This topic includes the following procedures:

- [Connect to an HDMI™ HDTV \(DVI-to-HDMI™\) on page 18.](#)
- [Connect to an HDTV \(DVI-to-DVI\) on page 20.](#)
- [Connect to an HDTV or component video device \(DVI-to-Component Video using ATI DVI-to-HDTV adapter\) on page 21.](#)
- [Connect to an HDTV or component video device \(S-Video-to-Component Video using ATI 9-Pin HDTV Output Cable\) on page 23.](#)
- [Connect to a composite video device \(S-Video-to-S-Video or Composite Video\) on page 25.](#)
- [Connect to a European video device \(S-Video to SCART using composite video adapter\) on page 27.](#)

## Connect to an HDMI™ HDTV (DVI-to-HDMI™/ PCI Express only)

**Note:** This option is available on graphics cards that support HDMI™.

- 1 Before connecting an HDMI™ HDTV, attach a monitor to the computer and install the video drivers.
- 2 Make sure the computer and monitor are off.

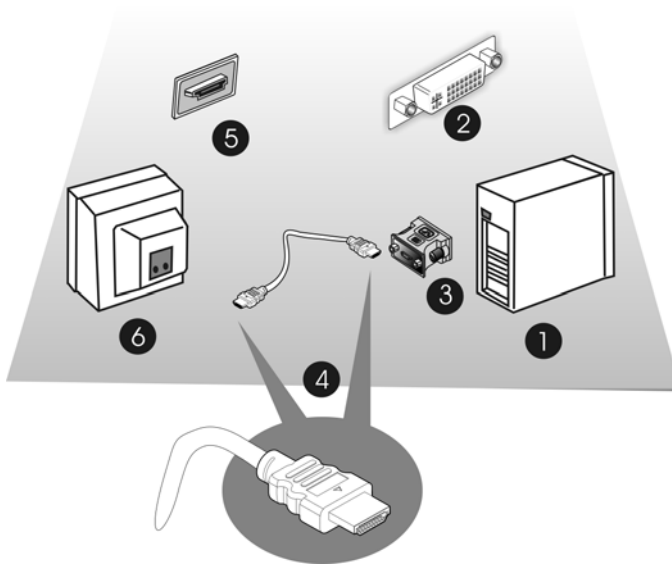

### HDMI™-to-HDMI™ connectors

#### Legend

1	Computer
2	DVI connection on the graphics card (On graphics cards with a DMS-59 port that supports HDMI™, connect a DMS-59 to two DVI adapter to create a DVI connection.)
3	DVI-to-HDMI™ adapter
4	HDMI™-to-HDMI™ cable
5	HDMI™ connection on the HDTV
6	HDMI™ HDTV

- 3 Connect the DVI-to-HDMI™ adapter to the DVI connection on the graphics card.



- 4** Connect one end of the HDMI™-to-HDMI™ cable to the DVI-to-HDMI™ adapter. Connect the other end of the HDMI™-to-HDMI™ cable to the HDMI™ connection on the HDMI™ HDTV.
- 5** If necessary, configure the HDTV for external audio. For more information, see the documentation that came with the TV.
- 6** Power on the monitor and HDTV, and then power on the computer. The HDTV will not display anything until Windows® starts.
- 7** Configure the HDTV using the ATI Catalyst™ Control Center, Displays Manager and DTV(HDMI) .

### Connect to an HDTV (DVI-to-DVI)

- 1 Before connecting an HDTV, attach a monitor to the computer and install the video drivers.
- 2 Make sure the computer and monitor are off.

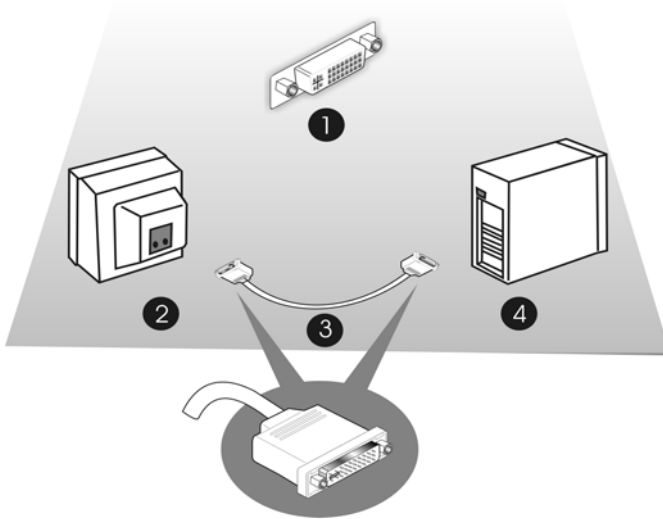

#### DVI-to-DVI connectors

##### Legend

- |   |  |
|---|--|
| 1 | DVI connection on the graphics card and the HDTV (On graphics cards with a DMS-59 port, connect a DMS-59 to two DVI adapter to create a DVI connection.) |
| 2 | HDTV   |
| 3 | DVI-to-DVI cable   |
| 4 | Computer   |

- 3 Connect one end of the DVI cable to the DVI connection on the graphics card. Connect the other end of the DVI cable to the DVI connection on the HDTV.
- 4 Connect one end of a sound cable to the computer sound card. Connect the other end of the cable to the sound input on the HDTV.
- 5 Configure the HDTV for external audio. For more information, see the documentation that came with the HDTV.

- 6 Power on the monitor and HDTV, and then power on the computer.  
The HDTV will not display anything until Windows® starts.
- 7 Configure the HDTV using the ATI Catalyst™ Control Center, Displays Manager and DTV(DVI).

### **Connect to an HDTV or component video device (DVI-to-Component Video using ATI DVI-to-HDTV adapter)**

- 1 Before connecting an HDTV, attach a monitor to the computer and install the video drivers.
- 2 Make sure the computer and monitor are off.

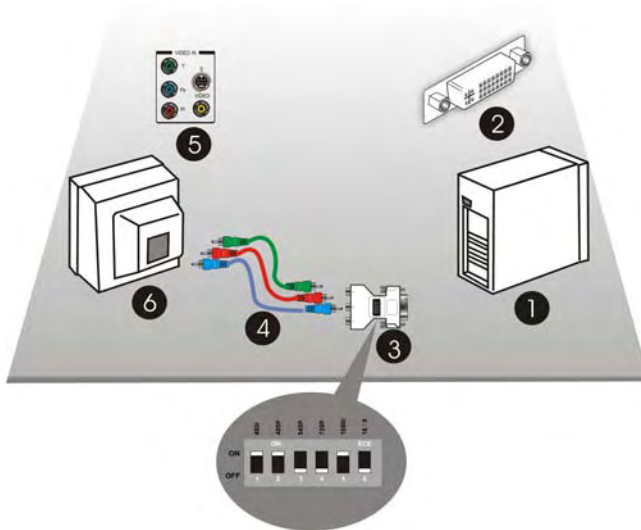

#### **DVI to component video connectors**

##### **Legend**

- |   |   |
|---|---|
| 1 | Computer  |
| 2 | DVI connection on the graphics card (On graphics cards with a DMS-59 port, connect a DMS-59 to two DVI adapter to create a DVI connection.) |
| 3 | ATI DVI-to-HDTV adapter (standard dip-switch settings)  |
| 4 | RCA patch cables (available from consumer electronics dealer, not to exceed 50 feet or 15 meters).  |
| 5 | Component video connection on the HDTV  |
| 6 | HDTV (Set to YPbPr input. For information specific to the device, see the HDTV manual.)   |

### 3 Set the ATI HDTV Component Video Adapter DIP switches.

Configure the DIP switches to set the appropriate display mode and aspect ratio. This sets the modes which appear when you select **Show all Modes** in the ATI Control Panel.

#### a) Set the display mode

**Note:** DIP switch 3 is always off (540p is not supported).

**Note:** Set all DIP switches on that correspond to the modes the component input device supports; for further details, consult the manual for the component video input device.

The six DIP switches on the ATI HDTV Component Video Adapter enable four, standard HDTV video modes: 480i, 480p, 720p, and 1080i. The default setting is 480i or 480p, depending upon the component input device. In the following example, 480i, 480p, and 1080i are supported.

Use a small, flat-head screwdriver to set the switches. The up position is on and the down position if off. Set the switches on for all modes that the HDTV or component input device supports.

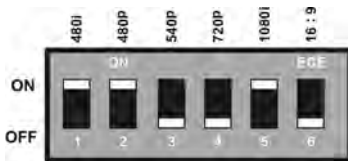

**Display Mode Switch Settings**

#### b) Set the Aspect Ratio.

If the display supports 16:9 aspect ratio, set DIP switch 6 (16:9) on. This switch toggles between 4:3 and 16:9. Off is 4:3.

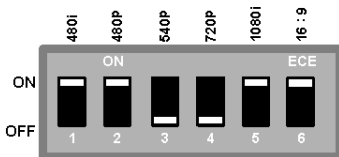

**Aspect Ratio Switch Settings**

In the previous examples, the component input display supports 480i, 480p, 1080i, and 16:9.

- 4 Attach the ATI DVI-to-HDTV component video adapter to the DVI connection on the graphics card.
- 5 Matching the colors on the connections, connect one end of the RCA patch cables to the ATI DVI-to-HDTV component video adapter. Connect the other end of the RCA patch cables to the component video connections on the HDTV.
- 6 Connect one end of a sound cable to the computer sound card. Connect the other end of the cable to the sound input on the HDTV.
- 7 If necessary, configure the HDTV for external audio. For more information, see the documentation that came with the TV.
- 8 Power on the monitor and HDTV, and then power on the computer. The HDTV will not display anything until Windows® starts.
- 9 Configure the HDTV using the ATI Catalyst™ Control Center, Displays Manager.

***Connect to an HDTV or component video device  
(S-Video-to-Component Video using ATI 7-Pin HDTV Output Cable)***

- 1 Before connecting an HDTV, attach a monitor to the computer and install the video drivers.
- 2 Make sure the computer and monitor are off.

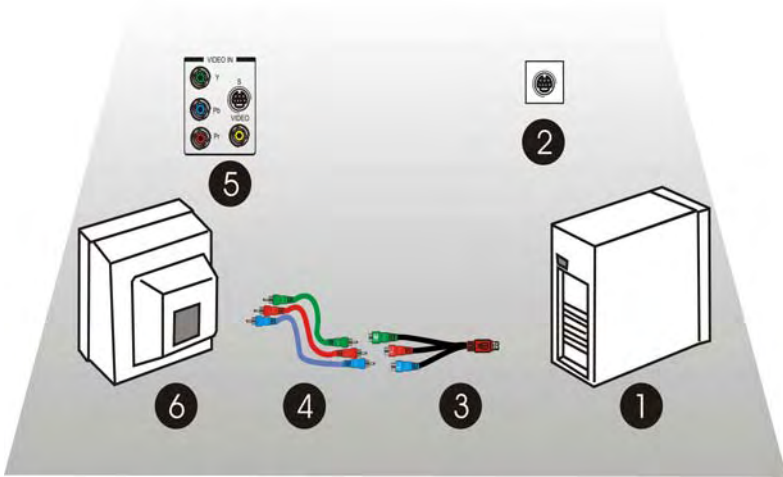

**S-Video to Component Video (using the ATI 9-Pin HDTV Output Cable)**

### Legend

1	Computer
2	S-Video connection on the graphics card
3	ATI 7-Pin HDTV output cable
4	Male RCA patch cables (available from consumer electronics dealer, not to exceed 50 feet or 15 meters.)
5	Component video connection on the HDTV
6	HDTV (Set to YPbPr input. For information specific to the device, see the HDTV manual.)

- 3 Attach the ATI 7-Pin HDTV Output Cable to the S-Video connection on the graphics card.
- 4 Matching the colors on the connectors, connect one end of the RCA patch cables to the ATI 7-Pin HDTV output cable. Connect the other end of the RCA patch cables to the component video connections on the HDTV.
- 5 Connect one end of a sound cable to the computer sound card. Connect the other end of the cable to the sound input on the HDTV.
- 6 If necessary, configure the HDTV for external audio. For more information, see the documentation that came with the TV.

- 7 Power on the monitor and HDTV, and then power on the computer.  
The HDTV will not display anything until Windows® starts.
- 8 Configure the HDTV using the ATI Catalyst™ Control Center, Displays Manager.

### **Connect to a composite video device (S-Video-to-S-Video or Composite Video)**

- 1 Before connecting a composite video device, attach a monitor to the computer and install the video drivers.
- 2 Make sure the computer and monitor are off.

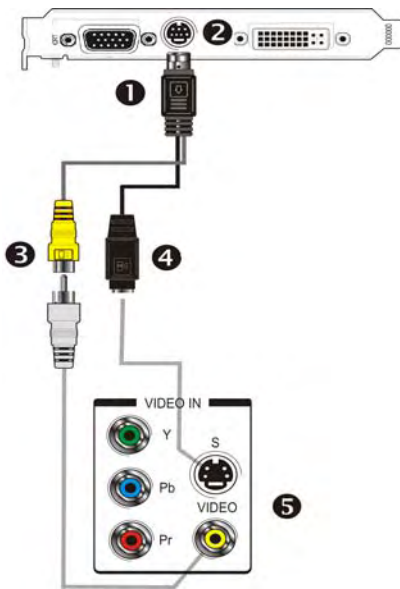

#### **S-Video to S-Video or Composite Video**

#### **Legend**

- |   |  |
|---|--|
| 1 | S-Video connector to graphics card                   |
| 2 | S-Video connection on graphics card                  |
| 3 | Composite video connector                            |
| 4 | S-Video connector                                    |
| 5 | Composite video and S-Video connections on TV or VCR |

- 3** Connect the S-Video connector on the composite video cable to the S-Video connection on the graphics card. Connect the other end of the composite video cable to either the S-Video or composite video connection on the composite video device.
- 4** Power on the monitor and composite video device, and then power on the computer.

The composite video device will not display anything until Windows® starts.

- 5** Configure the composite video device using the ATI Catalyst™ Control Center, Displays Manager.



### Connect to a European video device (S-Video to SCART using composite video adapter)

- 1 Before connecting a European video device, attach a monitor and install the video drivers.
- 2 Make sure the computer and the monitor are off.

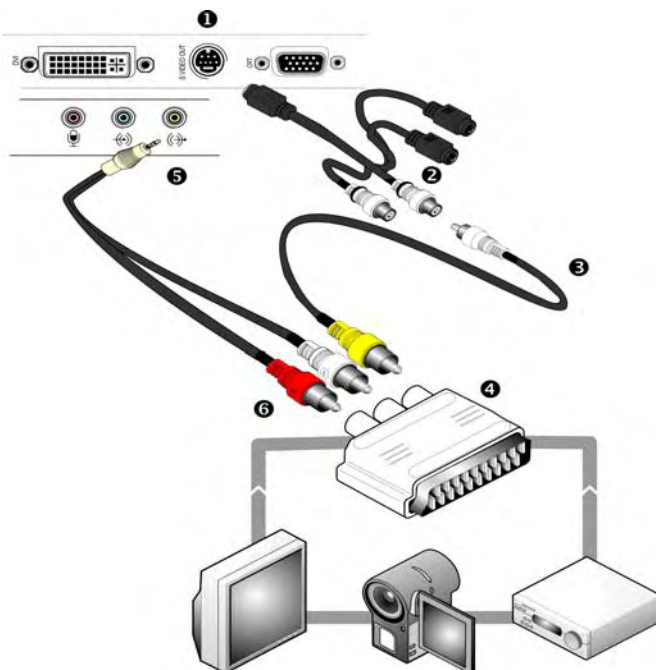

S-Video to SCART connectors

#### Legend

- |   |  |
|---|--|
| 1 | S-Video out connection on graphics card  |
| 2 | S-Video to composite adapter/cable       |
| 3 | Composite cable                          |
| 4 | SCART adapter                            |
| 5 | Audio mini-jack connection on sound card |
| 6 | Left and right RCA audio connectors      |

- 3 If the video device accepts PAL input, you must change the NTSC/PAL setting on the video card to PAL. NTSC is the TV standard used in North America. PAL is the TV standard for most of Europe, Africa, Asia, Japan, South Korea, and the Philippines.

**Note:** You can also change the NTSC/PAL settings through software using the ATI Displays control panel. For more information, see the Help for ATI Displays.

- a) Disconnect the monitor cable from the graphics card.
- b) Remove the graphics card from the computer.
- c) Locate the orange switch on the back of the card.



NTSC



PAL

**Switch Positions for NTSC and PAL**

- d) Use a sharp pencil to move slider switch number 1 as shown in the preceding illustration.
  - e) Re-install the graphics card into the computer and reconnect the monitor.
- 4 Connect the S-Video connector on the S-Video to composite video adapter/cable to the S-Video connection on the graphics card.
  - 5 Connect the other end of the S-Video to composite video adapter/cable to the SCART adapter.
  - 6 Attach the SCART adapter to the video device.
  - 7 Connect one end of a sound cable to the computer sound card. Connect the other end of the cable to the sound input on the TV.
  - 8 If necessary, configure the TV for external audio. For more information, see the documentation that came with the TV.
  - 9 Power on the monitor and TV or VCR, and then power on the computer.  
The TV will not display anything until Windows starts.
  - 10 Configure the TV using the ATI Catalyst™ Control Center, Displays Manager.

## Setting the Windows® Volume Control

For correct audio performance, the sound card line input must be active.

Depending on the operating system you use, choose either the Windows® XP or Windows Vista® procedure:

- **Display the Line Input settings (Windows®)**
- **Display the Line Input settings (Windows Vista®)**

### *Display the Line Input settings (Windows®)*

- 1 On the taskbar, right-click the **Volume** icon, which is usually in the lower-right corner of the desktop.

If the volume icon is not in the System Tray, do the following:

- a) Click **Start** and then click **Control Panel**.
- b) Double-click **Sounds and Audio Devices**.
- c) In the **Volume** tab, select **Place volume icon in the taskbar**.

- 2 Click **Open Volume Controls**.
- 3 If the Line-In volume control is not visible, click **Options**, and then click **Properties**.
- 4 Select the **Line-In** volume check box and then click **OK**.
- 5 If the **Mute** checkbox is selected, clear it to cancel muting.

### *Display the Line Input settings (Windows Vista®)*

- 1 In the taskbar, right-click the **Volume** icon, which is usually in the lower-right corner of the desktop.
- 2 Choose **Recording Devices**, select the **Line In** icon, and then click **Properties**.
- 3 Click the **Levels** tab and then drag the volume control to increase the volume. Click **OK**.

## Using the Avivo™ Video Converter

The wizard-based ATI Avivo™ Video Converter changes a video file from one format to another.

Use the Avivo™ Video Converter when you want to:

- Send video files by E-mail.
- Present video files on a web site.

- Make files compatible with a specific video format.
- Reduce video file size.
- Convert video files for uploading to an Apple® iPod® Video, Sony® PSP, or Windows® Mobile-based Portable Media Center device.

### **Avivo™ Video Converter Formats**

<b>To create</b>	<b>Use this Format</b>
Generic MPEG-1 video files. Standard MPEG-1 and MPEG-2 formats achieve very high compression rates and are portable to most computers.	MPEG-1
Generic MPEG-2 video files. Standard MPEG-1 and MPEG-2 formats achieve very high compression rates and are portable to most computers.	MPEG-2
Generic MPEG-4 video files. Standard MPEG-4 format provides good quality at low bit rates; very high compression is possible.	MPEG-4 (DivX Compatible)
Generic Windows® Media Video files. Windows® Media Video format is best for streaming video.	Windows® Media Video
Video for creating video CDs.	Video CD
Video for creating a super video CD.	Super Video CD
Video for DVD authoring.	DVD
Video for viewing on a Portable Media Center device.	Portable Media Center*
Video for viewing on a Sony® portable gaming device.	Sony® portable gaming device*
Video for viewing on an iPod® Video.	iPod® Video*

\*For details on uploading files to a portable device see the device manufacturer's user's guide or Help.

### **Open the ATI Avivo™ Video Converter**

**Note:** The ATI Avivo™ Video Converter software is not installed if you choose Express install when installing the ATI software and drivers from the installation CD. The ATI Avivo™ Video Converter software is listed in the installation options of the Custom install.

- 1 From the Windows® desktop, click **start**, and then select **Programs > Catalyst Control Centre > Catalyst Control Center - Basic**.
- 2 Click the **Easy Setup Wizards** tab.
- 3 From the list of wizards, choose **Avivo Video Converter**.
- 4 Click **Go**.

The Avivo™ Video Converter Wizard opens.

- 5 Follow the Avivo™ Video Converter wizard instructions.

**Note:** The **Start Over** button returns the wizard to the Easy Setup Wizards page.

### ***Upload video to a video iPod®***

- 1 Start iTunes®.
- 2 In the **File** menu, select **Add File to Library**.
- 3 Navigate to the converted files and drag the converted files to iTunes®.

The converted video files are added to iTunes®.

- 4 Connect a video capable iPod® to the computer.  
iTunes® copies the files to the iPod® automatically.

### ***Upload video to a Windows® Mobile-based Portable Media Center***

- 1 Start Windows®Media Player®, open the **File** menu, select **Add to Library**, and then choose **Add Folder**.
- 2 In the **Add Folder** dialog, browse to and then click the folder where the Portable Media Format files are located.
- 3 Click **OK**.

The video files are added to the Windows®Media Player® library.

- 4 Connect a Portable Media Center device to the computer.
- 5 Click the **Sync** tab and then click **Start Sync**.

### ***Upload video to a Sony® PSP***

**Note:** Make sure to resolve file name duplication before transferring the files to the Sony® PSP.

- 1 Connect a Sony® PSP to the computer using a USB connector.
- 2 Switch on the Sony® PSP.
- 3 Using the Sony® PSP system software, navigate to the top of the **Settings** list and select **USB Connection**.

The system detects a new removable disk drive.

- 4 Transfer the video files to the MP\_ROOT\100MNV01 folder of the Memory Stick Duo™.

# CrossFire™

CrossFire™ is a multi-GPU performance gaming platform, using CrossFire™-ready motherboards and CrossFire™-compatible graphics cards.

CrossFire™ works with all 3D games and applications. If ATI Catalyst™ A.I. is enabled in the ATI Catalyst™ Control Center software, the optimal rendering mode available for the application is automatically selected.

Performance enhancements experienced on a CrossFire™ system depend on the application or game being used. Performance improvements of up to 100% have been recorded. The latest graphics-intensive programs will generally see over 80% performance improvement at high resolutions and high image-quality modes.

## Basic Requirements

The basic requirements of a ATI Radeon™ HD 2600 Series CrossFire™ system are:

- Two ATI Radeon™ HD 2600 Series CrossFire™ graphics cards
- Two internal CrossFire™ bridge interconnects
- A CrossFire™ -ready motherboard
- We recommend a 550-watt power supply or better.

For an up-to-date listing of CrossFire™ certified motherboards and power supplies, and CrossFire™ configurations see:

[ati.amd.com/products/certification](http://ati.amd.com/products/certification)

## Installing CrossFire™ Graphics Cards

The following set of instructions assumes that the PCI Express® Slave graphics card has already been successfully installed in the secondary slot (slot one), and that the primary slot (slot zero) is empty.

**Note:** Consult your system builder or OEM to ensure that your system has an adequate power supply. A 550 watt or greater power supply is recommended.

For an up-to-date listing of CrossFire™ certified motherboards, see

[ati.amd.com/products/certification](http://ati.amd.com/products/certification)

For an up-to-date listing of certified power supplies, see:

[ati.amd.com/certifiedpsu](http://ati.amd.com/certifiedpsu)

### **Install CrossFire™ cards**

- 1 Make sure the computer, monitor, and other peripheral devices are off.
- 2 Unplug the computer power cord and disconnect cables from the back of the computer.

**Caution!** To avoid possible damage to the motherboard, wait approximately 20 seconds after unplugging the power cord before disconnecting a peripheral or removing a component from the motherboard

- 3 Remove the computer cover.

If necessary, consult the computer manual for help removing the cover.

**Caution!** Remember to discharge your body's static electricity by touching the power supply case or the metal surface of the computer chassis.

- 4 Remove any existing graphics cards from the computer.



**Warning!** Some graphics cards can get hot while operating. Wait about five minutes after turning off the computer before touching the card.

- 5 Locate the PCIe™ slots on the motherboard. If necessary, remove the metal backplate cover next to the PCIe™ slot from the computer case.
- 6 Align the new graphics card in the secondary PCIe™ slot next to the existing graphics card and press firmly until the card is fully seated.



## 7 Install the CrossFire™ bridge interconnects.

**Caution!** Always handle the CrossFire™ bridge interconnects by the connector only. Do not push or pull on the flexible cable.

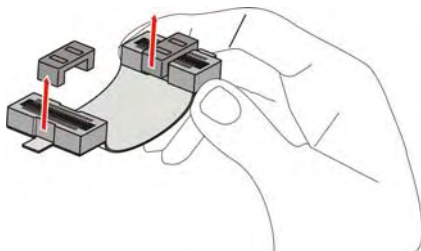

### Proper handling of the CrossFire™ bridge interconnects

- a) Remove protection tags from the connectors at each end of the CrossFire™ bridge interconnects.
- b) Press one end of the CrossFire™ bridge interconnect onto one of the connections on one of the graphics cards.
- c) Press the opposite end of the CrossFire™ bridge interconnect onto corresponding connection of the second graphics card.
- d) Repeat steps b and c above to connect the second CrossFire™ bridge interconnect to the graphics cards.

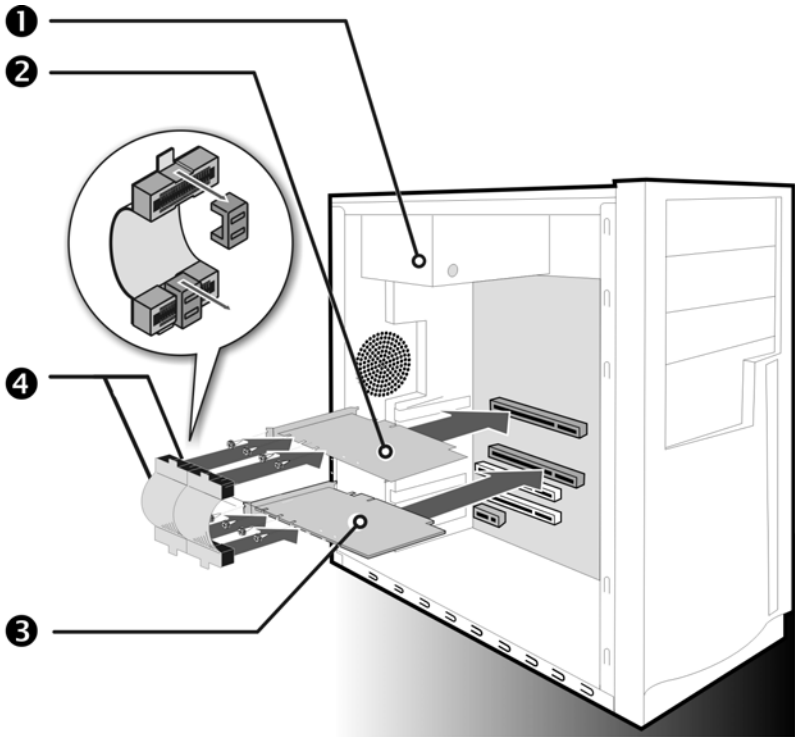

### CrossFire™ connections

#### Legend

- |   |                                     |
|---|-------------------------------------|
| 1 | 550 watt (or better) power supply   |
| 2 | Primary graphics card               |
| 3 | Secondary graphics card             |
| 4 | Two CrossFire™ bridge interconnects |

- 8 Fasten the graphics card securely. Make sure the cables are not interfering with anything inside the computer (for example, a cooling fan) and replace the computer cover.
- 9 Connect the monitor to the graphics card in the primary slot.

- 10 Reconnect any peripherals you have disconnected and plug in the computer's power cord.
- 11 Power on the monitor and then the computer.

## Enabling CrossFire™

To take full advantage of running dual graphics cards, enable and configure CrossFire™ in the ATI Catalyst™ Control Center.

### Start ATI Catalyst™ Control Center

Start ATI Catalyst™ Control Center from one of the following access points:

Access Point	Instructions
<b>Windows® Desktop</b>	<ol style="list-style-type: none"> <li>1. Right-click the Windows® desktop.</li> <li>2. From the short menu, select <b>ATI Catalyst® Control Center</b>.</li> </ol>
<b>Windows® Start Menu</b>	From the Windows® task bar, click <b>Start</b> , and then select <b>Programs &gt; ATI Catalyst™ Control Center</b> .
<b>Windows® System Tray</b>	<ol style="list-style-type: none"> <li>1. Right-click the ATI icon in the Windows® System Tray.</li> <li>2. From the short menu, select <b>ATI Catalyst® Control Center</b>.</li> </ol>
<b>Desktop shortcut</b>	<p>When you first installed the ATI Catalyst® Control Center, the setup wizard provided you with the option of placing a shortcut on the desktop. If you chose this option, you can</p> <ul style="list-style-type: none"> <li>• Double-click the ATI Catalyst® Control Center desktop shortcut.</li> </ul>
<b>Predefined hot keys</b>	Press the predefined combination of keys, <b>Ctrl+Alt+C</b> to launch ATI Catalyst® Control Center, or you can define your own hot key sequence by using the ATI Catalyst® Control Center Hotkey Manager.

### Enable CrossFire™

- 1 Start ATI Catalyst™ Control Center.
- 2 In Advanced View, from the Graphics Settings tree, click CrossFire™.
- 3 Select the **Enable CrossFire™** checkbox.

- 4 Enable ATI Catalyst™ A.I. to automatically select the preferred rendering mode for target applications.

For applications that are not identified in ATI Catalyst™ A.I., or when ATI Catalyst™ A.I. is disabled, default CrossFire™ rendering modes are used. Alternatively, you can enable the Super Anti-aliasing mode in ATI Catalyst™ Control Center.

**Note:** When CrossFire™ is enabled, only one display device is enabled.

**Note:** CrossFire™ Super Anti-Aliasing can be adjusted in the ATI Catalyst™ Control Center 3D settings.

**Note:** GPU Physics is only available when CrossFire™ is inactive. This ensures the highest possible performance. For more information on GPU Physics, see the ATI Catalyst™ Control Center Help.

## Display Configurations

Display support is available through only one display device when CrossFire™ is active. This arrangement ensures the best performance.

If additional displays are required when CrossFire™ is active, use either SurroundView™ (included in the Custom install options on the installation CD) or an additional graphics card.

While CrossFire™ is designed for optimal use on a single display, it is possible to drive multiple monitors using a CrossFire™ system when CrossFire™ is not enabled. On a standard CrossFire™ system, it is possible to drive four separate monitors and still have one of those displays as a dedicated CrossFire™ display. You can add more displays if the motherboard contains an integrated video connection and SurroundView™ is enabled.

# Reference

This topic provides information on troubleshooting, updating AGP/ motherboard chipset drivers, reinstalling drivers, where to get additional accessories, and how to register your product, plus warranty and compliance information.

## Troubleshooting

The following troubleshooting tips may help if you experience problems. For more help, contact customer care at [ati.amd.com/support](http://ati.amd.com/support) or your PC manufacturer.

General Troubleshooting	
Problem	Possible solution
Computer does not boot-up properly	<ul style="list-style-type: none"> <li>• Verify that the installation instructions were properly followed.</li> <li>• Check that the card is properly installed in the system and connected to the monitor.</li> <li>• If you have problems during start-up, restart the computer in <b>Safe Mode</b>. While starting Windows® XP, press and hold <b>F8</b> until you see the Windows® Advanced Options Menu. Use the arrow keys to select <b>Safe Mode</b> and then press <b>Enter</b>.</li> <li>• Check the system configuration utility of the operating system for the interrupt assignments.</li> <li>• If the computer has on-board graphics capability, you may need to disable it on the motherboard. For more information, see the computer documentation.</li> </ul>
No display	<p>Make sure:</p> <ul style="list-style-type: none"> <li>• The card is seated properly in its expansion slot.</li> <li>• The monitor cable is securely fastened to the card.</li> <li>• The monitor and computer are plugged in and receiving power.</li> <li>• You selected the appropriate monitor when you installed the driver.</li> <li>• If you are installing an AGP graphics card, make sure you have the latest version of the AGP Motherboard/ Chipset drivers.</li> </ul>

## General Troubleshooting

Problem	Possible solution
<p><b>Screen defects appear</b></p>	<ul style="list-style-type: none"> <li>• Check if the monitor supports the resolution, horizontal (kHz) and vertical (Hz) refresh rates as required by the graphics card.</li> <li>• Check the current resolution, refresh rate, and color depth settings in the <b>Settings</b> and <b>Monitor</b> tabs in the <b>Display Properties</b> dialog.</li> </ul> <p><b>Caution!</b> Ensure that both video card and monitor support resolution and refresh rates you select. Incompatible resolution/refresh rate selection may result in monitor damage. Refer to the monitor documentation for recommended resolutions and refresh rates.</p>
<p><b>Off-center screen image, odd colors or no picture</b></p>	<ul style="list-style-type: none"> <li>• Try adjusting the brightness, sharpness, contrast, and color balance controls of the monitor.</li> <li>• Try adjusting the centering and positioning controls of the monitor to position the picture on the screen</li> <li>• Set the monitor RGB inputs (and sync switches, if this option is available) to 75 ohms, with the sync set to external.</li> <li>• LCD monitor users: Refer to the monitor documentation for the appropriate cable and connector to plug into the DVI-I connector on the graphics card.</li> </ul>
<p><b>Operating system warns that video card isn't properly configured</b></p>	<ul style="list-style-type: none"> <li>• Remove and re-install the ATI drivers for the graphics card.</li> <li>• Check the driver installation and make sure that all software is correctly loaded corresponding to the operating system and applications.</li> </ul>

<b>CrossFire™-Specific Troubleshooting</b>	
<b>Problem</b>	<b>Possible solution</b>
<b>CrossFire™ is not functioning</b>	<p>In order for CrossFire™ to function, the CrossFire™ bridge interconnects must correctly connect the CrossFire™ graphics cards.</p> <ol style="list-style-type: none"> <li>1. Connect one end of the CrossFire™ bridge interconnect to the internal VMO connection on one of the cards.</li> <li>2. Connect the other end of the CrossFire™ bridge interconnect to the corresponding internal VMO connection of the other card.</li> <li>3. Repeat Steps 1 and 2 to connect the second CrossFire™ bridge interconnect.</li> <li>4. Connect the DVI-I connection on the primary CrossFire™ graphics card to your monitor.</li> </ol>
<b>“Before CrossFire™ can be enabled, you need to close the 3D application or video playback that is currently running.”</b>	<p>You cannot enable CrossFire™ in the ATI Catalyst™ Control Center if a 3D application, game, or video playback, such as a DVD movie, is running. Close all open 3D applications, games, and movie player applications, and then enable CrossFire™.</p>
<b>CrossFire™ Aspect in ATI Catalyst™ Control Center is Not Displayed</b>	<p>Ensure the CrossFire™ bridge interconnects have been correctly attached. The CrossFire™ aspect is only available when the two ATI Radeon™ HD 2600 Series graphics cards have been correctly installed and connected together.</p>
<b>“CrossFire™ Is Currently Unavailable.”</b>	<p>This error occurred because CrossFire™ did not correctly detect your graphics hardware or there is a problem with the software.</p> <p>Make sure:</p> <ul style="list-style-type: none"> <li>• The graphics cards are installed correctly.</li> <li>• The interconnects are installed correctly.</li> <li>• All running 3D applications are closed.</li> <li>• You restart the ATI Catalyst™ Control Center.</li> </ul> <p>For information on installing the software see the Getting Started Guide that came with your graphics card.</p>
<b>Screen rotation function does not work or is unavailable</b>	<p>Screen rotation is not an available feature on CrossFire™ systems.</p>

<b>HDTV/HDTV Adapter Troubleshooting</b>	
<b>Problem</b>	<b>Possible solution</b>
<b>The colors on my TV display are incorrect</b>	<ul style="list-style-type: none"> <li>• Ensure that the connections between the Component Video Adapter and your HDTV are correct (Y=Green, Pb=Blue, Pr=Red).</li> </ul>
<b>There is no display on my TV</b>	<ul style="list-style-type: none"> <li>• Your TV will not display anything until Windows® starts; this may take several minutes.</li> <li>• Ensure that the HDTV Component Video Adapter is properly connected and the TV input is correctly configured, and then restart your computer.</li> </ul>
<b>DVDs will not play in 720p or 1080i modes</b>	<ul style="list-style-type: none"> <li>• Copy-protected DVDs restrict playback to 480i and 480p modes.</li> </ul>
<b>I can't see the entire display</b>	<ul style="list-style-type: none"> <li>• If your component input device supports it, try 720p mode.</li> </ul>
<b>The display appears tilted</b>	<ul style="list-style-type: none"> <li>• Consult the HDTV user's manual.</li> </ul>
<b>My CRT display is green</b>	<ul style="list-style-type: none"> <li>• The computer is in component output mode. Restart the computer with the CRT monitor connected.</li> </ul>

## Determine the System Card Bus Type

There are two possible card bus types, AGP and PCIe™. If you have an AGP card you may need to update the motherboard and chipset drivers.

- 1 Look at the motherboard and card.
- 2 Using the illustration below for comparison, determine whether you have AGP or PCIe™ connectors.





AGP and PCIe™ graphics cards and system bus connectors

---

### Legend

---

- |   |                                     |
|---|-------------------------------------|
| 1 | AGP card and AGP expansion slot     |
| 2 | PCIe™ card and PCIe™ expansion slot |
- 

- 3 If you have AGP connectors and the graphics card is not working correctly, you may need to update the motherboard and chipset drivers for the computer.

## Updating your AGP Motherboard/Chipset Drivers

**Note:** This section applies only if you are installing an AGP graphics card.

If your computer has an AGP bus, you may need to update the motherboard AGP drivers before installing a new graphics card.

The AGP drivers for your motherboard enable AGP functionality for the motherboard chipset. These drivers may be referred to using any of the following names:

- AGP Driver
- AGP Miniport
- AGP VXD Driver
- Chipset Driver
- GART Driver
- VGART

Often you will see the name of a motherboard chipset in connection with these terms. For example:

- ALi GART Driver
- AMD AGP Miniport
- Intel VGART
- VIA AGP Driver

## **Obtain AGP drivers for your motherboard/chipset**

If you experience problems with the AGP chipset drivers, you may need a software update from the motherboard or chipset manufacturer.

**Note:** Installing the wrong AGP motherboard/chipset drivers may prevent Windows® from launching successfully. Make sure that the drivers you install are designed to function correctly with the motherboard. If you are uncertain, consult with the motherboard manufacturer for advice.

If you purchased a new motherboard, you likely received a CD that contains these drivers.

You can also locate these drivers on the motherboard manufacturer's Web site.

### ***Update AGP drivers for the motherboard/chipset***

- 1** Navigate to the Windows® **Control Panel** and open **System**.
- 2** In the **System Properties** dialog, click the **Hardware** tab.
- 3** Click **Device Manager**.
- 4** Select **System Devices**.
- 5** Scroll through the list of System Devices until you find a listing for the AGP controller. The chipset manufacturer's name will appear as the device name.

- 6 To determine the manufacturer, click the [AGP device name] > **Driver** > **Driver Details**:

Sample Motherboard/Chipset Manufacturers	
Advanced Micro Devices (AMD)	<a href="http://www.amd.com">www.amd.com</a>
VIA Technologies	<a href="http://www.viaarena.com">www.viaarena.com</a>
Acer Laboratories (ALI)	<a href="http://www.ali.com.tw">www.ali.com.tw</a>
Silicon Integrated Systems (SIS)	<a href="http://www.sis.com">www.sis.com</a>
Intel Technologies	<a href="http://support.intel.com">support.intel.com</a>
General Motherboard/chipset information	<a href="http://www.motherboards.org">www.motherboards.org</a>

## Reinstalling Drivers

You can install new drivers or reinstall existing drivers if there was a Windows® conflict.

**Note:** To ensure you have access to all the new features and performance options, download the latest driver from [ati.amd.com/support/driver.html](http://ati.amd.com/support/driver.html).

Reinstall the drivers at any time using the ATISSETUP utility located on the ATI installation CD. The ATISSETUP utility usually starts automatically when you insert the ATI installation CD into your computer after the operating system has started.

**Note:** Remove old graphics drivers before reinstalling the driver.

### ***Manually reinstall drivers***

If CD auto-run is not enabled and the ATISSETUP utility does not start automatically, follow these steps.

- 1 Double-click the CD, double-click **ATISSETUP**, and then click **OK**.
- 2 Follow the on-screen instructions and then choose either **Express** or **Custom Install**.

**Note:** Not all software components are installed using the Express installation; only the driver and ATI Catalyst™ Control Center are installed. Custom installation allows you to select individual software components for installation, such as HydraVision™ and the Avivo™ Video Converter.

**Tip!** If the installer fails to install the driver or you have conflicts, you can download the latest software from [ati.amd.com](https://ati.amd.com) and then install the software.

## Product Registration

To activate your warranty and obtain product support through Customer Care, register your graphics card at:

[ati.amd.com/online/registration](https://ati.amd.com/online/registration)

Customer Care will work to resolve your issue and help you to get the graphics card product up and running. If your issue is not resolved, our technicians will determine whether the difficulty you are experiencing is the result of the ATI product, whether the product contains a defect, and whether the product is under warranty.

- Customer Care is unable to assist with refunds, returns, or exchange specific inquiries. If resolving the problem being experienced is critical to your decision to keep the product, it is your responsibility to ensure that you know and are within the period of time your reseller will allow for refunds, returns or exchange.
- AMD is not responsible for any expense incurred accessing Customer Care. It is expected that customers will review the expense associated with the available support options and will choose the method that best meets their needs and budget.
- Customer Care reserves the right to limit support options for products that are not registered or are at End of Life.

## Additional Accessories

Additional and replacement cables, installation CD-ROMs, manuals, and other accessories for AMD products can be purchased from the online AMD store at:

[ati.amd.com/online/accessories](http://ati.amd.com/online/accessories)

# Compliance Information

This section details the compliance information for this product.

## FCC Compliance Information

This ATI Radeon™ HD 2600 Series product complies with FCC Rules part 15. Operation is subject to the following two conditions

- This device may not cause harmful interference.
- This device must accept any interference received, including interference that may cause undesired operation.

This equipment has been tested and found to comply with the limits for a Class B digital device, pursuant to Part 15 of the FCC Rules. These limits are designed to provide reasonable protection against harmful interference in a residential installation. This equipment generates, uses and can radiate radio frequency energy and, if not installed and used in accordance with manufacturer's instructions, may cause harmful interference to radio communications. However, there is no guarantee that interference will not occur in a particular installation. If this equipment does cause harmful interference to radio or television reception, which can be determined by turning the equipment off and on, the user is encouraged to try to correct the interference by one or more of the following measures:

- Re-orient or relocate the receiving antenna.
- Increase the separation between the equipment and receiver.
- Connect the equipment to an outlet on a circuit different from that to which the receiver is connected.
- Consult the dealer or an experienced radio/TV technician for help.

The use of shielded cables for connection of the monitor to the graphics card is required to ensure compliance with FCC regulations. Changes or modifications to this unit not expressly approved by the party responsible for compliance could void the user's authority to operate this equipment.

## Industry Canada Compliance Statement

ICES-003 This Class B digital apparatus complies with Canadian ICES-003.

Cet appareil numérique de la Classe B est conforme à la norme NMB-003 du Canada.

For further compliance information:

Advanced Micro Devices, Inc.  
62 Forest Street.  
Marlborough, MA  
01752  
USA  
508-303-3900

## CE Compliance Information

EMC Directive 89/336/EEC and amendments 91/263/EEC, 92/31/EEC and 93/68/EEC, Class B Digital Device EN 55022:2003/CISPR 22 Class B, Limits and Methods of Measurement of Radio Interference Characteristics Information Technology Equipment.

EN 55024:1998/CISPR 24:1997 +A1:2001 +A2:2003, Immunity of Information Technology Equipment (ITE), including EN 61000-4-2, EN 61000-4-3, EN 61000-4-4, EN 61000-4-5, EN 61000-4-6

## Informations de conformité de la CE

Directive EMC 89/336/CEE et amendements 92/31/CEE et 93/68/CEE, pour dispositif numérique de Classe B.

EN 55022:2003/CISPR 22:1997, - Classe B - Limites et méthodes de mesure des caractéristiques d'interférences radiophoniques, Matériel des technologies de l'information.

EN 55024:1998/CISPR 24:1997 +A1:2001 +A2:2003, Norme sur l'immunité de matériel des technologies de l'information, et comprenant EN 61000-4-2, EN 61000-4-3, EN 61000-4-4, EN 61000-4-5, EN 61000-4-6

## Electrical Safety

73/23/EEC - The Low Voltage Directive

IEC 60950-1:2001, IEC 60950:1999, 3rd Edition - Safety of Information Technology Equipment

BS EN60950-1:2002, BS EN60950:2000, 3rd Edition UL 60950-1:2003, UL 60950:2000, 3rd Edition CAN/CSA C22.2 No. 60950-1:2002, CAN/CSA C22.2 No. 60950-00, 3rd Edition (2000)

To meet UL safety requirements, the computer's maximum room temperature should not exceed 40° C.



## Waste Electrical and Electronic Equipment (WEEE) Directive Compliance

This product was manufactured by Advanced Micro Devices, Inc.







# Index

## Numerics

- 102 part number 3
- 1080i 22
- 16:9 22
- 3D 33, 41
- 4:3 22
- 480i 22, 42
- 480p 22, 42
- 540p 22
- 720p 42

## A

Accessories 47

Adapters

- 9-Pin Cable for Video Input/Video Output* 8
- 9-Pin HDTV output cable* 24
- 9-pin HDTV Output Cable* 8
- Composite video connector* 25
- DVI to VGA* 8
- DVI-to-HDMI* 8, 18
- DVI-to-HDTV* 8, 21
- DVI-to-VGA* 8
- SCART* 27

Add/Remove Programs 4

AGP 42

AMD Athlon 1

Anti-aliasing 38

ATI Catalyst Control Center 14

ATIS SETUP utility 45

Avivo Video Converter 11, 31

## B

Brightness 40

## C

Capture video 10

Card bus types 42

Catalyst® Control Center 37

Catalyst A.I. 33, 38

Catalyst Control Center 10, 11, 13, 14, 33, 38, 41

Chipset drivers 42

Color 10, 40

Compliance information 39, 48

Connections

- DVI-I Dual Link* 7
- HDMI* 7
- S-Video* 7
- VGA* 7
- VIVO* 7

Contrast 40

Control Panel 4, 10

Copy-protection for DVDs 42

CrossFire 1, 8, 9, 33, 34, 37, 38, 41

CrossFire bridge interconnects 41

CrossFire ready 33

CrossFire-Specific  
*Troubleshooting* 41

CRT 42

Customer Care 46, 47

## D

Dashboard 13

DIP switches 22

Displays Manager 19

distortion

- causes of* 15

Dot pitch 16

Drivers

- chipset* 42
- reinstalling* 45
- uninstall* 4

DTV(HDMI) 19

DVD 1, 4, 41

DVI 18, 40, 41

DVI-to-HDTV adapter 21

## E

Enable CrossFire 37

## F

F1 help 14

FCC Compliance 48

**G**

Games

*TV display* 16**H**

HDMI 8, 9, 18, 19

HDMI™ 18

HDTV 17, 18, 21

HDTV Adapter Troubleshooting  
42

Help 4, 14, 47

High Definition Television  
(HDTV) 42

Hot key 14, 37

HydraVision 11

**I**

Industry Canada Compliance 48

Input and output adapters

*DVI to VGA adapter* 8

iPod 30, 31

iTunes 31

**M**

Memory Stick Duo 32

Motherboard 1, 42

**N**

NTSC/PAL setting 28

**P**

PAL 28

PCI Express 1, 33

PCIe 42

Pentium 1

Power supply 1, 33

Primary slot 33

Product Registration 46

**R**

Red Green Blue (RGB) 40

Refresh Rate 10, 40

Registration 3

Rendering modes 38

Resolution 10, 16, 40

Rotation 41

**S**

Safe Mode 39

Safety instructions iii

Screen rotation 41

Secondary slot 33

Serial number 3

Shortcut 14, 37

Slave graphics card 33

Software installation 11

Sony PSP 30, 31

Super Anti-aliasing 38

SurroundView 9, 11, 38

S-Video 27

System requirements 1

**T**

Troubleshooting 42

*CrossFire-specific* 41*HDTV adapter* 42*Reference* 39

TV 15, 16

TV display 15, 16

*games* 16*troubleshooting* 42

TV Out 15

**U**Uninstalling old graphics card  
software 4**V**

VGA 8

VHDCI 41

Video 27, 40, 42

Video capture 10

Video file conversion 30

VMO 41

Volume control 29

**W**

Warranty 39, 47

Waste Electrical and Electronic  
Equipment (WEEE) Compliance  
49

Windows 10, 29, 45

Windows Advanced Options  
Menu 39

Windows Vista 4, 29

Windows volume control 29

Windows XP 4, 39