

# DAEWOO

# MICROWAVE CONVECTION/GRILL OVEN

KOC-924T0S / KOC-924T5S

OWNER'S  
MANUAL

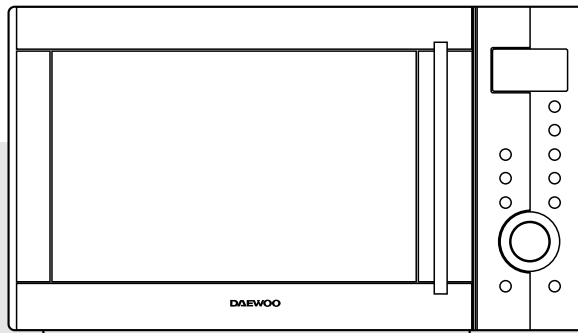

Before operating this oven, please read these manual completely.

## PRECAUTIONS TO AVOID POSSIBLE EXPOSURE TO EXCESSIVE MICROWAVE ENERGY

- (a) **Do not attempt to operate this oven with the door open** since open-door operation can result in harmful exposure to microwave energy. It is important not to defeat or tamper with the safety interlocks.
- (b) **Do not place any object** between the oven front face and the door or allow soil or cleaner residue to accumulate on sealing surfaces.
- (c) **WARNING** : If the door or door seals are damaged, the oven must not be operated until it has been repaired by a trained person: (1) door (bent), (2) hinges and latches (broken or loosened), (3) door seals and sealing surfaces.
- (d) **WARNING** : It is hazardous for anyone other than a trained person to carry out any service or repair operation which involves the removal of any cover which gives protection against exposure to microwave energy.
- (e) **WARNING** : Liquids or other foods must not be heated in sealed containers since they are liable to explode.
- (f) **WARNING** : Only allow children to use the oven without supervision when adequate instructions have been given so that the child is able to use the oven in a safe way and understands the hazards of improper use.

## TABLE OF CONTENTS

• INSTALLATION AND EARTHING INSTRUCTIONS .....	2
• IMPORTANT SAFETY INSTRUCTIONS .....	3
• WHICH UTENSILS CAN BE USED IN THE OVEN? .....	4
• CONTROL PANEL .....	5
• ACCESSORIES .....	6
• BEFORE OPERATION .....	7
SETTING THE CLOCK .....	7
CHILD LOCK AND POWER SAVE MODE .....	8
• OPERATION .....	9
MICROWAVE COOKING .....	9
GRILL COOKING .....	10
CONVECTION COOKING (with pre-heat) .....	11
CONVECTION COOKING (traditional cooking) .....	12
COMBINATION COOKING .....	13
WEIGHT DEFROST .....	14
TIME DEFROST .....	14
AUTO COOK .....	15
SPEEDY COOK .....	16
TO STOP THE OVEN WHILE THE OVEN IS OPERATING .....	16
ABNORMAL MESSAGES .....	16
ARCING .....	16
• GENERAL GUIDELINES .....	17
• KEEP THE OVEN CLEAN .....	18
• BEFORE CALLING FOR SERVICE .....	19
• QUESTIONS AND ANSWERS .....	20
• SPECIFICATIONS .....	20

# INSTALLATION AND EARTHING INSTRUCTIONS

## How to examine your microwave oven after unpacking.

Unpack oven, remove all packing material, and examine the oven for any damage such as dents, broken door, latches or cracks in the door. Do not remove the film from inside the door. Notify dealer immediately if the oven is damaged. Do not install if the oven is damaged.

## Where to place your microwave oven.

1. Place the oven on a flat and stable surface.
2. Surface of the oven is protected by a plastic film which should be removed before using.
3. Leave space behind and sides and upper of the oven. All air vents should be kept a clearance.  
If all vents are covered during operation, the oven may overheat and, eventually, lead to oven failure.
4. Keep away from radio and TV sets. If the oven is located close to a TV, radio interference may result.
5. Keep away from heating appliances and water taps. Keep the oven away from hot air, steam or splash when choosing a place to position it, or the insulation might be adversely affected and breakdowns occur.
6. The minimum height of free space necessary above the top surface of the oven is minimum 170mm.

## Prior to use (If your oven has a grill element)

In order to protect your oven during transportation and storage, the grill element is covered with a protective coating. To remove this coating the grill element must be heated for 5 minutes. This procedure will produce some bad odours as the protective coating on the element disappears.

To remove the coating, use the following procedures:

1. Place an overproof and microwave safe bowl, containing 200cc of water or more, in the oven.
2. Press the convection button.
3. Set the time to 5 minutes.
4. Press the start button.
5. When the 5 minutes has elapsed, an acoustic signal sounds.

### Note:

The protective coating has now been removed and the oven is ready to use. Please be aware that your oven now is very hot.

6. Open the oven door and remove the bowl with water (use oven gloves when removing the bowl).

## CHILD LOCK

To prevent child from operating the oven, install the childlock key.

1. Touch Stop/Clear button for 3 seconds.  
Indicator lock is indicated and all buttons do not operate.
2. Touch Stop/Clear button for 3 seconds once again, then childlock is canceled.

- **WARNING:** Only allow children to use the oven without supervision when adequate instructions have been given so that the child is able to use the oven in a safe way and understands the hazards of improper use.

## Electrical Connection

**WARNING-THIS APPLIANCE MUST BE EARTHED.**

**REFER TO RATING PLATE FOR VOLTAGE AND CHECK THAT THE APPLIANCE VOLTAGE CORRESPONDS WITH THE SUPPLY VOLTAGE IN YOUR HOME.**

The flexible mains lead must be correctly connected, as below, to a three pin plug of not less than 13 AMP capacity. You must use a 3 pin plug which should be marked with the number BS 1363 and it should be fitted with 13 AMP fuse marked with the number BS 1362.

We recommend the use of good quality plugs and wall sockets that can be switched off when the machine is not in use.

**IMPORTANT-**The wires in the mains lead fitted to this appliance are coloured in accordance with the following code

GREEN AND YELLOW-EARTH  
BLUE-NEUTRAL  
BROWN-LIVE

As the colour of the wires in the mains lead of this appliance may not correspond with the coloured markings identifying the terminals in your plug, proceed as follows:

### Power supply

- Check your local power source. This oven requires a current of approximately 15(12)amperes, 230V 50Hz.
- Power supply cord is about 1.2 meters long.
- The voltage used must be the same as specified on this oven. Using a higher voltage may result in a fire or other accident causing oven damage. Using low voltage will cause slow cooking. We are not responsible for damage resulting from use of this oven with a voltage of ampere fuse other than those specified.
- If the supply cord is damaged, it must be replaced by the manufacturer or its service agent or a similarly qualified person in order to avoid a hazard.

The wire which is coloured GREEN AND YELLOW must be connected to the terminal in the plug which is marked with the letter "E" or the earth symbol  $\perp$  or coloured GREEN AND YELLOW, or GREEN.

The wire which is coloured BLUE must be connected to the terminal which is marked with the letter "N" or coloured BLACK, or BLUE.

The wire which is coloured BROWN must be connected to the terminal which is marked with the letter "L" or coloured RED, or BROWN.

If the terminals in the plug are unmarked or you are in any doubt as to the correct connections, consult a qualified electrician.

If you do not make the proper electrical connections you will damage your microwave oven and possibly injure yourself. Neither the manufacturer nor the supplier are liable if this happens.

### MOULDED PLUGS

Should it be necessary to remove a moulded on plug from the mains cable, it should be cut off and replaced with a suitable replacement.

The moulded plug cannot be used for any other appliance, therefore remove the fuse and dispose immediately and safely to prevent anyone, especially children from plugging it in to a wall socket, which will create a safety hazard.

Should the mains lead ever require replacement, it is essential that this operation be carried out by a qualified electrician and should only be replaced with a flexible cord obtained from the manufacturer.

### **Applicable only if moulded plug is fitted.**

After replacement of a fuse in the plug, the fuse cover must be refitted. If the fuse cover is lost, a replacement cover is obtained. The colour of the correct replacement fuse cover is that of the coloured insert in the base of the plug or the colour that is embossed in words in the base of the plug recess or elsewhere on the plug. Always state this colour when ordering a replacement fuse cover.

Only 13 amp replacement fuses which are ASTA approved to BS 1362 should be fitted

## IMPORTANT SAFETY INSTRUCTIONS

When using electrical appliances, basic safety precautions should be followed, including the following:

**WARNING-**To reduce the risk of burns, electric shock, fire, injury to persons or exposure to excessive microwave energy:

1. Read all instructions before using the appliance.
2. Read and follow the specific "PRECAUTIONS TO AVOID POSSIBLE EXPOSURE TO EXCESSIVE MICROWAVE ENERGY", found on page 1.
3. This appliance must be earthed. Connect only to a properly installed wall socket.
4. Install or locate this appliance only in accordance with the provided installation instructions.
5. Some products such as whole eggs and sealed containers for example, closed glass jars-may explode and should not be heated in this oven.
6. Use this appliance only for its intended use as described in this manual.
7. As with any appliance, close supervision is necessary when used by children.
8. Do not operate this appliance if it has a damaged cord or plug, if it is not working properly, or if it has been damaged or dropped.
9. This appliance should be serviced only by qualified service personnel. Contact the nearest authorized service facility for examination, repair or adjustment.
10. Do not cover or block any openings on this appliance.
11. Do not use outdoors.
12. Do not immerse cord or plug in water.
13. Keep cord away from heated surfaces.
14. Do not let cord hang over edge of table or counter.
15. When cleaning surfaces of door and oven that meet when the door closes, use only mild, nonabrasive soaps or detergents with a sponge or soft cloth.
16. To reduce the risk of fire in the oven cavity:
  - (a) Do not overcook food. Carefully attend appliance if paper, plastic, or other combustible materials are placed inside the oven when cooking food.
  - (b) Remove wire twist-ties from bags before placing bag in oven.
  - (c) If materials inside the oven should ignite, keep oven door closed, turn oven off, and disconnect the power cord, or shut off power at the fuse or circuit breaker panel.
17. Do not use this appliance to heat corrosive chemicals (for example, sulfides and chlorides). Vapors from such corrosive chemicals may erode the contacts and springs of the safety interlock switches and render them inoperable.
18. The contents of feeding bottles and baby jars must be stirred or shaken and the temperature is to be checked before consumption to avoid burns.
19. The appliance must be positioned so that the plug is accessible.

## SAVE THESE INSTRUCTIONS

### General Use

Listed below are, as with all appliances, certain rules to follow and safeguards to assure top performance from this oven:

1. Do not use the oven for any reason other than food preparation, such as for drying clothes, paper, or any other nonfood items or for sterilizing purposes. They may catch on fire.
2. Do not use the oven when empty, this could damage the oven.
3. Do not use the oven cavity for any type of storage, such as papers, cookbook, cookware, etc.
4. Do not operate the oven without the turntable tray in place. Be sure it is properly sitting on the rotating base.
5. Be caution when removing the turntable tray after cooking meats that may have caused an accumulation of grease in the tray.
6. Unlike microwave-only ovens, this oven may become hot on the cabinet and oven door. Always use hot pads or oven mitts when placing or removing food and/or accessories from the oven. Be cautions about touching parts other then control panel during or immediately following grill or combination cooking.
7. If the oven is hot from combination cooking, do not use plastic or Styrofoam cookware for microwave cooking. They may melt.
8. Do not use recycled paper products for cooking. They may contain impurities which could cause sparks and/or fires when used during cooking.
9. Do not continue to cook with metal utensils if sparking appears. See "Accessories" section on page 6 for proper use of cookware.
10. Do not leave the oven unattended during short cooking times. Overcooking and fire may result.
11. Do not cook eggs in the shelf, as they will explode. Occasionally a poached egg may burst during microwave cooking. Be sure to cook covered, and let stand one minute after cooking before removing the cover.
12. Do not cook any food surrounded by a membrane, such as egg yolks, potatoes, chicken livers, etc., without first piercing them several times with a fork.
13. Do not pop popcorn except in a microwave approved popcorn bag or in a commercial package recommended especially for microwave ovens. Never try to popcorn in a paper bag. If oil is used while making popcorn, overcooking may cause smoke and, eventually, fire.
14. Do not attempt to operate this appliance with the door open.
15. Do not attempt to remove covers, panels, etc.
16. Look at the oven from time to time when food is heated or cooked in disposable containers of plastic, paper or other combustible materials.
17. If smoke is observed, switch off or unplug the appliance and keep the door closed in order to stifle any flames.
18. Microwave heating of beverages can result in delayed eruptive boiling, therefore care has to be taken when handling the container.

## TO AVOID EXPLOSION AND SUDDEN BOILING

### WARNING

When heating liquids, e.g. soups, sauces and beverages in your microwave oven, overheating the liquid beyond boiling point can occur without evidence of bubbling: This could result in a sudden boil over of the hot liquid. To prevent this possibility the following steps should be taken:

- Avoid using straight sided containers with narrow necks.
- Do not overheat.
- Stir the liquid before placing the container in the oven and again halfway through the heating time.
- After heating, allow to stand in the oven for a short time, stir or shake them again carefully and check the temperature of them before consumption to avoid burns (especially, contents of feeding bottles and baby food jars).

### 1. Eggs

Never cook eggs in their shells. Steam will build up inside the shell during cooking and the egg will explode.

If you want to cook or reheat eggs which have not been broken up by scrambling or mixing, you must always pierce the yolks or these will also explode. You should slice shelled hard boiled eggs before you reheat them in your microwave oven.

### 2. Piercing

Always pierce food which has a skin or membrane, for example, potatoes, tomatoes, apples, sausages etc. If you don't pierce them, steam will build up inside and they may explode.

### 3. Lids

Always remove the lids of jars and containers and take away food containers, before you cook using your microwave oven. If you don't, then steam and pressure might build up inside and cause an explosion even after the microwave cooking has stopped.

## WHICH UTENSIL CAN BE USED IN THE OVEN?

Before use, the user should check that utensils are suitable for use in microwave ovens.

Material	Grill & Convection cooking	Microwave cooking	Combined cooking
Glass (general)	No	Yes (1)	No
Glass (heat resistant)	Yes	Yes	Yes
Glass-ceramic and ceramic (heat resistant)	Yes	Yes (1)	Yes (1)
Earthenware	Yes	Yes	Yes
China (heat resistant)	Yes	Yes	Yes
Plastic (general)	No	Yes (2)	No
Plastic (heat resistant)	Yes (2)	Yes (2)	Yes (2)
Aluminium foil containers /aluminium foil	Yes	Yes (3)	Yes
Metal baking tins	Yes (4)	No	Yes (4)
Metal (pots.pans, etc)	Yes	No	No
Paper	No	Yes	No

- Without metal parts or metal trims.
- Some plastics are heat-proof only to certain temperatures. Check carefully!
- It is possible to use aluminium foil to shield delicate areas of food (this prevents over-cooking).
- Metal tins can be used in the combination methods, however if these are very deep, they will greatly reduce the efficiency, as metal shields the microwave energy from the food.

### Microwave function only

Utensils and cooking containers used in a microwave oven should be of a material that does not act as a barrier to microwave energy. Generally this means that you should cook in either (paper), plastic, glass or ceramic. Metal pans reflect microwave energy and inhibit cooking, and should not be used. In addition to material, the shape of the container should also be considered. Round oval shapes give the most even cooking. Square or rectangular containers may over-cook foods in the corners because more energy is absorbed there. Shallow containers give more even cooking results.

Utensils made of china and ceramic excellent to use in your microwave oven. Most types of glass are also very good. Lead crystal glass can crack and should therefore, not be used. Plastics and paper can also be used, provided they can withstand the temperature of the heated food. For cooking only use plastics, which will withstand a temperature of over 120°C, e.g. polypropene and polyamide. Some plastic materials, e.g. melamine, will be heated by the microwave, and be damaged. To find out if a certain container is suitable, the following simple test can be made:

Place the empty container and a glass of water inside the microwave oven. The water is needed because the oven must not be operated empty or with empty containers only. Let the oven work on full power for one minute. A suitable container will only be lukewarm.

Metal containers, e.g. saucepans or frying pans should not be used in microwave ovens. Nor should plates or vessels with decorations be used since metal e.g. gold, might be part of the decoration and such decorations will be damaged.

Small pieces of aluminium foil can be used, but only to shield the areas that would over-cook (e.g. for covering chicken wings, leg tips and fish tails) but the foil must not touch the side of the oven as damage may occur.



### Caution:

- There are a number of accessories available on the market. Before you buy, make sure they are suitable for microwave use.
- When you put food in the microwave oven, make sure that food, food supports or covering do not come in direct contact with any of the internal walls or the ceiling of the cavity since discolouration may take place.

# CONTROL PANEL

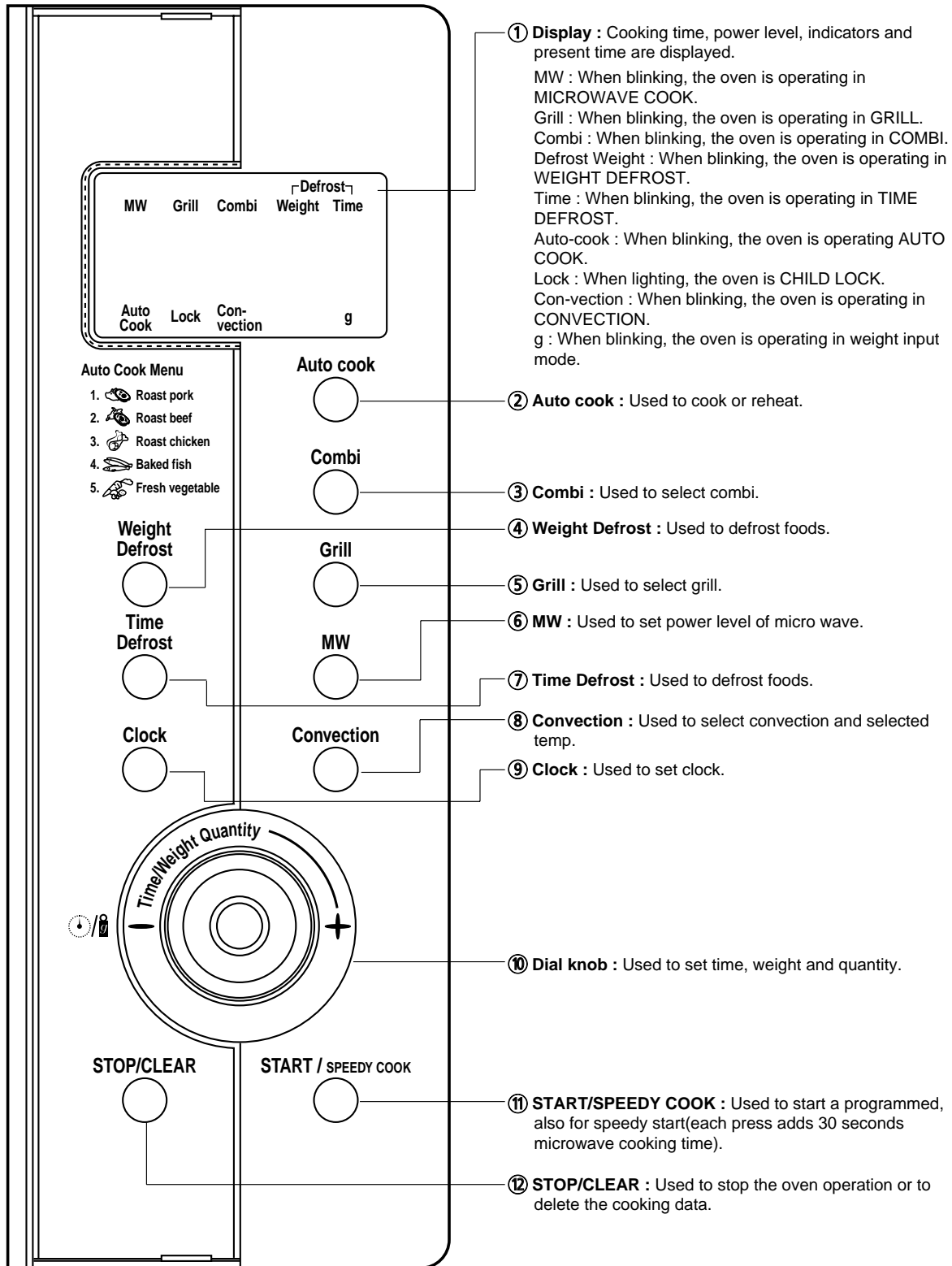

## ACCESSORIES

This oven comes equipped with several accessories. They can be used in various ways to facilitate cooking.

### ■ Rotating base

This fits over the shaft in the center of the oven's cavity floor. This to remain in the oven for all cooking. It should only be removed for cleaning.

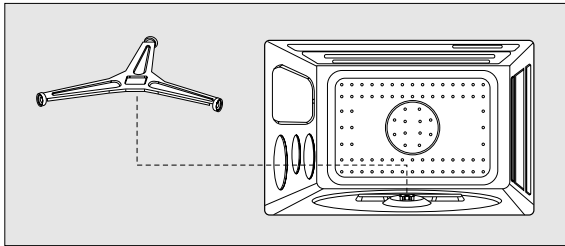

#### Important:

The rotating base must be placed in the center of the oven's cavity and fitted in the rotating shaft exactly. In case the rotating base does not fit in the rotating shaft, the rotating base might become as tray and sparks can occur.

### ■ Turntable tray or turntable

This metal tray fits over the rotating base and locks into place.

This is to be used in the oven for all cooking. It rotates clockwise or counterclockwise during cooking. It is easily removable for cooking and cleaning needs.

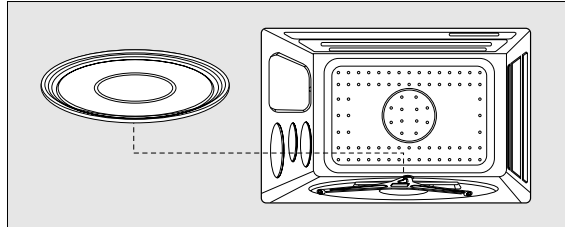

### ■ Metal rack

This metal rack is used with the turntable tray.

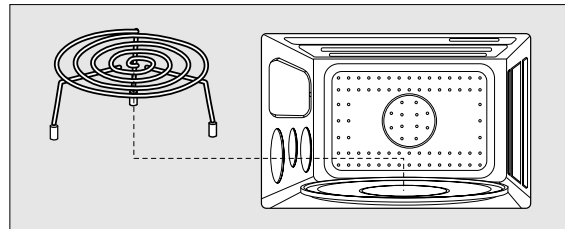

## ■ HOW TO USE THE ACCESSORIES OF COOKING

### ■ Turntable

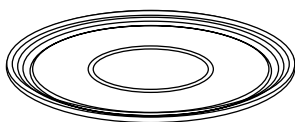

- Microwave cooking
- Convection cooking
- Combination cooking
- Auto cooking

### ■ Metal rack

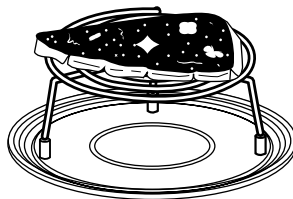

- Grill cooking

# BEFORE OPERATION

## SETTING THE CLOCK

When your oven is plugged in, the display will flash ":0" and a tone will sound. If the AC power ever goes off, the display shows ":0" when the power comes back on.

Your oven has multiple(12hr/24hr) clock system. To set the clock follow under procedure.

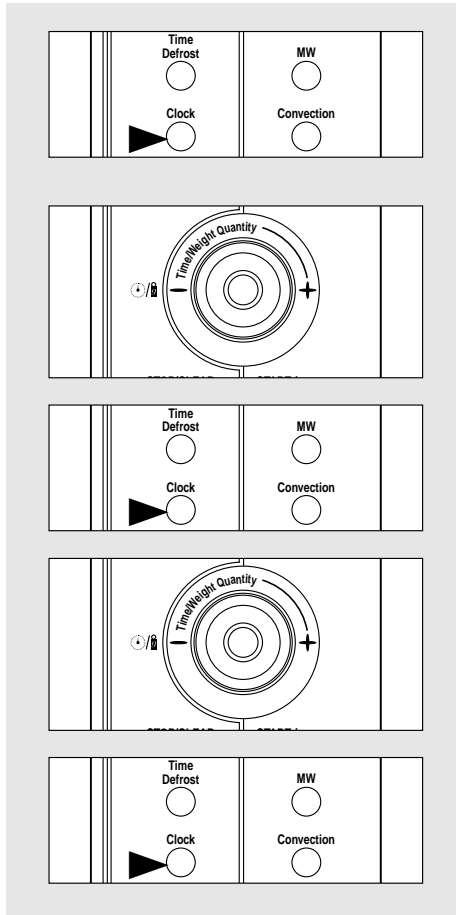

### Example : To set 5:30

1. Press **Clock** button once. (example : to set " 5:30 ")  
The display will be " 12H " shows.
2. Press **Clock** button once more, " 24H " shows in display.  
This is a 24hour clock system. If you want 12hour clock system, omit this step.
3. Turn the **dial knob** to set the hour number " 5: ".  
The hour number starts blinking, the colon will right.
4. Press **Clock** button. " 5:00 " shows in display.  
The minute number starts blinking, the colon and hour number will light.
5. Turn the **dial knob** until " 5:30 " in the display window.
6. Press **Clock** button. The colon starts blinking.  
If you selected 12hour clock system, this digital clock allows you to set from 1:00 to 12:59.  
If you selected 24hour clock system, this digital clock allows you to set from 0:00 to 23:59.



## CHILD LOCK AND POWER SAVE MODE

**Child lock** : The child lock prevents the oven from being used. For example because children could hurt themselves on hot liquids etc.  
**Power save mode** : This function is used for saving energy.

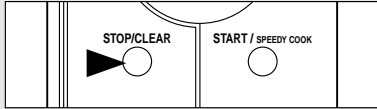

### To set child lock

1. Press **STOP/CLEAR** button.  
" : 0" or clock appears in the display.
2. Press and then hold **STOP/CLEAR** button for 3 seconds.  
The oven will lock indicator lights.  
Now the oven cannot be operated.
3. To cancel child lock simply repeat procedure 2.  
The oven will beep and lock indicator disappears.  
The oven is again available for normal use.

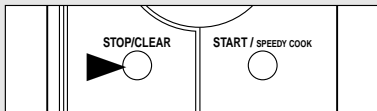

### To set power save mode

1. Press **STOP/CLEAR** button.  
" : 0" or clock appears in the display.
2. Press and then hold **Clock** button for 3 seconds.  
The display will turn off and a beep sounds.  
To operate the oven in power save mode, press any key or turn the knob.  
Then " : 0" or clock will be shown and the operation of all function key will be same as in the normal mode.  
But if there is no operation within 10 seconds in clear mode or while manipulating the key, all the contents of display will disappear.
3. To cancel power save simply repeat setting procedure. When the display is on.  
The power save mode will be canceled and a beep sounds.  
The oven is again available for normal use.

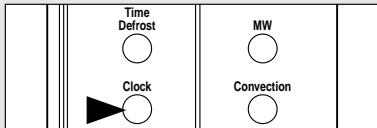

## OPERATION

**Tips :** Also remember to read this operating instruction for proper safety information and instruction before using the oven. Prior to setting the controls, place one cup of water in the oven, on a heat-proof glass measuring cup, for testing purposes.

**Note :** When the operation is finished the oven beeps three times, " : 0" or clock appears in the display, the rotating plate stops turning and the oven light turns off. The oven will continue to beep every 1 minute until the **STOP/CLEAR** button is pressed, or the door is opened.

The cooling fan continues to run for 5 minutes after cooking has stopped when it takes over 3 minutes for cooking.( the display will show "COOL" and " :0 or clock" )

Opening the oven door interrupts any operation except cooling fan.

To cancel the operation, press **STOP/CLEAR** button. To continue the operation, press **START/SPEEDY COOK** button.

The oven displays the set cooking time in 10 seconds steps( up to 5 minutes cooking time ), in 30 seconds steps( up to 10 minutes cooking time ), in 1 minutes steps( up to 60 minutes cooking time ).

## MICROWAVE COOKING

This microwave cooking method allows you to cook food for a desired time. In addition to the maximum power level(**100%**), you can select different microwave power from 9 other levels, **10% to 90%** for the foods that require slower cooking.

If you have used the appliance for grilling, convection or combination cooking, let the oven cool down before using again. Never switch the microwave oven on when it is empty.

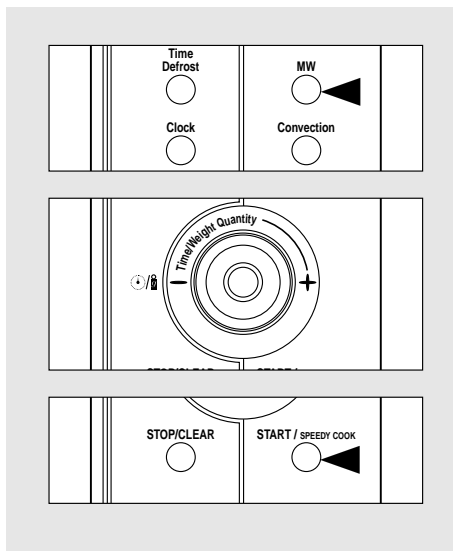

1. Press **MW** button once. **MW** indicator lights.

" **P-HI** " shows in display.

2. Select the appropriate power level by pressing the **MW** button again until the corresponding percentage is displayed. Refer to the power level table below for further details.

3. Turn the **dial knob** to set the cooking time.

For a cooking time of 5 minutes 30 seconds, turn the **dial knob** to the right to set 5:30. ( up to 60 minutes )

" **5:30** " shows in display.

4. Press **START/SPEEDY COOK** button.

The oven light comes on and the turntable starts rotating.

Cooking starts and the time in the display will count down.

**Note :** The oven will automatically work on 100% microwave power if a cooking time is entered without the power level previously being selected.

You can check the power level while cooking is in progress by pressing the **MW** button. The display will show the current power

**Power level table**

Power level	percentage	Output	Power level	percentage	Output
P-HI	100%	1000W	P-50	50%	500W
P-90	90%	900W	P-40	40%	400W
P-80	80%	800W	P-30	30%	300W
P-70	70%	700W	P-20	20%	200W
P-60	60%	600W	P-10	10%	100W
			P-00	0%	0W

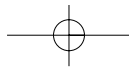

## GRILL COOKING

The grill enables you to heat and brown food quickly, without using microwaves.

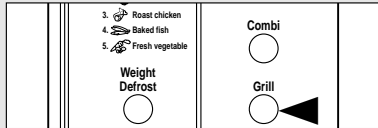

1. Press **Grill** button once. **GRILL**(upper grill) indicator lights.

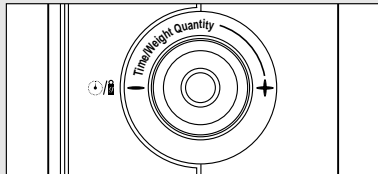

2. Turn the **dial knob** to set the grilling time.

For a grilling time of 11 minutes, turn the **dial knob** to the right to set 11:00.( up to 60 minutes )

"11:00" shows in display.

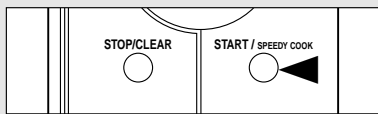

3. Press **START/SPEEDY COOK** button.

The oven light comes on and the turntable starts rotating. Cooking starts and the time in the display will count down.

**Note :**

The heating element is located in the top of the oven.

**Note :**

When first using the grill heaters, smoke and odour will be given off. To avoid this happening when food is being cooked, heat the upper and lower grills without food for approximately 10 minutes. Place food directly on the rack, in a flan dish or on a heat resistant plate on the rack.

**WARNING :**

The temperature inside the oven and window is very high. Do not touch the oven window and metallic interior of the oven when taking food in and out. Use thick oven gloves while handling food or accessories.

Suggested use	Place all food on metal rack.
This method is ideal for toasting bread or muffins. Remember the oven will be hot.	

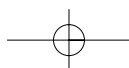

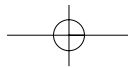

## CONVECTION COOKING(with pre-heat)

For convection cooking, it is recommended that you preheat the oven to the appropriate temperature before placing the food in the oven. The maximum preheating time is 30 minutes. If the cooking is not started immediately after preheating, the convection indicator will continue to flash and the preheated oven temperature will be displayed. It is maintained for 15 minutes; it is then switched off automatically.

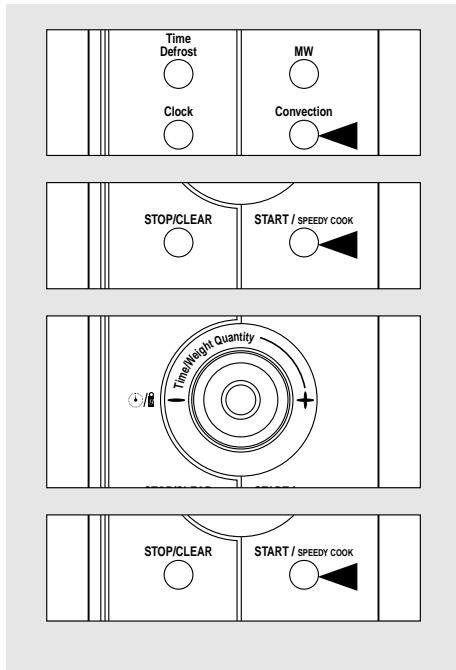

1. Press **Convection** button once. **CONVECTION** indicator lights. "110C" shows in display.
2. Select the convection cooking temperature by pressing the **Convection** button again until the corresponding temperature is displayed.

Temperature sequence
110C → 120C → 130C → 140C → 150C →
160C → 170C → 180C → 190C → 200C →
210C → 220C → 230C → 240C → 250C →

3. Press **START/SPEEDY COOK** button. **CONVECTION** indicator blinks. Temperature of preheating and "PrE-" blink alternately in the display. The oven will now preheat. When oven is preheated the oven will beep and the preheated oven temperature will appear in the display. Then open the door and place your food in the oven. Oven temperature and shows in display.
4. Turn the **dial knob** to set the cooking time. For a cooking time of 11 minutes, turn the **dial knob** to the right to set 11:00.(up to 60 minutes) "11:00" shows in display.
5. Press **START/SPEEDY COOK** button. The oven light comes on and the turntable starts rotating. Cooking starts and the time in the display will count down.

**Note:** You can check the setting temperature while preheating is in progress by pressing the **Convection** button.

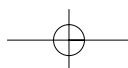

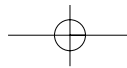

## CONVECTION COOKING(traditional cooking)

The convection mode enables you to cook food in the same way as in a traditional oven. Microwaves are not used. Always use oven gloves when touching the recipients in the oven, as they will be very hot.

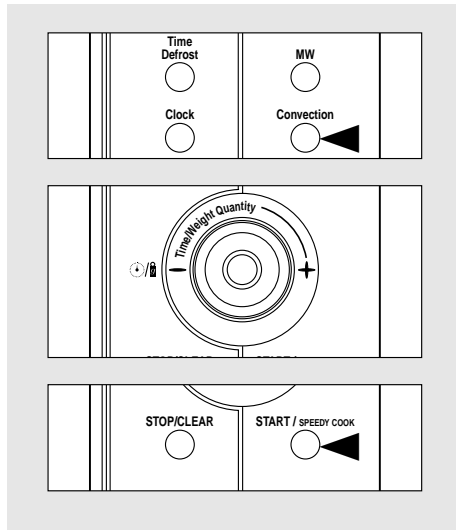

1. Press **Convection** button once. **CONVECTION** indicator lights. "110C" shows in display.
2. Select the convection cooking temperature by pressing the **Convection** button again until the corresponding temperature is displayed.

### Temperature sequence

110C → 120C → 130C → 140C → 150C →  
160C → 170C → 180C → 190C → 200C →  
210C → 220C → 230C → 240C → 250C →

3. Turn the **dial knob** to set the cooking time.  
For a cooking time of 11 minutes, turn the **dial knob** to the right to set 11:00.(up to 60 minutes)  
"11:00" shows in display.
4. Press **START/SPEEDY COOK** button.  
The oven light comes on and the turntable starts rotating.  
Cooking starts and the time in the display will count down.

**Note:** You can check the setting temperature while cooking is in progress by pressing the **Convection** button.

Suggested use	Cookware
<p>This function is ideal for cooking meringues, cookies, biscuits, scones, bread, puddings, large fruit cakes and all pastries.</p> <p>Remember the oven will be hot.</p> <p>Place all food on metal rack.</p>	<p>Use oven-proof cookware.</p> <p>As there is no microwave energy being used you can place metal tins directly onto the metal rack with no danger of arcing.</p>

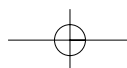

## COMBINATION COOKING ( Microwave + Convection + Upper Grill )

This function allows you to combine convection operation with microwave to produce traditional baked or roasted results in less time. Always use microwave-safe and oven-proof cookware. Glass or ceramic dishes are ideal as they allow the microwaves to penetrate the food evenly.

Always use oven gloves when touching the recipients in the oven, as they will be very hot.

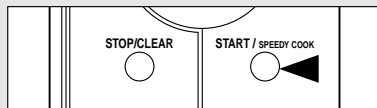
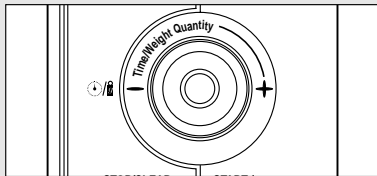
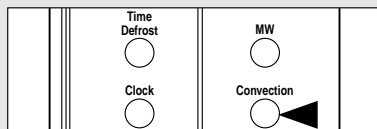
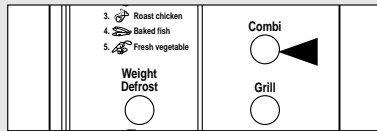

1. Press **Combi** button once.  
**COMBI** indicator light and "**C-0**" will show in the display.

2. Select the desired power level.

**For example : C-HI**

Press Combi button once again "**C-HI**" will show in the display.

Display	MW Power
C - 0	40%
C - HI	50%
C - LO	30%

**Note :** In sequential operation mode, only "C-0" can be selected.

3. Press **Convection** button once.

"**110°C**" shows in display.

Select the convection cooking temperature by pressing the Convection button again until the corresponding temperature is displayed.

Temperature sequence

110C → 120C → 130C → 140C → 150C →  
160C → 170C → 180C → 190C → 200C →  
210C → 220C → 230C → 240C → 250C →

4. Turn the **dial knob** to set the cooking time.

For a cooking time of 11 minutes, turn the **dial knob** to the right to set 11:00. ( up to 60 minutes )

"**11:00**" shows in display.

5. Press **START/SPEEDY COOK** button.

The oven light comes on and the turntable starts rotating.  
Cooking starts and the time in the display will count down.

**Note :** You can check the cooking temperature while cooking is in progress by pressing the **Convection** button.

The display will show the cooking temperature for 3 seconds.

In sequential operation mode, only "C-0" can be selected.

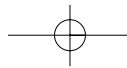

## WEIGHT DEFROST

Weight Defrost automatically sets the defrosting times and power levels to give even defrosting results for frozen food. During the defrosting process the oven will beep to remind you to check the food. The oven will beep, open the door, turn the frozen food over and close the door, press the **START/SPEEDY COOK** button.

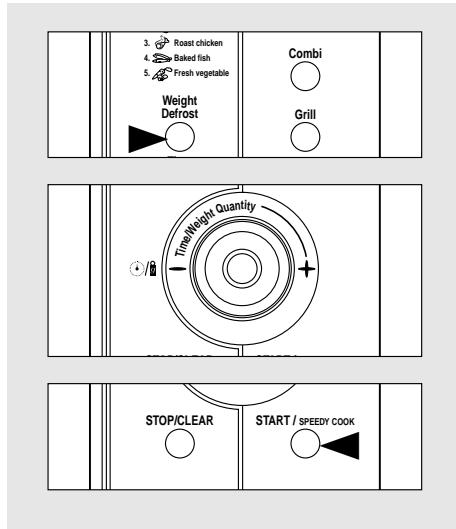

1. Press **Weight Defrost** button once. The **Weight-Defrost** indicator lights and "**: 0**" is displayed. The "**g**" indicator blinks.
2. Turn the **dial knob** to set the weight.  
Weight can be set up from 200g to 3000g.  
The weight will change in 50g increments or decrements.  
For a defrosting weight of 1000 grams, turn the **dial knob** to the right to set 1000. "**1000**" shows in display.
3. Press **START/SPEEDY COOK** button.  
The oven light comes on and the turntable starts rotating. The "**g**" indicator goes off.  
Cooking starts and the time in the display will count down.

**Note** : WEIGHT DEFROSTING begins. The defrosting time is automatically determined by the weight entered.

## TIME DEFROST

During the defrosting process the oven will beep to remind you to check the food. The oven will beep, open the door, turn the frozen food over and close the door, press the **START/SPEEDY COOK** button.

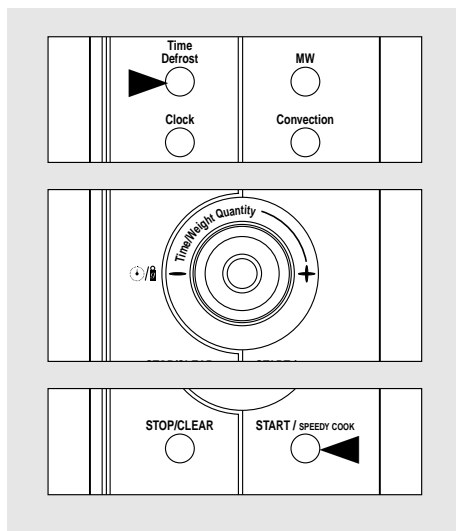

1. Press **Time Defrost** button once. The **Time-Defrost** indicator lights and "**: 0**" is displayed.
2. Turn the **dial knob** to set the defrosting time.  
For a time of 11 minutes, turn the **dial knob** to the right to set 11:00.(up to 60 minutes)  
"**11:00**" shows in display.
3. Press **START/SPEEDY COOK** button.  
The oven light comes on and the turntable starts rotating.  
Cooking starts and the time in the display will count down.

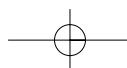

## AUTO COOK

This function allows you to simply and automatically cook a range of popular foods. Always use oven gloves when touching the recipients in the oven.

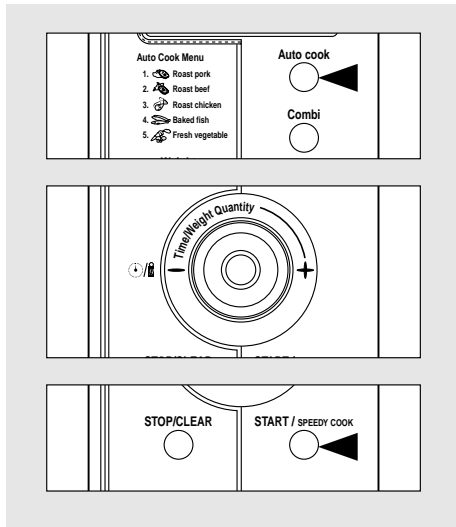

1. Press **Auto Cook** button once.  
**Auto Cook** indicator light.  
"AC-1" will show in the display.
2. Select the menu by pressing the **Auto Cook** button until the required menu is displayed.  
Refer to the auto cook menu chart below for further details.
3. Turn the **dial knob** to set the cooking weight.  
For a cooking weight of 1000 grams, turn the **dial knob** to the Right to set 1000 G.( up to 2000 grams )  
"1000" shows in display. "g" shows in display.  
Refer to the auto cook menu chart below for further details.
4. Press **START/SPEEDY COOK** button.  
The oven light comes on and the turntable starts rotating.  
Cooking starts and the time in the display will count down.

**Note :** You can check the setting cooking menu while the cooking is in progress by pressing the **Auto Cook** button.

**Auto Cook Menu Chart**

Press auto cook key	Auto Cook Menu	Minimum Weight	Maximum Weight	Weight Step
Once	<b>ROAST PORK</b>	500 g	2000 g	100 g
Twice	<b>ROAST BEEF</b>	500 g	2000 g	100 g
3 times	<b>ROAST CHICKEN</b>	800 g	3000 g	100 g
4 times	<b>BAKED FISH</b>	300 g	900 g	100 g
5 times	<b>FRESH VEGETABLE</b>	100 g	900 g	50 g

Auto Cook Menu	Start Temp.	Method	Cookware
<b>ROAST PORK</b>	Chilled temp.	<ol style="list-style-type: none"> <li>1. Tie the joint into a neat shape.</li> <li>2. Place the pork directly on the turntable.</li> <li>3. Brush with a little oil.</li> <li>4. Place roasts fat-side down a turntable tray.</li> <li>5. Cook on "AUTO COOK-ROAST PORK or ROAST BEEF".</li> <li>6. Turn over when hearing the beep.</li> <li>7. Remove from oven. Drain off any excess juices.</li> <li>8. Stand for 10 minutes in foil before serving.</li> </ol>	Place the pork or beef directly on the turntable.
<b>ROAST BEEF</b>			
<b>ROAST CHICKEN</b>	Chilled temp.	<ol style="list-style-type: none"> <li>1. Wash and dry chicken. Tie the legs loosely together with string.</li> <li>2. Pierce the skin a couple of times just under the legs.</li> <li>3. Brush butter mixture all over the chicken directly on the turntable.</li> <li>4. Place roasts breast-side down a turntable tray.</li> <li>5. Cook on "AUTO COOK-ROAST CHICKEN".</li> <li>6. Turn over when hearing the beep.</li> <li>7. Remove from oven. Drain off any excess juices. Season with salt if required. Stand for 10 minutes in foil before serving.</li> </ol>	Place the chicken directly on the turntable.
<b>BAKED FISH</b>	Chilled temp.	<ol style="list-style-type: none"> <li>1. All types of fresh fish(except battered or breadcrumbed fish) can be cooked whether whole, fillets or steaks.</li> <li>2. Place the prepared fish in a buttered dish.</li> <li>3. Season with salt and pepper, sprinkle with lemon juice and dot with butter. Do not cover dish.</li> <li>4. Place on dish on the turntable.</li> <li>5. Cook on "AUTO COOK- BAKED FISH".</li> </ol>	Micro and heat proof shallow dish. (e.g Pyrex.)
<b>FRESH VEGETABLES</b>		<ol style="list-style-type: none"> <li>1. Wash and trim.</li> <li>2. Place prepared vegetables into a suitable sized container.</li> <li>3. Sprinkle with 4-5 tbs. of water.</li> <li>4. Cover with pierced cling film or a lid.</li> <li>5. Place on dish on the turntable.</li> <li>6. Cook on "AUTO COOK- FRESH VEGETABLES.</li> </ol> <p>* For best results cut vegetables into similar sized pieces.</p>	Microproof dish. (e.g Pyrex.)



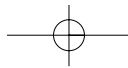

## SPEEDY COOK

The speedy cook function allows the oven to be cooking immediately on full power.

The speedy cook button has been pre-programmed to increase in increments of 30 seconds up to a maximum time of 5 minutes.

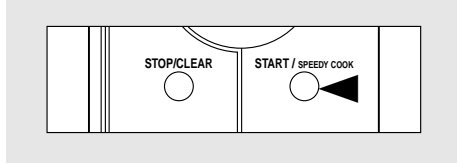

1. Press **START/SPEEDY COOK** button.

The oven will be " : 30" is displayed. MW indicator lights.

And the oven will start immediately. No need to press **START/SPEEDY COOK** button.

The oven light comes on and the turn table starts rotating and the time in the display will count down in seconds.

## TO STOP THE OVEN WHILE THE OVEN IS OPERATING

1. Open the door.
  - Oven stops operating.
  - You can restart the oven by closing the door and touching **START/SPEEDY COOK** button.
2. Press the **STOP/CLEAR** button.
  - Oven stops operating.
  - If you wish to cancel the cooking settings, press the **STOP/CLEAR** button again.

## ABNORMAL MESSAGE

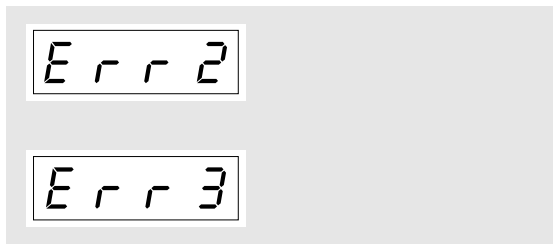

- If the inside temperature of the oven is higher than expected or the temperature sensor doesn't work properly, "Err 2" message will be shown in the display.
- Unplug the power and call our technical service.

- When the temperature sensor is disconnected, "Err 3" message will be shown in the display.
- Unplug the power and call our technical service.

## ARCING

*If you see arcing, press STOP/CLEAR button and correct the problem.*

Arcing is the microwave term for sparks in the oven. Arcing is caused by:

- Metal or foil touching the side of the oven.
- Foil not molded to food (upturned edges act like antennas).
- Metal, such as twist-ties, poultry pins, or gold rimmed dishes, in the microwave.
- Recycled paper towels containing small metal pieces being used in the microwave.

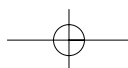

## GENERAL GUIDE LINES

Since microwave cooking to some extent is different from traditional cooking, the following general guidelines should be considered whenever you use your microwave oven

### If the food is undercooked

Check if:

- You have selected the correct power level.
- The selected time is sufficient-the times given in the recipes are approximate. They depend on initial temperature, weight and density of the food etc.
- The container is appropriate.

### If the food is overcooked,i.e. dried out or burnt

Before you cook again, consider whether:

- The power level was too high.
- The set time was too long-the times in the recipes are approximate. They depend on initial temperature, weight and density of the food etc.

### Points to remember when defrosting

- The shape of the package alters the defrosting time. Shallow rectangular packets defrost more quickly than a deep block. Separate pieces as they begin to defrost; freef low slices defrost more easily.
- Shield areas of food with small pieces of foil if they start to become warm.
- When defrosting, it is better to under thaw the food slightly and allow the process to finish during the standing time.

### The amount of food

The more food you want to prepare the longer it takes. A rule of thumb is that double amount of food requires almost double the time. If one potato takes four minutes to cook, approximately seven minutes are required to cook two potatoes.

### Starting temperature of food

The lower the temperature of the food which is being put into the microwave oven, the longer time it takes. Food at room temperature will be reheated more quickly than food at refrigerator temperature.

### Composition of the food

Food with a lot of fat and sugar will be heated faster than food containing a lot of water. fat and sugar will also reach a higher temperature than water in the cooking process. The more dense the food, the longer it takes to heat. "Very dense" food like meat takes longer time to reheat than lighter, more porous food like sponge cakes.

### Size and shape

Smaller pieces of food will cook more quickly than larger pieces and uniform pieces of food cook more evenly than irregularly shaped foods.

With unevenly shaped food, the thinner parts will cook faster than the thicker areas. Place the thinner chicken wings and legs to the centre of the dish.

### Stirring, turning of foods

Stirring and turning of foods are techniques used in conventional and well as in microwave cooking to distribute the heat quickly to the centre of the dish and avoid over-cooking at the outer edges of the food.

### Covering food helps:

- To reduce spattering
- To shorten cooking times
- To retain food moisture

All covering, which will allow microwaves to pass through are suitable-See above "Which utensils can be used in the oven?"

### Releasing pressure in foods

Several foods are tightly covered by a skin or membrane. These foods should be pricked with a fork or cocktail stick to release the pressure and to prevent bursting, as steam builds up within them during cooking. This applies to potatoes, chicken livers, sausages, egg yolks and some fruits.

### Standing time

Always allow the food to stand for some time after using the oven. standing time after defrosting, cooking/reheating always improves the result since the temperature will then be evenly distributed through out the food.

In a microwave oven foods continue to cook even when the microwave energy is turned off. They are no longer cooking by microwaves, but they are still being cooked by the conduction of the high residual heat to the centre of the food. The length of standing time depends on the volume and density of the food. Sometimes it can be as short as the time it takes you to remove the food from the oven and take it to the serving table. However, with larger, denser foods, the standing time may be as long as 10 minutes. During 'standing', the internal temperature of the food will rise by as much as 8° C and the food will finish cooking in this time.

### Arranging food

This is done in several ways in microwave cooking to give more even cooking results.

If you are cooking several items of the same food such as jacket potatoes, place them in a ring pattern for uniform cooking. When cooking foods of uneven shapes or thickness, place the smaller or thinner area of the food towards the centre of the dish where it will be heated last.

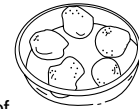

Uneven foods such as fish should be arranged in the oven with the tails to the centre.

If you are saving a meal in the refrigerator or 'plating' a meal for reheating, arrange the thicker, denser foods to the outside of the plate and the thinner or less dense foods in the middle.

Place thin slices of meat on top of each other or interlace them. Thicker slices such as meat loaf and sausages have to be placed close to each other. Gravy or sauce should be reheated in a separate container.



Choose a tall, narrow container rather than a low and wide container. When reheating gravy, sauce or soup, do not fill the container more than 2/3.



When you cook or reheat whole fish, score the skin this prevents cracking.

Shield the tail and head with small pieces of foil to prevent over-cooking but ensure the foil does not touch the sides of the oven.



## KEEP THE OVEN CLEAN

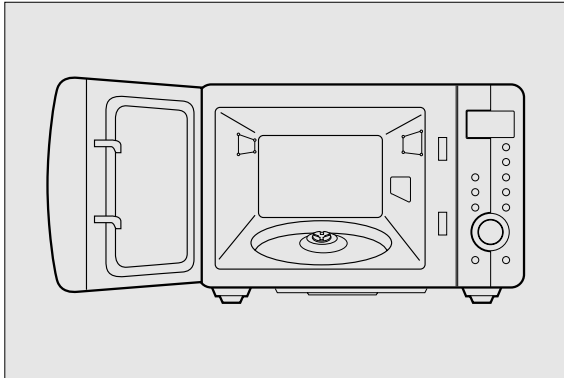

### INSIDE THE OVEN

The interior three side walls and floor are stainless steel. For easy cleaning, wipe spills and spatters as they occur with a damp cloth or sponge with water and a mild detergent. Rinse the cavity of any cleaning residue with a clean damp or sponge after cleaning. Dry with a soft cloth.

These areas can also be cleaned by using plastic or nylon scouring pads recommended for use of Teflon and Silverstone\*.

For hard to remove soil, use a mild non-abrasive cleaner. Use on the stainless steel areas, turntable and rotating base only.

### TOP SURFACE

Two quartz grill elements are installed on the top surface. As they are fragile, be careful not to press or grip them hard. Do not remove the grill elements to clean the surface.

### Warning

Just as your traditional oven becomes hot also this oven will become hot during use of the grill functions or in combination with microwaves. Children should be supervised at all times when using the oven.

### TURNTABLE AND ROTATING BASE

These two parts are easily removable for cleaning. The turntable should be cleaned frequently and is dishwasher proof. If food spills are accumulated under the rotating base, the oven will not operate efficiently. Be sure to wipe up any spills as they occur in this area.

Clean these parts as described in by the same method of cleaning inside the oven. Be sure to properly reinstall these parts into the cavity after cleaning.

### Note:

Do not use any other Turntable in the oven. Do not operate the oven without the Turntable and Rotating Base Properly in place.

### DOOR

While the oven door is still warm, any spatters or food soils should be wiped off with a damp sudsy cloth or sponge. Rinse with water and wipe dry with a cloth.

If steam or condensation appears around this area, wipe with a cloth. This may occur when the oven is operating under high humidity and with foods containing lots of moisture. This is a normal part of microwave cooking.

### Note:

- Although your oven is provided with safety features, it is important to observe the following:
  1. It is important not to defeat or tamper with safety interlocks.
  2. Do not place any object between the oven front face and the door or allow residue to accumulate on sealing surfaces. Wipe the sealing area frequently with a mild detergent, rinse and dry. Never use abrasive powers or pads.
  3. When opened, the door must not be subjected to strain, for example, a child hanging on an open door or any load could cause the oven to fall forward to cause injury and also damage to the door. Do not operate the oven if it is damaged, until it has been repaired by a service technician. It is particularly important that the oven closes properly and that there is no damage to the:
    - 1) Door(bent)
    - 2) Hinge and Hookes(broken or loosened)
    - 3) Door seals and sealing surface.
  4. The oven should not be adjusted or repaired by anyone except a properly trained service technician.

### EXTERIOR

#### CONTROL PANEL

Exercise care when cleaning this area. To clean, wipe the panel with a slightly dampened cloth, using only water. Wipe dry. Do not scrub this area or use any sort of chemical cleaner. Avoid use of excess water.

#### OUTSIDE SURFACE

The outside surfaces should be cleaned with soap and water, rinsed and dried with a soft cloth. Do not use any type of household or abrasive cleanser.

### Note:

- DO NOT USE ANY TYPE OF OVEN CLEANER ON ANY PART OF THE OVEN. It will damage some of the interior and exterior surfaces of the oven.
- In order to keep the good condition of your oven, clean the inside after each cooking.

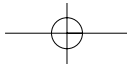

## BEFORE CALLING FOR SERVICE

You can often correct operating problems yourself. If your microwave/grill oven fails to work properly, locate the operating problem in the chart below and try the solutions marked for each problems.

If the microwave/grill oven still does not work properly, contact the nearest Service Center.

**Note:**

It is quite normal for steam to be emitted around the door during the cooking cycle. The door is not intended to seal the oven cavity completely but its special design contributes to the complete safety of the appliance.

**Caution:**

1. Do not attempt to operate the oven while empty as this will cause damage.
2. As an exhaust is located in the rear of the oven, install the oven so as not to block the outlet.  
If the microwave/grill oven still does not work properly, contact the nearest Service Center.

PROBLEM		1	2	3	4	5	6	7	8	9	10	11	12
Overcooked foods	Undercooked foods	X	X	X	X								
Overcooked foods	Undercooked foods					X	X						
Overcooked foods	Undercooked foods					X		X	X	X			
Overcooked foods	Undercooked foods										X		
Overcooked foods	Undercooked foods					X				X	X	X	
Overcooked foods	Undercooked foods					X		X	X		X		X

SOLUTION		1	2	3	4	5	6	7	8	9	10	11	12
Is start button pressed?	Is power cord plugged in?												
Is door closed?	Set the cooking time.												
Use approved cookware only.	Do not operate with oven empty.												
Supplied tray must be used.	Turn of stir food.												
Completely defrost food.	Turn correct dial knob / Press correct Function buttons												
Check to see that oven ventilation parts are not blocked.	Do "manual cooling" over 10 minutes.												

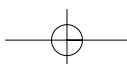

## QUESTIONS AND ANSWERS

**Q: I accidentally ran my microwave oven without any food in it. is it damaged?**

A: We do not recommend to operating the microwave oven without any food. However, running the oven empty for a SHORT time will not damage the oven.

**Q: Can I open the door when the oven is operating?**

A: The door can be opened anytime during the oven operation. Microwave energy will be instantly switched off and the time setting will maintain until the door is closed.

**Q: Does microwave energy pass through the viewing screen in the door?**

A: No. The metal screen bounces back the energy to the oven cavity. The holes are made to allow light to pass through. They do not let microwave energy pass through.

**Q: My microwave oven causes interference with my TV. is this normal?**

A: Some radio and TV interference might occur when you cook with the microwave oven. This interference is similar to the interference caused by small appliances such as mixers, vacuums, blow dryers, etc. It does not indicate a problem with your oven.

**Q: How can we know whether the oven is operating or not?**

A: Oven is operating only when the door is closed. After the end of oven cooking, the cooling fan will run for two minutes.

**Q: Why does my oven light dim?**

A: When cooking at reduced power level, the oven must cycle to obtain the selected power levels. The oven light, dims and clicking noises can be heard when the oven cycles.

**Q: When is the oven light on and off?**

A: The oven light is on during the cooking time and when the door is opened.

**Q: Why does steam accumulate on the oven door?**

A: During cooking, steam is given off from the food. Most of the steam is removed from the oven by the air which circulates in the oven cavity. However, some steam will condense on cooler surfaces such as the oven door. This is normal.

**Q: Sometimes warm air comes from the oven vents. Why?**

A: The heat given off from the cooking food warms the air in the oven cavity. This warmed air is carried out of the oven by the air flow pattern in the oven. There are no microwave in the air. The oven vents should never be blocked during cooking.

**Q: Why does the smoke come out of the exhaust vent at the back of oven?**

A: If smoke is observed, switch off or unplug the appliance and keep the door closed.

## SPECIFICATIONS

Power supply		230V~, 50Hz
Microwave	Power consumption	1500W
	Output power	1000W (IEC 705)
	Frequency	2,450MHz
Grill power consumption		1150W
Convection power consumption		2550W / 1450W (KOC-924T0S / KOC-924T5S)
Combination heating power consumption		3000W / 1500W (KOC-924T0S / KOC-924T5S)
Outside Dimension(WXDXH)		542(21.3)X515(20.3)X329(13.0)mm (inch)
Cavity Dimensions(WXDXH)		350(13.8)X355(14.0)X230(9.1)mm (inch)
Net Weight		Approx. 20Kg (44.1 lbs.)
Timer		60 minutes
Select function		Microwave / Grill / Convection / Combination
Microwave power level		10 stages