

SUPER[®]

SUPER[®] X6QT8

SUPER[®] X6QTE+

USER'S MANUAL

Revision 1.0

The information in this User's Manual has been carefully reviewed and is believed to be accurate. The vendor assumes no responsibility for any inaccuracies that may be contained in this document, makes no commitment to update or to keep current the information in this manual, or to notify any person or organization of the updates.

Please Note: For the most up-to-date version of this manual, please see our web site at www.supermicro.com.

SUPERMICRO COMPUTER reserves the right to make changes to the product described in this manual at any time and without notice. This product, including software, if any, and documentation may not, in whole or in part, be copied, photocopied, reproduced, translated or reduced to any medium or machine without prior written consent.

IN NO EVENT WILL SUPERMICRO COMPUTER BE LIABLE FOR DIRECT, INDIRECT, SPECIAL, INCIDENTAL, OR CONSEQUENTIAL DAMAGES ARISING FROM THE USE OR INABILITY TO USE THIS PRODUCT OR DOCUMENTATION, EVEN IF ADVISED OF THE POSSIBILITY OF SUCH DAMAGES. IN PARTICULAR, THE VENDOR SHALL NOT HAVE LIABILITY FOR ANY HARDWARE, SOFTWARE, OR DATA STORED OR USED WITH THE PRODUCT, INCLUDING THE COSTS OF REPAIRING, REPLACING, INTEGRATING, INSTALLING OR RECOVERING SUCH HARDWARE, SOFTWARE, OR DATA.

Any disputes arising between manufacturer and customer shall be governed by the laws of Santa Clara County in the State of California, USA. The State of California, County of Santa Clara shall be the exclusive venue for the resolution of any such disputes. Supermicro's total liability for all claims will not exceed the price paid for the hardware product.

Manual Revision: Rev. 1.0
Release Date: Nov. 22, 2006

Unless you request and receive written permission from SUPER MICRO COMPUTER, you may not copy any part of this document.

Information in this document is subject to change without notice. Other products and companies referred to herein are trademarks or registered trademarks of their respective companies or mark holders.

Copyright © 2006 by SUPER MICRO COMPUTER INC.
All rights reserved.

Printed in the United States of America

Preface

About This Manual

This manual is written for system integrators, PC technicians and knowledgeable PC users. It provides information for the installation and use of the **SUPER** X6QT8/X6QTE+ motherboard. The **SUPER** X6QT8/X6QTE+ supports single, dual or quad 64-bit Intel® Xeon processor MP, 7000 Series and 7100 Series processors at a front side bus speed of 800 or 677 MHz. Based upon the 64-bit Intel Xeon MP/7000 Series/7100 Series processors, the **SUPER** X6QT8/X6QTE+ supports the dual system bus architecture, and allows for symmetric multiprocessing across two shared system bus interfaces, providing performance enhancement with increased bus speeds and bandwidth. This motherboard is especially designed for the 4-way server platform, and can be used in front-end, back-end, general-purpose, communication and storage market segments. Please refer to our web site (<http://www.supermicro.com/products/motherboard/>) for updates on supported processors. This product is intended to be professionally installed.

Manual Organization

Chapter 1 describes the features, specifications and performance of the motherboard and provides detailed information about the chipset.

Chapter 2 provides hardware installation instructions. Read this chapter when installing the processor, memory modules and other hardware components into the system.

Chapter 3 describes troubleshooting procedures for the video, the memory and the system setup stored in CMOS.

Chapter 4 includes an introduction to BIOS and provides detailed information on running the CMOS Setup utility.

Appendix A provides BIOS POST Messages.

Appendix B lists BIOS POST Codes.

Appendix C lists Software Installation Instructions.

Conventions Used in this Manual

Special attention should be given to the following symbols for proper installation and to prevent damage done to the components or injury to yourself:



Danger/Caution: Instructions to be strictly followed to prevent catastrophic system failure or to avoid bodily injury.



Warning: Important information given to ensure proper system installation or to prevent damage to the components.

Note: Additional Information given to differentiate various models or to ensure correct system setup.

Table of Contents

Preface

About This Manual	iii
Manual Organization	iii
Conventions Used in this Manual	iii

Chapter 1: Introduction

1-1 Overview	1-1
Checklist	1-1
Contacting Supermicro	1-2
SUPER [®] X6QT8/X6QTE+ Image	1-3
SUPER [®] X6QT8 Layout	1-4
SUPER [®] X6QT8 Quick Reference	1-5
SUPER [®] X6QTE+ Layout	1-7
SUPER [®] X6QTE+ Quick Reference	1-8
Motherboard Features.....	1-9
Intel E8501 Chipset: System Block Diagram	1-11
1-2 Chipset Overview	1-12
1-3 Special Features	1-13
Recovery from AC Power Loss	1-13
1-4 PC Health Monitoring	1-13
1-5 ACPI Features	1-14
1-6 Power Supply	1-15
1-7 Super I/O	1-16

Chapter 2: Installation

2-1 Static-Sensitive Devices	2-1
Precautions.....	2-1
Unpacking	2-1
2-2 Processor and Heatsink Installation	2-2
2-3 Installing DIMMs	2-6
2-4 Control Panel Connectors and IO Ports	2-7
A. Back Panel Connectors/IO Ports.....	2-7
B. Front Control Panel.....	2-8
C. Front Control Panel Pin Definitions	2-9
NMI Button	2-9
Power LED	2-9
HDD LED	2-10
NIC1/NIC2 LED	2-10

Overheat/Fan Fail LED	2-11
Power Fail LED	2-11
Reset Button	2-12
Power Button	2-12
2-5 Connecting Cables	2-13
ATX Power Connector	2-13
Processor Power Connector	2-13
Chassis Intrusion	2-14
Universal Serial Bus	2-14
Wake-On-LAN	2-15
Wake-On-Ring	2-15
Serial Ports	2-16
GLAN (Ethernet) Ports	2-16
ATX PS/2 Keyboard and Mouse Ports	2-17
Fan Headers	2-17
VGA Enable	2-18
Power Supply Failure	2-18
SMB Header	2-19
SMB Power Connector	2-19
Power LED/Speaker	2-20
Compact Flash Card Power Connectors	2-20
JTAG Connector	2-21
Alarm Reset	2-21
2-6 Jumper Settings	2-21
Explanation of Jumpers	2-22
GLAN Enable/Disable	2-22
Clear CMOS	2-23
Watch Dog	2-23
VGA Enable/Disable	2-24
FSB Speed Select	2-24
SCSI Controller Enable/Disable	2-25
SCSI Termination Enable/Disable	2-25
3rd Power Supply Power Failure Detect	2-26
2-7 Onboard Indicators	2-27
GLAN LEDs	2-27
Overheat LED	2-27
SCSI Channel Indicators	2-28
Onboard Power LED	2-28

2-8	Parallel Port, Floppy, IPMI, Hard Disk Drive and SCSI Connections	2-29
	Floppy Connector.....	2-29
	IDE Connectors	2-30
	Ultra 320 SCSI Connectors.....	2-31
	IPMI 2.0 Socket.....	2-31

Chapter 3: Troubleshooting

3-1	Troubleshooting Procedures	3-1
	Before Power On.....	3-1
	No Power.....	3-1
	No Video	3-1
	Losing the System's Setup Configuration	3-1
	Memory Errors.....	3-2
3-2	Technical Support Procedures	3-2
3-3	Frequently Asked Questions	3-3
3-4	Returning Merchandise for Service	3-4

Chapter 4: BIOS

4-1	Introduction	4-1
4-2	Main Setup	4-2
4-3	Advanced Setup	4-3
4-4	Boot Setup	4-16
4-5	Security Setup	4-18
4-6	Exit.....	4-19

Appendices:

Appendix A:	BIOS POST Messages	A-1
Appendix B:	BIOS POST Codes.....	B-1
Appendix C:	Software Installation Instructions.....	C-1

Chapter 1

Introduction

1-1 Overview

Checklist

Congratulations on purchasing your computer motherboard from an acknowledged leader in the industry. Supermicro boards are designed with the utmost attention to detail to provide you with the highest standards in quality and performance. Check that the following items have all been included with your motherboard. If anything listed here is damaged or missing, contact your retailer. All included in the retail box.

One (1) Supermicro Mainboard

One (1) ribbon cable for IDE devices (CBL-036L-2)

One (1) floppy ribbon cable (CBL-022L)

Two (2) SATA cables (CBL-0044L)

One (1) SCSI Cable (CBL-034L-U320) (*X6QT8 only)

One (1) I/O backpanel shield (CSE-PT07L)

One (1) Supermicro CD containing drivers and utilities (CDR-INTC-Q)

One (1) Motherboard/BIOS User's Manual

One (1) Adaptec SCSI User's Manual (MNL-0669) (*X6QT8 Only)

Contacting Supermicro

Headquarters

Address: SuperMicro Computer, Inc.
980 Rock Ave.
San Jose, CA 95131 U.S.A.

Tel: +1 (408) 503-8000

Fax: +1 (408) 503-8008

Email: marketing@supermicro.com (General Information)
support@supermicro.com (Technical Support)

Web Site: www.supermicro.com

Europe

Address: SuperMicro Computer B.V.
Het Sterrenbeeld 28, 5215 ML
's-Hertogenbosch, The Netherlands

Tel: +31 (0) 73-6400390

Fax: +31 (0) 73-6416525

Email: sales@supermicro.nl (General Information)
support@supermicro.nl (Technical Support)
rma@supermicro.nl (Customer Support)

Asia-Pacific

Address: SuperMicro, Taiwan
SuperMicro, Taiwan
4F, No. 232-1 Liancheng Road
Chung-Ho 235, Taipei Hsien, Taiwan, R.O.C.

Tel: +886-(2) 8226-3990

Fax: +886-(2) 8226-3991

Web Site: www.supermicro.com.tw

Technical Support:

Email: support@supermicro.com.tw

Tel: 886-2-8228-1366, ext.132 or 139

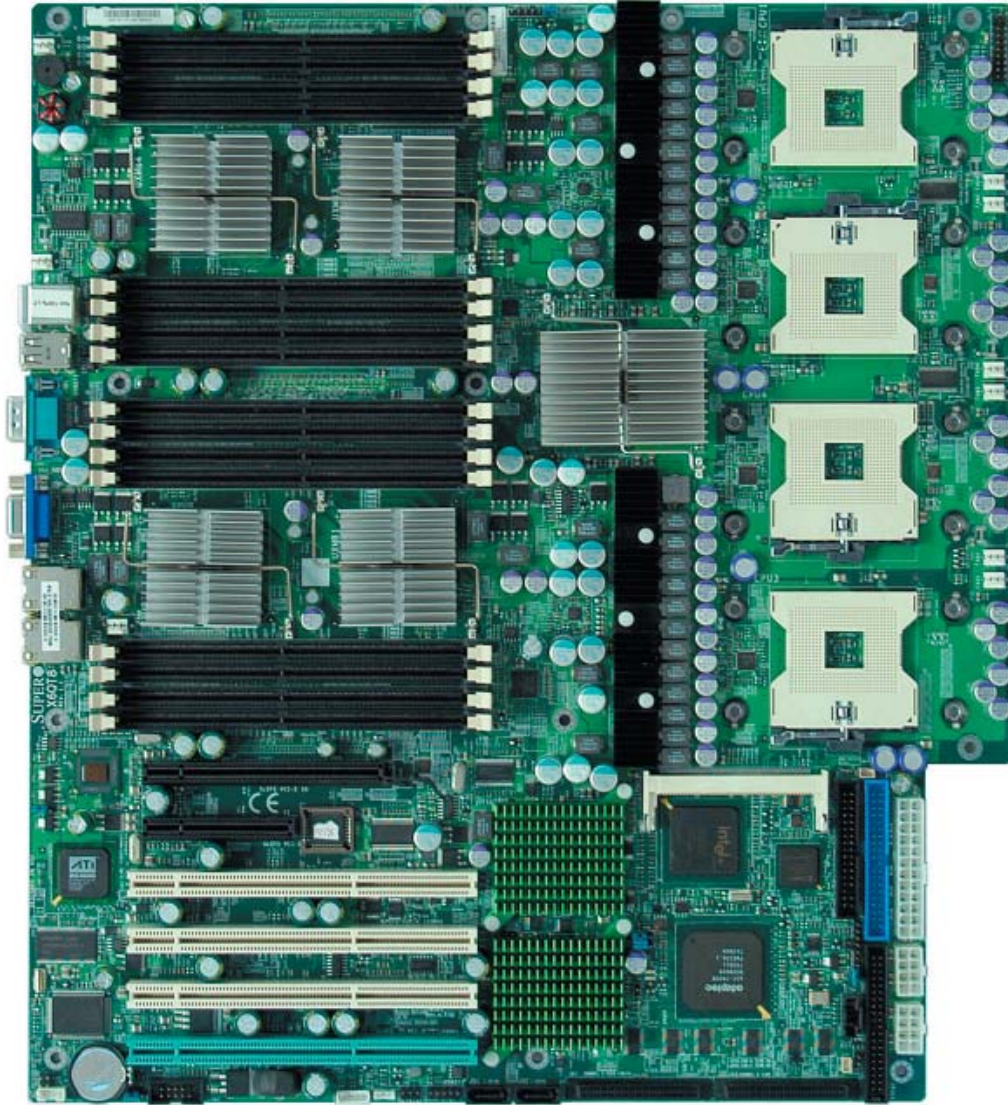
Figure 1-1. SUPER[®]X6QT8 Image

Important Notes to the User

1. All images and graphics shown in this manual were based upon the latest PCB revision available at the time of publishing of this manual. The motherboard you've received may or may not look exactly the same as the graphics shown in this manual.
2. The X6QTE+ does not contain onboard SCSI components and dual PXH Controllers. It has only one PCI-Exp. slot (Slot 6: PCI-Exp. x16).
3. When one CPU is used, install it in CPU Socket #1. When two CPUs are used, install them in Socket #1 and Socket #2. If three CPUs are used, install them in Sockets #1, #2 and #3.
4. To optimize memory performance, please refer to Memory Installation on Page 2-6 in Chapter 2.

Figure 1-2A. SUPER X6QT8 Motherboard Layout
(not drawn to scale)

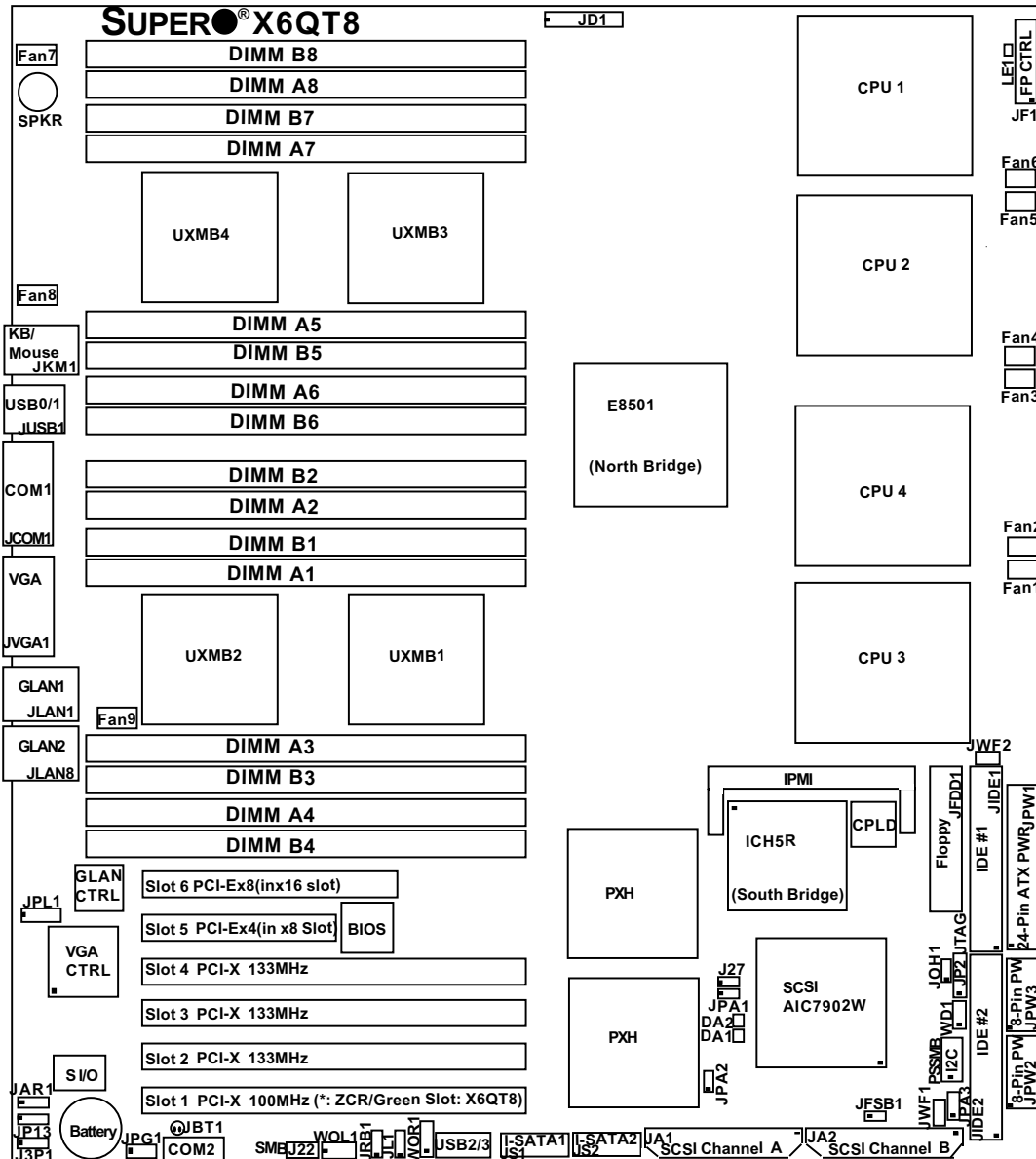

***Notes:**

- 1. Jumpers not indicated are for testing only.
- 2. "■" indicates the location of "Pin 1".
- 3. SCSI, PCI Slots #1-#5, ZCR and PXHs are available on the X6QT8 only.
- 4. Both IDE#1 and IDE#2 support compact flash cards. When a compact flash card is installed, be sure to connect a power cable to its PWR header (JWF1 for IDE1, JWF2 for IDE2).
- 5. UXMB1-UXMB4: These are extended memory bridge chips that came with the chipset.
- 6. CPLD stands for Complex Programmable Logic Devices.
- 7. For the SCSI ZCR card to work properly, please install it in the green slot.
- 8. If one CPU is used, install it in CPU Socket#1; if two CPUs are used, install them in Sockets #1 & #2. If three, install them in Sockets #1, #2 and #3.
- 9. For best memory performance, install DIMM modules in the following slots first: DIMMs A1& B1, DIMMs A3 & B3, DIMMs A5 & B5, DIMMs A7 & B7. Also refer to Pg. 2-6 in Chapter 2 for details.

Quick Reference (X6QT8)

Jumper	Description	Default Setting
J27	Processor Speed Strapping Enable	On (Enabled)(*Chpt.2)
JBT1	CMOS Clear	See Chapter 2
JFSB1	Front Side Bus Speed Select	Off (200 MHz)
JP13	3rd Power Supply Fail Detect	Off (Disabled)
JPA1	SCSI Controller Enable	Pins 1-2 (Enabled)
JPA2/JPA3	SCSI Chan.A/Chan.B Term. Enable	Off (Enable)
JPG1	VGA Enable	Pins 1-2 (Enabled)
JPL1	LAN1/LAN 2 Enable/Disable	Pins 1-2 (Enabled)
JWD1	Watch Dog Enable	Pins 1-2 (Reset)
Connector	Description	
ATX PWR	Primary 24-pin ATX PWR Connector (JPW1) (Required)	
8-pin PWR	12V 8-pin PWR Connectors (JPW2/JPW3) (Required)	
Alarm Reset	Power Supply Alarm Reset (JAR1)	
Chassis Intrusion	Chassis Intrusion Header (JL1)	
COM1/COM2	COM1/COM2 Serial Port Connector/Header	
Compact Flash PWR	Compact Flash PWR (JWF1:IDE1, JWF2:IDE2)	
DIMM A1-B8	Memory (RAM) Slots (*See Pg. 2-6 in Chapter 2.)	
FAN 1-9	CPU/Chassis/System Fan Headers	
Floppy	Floppy Disk Drive Connector	
FP CTRL	Front Control Panel Connector (JF1)	
GLAN 1/2	G-bit Ethernet Ports	
IDE1, IDE2	IDE 1 & 2 Connectors (Compact Flash Card supported)	
IPMI	IPMI 2.0 Socket	
JTAG	JTAG Connector for the CPLD (JP2) (*Note 6, Pg 1-4)	
KB/MS	PS/2 Keyboard/Mouse	
PWR LED/SPKR	PWR LED (Pins1-3), Speaker (Pins 5-7) (JD1)	
PWR Supply Fail	PWR Supply Failure Header (J3P1)	
PWR SMB (PSSMB)	Power SMB I ² C (System Management Bus)	
SCSI	SCSI Channel A (JA1), Channel B (JA2) Connectors	
SMB	SMBus (System Management Bus) (J22)	
Slot1	Slot1: PCI-X 100 ZCR (*See Note 7 on Pg. 1-4)	
Slot2-Slot4	PCI-X133MHz slots	
Slot5, Slot6	PCI-Ex4 in x8 Slot (Slot 5), PCI-Ex8 in x16 slot (Slot 6)	
Speaker (SPKR)	Internal Buzzer	
I-SATA1/2	Intel Serial ATA0 (JS1), Serial ATA1 (JS2) Connectors	
USB 0/1/2/3	Back Panel USB Ports (0/1), Front Panel USB (2/3)	
VGA	VGA Connector	
WOL	Wake-on-LAN Header (JWOL1)	
WOR	Wake-on-Ring Header (JWOR1)	

(*Note: For CPU and Memory Installation, please Notes 8, 9 on Page 1-4.)

LED Indicator	Description
DA1, DA2	Onboard SCSI Chan. A & Chan. B LEDs
OH LED	Overheat LED (JOH1)
Onboard PWR LED	Power LED Indicator (LE1)

Figure 1-2B. SUPER X6QTE+ Motherboard Layout
(not drawn to scale)

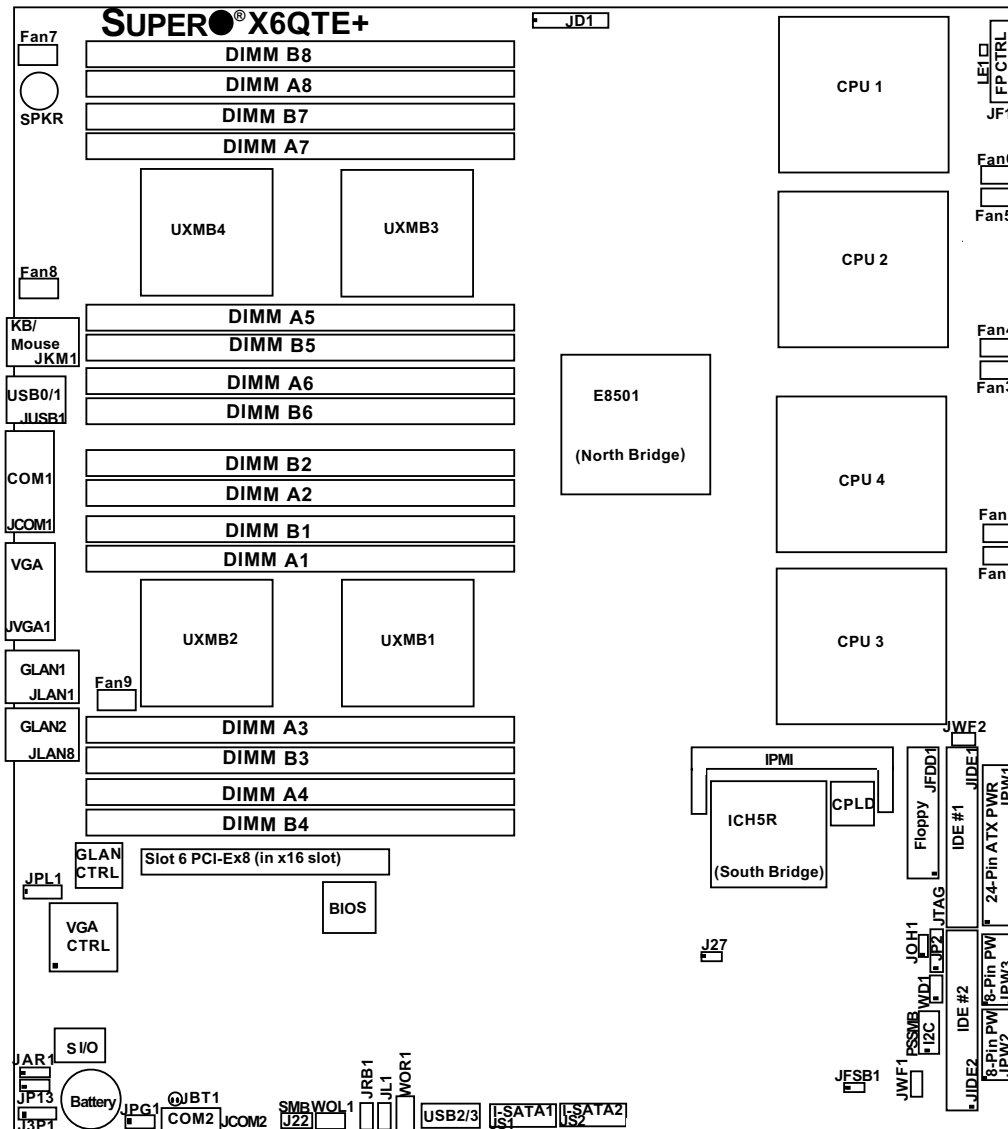

***Notes:**

1. Jumpers not indicated are for testing only.
2. "■" indicates the location of "Pin 1".
3. Both IDE#1 and IDE#2 support compact flash cards. When a compact flash card is installed, be sure to connect a power cable to its PWR header (JWF1 for IDE1, JWF2 for IDE2).
4. UXMB1-UXMB4: These are extended memory bridge chips that came with the chipset.
5. CPLD stands for Complex Programmable Logic Devices.
6. If one CPU is used, install it in CPU Socket#1; if two CPUs are used, install them in Sockets #1 & #2. If three, install them in Sockets #1, #2 and #3.
7. For best memory performance, install DIMM modules in the following slots first: DIMMs A1 & B1, DIMMs A3 & B3, DIMMs A5 & B5, DIMMs A7 & B7. Please also refer to Pg. 2-6 in Chapter 2 for details.
8. The X6QTE+ supports up to 95W CPUs.

Quick Reference (X6QTE+)

Jumper	Description	Default Setting
J27	Processor Speed Strapping Enable	On (Enabled)(*Chpt.2)
JBT1	CMOS Clear	See Chapter 2
JFSB1	Front Side Bus Speed Select	Off (200 MHz)
JP13	3rd Power Supply Fail Detect	Off (Disabled)
JPG1	VGA Enable	Pins 1-2 (Enabled)
JPL1	LAN1/LAN 2 Enable/Disable	Pins 1-2 (Enabled)
JWD1	Watch Dog Enable	Pins 1-2 (Reset)

Connector	Description
ATX PWR	Primary 24-pin ATX PWR Connector (JPW1) (Required)
8-pin PWR	12V 8-pin PWR Connectors (JPW2/JPW3) (Required)
Alarm Reset	Power Supply Alarm Reset (JAR1)
Chassis Intrusion	Chassis Intrusion Header (JL1)
COM1/COM2	COM1/COM2 Serial Port Connector/Header
Compact Flash PWR	Compact Flash PWR (JWF1:IDE1, JWF2:IDE2)
DIMM A1-B8	Memory (RAM) Slots
FAN 1-9	CPU/Chassis/System Fan Headers
Floppy	Floppy Disk Drive Connector
FP CTRL	Front Control Panel Connector
GLAN 1/2	G-bit Ethernet Ports
IDE1, IDE2	IDE 1 & 2 Connectors (Compact Flash Card supported)
IPMI	IPMI 2.0 Socket
JTAG	JTAG Connector for the CPLD (JP2) (Note5, Pg 1-7)
KB/MS	PS/2 Keyboard/Mouse
PWR LED/SPKR	PWR LED (Pins1-3), Speaker (Pins 5-7) (JD1)
PWR Supply Fail	PWR Supply Failure Header (J3P1)
PWR SMB (PSSMB)	Power SMB I ² C (System Management Bus)
SMB	SMBus (System Management Bus) (J22)
Slot6	PCI-Ex8 in x16 slot
Speaker (SPKR)	Internal Buzzer
I-SATA1/2	Intel Serial ATA0 (JS1), Serial ATA1 (JS2) Connectors
USB 0/1/2/3	Back Panel USB Ports (0/1), Front Panel USB (2/3)
VGA	VGA Connector
WOL	Wake-on-LAN Header (JWOL1)
WOR	Wake-on-Ring Header (JWOR1)

LED Indicator	Description
OH LED	Overheat LED (JOH1)
Onboard PWR LED	Power LED Indicator (LE1)

(*Note: The X6QTE+ supports up to 95W CPUs.)

Motherboard Features

CPU ◆ *Latest CPU technology!*

- supports single, dual or quad 64-bit Intel® Xeon processor MP, 7000 Series and 7100 Series processors at front side bus speed of 800 or 677 MHz
 - supports the dual system bus architecture with increased bus speeds and bandwidth, especially designed for the 4-way server platform
- (***Note:** The X6QTE+ supports up to 95W CPUs.)

Memory

- 16 (Sixteen) 240-pin DIMM sockets supporting up to 64 GB Registered ECC DDR2 533/400 SDRAM

Note: Interleaved memory: requires memory modules to be installed in pairs. See Section 2-3 for details.

Chipset

- Intel E8501 chipset, including: E8501 Chipset (North Bridge) with E8501 Chipset External Memory Bridge (XMB), ICH5R (South Bridge) and PXH PCI Controller Hub (*The PXH Controller is available for the X6QT8 only.)

Expansion Slots (***See Note 3 on Page 1-4.**)

- Two PCI-Exp slots--Slot 5: PCI-Ex4 in x8 slot (x4 signal in x8 connector)
Slot 6: PCI-E x8 in x 16 slot (x8 signal in x16 connector)
 - Four PCI-X slots (Slot 1:PCI-X 100MHz ZCR, Slots 2-4: PCI-X 133MHz)
- (***Note:** Slot 1 to Slot 5 are not available on the X6QTE+)

BIOS

- 8 Mb AMI® Flash ROM
- APM 1.2, DMI 2.3, PCI 2.2, ACPI 1.0, Plug and Play (PnP), SMBIOS 2.3, USB Keyboard, and Hardware BIOS Virus protection

PC Health Monitoring

- Onboard voltage monitors for CPU cores, +3.3V, +5V, +12V,-12V and +3.3V standby
- CPU 5-phase switching voltage regulator
- CPU/chassis temperature monitors
- Environmental temperature monitor and control via Super Doctor III
- I²C Temperature sensing logic
- CPU fan auto-off in sleep mode
- CPU thermal trip support for processor protection
- Power-up mode control for recovery from AC power loss
- Auto-switching voltage regulator for CPU core
- System overheat LED and control
- Chassis intrusion detection
- System resource alert via Super Doctor III
- Thermal Management 2 support

- Fan Status Monitor for fan speed/on-off control
- VRM Protection Feature (88°C, *98°C, 108°C) (*Default: 98°C)

ACPI Power Features

- Main switch override mechanism
- Wake-on-Ring (WOR)/Wake-on-LAN (WOL) support
- Power-on mode for AC power recovery
- Chassis Intrusion

LED Indicators

- SCSI Activity LEDs (*X6QT8 only)
- Power LED

Software

- IPMI 2.0 optional
- Supero DoctorIII
- Watch Dog/NMI

Onboard I/O

- Adaptec AIC-7902 Ultra 320 dual-channel SCSI connectors supports HostRAID 0, 1, 10, and JBOD (*X6QT8 only)
- One IPMI 2.0 Socket
- Intel 82571 EB dual-port gigabit Ethernet controller
- Two EIDE Ultra DMA/100 bus master interfaces supports UDMA Mode5, PIO Mode4, ATA/100 and up to 4 IDE devices
- One floppy port interface (up to 2.88 MB)
- PS/2 mouse and PS/2 keyboard ports
- 2 USB 2.0 (Universal Serial Bus) rear ports
- USB 2.0 internal headers (2 headers)
- Two Intel ICH5R Serial ATA Connectors support RAID 0, 1 and JBOD
- One ATI ES1000 16MB
- Super I/O (National 87427)
- One Fast UART 16550 Serial port and one header
- One VGA port

Other

- Internal/external modem ring-on
- Chassis intrusion detection/header
- Console redirection
- SDDC support

CD/Diskette Utilities

- BIOS flash upgrade utility and device drivers

Dimensions

- Proprietary 16" x 14.3" (406.4mm x 363.22 mm)

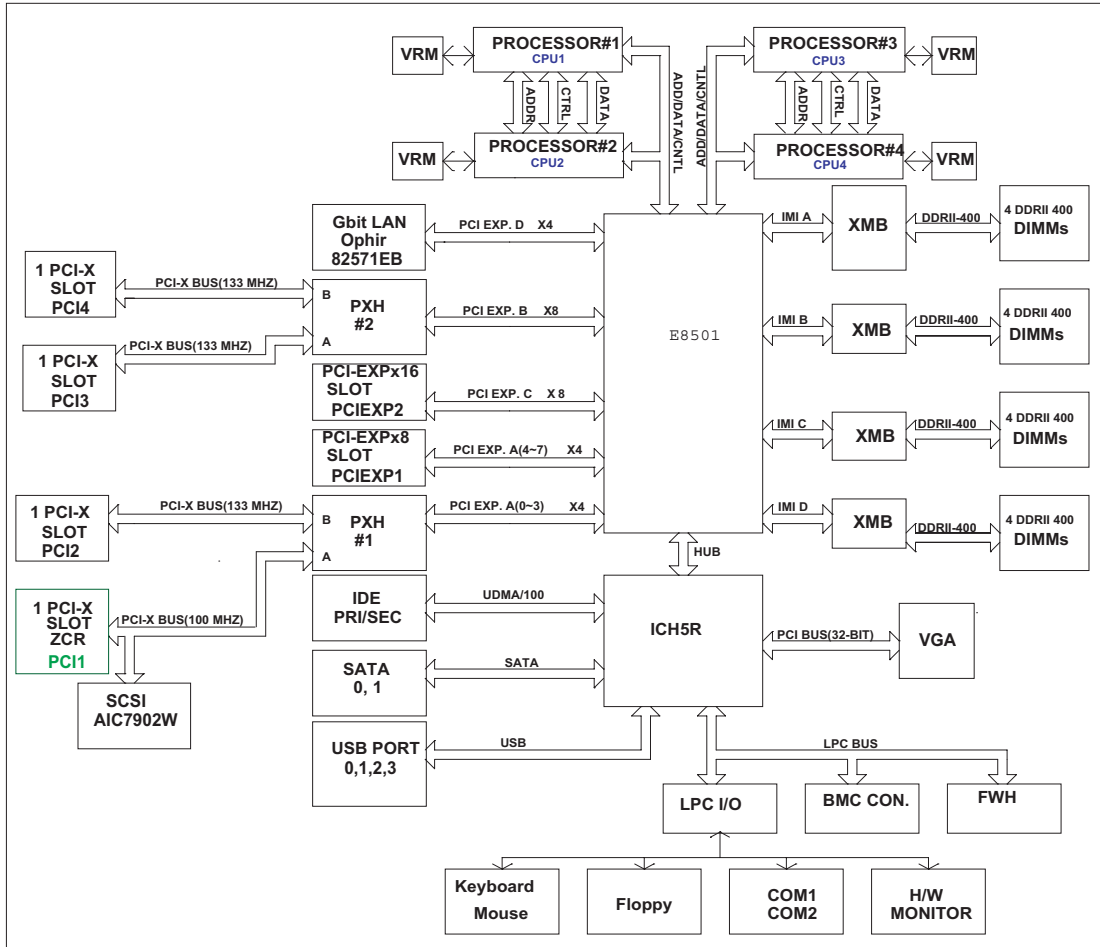

Figure 1-9. Block Diagram of the E8501 Chipset

Note: This is a general block diagram. Please see the previous Motherboard Features pages for details on the features of each motherboard.

1-2 Chipset Overview

The E8501 Chipset

Built upon the functionality and the capability of the E8501 chipset, the X6QT8/X6QTE+ motherboard provides the performance and feature set required for 4-Way servers with configuration options optimized for communications, storage, computation or database applications. The Intel E8501 chipset is built around the E8501 chipset North Bridge (NB), and the Intel E8501 chipset external Bridge (XMB).

The E8501 chipset North Bridge (NB) provides the interconnection between 64-bit Intel Xeon MP/7000 Series/7100 Series Processors, XMB (via four independent Memory Interfaces), I/O components via PCI-Express Links and ICH5R. It supports up to four 64-bit Xeon processor MP/7000 Series/7100 Series processors at a Front Side Bus of 667MHz or 800MHz. It offers ECC protection on data signals, parity protection on address signals, and supports Return Data by Enhanced Defer to allow for extraordinary completion.

Independent Memory Interface

Memory support features include the following:

- Four Independent Memory Interface (IMI) ports, each with up to 5.33 GB bandwidth (read) and 2.67 GB bandwidth (write) simultaneously at 166.7 MHz, or with up to 6.4 GB bandwidth (read) and 3.2 GB bandwidth (write) simultaneously at 200 MHz
- 40-bit addressing support provides one terabyte addressing capability
- Memory technology independent

I/O Interfaces

The E8501 chipset relies on PCI Express to provide the interconnection between the North Bridge and the I/O subsystem. The I/O subsystem is based on three x4 PCI Express links, two x8 PCI Express links, and one HI1.5 link.

- Three x4 and two x8 (each can be configured as two x4,) making a total of seven x4 links
- Dual PXH Controllers with 2 PCI-X buses per controller. (Each bus supports up to 133 MHz.) (*Note: for the X6QT8 only.)

HI 1.5

- 8-bit wide, 4x data transfer, 66 MHz base clock with 266 MB/s bandwidth
- Legacy I/O interconnection to the ICH5R

Transaction Processing Capabilities

- 64 transactions processed concurrently
- 128-entry Common Data Cache (CDC) for write combining and write buffering

1-3 Special Features

Recovery from AC Power Loss

The feature allows the user to set the power state after a power outage. You can select Power-Off for the system power to remain off after a power loss. Select Power-On for the system power to be turned on after a power loss. Select Last State to allow the system to resume its last state before the power loss. The default setting is **Last State**.

1-4 PC Health Monitoring

This section describes the PC health monitoring features of the SUPER X6QT8 /X6QTE+. It has an onboard System Hardware Monitor chip that supports PC health monitoring.

Onboard Voltage Monitors for the CPU Cores, +3.3V, +5V, +12V, -12V and +3.3V Standby

An onboard voltage monitor will scan these voltages continuously. Once a voltage becomes unstable, a warning is given or an error message is sent to the screen. Users can adjust the voltage thresholds (via Supero Doctor III) to define the sensitivity of the voltage monitor.

Fan Status Monitor with Fan Speed Control

The PC health monitor can check the RPM status of the cooling fans. The onboard CPU and chassis fans are controlled by Thermal Management via BIOS.

Environmental Temperature Control

The thermal control sensor monitors the CPU temperature in real time and will turn on the thermal control fan whenever the CPU temperature exceeds a user-defined threshold. The overheat circuitry runs independently from the CPU. It can continue to monitor for overheat conditions even when the CPU is in sleep mode. Once it detects that the CPU temperature is too high, it will automatically turn on the thermal control fan to prevent any overheat damage to the CPU. The onboard chassis thermal circuitry can monitor the overall system temperature and alert users when the chassis temperature is too high.

CPU Overheat LED and Control

This feature is available when the user enables the CPU overheat warning function in the BIOS. This allows the user to define an overheat temperature.

Thermal Management/CPU VRM Overheat

When the CPU reaches 70° C and above (Overheat), the CPU will go into throttling state. CPU Voltage will decrease to reduce CPU power consumption. When the CPU temperature reaches 78° C (*Default) and above, the Overheat LED and the Alarm Buzzer will be turned on in addition to the slowing down of the CPU. Once the CPU temperature returns to normal, the CPU voltage will return to normal as well, allowing the CPU to run at maximum speed.

VRM Protection

When the CPU VRM temperature reaches the threshold preset by the user in the BIOS, the system will go into TM (Thermal Management) mode. The CPU will slow down and the VRM current will drop to prevent the VRM from overheating. (The settings are: 88°C, *98°C, 108°C.) (*Default)

Auto-Switching Voltage Regulator for the CPU Core

The auto-switching voltage regulator for the CPU core can support up to 20A current. This will allow the regulator to run cooler and thus make the system more stable.

1-5 ACPI Features

The ACPI (Advanced Configuration and Power Interface) specification defines a flexible and abstract hardware interface that provides a standard way to integrate power management features throughout a PC system, including its hardware, operating system and application software. This enables the system to automatically turn on and off peripherals such as CD-ROMs, network cards, hard disk drives and printers. This also includes consumer devices connected to the PC such as VCRs, TVs, telephones and stereos.

In addition to enabling operating system-directed power management, ACPI provides a generic system event mechanism for Plug and Play and an operating system-independent interface for configuration control. ACPI leverages the Plug and Play BIOS data structures while providing a processor architecture-independent implementation that is compatible with Windows 2000, Windows XP, and Windows Server 2003.

Slow Blinking LED for Suspend-State Indicator

When the CPU goes into a suspend state, the chassis power LED will start blinking to indicate that the CPU is in suspend mode. When the user presses any key, the CPU will wake-up and the LED will automatically stop blinking and remain on.

Main Switch Override Mechanism

When an ATX power supply is used, the power button can function as a system suspend button to make the system enter a SoftOff state. The monitor will be suspended, and the hard drive will spin down. Pressing the power button again will cause the whole system to wake-up. During the SoftOff state, the ATX power supply provides power to keep the required circuitry in the system alive. In case the system malfunctions and you want to turn off the power, just press and hold the power button for 4 seconds. This option can be set in the Power Button Instant-Off feature under the Advanced Chipset Section in the BIOS Setup.

External Modem Ring-On (WOR)

Wake-up events can be triggered by a device such as the external modem ringing when the system is in the SoftOff state. Note that external modem ring-on can only be used with an ATX 2.01 (or above) compliant power supply.

Wake-On-LAN (WOL)

Wake-On-LAN is defined as the ability of a management application to remotely power up a computer that is powered off. Remote PC setup, updates and asset-tracking can occur after hours and on weekends so that daily LAN traffic is kept to a minimum and users are not interrupted. The motherboard has a 3-pin header (WOL) to connect to the 3-pin header on a Network Interface Card (NIC) that has WOL capability. In addition, an onboard LAN controller can also support WOL without any connection to the WOL header. The 3-pin WOL header is to be used with a LAN add-on card only.

***Note:** Wake-On-LAN requires an ATX 2.01 (or above) compliant power supply.

1-6 Power Supply

As with all computer products, a stable power source is necessary for proper and reliable operation. It is even more important for processors that have high CPU clock rates.

The X6QT8/X6QTE+ can only accommodate ATX 24-pin and 8-pin power supplies. Although most power supplies generally meet the specifications required by the CPU, some are inadequate. Your power supply must have one 24-pin and two 12V 8-pin connectors and should supply at least 650W of power; an even higher wattage power supply is recommended for high-load configurations. Also, your power must supply 1.5A for the Ethernet ports.

***Note:** Two additional 12V 8-pin power connectors (JPW2/JPW3) are required for Intel Xeon MP CPUs. Failure to provide this extra power to the CPU may make it unstable within a few minutes of operation. See Section 2-6 for details on power connectors.

It is strongly recommended that you use a high quality power supply that meets ATX power supply Specification 2.01 or above. It must also be SSI compliant (-refer to the web site at <http://www.ssiforum.org/> for details). Additionally, in areas where noisy power transmission is present, you may choose to install a line filter to shield the computer from noise. It is recommended that you also install a power surge protector to help avoid problems caused by power surges.

1-7 Super I/O

The disk drive adapter functions of the Super I/O chip include a floppy disk drive controller that is compatible with industry standard 82077/765, a data separator, write pre-compensation circuitry, decode logic, data rate selection, a clock generator, drive interface control logic and interrupt and DMA logic. The wide range of functions integrated onto the Super I/O greatly reduces the number of components required for interfacing with floppy disk drives. The Super I/O supports 360 K, 720 K, 1.2 M, 1.44 M or 2.88 M disk drives and data transfer rates of 250 Kb/s, 500 Kb/s or 1 Mb/s. It also provides two high-speed, 16550 compatible serial communication ports (UARTs). Each UART includes a 16-byte send/receive FIFO, a programmable baud rate generator, complete modem control capability and a processor interrupt system. Both UARTs provide legacy speed with baud rate of up to 115.2 Kbps as well as an advanced speed with baud rates of 250 K, 500 K, or 1 Mb/s, which support higher speed modems.

The Super I/O supports one PC-compatible printer port (SPP), Bidirectional Printer Port (BPP) , Enhanced Parallel Port (EPP) or Extended Capabilities Port (ECP).

The Super I/O provides functions that comply with ACPI (Advanced Configuration and Power Interface), which includes support of legacy and ACPI power management through an SMI or SCI function pin. It also features auto power management to reduce power consumption.

Chapter 2

Installation

2-1 Static-Sensitive Devices



Electric-Static-Discharge (ESD) can damage electronic components. To prevent damage to your system board, it is important to handle it very carefully. The following measures are generally sufficient to protect your equipment from ESD.

Precautions

- Use a grounded wrist strap designed to prevent static discharge.
- Touch a grounded metal object before removing the board from the antistatic bag.
- Handle the board by its edges only; do not touch its components, peripheral chips, memory modules or gold contacts.
- When handling chips or modules, avoid touching their pins.
- Put the motherboard and peripherals back into their antistatic bags when not in use.
- For grounding purposes, make sure your computer chassis provides excellent conductivity between the power supply, the case, the mounting fasteners and the motherboard.
- Use only the correct type of onboard CMOS battery as specified by the manufacturer. Do not install the onboard battery upside down to avoid possible explosion.

Unpacking

The motherboard is shipped in antistatic packaging to avoid static damage. When unpacking the board, make sure the person handling it is static protected.

2-2 Processor and Heatsink Installation



When handling the processor package, avoid placing direct pressure on the label area of the fan. Also, do not place the motherboard on a conductive surface which can damage the BIOS battery and prevent system bootup.

IMPORTANT: Always connect the power cord last and always remove it before adding, removing or changing any hardware components. Make sure that you install the processor into the CPU socket **before** you install the CPU heat sink.

***Note:** For proper system cooling, please use the heatsink provided by Supermicro.

CPU Installation

1. Lift the lever on the CPU socket--lift the lever completely as shown on the picture on the right; otherwise, you will damage the CPU socket when power is applied. (Install CPU1 first.)

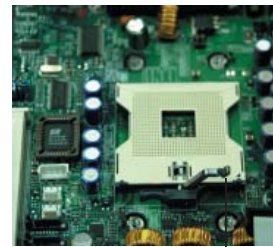

Socket lever

2. Insert the CPU in the socket, making sure that pin 1 of the CPU aligns with pin 1 of the socket (both corners are marked with a triangle). When using only one CPU, install it into CPU socket #1 (CPU sockets will be automatically disabled if not in use).

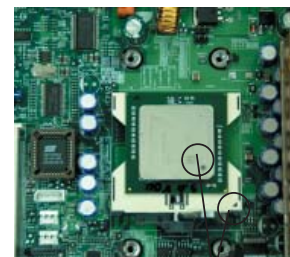

Pin1

3. Press the lever down until you hear a click, so you can be sure that the CPU is securely installed in the CPU socket.



Socket lever in the locking Position

(*Note: CPUs shown in the pictures are for display only. Your CPU may or may not look exactly the same as the ones shown in the graphics above.)

Heatsink Installation



IMPORTANT: Due to the weight of the Passive Heatsink (about 1KG), you need to have Heatsink Mounting plate installed on the chassis to prevent damage to the CPU and the motherboard)

1. Do not apply any thermal compound to the heatsink or the CPU die-the required amount has already been applied.

2. Place the heatsink on top of the CPU so that the four mounting holes are aligned with those on the retention mechanism.

Passive Heatsink

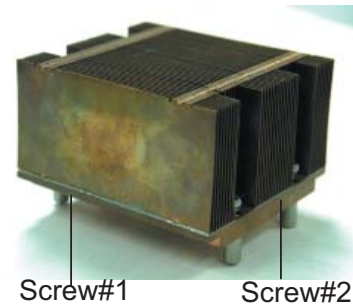

3. Screw in two diagonal screws (ie the #1 and the #2 screws) until just snug (-do not fully tighten the screws to avoid possible damage to the CPU.)

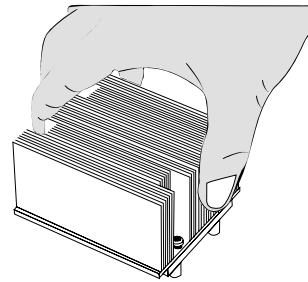

4. Finish the installation by fully tightening all four screws.

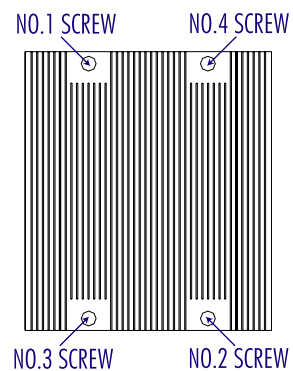

(*Note: The CPU heatsink shown in the picture above is for display only. Your heatsink may or may not look exactly the same as the one shown in the graphic above.)

To Un-install the Heatsink



Caution! We do not recommend that you remove the CPU or heatsink. However, if you do need to un-install the heatsink, please follow the instructions below to uninstall the heatsink to prevent damage to the CPU or the CPU socket.

1. Unscrew and remove the heatsink screws from the motherboard in the sequence as show in the picture on the right.

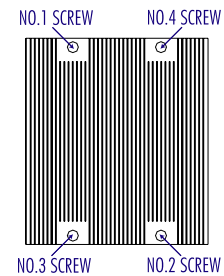

2. Hold the heatsink as shown in the picture on the right and gently wriggle the heatsink to loosen it from the CPU. (Do not use excessive force when wriggling the heatsink!)

3. Once the CPU is loosened, remove the heatsink from the CPU socket.

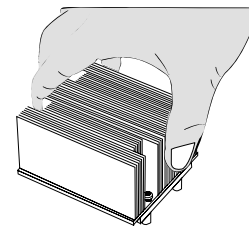

4. Clean the surface of the CPU and the heatsink to get rid of the old thermal grease. Reapply the proper amount of thermal grease on the surface before you re-install the CPU and the heatsink.

Figure 2-1. PGA604 Socket: Empty and with Processor Installed

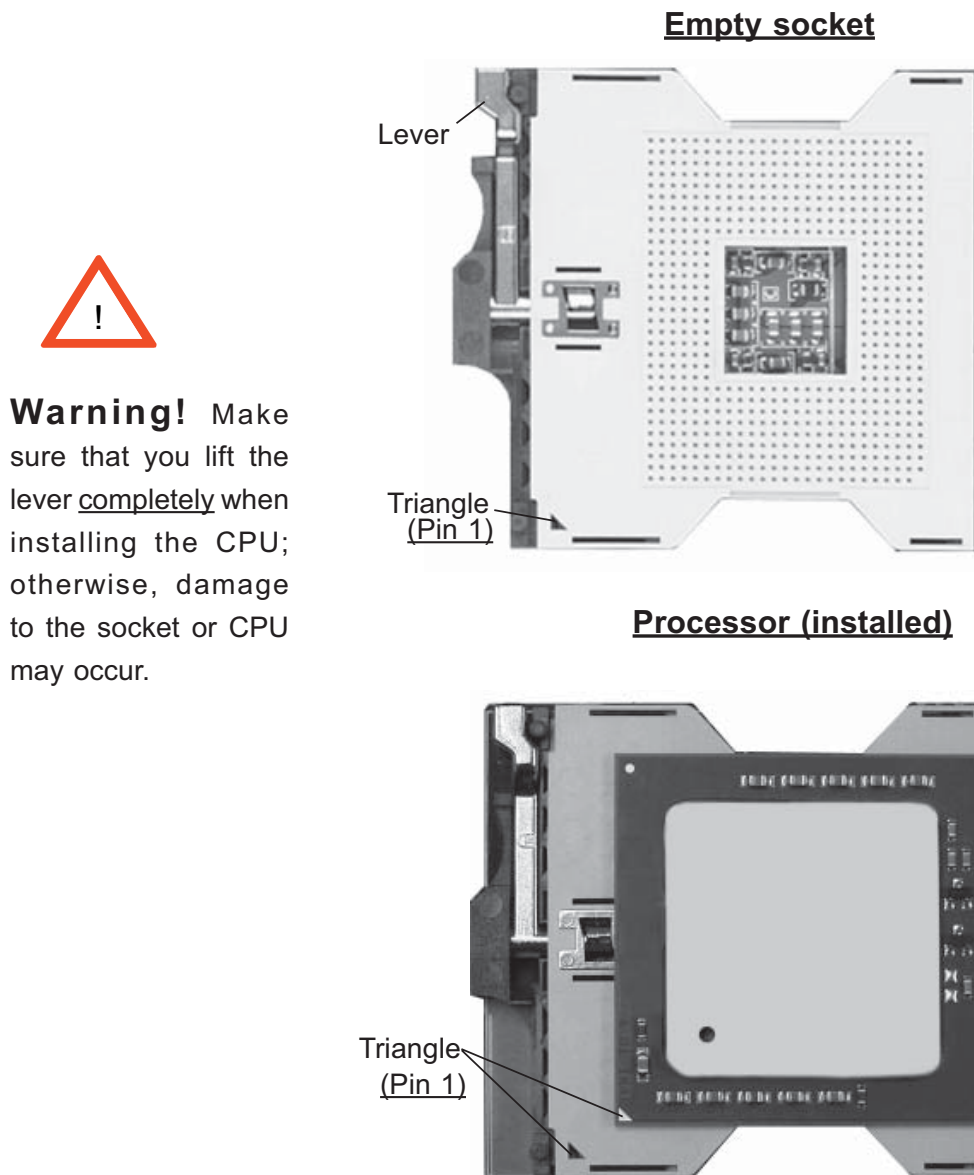

(*Note: The CPU shown in the picture is for display only. Your CPU may or may not look exactly the same as the one shown in the picture above.)

Mounting the Motherboard in the Chassis

All motherboards have standard mounting holes to fit different types of chassis. Make sure that the locations of all the mounting holes for both the motherboard and the chassis match. Make sure that the metal standoffs click in or are screwed in tightly. Then use a screwdriver to secure the motherboard onto the motherboard tray. Please note that some components are very close to the mounting holes. Take caution when installing or removing these components to prevent damage to the components.

2-3 Installing DIMMs



CAUTION Exercise extreme care when installing or removing DIMM modules to prevent any possible damage. Also note that the memory is interleaved to improve performance.

DIMM Installation (See Figure 2-2)

1. Insert the desired number of DIMMs into the memory slots, starting with the first DIMM of the first bank. Each UXMB chip is independent from each other, so memory modules can be installed on the first bank of a UXMB Controller. For best memory performance, 8 memory modules minimal are required (-2 modules for each UXMB chip. See the Memory Table below.)

	DIMM Memory			
	Bank 1		Bank 2	
UXMB1	A1	B1	A2	B2
UXMB2	A3	B3	A4	B4
UXMB3	A5	B5	A6	B6
UXMB4	A7	B7	A8	B8

2. To optimize memory performance, install DIMM modules in the following slots first: DIMMs A1 & B1, DIMMs A3 & B3, DIMMs A5 & B5, DIMMs A7 & B7.
3. Insert each DIMM module vertically into its slot. Pay attention to the notch along the bottom of the module to prevent inserting the DIMM module incorrectly.
4. Gently press down on the DIMM module until it snaps into place in the slot. Repeat for all modules.

Memory Support

The X6QT8/X6QTE+ supports up to 64 GB of Reg. ECC DDR2 533/400 (PC3200) memory. (**Note:** Due to OS limitations, some operating systems may not support more than 4GB of memory.)

Figure 2-2. Installing and Removing DIMMs

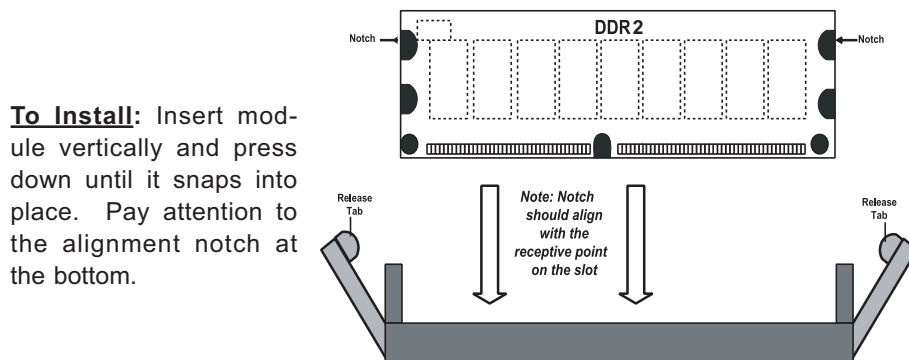

To Remove:

Use your thumbs to gently push near the edge of both ends of the module. This should release it from the slot.

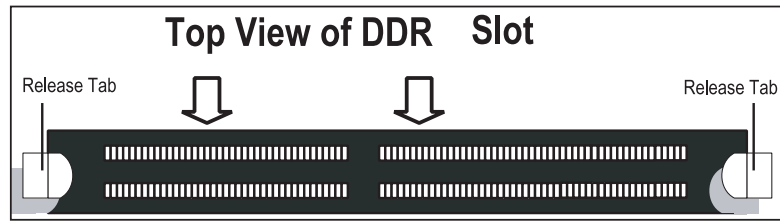

2-4 Control Panel Connectors/I/O Ports

The I/O ports are color coded in conformance with the PC 99 specification. See Figure 2-3 below for the colors and locations of the various I/O ports.

A. Back Panel Connectors/I/O Ports

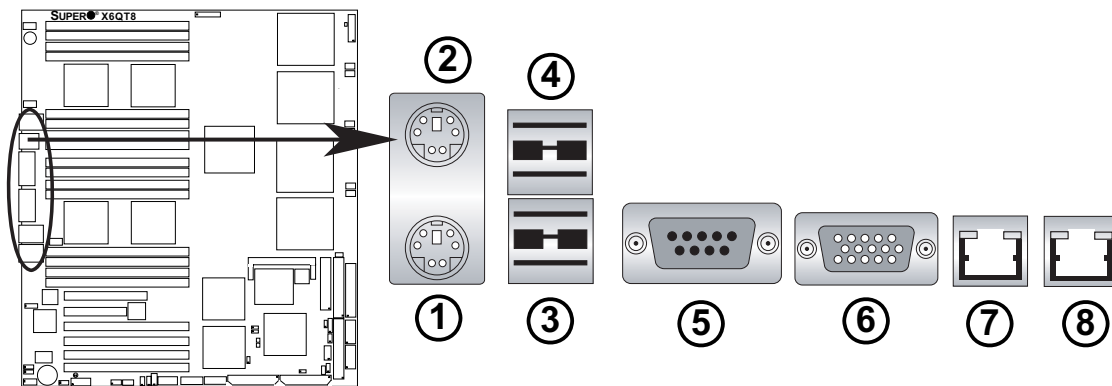

Figure 2-3. Back Panel I/O Port Locations and Definitions

Back Panel Connectors

1. Keyboard (Purple)
 2. PS/2 Mouse (Green)
 3. Back Panel USB Port 1
 4. Back Panel USB Port 2
 5. COM Port 1 (Turquoise)
 6. VGA Port (Blue)
 7. Gigabit LAN 1
 8. Gigabit LAN 2
- (*See Section 2-5 for details.)

B. Front Control Panel

Front Control Panel

JF1 contains header pins for various buttons and indicators that are normally located on a front control panel of the chassis. These connectors are designed specifically for use with Supermicro server chassis. See Figure 2-4 for the descriptions of the various control panel buttons and LED indicators. Refer to the following section for descriptions and pin definitions.

Figure 2-4. JF1 Header Pins

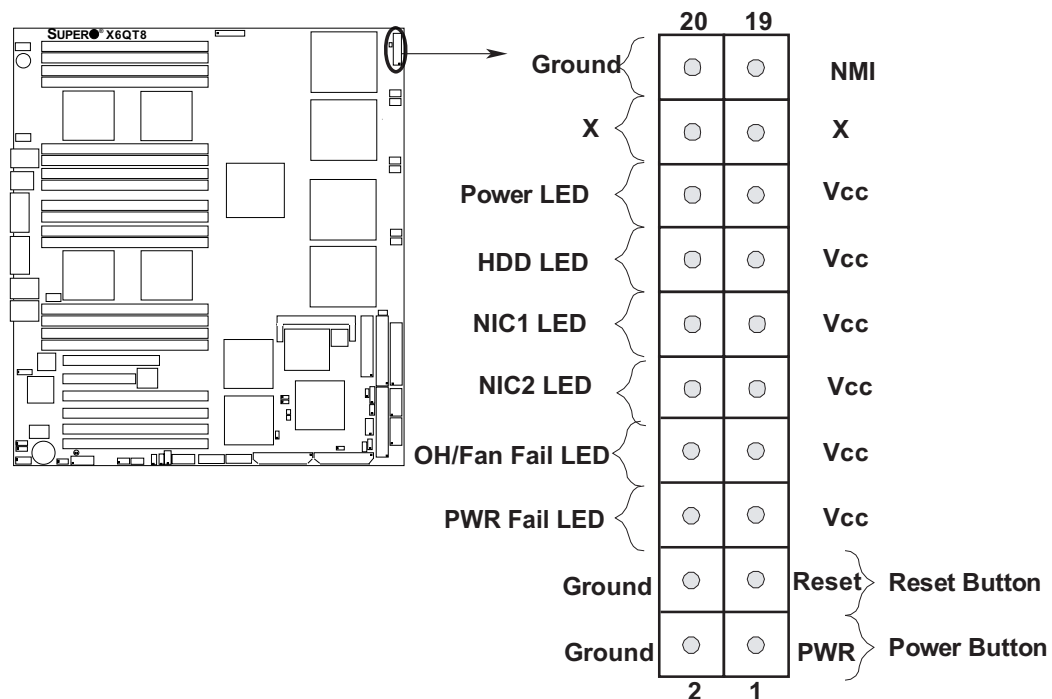

C. Front Control Panel Pin Definitions

NMI Button

The non-maskable interrupt button header is located on pins 19 and 20 of JF1. Refer to the table on the right for pin definitions.

NMI Button Pin Definitions (JF1)	
Pin#	Definition
19	Control
20	Ground

Power LED

The Power LED connection is located on pins 15 and 16 of JF1. Refer to the table on the right for pin definitions.

Power LED Pin Definitions (JF1)	
Pin#	Definition
15	+5V
16	Ground

A. NMI

B. PWR LED

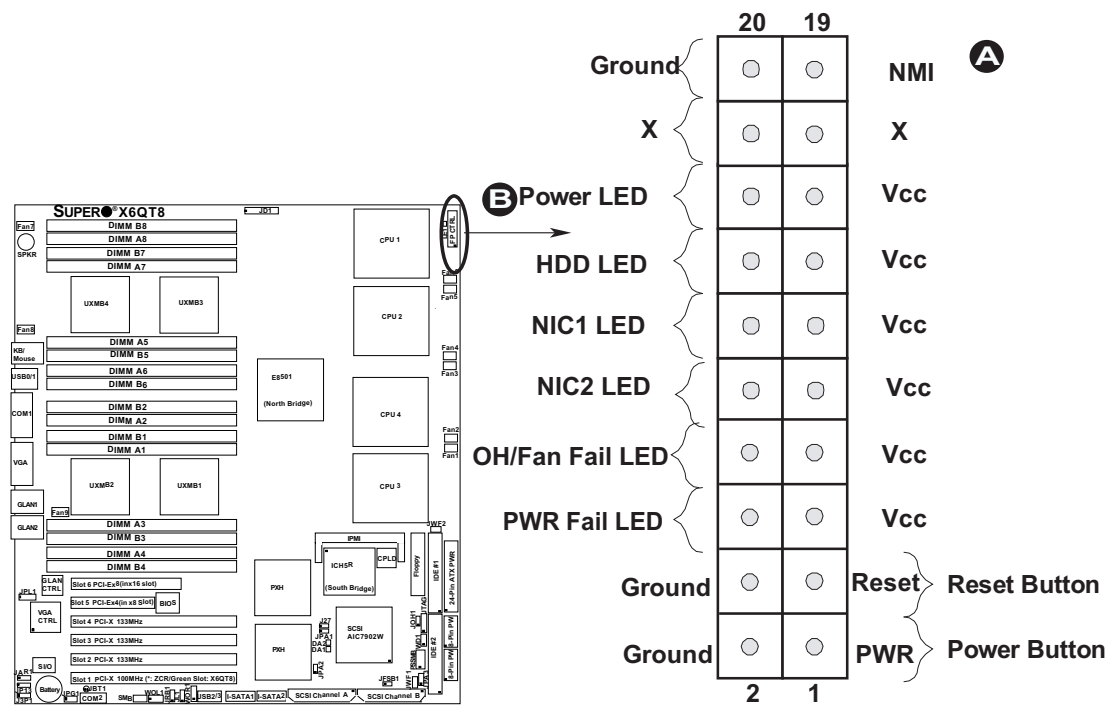

HDD LED

The HDD LED connection is located on pins 13 and 14 of JF1. Attach a hard drive LED cable here to display a hard disk drive activity (including SCSI, Serial ATA and IDE). See the table on the right for pin definitions.

HDD LED Pin Definitions (JF1)	
Pin#	Definition
13	+5V
14	HD Active

NIC1/NIC2 LED Indicators

The NIC (Network Interface Controller) LED connections for the GLAN port1 is located on pins 11 and 12 of JF1, and for the GLAN port2 is located on pins 9 and 10 of JF1. Attach the NIC LED cables to display network activity. Refer to the tables on the right for pin definitions.

GLAN1/2 LED Pin Definitions (JF1)	
Pin#	Definition
9/11	Vcc
10/12	Ground

A. HDD

B. NIC1/NIC2

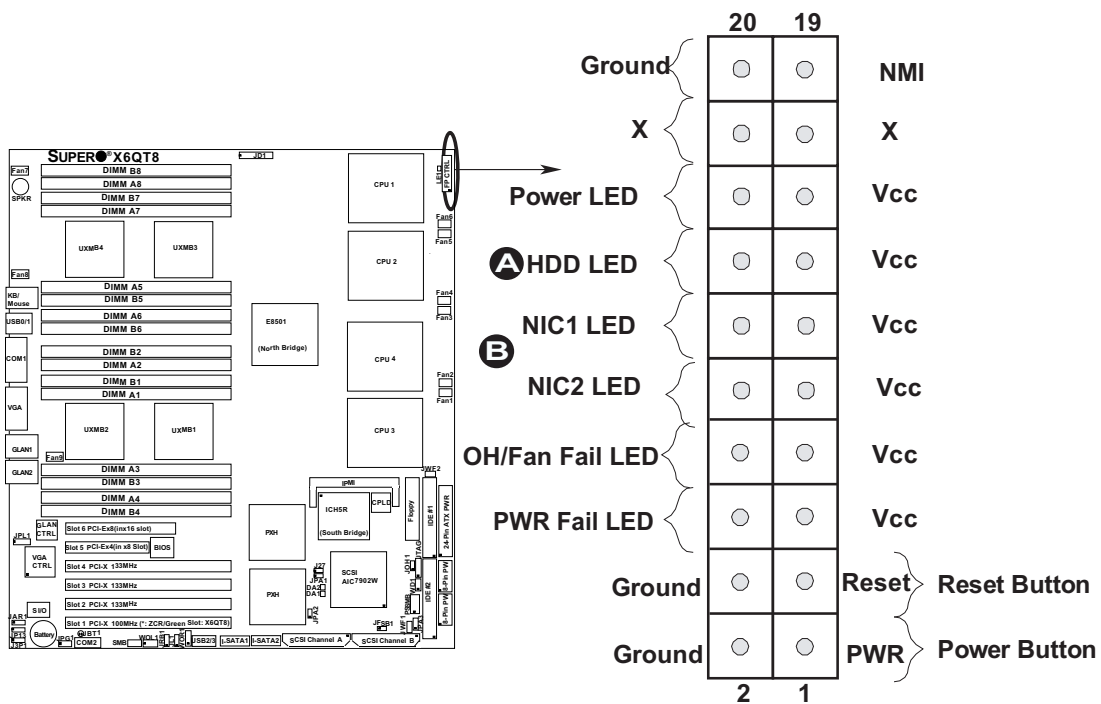

Overheat/Fan Fail LED

Connect an LED to the OH/Fan Fail LED connection on pins 7 and 8 of JF1 to provide an advanced warning of chassis overheating and fan failure. Refer to the table on the right for pin definitions.

OH/Fan Fail LED Pin Definitions (JF1)	
Pin#	Definition
7	Vcc
8	Ground

OH/Fan Fail Indicator Status	
State	Definition
Off	Normal
On	Overheat
Flash-ing	Fan Fail

Power Fail LED

The Power Fail LED connection is located on pins 5 and 6 of JF1. Refer to the table on the right for pin definitions.

PWR Fail LED Pin Definitions (JF1)	
Pin#	Definition
5	Vcc
6	Ground

A. OH/Fan Fail LED

B. PWR Fail LED

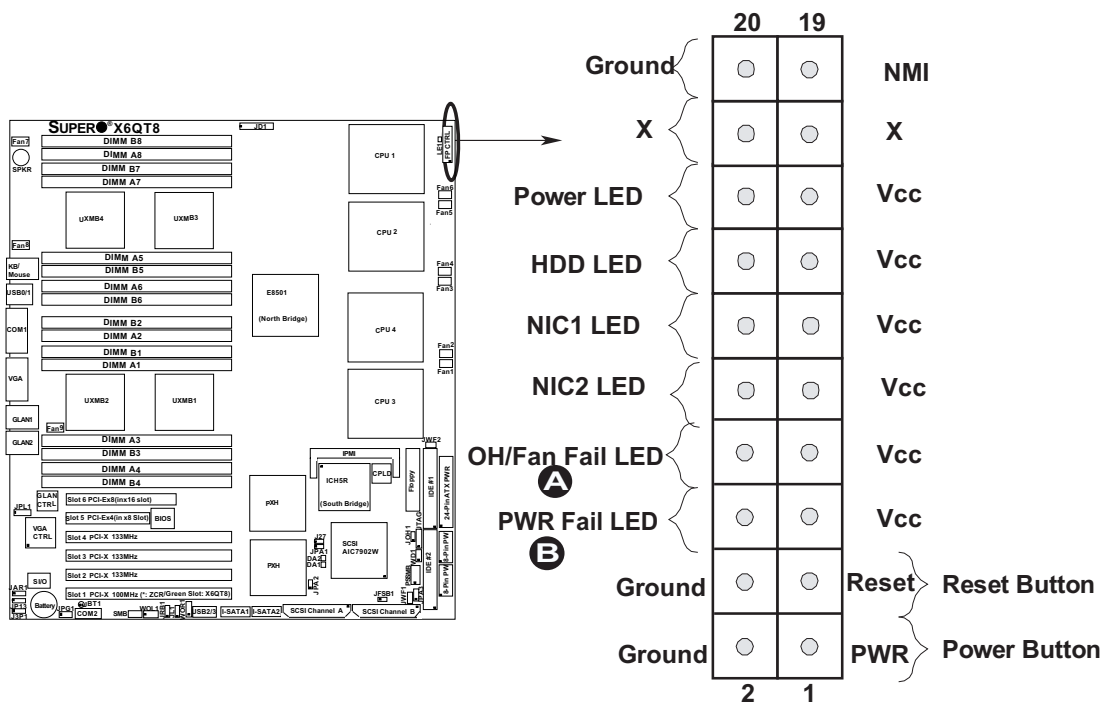

Reset Button

The Reset Button connection is located on pins 3 and 4 of JF1. Attach it to the hardware reset switch on the computer case. Refer to the table on the right for pin definitions.

Reset Button Pin Definitions (JF1)	
Pin#	Definition
3	Reset
4	Ground

Power Button

The Power Button connection is located on pins 1 and 2 of JF1. Momentarily contacting both pins will power on/off the system. To turn off the power when set to suspend mode, press the button for at least 4 seconds. Refer to the table on the right for pin definitions.

Power Button Pin Definitions (JF1)	
Pin#	Definition
1	Signal
2	+3V Standby

A. Reset

B. PWR Button

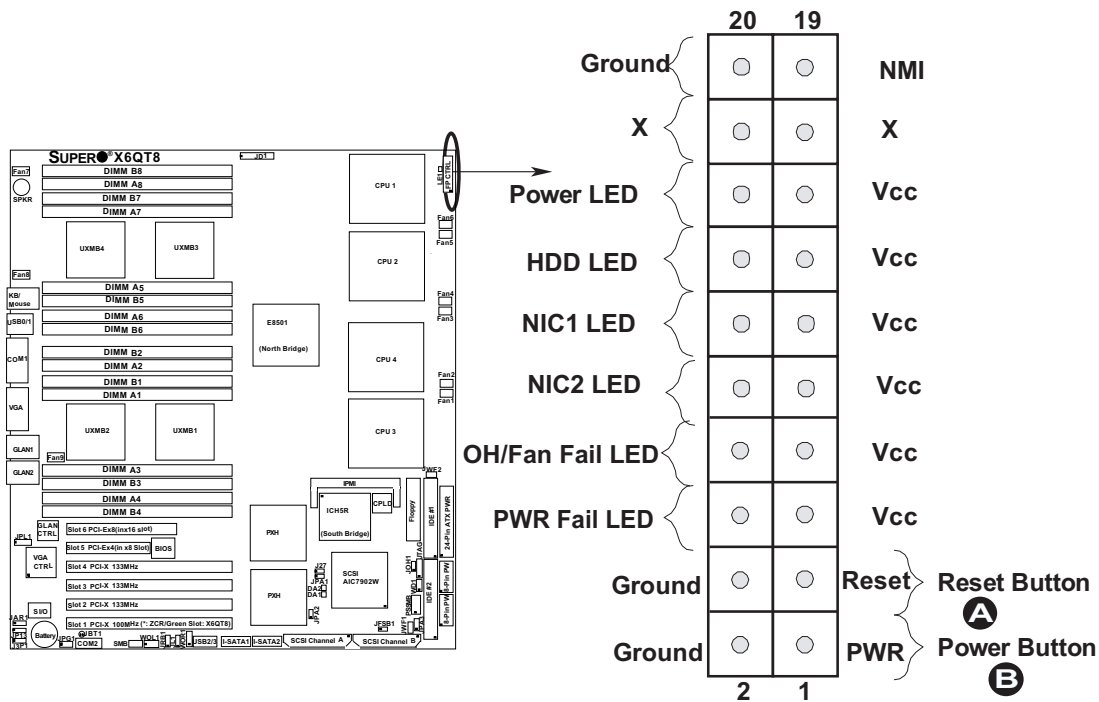

2-5 Connecting Cables

ATX Power Connector

There is a 24-pin main power supply connector (JPW1) and two 8-pin CPU PWR connectors (JPW2/JPW3) on the board. This power connector meets the SSI EPS 12V specification. See the table on the right for pin definitions. For CPU PWR (JPW2/JPW3), please refer to the item listed below.

Pin#	Definition	Pin #	Definition
13	+3.3V	1	+3.3V
14	-12V	2	+3.3V
15	COM	3	COM
16	PS_ON	4	+5V
17	COM	5	COM
18	COM	6	+5V
19	COM	7	COM
20	Res (NC)	8	PWR_OK
21	+5V	9	5VSB
22	+5V	10	+12V
23	+5V	11	+12V
24	COM	12	+3.3V

Secondary Power Connectors

In addition to the Primary ATX power connector (above), the 12V 8-pin Processor connectors located at JPW2/JPW3 must also be connected to your power supply. See the table on the right for pin definitions.

Pins	Definition
1 through 4	Ground
5 through 8	+12V

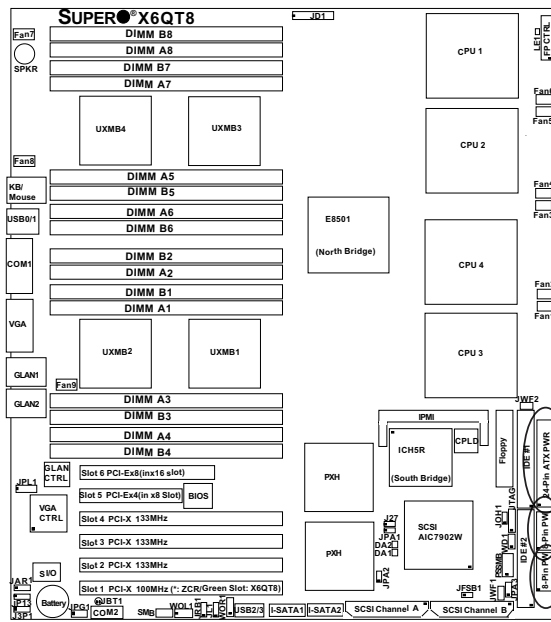

A. 24-Pin PWR

B. 8-Pin PWR

Chassis Intrusion

A Chassis Intrusion header is located at JL1. Attach an appropriate cable to inform you of a chassis intrusion.

Chassis Intrusion Pin Definitions (JL1)	
Pin#	Definition
1	Intrusion Input
2	Ground

Universal Serial Bus (USB)

There are two Universal Serial Bus ports (USB 0/1) located on the I/O panel and additional two USB headers (USB 2/3) on the motherboard. These two USB (USB 2/3) headers can be used to provide front side chassis access (-cables not included). See the tables on the right for pin definitions.

Universal Serial Bus Pin Definitions			
USB 0/1 Pin #	Definition	(FP) USB 2/3 Pin #	Definition
1	+5V	1	+5V
2	PO-	2	PO-
3	PO+	3	PO+
4	Ground	4	Ground
5	N/A	5	Key

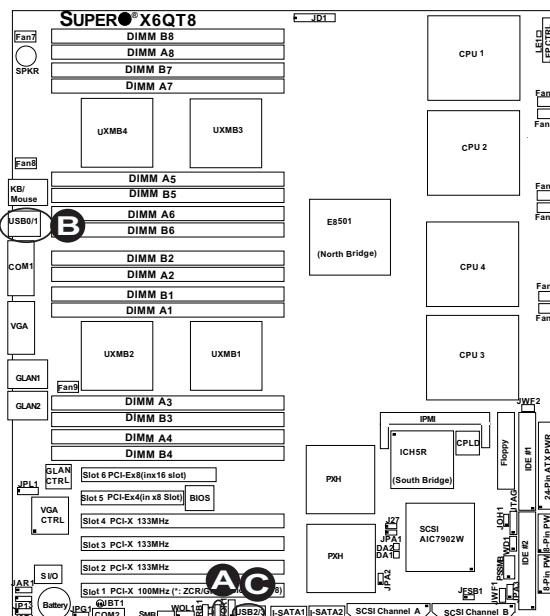

A. Chassis Intrusion

B. USB 0/1

C. USB 2/3

Wake-On-LAN

The Wake-On-LAN header is designated JWOL on the motherboard. See the table on the right for pin definitions. (You must also have a LAN card with a Wake-On-LAN connector and cable to use this feature.)

Wake-On-LAN Pin Definitions (JWOL)	
Pin#	Definition
1	+5V Standby
2	Ground
3	Wake-up

Wake-On-Ring

The Wake-On-Ring header is designated JWOR. This function allows your computer to receive and to be "woken by" an incoming call to the modem when in suspend state. See the table on the right for pin definitions. You must have a Wake-On-Ring card and cable to use this feature.

Wake-On-Ring Pin Definitions (JWOR)	
Pin#	Definition
1	Ground (Black)
2	Wake-up

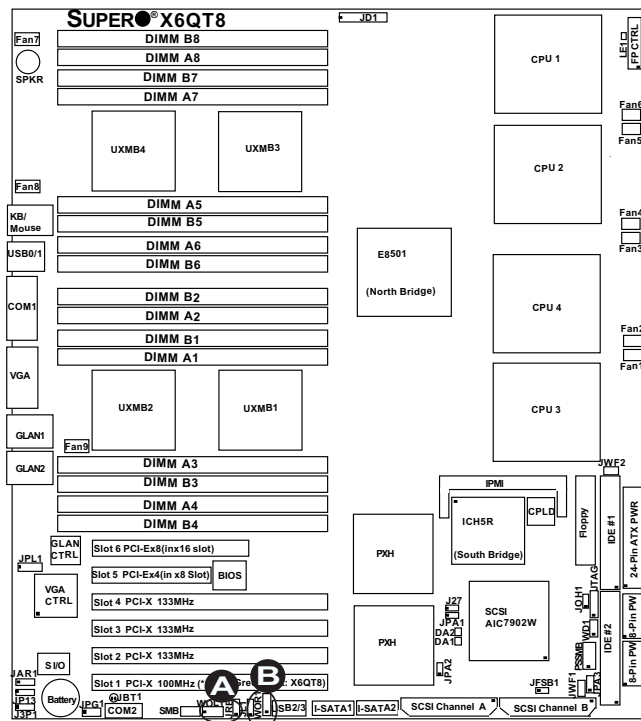

- A. WOL
- B. WOR

Serial Ports

There are one Serial Port-COM1 (JCOM1) and one Serial Header-COM2 (JCOM2) on the motherboard. The Serial Header located at JCOM2 can be accessed from the front panel. See the table on the right for pin definitions.

Pin #	Definition	Pin #	Definition
1	CD	6	DSR
2	RD	7	RTS
3	TD	8	CTS
4	DTR	9	RI
5	Ground	10	NC

Note: Pin 10 is included on the header but not on the port. NC indicates no connection.

GLAN (Giga-bit Ethernet) Ports

Two G-bit Ethernet ports (designated JLAN1/JLAN8) are located on the IO backplane. These ports accept RJ45 type cables.

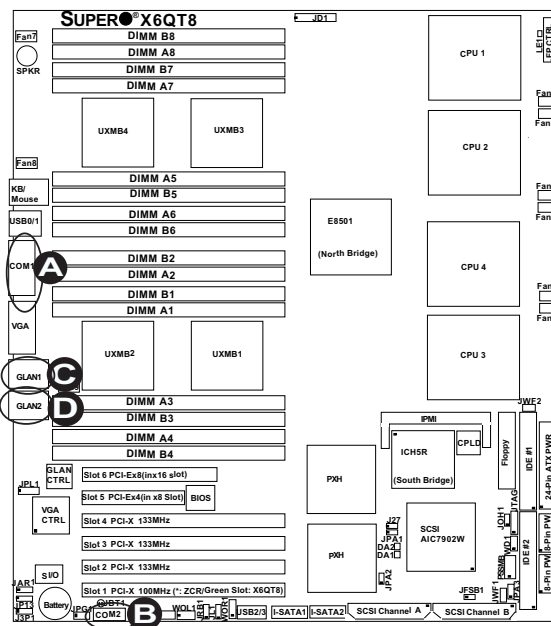

- A. COM1
- B. COM2
- C. GLAN1
- D. GLAN2

ATX PS/2 Keyboard and PS/2 Mouse Ports

The ATX PS/2 keyboard and PS/2 mouse are located at JKM1 on the I/O Backplane. See the table on the right for pin definitions.

PS/2 Keyboard and Mouse Port Pin Definitions	
Pin#	Definition
1	Data
2	NC
3	Ground
4	VCC
5	Clock
6	NC

Fan Headers

There are nine fan headers (Fan 1 to Fan 9) on the motherboard. These Fans are CPU and system cooling fans. See the table on the right for pin definitions. Please refer to "Health Monitoring" in the BIOS Advanced Setting for fan speed control settings.

Fan Header Pin Definitions	
Pin#	Definition
1	Ground (Black)
2	+12V (Red)
3	Tachometer

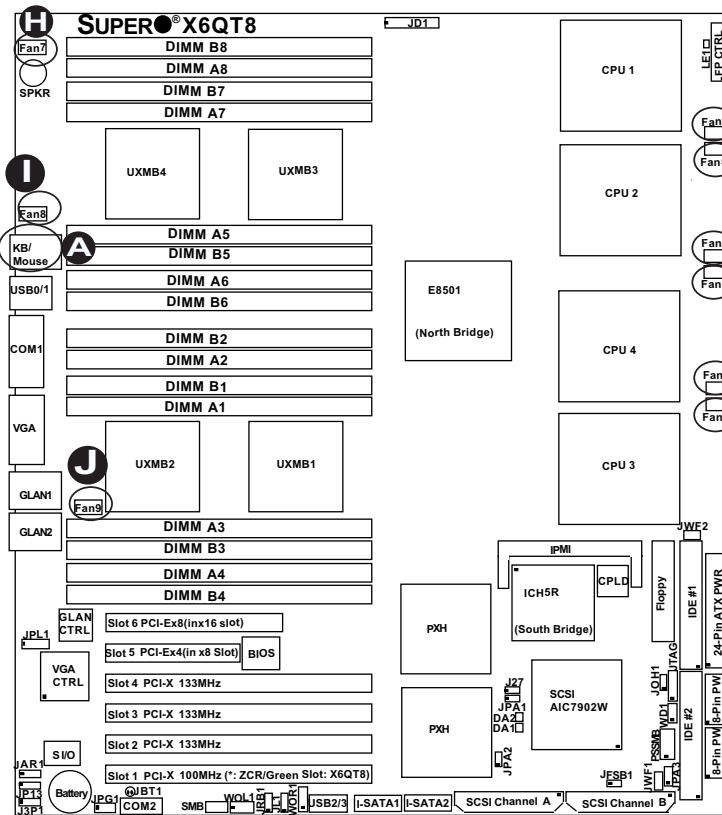

- A. Keyboard/Mouse
- B. Fan1
- C. Fan2
- D. Fan3
- E. Fan4
- F. Fan5
- G. Fan6
- H. Fan7
- I. Fan8
- J. Fan9

VGA Connector

A VGA connector (JVGA1) is located next to the GLAN1 on the IO backplane. Refer to the board layout below for the location.

Power Supply Failure

Connect a cable from your power supply to the J3P1 header to provide a warning of power supply failure. This warning signal is passed through the PWR_LED pin to indicate of a power failure on the chassis. See the table on the right for pin definitions.

PWR Fail Pin Definitions	
Pin#	Definition
1	PWR 1 Fail Signal
2	PWR 2 Fail Signal
3	PWR 3 Fail Signal
4	PWR 4 Fail Signal

Note: This feature is only available when using redundant Supermicro power supplies.

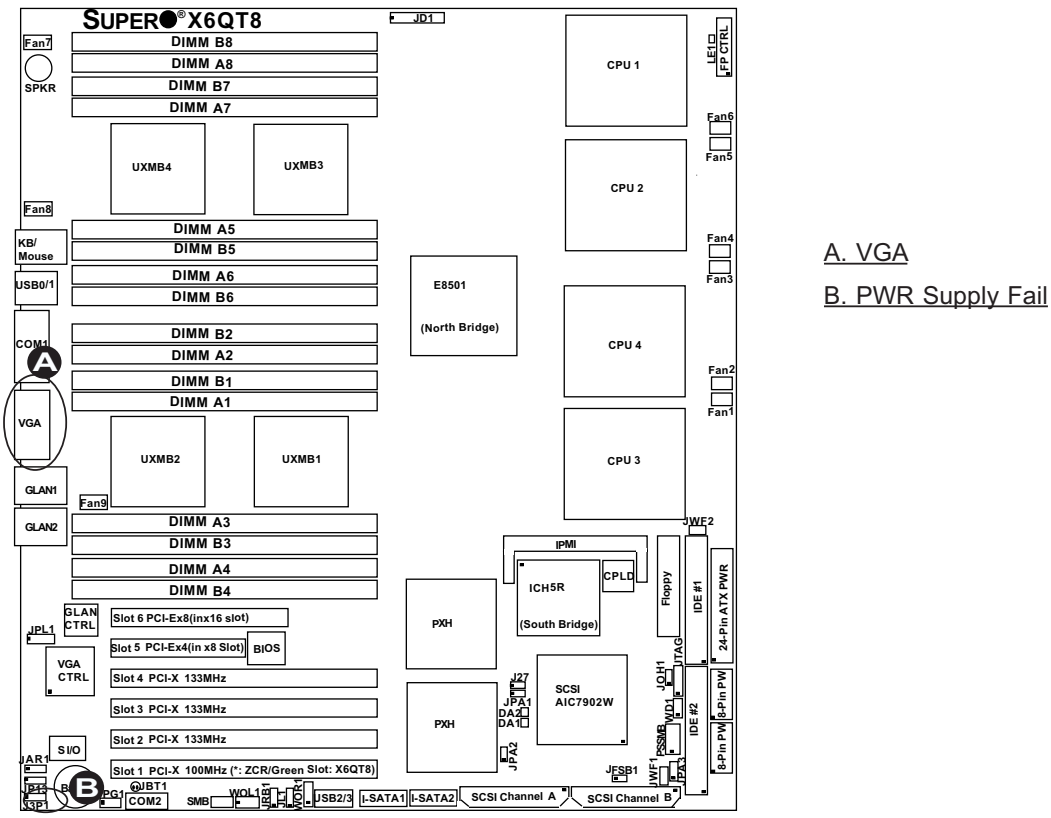

- A. VGA
- B. PWR Supply Fail

SMB Header

A System Management Bus header is located at J22. Connect the appropriate cable here to utilize SMB on your system.

SMB Header Pin Definitions	
Pin#	Definition
1	Data
2	Ground
3	Clock
4	No Connection

SMB Power (I²C) Connector

I²C Connector (PSSMB), located next to the IDE#2 Connector, monitors onboard power supply, fan and system temperatures.

PWR SMB Pin Definitions	
Pin#	Definition
1	Clock
2	Data
3	N/A
4	N/A
5	N/A

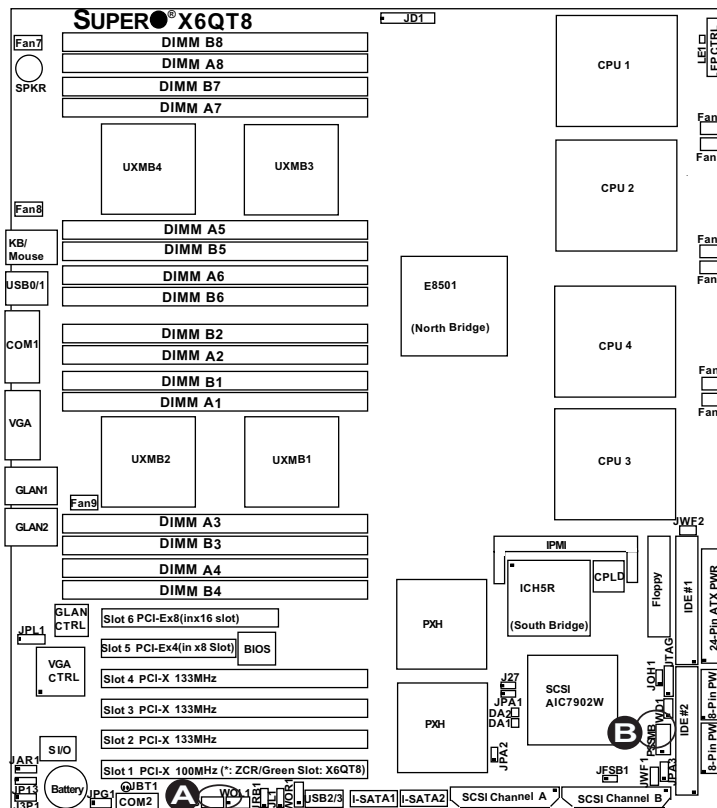

A. SMB
B. PWR SMB

Power LED/Speaker (JD1)

On the JD1 header, pins 1-3 are for a power LED and pins 4-7 are for the speaker. See the table on the right for speaker pin definitions. ***Note:** The speaker connector pins are for use with an external speaker. If you wish to use the onboard speaker, you should close pins 6-7 with a jumper.

Speaker Connector	
Pin Setting	Definition
Pins 6-7	Internal Speaker
Pins 4-7	External Speaker

Compact Flash Card PWR Connectors (JWF1, JWF2)

Two Compact Flash Card Power Connectors are located at JWF1 and JWF2. For Compact Flash Cards to work properly, you will need to connect power cables to JWF1/JWF2. See the tables on the right for details. Refer to the board layout below for the location.

Compact Flash Card PWR Connectors	
Header#	Definition
JWF1	Compact Flash#1 (JIDE1)
JWF2	Compact Flash#2 (JIDE2)

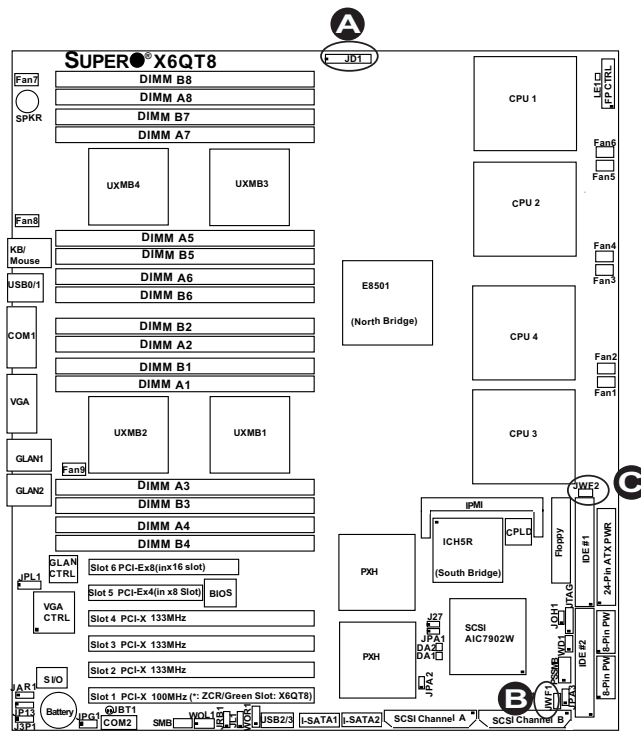

- A. PWR LED/SPKR-JD1
- B. Compact Flash PWR-JWF1
- C. Compact Flash PWR-JWF2

JTAG Connector

JTAG Connector located next to the IDE2 connector allows you to configure the onboard CPLD (-Complex Programmable Logic Device.) See the table on the right for pin definitions.

JTAG Connector	
Pin#	Definition
Pin 1	Ground
Pin 2	TLK
Pin 3	TD0
Pin 4	TD1
Pin 5	TMS
Pin 6	3.3 V

Alarm Reset (JAR1)

The system will notify you in the event of a power supply failure. This feature is only available for chassis with Supermicro redundant power supply units installed. If you only have a single power supply installed, you should not connect anything to this header (JAR1) to prevent false alarms. See the table on the right for jumper settings.

Alarm Reset Jumper Settings	
Jumper Setting	Definition
Open (*Default)	Enabled*
Closed	Disabled

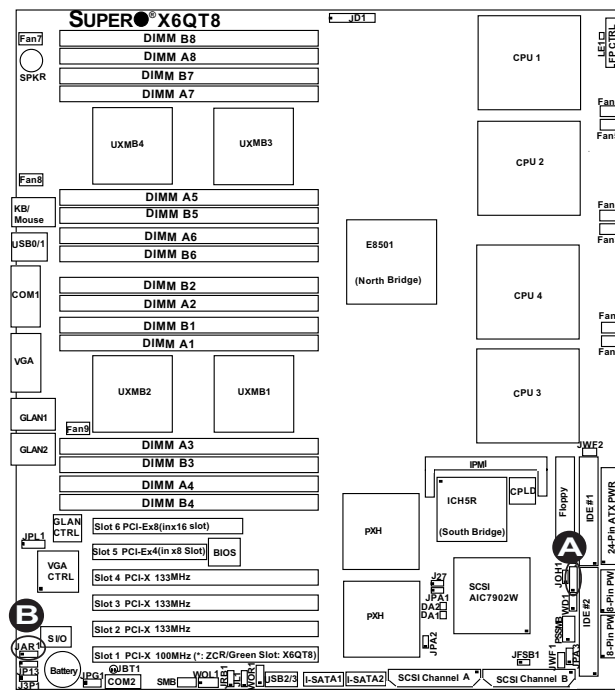

A. JTAG

B. Alarm Reset

2-6 Jumper Settings

Explanation of Jumpers

To modify the operation of the motherboard, jumpers can be used to choose between optional settings. Jumpers create shorts between two pins to change the function of the connector. Pin 1 is identified with a square solder pad on the printed circuit board. See the motherboard layout pages for jumper locations.

Note: On two pin jumpers, "Closed" means the jumper is on and "Open" means the jumper is off the pins.

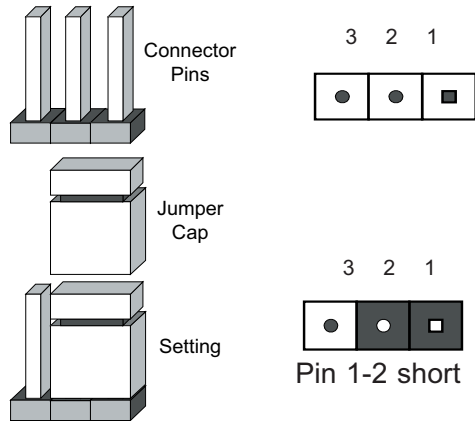

GLAN Ports Enable/Disable

JPL1 enables or disables GLAN ports on the motherboard. When set to Enabled, both GLAN Ports 1 & 2 are enabled. When Disabled, both GLAN Ports 1 & 2 are disabled. See the table on the right for jumper settings.

GLAN Enable Jumper Settings	
Jumper Setting	Definition
Pins 1-2 (*Default)	Enabled*
Pins 2-3	Disabled

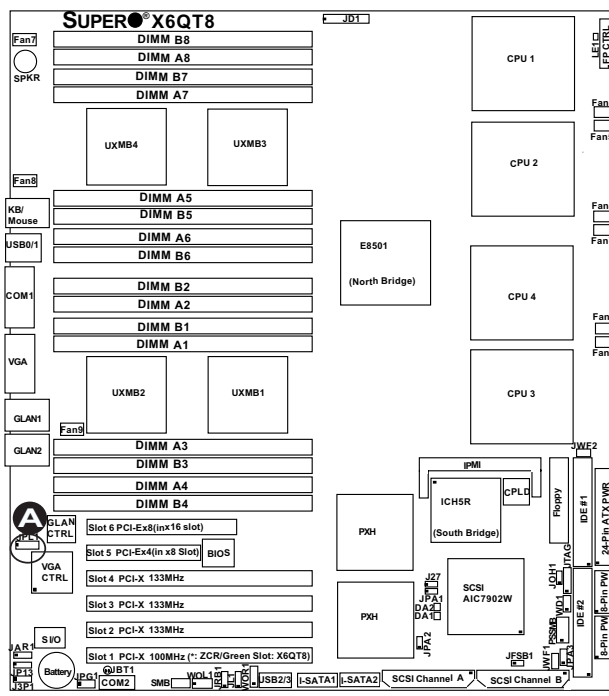

A. GLAN 1/2 Enable

CMOS Clear

JBT1 is used to clear CMOS. Instead of pins, this "jumper" consists of contact pads to prevent the accidental clearing of CMOS. To clear CMOS, use a metal object such as a small screwdriver to touch both pads at the same time to short the connection. Always remove the AC power cord from the system before clearing CMOS. **Note:** For an ATX power supply, you must completely shut down the system, remove the AC power cord and then short JBT1 to clear CMOS.

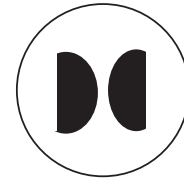

Watch Dog

JWD1 controls Watch Dog, a system monitor that takes actions when a software application hangs. Closing pins 1-2 to allow Watch Dog to reset the system if a program hangs. Closing pins 2-3 will generate a non-maskable interrupt for the program hangs. (This requires software implementation). Watch Dog must also be enabled in the BIOS.

Watch Dog Jumper Settings (JWD)	
Jumper Setting	Definition
Pins 1-2 (*Default)	Reset*
Pins 2-3	NMI
Open	Disabled

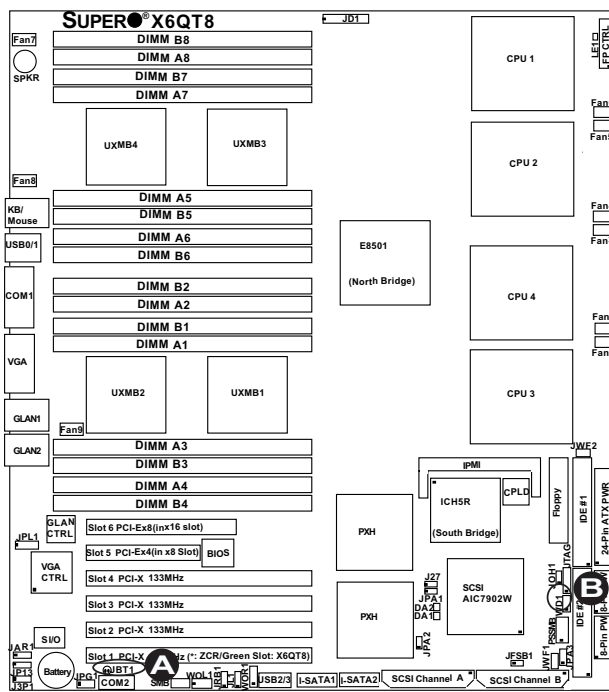

A. Clear CMOS

B. JWD1

VGA Enable/Disable

JPG1 enables or disables the VGA Connector on the motherboard. See the table on the right for jumper settings.

VGA Enable/Disable Jumper Settings	
Jumper Setting	Definition
Pins 1-2 (*Default)	Enabled*
Pins 2-3	Disabled

FSB Speed Select

Front Side Bus Speed Select Jumper located at JFSB1 allows you to set the FSB speed. See the table on the right for jumper settings.

FSB Jumper Settings	
Jumper Setting	Definition
Open (*Default)	200 MHz*
Closed	167 MHz

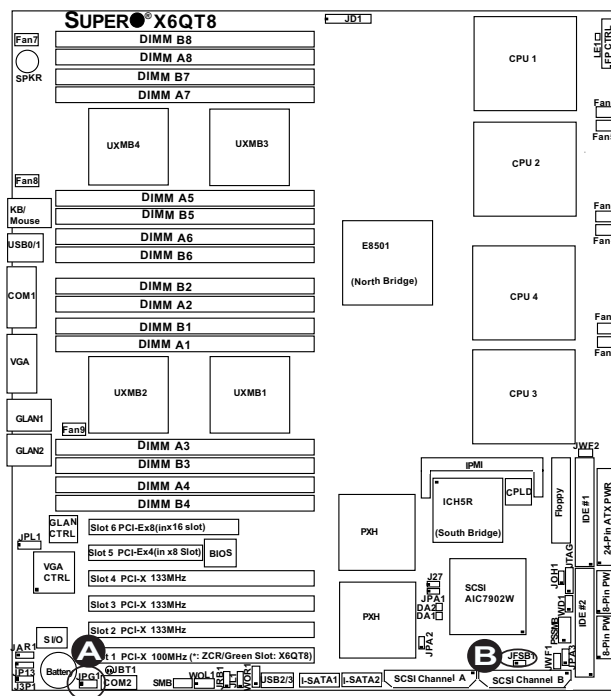

- A. VGA Enable
- B. FSB Speed Select

SCSI Controller Enable/ Disable (*For X6QT8 only)

Jumper JPA1 allows you to enable or disable the SCSI Controller. The default setting is pins 1-2 to enable the SCSI Controller. See the table on the right for jumper settings.

SCSI Enable/Disable Jumper Settings	
Jumper Setting	Definition
Pins 1-2 (*Default)	Enabled
Pins 2-3	Disabled

SCSI Termination Enable/ Disable (*For X6QT8 only)

Jumper JPA2 allows you to enable or disable SCSI Channel A Termination, and JPA3, for SCSI Channel B Termination. The default setting is **open** to enable the termination of the SCSI connectors. (*Note: For the SCSI drives to function properly, please do not change the default setting set by the manufacturer.) See the table on the right for jumper settings.

SCSI Termination Enable/Disable Jumper Settings	
Jumper Setting	Definition
Open (*Default)	Enabled
Closed	Disabled

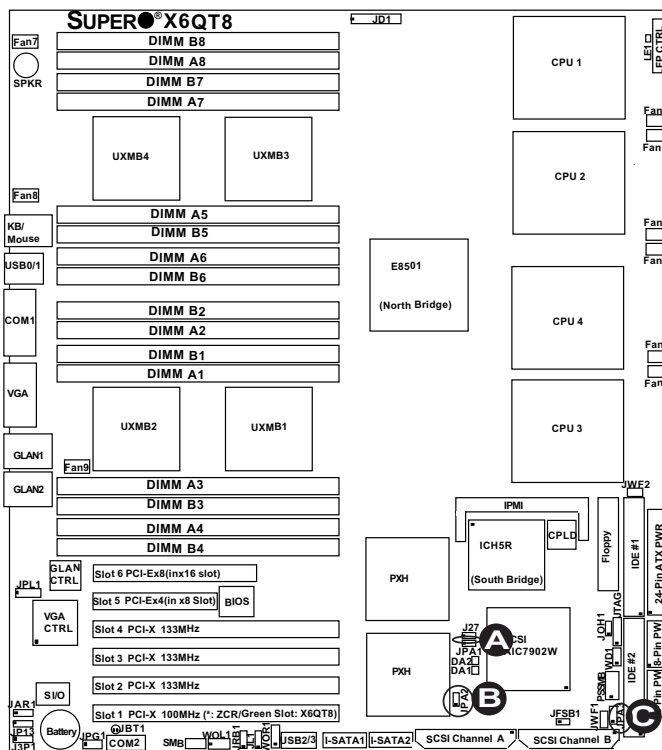

- A. SCSI Controller Enable
- B. SCSI Channel A Term. Enable
- C. SCSI Channel B Term. Enable

3rd PWR Supply PWR Failure Detect (JP13)

This function allows the system to notify you in the event of a power supply failure. This feature assumes that three power supply units are installed in the chassis, with one acting as a backup. If you only have one or two power supply units installed, you should disable this jumper to prevent false alarms.

3rd PWR Supply PWR Fault Jumper Settings	
Jumper Setting	Definition
Closed	Enabled
Open (*Default)	Disabled*

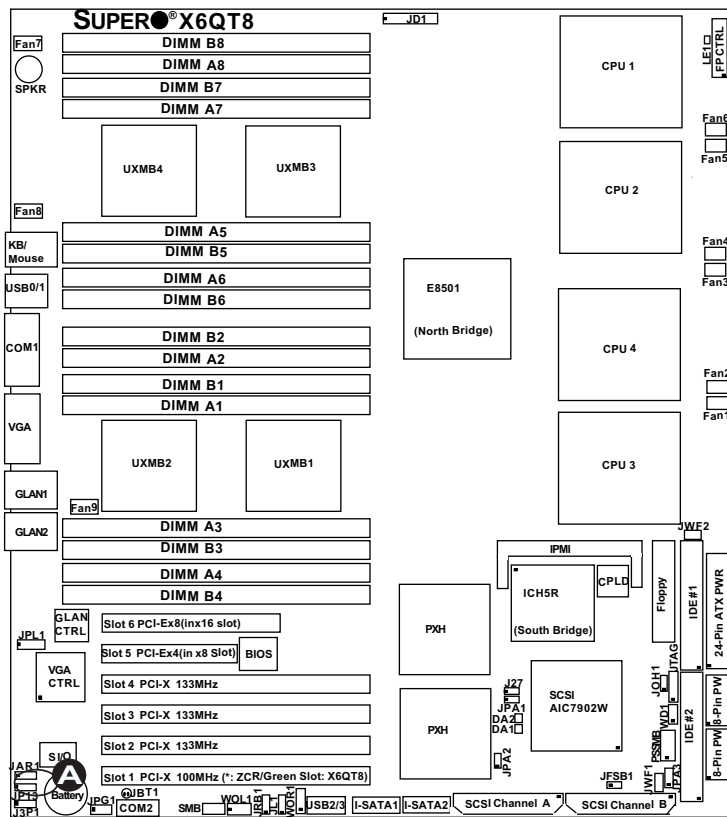

A. 3rd PWR Fail Detect

2-7 Onboard Indicators

GLAN LEDs

There are two Gigabit Ethernet LAN ports (located beside the Video port) on the motherboard. Each GLAN port has two LEDs. The blinking Amber LED indicates activity while the other LED may be green, amber or off to indicate the speed of the connection. See the table at right for the functions associated with the second LED.



GLAN Left LED Connection Speed Indicator	
LED Color	Definition
Off	10Mbps or No Connection
Green	100 Mbps
Amber	1 Gbps

GLAN Right LED Activity Indicator	
LED Color	Definition
Amber	Flashing: Active

Overheat LED (JOH1)

The JOH1 header is used to connect an LED to provide warnings of chassis overheating. Refer to the layout below for the location. Also See the table on the right for pin definitions.

Overheat LED Pin Definitions	
Pin#	Definition
1	5vDC
2	OH Active

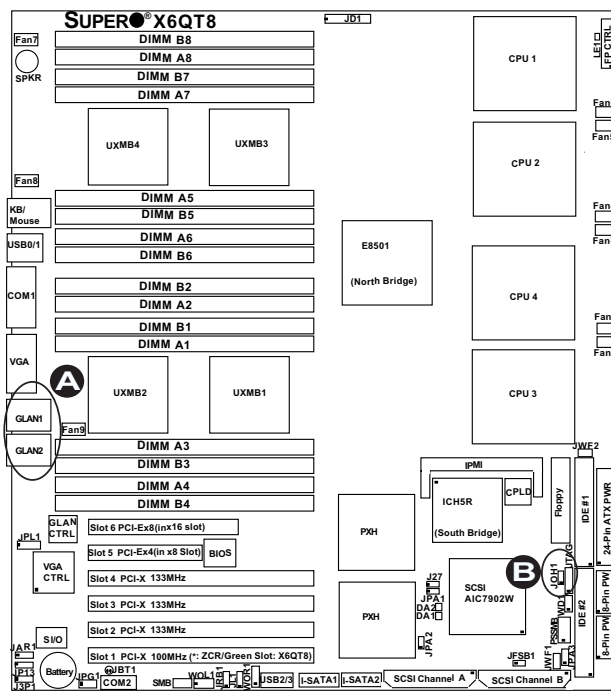

- A. GLAN LEDs
- B. Overheat LED

SCSI Channel Indicators (DA1, DA2) (*X6QT8 only)

There are two SCSI Channel Status LEDs (DA1, DA2) on the motherboard. DA1 indicates the SCSI Channel A activity, and DA 2, Channel B. See the layout below for DA1 and DA2 locations.

Onboard Power LED (LE1)

There is an Onboard Power LED (LE1) located on the motherboard. When LE1 is off, the system is off. When the green light is on, the system is on. See the layout below for the LED location.

Onboard PWR LED Indicator (LE1)	
LED Color	Definition
Off	System Off
Green	System On

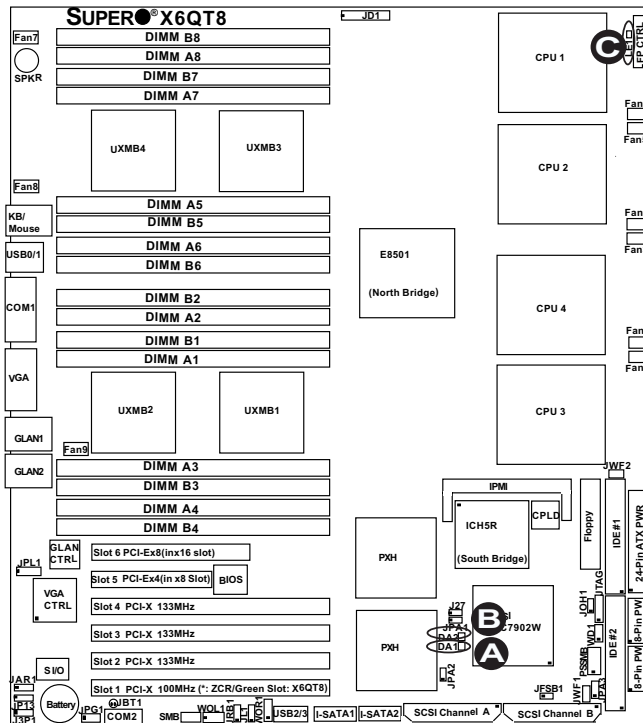

- A. DA1
- B. DA2
- C. LE1

2-8 Floppy, IPMI, Hard Disk Drive and SCSI Connections

Note the following when connecting the floppy and hard disk drive cables:

- The floppy disk drive cable has seven twisted wires.
- A red mark on a wire typically designates the location of pin 1.
- A single floppy disk drive ribbon cable has two connectors to provide for two floppy disk drives. The connector with twisted wires always connects to drive A, and the connector that does not have twisted wires always connects to drive B.

Floppy Connector

The floppy connector is located at JFDD1. See the table below for pin definitions.

Floppy Drive Connector Pin Definitions (Floppy)			
Pin#	Definition	Pin #	Definition
1	Ground	2	FDHDIN
3	Ground	4	Reserved
5	Key	6	FDEDIN
7	Ground	8	Index
9	Ground	10	Motor Enable
11	Ground	12	Drive Select B
13	Ground	14	Drive Select B
15	Ground	16	Motor Enable
17	Ground	18	DIR
19	Ground	20	STEP
21	Ground	22	Write Data
23	Ground	24	Write Gate
25	Ground	26	Track 00
27	Ground	28	Write Protect
29	Ground	30	Read Data
31	Ground	32	Side 1 Select
33	Ground	34	Diskette

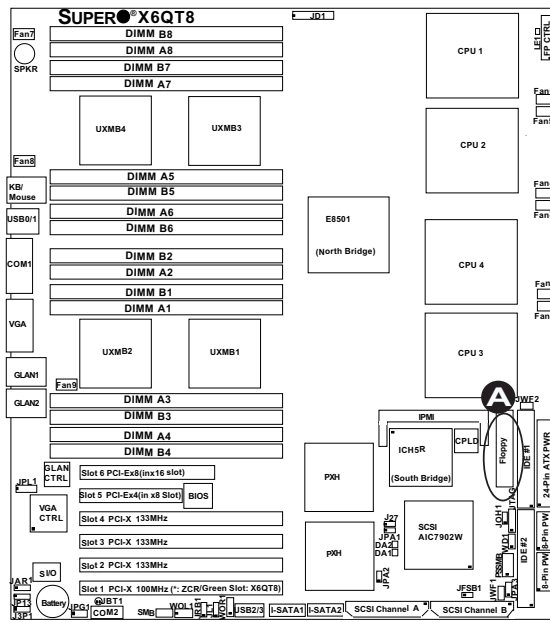

A. Floppy

IDE Connectors

There are no jumpers to configure the onboard IDE#1 and IDE #2. Both IDE#1 and IDE#2 support Compact Flash Cards. When a compact card is used, you will need to connect a power cable to its power connector to provide adequate power to the drive. (JWF1: IDE#1, JWF2: IDE#2.) See the table on the right for pin definitions.

IDE Drive Connectors Pin Definitions (IDE)			
Pin#	Definition	Pin #	Definition
1	Reset IDE	2	Ground
3	Host Data 7	4	Host Data 8
5	Host Data 6	6	Host Data 9
7	Host Data 5	8	Host Data 10
9	Host Data 4	10	Host Data 11
11	Host Data 3	12	Host Data 12
13	Host Data 2	14	Host Data 13
15	Host Data 1	16	Host Data 14
17	Host Data 0	18	Host Data 15
19	Ground	20	Key
21	DRQ3	22	Ground
23	I/O Write	24	Ground
25	I/O Read	26	Ground
27	IOCHRDY	28	BALE
29	DACK3	30	Ground
31	IRQ14	32	IOCS16
33	Addr1	34	Ground
35	Addr0	36	Addr2
37	Chip Select 0	38	Chip Select 1
39	Activity	40	Ground

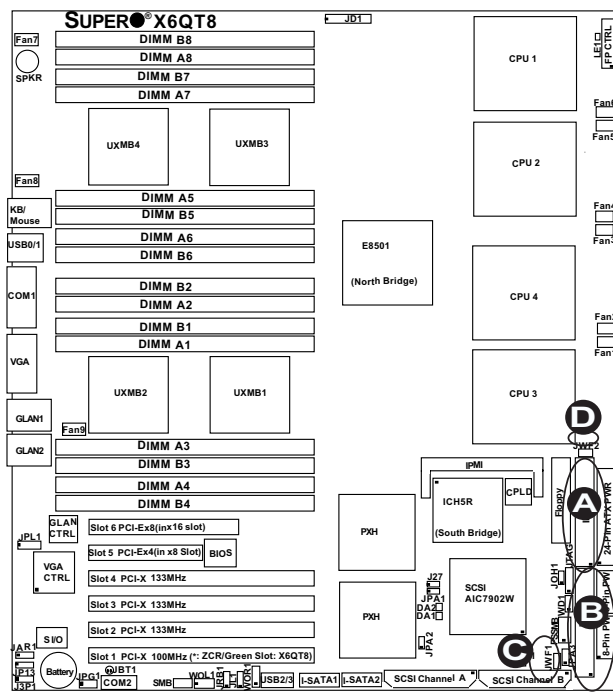

- A. IDE 1
- B. IDE 2
- C. JWF1
- D. JWF2

Ultra320 SCSI Connectors (*X6QT8 Only)

Refer to the table below for the pin definitions of the Ultra320 SCSI connectors: SCSI Channel A (located at JA1) and SCSI Channel B (located at JA2.)

IPMI 2.0 Socket

An IPMI 2.0 Socket is located on the motherboard. Refer to the layout below for the IPMI Socket location.

- A. SCSI Channel A
- B. SCSI Channel B
- C. IPMI 2.0 Socket

Ultra320 SCSI Drive Connector Pin Definitions			
Pin#	Definition	Pin #	Definition
1	+DB (12)	35	-DB (12)
2	+DB (13)	36	-DB (13)
3	+DB (14)	37	-DB (14)
4	+DB (15)	38	-DB (15)
5	+DB (P1)	39	-DB (P1)
6	+DB (0)	40	-DB (0)
7	+DB (1)	41	-DB (1)
8	+DB (2)	42	-DB (2)
9	+DB (3)	43	-DB (3)
10	+DB (4)	44	-DB (4)
11	+DB (5)	45	-DB (5)
12	+DB (6)	46	-DB (6)
13	+DB (7)	47	-DB (7)
14	+DB (P)	48	-DB (P)
15	Ground	49	Ground
16	DIFFSENS	50	Ground
17	TERMPWR	51	TERMPWR
18	TERMPWR	52	TERMPWR
19	Reserved	53	Reserved
20	Ground	54	Ground
21	+ATN	55	-ATN
22	Ground	56	Ground
23	+BSY	57	-BSY
24	+ACK	58	-ACK
25	+RST	59	-RST
26	+MSG	60	-MSG
27	+SEL	61	-SEL
28	+C/D	62	-C/D
29	+REQ	63	-REQ
30	+I/O	64	-I/O
31	+DB (8)	65	-DB (8)
32	+DB (9)	66	-DB (9)
33	+DB (10)	67	-DB (10)
34	+DB (11)	68	-DB (11)

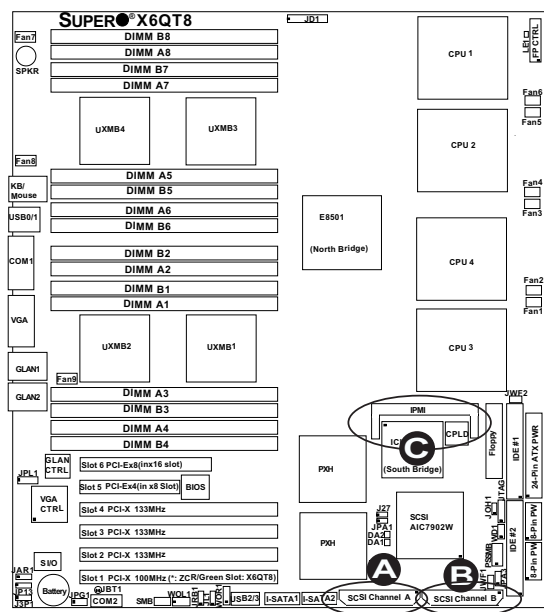

Notes

Chapter 3

Troubleshooting

3-1 Troubleshooting Procedures

Use the following procedures to troubleshoot your system. If you have followed all of the procedures below and still need assistance, refer to the 'Technical Support Procedures' and/or 'Returning Merchandise for Service' section(s) in this chapter.

***Note: Always disconnect the power cord before adding, changing or installing any hardware components.**

Before Power On

1. Make sure that there are no short circuits between the motherboard and chassis.
2. Install one CPU (making sure it is fully seated) at a time, connect the chassis speaker and the power LED to the motherboard. (Check all jumper settings as well.)
3. Use only the correct type of CMOS battery as recommended by the Manufacturer. Do not install the battery upside down to avoid possible explosion.

No Power

1. Make sure that there are no short circuits between the motherboard and chassis.
2. Make sure that all jumpers are set to their default positions.
3. Make sure that the 115V/230V switch on the power supply is properly set.
4. Turn the power switch on and off to test the system.
5. The battery on your motherboard may be old. Check to verify that it still supplies ~3VDC. If it does not, replace it with a new one.

No Video

1. If the power is on, but you have no video, remove add-on cards, if possible to simplify system configuration.
2. Use the speaker to determine if any beep codes exist. Refer to Appendix A and Appendix B for details on beep codes.
 - 2a. Check if the onboard video is enabled through Jumper JPG1.
 - 2b. Remove all memory modules to make sure that the system gives alarms for no memory. If the system beeps, memory modules can be bad or incompatible. See Section 2-3 for more information on supported memory.

Losing the System's Setup Configuration

1. Make sure that you are using a high quality power supply. A poor quality power supply may cause the system to lose the CMOS setup. Refer to Section 1-6 for details on recommended power supplies.

2. The battery on your motherboard may be old. Check to verify that it still supplies ~3VDC. If it does not, replace it with a new one.
3. If the above steps do not fix the Setup Configuration problem, contact your vendor for repairs.

NOTE

If you are a system integrator, VAR or OEM, a POST diagnostics card is recommended. For I/O port 80h codes, refer to Appendix B.

Memory Errors

1. Make sure that all DIMM modules are properly and fully installed.
2. Determine if different speeds of DIMMs have been installed and verify that the BIOS setup is configured for the fastest speed of RAM used. It is recommended to use the same RAM speed for all DIMMs in the system.
3. Make sure that you are using the correct type of Registered, ECC DDR2 533/400 SDRAM (*recommended by the manufacturer.)
4. Check for bad DIMM modules or slots by swapping a single module between two slots and noting the results.
5. Make sure that all memory modules are fully seated in their slots. As an interleaved memory scheme is used, you must install two modules at a time. (See Section 2-3).
6. Check the position of the 115V/230V switch on the power supply.

3-2 Technical Support Procedures

Before contacting Technical Support, please take the following steps. Also, note that as a motherboard manufacturer, Supermicro does not sell directly to end-users, so it is best to first check with your distributor or reseller for troubleshooting services. They should know of any possible problem(s) with the specific system configuration that was sold to you.

1. Please go through the 'Troubleshooting Procedures' and 'Frequently Asked Question' (FAQ) sections in this chapter or see the FAQs on our web site (at <http://www.supermicro.com/support/faqs/>) before contacting Technical Support.
2. BIOS upgrades can be downloaded from our web site at <http://www.supermicro.com/support/bios/>.

Note: Not all BIOS can be flashed, it depends on the modifications done to the boot block code.

3. If you still cannot resolve the problem, include the following information when contacting Super Micro for technical support:

- Motherboard model and PCB revision number
- BIOS release date/version (this can be seen on the initial display when your system first boots up)
- System configuration

An example of a Technical Support form is on our web site at <http://www.supermicro.com/support/contact.cfm/>.

4. Distributors: For immediate assistance, please have your account number ready when placing a call to our technical support department. We can be reached by e-mail at support@supermicro.com, by phone at:(408) 503-8000, option 2, or by fax at (408)503-8019.

3-3 Frequently Asked Questions

Question: What are the various types of memory that my motherboard can support?

Answer: The X6QT8/X6QTE+ has 16 240-pin DIMM slots that support registered ECC DDR2 533/400 SDRAM modules. It is strongly recommended that you do not mix memory modules of different speeds and sizes.

Question: How do I update my BIOS?

Answer: It is recommended that you **do not** upgrade your BIOS if you are not experiencing any problem with your system. Updated BIOS files are located in our web site at <http://www.supermicro.com/support/bios/>. Please check our BIOS warning message and the information on how to update your BIOS on our web site. Also, check the current BIOS revision and make sure it is newer than your BIOS before downloading.

Question: What's on the CD that came with my motherboard?

Answer: The supplied compact disc has quite a few drivers and programs that will greatly enhance your system. We recommend that you review the CD and install the applications you need. Applications on the CD include chipset drivers for Windows and security and audio drivers.

3-4 Returning Merchandise for Service

A receipt or copy of your invoice marked with the date of purchase is required before any warranty service will be rendered. You can obtain service by calling your vendor for a Returned Merchandise Authorization (RMA) number. When returning to the manufacturer, the RMA number should be prominently displayed on the outside of the shipping carton, and mailed prepaid or hand-carried. Shipping and handling charges will be applied for all orders that must be mailed when service is complete.

This warranty only covers normal consumer use and does not cover any damage incurred in shipping or from failure due to the alternation, misuse, abuse or improper maintenance of products.

During the warranty period, contact your distributor first for any product problems.

Chapter 4

AMIBIOS

4-1 Introduction

This chapter describes the AMIBIOS Setup Utility for the X6QT8/X6QTE+. The AMI ROM BIOS is stored in a Flash EEPROM and can be easily updated using a floppy disk-based program. This chapter describes the basic navigation of the AMIBIOS Setup Utility setup screens.

Starting BIOS Setup Utility

To enter the AMIBIOS Setup Utility screens, hit the <Delete> key while the system is booting up.

(***Note:** In most cases, the <Delete> key is used to invoke the AMIBIOS setup screen. There are a few cases when other keys are used, such as <F1>, <F2>, etc.)

Each main BIOS menu option is described in this user's guide. The Main BIOS setup menu screen has two main frames. The left frame displays all the options that can be configured. "Grayed-out" options cannot be configured. Options in blue can be configured by the user. The right frame displays the key legend. Above the key legend is an area reserved for a text message. When an option is selected in the left frame, it is highlighted in white. Often a text message will accompany it. (***Note:** the AMI BIOS has default text messages built in. Supermicro retains the option to include, omit, or change any of these text messages.)

The AMIBIOS Setup Utility uses a key-based navigation system called hot keys. Most of the AMIBIOS setup utility hot keys can be used at any time during the setup navigation process. These keys include <F1>, <F10>, <Enter>, <ESC>, arrow keys, and etc. (***Note:** Options printed in **Bold** are default settings.)

How To Change the Configuration Data

The configuration data that determines the system parameters may be changed by entering the AMI BIOS Setup utility. This Setup utility can be accessed by pressing at the appropriate time during system boot.

Starting the Setup Utility

Normally, the only visible POST (Power On Self Test) routine is the memory test. As the memory is being tested, press the <Delete> key to enter the main menu of the AMI BIOS Setup Utility. From the main menu, you can access the other setup screens. An AMIBIOS identification string is displayed at the left bottom corner of the screen, below the copyright message.



Warning!! Do not shut down or reset the system while updating BIOS to prevent possible boot failure.

4-2 Main Setup

When you first enter the AMI BIOS Setup Utility, you will enter the Main setup screen. You can always return to the Main setup screen by selecting the **Main** tab on the top of the screen. The Main BIOS Setup screen is shown below.

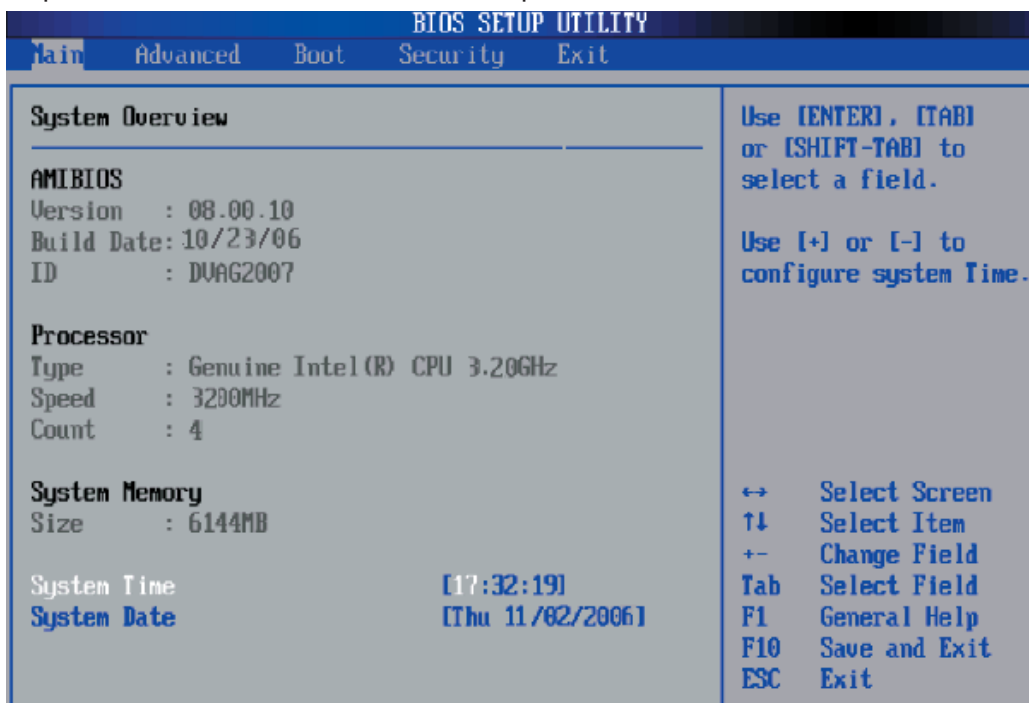

When you select the Main Setup, the following items will be automatically displayed:

System Overview: The following BIOS information will be displayed:

AMIBIOS

Version
Build Date
ID

Processors

When you select this option, the AMI BIOS will automatically display the status of processors as shown below:

Type
Speed
Count

System Memory

This option allows the AMI BIOS to display the status of memory installed in the system.

System Time/System Date

Use this option to change the system time and date. Highlight *System Time* or *System Date* using the arrow keys. Enter new values through the keyboard. Press the <Tab> key or the arrow keys to move between fields. The date must be entered in DAY/MM/DD/YY format. The time is entered in HH:MM:SS format. (***Note:** The time is in 24-hour format. For example, 5:30 A.M. appears as 05:30:00, and 5:30P. M. as 17:30:00.)

4-3 Advanced Settings

The Advanced Settings screen and sub menus are listed below:

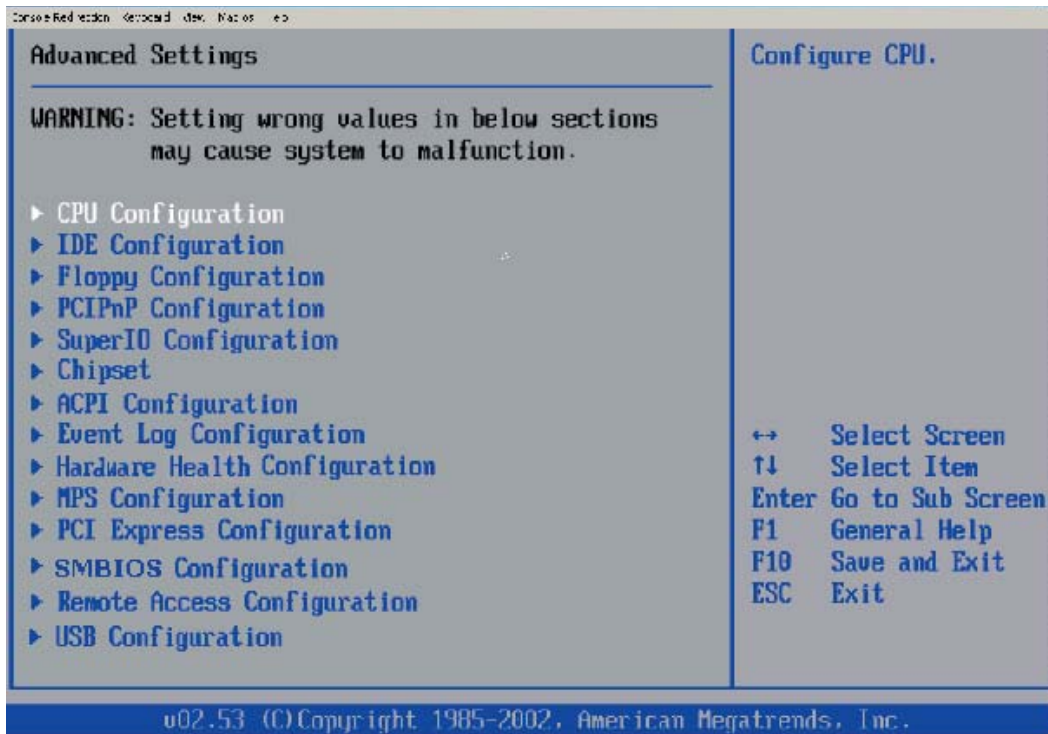

Warning



When you first enter the Advanced Setup screen, the Setup Warning will be displayed. Please follow the instruction and set the correct value for each item to prevent the system from malfunctioning.

► CPU Configuration Sub-Menu

Configure Advanced CPU Settings

This option allows the user to configure the Advanced CPU settings for the processor(s) installed in the system.

Ratio CMOS Setting (*Available when SpeedStep is disabled.)

This option allows the user to set the ratio between the CPU Core Clock and the FSB frequency. The default setting is 16.

L3 Cache (*Available when supported by the OS and the CPU.)

Select **Enabled** to enable L3 (Level 3) Cache in the CPU. The options are **Enabled** and **Disabled**.

Hardware Prefetcher (*Available when supported by the OS and the CPU.)

If set to "Enabled," the hardware prefetcher will pre-fetch streams of data and instructions from main memory to L2 cache in the forward or backward manner to improve CPU performance. The options are **Disabled** and **Enabled**.

Adjacent Cache Line Prefetch (*Available when supported by the OS and the CPU.)

The CPU fetches the cache line for 64 bytes if this option is set to Disabled. The CPU fetches both cache lines for 128 bytes as comprised if Enabled. The options are Disabled and **Enabled**.

Max CPUID Value Limit

This feature allows the user to set the maximum CPU ID value. Enable this function to boot the legacy operating systems that cannot support processors with extended CPUID functions. The options are Enabled and **Disabled**.

Vanderpool Technology (*Available when supported by the CPU.)

Set to Enabled to utilize enhanced virtualization capabilities provided by the Intel Vanderpool Technology to allow one platform to run multiple operating systems and applications in independent partitions, creating multiple "virtual" systems in one physical computer. The options are **Enabled** and Disabled. (*Note: If there is any change to this setting, you will need to power off and restart the system for the change to take effect.) Refer to Intel's web site for detailed information.

Execute Disable Bit (*Available when supported by the OS and the CPU.)

Set to **Enabled** to enable the Execute Disable Bit to allow the processor to classify areas in the system memory where an application code can execute and where it cannot, thus preventing a worm or a virus from creating a flood of codes to overwhelm the processor or damage the system during an attack. (Note: For more information regarding hardware/software support for this function, please refer to Intel's and Microsoft's web sites.

Single Logical Processor Mode (*Available when supported by the CPU.)

Select Enabled to allow the processor to operate in the single core mode, allowing Logical Processor 0 CORE 0 to remain active. The options are Enabled and **Disabled**.

Hyper-Threading Technology

This setting allows you to **Enable** or Disable the function of Hyper-Threading. Enabling Hyper-Threading results in increased CPU performance.

Intel (R) SpeedStep (tm) Technology (*Available when supported by the CPU.)

The Enhanced Intel SpeedStep Technology allows the system to automatically adjust processor voltage and core frequency in an effort to reduce power consumption and heat dissipation. Select Maximum to set the CPU speed to the maximum. Select Minimum to set the CPU speed to the minimum. Select Auto to allow the CPU speed to be controlled by the OS. Select **Disabled** to disable this feature. **(Refer to Intel's web site for detailed information.)**

Intel (R) C-State Technology

C1 Configuration Mode (*Available when supported by the CPU.)

Select **Standard** to enable the C1 Halt State to partially turn off the CPU internal clocks to conserve energy and prevent system overheating when the OS is idle. Select **Enhanced** to enable the Enhanced C1 Halt State to lower the CPU clock frequency and the supply voltage before turning off the clocks.

► IDE Configuration Sub-Menu

When this sub-menu is selected, the AMI BIOS automatically displays the following items:

IDE Configuration

This feature allows the user to configure the IDE mode. The options are **Disabled**, **P-ATA** (Parallel ATA) only, **S-ATA** (Serial ATA) only and **P-ATA & S-ATA**.

Combined Mode Operation

This feature allows the user to select the IDE Combined Mode. The options are **P-ATA 1st Channel** and **S-ATA 1st Channel**.

S-ATA Ports Definition

This feature allows the user to configure the Serial ATA Ports. The options are **P0-Master/P1-Slave** and **P0-Slave/P1-Master**.

Primary IDE Channel Master/Slave, Secondary IDE Channel Master/Slave

These settings allow the user to set the parameters of Primary IDE Channel Master/Slave and Secondary IDE Channel Master/Slave slots. Hit <Enter> to activate the following sub-menu screen for detailed options of these items. Set the correct configurations accordingly. The items included in the sub-menu are:

Type

Select the type of device connected to the system. The options are **Not Installed**, **Auto**, **CDROM** and **ARMD**.

LBA/Large Mode

LBA (Logical Block Addressing) is a method of addressing data on a disk drive. In the LBA mode, the maximum drive capacity is 137 GB. For drive capacities over 137 GB, your system must be equipped with a 48-bit LBA mode addressing. If not, contact your manufacturer or install an ATA/133 IDE controller card that supports 48-bit LBA mode. The options are **Disabled** and **Auto**.

Block (Multi-Sector Transfer)

Block Mode boosts the IDE drive performance by increasing the amount of data transferred. Only 512 bytes of data can be transferred per interrupt if Block Mode is not used. Block Mode allows transfers of up to 64 KB per interrupt. Select "Disabled" to allow the data to be transferred from and to the device one sector at a time. Select "Auto" to allow the data transfer from and to the device occur multiple sectors at a time if the device supports it. The options are **Auto** and **Disabled**.

PIO Mode

The IDE PIO (Programmable I/O) Mode programs timing cycles between the IDE drive and the programmable IDE controller. As the PIO mode increases, the cycle time decreases. The options are **Auto**, 0, 1, 2, 3, and 4. Select Auto to allow the AMI BIOS to automatically detect the PIO mode. Use this value if the IDE disk drive support cannot be determined. Select 0 to allow the AMI BIOS to use PIO mode 0. It has a data transfer rate of 3.3 MBs. Select 1 to allow the AMI BIOS to use PIO mode 1. It has a data transfer rate of 5.2 MBs. Select 2 to allow the AMI BIOS to use PIO mode 2. It has a data transfer rate of 8.3 MBs. Select 3 to allow the AMI BIOS to use PIO mode 3. It has a data transfer rate of 11.1 MBs. Select 4 to allow the AMI BIOS to use PIO mode 4. It has a data transfer rate of 16.6 MBs. This setting generally works with all hard disk drives manufactured after 1999. For other disk drives, such as IDE CD-ROM drives, check the specifications of the drive.

DMA Mode

Select Auto to allow the BIOS to auto detect the DMA mode. Use this value if the IDE disk drive support cannot be determined. Select SWDMA0 to allow the BIOS to use Single Word DMA mode 0. It has a data transfer rate of 2.1 MBs. Select SWDMA1 to allow the BIOS to use Single Word DMA mode 1. It has a data transfer rate of 4.2 MBs. Select SWDMA2 to allow the BIOS to use Single Word DMA mode 2. It has a data transfer rate of 8.3 MBs. Select MWDMA0 to allow the BIOS to use Multi Word DMA mode 0. It has a data transfer rate of 4.2 MBs. Select MWDMA1 to allow the BIOS to use Multi Word DMA mode 1. It has a data transfer rate of 13.3 MBs. Select MWDMA2 to allow the BIOS to use Multi-Word DMA mode 2. It has a data transfer rate of 16.6 MBs. Select UDMA0 to allow the BIOS to use Ultra DMA mode 0. It has a data transfer rate of 16.6 MBs. It has the same transfer rate as PIO mode 4 and Multi Word DMA mode 2. Select UDMA1 to allow the BIOS to use Ultra DMA mode 1. It has a data transfer rate of 25 MBs. Select UDMA2 to allow the BIOS to use Ultra DMA mode 2. It has a data transfer rate of 33.3 MBs. Select UDMA3 to allow the BIOS to use Ultra DMA mode 3. It has a data transfer rate of 66.6 MBs. Select UDMA4 to allow the BIOS to use Ultra DMA mode 4. It has a data transfer rate of 100 MBs. The options are **Auto**, SWDMA_n, MWDMA_n, and UDMA_n.

S.M.A.R.T. For Hard disk drives

Self-Monitoring Analysis and Reporting Technology (SMART) can help predict impending drive failures. Select "Auto" to allow the AMI BIOS to auto detect hard disk drive support. Select "Disabled" to prevent the AMI BIOS from using the S.M.A.R.T. Select "Enabled" to allow the AMI BIOS to use the S.M.A.R.T. to support hard drive disk. The options are Disabled, Enabled, and **Auto**.

32-Bit Data Transfer

Select **Enabled** to activate the function of 32-Bit data transfer. Select "Disabled" to disable this function. The options are **Enabled** and Disabled.

Hard Disk Write Protect

Select Enabled to enable the function of Hard Disk Write Protect to prevent data from being written to HDD. The options are Enabled or **Disabled**.

IDE Detect Time Out

This feature allows the user to set the time-out value for detecting ATA, ATA PI devices installed in the system. The options are 0 (sec), 5, Mode 1.0, 15, 20, 25, 30, and **35**.

ATA(PI) 80Pin Cable Detection

This feature allows the AMI BIOS to auto-detect 80Pin ATA(PI) Cable. The options are **Host & Device**, Host and Device.

►Floppy Configuration

This option allows the user to configure the settings for the Floppy Drives installed in the system.

Floppy A/Floppy B

Move the cursor to these fields via up and down arrow keys to select the floppy type. The options are Disabled, 360 KB 5 1/4", 1.2 MB 5 1/4", 720 KB 3 1/2", **1.44 MB 3 1/2"**, and 2.88 MB 3 1/2".

►PCI/PnP Configuration

This feature allows the user to set the PCI/PnP configurations for the following items:

Clear NVRAM

Select Yes to clear NVRAM during system boot. The options are Yes and **No**.

Plug & Play OS

Select Yes to allow the OS to configure Plug & Play devices. (*This is not required for system boot if you system has an OS that supports Plug & Play.) Select **No** to allow the AMI BIOS to configure all devices in the system.

PCI Latency Timer

This option sets the latency of all PCI devices on the PCI bus. The default setting is **"64."** Select "32" to set the PCI latency to 32 PCI clock cycles. Select "64" to set the PCI latency to 64 PCI clock cycles. Select "96" to set the PCI latency to 96 PCI clock cycles. Select "128" to set the PCI latency to 128 PCI clock cycles. Select "160" to set the PCI latency to 160 PCI clock cycles. Select "192" to set the PCI latency to 192 PCI clock cycles. Select "224" to set the PCI latency to 224 PCI clock cycles. Select "248" to set the PCI latency to 248 PCI clock cycles.

Allocate IRQ to PCI VGA

Set this value to allow or restrict the system from giving the VGA adapter card an interrupt address. The options are **Yes** and No.

Palette Snooping

Select Enabled to inform the PCI devices that an ISA graphics device is installed in the system in order for the graphics card to function properly. The options are Enabled and **Disabled**.

PCI IDE BusMaster

Set this value to allow or prevent the use of PCI IDE busmastering. Select "Enabled" to allow the BIOS to use the PCI busmaster for reading and writing to IDE drives. The options are **Disabled** and Enabled.

Offboard PCI/ISA IDE Card

This option allows the user to assign a PCI slot number to an off-board PCI/ISA IDE card in order for it to function properly. The options are **Auto**, PCI Slot1, PCI Slot2, PCI Slot3, PCI Slot4, PCI Slot5, and PCI Slot6.

IRQ3/IRQ4/IRQ5/IRQ7/IRQ9/IRQ10/IRQ11/IRQ14/IRQ15

This feature specifies the availability of an IRQ to be used by a PCI, PnP device. Select Reserved for an IRQ to be used by a Legacy ISA device. The options are **Available** and Reserved.

DMA Channel 0/Channel 1/Channel 3/Channel 5/Channel 6/Channel 7

Select Available to indicate that a specific DMA channel is available to be used by a PCI/PnP device. Select Reserved if a DMA channel specified is reserved for a Legacy ISA device.

Reserved Memory Size

This feature specifies the size of memory block to be reserved for Legacy ISA devices. The options are **Disabled**, 16K, 32K, 64K.

► Super IO Configuration Submenu

Onboard Floppy Controller

Set to enabled to enable the onboard floppy controller. The options are **Enabled** and Disabled.

Serial Port1 Address/Serial Port2 Address

This option specifies the base I/O port addresses and the Interrupt Request addresses of Serial Port 1 and Serial Port 2. Select "Disabled" to prevent the serial port from accessing any system resources. When this option is set to *Disabled*, the serial port physically becomes unavailable. Select "3F8/IRQ4" to allow the serial port to use 3F8 as its I/O port address and IRQ 4 for the interrupt address. The options for Serial Port 1 are Disabled, **3F8/IRQ4**, 3E8/IRQ4, 2E8/IRQ3. The options for Serial Port 2 are Disabled, **2F8/IRQ3**, 3E8/IRQ4 and 2E8/IRQ3.

► **Advanced Chipset Settings**

This item allows the user to configure the Advanced Chipset settings for the system.

► **NorthBridge Configuration**

This feature allows the user to configure the settings for the Intel E7520 NorthBridge chipset.

Memory Remap Feature

Select Enabled to allow remapping of the overlapped PCI memory above the total physical memory. The options are **Enabled** and Disabled.

Max. Payload of Slot#5/Slot#6

This feature allows the user to set the maximum payload size that PCI-Exp. Slot#5/Slot#6 can support for Transaction Layer Packets (TLPs). The options are **128B** and 256B.

► **SouthBridge Configuration**

This feature allows the user to configure the settings for the Intel ICH South Bridge chipset.

Power Button Instant-Off

If set to Enabled, the system will power off immediately as soon as the user hits the power button. If set to Disabled, the system will power off when the user presses the power button for 4 seconds or longer. The options are **Enabled** and Disabled.

► **Intel PCI-X Hub Configuration**

Slot#1/Slot#2/Slot#3/Slot#4 Bus Frequency

This option allows the user to set the maximum PCI speed to be used in the PCI slot specified. Select "Auto" to allow the BIOS automatically detect the capability of the device installed on the bus. The options for Slot 1 are Auto, 33 MHz PCI, 66 MHz PCI, 66 MHz PCI-X, and 100 MHz PCI-X. The options for Slot 2 to Slot 4 are Auto, 33 MHz PCI, 66 MHz PCI, 100 MHz PCI-X, and 133 MHz PCI-X.

I/O Port Decode

This option allows the user to select the decode range for the I/O connections. The options are **4K Decode** and 1K Decode.

VGA 1G-Bit Decode

Select Enabled to enable the function of decoding VGA for the devices installed behind the PXH PCI Controller Hub. The options are **Enabled** and Disabled.

► **ACPI Configuration**

This item allows the user to enable or disable the ACPI support for the operating system.

ACPI OS

Select Yes to enable ACPI support for your operating system. The options are **Yes** and No.

► **Advanced ACPI Configuration**

Use this feature to configure additional ACPI options. Select Yes if the operating system supports ACPI. Select No if the operating system does not support ACPI. The options are No and **Yes**.

ACPI 2.0 Features

Select Yes to allow the RSDP pointers to point to the Fixed System Description Tables. Select No to deactivate this function. The options are Yes and **No**.

ACPI APIC Support

Select Enabled to allow the ACPI APIC Table Pointer to be included in the RSDP pointer list. The options are **Enable** and Disabled.

AMI OEMB Table

Select Enabled to allow the OEMB Table Pointer to be included in the R(x)SDT pointer lists. The options are **Enabled** and Disabled.

Headless Mode

Select Enabled to activate the Headless Operation Mode through the ACPI and will allow the BIOS to boot up the system without any keyboard, mouse and video. The options are Enabled and **Disabled**.

► **Event Log Configuration**

Highlight this item and press <Enter> to view the contents of the event log.

View Event Log

This feature allows the user to view all unread events.

Mark All Events as Read

Highlight this item and press <Enter> to mark the DMI events as read.

Clear Event Log

This setting will clear all event logs when set to OK. The options are OK and **Cancel**.

► Hardware Health Configuration

This feature allows the AMI BIOS to automatically display the status of the following items:

► Temperatures

CPU Overheat Temperature

This feature allows the user to set the CPU Overheat temperature threshold. The options range from 65°C to 90°C. Use the <+> and <-> keys to set the desired setting. The default setting is **78°C**.

The AMI BIOS will automatically monitor and display the following information:

CPU1 Temperature, CPU2 Temperature, CPU3 Temperature, CPU4 Temperature and System Temperature

► Fan Speed

Fan Speed Control:

This feature allows the user to decide how the system controls the speeds of the onboard fans. The CPU temperature and the fan speed are correlative. When the CPU on-die temperature increases, the fan speed will also increase, and vice versa. Select “Workstation” if your system is used as a workstation. Select “Server” if your system is used as a server. Select “Disable” to disable the fan speed control function to allow the onboard fans to constantly run at full speed (12V). The options are **Disable**, 3-pin (Server), and 3-pin (Workstation).

Fan1-Fan9 Speeds

► Voltage

Voltage Monitoring

CPU1-CPU4 Vcore

+3.3V,

+5V,

+12Vcc,

-12Vcc,

+3.3V Standby

► **MPS Configuration**

This section allows the user to configure the multiprocessors table.

MPS Revision

This feature allows the user to select the MPS Revision. Please follow the instructions given on the screen to select the MPS Revision Number. The options are 1.1 and **1.4**.

► **PCI Express Configuration**

This section allows the user to configure the PCI Express slots.

Active State Power Management

Select Enabled to activate the function of power management for signal transactions between the PCI Express L0 and L1 Links. The options are Enabled and **Disabled**.

► SMBIOS Configuration

SMBIOS SMI Support

Select Enabled to enable the function of SMBIOS SMI Wrapper support for PnP Func 50h-54h. The options are **Enabled** and Disabled.

► Remote Access Configuration

You can use this screen to select options for the Remote Access Configuration. Use the up and down arrow keys to select an item. Use the <+> and <-> keys to change the value of the selected option.

Remote Access

This feature allows the user to enable the function of Remote Access. The options are Enabled and **Disabled**.

If the item "Remote Access" is set to Enabled, you can select a Remote Access type and configure the following settings:

Serial Port Number

This feature allows the user to select the serial port for Console Redirection. The options are **COM1** and COM2.

Base Address

This feature allows the user to set Base Address for the Serial Port Selected. The default setting is **2F8h, 8**.

Serial Port Mode

This feature allows the user to set the serial port mode for Console Redirection. The options are **115200 8, N, 1**, 57600 8, N, 1, 38400 8, N, 1, 19200 8, N, 1 and 9600 8, N, 1.

Flow Control

This feature allows the user to set the flow control for Console Redirection. The options are **None**, Hardware, and Software.

Redirection After BIOS POST

This feature allows the user to select Disabled to turn off Console Redirection after POST. Select **Always** to keep Console Redirection active all the time. (*Note: this setting may not be supported by some operating systems.) Select Boot Loader to keep Console Redirection active during POST and Boot Loader.

Terminal Type

This feature allows the user to select the target terminal type for Console Redirection. The options are **ANSI**, VT100, and VT-UTF8.

VT-UTF8 Comb Key Support

This feature allows the user to select Enabled to enable the VT-UTF8 Combination Key support for the ANSI/VT100 Terminals. The options are **Enabled** and Disabled.

Sredir Memory Display Delay

This feature allows the user to decide how many seconds the BIOS shall wait before memory information is displayed. The options are: **No Delay**, Delay 1 Sec., Delay 2 Sec. and Delay 4 Sec.

►USB Configuration

This feature allows the user to configure the USB settings.

USB Function

This feature allows you to enable the USB Ports. The options are Disabled, 2 USB Ports, 4 USB Ports, and **Enabled**.

Legacy USB Support

Select Enabled to enable USB Legacy support. Disable legacy support if there are no USB devices installed in the system. The options are Disabled, **Enabled**, and Auto.

USB 2.0 Controller

This setting allows you to enable or disable the USB 2.0 Controller. The options are Disabled and **Enabled**.

USB 2.0 Controller Mode

This setting allows you to configure the USB 2.0 Controller Mode. The options are **Hi-Speed (480 Mbps)** and Full Speed-(12Mbps).

Stop EHCI HC in OHCI Handover

Select Enabled to halt an ECHI Host Controller during OHCI OS handover calls when the EHCI Host Controller is not supported by the Operating System.

Hot Plug USB FDD Support

Set to Enabled to create a dummy FDD device to be used as a hot-plug FDD. Set to Auto for a hot-plug FDD device to be automatically created if a USB FDD is not detected. The options are **Auto**, Enabled and Disabled.

► BIOS Settings Configuration

Quick Boot

If Enabled, this option will skip certain tests during POST to reduce the time needed for system bootup. The options are **Enabled** and Disabled.

Quiet Boot

This option allows the boot up screen options to be modified between POST messages or the OEM logo. Select **Disabled** to allow the computer system to display the POST messages. Select Enabled to allow the computer system to display the OEM logo.

Add-On ROM Display Mode

This option allows the BIOS to display add-on ROM (read-only memory) messages. Select **Force BIOS** to display a third party BIOS during system boot. Select "Keep Current" to display the current BIOS information during system boot.

Boot up Num-Lock

This option allows the Number Lock setting to be modified during boot up. The default setting is **On**. The options are On and Off.

PS/2 Mouse Support

This option allows the PS/2 mouse support to be modified. The options are **Auto**, Enabled and Disabled.

System Keyboard

This option allows the user to enable or disable all keyboards connected to the system. The options are **Present** and Absent.

Wait for 'F1' If Error

Select Enable to activate the function of Wait for F1 if Error. The options are **Enabled** and Disabled.

Hit 'DEL' Message Display

Select Enabled to display the Setup Message when the user hits the DEL key. The options are **Enabled** and Disabled.

Onboard SCSI RAID

Select Enable to enable the Onboard SCSI RAID devices. The options are Enabled and **Disabled**.

Interrupt 19 Capture

Select Enabled to allow ROMs to trap Interrupt 19. The options are Enabled and **Disabled**.

Watch Dog Timer

If enabled, this option will automatically reset the system if the system is not active for more than 5 minutes. The options are Enabled and **Disabled**.

Resume On Modem Ring

Select On to “wake your system up” when an incoming call is received by your modem. The options are On and **Off**.

Restore on AC Power Loss

The feature allows the user to set the power state after a power outage. Select Power-Off for the system power to remain off after a power loss. Select Power-On for the system power to be turned on after a power loss. Select Last State to allow the system to resume its last state before the power loss. The options are Power-On, Power-Off and **Last State**.

4-4 Boot Settings

This feature allows the user to configure the following items:

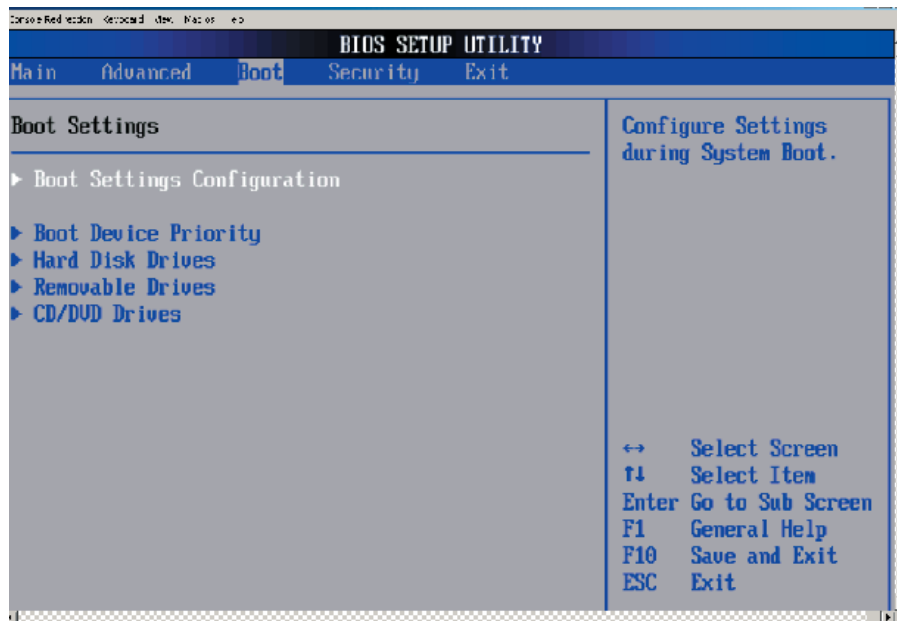

► **Boot Device Priority**

This feature allows the user to specify the sequence of priority for the Boot Device.

The settings are 1st Floppy Drive, CD ROM, ATAPI CDROM and Disabled. The default settings are:

- 1st boot device – 1st Floppy Drive
- 2nd boot device – CD/DVD: PS-UJDA770
- 3rd boot device – SCSI: 00, AIC-7902B
- 4th boot device – Network: IBA GE Slot
- 5th boot device – Network: IBA GE Slot
- 6th boot device – Network: IBA GE Slot

► **Hard Disk Drives**

This feature allows the user to specify the boot sequence from available Hard Drives.

1st Drive

- 1ST boot device – SCSI: 00, AIC-7902B

► **Removable Drives**

This feature allows the user to specify the boot sequence from available Removable Drives.

1st Drive

This option allow the user to specify the boot sequence for 1st Removable Drive.

The options are **1st Floppy Drive** and Disabled.

► **CD/DVD Drives**

This feature allows the user to specify the boot sequence from available CD/DVD-Drives.

1st Drive

This option allows the user to specify the boot sequence for the 1st CD/DVD Drive. The options are CD/DVD: PS-UJDA770, CD/DVD and Disabled.

4-5 Security Settings

The AMI BIOS provides a Supervisor and a User password. If you use both passwords, the Supervisor password must be set first.

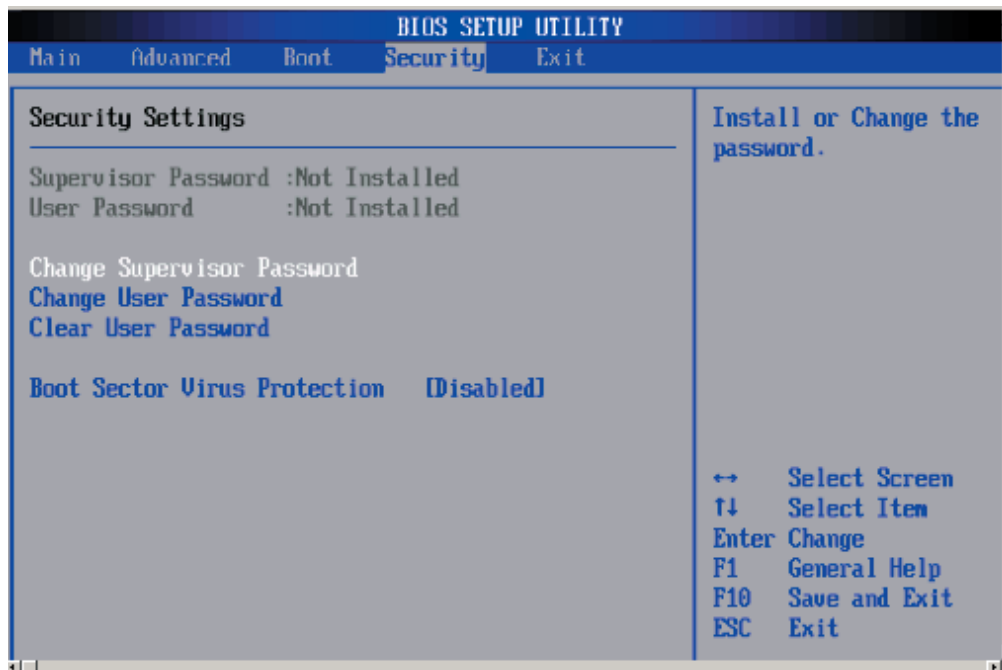

Change Supervisor Password

Select this option and press <Enter> to access the sub-menu, and then type in the password.

Change User Password

Select this option and press <Enter> to access the sub-menu, and then type in the password.

Clear User Password

This option allows the user to clear a password that has been previously entered into the system.

Password Check

Set to **Setup** to allow the system to perform a password check when the BIOS Setup is invoked. Set to **Always** to allow the system to perform a password check when the BIOS Setup is invoked or when the system boots up.

Boot Sector Virus Protection

This option is near the bottom of the Security Setup screen. Select "Disabled" to deactivate the Boot Sector Virus Protection. Select "Enabled" to enable boot sector protection. When Enabled, the AMIBIOS displays a warning when any program (or virus) issues a Disk Format command or attempts to write to the boot sector of the hard disk drive. The options are Enabled and **Disabled**.

4-6 Exit Options

Select the Exit tab from the AMIBIOS Setup Utility screen to enter the Exit BIOS Setup screen.

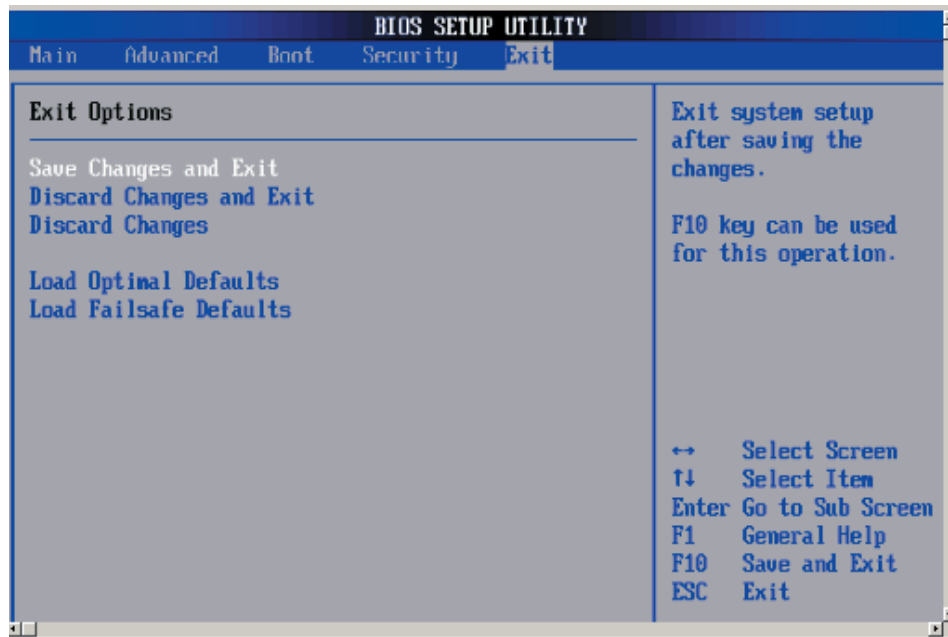

Saving Changes and Exit

When you have completed the system configuration changes, select this option to leave the BIOS Setup and reboot the computer, so the new system configuration parameters can take effect. Select Save Changes and Exit from the Exit menu and press <Enter>.

Discarding Changes and Exit

Select this option to quit the BIOS Setup without making any permanent changes to the system configuration and reboot the computer. Select Discard Changes and Exit from the Exit menu and press <Enter>.

Discarding Changes

Select this option and press <Enter> to discard all the changes and return to the AMIBIOS Utility Program.

Load Optimal Defaults

To set this feature, select Load Optimal Defaults from the Exit menu and press <Enter>. Then, Select "OK" to allow the AMI BIOS to automatically load Optimal Defaults to the BIOS Settings. The Optimal settings are designed for maximum system performance, but may not work best for all computer applications.

Load Fail-Safe Defaults

To set this feature, select Load Fail-Safe Defaults from the Exit menu and press <Enter>. The Fail-Safe settings are designed for maximum system stability, but not for maximum performance.

Appendix A

BIOS Error Beep Codes

During the POST (Power-On Self-Test) routines, which are performed each time the system is powered on, errors may occur.

Non-fatal errors are those which, in most cases, allow the system to continue the boot-up process. The error messages normally appear on the screen.

Fatal errors are those which will not allow the system to continue the boot-up procedure. If a fatal error occurs, you should consult with your system manufacturer for possible repairs.

These fatal errors are usually communicated through a series of audible beeps. The numbers on the fatal error list, on the following page, correspond to the number of beeps for the corresponding error.

Beep Code	Error Message	Description
1 beep	Refresh	Circuits have been reset. (Ready to power up.)
5 short, 1 long	Memory error	No memory detected in system
8 beeps	Display memory read/write error	Video adapter missing or with faulty memory

Notes

Appendix B

BIOS POST Checkpoint Codes

When AMIBIOS performs the Power On Self Test, it writes checkpoint codes to I/O port 0080h. If the computer cannot complete the boot process, diagnostic equipment can be attached to the computer to read I/O port 0080h.

B-1 Uncompressed Initialization Codes

The uncompressed initialization checkpoint codes are listed in order of execution:

Checkpoint	Code Description
D0h	The NMI is disabled. Power on delay is starting. Next, the initialization code checksum will be verified.
D1h	Initializing the DMA controller, performing the keyboard controller BAT test, starting memory refresh and entering 4 GB flat mode next.
D3h	Starting memory sizing next.
D4h	Returning to real mode. Executing any OEM patches and setting the Stack next.
D5h	Passing control to the uncompressed code in shadow RAM at E000:0000h. The initialization code is copied to segment 0 and control will be transferred to segment 0.

B-2 Bootblock Recovery Codes

The bootblock recovery checkpoint codes are listed in order of execution:

Checkpoint	Code Description
E0h	The onboard floppy controller if available is initialized. Next, beginning the base 512 KB memory test.
E1h	Initializing the interrupt vector table next.
E2h	Initializing the DMA and Interrupt controllers next.
E6h	Enabling the floppy drive controller and Timer IRQs. Enabling internal cache memory.
Edh	Initializing the floppy drive.
Eeh	Looking for a floppy diskette in drive A:.. Reading the first sector of the diskette.
Efh	A read error occurred while reading the floppy drive in drive A:..
F0h	Next, searching for the AMIBOOT.ROM file in the root directory.
F1h	The AMIBOOT.ROM file is not in the root directory.
F2h	Next, reading and analyzing the floppy diskette FAT to find the clusters occupied by the AMIBOOT.ROM file.
F3h	Next, reading the AMIBOOT.ROM file, cluster by cluster.
F4h	The AMIBOOT.ROM file is not the correct size.
F5h	Next, disabling internal cache memory.
FBh	Next, detecting the type of flash ROM.
FCh	Next, erasing the flash ROM.
FDh	Next, programming the flash ROM.
FFh	Flash ROM programming was successful. Next, restarting the system BIOS.

B-3 Uncompressed Initialization Codes

The following runtime checkpoint codes are listed in order of execution.

These codes are uncompressed in F0000h shadow RAM.

Checkpoint	Code Description
03h	The NMI is disabled. Next, checking for a soft reset or a power on condition.
05h	The BIOS stack has been built. Next, disabling cache memory.
06h	Uncompressing the POST code next.
07h	Next, initializing the CPU and the CPU data area.
08h	The CMOS checksum calculation is done next.
0Ah	The CMOS checksum calculation is done. Initializing the CMOS status register for date and time next.
0Bh	The CMOS status register is initialized. Next, performing any required initialization before the keyboard BAT command is issued.
0Ch	The keyboard controller input buffer is free. Next, issuing the BAT command to the keyboard controller.
0Eh	The keyboard controller BAT command result has been verified. Next, performing any necessary initialization after the keyboard controller BAT command test.
0Fh	The initialization after the keyboard controller BAT command test is done. The keyboard command byte is written next.
10h	The keyboard controller command byte is written. Next, issuing the Pin 23 and 24 blocking and unblocking command.
11h	Next, checking if <End or <Ins> keys were pressed during power on. Initializing CMOS RAM if the Initialize CMOS RAM in every boot AMIBIOS POST option was set in AMIBCP or the <End> key was pressed.
12h	Next, disabling DMA controllers 1 and 2 and interrupt controllers 1 and 2.
13h	The video display has been disabled. Port B has been initialized. Next, initializing the chipset.
14h	The 8254 timer test will begin next.
19h	Next, programming the flash ROM.
1Ah	The memory refresh line is toggling. Checking the 15 second on/off time next.
2Bh	Passing control to the video ROM to perform any required configuration before the video ROM test.
2Ch	All necessary processing before passing control to the video ROM is done. Looking for the video ROM next and passing control to it.
2Dh	The video ROM has returned control to BIOS POST. Performing any required processing after the video ROM had control
23h	Reading the 8042 input port and disabling the MEGAKEY Green PC feature next. Making the BIOS code segment writable and performing any necessary configuration before initializing the interrupt vectors.
24h	The configuration required before interrupt vector initialization has completed. Interrupt vector initialization is about to begin.

Checkpoint	Code Description
25h	Interrupt vector initialization is done. Clearing the password if the POST DIAG switch is on.
27h	Any initialization before setting video mode will be done next.
28h	Initialization before setting the video mode is complete. Configuring the monochrome mode and color mode settings next.
2Ah	Bus initialization system, static, output devices will be done next, if present. See the last page for additional information.
2Eh	Completed post-video ROM test processing. If the EGA/VGA controller is not found, performing the display memory read/write test next.
2Fh	The EGA/VGA controller was not found. The display memory read/write test is about to begin.
30h	The display memory read/write test passed. Look for retrace checking next.
31h	The display memory read/write test or retrace checking failed. Performing the alternate display memory read/write test next.
32h	The alternate display memory read/write test passed. Looking for alternate display retrace checking next.
34h	Video display checking is over. Setting the display mode next.
37h	The display mode is set. Displaying the power on message next.
38h	Initializing the bus input, IPL, general devices next, if present. See the last page of this chapter for additional information.
39h	Displaying bus initialization error messages. See the last page of this chapter for additional information.
3Ah	The new cursor position has been read and saved. Displaying the Hit message next.
3Bh	The Hit message is displayed. The protected mode memory test is about to start.
40h	Preparing the descriptor tables next.
42h	The descriptor tables are prepared. Entering protected mode for the memory test next.
43h	Entered protected mode. Enabling interrupts for diagnostics mode next.
44h	Interrupts enabled if the diagnostics switch is on. Initializing data to check memory wraparound at 0:0 next.
45h	Data initialized. Checking for memory wraparound at 0:0 and finding the total system memory size next.
46h	The memory wraparound test is done. Memory size calculation has been done. Writing patterns to test memory next.
47h	The memory pattern has been written to extended memory. Writing patterns to the base 640 KB memory next.
48h	Patterns written in base memory. Determining the amount of memory below 1 MB next.
49h	The amount of memory below 1 MB has been found and verified.
4Bh	The amount of memory above 1 MB has been found and verified. Checking for a soft reset and clearing the memory below 1 MB for the soft reset next. If this is a power on situation, going to checkpoint 4Eh next.

Checkpoint	Code Description
4Ch	The memory below 1 MB has been cleared via a soft reset. Clearing the memory above 1 MB next.
4Dh	The memory above 1 MB has been cleared via a soft reset. Saving the memory size next. Going to checkpoint 52h next.
4Eh	The memory test started, but not as the result of a soft reset. Displaying the first 64 KB memory size next.
4Fh	The memory size display has started. The display is updated during the memory test. Performing the sequential and random memory test next.
50h	The memory below 1 MB has been tested and initialized. Adjusting the displayed memory size for relocation and shadowing next.
51h	The memory size display was adjusted for relocation and shadowing.
52h	The memory above 1 MB has been tested and initialized. Saving the memory size information next.
53h	The memory size information and the CPU registers are saved. Entering real mode next.
54h	Shutdown was successful. The CPU is in real mode. Disabling the Gate A20 line, parity, and the NMI next.
57h	The A20 address line, parity, and the NMI are disabled. Adjusting the memory size depending on relocation and shadowing next.
58h	The memory size was adjusted for relocation and shadowing. Clearing the Hit message next.
59h	The Hit message is cleared. The <WAIT...> message is displayed. Starting the DMA and interrupt controller test next.
60h	The DMA page register test passed. Performing the DMA Controller 1 base register test next.
62h	The DMA controller 1 base register test passed. Performing the DMA controller 2 base register test next.
65h	The DMA controller 2 base register test passed. Programming DMA controllers 1 and 2 next.
66h	Completed programming DMA controllers 1 and 2. Initializing the 8259 interrupt controller next.
67h	Completed 8259 interrupt controller initialization.
7Fh	Extended NMI source enabling is in progress.
80h	The keyboard test has started. Clearing the output buffer and checking for stuck keys. Issuing the keyboard reset command next.
81h	A keyboard reset error or stuck key was found. Issuing the keyboard controller interface test command next.
82h	The keyboard controller interface test completed. Writing the command byte and initializing the circular buffer next.
83h	The command byte was written and global data initialization has completed. Checking for a locked key next.
84h	Locked key checking is over. Checking for a memory size mismatch with CMOS RAM data next.
85h	The memory size check is done. Displaying a soft error and checking for a password or bypassing WINBIOS Setup next.

Checkpoint	Code Description
86h	The password was checked. Performing any required programming before WINBIOS Setup next.
87h	The programming before WINBIOS Setup has completed. Uncompressing the WINBIOS Setup code and executing the AMIBIOS Setup or WINBIOS Setup utility next.
88h	Returned from WINBIOS Setup and cleared the screen. Performing any necessary programming after WINBIOS Setup next.
89h	The programming after WINBIOS Setup has completed. Displaying the power on screen message next.
8Ch	Programming the WINBIOS Setup options next.
8Dh	The WINBIOS Setup options are programmed. Resetting the hard disk controller next.
8Fh	The hard disk controller has been reset. Configuring the floppy drive controller next.
91h	The floppy drive controller has been configured. Configuring the hard disk drive controller next.
95h	Initializing the bus option ROMs from C800 next. See the last page of this chapter for additional information.
96h	Initializing before passing control to the adaptor ROM at C800.
97h	Initialization before the C800 adaptor ROM gains control has completed. The adaptor ROM check is next.
98h	The adaptor ROM had control and has now returned control to BIOS POST. Performing any required processing after the option ROM returned control.
99h	Any initialization required after the option ROM test has completed. Configuring the timer data area and printer base address next.
9Ah	Set the timer and printer base addresses. Setting the RS-232 base address next.
9Bh	Returned after setting the RS-232 base address. Performing any required initialization before the Coprocessor test next.
9Ch	Required initialization before the Coprocessor test is over. Initializing the Coprocessor next.
9Dh	Coprocessor initialized. Performing any required initialization after the Coprocessor test next.
9Eh	Initialization after the Coprocessor test is complete. Checking the extended keyboard, keyboard ID, and Num Lock key next. Issuing the keyboard ID command next.
A2h	Displaying any soft errors next.
A3h	The soft error display has completed. Setting the keyboard typematic rate next.
A4h	The keyboard typematic rate is set. Programming the memory wait states next.
A5h	Memory wait state programming is over. Clearing the screen and enabling parity and the NMI next.
A7h	NMI and parity enabled. Performing any initialization required before passing control to the adaptor ROM at E000 next.
A8h	Initialization before passing control to the adaptor ROM at E000h completed. Passing control to the adaptor ROM at E000h next.

Checkpoint	Code Description
A9h	Returned from adaptor ROM at E000h control. Performing any initialization required after the E000 option ROM had control next.
Aah	Initialization after E000 option ROM control has completed. Displaying the system configuration next.
Abh	Uncompressing the DMI data and executing DMI POST initialization next.
B0h	The system configuration is displayed.
B1h	Copying any code to specific areas.
00h	Code copying to specific areas is done. Passing control to INT 19h boot loader next.

Notes

Appendix C

Software Installation

After all the hardware has been installed, you must first configure the Adaptec Embedded Serial ATA RAID Driver before you install the Windows operating system. The necessary drivers are all included on the Supermicro bootable CDs that came packaged with your motherboard.

C-1 Introduction to the Adaptec Embedded Serial ATA RAID Controller Driver

Serial ATA (SATA)

Serial ATA(SATA) is a physical storage interface. It uses a single cable with a minimum of four wires to create a point-to-point connection between devices. It is a serial link which supports SATA Transfer rates from 150MBps. Because the serial cables used in SATA are thinner than the traditional cables used in Parallel ATA(PATA), SATA systems have better airflow and can be installed in smaller chassis than Parallel ATA. In addition, the cables used in PATA can only extend to 40cm long, while Serial ATA cables can extend up to one meter. Overall, Serial ATA provides better functionality than Parallel ATA.

Introduction to the Intel ICH5R I/O Controller Hub

Located in the South Bridge of the Intel E8501 Chipset, the ICH5R I/O Controller Hub provides the I/O subsystem with access to the rest of the system. It supports 2-channel Ultra ATA/100 Bus Master IDE controller (PATA) and two Serial ATA (SATA) Host Controllers, which support up to two Serial ATA ports and up to two RAID drives. The ICH5R I/O Controller Hub supports the following Parallel ATA (PATA) and Serial (SATA) device configurations:

ATA Operate Mode

You can select from the following two modes: Combined Mode and Enhanced Mode.

Combined Mode:

In this mode, system BIOS assigns the traditional IRQ 14 and IRQ 15 for the use of HDD. Up to 4 ATA devices are supported by this mode.

Within the Combined Mode, the following three modes are supported:

*Non-Combined Mode: Parallel ATA only: with the maximum of 4 devices supported;

*Non-Combined Mode: Serial ATA only: with the maximum of 2 devices supported;

*Combined Mode: SATA devices and PATA: with the support of 2 devices each (total: 4 devices maximum). (For IDE/SATA configurations, please refer to the table below.)

To configure SATA RAID for Operating Systems that support RAID functions(--Windows, Red Hat & SuSe, Linux)

1. Select "Advanced Setting" from the AMI BIOS menu.
2. Select the IDE Configuration menu.
3. Change the IDE Configuration to "P-ATA Only."
4. Under the item-"Configure S-ATA as RAID", select "Yes".
5. Tap the <Esc> key and scroll down to "Exit". Select "Save and Exit" from the "Exit" menu. Press the <Enter> key to save the changes and exit the BIOS.
6. Once you've exited the BIOS Utility, the system will re-boot.
7. During the system startup, press the <Ctrl> and the <A> keys simultaneously to run the Adaptec RAID Configuration Utility when prompted by the following message:

Press <Ctrl><A> for Adaptec RAID Configuration Utility.

The Adaptec Embedded Serial ATA with HostRAID Controller Driver

Adaptec's Embedded Serial ATA RAID with HostRAID controller adds RAID functionality to the Serial ATA I/O controller by supporting RAID 0 (Striping) or RAID 1 (Mirroring) to enhance the industry's pioneer PCI-to-e host controller products. RAID striping (RAID 0) can greatly improve hard disk I/O performance because of its capability in striping data across multiple drives. RAID mirroring (RAID 1) allows the data to be simultaneously written to two drives, so critical data is always available even if a single hard disk fails. Due to the built-in functionality, the X6QT8/X6QTE+ is specially designed to keep pace with the increasing performance demands of computer systems by improving disk I/O throughput and providing data accessibility regardless of a single disk failure. By incorporating the Adaptec Embedded Serial ATA into the motherboard design, Supermicro's X6QT8/X6QTE+ offers the user with the benefits of SATARAID without the high costs associated with hardware RAID applications.

(*Note: For Adaptec's RAID Driver Installation Instructions, please refer to the Adaptec RAID Controller User's Guide: "Emb_SA_RAID_UG.pdf" in the CD that came with this motherboard. You can also download a copy of Adaptec's User's Guide from our web site at www.supermicro.com.)

Using the Adaptec RAID Configuration Utility (ARC)

The Adaptec RAID Configuration Utility is an embedded BIOS Utility, including:

*Array Configuration Utility: Use this utility when you want to create, configure and manage arrays.

* Disk Utilities: Use this option to format or verify disks.

To run the Adaptec RAID Configuration Utility, you will need to enable the RAID function in the system BIOS (refer to Chapter 4 for System BIOS Configurations), and then, press the <Ctrl> and <A> keys simultaneously when prompted to do so during the system startup. (Refer to the previous page for detailed instructions.)

(*Note: To select an option, use the arrow keys to highlight the item and then press the <Enter> key to select it. To return to the previous menu, press the <ESC> key.)

A. Using the Array Configuration Utility (ACU)

The Array Configuration Utility (ACU) enables you to create, manage, and delete arrays from the controller's BIOS, add and delete spare drives, and initialize drives. During the system startup, press <Ctrl> and <A> simultaneously, and the main menu will appear.

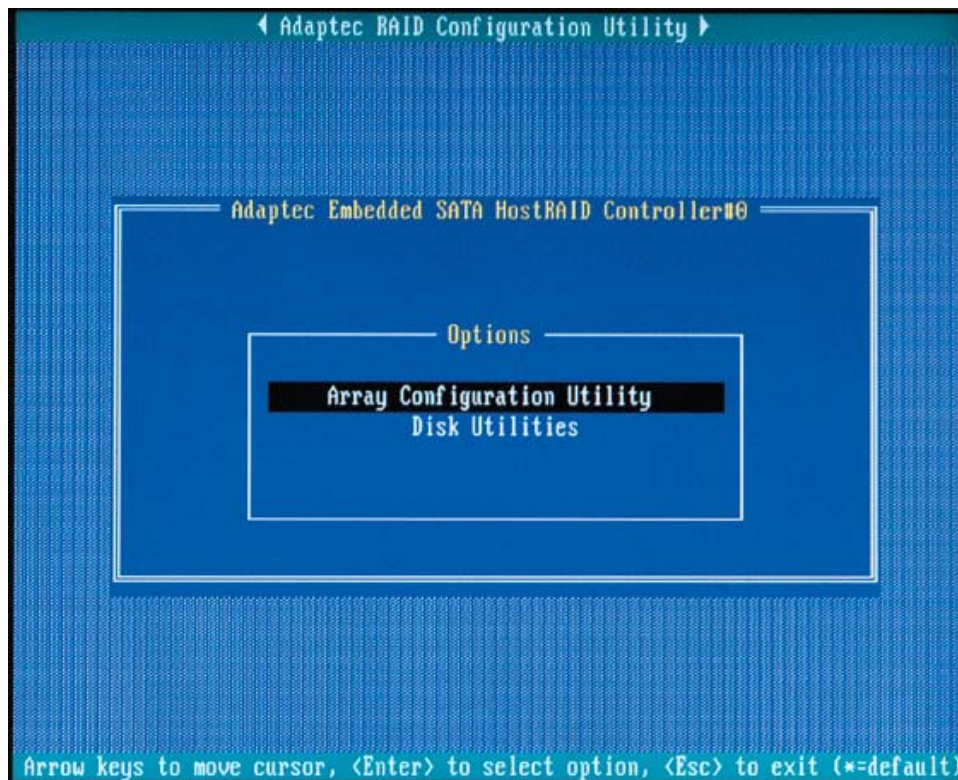

Managing Arrays

Select this option to view array properties, and delete arrays. The following sections describe the operations Of "Managing Arrays".

To select this option, use the arrow keys and the <enter> key to select "Managing Arrays" from the main menu (as shown above).

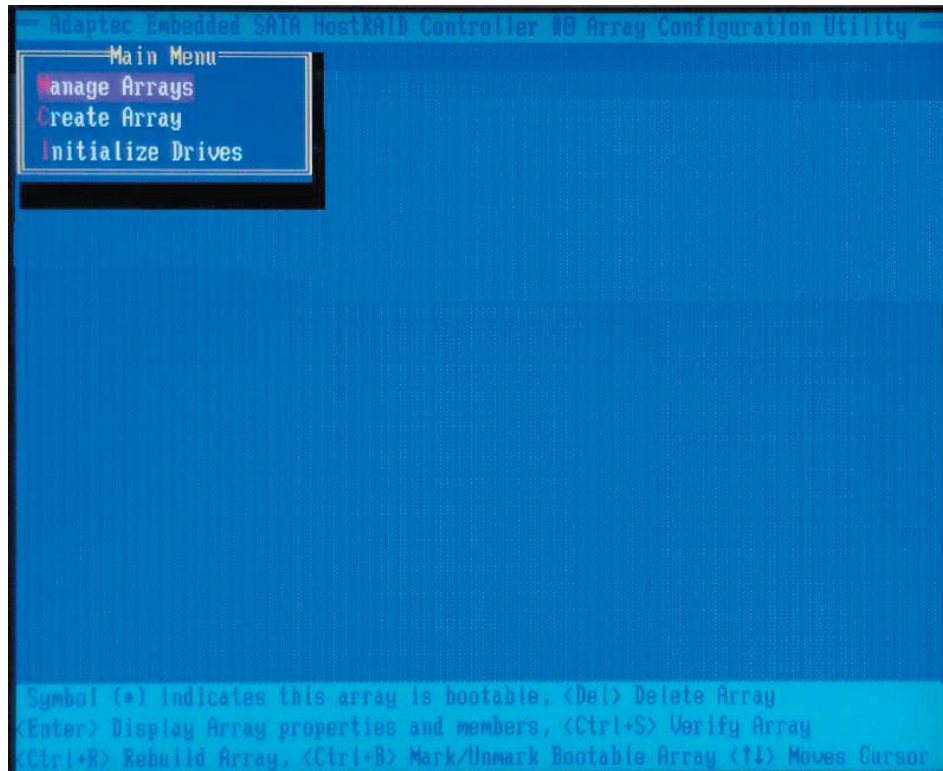

Viewing Array Properties

To view the properties of an existing array:

1. At the BIOS prompt, press **Ctrl+A**.
2. From the ARC menu, select **Array Configuration Utility (ACU)**.
3. From the ACU menu, select **Manage Arrays** (as shown on the previous screen.)
4. From the List of Arrays dialog box, select the array you want to view and press **Enter**.

The Array Properties dialog box appears, showing detailed information on the array. The physical disks associated with the array are displayed here.

5. Press **Esc** to return to the previous menu.

Deleting Arrays

**Warning: Back up the data on an array before you delete it to prevent the loss of data. Deleted arrays cannot be restored.*

To delete an existing array:

1. Turn on your computer and press **Ctrl+A** when prompted to access the ARC utility.
2. From the ARC main menu, select **Array Configuration Utility**.
3. From the ACU menu, select **Manage Arrays**.
4. Select the array you wish to delete and press **Delete**.
5. In the Array Properties dialog box, select **Delete** and press **Enter**. The following prompt is displayed:

**Warning!! Deleting the array will render array unusable. Do you want to delete the array?(Yes/No):*

RAID 1 only—the following prompt is also displayed:

Deleting the partition will result in data loss! Do you also want to delete the partition? (Yes/No):

6. Press **Yes** to delete the array or partition or **No** to return to the previous menu.
7. Press **Esc** to return to the previous menu.

Creating Arrays

Before creating arrays, make sure the disks for the array are connected and installed in your system. Note that disks with no usable space, or disks that are un-initialized are shown in gray and cannot be used. See *Initializing Disk Drives*.

To create an array:

- 1 Turn on your computer and press **Ctrl+A** when prompted to access the ARC utility.
- 2 From the ARC menu, select **Array Configuration Utility Main Menu (ACU)** (as shown on the first screen on page C-5).
- 3 From the ACU menu, select **Create Array**.
- 4 Select the disks for the new array and press Insert (as the screen shown below).

(*Note: To deselect any disk, highlight the disk and press **Delete**.)

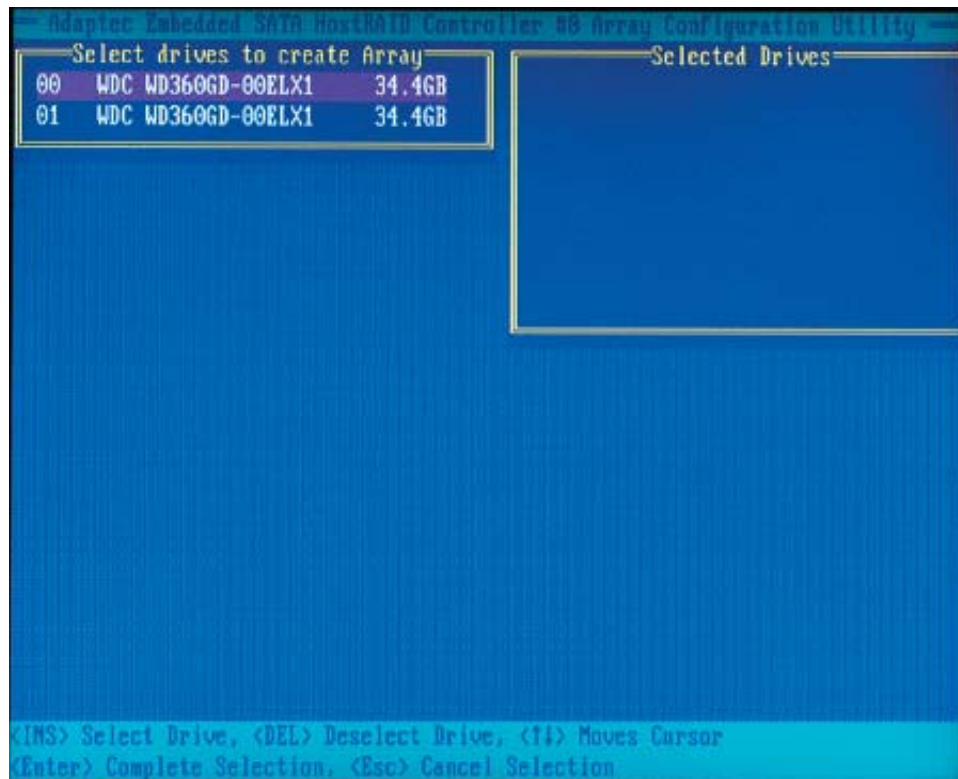

5 Press **Enter** when both disks for the new array are selected. The Array Properties menu displays (as the screen shown below).

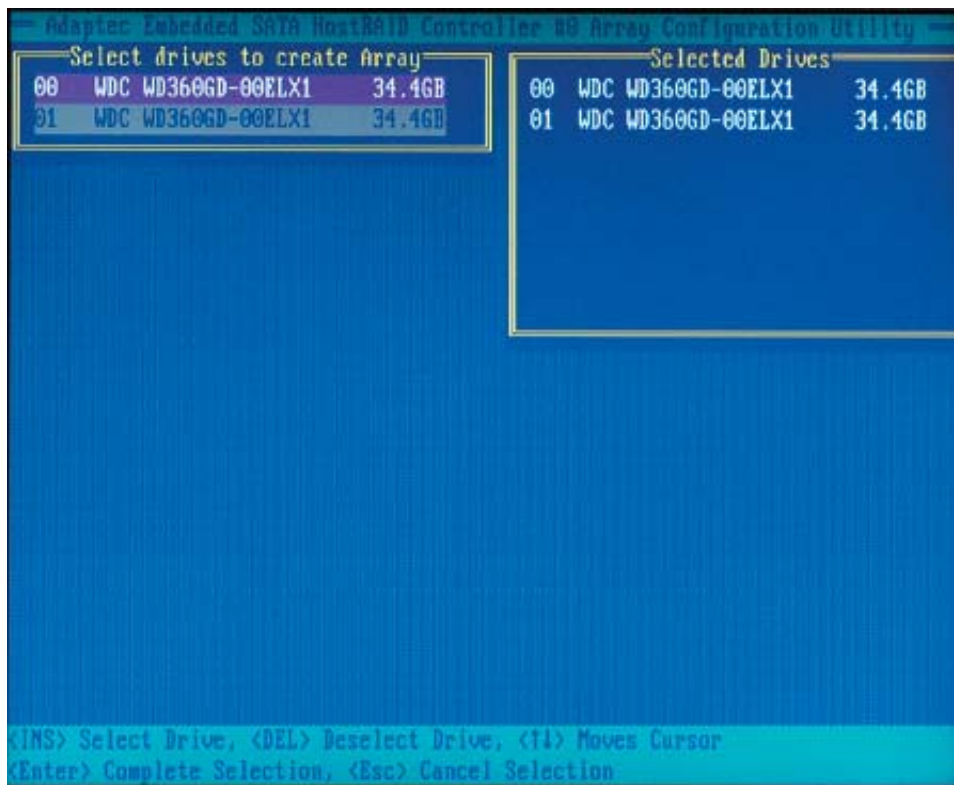

Assigning Array Properties

Once you've create a new array, you are ready to assign the properties to the array.

***Caution:** Once the array is created and its properties are assigned, you cannot change the array properties using the ACU. You will need to use the Adaptec Storage Manager - Browser Edition. (Refer to Adaptec's User's Guide in the enclosed CD.)

To assign properties to the new array:

1. In the Array Properties menu (as shown in the screen below), select an array type and press **Enter**.

Note that only the available array types: RAID 0, and RAID1 are displayed on the screen. (*RAID 0 or RAID 1 requires two drives.)

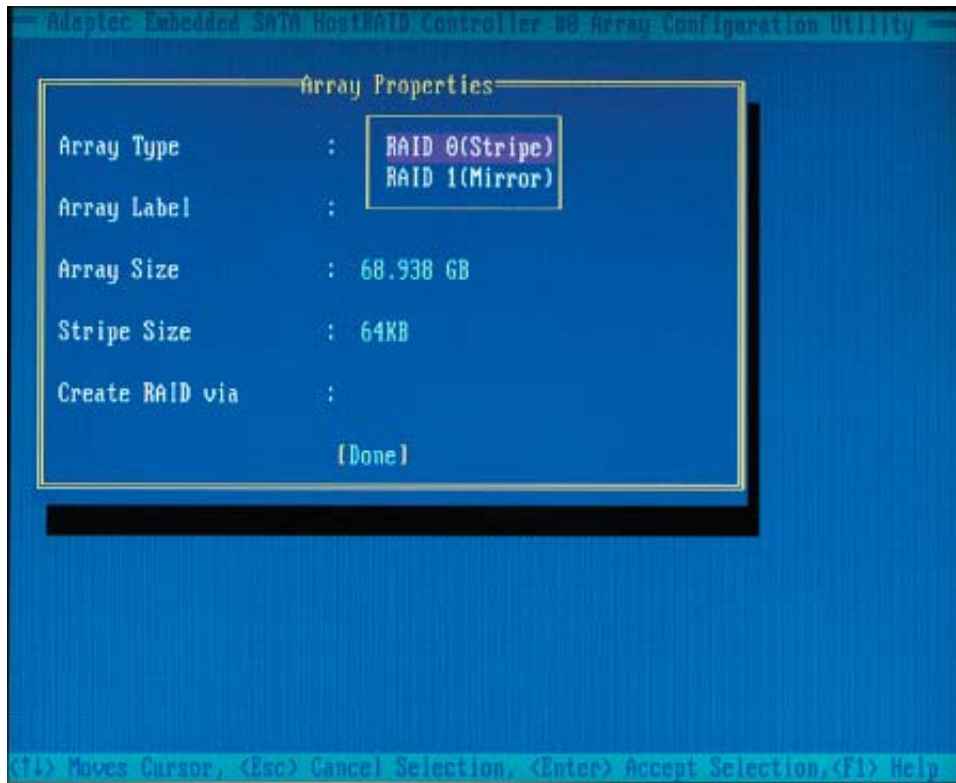

2. Under the item "**Arrays Label**", type in an label and press **Enter**. (*Note: The label shall not be more than 15 characters.)
3. For RAID 0, select the desired stripe size. (*Note: Available stripe sizes are 16, 32, and 64 KB-default. It is recommended that you *do not* change the default setting.)
4. The item: "**Create RAID via**" allows you to select between the different creating methods for RAID 0 and RAID 1.

The following table gives examples of when each is appropriate.

Raid Level	Create Via	When Appropriate
RAID 0	No Init	Creating a RAID 0 on new drives
RAID 0	Migrate (*Note)	Creating a RAID 0 from one new drive and one drive with data you wish to preserve
RAID 1	Build1	Any time you wish to create a RAID 1, but especially if you have data on one drive that you wish to preserve
RAID 1	Clear	Creating a RAID 1 on new drives, or when you want to ensure that the array contains no data after creation.
RAID 1	Quick	Fastest way to create a RAID 1. Appropriate when using new drives
RAID 1	Init	

(*Note: If you select Migrate for RAID 0, or Build for RAID 1, you will be asked to select the source drive. The contents of the source drive will be preserved. However, the data on the new drive will be lost.)

5. When you are finished, press **Done** (as the screen shown below).

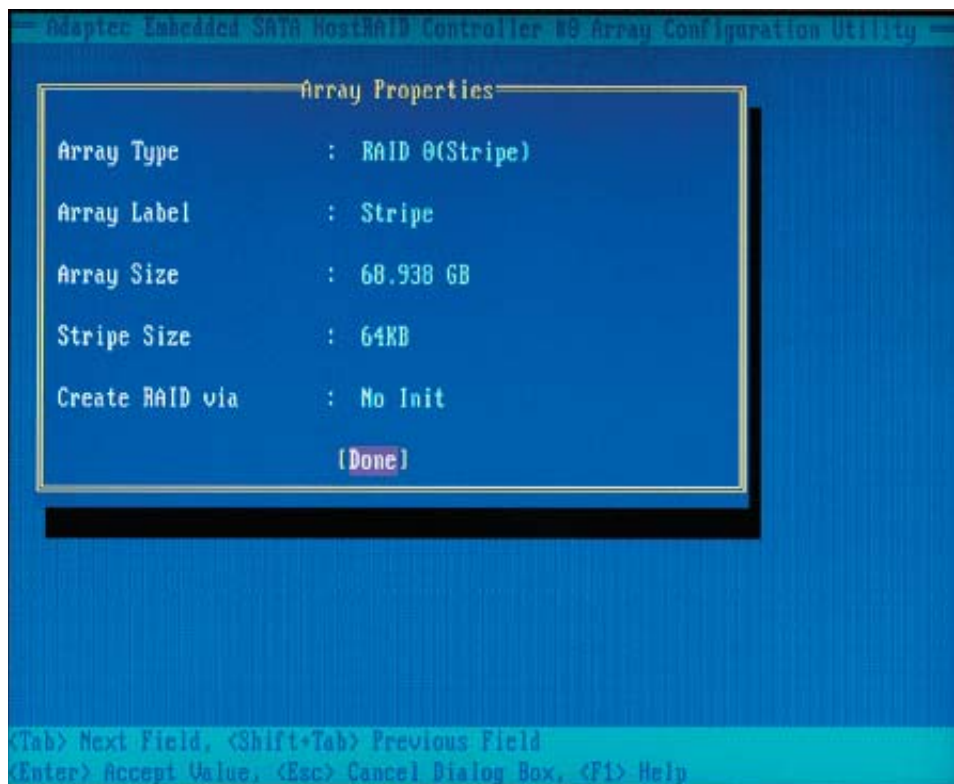

Notes:

1. Before adding a new drive to an array, back up any data contained on the new drive. Otherwise, all data will be lost.
2. If you stop the Build or Clear process on a RAID 1 from ACU, you can restart it by pressing Ctrl+R.
3. A RAID 1 created using the Quick Init option may return some data mis-compare if you later run a consistency check. This is normal and is not a cause for concern.
4. The ACU allows you to use drives of different sizes in a RAID . However, during a build operation, only the smaller drive can be selected as the source or first drive.
5. When migrating from single volume to RAID 0, migrating from a larger drive to a smaller drive is allowed. However, the destination drive must be at least half the capacity of the source drive.
6. Adaptec does not recommend that you migrate or build an array on Windows dynamic disks (volumes), as it will result in data loss.

Warning: Do not interrupt the creation of a RAID 0 using the Migrate option. If you do, you will not be able to restart, or to recover the data that was on the source drive.

Adding a Bootable Array

To make an array bootable:

1. From the Main menu, select **Manage Arrays**.
2. From the List of Arrays, select the array you want to make bootable, and press **Ctrl+B**.
3. Enter Y to create a bootable array when the following message is displayed: "This will make all other existing bootable array non-bootable. Do you want to make this array bootable? (Yes/No):" Then, a bootable array will be created. An asterisk will appear next to the bootable array (as shown in the picture below:)

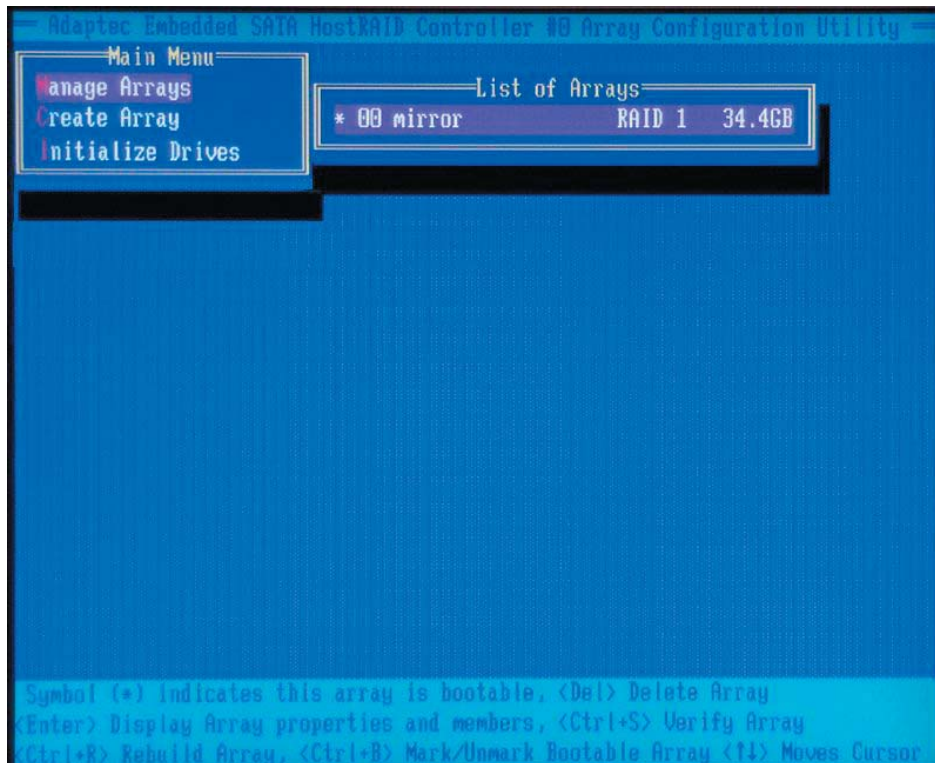

Deleting a Bootable Array

To delete a bootable array:

1. From the Main menu, select **Manage Arrays**.
 2. From the List of Arrays, select the bootable array (*) you want to delete, and press **Ctrl+B**. (* a bootable array is the array marked with an asterisk (as shown in the picture above.)
 3. Enter Y to delete a bootable array when the following message is displayed: "The array is already marked bootable. Do you want to make this array as not bootable? (Yes/No):" Then, the bootable array will be deleted and the asterisk will disappear.
- (*Note: do not use the delete key to delete the bootable array.)

Initializing Disk Drives

If an installed disk does not appear in the disk selection list for creating a new array, or if it appears grayed out, you may have to initialize it before you can use it as part of an array. Drives attached to the controller must be initialized before they can be used in an array.

Caution: Initializing a disk overwrites the partition table on the disk and makes any data on the disk inaccessible. If the drive is used in an array, you may not be able to use the array again.

Do not initialize a disk that is part of a boot array. To determine which disks are associated with a particular array, please refer to [Viewing Array Properties](#).

To initialize drives:

1. Turn on your computer and press **Ctrl+A** when prompted to access the ARC utility.
2. From the ARC menu, select **Array Configuration Utility (ACU)** (as shown in the screen below).

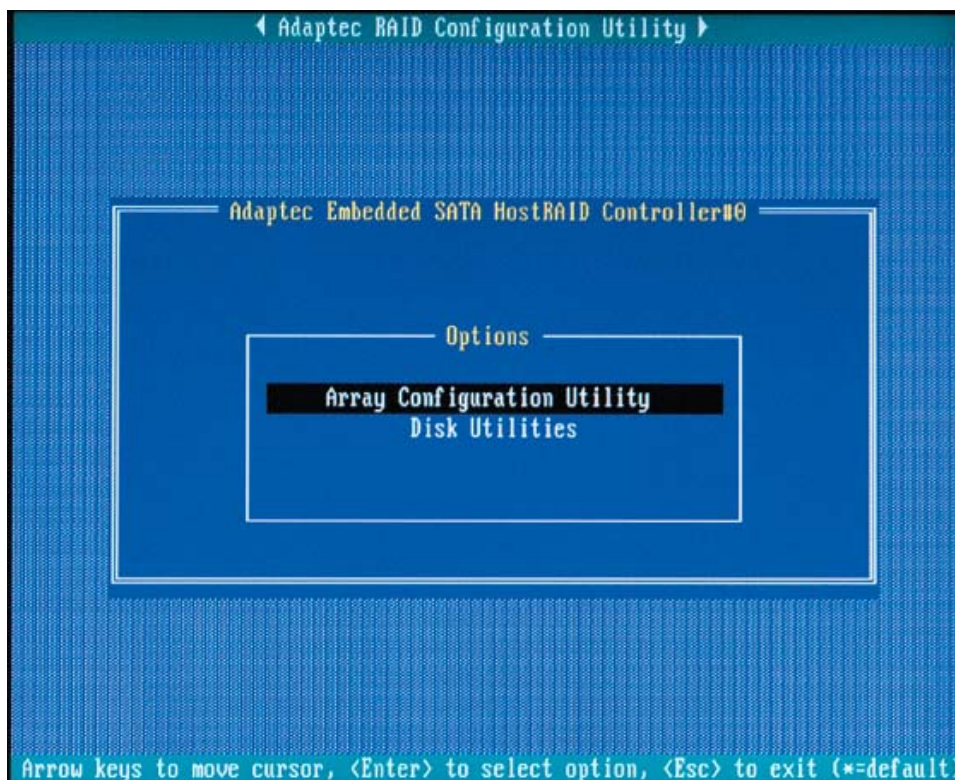

3. Select **Initialize Drives** (as shown in the screen below).

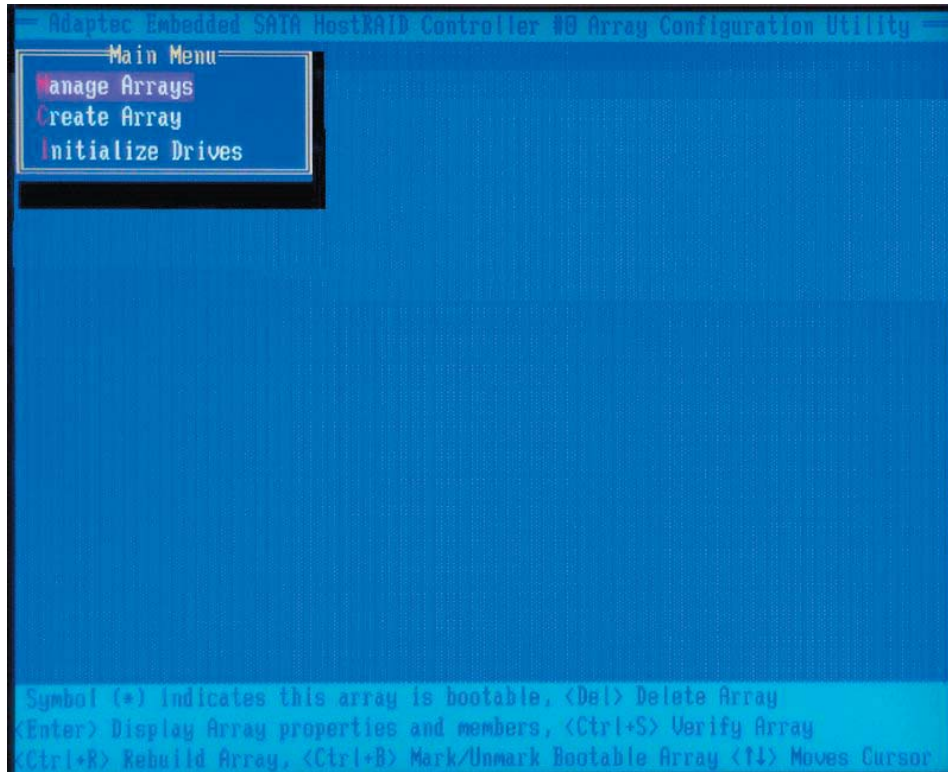

4. Use the up and down arrow keys to highlight the disk you wish to initialize and press **Insert** (as shown in the screen below).

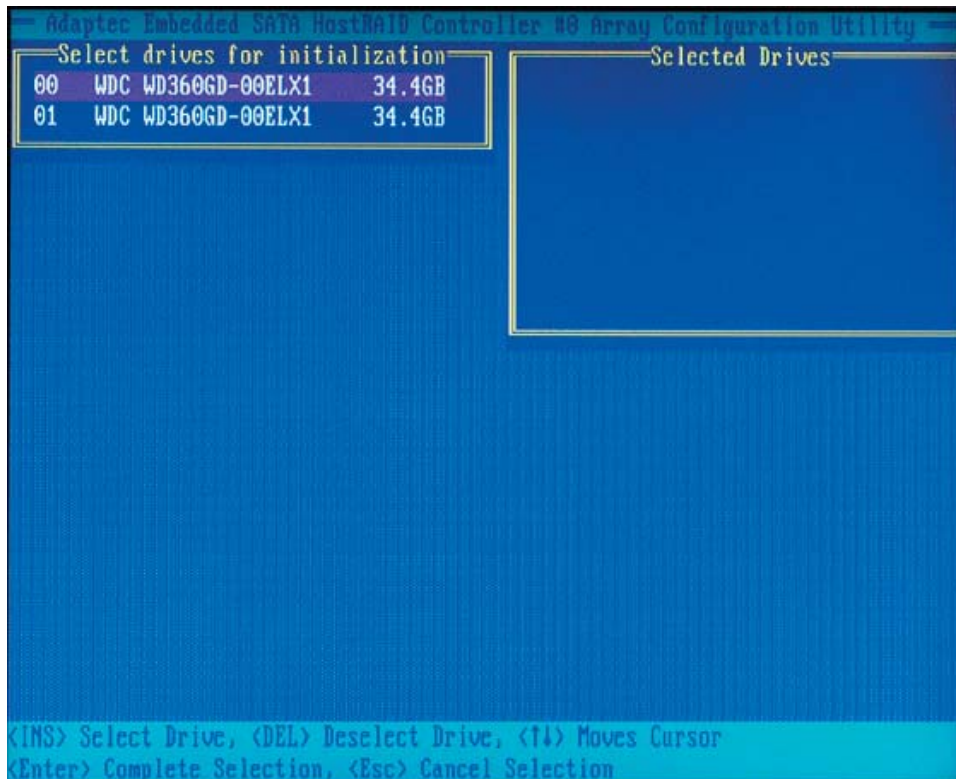

- Repeat [Step 4](#) so that both drives to be initialized are selected (as shown in the screen below).



- Press **Enter**.
- Read the warning message as shown in the screen.

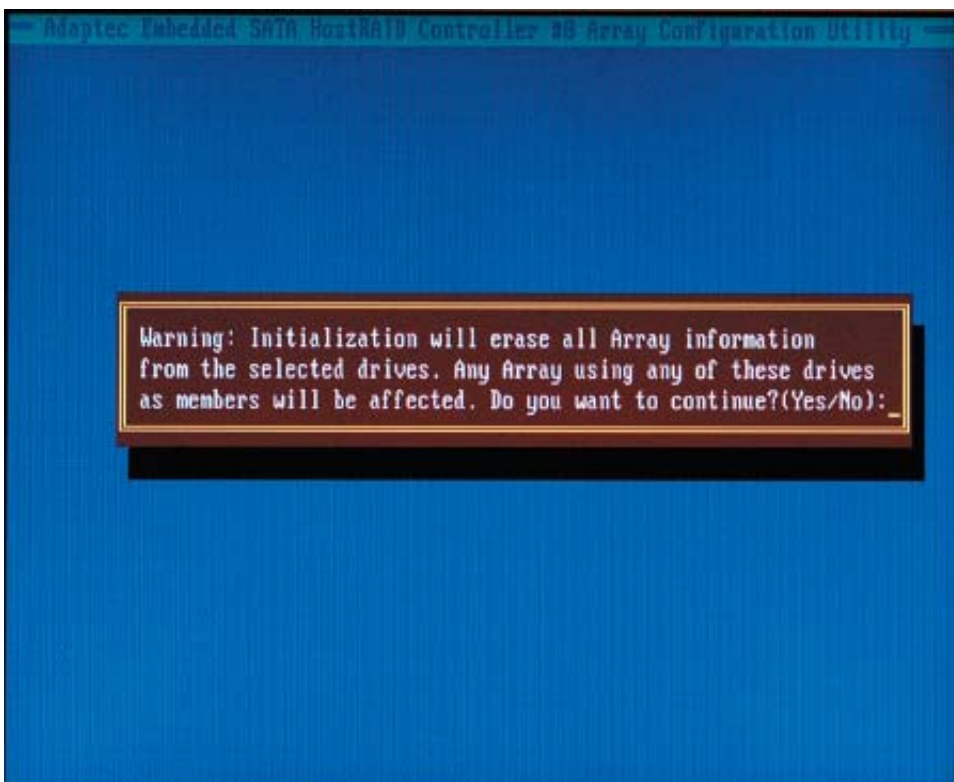

- Make sure that you have selected the correct disk drives to initialize. If correct, type Y to continue.

Rebuilding Arrays

***Note 1:** Rebuilding applies to Fault Tolerant array (RAID 1) only.

If an array Build process (or initialization) is interrupted or critical with one member missing, you must perform a Rebuild to get the array to Optimal status. For a critical array Rebuild operation, the optimal drive is the source drive.

***Note 2:** If no spare array exists and a hard disk drive fails, you need to create a spare before you can rebuild an array.

To Rebuild an array:

1 From the Main Menu, select **Manage Arrays** (as shown in the screen below). From the List of Arrays, select the array you want to Rebuild.

2 Press **Ctrl+R** to Rebuild.

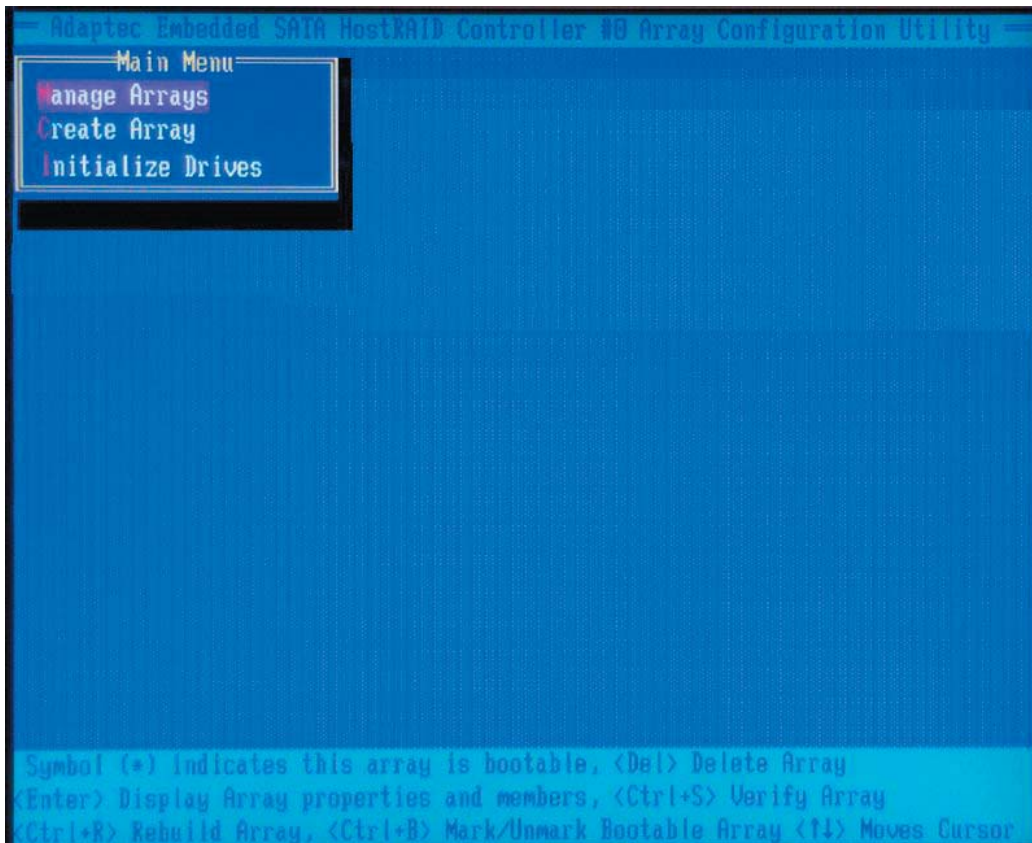

Using the Disk Utilities

The Disk Utilities enable you to format or verify the media of your Serial ATA hard disks.

To access the disk utilities:

1. Turn on your computer and press **Ctrl+A** when prompted to access the ARC utility (as shown in the screen below.)

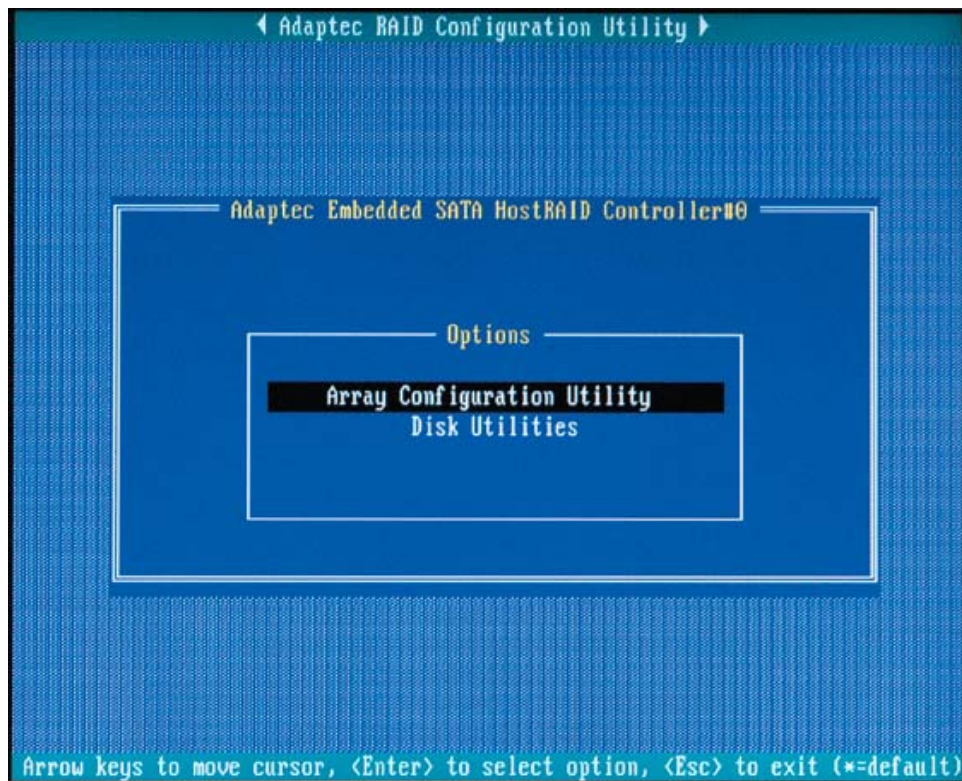

2. From the ARC menu, select **Disk Utilities** as shown in the screen below.

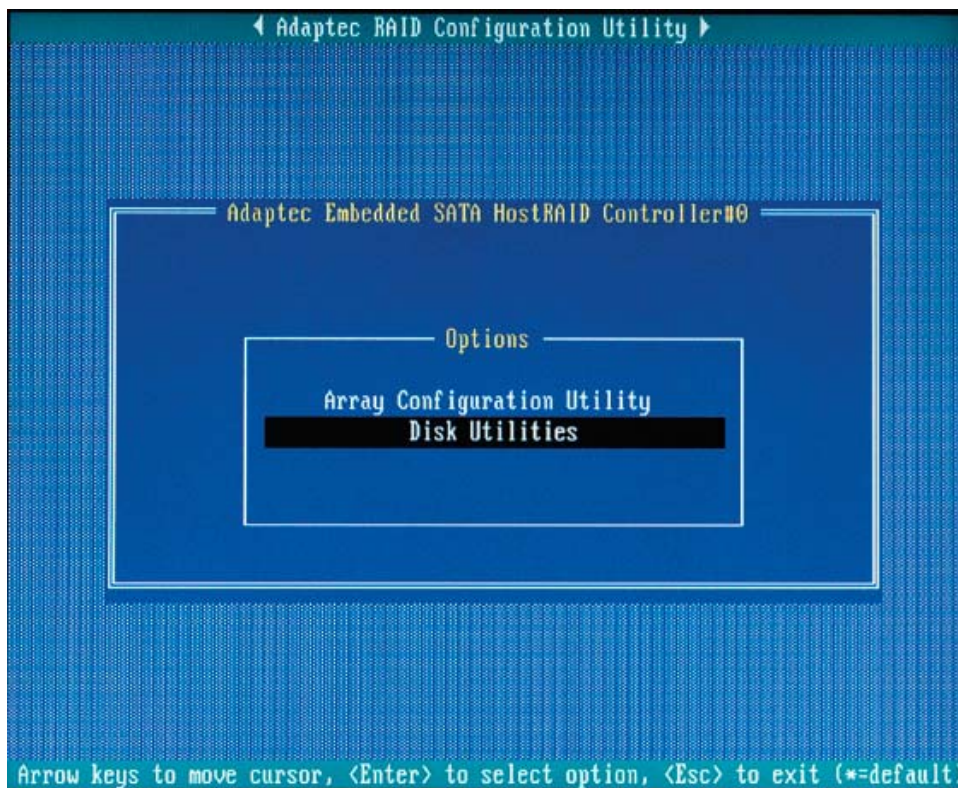

3 Select the desired disk and press **Enter** (as shown in the screen below.)

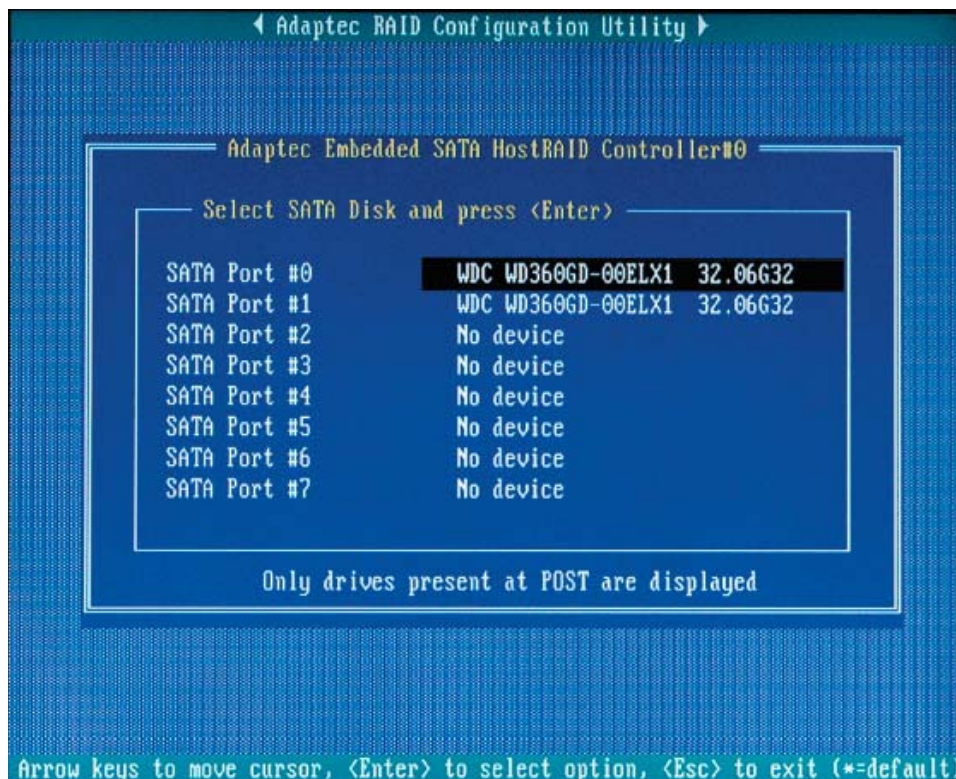

You can choose from the following options:

1. Format Disk—Simulates a low-level format of the hard drive by writing zeros to the entire disk. Serial ATA drives are low-level formatted at the factory and do not need to be low-level formatted again.

(***Caution:** Formatting destroys all data on the drive. Be sure to back up your data before performing this operation.)

2. Verify Disk Media—Scans the media of a disk drive for defects.

To Exit Adaptec RAID Configuration Utility

1. Once you have completed RAID array configurations, press **ESC** to exit. The following screen will appear.

2. Press **Yes** to exit the Utility.

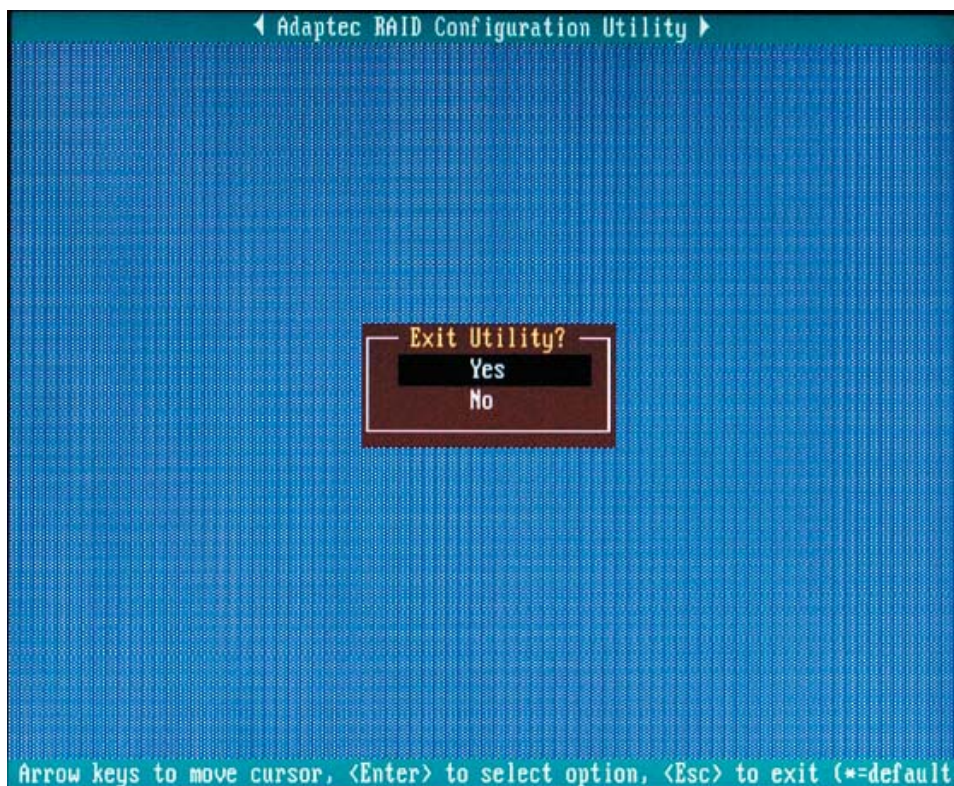

(*For more information regarding Adaptec RAID Utility, please refer to the Adaptec User's Guide in the CD included in your shipping package. You can also download a copy of the Adaptec User's Guide from our web site at: www.supermicro.com.)

C-2 Installing Intel's ICH5R Driver by Adaptec and the Windows OS

- a. Insert Supermicro's bootable CD that came with the package into the CD Drive during the system reboot, and the screen: "Super Micro Driver Diskette Maker" will appear.
- b. From the list displayed on the screen, choose the item: "Intel ICH5R Driver by 3rd Party (Adaptec)" and press <ENTER>.
- c. From the next screen displayed, choose the OS driver you want to install and press <Enter>.
- d. Insert a formatted diskette into drive A: and press <Enter> as prompted.
- e. Exit the program after the process is completed. Then, reboot the system.
- f. Insert Microsoft Windows OS Setup CD in the CD Driver, and the system will start to boot up from CD.
- g. Press the <F6> key when the message-"Press F6 if you need to install a third party SCSI or RAID driver" displays.
- h. When the Windows OS Setup screen appears, press "S" to specify additional device(s).
- i. Insert the driver diskette-"Adaptec Embedded Serial ATA Raid Controller Driver" into Drive A: and press the <Enter> key.
- j. Choose Adaptec Embedded Host Serial ATA Raid Controller from the list indicated in the Windows OS Setup Screen, and press the <Enter> key.
- k. Press the <Enter> key to continue the installation process. (If you need to specify any additional devices to be installed, do it at this time.) Once all devices are specified, press the <Enter> key to continue with the installation.
- l. From the Windows OS Setup screen, press the <Enter> key. The OS Setup will automatically load all device files, and, then, continue the Windows OS installation.
- m. After Windows OS Installation is completed, the system will automatically reboot.

C-3 Installing Other Software Programs and Drivers

Installing Drivers other than the Adaptec Embedded Serial ATA RAID Controller Driver

After you've installed Windows Operating System, a screen as shown below will appear. You are ready to install software programs and drivers that have not yet been installed. To install these software programs and drivers, click the icons to the right of these items.

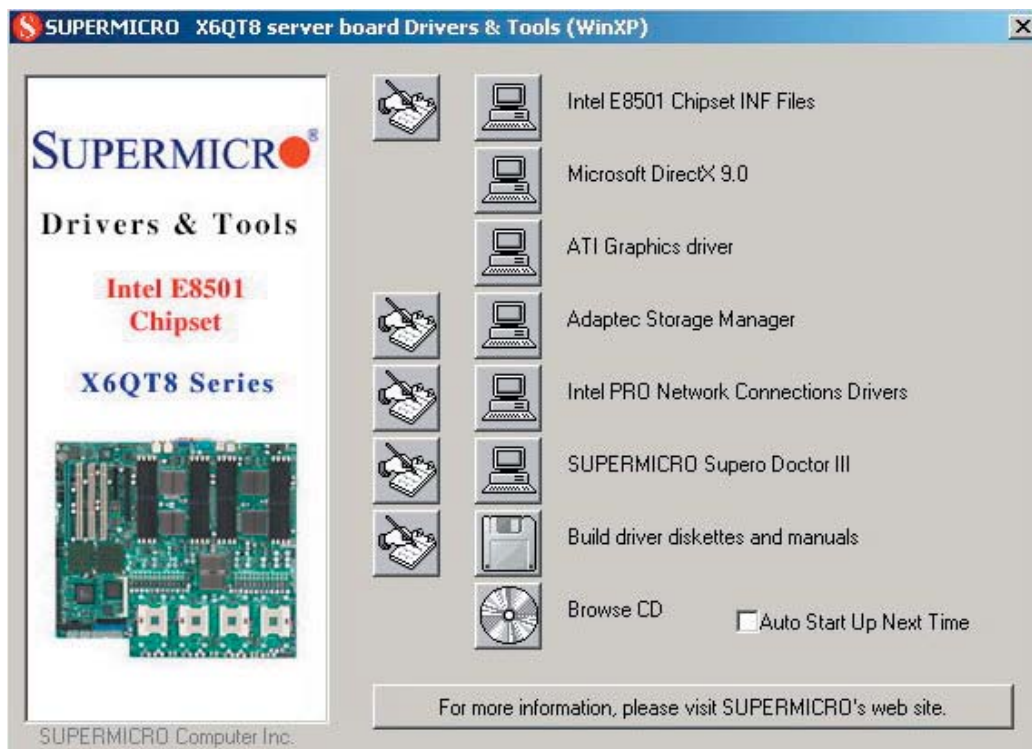

Driver/Tool Installation Display Screen

(***Note:** Click the icons showing a hand writing on paper to view the readme files for each item. Click the computer icons to the right of these items to install each item (from top to the bottom) one at a time. **After installing each item, you must re-boot the system before moving on to the next item on the list.** The bottom icon with a CD on it allows you to view the entire contents of the CD.)

(***Please refer to the Adaptec User's Guide for the installation of Adaptec's Serial ATA RAID Controller Driver. Adaptec's User's Guide is included in the CD. You can also download a copy of the user's guide from our web site.**)

Supero Doctor III

The Supero Doctor III program is a Web base management tool that supports remote management capability. It includes Remote and Local Management tools. The local management is called SD III Client. The Supero Doctor III program included on the CDROM that came with your motherboard allows you to monitor the environment and operations of your system. Supero Doctor III displays crucial system information such as CPU temperature, system voltages and fan status. See the Figure below for a display of the Supero Doctor III interface.

(*The default user name and password are ADMIN.)

Supero Doctor III Interface Display Screen-I (Health Information)

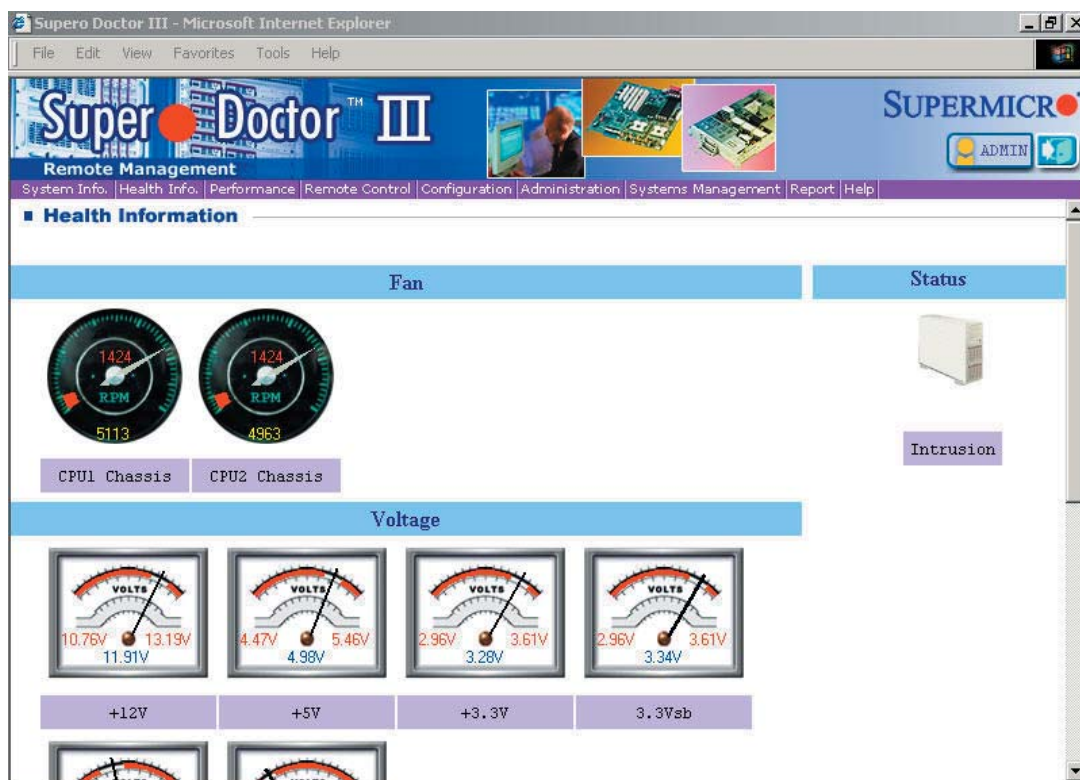

Supero Doctor III Interface Display Screen-II (Remote Control)

Graceful power control

Supero Doctor III allows a user to inform the OS to reboot or shut down within a specified time (the default is 30 seconds). Before the system reboots or shuts down, it's allowed to cancel the action.

Requirements

Keep Supero SD3Service Daemon running at all times on this system.
Provide TCP/IP connectivity.

Power control

(*Note: SD III Software Revision 1.0 can be downloaded from our Web site at: ftp://ftp.supermicro.com/utility/Supero_Doctor_III/. You can also download SDIII User's Guide at: <http://www.supermicro.com/PRODUCT/Manuals/SDIII/UserGuide.pdf>. For Linux, we will still recommend Supero Doctor II.)

Notes