

SY-6ZB Motherboard

Quick Start Guide

Introduction

Hardware
Installation

Quick BIOS
Setup

The SOYO CD

FC Tested To Comply
With FCC Standards
FOR HOME OR OFFICE USE

100% POST CONSUMER
RECYCLED PAPER

SY-6ZB Motherboard

Pentium® III, Pentium® II & Celeron™ processors
82440 ZX AGP/PCI Motherboard
66&100MHz Front Side Bus supported
AT/ATX Power Connectors

Copyright © 1999 bySoyo Computer Inc.

Trademarks:

Soyo is a registered trademark of Soyo Computer Inc. All trademarks are the property of their owners.

Product Rights:

Product and corporate names mentioned in this publication are used for identification purposes only and may be registered trademarks or copyrights of their respective companies.

Copyright Notice:

All rights reserved. This manual is copyrighted by Soyo Computer Inc. You may not reproduce, transmit, transcribe, store in a retrieval system, or translate into any language, in any form or by any means, electronic, mechanical, magnetic, optical, chemical, manual or otherwise, any part of this publication without express written permission of Soyo Computer Inc.

Disclaimer:

Soyo Computer Inc. makes no representations or warranties regarding the contents of this manual. We reserve the right to revise the manual or make changes in the specifications of the product described within it at any time without notice and without obligation to notify any person of such revision or change. The information contained in this manual is provided for general use by our customers. Our customers should be aware that the personal computer field is the subject of many patents. Our customers should ensure that their use of our products does not infringe upon any patents. It is the policy of Soyo Computer Inc. to respect the valid patent rights of third parties and not to infringe upon or assist others to infringe upon such rights.

Restricted Rights Legend:

Use, duplication, or disclosure by the Government is subject to restrictions set forth in subparagraph (c)(1)(ii) of the Rights in Technical Data and Computer Software clause at 252.277-7013.

About This Guide:

This Quick Start Guide is for assisting system manufacturers and end users in setting up and installing the Motherboard. Information in this guide has been carefully checked for reliability; however, no guarantee is given as to the correctness of the contents. The information in this document is subject to change without notice.

If you need any further information, please visit our **Web Site** on the Internet. The address is "<http://www.soyo.com.tw>".

6ZB QSG Version 1.0 - Edition: March 1999

* These specifications are subject to change without notice

1 Introduction

Congratulations on your purchase of the **SY-6ZB** Motherboard. This *Quick Start Guide* describes the steps for installing and setting up your new Motherboard.

This guide is designed for all users to provide the basic steps of Motherboard setting and operation. For further information, please refer to *SY-6ZB Motherboard User's Guide and Technical Reference* online manual included on the CD-ROM packed with your Motherboard.

Unpacking

* If your board comes with a driver disc and a paper manual, the Quick Start Guide and the CD-ROM are not included in the package.

When unpacking the Motherboard, check for the following items:

- ◆ The SY-6ZB 82440 ZX AGP/PCI Motherboard
- ◆ This Quick Start Guide
- ◆ The Installation CD-ROM
- ◆ The CPU Retention Set
- ◆ One IDE Device Flat Cable
- ◆ One Floppy Disk Drive Flat Cable
- ◆ One dual 25-pin parallel with 25-pin flat cable and 9-pin serial with 9-pin flat cable external connector
- ◆ One dual 6-pin PS/2 mouse connector with 6-pin flat cable and 9-pin serial connector with 9-pin flat cable

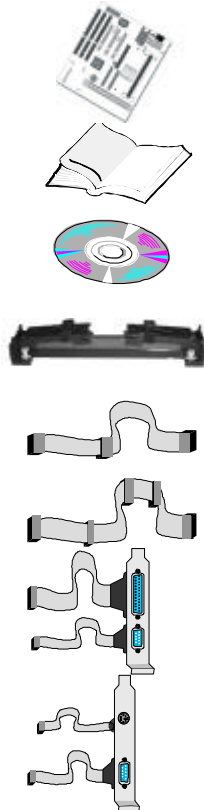

SY-6ZB Motherboard Layout

Introduction

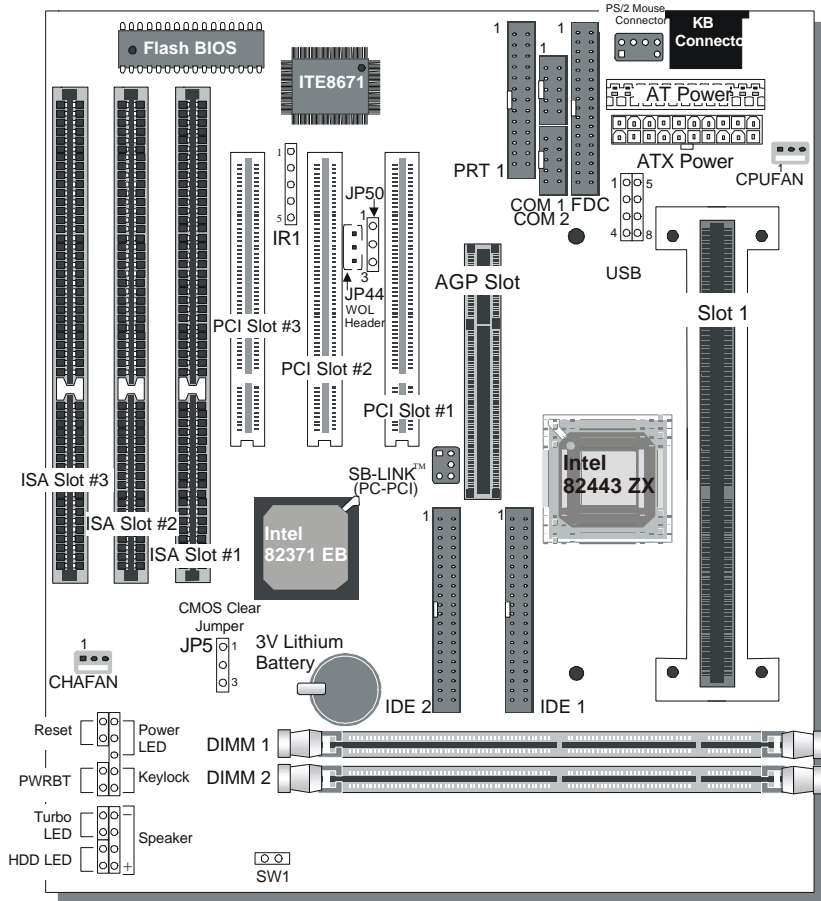

Key Features

- Supports Intel Pentium® III processor (450-500MHz), Pentium® II processor (233-450MHz) & Celeron™ processor (266-433MHz)
- Auto-detect CPU voltage
- PC98, ACPI, Ultra DMA/33
- Power-on by modem or alarm
- Supports Wake-On-LAN (WOL)
- Supports Power-On by Keyboard
- Supports on-board hardware monitoring
- and includes Hardware Doctor™ utility
- Supports Creative SB-LINK™ (PC-PCI) for PCI audio card
- 1 x 32-bit AGP slot
- 3 x 32-bit bus mastering PCI slots
- 1 x IrDA port
- Supports multiple-boot function
- AT/ATX power connectors
- Y2K Compliant

2 Installation



To avoid damage to your Motherboard, follow these simple rules while handling this equipment:

- Before handling the Motherboard, ground yourself by grasping an unpainted portion of the system's metal chassis.
- Remove the Motherboard from its anti-static packaging. Hold it by the edges and avoid touching its components.
- Check the Motherboard for damage. If any chip appears loose, press carefully to seat it firmly in its socket.

Follow the directions in this section designed to guide you through a quick and correct installation of your new **SY-6ZB** Motherboard. For detailed information, please refer to *SY-6ZB Motherboard User's guide and Technical Reference* online manual included on the CD-ROM packed with your Motherboard.

PREPARATIONS

Gather and prepare all the necessary hardware equipment to complete the installation successfully:

- ◆ Slot 1 processor with built-in CPU cooling fan (boxed type)
- ◆ SDRAM module
- ◆ Computer case and chassis with adequate power supply unit
- ◆ Monitor
- ◆ PS/2 Keyboard
- ◆ Pointing Device
- ◆ VGA Card
- ◆ Sound Card (optional)
- ◆ Speaker(s) (optional)
- ◆ Disk Drives: HDD, CD-ROM, Floppy drive ...
- ◆ External Peripherals: Printer, Plotter, and Modem- (optional)
- ◆ Internal Peripherals: Modem and LAN cards (optional)

SY-6ZB Quick Start Guide

Install the Motherboard

Follow the steps below in order to perform the installation of your new **SY-6ZB** Motherboard.

Step 1. Install the CPU

Mark your CPU Frequency: Record the working frequency of your CPU that should be clearly marked on the CPU cover.





FSB 66MHz

<input type="checkbox"/> 266MHz (66 x 4.0)	<input type="checkbox"/> 333MHz (66 x 5.0)	<input type="checkbox"/> 400MHz (66 x 6.0)	<input type="checkbox"/>
<input type="checkbox"/> 300MHz (66 x 4.5)	<input type="checkbox"/> 366MHz (66 x 5.5)	<input type="checkbox"/> 433MHz (66 x 6.5)	

FSB 100MHz

<input type="checkbox"/> 350MHz (100 x 3.5)	<input type="checkbox"/> 450MHz (100 x 4.5)	<input type="checkbox"/> 550MHz (100 x 5.5)	<input type="checkbox"/>
<input type="checkbox"/> 400MHz (100 x 4.0)	<input type="checkbox"/> 500MHz (100 x 5.0)	<input type="checkbox"/> 600MHz (100 x 6.0)	

CPU Mount Procedure: To mount the processor that you have purchased separately, follow these instructions.

<p>Retention Module</p> 	<p>Step 1. Open the two sides by folding them up.</p> 
<p>Step 2. Push the locks on top of the CPU inward.</p> 	<p>Step 3. Insert the CPU into the retention module. The CPU fits in the CPU slot in only ONE way, do not try to force it in.</p> 
<p>Step 4. After completely inserting the CPU, push the two locks on top of the CPU outward. Now your CPU is ready for use.</p> 	<p>HOT</p> <p>To remove the CPU, press the two notches on top of the CPU inward. Now press the two slides on the retention module down and remove the CPU.</p>

Note: Installing a heat sink and cooling fan on top of your CPU is necessary for proper heat dissipation. Failing to install these items may result in overheating and possible burn-out of your CPU.

Step 2. Make Connections to the Motherboard

This section tells how to connect internal peripherals and power supply to the Motherboard.

Internal peripherals include IDE devices (HDD, CD-ROM), Floppy Disk Drive, Chassis Fan, Front Panel Devices (Turbo LED, Internal Speaker, Reset Button, IDE LED, and KeyLock Switch.), Wake-On-LAN card, VGA card, Sound Card, and other devices.

For more details on how to connect internal and external peripherals to your new SY-6ZB Motherboard, please refer to *SY-6ZB Motherboard User's Guide and Technical Reference* online manual on CD-ROM.

Connectors and Plug-ins

PCI Audio Card Header: SB-Link™(PC-PCI)					Wake-On-LAN Header: JP44			
Connect the SB-Link™(PC-PCI) cable from your PCI audio card to this header.					Pin1	Pin2	Pin3	
					5VSB	GND	MP-Wakeup	
CPU Cooling Fan: CPUFAN				Chassis Fan: CHAFAN				
Pin1	Pin2	Pin3	Pin1	Pin2	Pin3			
GND	12V	SENSOR	GND	12V	SENSOR			
				Power LED		Keylock		
				Pin1	Pin2	Pin3	Pin1	Pin2
				5V	NC	GND	Control Pin	GND
				Speaker				
				Pin1	Pin2	Pin3	Pin4	
				5V	NC	NC	Speaker out	
HDD LED		Turbo LED		PWRBT		RESET		
Pin1	Pin2	Pin1	Pin2	Pin1	Pin2	Pin1	Pin2	
LED Anode	LED Cathode	LED Cathode	GND	Power On/Off	GND	Power Good	GND	
IrDA (Infrared Device Header): IR1					AT Power Cable			
Pin1	Pin2	Pin3	Pin4	Pin5	Connect the AT Power cable to this connector. If you use AT power supply.			
VCC	None	IRRX	GND	IRTX				
ATX Power On/Off: PWRBT					ATX Power Supply: ATX PW			
Connect your power switch to this header (momentary switch type).					Attach the ATX Power cable to this connector. If you use ATX power supply.			
To turn off the system, please press this switch and hold down for longer than 4 seconds.					When using the Keyboard Wake-Up function, please make sure the ATX power supply can take at least 720mA load on the 5V Standby lead (5VSB) to meet the standard ATX specifications.			

Hardware Installation

SY-6ZB Quick Start Guide

Step 3. Configure Memory

Your board comes with two DIMM sockets, providing support for up to 256MB of main memory using DIMM modules from 8MB to 128MB. For 66MHz front side bus CPUs use 12ns or faster memory; for 100MHz front side bus CPUs use 8ns (100MHz, PC100 compliant) memory.



Memory Configuration Table

Number of Memory Modules	DIMM 1	DIMM 2
1	1 st	
2	1 st	2 nd
RAM Type	SDRAM	
Memory Module Size (MB)	8/16/32/64/128 Mbytes	

Important: It is of prime importance that you install DIMM modules as outlined in the table above in order to preserve signal integrity on 100MHz front side bus systems.

Step 4. Set SW1 for power up FSB clock and AGP bus clock.

SW1 is used to adjust AGP bus clock frequency depending on the value of the front side bus (FSB) clock, also the setting of the SW1 determines the power up FSB clock which will remain effective until the BIOS set the FSB clock to the CMOS setting.

SW1 Setting	Power up FSB Clock	AGP Clock
	66MHz	AGP Clock = FSB Clock ÷ 1
	100MHz	AGP Clock = FSB Clock ÷ 1.5

Note: The specification of maximum AGP bus Clock frequency is 66.6MHz.



- * Set SW1 to open when you use a FSB 100MHz CPU.
- * Set SW1 to close when you use a FSB 66MHz CPU.
- * Set SW1 to open when you use a FSB 66MHz CPU but want to over clock the FSB clock to 100MHz via the BIOS setting.

Step 5. Set the CPU Frequency

You do not need to set any jumper for the CPU frequency. Instead, CPU setting are changed through the BIOS [CHIPSET FEATURES SETUP]. Please refer to *Chapter 3 - Quick BIOS Setup* for details on how to set the Slot 1 processor frequency.

Step 6. Enable/Disable Power-On by Keyboard (JP50)



You can choose to enable the Power-On by Keyboard function by shorting pin 2-3 on jumper JP50, otherwise, short pin 1-2 to disable this function.

Power-On by Keyboard	Enable	Disable
JP50 Setting	Short pin 2-3 to enable the Power-On by Keyboard function. 	Short pin 1-2 to disable the Power-On by Keyboard function. 
<p>Important: When using the Power-On by Keyboard function, please make sure the ATX power supply can take at least 720mA load on the 5V Standby lead (5VSB) to meet the standard ATX specification.</p>		

Hardware Installation

Step 7. Clear CMOS Data (JP5)

Clear the CMOS memory by momentarily shorting pin 2-3 on jumper JP5 for at least 5 seconds, and then by shorting pin 1-2 to retain new settings. This jumper can be easily identified by its white colored cap.

CMOS Clearing	Clear CMOS Data	Retain CMOS Data
JP5 Setting	Short pin 2-3 for at least 5 seconds to clear the CMOS. 	Short pin 1-2 to retain the new settings. 
<p>Note: You must unplug the ATX power cable from the ATX power connector when performing the CMOS Clear operation.</p>		



Note on Over-clocking Capability

The SY-6ZB Motherboard provides over-clocking capability. Due to the over-clocking setting your system may fail to boot up or hang during run time. If this occurs, please perform the following steps to recover your system from the abnormal situation:

1. Turn off system power (If you use a ATX power supply, sometimes you have to press the power button for more then 4 seconds to shut down the system)
2. Set the SW1 to short if you use a FSB 66MHz CPU
3. Press and hold down the <Insert> key while turning on the system power. Keep holding down the <Insert> key until you see the message of the CPU type and frequency (133MHz or 200MHz) appear on screen
4. Press the key during the system diagnostic checks to enter the Award BIOS Setup program
5. From the BIOS main menu, select [CHIPSET FEATURES SETUP] and move the cursor to the [CPU Frequency] field to set the proper working frequency
6. Select [Save & Exit SETUP] and press <Enter> to save the configuration to the CMOS memory, and continue the boot sequence

Note: SOYO does not guarantee system stability if the user over clocks the system. Any malfunctions due to over-clocking are not covered by the warranty.

3 Quick BIOS Setup

This Motherboard does not use any hardware jumpers to set the CPU frequency. Instead, CPU settings are software configurable with the BIOS **[CHIPSET FEATURES SETUP]**.

After the hardware installation is complete, turn the power switch on, then press the **** key during the system diagnostic checks to enter the Award BIOS Setup program. The CMOS SETUP UTILITY will display on screen. Then, follow these steps to configure the CPU settings.

Step 1. Select [LOAD SETUP DEFAULT]

Select the "LOAD SETUP DEFAULT" menu and type "Y" at the prompt to load the BIOS optimal setup.

Step 2. Select [STANDARD CMOS SETUP]

Set [Date/Time] and [Floppy drive type], then set [Hard Disk Type] to "Auto".

Step 3. Select [CHIPSET FEATURES SETUP]

Move the cursor to the **[CPU Speed]** field to set the CPU frequency.

Available [CPU Speed] settings on your SY-6ZB Motherboard are detailed in the following table. If you set this field to [Manual], you are then required to fill in the next two consecutive fields: (1) the [CPU Host Clock], and (2) the [CPU Ratio].

CPU Frequency		Select the working frequency of your Pentium® III, Pentium® II, Celeron™ processor among these preset values. Note: <input checked="" type="checkbox"/> Mark the checkbox that corresponds to the working frequency of your Pentium® III, Pentium® II, Celeron™ processor in case the CMOS configuration should be lost.
<input type="checkbox"/> 233MHz (66 x 3.5)	<input type="checkbox"/> 350MHz (100 x 3.5)	
<input type="checkbox"/> 266MHz (66 x 4.0)	<input type="checkbox"/> 400MHz (100 x 4.0)	
<input type="checkbox"/> 300MHz (66 x 4.5)	<input type="checkbox"/> 450MHz (100 x 4.5)	
<input type="checkbox"/> 333MHz (66 x 5.0)	<input type="checkbox"/> 500MHz (100 x 5.0)	
<input type="checkbox"/> 366MHz (66 x 5.5)	<input type="checkbox"/> 550MHz (100 x 5.5)	
<input type="checkbox"/> 400MHz (66 x 6.0)	<input type="checkbox"/> 600MHz (100 x 6.0)	
<input type="checkbox"/> 433MHz (66 x 6.5)	<input type="checkbox"/>	

Note: if you use Bus Frequencies of 75 MHz, make sure that your PCI cards can cope with the higher PCI clock.

Step 4. Select [SAVE & EXIT SETUP]

Press **<Enter>** to save the new configuration to the CMOS memory, and continue the boot sequence.

4 The SOYO CD

Your SY-6ZB Motherboard comes with a CD-ROM labeled "SOYO CD." The SOYO CD contains the user's manual file for your new Motherboard, the drivers software available for installation, and a database in HTML format with information on SOYO Motherboards and other products.

Step 1. Insert the SOYO CD into the CD-ROM drive
The SOYO CD will auto-run, and the SOYO CD Start Up Menu will display as shown below.

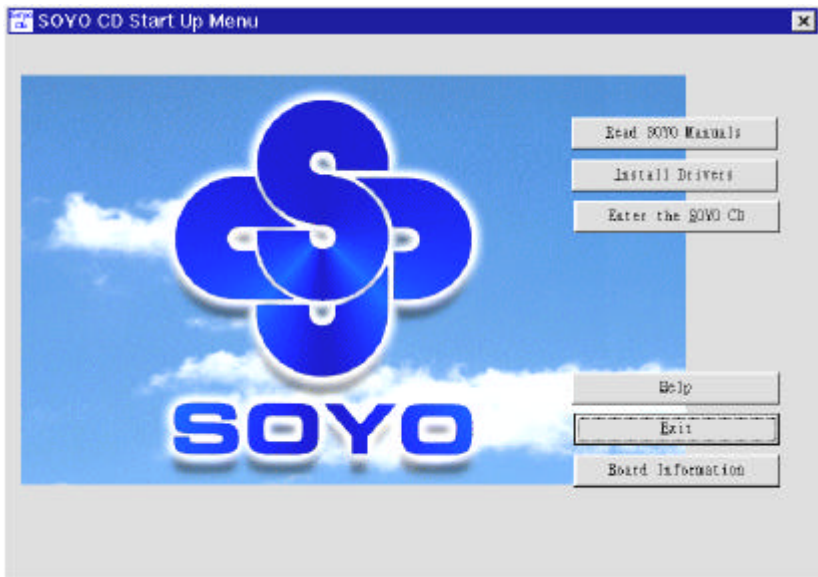

(SOYO CD Start Up Program Menu)

The SOYO CD Start Up Program automatically detects which SOYO Motherboard you own and displays the corresponding model name.

Step 2. Read SOYO [6ZB] Manual

Click the **Read Manual** button to open the user's manual file of your Motherboard.

Please note that if the Start Up program was unable to determine which SOYO Motherboard you own, the manual selection menu will pop up, as shown below. Then select the user's manual file that corresponds to your Motherboard model name and click **OK**.

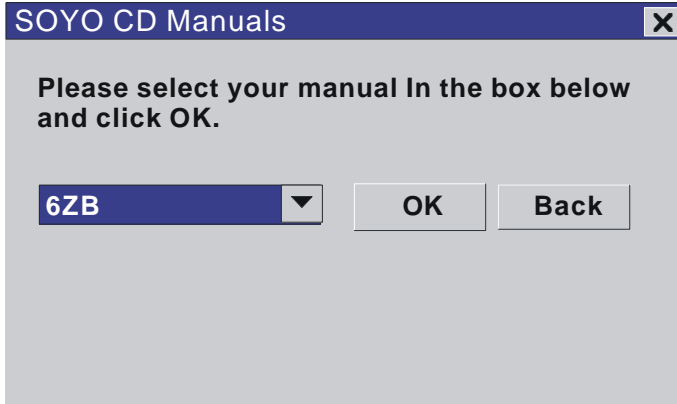

(Manual Selection Menu)

The user's manual files included on the SOYO CD can be read in PDF (Postscript Document) format. In order to read a PDF file, the appropriate Acrobat Reader software must be installed in your system.

Note: The Start Up program automatically detects if the Acrobat Reader utility is already present in your system, and otherwise prompts you on whether or not you want to install it. You must install the Acrobat Reader utility to be able to read the user's manual file. Follow the instructions on your screen during installation, then once the installation is completed, restart your system and re-run the SOYO CD.

Step 3. Install Drivers

Click the **Install Drivers** button to display the list of drivers software that can be installed with your Motherboard. The Start Up program displays the drivers available for the particular model of Motherboard you own. We recommend that you only install those drivers.

SY-6ZB Quick Start Guide

The following drivers are available for Windows 95

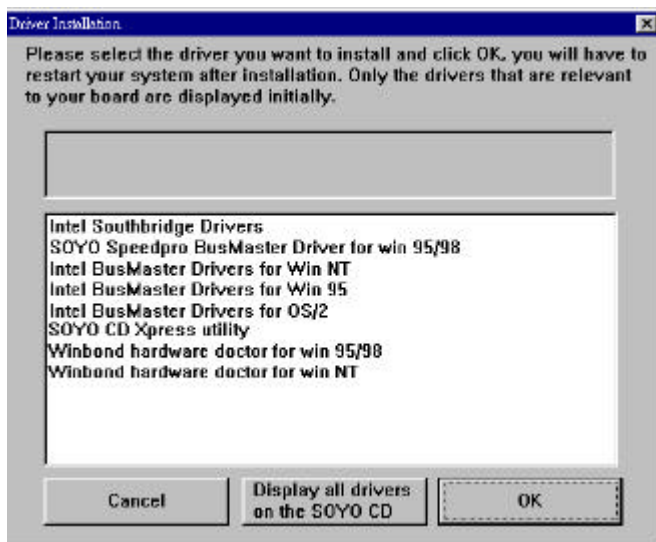

(Driver Installation Menu)

The following drivers are available for Windows 98

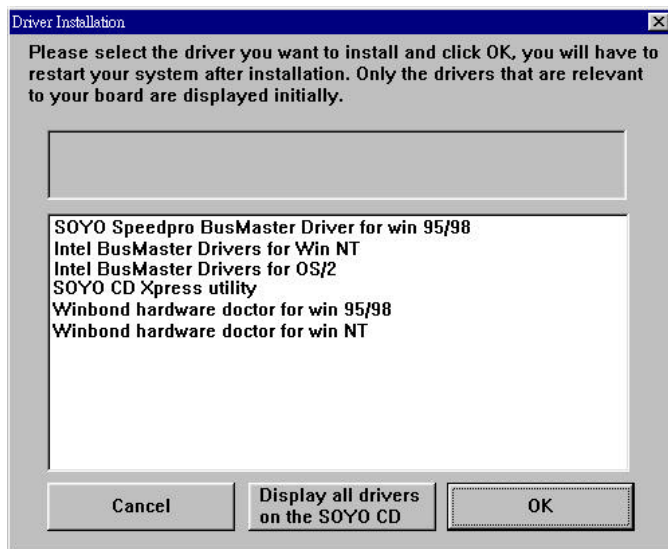

(Driver Installation Menu)

A short description of all available drivers follows:

➤ Intel Southbridge Drivers

Because Windows 95 does not recognize the Southbridge of the newer Intel chipsets (TX, ZX, ZX etc) this utility has to be run, it will update the necessary Windows files. (Only for Windows 95)

➤ SOYO SpeedPro Busmaster Driver for Win 95/98

Without the busmaster drivers the CPU will need to be involved every time data is read from or written to the Harddisk. The busmaster drivers make use of DMA (Direct Memory Access) to relieve the CPU of this burden, thus speeding up the system.

The SOYO SpeedPro driver makes use of an advanced caching algorithm, which gives it an advantage over other busmaster drivers.

➤ Intel Busmaster Drivers for Windows 95

➤ Intel Busmaster Drivers for Win NT

➤ Intel Busmaster Drivers for OS/2

These are the official busmaster drivers as supplied by Intel.



Note: Do NEVER install two types of busmaster drivers on your system, this will lead to conflicts and system instability. Therefore, if you install the SOYO SpeedPro Busmaster driver you can NOT install the Intel Busmaster drivers. Before installing a new busmaster driver first UNINSTALL the old busmaster driver.

➤ SOYO CD Xpress Utility

This utility will enhance your CD-ROM Drive data-throughput by using space on the Harddisk as cache. This way application programs can access data faster. This utility is suitable for Windows 95/98.

➤ Winbond hardware doctor for Windows xx

Your motherboard comes with a hardware monitoring IC. By installing this utility Temperature, Fan speed and Voltages can be monitored. It is also possible to set alarms when current system values exceed or fall below pre-set values.

This utility comes with a preset monitoring range for the CPU voltage. However, the core voltage of the processor you purchased may fall out of this preset range, so you may need to adjust the pre-set value. Please refer to the SY-6ZB Motherboard's CD manual for the details.

Select which driver you want to install and click **OK**, or click **Cancel** to abort the driver installation and return to the main menu.

SY-6ZB Quick Start Guide

Note: Once you have selected a driver, the system will automatically exit the SOYO CD to begin the driver installation program. When the installation is complete, most drivers require to restart your system before they can become active.

However, to display the list of all drivers software available with SOYO Motherboards, click the **Display all drivers on the SOYO CD** button. Please make sure to install only the drivers adapted to your system, or otherwise this cause system malfunctions.

Step 4. Enter the SOYO CD

Click the **Enter SOYO CD** button to enter the SOYO HTML database. The Start Up program will activate the default HTML browser installed on your system (for example, Internet Explorer or Netscape) to visualize the contents of the SOYO CD.

The SOYO CD contains useful information about your Motherboard and other SOYO products available in as many as eleven different languages. For your convenience, this information is available in HTML format, similar to the format widely used on the Internet.



(SOYO CD HTML Database in English*)

(* The list of menu options may vary between languages)

Note: If no HTML browser is installed on your system, the Start Up program will prompt you on whether or not you would like to install the Internet Explorer* browser. Click YES to install the HTML browser. After the installation is complete, please restart your system. Then re-run the SOYO CD and you will be able to browse the SOYO HTML database.

(* Internet Explorer is a Microsoft Trademark)

Edition: March 1999
Version 1 .0
6ZB SERIAL

International Headquarters

Soyo Computer Inc., (Taiwan)
Tel: 886-2-2290-3300
Fax: 886-2-2298-3322
Web Site: <http://www.soyo.com.tw>
E-mail: info@mail.soyo.com.tw

USA Branch Office

Soyo Tek Inc., (USA)
Tel: (408) 452-7696
Fax: (408) 573-7696
Web Site: <http://www.soyousa.com>
E-mail: sales@soyousa.com

SOYO Europe

Soyo Europe B.V., (Holland)
Tel: 31-79-3637500
Fax: 31-79-3637575
Web Site: <http://www.soyo-europe.com>
<http://www.soyo.nl>
E-mail: Sales@soyo.nl

Germany Branch Office

SAAT Technology GmbH, (Germany)
Tel: 49-(0)441-204044
Fax: 49-(0)441-203422
Web Sites: <http://www.saat.de>
<http://www.soyo-saat.de>
<http://www.soyo-saat.com>
Email: sales@saat.de

UK Branch Office

Soyo (U.K.) Ltd.
Tel: 44-(0)181-569 4111
Fax: 44-(0)181-569 4134
Web Site: <http://www.soyo.nl>
E-mail: sales@soyo.nl

Japan Branch Office

Soyo Computer (Japan)
Tel: 81-3-33682188
Fax: 81-3-33682199
Web Site: <http://www.soyo.co.jp>
E-mail: soyo@po.ijinet.or.jp

Hong Kong Branch Office

Soyo Hong Kong Ltd. (H.K.)
Tel: 852-2710-9810
Fax: 852-2710-9078
Web Site: <http://www.soyo.com.hk>
E-mail: rshu@hkstar.com