

# SH7286 Group PLQP0176KB-A User System Interface Board

R0E572860CFK00

User's Manual

Renesas Microcomputer Development Environment System  
SuperH™ Family / SH7280 Series

Rev. 1.00  
Revision Date: Jan. 09, 2008

Renesas Technology  
[www.renesas.com](http://www.renesas.com)

User's Manual



## Notes regarding these materials

1. This document is provided for reference purposes only so that Renesas customers may select the appropriate Renesas products for their use. Renesas neither makes warranties or representations with respect to the accuracy or completeness of the information contained in this document nor grants any license to any intellectual property rights or any other rights of Renesas or any third party with respect to the information in this document.
2. Renesas shall have no liability for damages or infringement of any intellectual property or other rights arising out of the use of any information in this document, including, but not limited to, product data, diagrams, charts, programs, algorithms, and application circuit examples.
3. You should not use the products or the technology described in this document for the purpose of military applications such as the development of weapons of mass destruction or for the purpose of any other military use. When exporting the products or technology described herein, you should follow the applicable export control laws and regulations, and procedures required by such laws and regulations.
4. All information included in this document such as product data, diagrams, charts, programs, algorithms, and application circuit examples, is current as of the date this document is issued. Such information, however, is subject to change without any prior notice. Before purchasing or using any Renesas products listed in this document, please confirm the latest product information with a Renesas sales office. Also, please pay regular and careful attention to additional and different information to be disclosed by Renesas such as that disclosed through our website. (<http://www.renesas.com>)
5. Renesas has used reasonable care in compiling the information included in this document, but Renesas assumes no liability whatsoever for any damages incurred as a result of errors or omissions in the information included in this document.
6. When using or otherwise relying on the information in this document, you should evaluate the information in light of the total system before deciding about the applicability of such information to the intended application. Renesas makes no representations, warranties or guaranties regarding the suitability of its products for any particular application and specifically disclaims any liability arising out of the application and use of the information in this document or Renesas products.
7. With the exception of products specified by Renesas as suitable for automobile applications, Renesas products are not designed, manufactured or tested for applications or otherwise in systems the failure or malfunction of which may cause a direct threat to human life or create a risk of human injury or which require especially high quality and reliability such as safety systems, or equipment or systems for transportation and traffic, healthcare, combustion control, aerospace and aeronautics, nuclear power, or undersea communication transmission. If you are considering the use of our products for such purposes, please contact a Renesas sales office beforehand. Renesas shall have no liability for damages arising out of the uses set forth above.
8. Notwithstanding the preceding paragraph, you should not use Renesas products for the purposes listed below:
  - (1) artificial life support devices or systems
  - (2) surgical implantations
  - (3) healthcare intervention (e.g., excision, administration of medication, etc.)
  - (4) any other purposes that pose a direct threat to human lifeRenesas shall have no liability for damages arising out of the uses set forth in the above and purchasers who elect to use Renesas products in any of the foregoing applications shall indemnify and hold harmless Renesas Technology Corp., its affiliated companies and their officers, directors, and employees against any and all damages arising out of such applications.
9. You should use the products described herein within the range specified by Renesas, especially with respect to the maximum rating, operating supply voltage range, movement power voltage range, heat radiation characteristics, installation and other product characteristics. Renesas shall have no liability for malfunctions or damages arising out of the use of Renesas products beyond such specified ranges.
10. Although Renesas endeavors to improve the quality and reliability of its products, IC products have specific characteristics such as the occurrence of failure at a certain rate and malfunctions under certain use conditions. Please be sure to implement safety measures to guard against the possibility of physical injury, and injury or damage caused by fire in the event of the failure of a Renesas product, such as safety design for hardware and software including but not limited to redundancy, fire control and malfunction prevention, appropriate treatment for aging degradation or any other applicable measures. Among others, since the evaluation of microcomputer software alone is very difficult, please evaluate the safety of the final products or system manufactured by you.
11. In case Renesas products listed in this document are detached from the products to which the Renesas products are attached or affixed, the risk of accident such as swallowing by infants and small children is very high. You should implement safety measures so that Renesas products may not be easily detached from your products. Renesas shall have no liability for damages arising out of such detachment.
12. This document may not be reproduced or duplicated, in any form, in whole or in part, without prior written approval from Renesas.
13. Please contact a Renesas sales office if you have any questions regarding the information contained in this document, Renesas semiconductor products, or if you have any other inquiries.



# IMPORTANT INFORMATION

## READ FIRST

- **READ this user's manual before using this emulator product.**
- **KEEP the user's manual handy for future reference.**

**Do not attempt to use the emulator product until you fully understand its mechanism.**

### **Emulator Product:**

Throughout this document, the term "emulator product" shall be defined as the following products produced only by Renesas Technology Corp. and Renesas Solutions Corp. excluding all subsidiary products.

- E200F main unit
- External bus trace unit
- Evaluation-chip unit
- Expansion profiling unit
- Emulation memory unit
- User system interface board
- Trace cable

The user system or a host computer is not included in this definition.

### **Purpose of the User System Interface Board:**

This user system interface board is used to connect the evaluation-chip unit to the user system. This user system interface board must only be used for the above purpose.

### **Limited Applications:**

This emulator product is not authorized for use in transportation, vehicular, medical (where human life is potentially at stake), aerospace, nuclear, or undersea repeater applications. Buyers of this emulator product must notify Renesas Technology Corporation, Renesas Solutions Corporation or an authorized Renesas Technology product distributor before planning to use the product in such applications.

### **Improvement Policy:**

Renesas Technology Corp. (including its subsidiaries, hereafter collectively referred to as Renesas) pursues a policy of continuing improvement in design, performance, and safety of the emulator product. Renesas reserves the right to change, wholly or partially, the specifications, design, user's manual, and other documentation at any time without notice.

## **Target User of the Emulator Product:**

This emulator product should only be used by those who have carefully read and thoroughly understood the information and restrictions contained in the user's manual. Do not attempt to use the emulator product until you fully understand its mechanism.

It is highly recommended that first-time users be instructed by users that are well versed in the operation of the emulator product.

Users are required to be familiar with the basic knowledge for the electric circuits, logic circuits, and microcomputers.

## **Precautions to be Taken when Using This Product:**

1. This emulator is a development supporting unit for use in your program development and evaluation stages. In mass-producing your program you have finished developing, be sure to make a judgment on your own risk that it can be put to practical use by performing integration test, evaluation, or some experiment else.
2. In no event shall Renesas Solutions Corporation be liable for any consequence arising from the use of this emulator.
3. Renesas Solutions Corporation strives to renovate or provide a workaround for product malfunction at some charge or without charge. However, this does not necessarily mean that Renesas Solutions Corporation guarantees the renovation or the provision under any circumstances.
4. This emulator has been developed by assuming its use for program development and evaluation in laboratories. Therefore, it does not fall under the application of Electrical Appliance and Material Safety Law and protection against electromagnetic interference when used in Japan.
5. This emulator does not conform to safety standards such as UL or IEC. Be careful when you take this emulator overseas.
6. Renesas cannot anticipate every possible circumstance that might involve a potential hazard. The warnings in this user's manual and on the emulator product are therefore not all inclusive. Therefore, you must use the emulator product safely at your own risk.

## **LIMITED WARRANTY**

Renesas warrants its emulator products to be manufactured in accordance with published specifications and free from defects in material and/or workmanship. Renesas, at its option, will replace any emulator products returned intact to the factory, transportation charges prepaid, which Renesas, upon inspection, shall determine to be defective in material and/or workmanship. The foregoing shall constitute the sole remedy for any breach of Renesas' warranty. See the Renesas warranty booklet for details on the warranty period. This warranty extends only to you, the original Purchaser. It is not transferable to anyone who subsequently purchases the emulator product from you. Renesas is not liable for any claim made by a third party or made by you for a third party.

## **DISCLAIMER**

RENESAS MAKES NO WARRANTIES, EITHER EXPRESS OR IMPLIED, ORAL OR WRITTEN, EXCEPT AS PROVIDED HEREIN, INCLUDING WITHOUT LIMITATION THEREOF, WARRANTIES AS TO MARKETABILITY, MERCHANTABILITY, FITNESS FOR ANY PARTICULAR PURPOSE OR USE, OR AGAINST INFRINGEMENT OF ANY PATENT. IN NO EVENT SHALL RENESAS BE LIABLE FOR ANY DIRECT, INCIDENTAL OR CONSEQUENTIAL DAMAGES OF ANY NATURE, OR LOSSES OR EXPENSES RESULTING FROM ANY DEFECTIVE EMULATOR PRODUCT, THE USE OF ANY EMULATOR PRODUCT, OR ITS DOCUMENTATION, EVEN IF ADVISED OF THE POSSIBILITY OF SUCH DAMAGES. EXCEPT AS EXPRESSLY STATED OTHERWISE IN THIS WARRANTY, THIS EMULATOR PRODUCT IS SOLD "AS IS", AND YOU MUST ASSUME ALL RISK FOR THE USE AND RESULTS OBTAINED FROM THE EMULATOR PRODUCT.

**State Law:**

Some states do not allow the exclusion or limitation of implied warranties or liability for incidental or consequential damages, so the above limitation or exclusion may not apply to you. This warranty gives you specific legal rights, and you may have other rights which may vary from state to state.

**The Warranty is Void in the Following Cases:**

Renesas shall have no liability or legal responsibility for any problems caused by misuse, abuse, misapplication, neglect, improper handling, installation, repair or modifications of the emulator product without Renesas' prior written consent or any problems caused by the user system.

**All Rights Reserved:**

1. Circuitry and other examples described herein are meant merely to indicate the characteristics and performance of Renesas' semiconductor products. Renesas assumes no responsibility for any intellectual property claims or other problems that may result from applications based on the examples described herein.
2. No license is granted by implication or otherwise under any patents or other rights of any third party or Renesas.
3. This user's manual and emulator product are copyrighted and all rights are reserved by Renesas. No part of this user's manual, all or part, may be reproduced or duplicated in any form, in hard-copy or machine-readable form, by any means available without Renesas' prior written consent.

**Figures:**

Some figures in this user's manual may show items different from your actual system.



# SAFETY PAGE

## READ FIRST

- **READ** this user's manual before using this emulator product.
- **KEEP** the user's manual handy for future reference.

Do not attempt to use the emulator product until you fully understand its mechanism.

## DEFINITION OF SIGNAL WORDS

Either in the user's manual or on the product, several icons are used to insure proper handling of this product and also to prevent injuries to you or other persons, or damage to your properties. Their graphic images and meanings are given in this safety page. Be sure to read this chapter before using the product.



**This is the safety alert symbol. It is used to alert you to potential personal injury hazards. Obey all safety messages that follow this symbol to avoid possible injury or death.**



**DANGER** indicates an imminently hazardous situation which, if not avoided, will result in death or serious injury.



**WARNING** indicates a potentially hazardous situation which, if not avoided, could result in death or serious injury.



**CAUTION** indicates a potentially hazardous situation which, if not avoided, may result in minor or moderate injury.



**CAUTION** used without the safety alert symbol indicates a potentially hazardous situation which, if not avoided, may result in property damage.

**NOTE** emphasizes essential information.

In addition to the four above, the following are also used as appropriate.

 means WARNING or CAUTION.

Example:  CAUTION AGAINST AN ELECTRIC SHOCK

 means PROHIBITION.

Example:  DISASSEMBLY PROHIBITED

 means A FORCIBLE ACTION.

Example:  UNPLUG THE POWER CABLE FROM THE RECEPTACLE.

# **WARNING**

## **Warnings for AC Power Supply:**



• If the attached AC power cable does not fit the receptacle, do not alter the AC power cable and do not plug it forcibly. Failure to comply may cause electric shock and/or fire.

• Use an AC power cable which complies with the safety standard of the country.

• Do not touch the plug of the AC power cable when your hands are wet. This may cause electric shock.

• This product is connected signal ground with frame ground. If your developing product is transformless (not having isolation transformer of AC power), this may cause electric shock. Also, this may give an unreparable damage to this product and your developing one.

While developing, connect AC power of the product to commercial power through isolation transformer in order to avoid these dangers.

• If other equipment is connected to the same branch circuit care should be taken not to overload the circuit. Refer to nameplate for electrical ratings.



• When installing this equipment, insure that a reliable ground connection is maintained.

# **WARNING**

-  • If you smell a strange odor, hear an unusual sound, or see smoke coming from this product, then disconnect power immediately by unplugging the AC power cable from the outlet.

Do not use this as it is because of the danger of electric shock and/or fire. In this case, contact your local distributor.

- When installing or connecting this product with other equipment, shut down AC power or disconnect the AC power cord from the equipment to prevent personal injury or damage to the equipment.

## **Warnings to Be Taken for This Product:**

-  • Do not disassemble or modify this product. Personal injury due to electric shock may occur if this product is disassembled and modified.
- Make sure nothing falls into the cooling fan on the top panel, especially liquids, metal objects, or anything combustible.

## **Warning for Installation:**

-  • Do not set this product in water or areas of high humidity. Make sure that the product does not get wet. Spilling water or some other liquid into the product may cause unreparable damage.

## **Warning for Use Environment:**

- This equipment is to be used in an environment with a maximum ambient temperature of 35°C. Care should be taken that this temperature is not exceeded.

## CAUTION

### Cautions for AC Adapter:

- ❗ • Use only the AC adapter included in this product package.
  - The included AC adapter is for this emulator. Do not use it for other product.
  - The DC plug on the included AC adapter has the below polarity.



- The included AC adapter has no power supply switch. The AC adapter is always active while connecting the AC power cable.

### Cautions to Be Taken for This Product:

- ❗ • Use caution when handling this product. Be careful not to apply a mechanical shock.
  - Do not pull the main unit by the probe of the emulation probe or the flexible cable which are connected to this product. Excessive flexing or force of the flexible cable for connecting this product to the emulation probe may break connector.

### Caution for Installation:

- ❗ • When in use do not place the emulator on its side.

# **WARNING**

**Observe the precautions listed below. Failure to do so will result in a FIRE HAZARD and will damage the user system and the emulator product or will result in PERSONAL INJURY. The USER PROGRAM will be LOST.**

- 1. Do not repair or remodel the emulator product by yourself for electric shock prevention and quality assurance.**
- 2. Always switch OFF the E200F emulator and user system before connecting or disconnecting any CABLES or PARTS.**
- 3. Always before connecting any CABLES, make sure that pin 1 on both sides are correctly aligned.**

# Preface

The R0E572860CFK00 is a user system interface board that connects a user system for the SH7286 PLQP0176KB-A (former package: FP-176EV) package to the SH7280 E200F emulator (R0E0200F1EMU00 or R0E572800VKK00).

# Contents

Section 1	Configuration.....	1
Section 2	Environmental Conditions.....	3
Section 3	Connection Procedures.....	4
3.1	Connecting User System Interface Board to User System.....	4
3.1.1	Installing IC Socket.....	4
3.1.2	Installing Cable Head.....	5
3.1.3	Fastening Cable Head.....	5
3.2	Connecting User System Interface Board to EV-Chip Board.....	7
3.3	Recommended Dimensions for User System Mount Pad (Footprint).....	9
3.4	Dimensions for External Bus Trace Unit, Emulation Memory Unit, EV-Chip Unit, and User System Interface Board.....	10
3.5	Resulting Dimensions after Connecting User System Interface Board.....	12
Section 4	Installing the MCU to the User System.....	15
Section 5	Verifying Operation.....	17
Section 6	Notice.....	18



# Section 1 Configuration

Figure 1 and table 1 show the external appearance and components, respectively, of the user system interface board for the PLQP0176KB-A. Please make sure you have all of these components when unpacking.

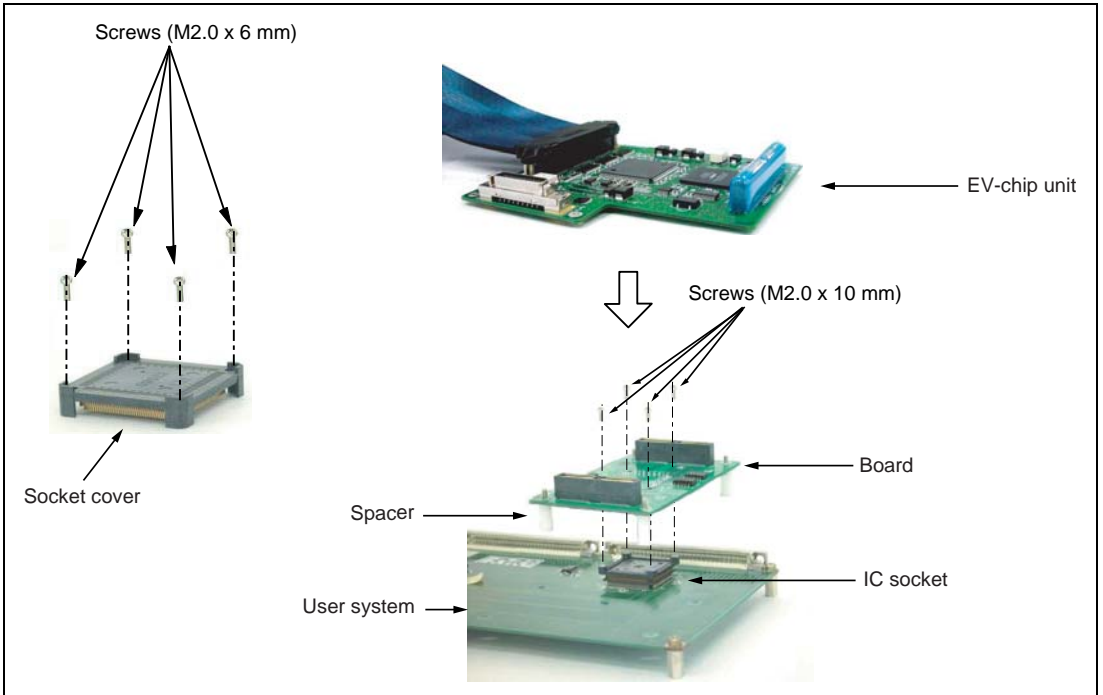

**Figure 1 User System Interface Board for the SH7286 PLQP0176KB-A Package**

# CAUTION

**Use a NQPACK176SD socket (manufactured by Tokyo Eletech Corporation) and a HQPACK176SD (manufactured by Tokyo Eletech Corporation) for the PLQP0176KB-A package IC socket and socket cover, respectively, on the user system.**

**Table 1 R0E572860CFK00 Components**

<b>No.</b>	<b>Component</b>	<b>Quantity</b>	<b>Remarks</b>
1	Board	1	With four spacers (2.6MP x 11 mm)
2	IC socket	1	For the PLQP0176KB-A package (to be mounted on the user system)
3	Socket cover	1	For the PLQP0176KB-A package (for installing MCU)
4	Screws (M2.0 x 10 mm)	4	For fastening board
5	Screws (M2.0 x 6 mm)	4	For installing a PLQP0176KB-A-packaged MCU
6	Guide pins	3	
7	Screwdriver	1	
8	User's manual	1	User's manual for R0E572860CFK00 (this manual)

## Section 2 Environmental Conditions

Maintain the conditions in table 2 when using the emulator.

**Table 2 Environmental Conditions**

<b>Item</b>	<b>Specifications</b>
Temperature	Operating: +10 to +35°C Storage: -10 to +35°C
Humidity	Operating: 35 to 80% RH, no condensation Storage: 35 to 80% RH, no condensation
Vibration	Operating: 2.45 m/s <sup>2</sup> max. Storage: 4.9 m/s <sup>2</sup> max. Transportation: 14.7 m/s <sup>2</sup> max.
Ambient gases	There must be no corrosive gases present.

## Section 3 Connection Procedures

### 3.1 Connecting User System Interface Board to User System

#### **WARNING**

**Always switch OFF the user system and the emulator product before the USER SYSTEM INTERFACE BOARD is connected to or removed from any part. Before connecting, make sure that pin 1 on both sides are correctly aligned. Failure to do so will result in a FIRE HAZARD and will damage the user system and the emulator product or will result in PERSONAL INJURY. The USER PROGRAM will be LOST.**

To connect the cable head to the user system, follow the instructions below.

#### 3.1.1 Installing IC Socket

Solder the IC socket for a PLQP0176KB-A package to the user system.

#### **CAUTION**

**Be sure to completely solder the leads so that the solder slops gently over the leads and forms solder fillets. (Use slightly more solder than the MCU.)**

### 3.1.2 Installing Cable Head

## CAUTION

**Check the location of pin 1 before inserting.**

Align pin 1 on the IC socket for a PLQP0176KB-A package on the user system with pin 1 on the user system interface board, and insert the user system interface board into the IC socket on the user system, as shown in figure 2.

### 3.1.3 Fastening Cable Head

## CAUTION

- 1. Use a Phillip-type screwdriver whose head matches the screw head.**
- 2. The tightening torque must be 0.054 N•m or less.  
If the applied torque cannot be accurately measured, stop tightening when the force required to turn the screw becomes significantly greater than that needed when first tightening. If a screw is tightened too much, the screw head may break or an IC socket contact error may be caused by a crack in the IC socket solder.**
- 3. If the emulator does not operate correctly, cracks might have occurred in the solder. Check conduction with a tester and re-solder the IC socket if necessary.**

Fasten the user system interface board to the IC socket for a PLQP0176KB-A package on the user system with the four screws (M2.0 x 10 mm) provided. Each screw should be tightened a little at a time, alternating between screws on opposing corners. Take special care, such as manually securing the IC socket soldered area, to prevent the soldered IC socket from being damaged by overtightening the screws or twisting the components.

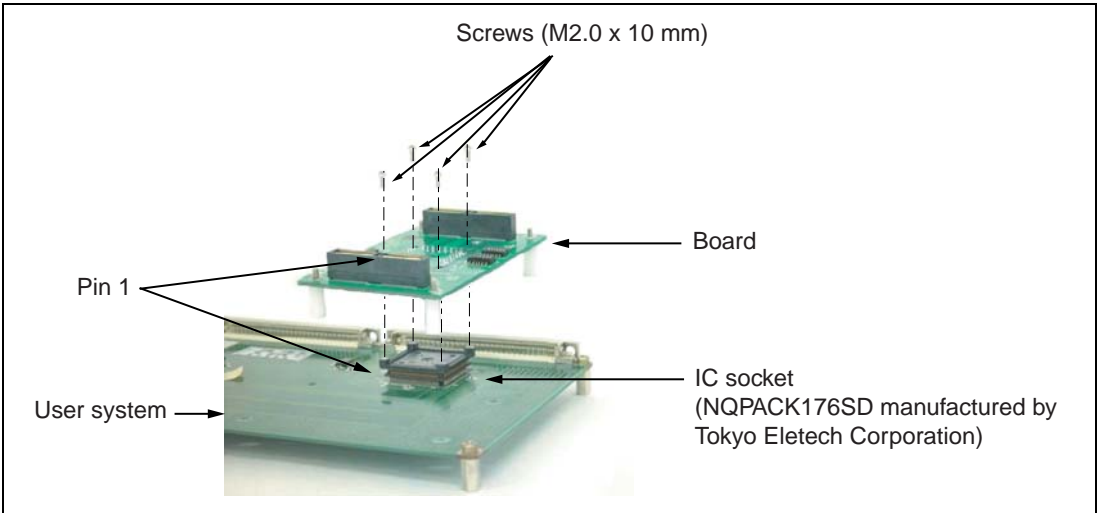

**Figure 2 Connecting User System Interface Board to User System**

## 3.2 Connecting User System Interface Board to EV-Chip Board

### **WARNING**

**Observe the precautions listed below. Failure to do so will result in a FIRE HAZARD and will damage the user system and the emulator product or will result in PERSONAL INJURY. The USER PROGRAM will be LOST.**

- 1. Always switch OFF the user system and the emulator product before the USER SYSTEM INTERFACE BOARD is connected to or removed from any part. Before connecting, make sure that pin 1 on both sides are correctly aligned.**
- 2. The user system interface board dedicated to the emulator must be used.**

1. Make sure the user system and emulator are turned off.
2. Align the connectors on the board with those on the EV-chip board according to their numbers (figure 3).
3. Adjust the height of the spacer attached to the board with the user system.

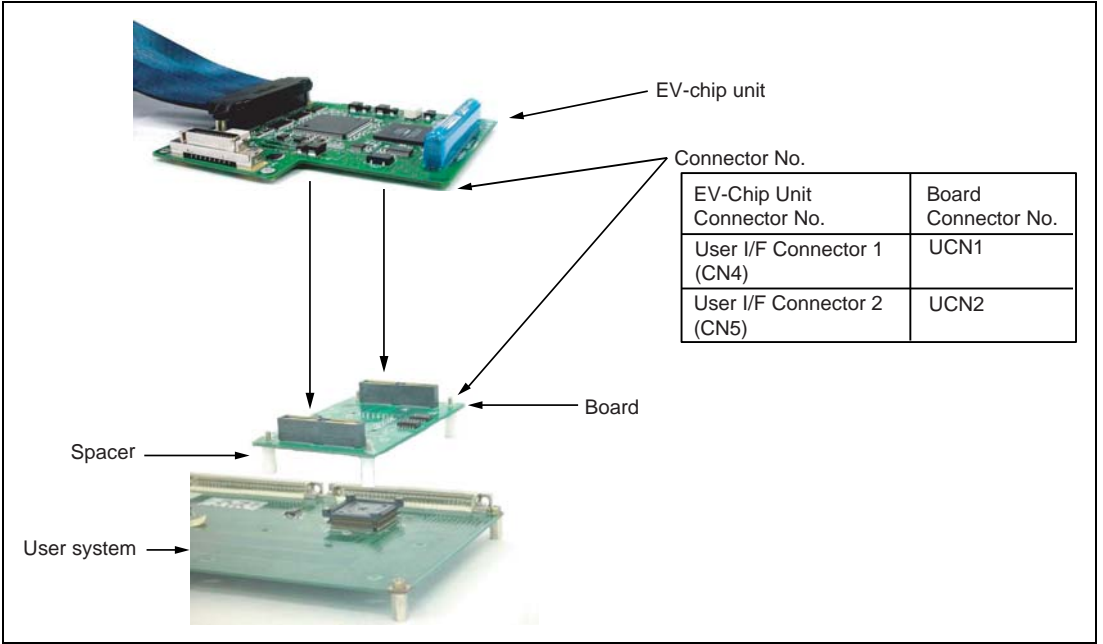

**Figure 3 Connecting User System Interface Board to EV-Chip Board**



### 3.3 Recommended Dimensions for User System Mount Pad (Footprint)

Figure 4 shows the recommended dimensions for the mount pad (footprint) for the user system with an IC socket for a PLQP0176KB-A package (NQPACK176SD: manufactured by Tokyo Eletech Corporation). Note that the dimensions in figure 4 are somewhat different from those of the actual chip's mount pad.

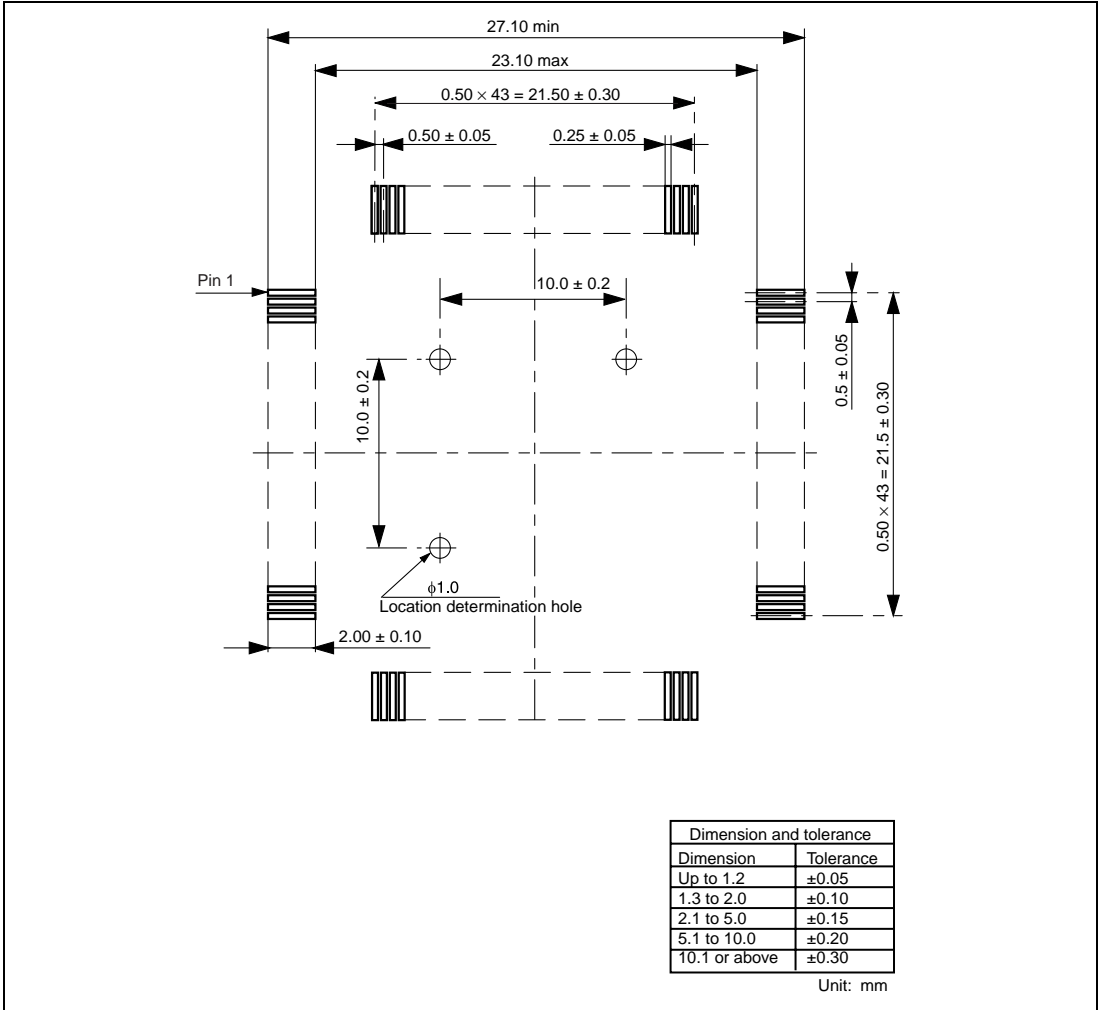
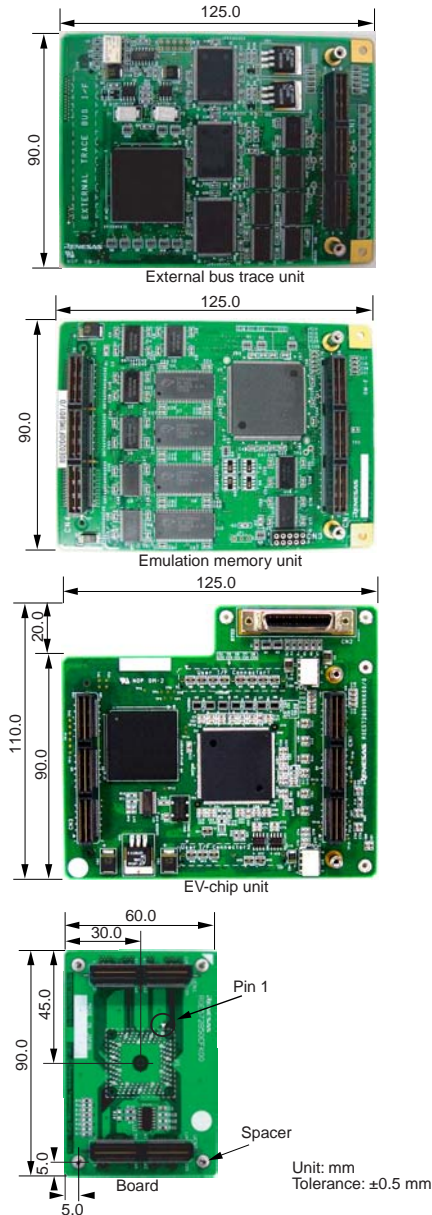

Figure 4 Recommended Dimensions for Mount Pad

### **3.4 Dimensions for External Bus Trace Unit, Emulation Memory Unit, EV-Chip Unit, and User System Interface Board**

The dimensions for the external bus trace unit, emulation memory unit, EV-chip unit, and the user system interface board are shown in figure 5.



**Figure 5 Dimensions for External Bus Trace Unit, Emulation Memory Unit, EV-Chip Unit, and User System Interface Board**

### 3.5 Resulting Dimensions after Connecting User System Interface Board

The resulting dimensions, after connecting the user system interface board to the user system, are shown in figures 6, 7, and 8.

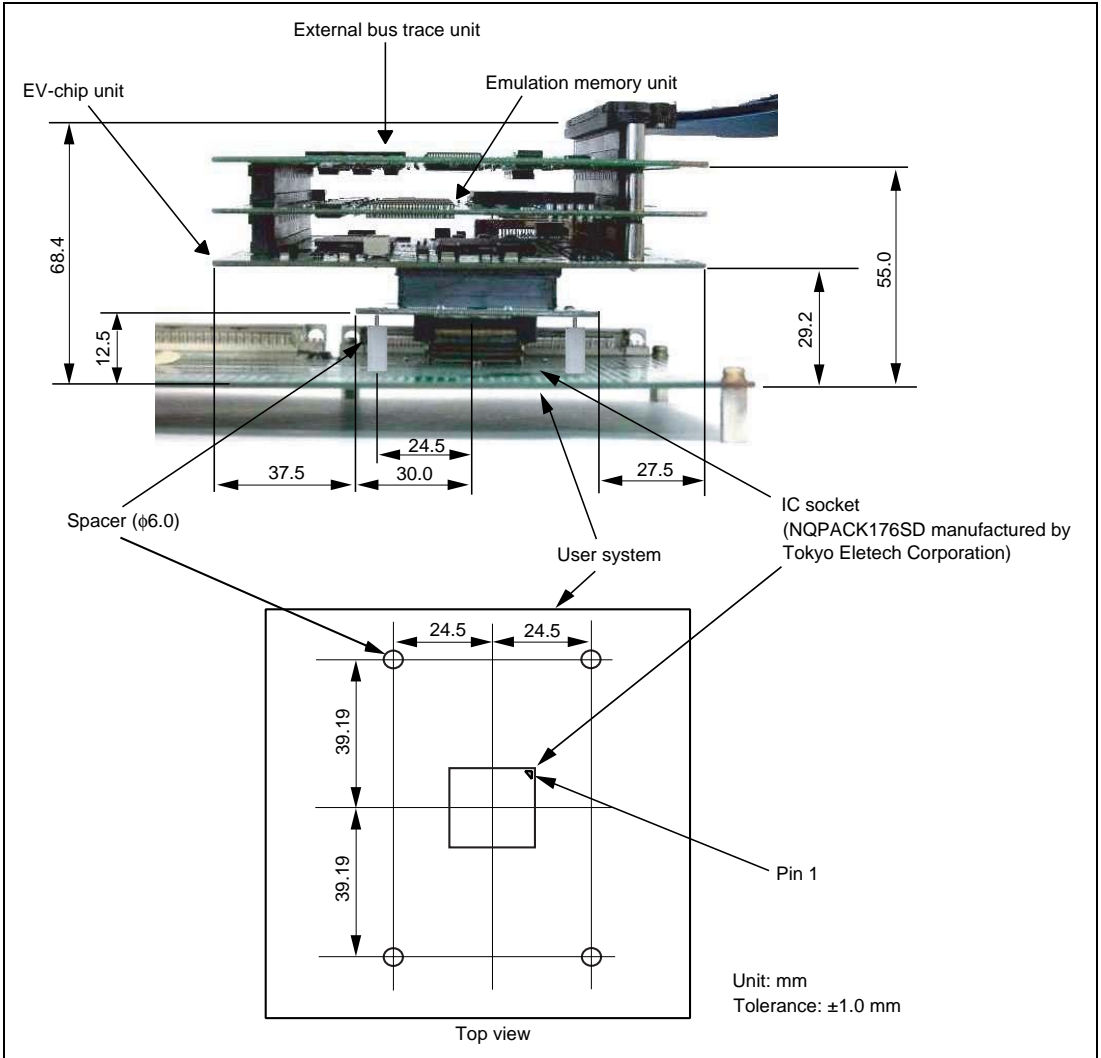

**Figure 6 Resulting Dimensions after Connecting User System Interface Board (when Connecting External Bus Trace Unit, Emulation Memory Unit, and EV-Chip Unit)**

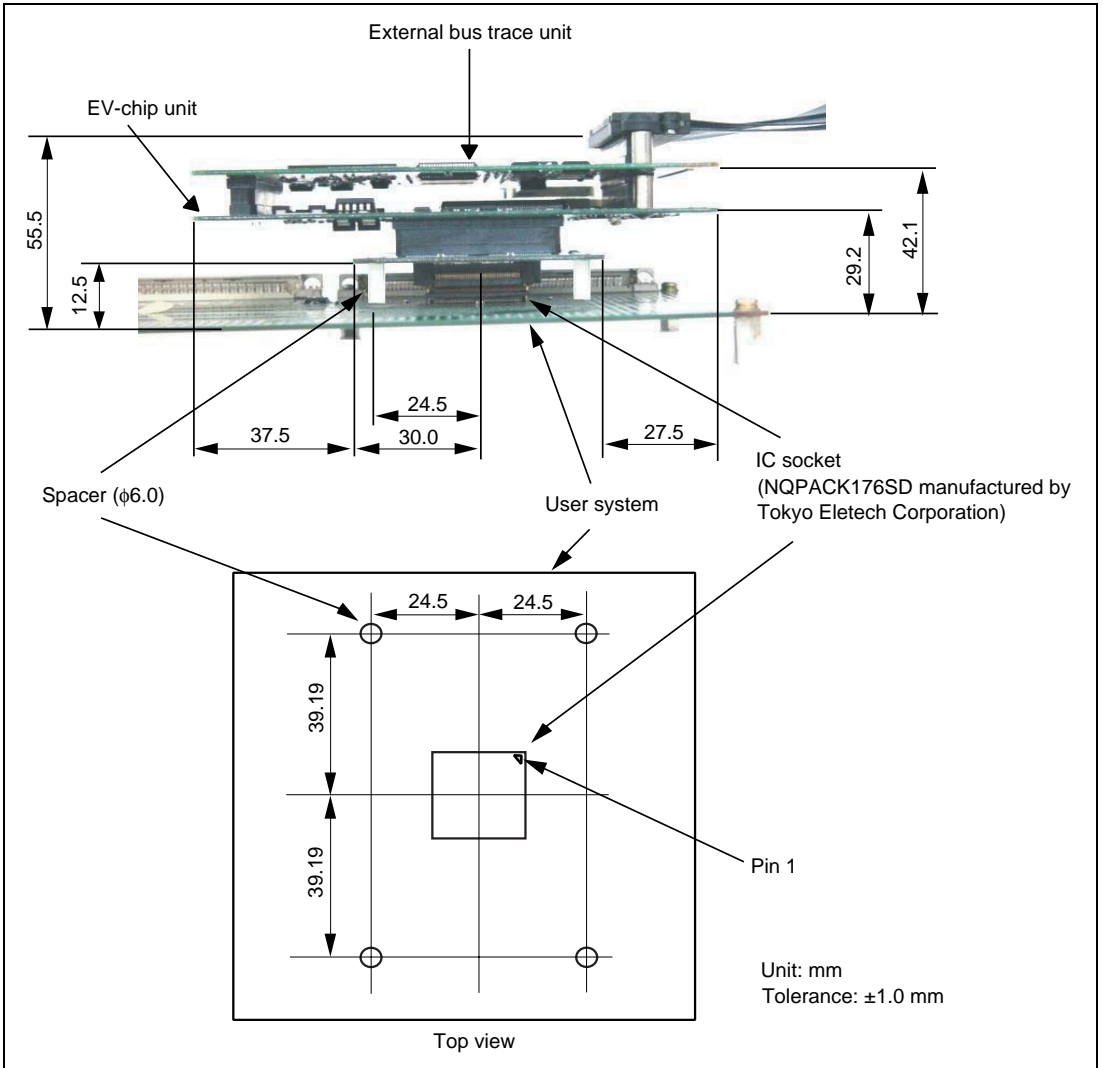

**Figure 7 Resulting Dimensions after Connecting User System Interface Board (when Connecting External Bus Trace Unit and EV-Chip Unit)**

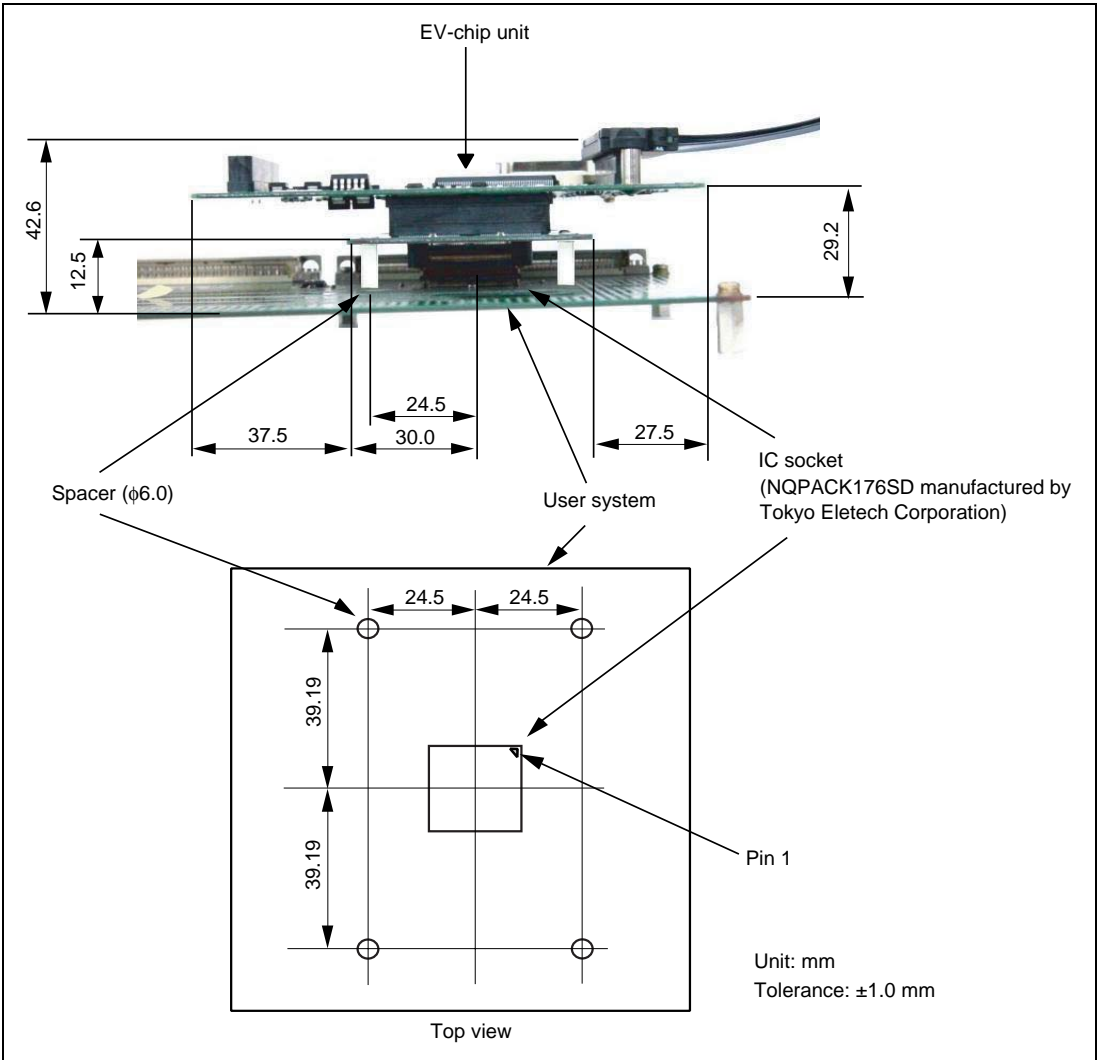

**Figure 8 Resulting Dimensions after Connecting User System Interface Board (when Connecting EV-Chip Unit)**

## Section 4 Installing the MCU to the User System

### CAUTION

- 1. Check the location of pin 1 before inserting.**
- 2. Use a Philips-type screwdriver whose head matches the screw head.**
- 3. The tightening torque must be 0.054 N•m or less.  
If the applied torque cannot be accurately measured, stop tightening when the force required to turn the screw becomes significantly greater than that needed when first tightening. If a screw is tightened too much, the screw head may break or an IC socket contact error may be caused by a crack in the IC socket solder.**
- 4. If the MCU does not operate correctly, cracks might have occurred in the solder. Check conduction with a tester and re-solder the IC socket if necessary.**

Check the location of pin 1 before inserting the MCU into the IC socket on the user system, as shown in figure 9. After inserting the MCU, fasten the socket cover with the provided four screws (M2.0 x 6 mm). Take special care, such as manually securing the IC socket soldered area, to prevent the IC socket from being damaged by overtightening the screws or twisting the components.

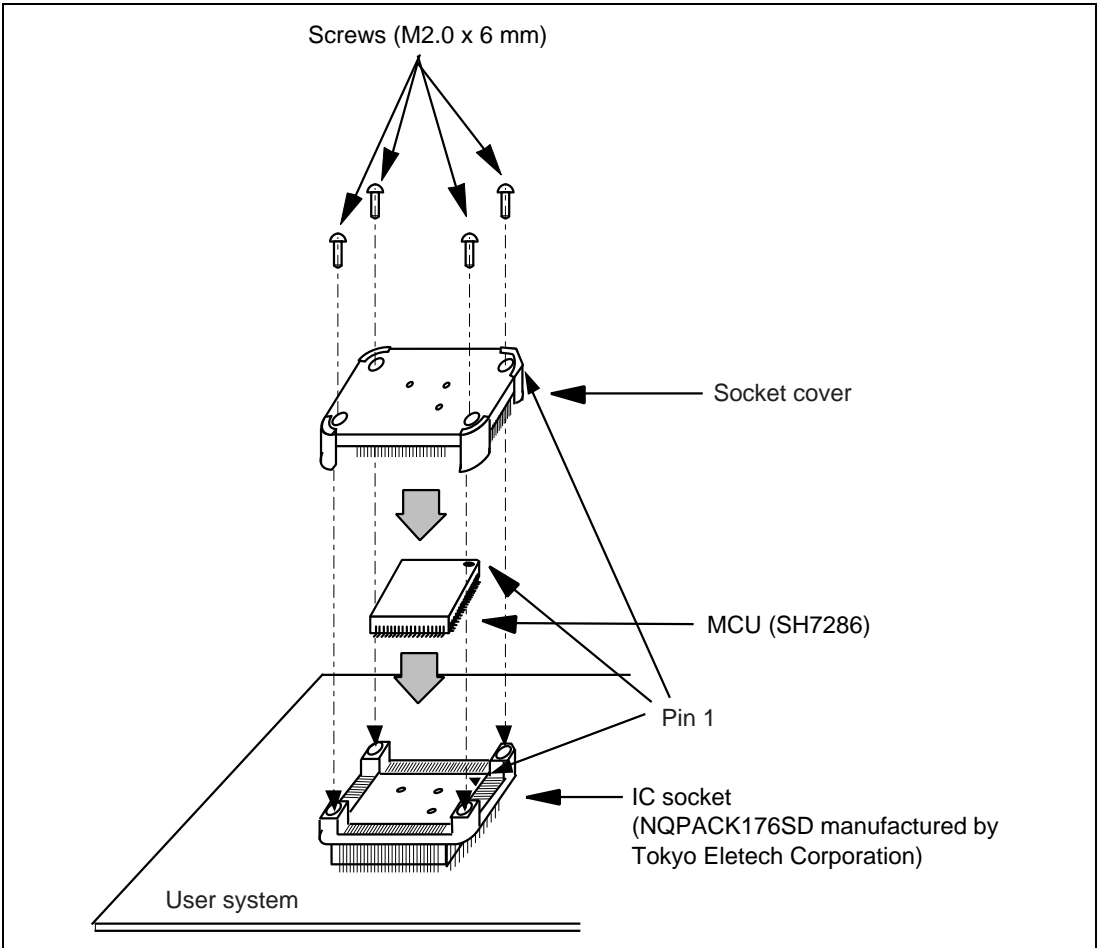

**Figure 9 Installing MCU to User System**



## Section 5 Verifying Operation

1. Turn on the emulator according to the procedures described in the SH-2A, SH-2 E200F Emulator User's Manual (R0E0200F1EMU00E or R0E572800EMU00E).
2. The emulator connected to this user system interface board supports three kinds of clock sources as the MCU clock. For details, refer to the SH7080 E200F Emulator User's Manual (R0E0200F1EMU00E).

— To use the emulator internal clock

Select the clock in the emulator by the CLOCK command (emulator command).

— To use the external clock on the user system

Supply the external clock from the user system to the emulator by inputting the EXTAL pin (pin 115) on the user system interface board or connecting the crystal oscillator to the XTAL (pin 113) and EXTAL pins. For details, refer to section 4, Clock Pulse Generator, in the SH7280 Group Hardware Manual.

Figure 10 shows the clock oscillator on the user system interface board.

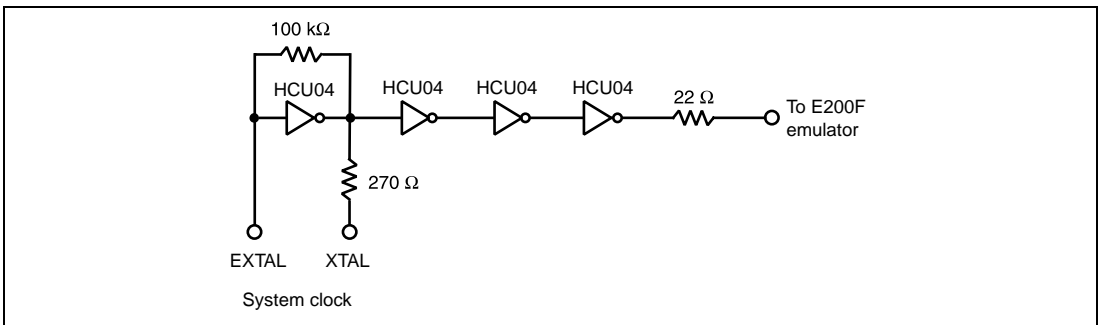

**Figure 10 Clock Oscillator**

## Section 6 Notice

1. Before connecting any parts or cables, make sure that pin 1 on the both sides are correctly aligned.
2. Do not apply excessive force to the user system interface board while it is connected to the user system.
3. The dimensions of the recommended mount pad for the IC socket for this user system interface board are different from those of the MCU.
4. This user system interface board is specifically designed for the SH7280 E200F EV-chip unit (R0E572800VKK00). Do not use this board with any other emulator.
5. When power is not supplied to the Vcc pin on the user system interface board, the emulator displays \*\* VCC DOWN. The emulator will not operate correctly.

---

**SH7286 Group PLQP0176KB-A**  
**User System Interface Board**  
**User's Manual**

Publication Date: Rev.1.00, January 9, 2008  
Published by: Sales Strategic Planning Div.  
Renesas Technology Corp.  
Edited by: Customer Support Department  
Global Strategic Communication Div.  
Renesas Solutions Corp.

Renesas Technology Corp. Sales Strategic Planning Div. Nippon Bldg., 2-6-2, Ohte-machi, Chiyoda-ku, Tokyo 100-0004, Japan

---



## RENESAS SALES OFFICES

<http://www.renesas.com>

Refer to "<http://www.renesas.com/en/network>" for the latest and detailed information.

**Renesas Technology America, Inc.**  
450 Holger Way, San Jose, CA 95134-1368, U.S.A  
Tel: <1> (408) 382-7500, Fax: <1> (408) 382-7501

**Renesas Technology Europe Limited**  
Dukes Meadow, Millboard Road, Bourne End, Buckinghamshire, SL8 5FH, U.K.  
Tel: <44> (1628) 585-100, Fax: <44> (1628) 585-900

**Renesas Technology (Shanghai) Co., Ltd.**  
Unit 204, 205, AZIACenter, No.1233 Lujiazui Ring Rd, Pudong District, Shanghai, China 200120  
Tel: <86> (21) 5877-1818, Fax: <86> (21) 6887-7858/7898

**Renesas Technology Hong Kong Ltd.**  
7th Floor, North Tower, World Finance Centre, Harbour City, Canton Road, Tsimshatsui, Kowloon, Hong Kong  
Tel: <852> 2265-6688, Fax: <852> 2377-3473

**Renesas Technology Taiwan Co., Ltd.**  
10th Floor, No.99, Fushing North Road, Taipei, Taiwan  
Tel: <886> (2) 2715-2888, Fax: <886> (2) 3518-3399

**Renesas Technology Singapore Pte. Ltd.**  
1 Harbour Front Avenue, #06-10, Keppel Bay Tower, Singapore 098632  
Tel: <65> 6213-0200, Fax: <65> 6278-8001

**Renesas Technology Korea Co., Ltd.**  
Kukje Center Bldg. 18th Fl., 191, 2-ka, Hangang-ro, Yongsan-ku, Seoul 140-702, Korea  
Tel: <82> (2) 796-3115, Fax: <82> (2) 796-2145

**Renesas Technology Malaysia Sdn. Bhd**  
Unit 906, Block B, Menara Amcorp, Amcorp Trade Centre, No.18, Jln Persiaran Barat, 46050 Petaling Jaya, Selangor Darul Ehsan, Malaysia  
Tel: <603> 7955-9390, Fax: <603> 7955-9510



SH7286 Group PLQP0176KB-A  
User System Interface Board  
User's Manual

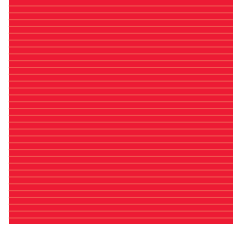

Renesas Technology Corp.

2-6-2, Ote-machi, Chiyoda-ku, Tokyo, 100-0004, Japan