

Installation Instructions



IMPORTANT SAFEGUARDS

1. Read Instructions - All safety and operating instructions should be read before the unit is operated.
2. Retain Instructions - The safety and operating instructions should be retained for future reference.
3. Heed Warnings - All warnings on the unit and in the operating instructions should be adhered to.
4. Follow Instructions - All operating and use instructions should be followed.
5. Cleaning - Unplug the unit from the outlet before cleaning. Do not use liquid cleaners or aerosol cleaners. Use a damp cloth for cleaning.
6. Attachments - Do not use attachments not recommended by the product manufacturer as they may cause hazards.
7. Water and Moisture - Do not use this unit near water - for example, in a wet basement, near a swimming pool, in an unprotected outdoor installation, or any area classified as a wet location.
8. Accessories - Do not place this unit on an unstable stand, tripod, bracket, or mount. The unit may fall, causing serious injury to a person and serious damage to the unit. Use only with a stand, tripod, bracket, or mount recommended by the manufacturer or sold with the product. Any mounting of the unit should follow the manufacturer's instructions and should use a mounting accessory recommended by the manufacturer.

An appliance and cart combination should be moved with care. Quick stops, excessive force, and uneven surfaces may cause the appliance and cart combination to overturn.
9. Ventilation - This unit should not be placed in a built-in installation or rack, unless proper ventilation is provided, or the manufacturer's instructions have been adhered to. The equipment must not exceed its maximum operating temperature requirements.
10. Mechanical Loading - Mounting of the equipment in a rack shall be such that a hazardous condition is not achieved due to uneven mechanical loading.
11. Power Sources - This unit should be operated only from the type of power source indicated on the marking label. If you are not sure of the type of power supply you plan to use, consult your dealer or local power company. For units intended to operate from battery power or other sources, refer to the operating instructions.
12. Grounding or Polarization - This unit may be equipped with a polarized alternating-current line plug (a plug having one blade wider than the other). This plug will fit into the power outlet only one way. This is a safety feature. If you are unable to insert the plug fully into the outlet, try reversing the plug. If the plug should still fail to fit, contact your electrician to replace your obsolete outlet. Do not defeat the safety purpose of the polarized plug.

Alternately, this unit may be equipped with a 3-wire grounding-type plug, a plug having a third (grounding) pin. This plug will only fit into a grounding-type power outlet. This is a safety feature. If you are unable to insert the plug into the outlet, contact your electrician to replace your obsolete outlet. Do not defeat the safety purpose of the grounding-type plug.
13. Power Cord Protection - Power supply cords should be routed so that they are not likely to be walked on or pinched by items placed upon or against them, paying particular attention to cords and plugs, convenience receptacles, and the point where they exit from the appliance.
14. Power Lines - An outdoor system should not be located in the vicinity of overhead power lines or other electric light or power circuits or where it can fall into such power lines or circuits. When installing an outdoor system, extreme care should be taken to keep from touching such power lines or circuits, as contact with them might be fatal. U.S.A. models only - refer to the National Electrical Code Article 820 regarding installation of CATV systems.
15. Overloading - Do not overload outlets and extension cords, as this can result in a risk of fire or electric shock.
16. Object and Liquid Entry - Never push objects of any kind into this unit through openings, as they may touch dangerous voltage points or short out parts that could result in a fire or electric shock. Never spill liquid of any kind on the unit.
17. Servicing - Do not attempt to service this unit yourself as opening or removing covers may expose you to dangerous voltage or other hazards. Refer all servicing to qualified service personnel.
18. Damage Requiring Service - Unplug the unit from the outlet and refer servicing to qualified service personnel under the following conditions:
 - a. When the power supply cord or plug is damaged.
 - b. If liquid has been spilled or objects have fallen into the unit.
 - c. If the unit has been exposed to water and/or inclement weather (rain, snow, etc.).
 - d. If the unit does not operate normally by following the operating instructions. Adjust only those controls that are covered by the operating instructions, as an improper adjustment of other controls may result in damage, often requiring extensive work by a qualified technician, to restore the unit to its normal operation.
 - e. If the unit has been dropped or the cabinet has been damaged.
 - f. When the unit exhibits a distinct change in performance--this indicates a need for service.
19. Replacement Parts - When replacement parts are required, be sure the service technician has used replacement parts specified by the manufacturer or having the same characteristics as the original part. Unauthorized substitutions may result in fire, electric shock, or other hazards.
20. Safety Check - Upon completion of any service or repairs to this unit, ask the service technician to perform safety checks to determine that the unit is in proper operating condition.
21. Coax Grounding - If an outside cable system is connected to the unit, be sure the cable system is grounded. U.S.A. models only--Section 810 of the National Electrical Code, ANSI/NFPA No. 70-1981, provides information with respect to proper grounding of the mount and supporting structure, grounding of the coax to a discharge unit, size of grounding conductors, location of discharge unit, connection to grounding electrodes, and requirements for the grounding electrode.
22. Lightning - For added protection of this unit during a lightning storm, or when it is left unattended and unused for long periods of time, unplug it from the wall outlet and disconnect the cable system. This will prevent damage to the unit due to lightning and power line surges.

FCC & ICES INFORMATION

(U.S.A. and Canadian Models Only)

WARNING - This equipment has been tested and found to comply with the limits for a Class A digital device, pursuant to Part 15 of the FCC Rules and ICES-003 of Industry Canada. These limits are designed to provide reasonable protection against harmful interference when the equipment is operated in a commercial environment. This equipment generates, uses, and radiates radio frequency energy and, if not installed and used in accordance with the instruction manual, may cause harmful interference to radio communications. Operation of this equipment in a residential area is likely to cause harmful interference in which case the user will be required to correct the interference at his own expense. Intentional or unintentional changes or modifications not expressly approved by the party responsible for compliance shall not be made. Any such changes or modifications could void the user's authority to operate the equipment.

If necessary, the user should consult the dealer or an experienced radio/television technician for corrective action. The user may find the following booklet prepared by the Federal Communications Commission helpful: "How to Identify and Resolve Radio-TV Interference Problems." This booklet is available from the U.S. Government Printing Office, Washington, DC 20402, Stock No.004-000-00345-4.

Warning: This is a Class A product. In a domestic environment, this product may cause radio interference in which case the user may be required to take adequate measures.

SAFETY PRECAUTIONS



CAUTION

RISK OF ELECTRIC SHOCK. DO NOT OPEN!



CAUTION: TO REDUCE THE RISK OF ELECTRICAL SHOCK, DO NOT OPEN COVERS. NO USER SERVICEABLE PARTS INSIDE. REFER SERVICING TO QUALIFIED SERVICE PERSONNEL.



The lightning flash with an arrowhead symbol within an equilateral triangle is intended to alert the user to the presence of uninsulated “dangerous voltage” within the product’s enclosure that may be of sufficient magnitude to constitute a risk of electric shock to persons.



The exclamation point within an equilateral triangle is intended to alert the user to presence of important operating and maintenance (servicing) instructions in the literature accompanying the appliance.

WARNING

TO PREVENT FIRE OR SHOCK HAZARD, DO NOT EXPOSE UNITS NOT SPECIFICALLY DESIGNED FOR OUTDOOR USE TO RAIN OR MOISTURE.



Attention: Installation should be performed by qualified service personnel only in accordance with the National Electrical Code or applicable local codes.



Power Disconnect. Units with or without ON-OFF switches have power supplied to the unit whenever the power cord is inserted into the power source; however, the unit is operational only when the ON-OFF switch is in the ON position. The power cord is the main power disconnect for all units.

SECURITE



ATTENTION

RISQUE D'ÉLECTROCUTION. NE PAS OUVRIR!



DANGER : POUR ÉVITER TOUT RISQUE D'ÉLECTROCUTION, VEUILLEZ NE PAS OUVRIR LE BOÎTIER. IL N'Y A PAS DE PIÈCES REMPLAÇABLES PAR L'UTILISATEUR À L'INTÉRIEUR DU BOÎTIER. POUR TOUTE MAINTENANCE, VEUILLEZ VOUS ADRESSER À UN TECHNICIEN SPÉCIALISÉ.



L'éclair fléché dans un triangle équilatéral avertit l'utilisateur de la présence d'une “tension dangereuse” non isolée à l'intérieur de l'appareil et d'une valeur suffisante pour présenter un risque d'électrocution aux personnes.



Le point d'exclamation contenu dans un triangle équilatéral avertit l'utilisateur de la présence de consignes d'utilisation et de maintenance importantes dans la documentation qui accompagne l'appareil.

ATTENTION

POUR ÉVITER TOUT RISQUE D'ÉLECTROCUTION OU D'INCENDIE, VEUILLEZ NE PAS EXPOSER À LA PLUIE OU À L'HUMIDITÉ UN APPAREIL NON CONÇU POUR UNE UTILISATION EXTÉRIEURE.



Attention. L'installation ne doit être effectuée que par un personnel technique qualifié conformément à la réglementation du Code Électrique National ou à la réglementation locale pertinente.



Disjonction de l'alimentation. Les appareils avec ou sans commutateurs ON-OFF sont alimentés à chaque fois que le cordon d'alimentation est branché à la source d'alimentation; toutefois, les appareils disposant de commutateurs ON-OFF ne fonctionnent que lorsque le commutateur ON-OFF est dans la position ON. Le cordon d'alimentation constitue le moyen de disjonction de l'alimentation principale de tous les appareils.

WARNING: Electrostatic-sensitive device. Use proper CMOS/MOSFET handling precautions to avoid electrostatic discharge.

NOTE: Grounded wrist straps must be worn and proper ESD safety precautions observed when handling the electrostatic-sensitive printed circuit boards.





ATTENTION
OBSERVE PRECAUTIONS
FOR HANDLING
ELECTROSTATIC
SENSITIVE DEVICES

CAUTION: Lithium Battery

Danger of explosion if battery is incorrectly replaced. Replace only with the same or equivalent type recommended by the manufacturer. Dispose of used batteries according to the battery manufacturer's instructions



SICHERHEITSHINWEISE

	VORSICHT ELEKTRISCHE SPANNUNG. NICHT ÖFFNEN!	
VORSICHT: DAS GEHÄUSE ZUR VERMEIDUNG VON ELEKTRISCHEN SCHLÄGEN NICHT ÖFFNEN. DAS GERÄT ENTHÄLT KEINE VOM BENUTZER ZU WARTENDEN TEILE. REPARATUREN NUR VON FACHPERSONAL AUSFÜHREN LASSEN.		

 Das Blitzsymbol im gleichseitigen Dreieck soll den Benutzer auf nicht isolierte "gefährliche Spannung" im Produkt hinweisen, die ausreichend stark sein kann, um die Gefahr von elektrischen Schlägen für Menschen darzustellen.

 Das Ausrufungszeichen im gleichseitigen Dreieck soll den Benutzer auf wichtige Bedienungs- und Wartungsanweisungen in der Dokumentation hinweisen, die dem Gerät beiliegt.

**WARNUNG
ZUR VERMEIDUNG VON FEUER UND
ELEKTRISCHEN SCHLÄGEN DAS GERÄT
NICHT REGEN ODER FEUCHTIGKEIT
AUSSETZEN.**

 Achtung: Die Installation darf nur von qualifiziertem Wartungspersonal gemäß dem National Electrical Code oder den gültigen örtlichen Vorschriften durchgeführt werden.

 Abtrennen der Spannungsversorgung: Die Spannungsversorgung zu Geräten mit und ohne Ein/Aus-Schalter ist hergestellt, wenn das Netzkabel an eine Netzsteckdose angeschlossen ist. Das Gerät ist jedoch nur betriebsbereit, wenn der Ein/Aus-Schalter eingeschaltet ist. Bei allen Geräten erfolgt das Abtrennen der Spannungsversorgung über das Netzkabel.

SEGURIDAD

	PRECAUCIÓN RIESGO DE DESCARGA ELÉCTRICA ¡NO ABRIR!	
PRECAUCIÓN: PARA REDUCIR EL RIESGO DE DESCARGA ELÉCTRICA, NO ABRA LAS TAPAS. EN EL INTERIOR NO HAY NINGÚN COMPONENTE REPARABLE POR EL USUARIO. LAS REPARACIONES DEBE REALIZARLAS PERSONAL CUALIFICADO.		

 El símbolo de flecha en forma de rayo situado dentro de un triángulo equilátero pretende alertar al usuario de la presencia de "voltaje peligroso" sin aislamiento dentro de la caja del producto, el cual podría resultar de una magnitud suficiente como para presentar un riesgo de descarga eléctrica para las personas.

 El punto de exclamación dentro de un triángulo equilátero pretende alertar al usuario de la existencia de instrucciones de funcionamiento y mantenimiento (reparación) en la documentación suministrada con el aparato.

**AVISO
PARA IMPEDIR EL RIESGO DE INCENDIO O
DESCARGA, NO EXPONGA EL APARATO A
LLUVIA O HUMEDAD**

 Atención: La instalación debe realizarla personal cualificado en cumplimiento estricto del código eléctrico nacional (en el caso de los EE.UU.) o de los códigos locales aplicables.

 Para Desconectar la Alimentación: Unidades no equipadas con interruptores ON/OFF, son alimentadas cuando el cable de alimentación es conectado a la corriente eléctrica. Las unidades equipadas con interruptores son alimentadas de igual forma, pero adicionalmente requieren que el interruptor esté posicionado en ON. El cable de alimentación es el medio principal de desconexión del equipo.

VEILIGHEIDSMATREGELEN

	VOORZICHTIG GEVAAR VOOR ELEKTRISCHE SCHOK. NIET OPENEN!	
VOORZICHTIG: MAAK HET APPARAAT NIET OPEN OM DE KANS OP ELEKTRISCHE SCHOKKEN TE VERMIJDEN. BEVAT GEEN ONDERDELEN DIE DOOR DE GEBRUIKER MOETEN WORDEN ONDERHOUDEN. LAAT ONDERHOUD EN REPARATIES UITVOEREN DOOR BEVOEGDE TECHNICI.		

 Het symbool 'Bliksemflits met pijlkop' in een gelijkzijdige driehoek wijst de gebruiker op de aanwezigheid in de kast van het apparaat van niet-geïsoleerde spanningen die voldoende sterk zijn om het gevaar van elektrische schokken op te leveren.



 Het uitroepteken in een gelijkzijdige driehoek maakt de gebruiker attent op de aanwezigheid in de bij het apparaat behorende documentatie van belangrijke aanwijzingen voor bediening en onderhoud.

**WAARSCHUWING
TER VOORKOMING VAN BRANDGEVAAR
EN ELEKTRISCHE SCHOKKEN MAG DIT
ARMATUUR NIET AAN REGEN EN VOCHT
WORDEN BLOOTGESTELD.**

 Let op: Het apparaat mag uitsluitend door bevoegde technici geïnstalleerd worden en wel in overeenstemming met de National Electrical Code of de daarvoor plaatselijk geldende richtlijnen.

 Afsluiten voeding. Apparaten met of zonder ON-OFF-schakelaar krijgen voeding zodra het netsnoer in de wandcontactdoos wordt gestoken; het apparaat is echter alleen operationeel als de ON-OFF-schakelaar op ON staat. Het netsnoer kan bij alle apparaten worden gebruikt om deze uit te schakelen.

SICUREZZA

	ATTENZIONE PERICOLO DI SCOSSA ELETTRICA. NON APRIRE.	
ATTENZIONE: PER RIDURRE IL PERICOLO DI SCOSSA ELETTRICA, NON APRIRE LE COPERTURE. L'INTERNO NON CONTIENE COMPONENTI CHE L'UTENTE PUÒ RIPARARE PERSONALMENTE. RIVOLGERSI AL PERSONALE DI ASSISTENZA QUALIFICATO PER QUALSIASI INTERVENTO DI RIPARAZIONE.		

 Il simbolo triangolare di un fulmine con la punta a freccia intende mettere in allerta l'utente riguardo alla presenza di tensioni pericolose non isolate all'interno del guscio dell'unità, che potrebbero essere di intensità sufficiente per costituire pericolo di elettrocuzione.

 Il punto esclamativo racchiuso in un triangolo equilatero intende avvisare l'utente in merito alla presenza di importanti istruzioni operative e di manutenzione nella documentazione di accompagnamento all'unità.

**AVVERTENZA
PER IMPEDIRE INCENDI O SCOSSA
ELETTRICA, NON ESPORRE L'UNITÀ ALLA
PIOGGIA O ALL'UMIDITÀ.**

 Precauzione: affidare l'installazione al solo personale qualificato e nel rispetto del Codice elettrico nazionale (USA) o dei codici locali pertinenti.

 Scollegamento dell'alimentazione. Gli apparecchi con o senza commutatori ON-OFF ricevono corrente tutte le volte che il cavo di alimentazione è inserito nella presa di forza; tuttavia, gli apparecchi muniti di commutatore ON-OFF funzionano solo se quest'ultimo è in posizione ON. Il cavo di alimentazione serve a scollegare dalla corrente tutti gli apparecchi.

MEDIDAS DE SEGURANÇA

	CUIDADO RISCO DE CHOQUE ELÉCTRICO. NÃO ABRIR!	
CUIDADO: PARA REDUZIR O RISCO DE CHOQUE ELÉCTRICO, NÃO ABRA AS TAMPAS. O INTERIOR NÃO CONTÉM PEÇAS QUE NECESSITEM DE MANUTENÇÃO. A MANUTENÇÃO DEVE SER EFECTUADA POR PESSOAL DE ASSISTÊNCIA TÉCNICA QUALIFICADO.		



O símbolo do raio com a cabeça de uma seta dentro de um triângulo equilátero serve para alertar o utilizador para a presença de "corrente eléctrica perigosa" não isolada no interior da caixa do produto que pode ser suficiente para dar origem a choques eléctricos.



O ponto de exclamação dentro de um triângulo equilátero serve para alertar o utilizador para a presença de instruções de funcionamento e manutenção importantes na documentação fornecida com o aparelho.

AVISO

PARA EVITAR INCÊNDIOS OU CHOQUES ELÉCTRICOS, NÃO EXPONHA À CHUVA OU HUMIDADE UNIDADES NÃO ESPECIFICAMENTE CRIADAS PARA UTILIZAÇÃO NO EXTERIOR.



Atenção: A instalação deve ser efectuada por pessoal de assistência técnica qualificado, de acordo com o National Electrical Code (Normas de Electricidade Nacionais) ou a legislação local aplicável.





Desconexão da electricidade. Unidades com ou sem interruptores ON-OFF são activadas sempre que o cabo eléctrico for ligado a uma fonte de alimentação. No entanto, a unidade fica operacional apenas quando o interruptor ON-OFF se encontrar na posição ON. Para desligar a electricidade em qualquer uma das unidades deve ser utilizado o cabo eléctrico.



Precauções a ter durante a substituição da bateria
Use apenas fontes de alimentação recomendadas. As fontes de alimentação devem cumprir os requisitos da versão mais recente de IEC 65/VDE 0860. Qualquer substituição pode causar danos na unidade ou dar origem a incêndios ou choques eléctricos.

ZASADY BESPİCZENSTAWA

	UWAGA NIEBEZPIECZENSTWO PORAZENIA PRĄDEM ELEKTRYCZNYM. NIE OTWIERAĆ!	
UWAGA: ZE WZGLĘDU NA NIEBEZPIECZENSTWO PORAZENIA PRĄDEM NIE WOLNO OTWIERAĆ POKRYWY. W ŚRODKU NIE MA ŻADNYCH ELEMENTÓW, KTÓRE MOGĄ BYĆ NAPRAWIANE PRZEZ UŻYTKOWNIKA. NAPRAWĘ NALEŻY POWIERZYĆ AUTORYZOWANEMU PUNKTOWI SERWISOWEMU.		



Błyskawica ze strzałką wewnątrz trójkąta równobocznego ma za zadanie zwrócić uwagę użytkownika na obecność nieizolowanego "niebezpiecznego napięcia" wewnątrz obudowy urządzenia, o wielkości stwarzającej niebezpieczeństwo porażenia prądem.



Wykrzyknik wewnątrz trójkąta równobocznego ma za zadanie zwrócić uwagę użytkownika na ważne czynności, związane z obsługą i konserwacją urządzenia, zamieszczone w Instrukcji obsługi.

OSTRZEŻENIE

ABY UNIKNĄĆ POŻARU LUB PORAZENIA PRĄDEM NIE WOLNO WYSTAWIAĆ NA DZIAŁANIE DESZCZU LUB WILGOCI URZĄDZEŃ, KTÓRE NIE ZOSTAŁY SPECJALNIE ZAPROJEKTOWANE DO UŻYWANIA NA OTWARTYM POWIETRZU.



Uwaga: Instalację urządzenia powinien wykonać tylko wykwalifikowany personel, zgodnie z przepisami NEC lub odpowiednimi przepisami miejscowymi.



Odłączanie zasilania. Urządzenia zarówno nie posiadające, jak i posiadające wyłączniki ON-OFF znajdują się pod napięciem, jeżeli tylko przewód zasilający jest połączony ze źródłem zasilania. Jednakże urządzenie działa tylko wtedy, gdy wyłącznik znajduje się w położeniu ON. Przewód zasilający jest głównym odłącznikiem zasilania dla wszystkich rodzajów urządzeń.



Wymiana baterii

Stosuj tylko zalecane baterie. Muszą one spełniać wymagania najnowszej wersji IEC 65/VDE 0860. Zamienniki mogą uszkodzić urządzenie lub spowodować pożar czy porażenie prądem.

TABLE OF CONTENTS

1 PRODUCT DESCRIPTION	8
1.1 Models	8
1.2 Features.....	8
2 UNPACKING	8
2.1 Package Contents	8
3 SYSTEM OVERVIEW	8
4 ADIM CONNECTIONS AND CONFIGURATION	10
4.1 DVR Configuration (See DVR manual)	10
4.2 IntuiKey Keyboard and Serial Hub Connections	10
4.3 ADIM PC is pre-configured as follows	10
4.4 Primary DVR Connections.....	10
4.5 Backup DVR and Review Monitor Connections (Optional)	10
4.6 Network Connections.....	11
4.7 ADIM PC Connections	11
4.8 The PC is pre-configured with the following network parameters	11
4.9 Setting up ADIM PC Connections.....	11
4.10 Allegiant Connections	11
5 ADIM CONFIGURATION	12
5.1 Logging ON and User Levels	12
6 OPERATION	13
6.1 DVR Configuration Page	13
6.2 Other Configuration.....	14
6.2.1 <i>Allegiant Status Message Monitors</i>	14
6.2.2 <i>Auto-Login</i>	14
6.2.3 <i>Keyboard / Com Port Assignment</i>	14
6.3 Status and Monitoring Page	15
6.4 Allegiant Camera Title Transfer Dialog.....	16
7 ADIM KEYBOARD OPERATION	17
7.1 Product Menu.....	17
7.2 Allegiant Main Menu	17
7.3 ADIM Controls Menu	17
7.4 Joystick Operation	17
7.5 Numeric Keypad Buttons	17
7.6 Softkey Buttons	17
7.7 Keyboard Error Handling	17
7.8 Clearing ADIM Alarms	17
8 TROUBLESHOOTING	18
APPENDIX A – EVENT LOGS	19
APPENDIX B – TECHNICAL SPECS	22
APPENDIX C – RECOMMENDED NETWORK SWITCHES	23
APPENDIX D – LIST OF COMPATIBLE DVRS	23
APPENDIX E – PRIMARY, BACK-UP AND REVIEW DVRS	23

I PRODUCT DESCRIPTION

ADIM™ is a powerful security and surveillance solution that combines the power and features of the Philips Allegiant matrix switcher with the speed and quality of digital video recording. This tightly integrated solution uses the IntuiKey keyboard to control all cameras, monitors and digital video recorders. With the push of a button, the DVR will playback video from the current camera and display it on the specified CCTV monitor. The joystick can be used to fast forward, fast reverse and navigate the menu within the DVR.

1.1 Models

ADM0101 (see package contents below)

1.2 Features

- IntuiKey Keyboard interface for all Camera, Allegiant® and DVR functions
- One-button transition from Live to recorded video—on the specified analog monitor
- Synchronization of DVR and Allegiant clocks
- Status monitoring and event logging
- Automatic switchover to backup DVRs
- Monitor review; playback all video that was directed to specified review monitors

2 UNPACKING

Unpack carefully to prevent damage to the equipment.

2.1 Package Contents

Item	Qty	Part Number
ADIM PC (keyboard, mouse, monitor, power cord, Windows NT®, ADIM and system software, rack mounting hardware)	1	3033743001
Software Key	1	3031874021002
Master Control software	1	30336800100
Serial Hub	1	ACCSH01
Ethernet Cable	2	3032779001
Console Cable, 10-foot	1	LTC 8506/00
Null Modem Cable, 15-foot	1	ACCNM015
Instruction Manual (this manual)	1	393589042712*
Master Control Software for Windows Manual	1	393589012413



3 SYSTEM OVERVIEW

ADIM is an integration solution for the IntuiKey Keyboard, Allegiant Matrix Switcher and selected Philips DVRs.

Components of an ADIM system:

- Allegiant matrix switcher
- Hi-Qs (Revision 1.10 or higher)
- Disk Arrays (optional)
- ADIM PC
- Serial Hub(s)
- Universal IntuiKey Keyboard(s) – (Rev 1.10 or higher)
- Network Switch(es) – (See Appendix C for recommended network switches.)

NOTE: For your convenience, the Hi-Q Management Utility and the IntuiKey Keyboard's Installer program are pre-installed on the ADIM PC.

* Revision of this Instruction Manual will increment as changes are made. Please visit www.Philipscsi.com for the most current version.

Typical System:

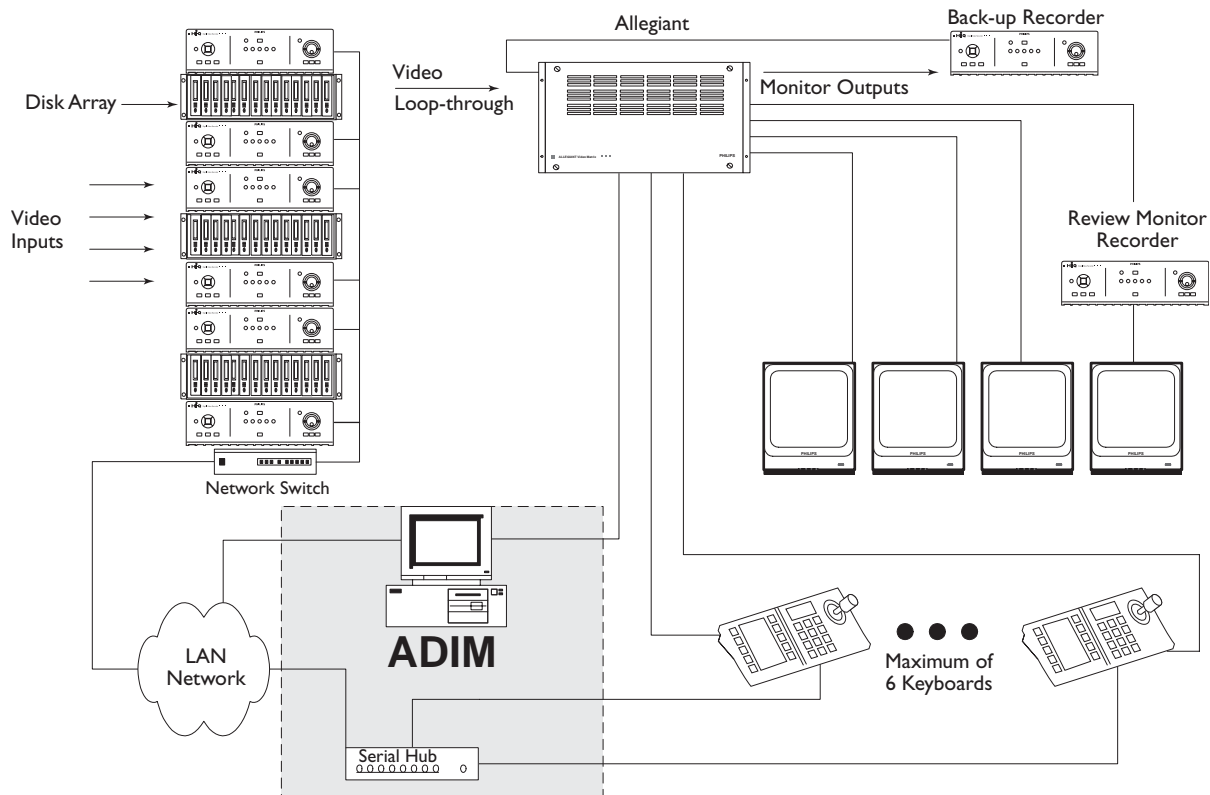

IMPORTANT NOTES:

- Disk Arrays are optional. (See specific DVR for Disk Array options.)
- Additional Serial Hubs may be used for remote keyboards.
- The ADIM system can handle a maximum of 6 keyboards; additional Keyboards may be connected to the Allegiant for live monitoring and camera control.
- ADIM can only be used with compatible Philips DVRs. (See Appendix D.)
- Only one user at a time can access a particular DVR. To avoid situations where high priority cameras are not accessible for playback, avoid placing more than one high priority camera on each DVR.
- The ADIM supports only one Allegiant system. The Allegiant may be a master in a satellite configuration, with DVRs at both master and satellite sites.
- Ensure the Allegiant has sufficient inputs for all cameras, DVR MON A outputs and optional Backup DVR MON A outputs.
- Ensure the Allegiant has sufficient outputs for all Backup DVR inputs.
- This system is designed to operate on its own closed network.
- The ADIM PC does not take the place of the 8900 Series PC. An LTC 8900 Allegiant System will still require its LTC 8943/92 PC.
- The DVRs can be configured as Review Monitors, providing playback capability only for cameras that were directed to the specific monitors.

4 ADIM CONNECTIONS AND CONFIGURATION

NOTE: The installer should be familiar with the Allegiant CCTV control system and Windows-based software, and have a general knowledge of networking.

4.1 DVR Configuration (See DVR manual)

Configure each DVR with a unique IP address

- Ensure valid IP addresses are configured
- Set the DVRs recording parameters
- Ensure the Hi-Q's password is set to **1234** (this is the default password)

4.2 IntuiKey Keyboard and Serial Hub Connections

- Connect each IntuiKey Keyboard to the Allegiant via an RS-485 cable (not supplied).
- Connect each IntuiKey Keyboard to the Serial Hub via a null modem cable (a 15-foot cable is supplied).
- Connect the serial hub to the network via an ethernet cable (2 are supplied).

IMPORTANT:

- The serial hub must be on the same network segment as the ADIM PC.
- If the distance from your Keyboard to the Serial Hub exceeds RS-232 limitations (50 feet), use a modem or additional Serial Hub to extend the distance. (See Appendix B for the RS-232 pin out details.)

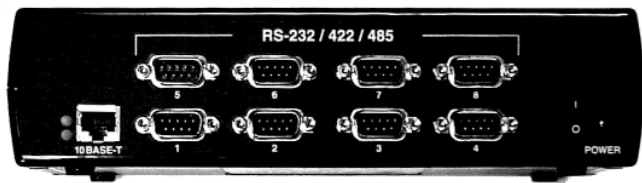

Rear View of the Serial Hub

4.3 ADIM PC is pre-configured as follows:

Serial Hub's Physical Port	PC COM Port
1	5
2	6
3	7
4	8
5	9
6	10
7	11*
8	12*

*Not Used; On the Serial Hub, keyboard cables can be connected to Ports 1 through 6, Ports 7 & 8 are not used.

IMPORTANT: Please make note of your connections (COM port configurations in Sections 4.4 & 4.5) for future reference.

4.4 Primary DVR Connections

- Connect the camera to the Primary DVR inputs and loop video to the Allegiant inputs.
- Connect the MON A output of the Primary DVRs to Allegiant inputs.

Figure 4.1 shows the relationship of the Primary DVR outputs and Allegiant inputs to the DVR Configuration page of the ADIM.

4.5 Backup DVR and Review Monitor Connections (Optional)

- Connect the Allegiant Monitor Outputs to the Backup or Review DVR video inputs.
- Connect the MON A output of the DVRs to an Allegiant input.

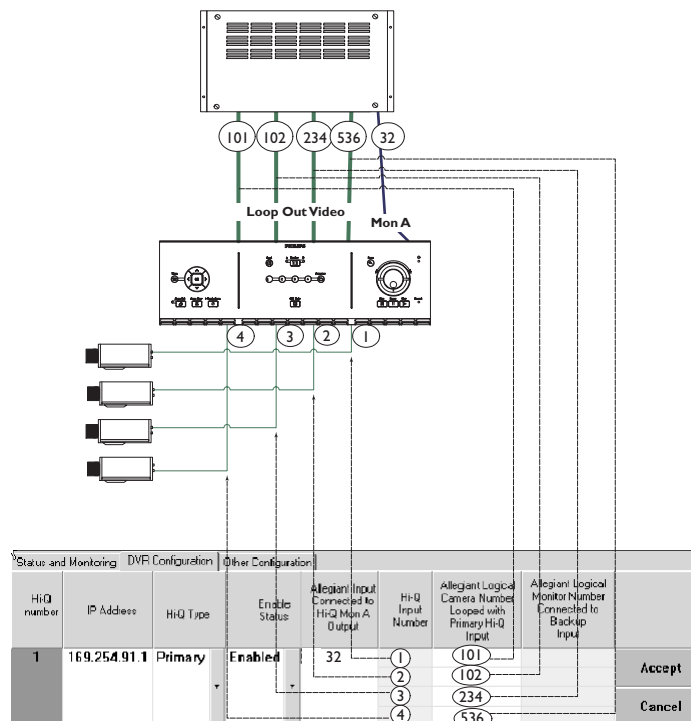

Figure 4.1

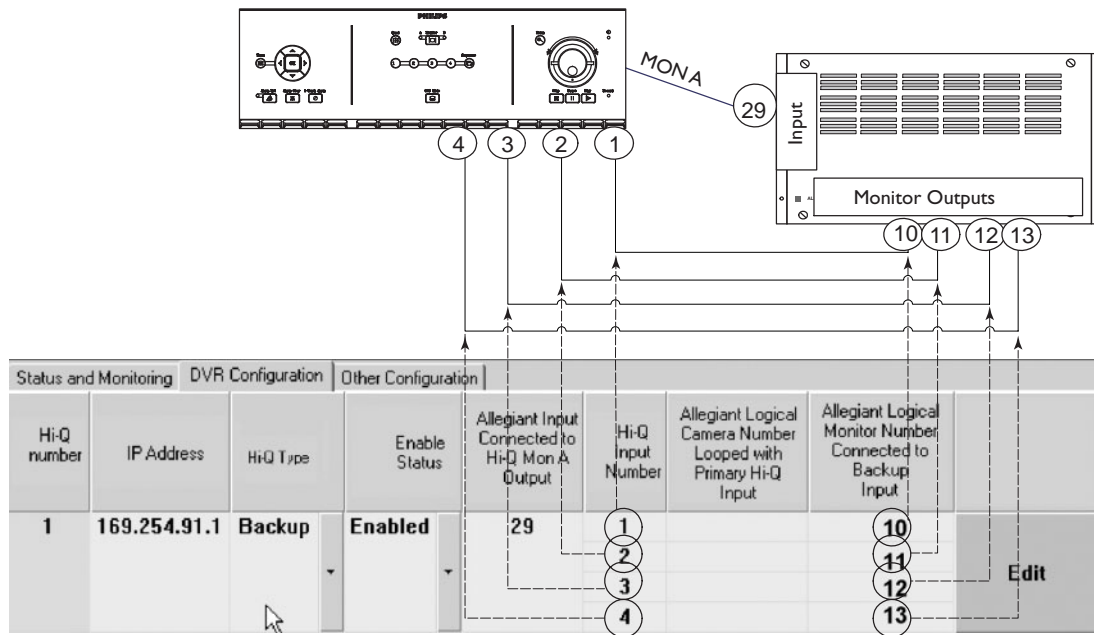

Figure 4.2

Figure 4.2 Shows the relationship of the Backup and Review DVRs and Allegiant outputs to the DVR Configuration page of the ADIM.

4.6 Network Connections

- Interconnect the Serial Hub(s), ADIM PC, DVRs and network switches.

NOTE: Connect the ADIM PC to the Network using the port labeled LAN – Connect to Primary IP address.

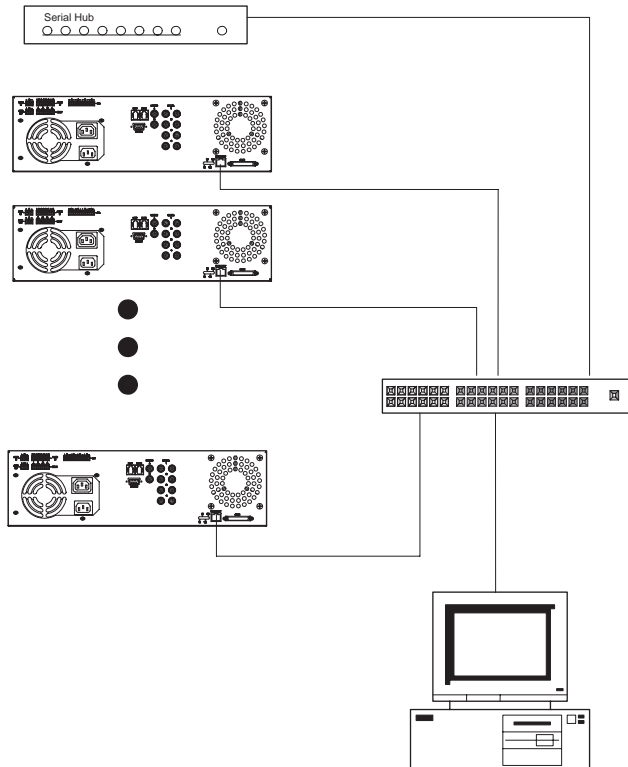

4.7 ADIM PC Connections

- Connect the Software Key to the parallel port of the PC.

4.8 The PC is pre-configured with the following network parameters

- IP address: 10.10.0.10
- Subnet mask: 255.255.255.0
- Default Gateway: 10.10.0.1

Philips recommends that your IT department perform all network and set up configuration.

NOTE: The PC is pre-configured to communicate with the Serial Hub that is shipped with ADIM. If a different Serial Hub is used with the system, the PC must be reconfigured. (Refer to the Serial Hub's instruction manual.)

NOTE: A printer or other device can be connected onto the security key, but the key may not function properly unless the device is turned on.

4.9 Setting up ADIM PC Connections

- Connect the keyboard and mouse "Y" adapter to the mouse/keyboard port on back of PC. Connect the mouse and the keyboard to the "Y" adapter.
- Connect the PC monitor to the port labeled "PC Monitor Connector". Plug the PC and Monitor power cords into the appropriate power sources, but do not turn on the power switches yet.
- Connect the ADIM PC to Allegiant Console Port.
 - Use the console cable to connect PC COM port number 1 to the Allegiant Console port.
 - Make sure that the ADIM PC is configured for the same network segment as the Hi-Q Recorders [10.10.0.0/255.255.255.0/10.10.0.1 (defaults)].
- Connect the ADIM PC to the Network Switch.
- Turn on the power switches to the PC and the monitor.

4.10 Allegiant Connections

- Connect the Allegiant to a PC COM Port 1 (recommended) using the supplied Console cable.

5 ADIM CONFIGURATION

The ADIM software is pre-loaded. No software installation is required.

 Open the ADIM Application by double clicking the ADIM icon on your desktop.

5.1 Logging ON and User Levels

- Log in with a user name and password.

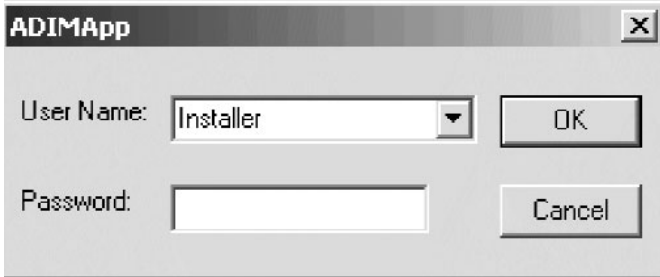

- If configuring the system, logon as a user with Installer or Administrator privileges. This grants access to all areas.

NOTE: The ADIM's user name and password are the same as the Master Control Software for Windows.

- User levels for ADIM and Master Control Software for Windows:

User Level	Default User Names	Default Passwords	Areas of Access
Installer	Installer	1	Status, Monitoring & Configuration
Administrator	Administrator	2	Status, Monitoring & Configuration
Operator	Operator	3	Status, Monitoring

NOTE: The PC is pre-configured to automatically log into Windows NT and start the ADIM application. ADIM can be configured to automatically log in, bypassing the log in dialog. This allows automatic start up of the ADIM application when the PC is restarted.

- Select or create an Allegiant Server document.

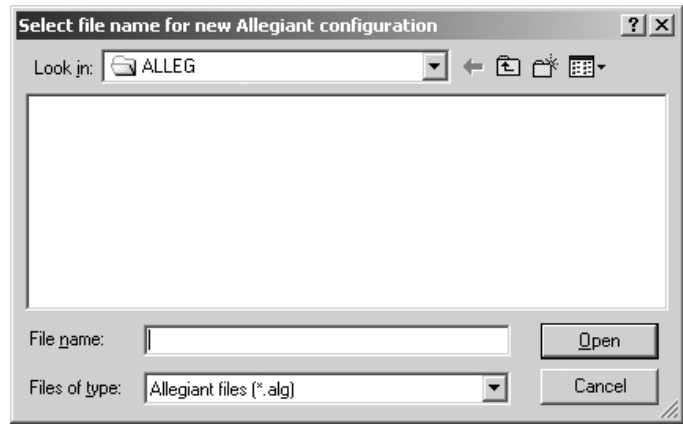

NOTE: ADIM will automatically open the last Allegiant document, therefore this screen may not be seen.

- If creating a new Allegiant document, select the type of Allegiant:

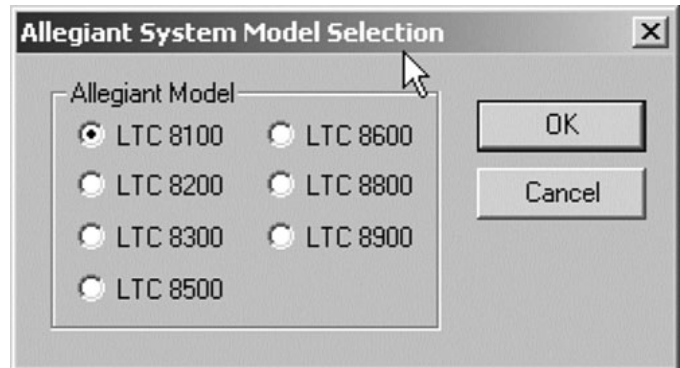

- The ADIM Status and Monitoring screen is displayed as shown in Figure 5.1.

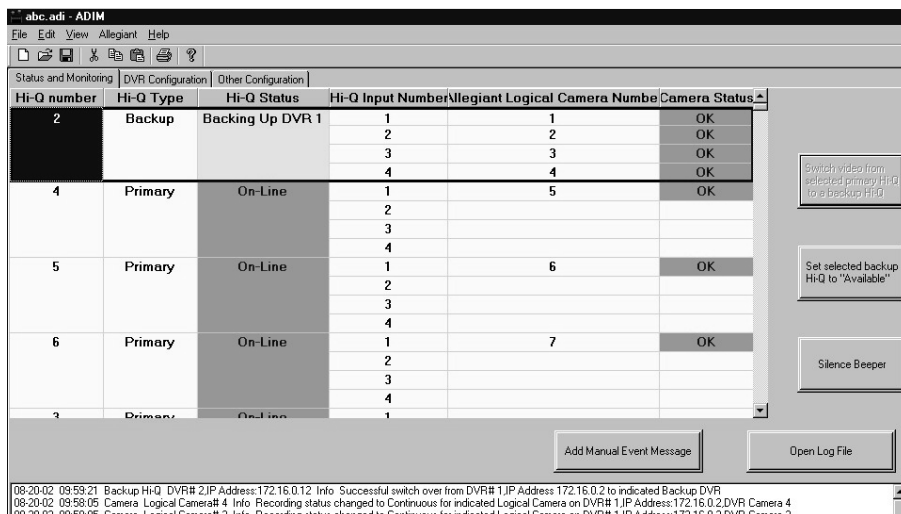
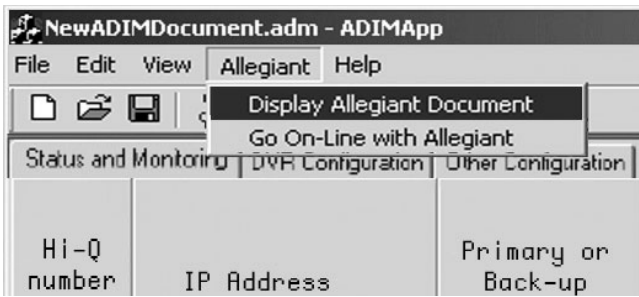
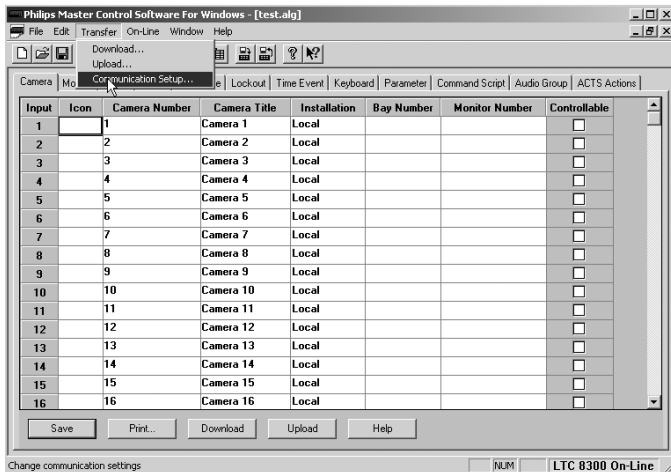

Figure 5.1

- If it is a new document, or if the Allegiant system is not on-line, select <Allegiant> <<Display Allegiant Document>>:



Allegiant Document:



- Using the instructions in the *Master Control Software For Windows*, configure the communication parameters <<Transfer>> <<<Communication Setup>>>:



Set the communication parameters for the Allegiant and press Go Online.

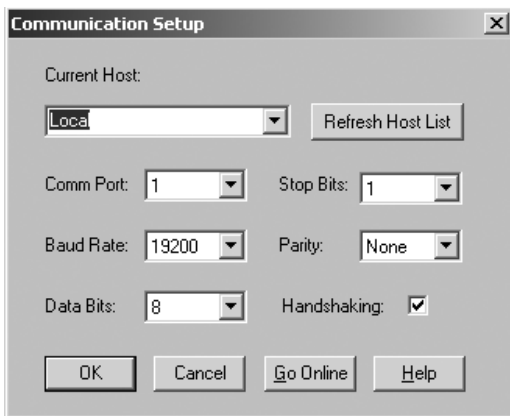

NOTE: The green **Allegiant On-line** (in the lower right corner) indicates ADIM is properly communicating with the Allegiant. It may take up to 20 seconds for communication to be established.

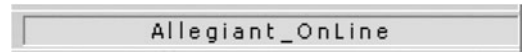

- Go to the **DVR Configuration** page to enter the values for each DVR. (See Section 6; Operation.)

6 OPERATION

Elements of the ADIM document window:



6.1 DVR Configuration Page

- To edit any fields, first select the **Edit** button assigned to the DVR #.
- After the row is filled in, select **Accept**.

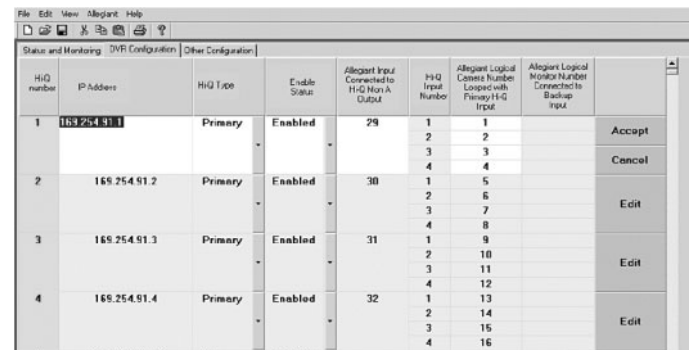

ITEM	Explained	Default
Hi-Q Number	Identifies 1 to 800 Hi-Qs (Not changeable)	Not applicable
IP address	Hi-Q IP address	000.000.000.000
Primary, Monitor Review or Backup	Determines how the Hi-Q is configured into the system (Primary, Backup, Review)	Primary
Enabled Status	Used to bring a Hi-Q online	Disabled
Allegiant Input connected to Hi-Q MON A output	Must be a valid logical camera number within the Allegiant document	Blank
Hi-Q (Hi-Q) input number	Physical inputs on the Hi-Q (Not changeable)	Not Applicable
Allegiant Logical Camera Number looped with primary Hi-Q input	The logical camera number within the Allegiant system that is assigned to the physical input of the Primary Hi-Q	Blank
Allegiant Logical monitor number connected to backup	The logical monitor output of the Allegiant that is assigned to the physical input of the backup Hi-Q	Blank

NOTE for Allegiant model LTC 8500:

- All Allegiants *EXCEPT* the LTC 8500 display the ADIM messages on a third line above or below the two status lines.
- The LTC 8500 does not have a third line for these messages, however, the messages can be set to overwrite the Monitor Title display. **To do this the monitors must be set to Monitor Title mode.**

6.2.2 Auto-Login



If the **Enable Automatic Login** checkbox is checked, upon start of the application, ADIM is automatically logged on with User Privileges.

6.2.3 Keyboard / Com Port Assignment

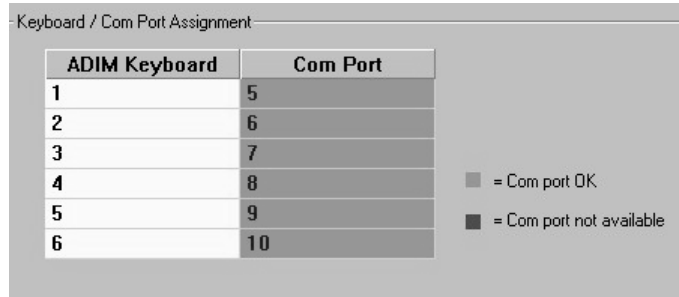

Example: Connect keyboard 1 into physical port 1 on back of the serial hub (preconfigured as COM5), etc.

6.2 Other Configuration

6.2.1 Allegiant Status Message Monitors

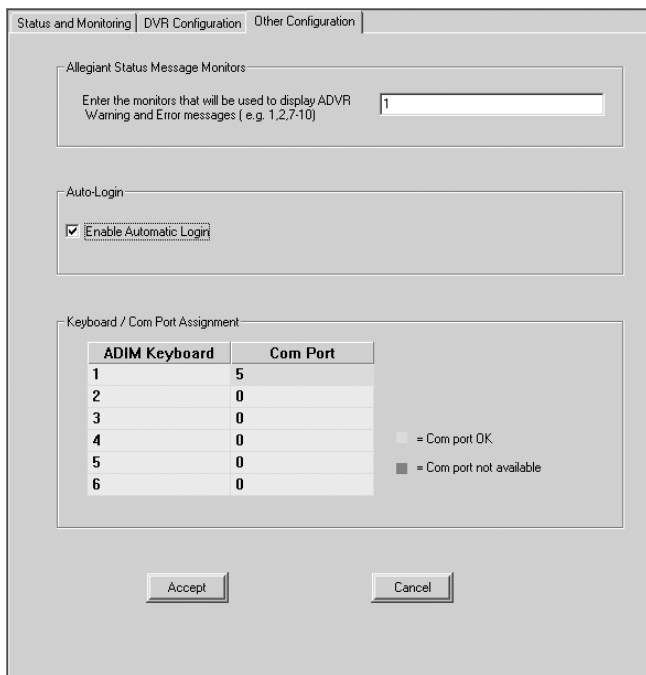

Table Heading	Explained	Field Values
ADIM Keyboard	Logical Keyboard Number	1 – 6
COM Port	Specify a com port for each keyboard	1 – 256 (See Section 4.3 for pre-configured values) <ul style="list-style-type: none"> • COM port OK (GREEN) • COM port not available (RED)

The **<Allegiant Status Message Monitors>** area is used to specify the Allegiant monitors that will display ADIM warning and error messages. Enter the monitor number(s) separated by commas (monitor ranges are specified with dashes). The monitor number(s) must exist in the Allegiant Monitor Table.

6.3 Status and Monitoring Page

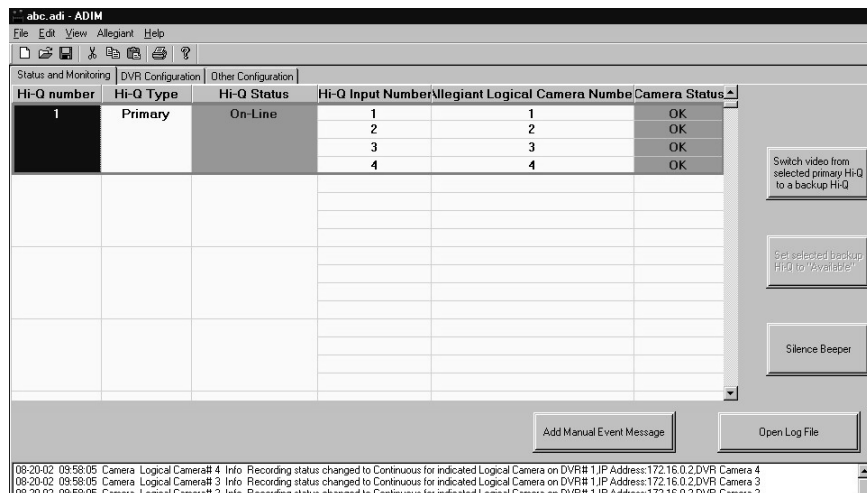

Table Element	Explained	Field Values
Hi-Q number	Fixed field depending on where the Hi-Q is entered into the table	1 - 800
Hi-Q Type	Determines configuration of the Hi-Q in the system	Primary, Backup, Review Monitor (See Appendix E for more details)
Hi-Q Status	Indicates operational status of a Hi-Q: On-Line and operational (Green); Off-Line (Red); Back-up unit that is currently backing up a primary Hi-Q (Yellow)	Primary: On-Line (Green), Off-Line (Red) Backup: Available (Green), Backing up a Primary Hi-Q (Yellow)
Hi-Q Input Number	Physical inputs on the Hi-Q.	1 through 4
Allegiant Logical Camera Number	If a Backup Hi-Q is Backing up a Primary Hi-Q, this field indicates the logical camera numbers that are being recorded by the backup Hi-Qs. For Primary Hi-Qs, this is simply the logical camera attached to the Hi-Q.	1 - 9,999
Camera Status	Field is gray when the associated Hi-Q is Off-Line, or if the Hi-Q is a Backup Hi-Q in the Available state.	OK (green) NO Sync (red)
BUTTON: Switch video from selected Primary Hi-Q to a Backup Hi-Q	This can be used to perform maintenance or repair on a Hi-Q without losing any recording. To manually switch cameras to backup Hi-Q, first select a Hi-Q, then press this button.	
BUTTON: Set Selected Backup Hi-Q to "Available"	Frees up a Backup DVR that's currently in use. This DVR can subsequently be used to backup another DVR. First, ensure that the primary Hi-Q is operating and On-Line, then select the Backup Hi-Q and press this button.	
BUTTON: Silence Beep	Silences the ADIM PC alarm (beep).	
BUTTON: Add Manual Event Message	Allows a user to manually add a message to the Event Log.	
ADIM Messages	Displays the most recent information, warning, and error events.	
BUTTON: Open Log File	The Open File dialog box is displayed. The log file names indicate the day. (See Figures 6.1a & 6.1b)	
Allegiant On-line	The lower right-hand corner of the screen indicates On/Off-Line status of the Allegiant.	Green = On-Line Red = Off-Line

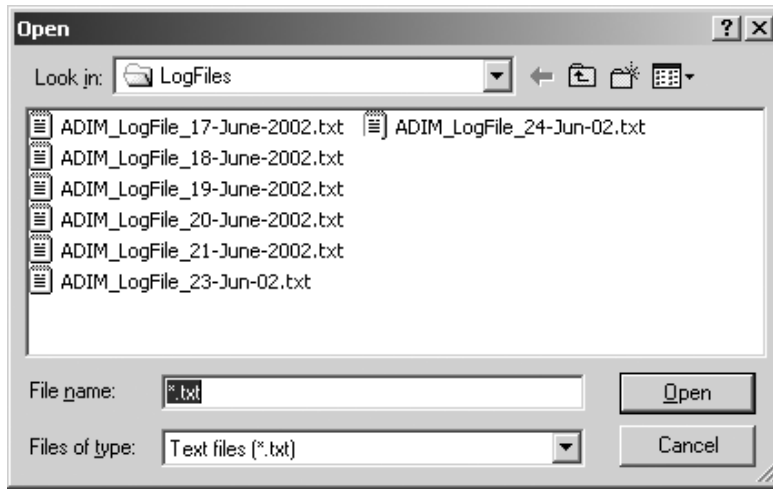

Figure 6.3a

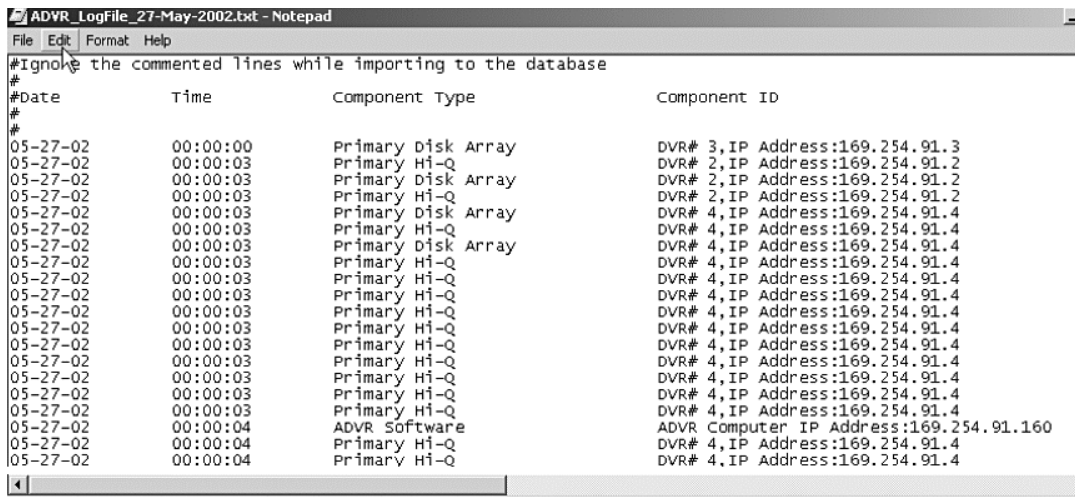

Figure 6.3b

NOTES:

- New Log files are created daily upon the occurrence of the first event after 12:00am. Otherwise, new entries are appended to the existing log file upon starting the application.
- Log files are easily manipulated into MS Excel or MS Access files for reporting. Use the **TAB-delimited** option to import into other databases.

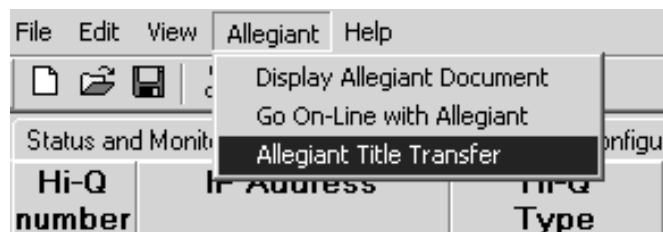

Figure 6.4a

6.4 Allegiant Camera Title Transfer Dialog

Camera titles configured for your *Allegiant* may be transferred to the DVRs. Titles may be transferred in their entirety, or specific cameras may be selected. To transfer titles, from the pull-down **FILE** menu, select *Allegiant* from the menu, then select *Allegiant Title Transfer*, as shown in Figures 6.4a and 6.4b.

NOTE: Allegiant camera titles must be downloaded to the Allegiant before they can be transferred to DVRs.

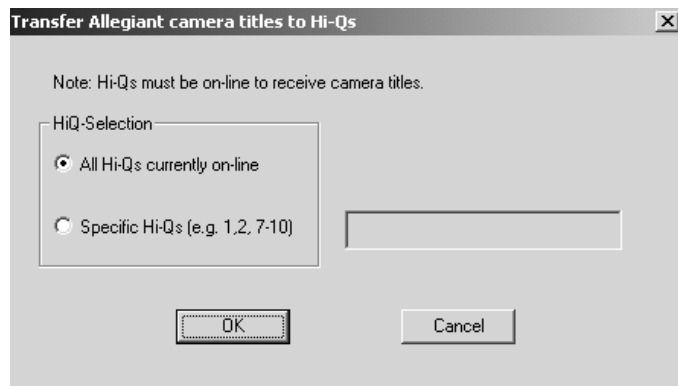

Figure 6.4b

7 ADIM KEYBOARD OPERATION

7.1 Product Menu

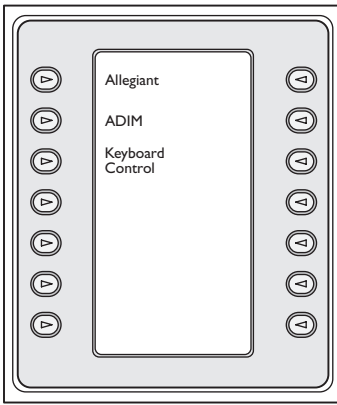

Figure 7.1

To ensure that the IntuiKey Keyboard is properly connected to the ADIM system, press the IntuiKey's **Product** key. The **ADIM On-Line** softkey option (see **Figure 7.1**) will only be displayed if the IntuiKey Keyboard is properly connected and configured, and the ADIM application is running.

Press the **ADIM On-Line** softkey to bring up the Allegiant main menu. The **ADIM Controls** softkey is now displayed.

NOTE: If ADIM is offline, the **ADIM Controls** softkey will not appear (will be blank on the IntuiKey Keyboard).

7.2 Allegiant Main Menu

Upon pressing the **ADIM Controls** softkey, the following occurs:

- If the selected camera is found and the DVR is mapped and available, pre-recorded video from the present camera is displayed on the selected CCTV monitor. (The default pre-recorded time is 1-minute.) In addition, the Keyboard displays the **ADIM Controls** menu (**Figure 7.3**).
- If the requested camera or monitor is not mapped to a DVR (within the ADIM), the error message, **Requested Device Not Found**, (along with an audible beep) is displayed on the Keyboard.
- If the camera is found, but the DVR is in use by another operator, the error message, **DVR in Use**, (along with an audible beep) is displayed on the Keyboard.

Refer to Appendix E for more information.

7.3 ADIM Controls Menu

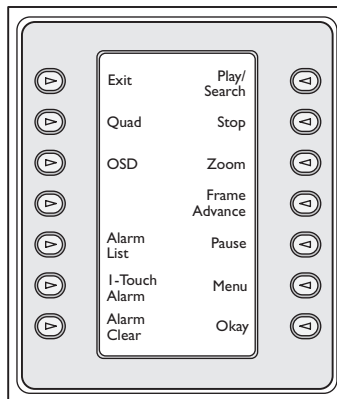
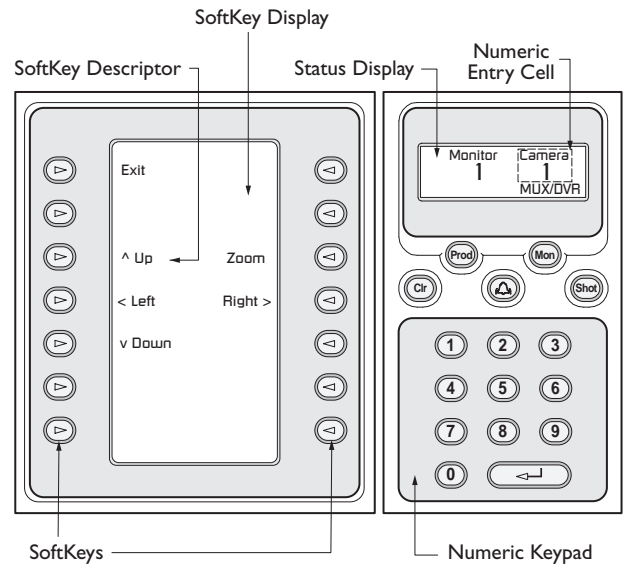

Figure 7.3

The **ADIM Controls** menu is used to control the Hi-Q (DVRRT4, DVRRT4EP) from the IntuiKey Keyboard.



IntuiKey Components

7.4 Joystick Operation

When in **ADIM Controls** mode, the IntuiKey Joystick can be used for the following actions:

- Navigation of the Menu Screen of the DVRs (UP, DOWN, LEFT, RIGHT).
- Proportional Playback Speed (clockwise rotation for fast forward; counterclockwise rotation for fast reverse).

7.5 Numeric Keypad Buttons

When in **ADIM Controls** mode, the IntuiKey Keypad buttons perform the following functions:

- **Enter** corresponds to the Hi-Q's front panel **OK** or **Select** button.
- The 1, 2, 3, and 4 keypad buttons on the keyboard emulate the Hi-Q's front panel buttons.

7.6 Softkey Buttons

When in **ADIM Controls** mode, the IntuiKey softkeys perform the appropriate action for the specific DVR.

The **Exit** button performs the following actions:

- Returns the DVR to the system (makes available for other users).
- Returns the keyboard to its previous menu.
- Returns the Live camera view (direct from the Allegiant) to the present monitor.

NOTE: Details regarding the functions of the other buttons may be found in the IntuiKey Keyboard and Philips DVR Instruction Manuals.

7.7 Keyboard Error Handling

If the IntuiKey keyboard fails to communicate with the system, an error message, **ADIM Communication Error** (along with an audible beep) displays on the keyboard.

7.8 Clearing ADIM Alarms

ADIM messages (see **Appendix A**) will be displayed on the assigned CCTV monitors. Ensure the keyboard is **NOT** in the **ADIM Controls** menu. Use the IntuiKey Keyboard's **CLR** to clear **ADIM Alarm** messages.

8 TROUBLESHOOTING

Problem	Explanation / Resolution
Keyboards are not communicating with the ADIM Software	<ul style="list-style-type: none"> • Ensure that a null modem serial cable is connected between the IntuiKey keyboards and the serial hub. • Ensure that the appropriate communications port is properly configured for the serial hub. • Ensure that the serial hub is connected to the network switch with a straight-through Ethernet cable. • Ensure that the ADIM software computer is connected to the network switch with a straight-through Ethernet cable. <p>NOTE: If the COM port light is green (OK), this confirms the ADIM software successfully opened the COM port. (The COM port exists and is not in use by another application.)</p>
Pressing ADIM Controls on the IntuiKey results in the Allegiant monitor displaying the output of the Hi-Q's MON A in Live mode instead of Playback mode. (No error messages are displayed on the Allegiant monitor.)	<ul style="list-style-type: none"> • Set the Hi-Q Recorder's password to 1234.
Keyboards display ADIM Off-line	<ul style="list-style-type: none"> • Ensure that the ADIM software is up and running in normal operations mode. • Verify that the RS-232 cable from the keyboard to the serial hub is connected properly. • The keyboard may go off-line and lose communication with ADIM if excessive conducted power disturbance is present on the system's serial and/or ethernet interfaces. To re-establish communication, first identify and remove the source of the disturbance, or protect the system's serial and/or ethernet interfaces from the disturbance, and then close and restart the ADIM PC software. • Verify that the serial hub and ADIM PC is on the same network segment.
Error Message 100 DVR in Use is displayed on the IntuiKey keyboard when DVR Control is pressed on the IntuiKey keyboard	<p>The ADIM system has found the DVR associated with the keyboard user's request, but another user is presently using the DVR.</p> <ul style="list-style-type: none"> • Wait for the DVR to be released by the other user.
Error Message 101 Requested Devices Not Found is displayed on the IntuiKey keyboard	<p>The user has requested playback from a device (either a camera or monitor) that could not be found in the ADIM mapping tables.</p> <ul style="list-style-type: none"> • Ensure that the ADIM mapping tables are correct. • Ensure that the DVR associated with the requested device is on-line. • Ensure that in the case of a camera not being found that the associated DVR is marked as a playback or backup DVR. • Ensure that in the case of a monitor not being found, the associated DVR is marked as a review DVR.
Error Message 102 ADIM Communication Error is displayed on the IntuiKey keyboard	<p>Communications have failed between the ADIM PC software and the IntuiKey keyboards.</p> <ul style="list-style-type: none"> • Verify that the ADIM software is still running. • Examine the Log file in the ADIM software to determine the reason for the communications failure. • Ensure that the keyboard is connected to the serial hub using a 9-pin null modem cable. • Ensure that the serial hub is turned on and functioning properly (consult the manual that came with serial hub). • Ensure that the keyboard is connected to the same serial port as defined in the ADIM software. • Ensure that the ADIM system has associated a valid serial port to the keyboard. • Ensure that the ADIM software and PC is running properly.
Error Message 103 ADIM General Error is displayed on the IntuiKey keyboard	<p>The ADIM software wishes to gain attention of the user due to detection of an error.</p> <ul style="list-style-type: none"> • Consult the ADIM software PC and associated log file.
Error Message 104 ADIM Mode Conflict Error is displayed on the IntuiKey keyboard	<p>The IntuiKey keyboard and ADIM software are not synchronized. No action is required; the keyboard and ADIM software will automatically synchronize.</p>

APPENDIX A – EVENT LOGS

Event	Monitor Message	Likely Source of Error Info	Log File			
			Component Type	Component ID	Entry Type	Log Message
Primary or Review Hi-Q Failure	DVR Error!	ADIM Software	Primary or Review Hi-Q	DVR #nnnn, IP Address: XXX.XXX.XXX.XXX	Error	DVR Failure
Primary or Review Hi-Q Disk Array Failure	DVR Error!	Hi-Q	Primary or Review Disk Array	DVR #nnnn, IP Address: XXX.XXX.XXX.XXX	Error	Disk Array Failure
Backup Hi-Q Failure	BU DVR Error	ADIM Software	Backup Hi-Q	DVR #nnnn, IP Address: XXX.XXX.XXX.XXX	Error	Backup DVR Failure
Backup Hi-Q Disk Array Failure	BU DVR Error	Hi-Q	Backup Disk Array	DVR #nnnn, IP Address: XXX.XXX.XXX.XXX	Error	Disk Array Failure*
Hi-Q Disabled		Hi-Q	ADIM Software	DVR #nnnn, IP Address: XXX.XXX.XXX.XXX	Info	Indicated DVR disabled
Hi-Q Enabled		Hi-Q	ADIM Software	DVR #nnnn, IP Address: XXX.XXX.XXX.XXX	Info	Indicated DVR Enabled
Hi-Q On-line		ADIM Software	Hi-Q	DVR #nnnn, IP Address: XXX.XXX.XXX.XXX	Info	Indicated DVR on-line
Hi-Q Off-line		ADIM Software	Hi-Q	DVR #nnnn, IP Address: XXX.XXX.XXX.XXX	Info	Indicated DVR off-line
Log File Created		ADIM Software	ADIM Software	ADIM Computer, IP Address: XXX.XXX.XXX.XXX	Info	Log file created
Log File Opened for Append		ADIM Software	ADIM Software	ADIM Computer, IP Address: XXX.XXX.XXX.XXX	Info	Log file opened for append
PC Hard Disk Nearly Full	PC Disk Low	ADIM Software	ADIM Software	ADIM Computer, IP Address: XXX.XXX.XXX.XXX	Warning	Less than 500 Mbytes of free space remains on the PC hard disk – improper system operation may occur if the disk is allowed to fill up
ADIM Software Started		ADIM Software	ADIM Software	ADIM Computer, IP Address: XXX.XXX.XXX.XXX	Info	ADIM Software started
Manual Event		ADIM Software	User	User Name, User Number: XX	Info	User specified.
Hi-Q Hi-Temp Warning	DVR Hi Temp	Hi-Q	Hi-Q	DVR #nnnn, IP Address: XXX.XXX.XXX.XXX	Warning	Over-temperature warning received from indicated Hi-Q
Hi-Q Lo-Temp Warning	DVR Lo Temp	Hi-Q	Hi-Q	DVR #nnnn, IP Address: XXX.XXX.XXX.XXX	Warning	Under-temperature warning received from indicated Hi-Q
Hi-Q Low Battery Warning	DVR Battery	Hi-Q	Hi-Q	DVR #nnnn, IP Address: XXX.XXX.XXX.XXX	Warning	Low battery warning received from indicated Hi-Q
Disk Array Degraded	Disk Array!	Hi-Q	Disk Array	DVR #nnnn, IP Address: XXX.XXX.XXX.XXX	Warning	Disk Array disk failure detected – disk array operating in degraded mode*

APPENDIX A – EVENT LOGS (...continued)

Event	Monitor Message	Likely Source of Error Info	Log File			
			Component Type	Component ID	Entry Type	Log Message
Allegiant On-Line		ADIM Software	Allegiant	Allegiant	Info	Allegiant went On-Line
Allegiant Off-Line		ADIM Software	Allegiant	Allegiant	Info	Allegiant went Off-Line
Hi-Q Low Power Supply Voltage	DVR Voltage	Hi-Q	Hi-Q	DVR #nnnn, IP Address: XXX.XXX.XXX.XXX	Warning	Voltage out of spec warning received from indicated Hi-Q
Camera Dark Alarm	Dark CamXXXX	Hi-Q	Camera	Logical Camera #	Warning	Dark Alarm for indicated Logical Camera on DVR #nnnn, IP Address: XXX.XXX.XXX.XXX, DVR Camera X
Camera Failure (Video Loss Alarm)	Fail CamXXXX	Hi-Q	Camera	Logical Camera #	Error	Camera Sync Loss Alarm for indicated Logical Camera on DVR #nnnn, IP Address: XXX.XXX.XXX.XXX, DVR Camera X
Manual Alarm		Hi-Q	Hi-Q	Logical Camera #	Info	Manual Alarm for indicated Logical Camera on DVR #nnnn, IP Address: XXX.XXX.XXX.XXX, DVR Camera X
Auxiliary Alarm		Hi-Q	Camera	Logical Camera #	Info	Auxiliary Alarm for indicated Logical Camera on DVR #nnnn, IP Address: XXX.XXX.XXX.XXX, DVR Camera X
Keyboard Communication (consecutive bad checksums)	KBD Comms	ADIM Software	Keyboard	Keyboard n	Warning	Communication errors detected for indicated keyboard
Hi-Q Communication (consecutive bad checksums)		ADIM Software	Hi-Q	DVR #nnnn, IP Address: XXX.XXX.XXX.XXX	Info	Communication errors detected for indicated Hi-Q
Hi-Q Communication Lost (no Q-Ping Response)		ADIM Software	Hi-Q	DVR #nnnn, IP Address: XXX.XXX.XXX.XXX	Info	No response from indicated Hi-Q
DVR Disk Full		Hi-Q	Hi-Q	DVR #nnnn, IP Address: XXX.XXX.XXX.XXX	Info	Hi-Q internal disk full
Recording Status Change I		Hi-Q	Camera	Logical Camera #	Info	Recording status changed to Disabled for indicated Logical Camera on DVR #nnnn, IP Address: XXX.XXX.XXX.XXX, DVR Camera X

APPENDIX A – EVENT LOGS (...continued)

Event	Monitor Message	Likely Source of Error Info	Log File			
			Component Type	Component ID	Entry Type	Log Message
Recording Status Change 2		Hi-Q	Camera	Logical Camera #	Info	Recording status changed to Continuous for indicated Logical Camera on DVR #nnnn, IP Address: XXX.XXX.XXX.XXX, DVR Camera X
Recording Status Change 3		Hi-Q	Camera	Logical Camera #	Info	Recording status changed to Continuous with Audio for indicated Logical Camera on DVR #nnnn, IP Address: XXX.XXX.XXX.XXX, DVR Camera X
Recording Status Change 4		Hi-Q	Camera	Logical Camera #	Info	Recording status changed to Event Only for indicated Logical Camera on DVR #nnnn, IP Address: XXX.XXX.XXX.XXX, DVR Camera X
Recording Status Change 5		Hi-Q	Camera	Logical Camera #	Info	Recording stopped; Encoder problem for indicated Logical Camera on DVR #nnnn, IP Address: XXX.XXX.XXX.XXX, DVR Camera X
Hi-Q Timeout		ADIM Software	Hi-Q	DVR #nnnn, IP Address: XXX.XXX.XXX.XXX	Info	Timeout -- Could not go On-Line with indicated Hi-Q
Hi-Q Delayed-OK		ADIM Software	Hi-Q	DVR #nnnn, IP Address: XXX.XXX.XXX.XXX	Info	Timeout -- Could not go On-Line with indicated Hi-Q
Disk Array Not Found	Disk Array!	ADIM Software	Disk Array	DVR #nnnn, IP Address: XXX.XXX.XXX.XXX	Warning	Disk Array not detected
Hi-Q DVR Switchover	Backup OK	ADIM Software	Backup Hi-Q	DVR #nnnn, IP Address (of Backup DVR): XXX.XXX.XXX.XXX	Info	Successful switchover from DVR nnnn, IP Address XXX.XXX.XXX.XXX to indicated Backup DVR
Hi-Q DVR Switchover Warning	Backup OK	ADIM Software	Backup Hi-Q	DVR #nnnn, IP Address (of Primary DVR): XXX.XXX.XXX.XXX	Warning	Warning message to generate monitor message to inform operator of switchover.
Hi-Q DVR No Backup Warning	No Backup!	ADIM Software	Primary Hi-Q	DVR #nnnn, IP Address: XXX.XXX.XXX.XXX	Warning	No backup DVR was available to backup failed DVR
Hi-Q Backup DVR made available		ADIM Software	Backup Hi-Q	DVR #nnnn, IP Address (of Backup DVR): XXX.XXX.XXX.XXX	Info	The backup DVR is set available from backing up state of DVR nnnn, IP Address (Primary DVR) XXX.XXX.XXX.XXX
Manual Backup Switchover Selected		ADIM Software	ADIM Software	ADIM Computer, IP Address: XXX.XXX.XXX.XXX	Info	Manual Switchover from DVR nnnn, IP Address XXX.XXX.XXX.XXX was selected

nnnn = logical DVR number, no leading zeros

APPENDIX B – TECHNICAL SPECS

ADIM Components (included):

Industrial PC: Rack-mount industrial-grade Pentium® PC, 120 MB RAM (minimum), 8 GB hard drive (minimum),
CD-ROM drive, floppy drive, keyboard, mouse, 10/100BaseT- compatible (RJ-45), keyboard/mouse rack-mount shelf, and Windows NT® 120/220 VAC, 50/60 Hz.

Monitor: 14-inch SVGA (including rack-mount hardware) 120/220, VAC, 50/60 Hz

LTC 8506/00: (1) 10-foot Console Cable

Ethernet Cable: (2) 25-foot Cables

ACCNM015: (1) RS-232 Null Modem Cable, 15-foot

ACCSH01: (1) Ethernet Serial Hub
RocketPort Serial Hub 8-Port
Operating Temperature: 0 to 40°C
Voltage: 100 - 240 Volts AC, 50 - 60 Hertz
Dimensions: 6" x 9" x 2.5"
(152 mm x 229 mm x 63.5 mm)
Weight: 2 lbs., 5 oz., (.90 KG) including power supply
Host Interface: Ethernet 10Base-T (10 Mbps), RJ-45
Network Addressing Supported:
MAC (Media Access Control)
IP (Internet Protocol)
Agency Approvals: FCC Part 15 Class A
UL/C-UL Listed CE Mark
Interface: Eight (8); DB9 Male, RS-232, RS-422 or RS-485 (selectable)

Wiring diagram for the Serial Port's RS-232 connections

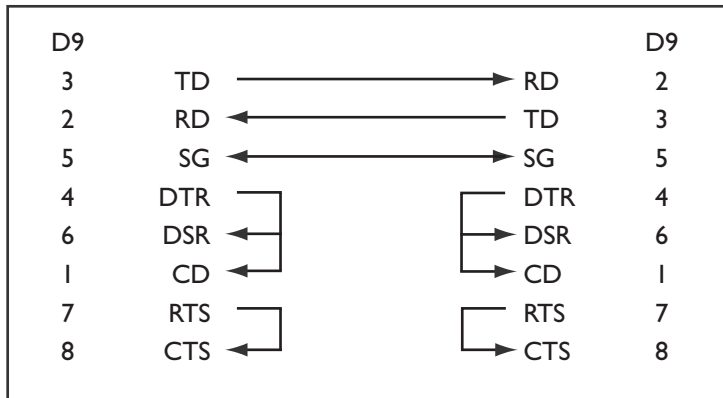

Figure I: Null Modem Wiring Diagram

APPENDIX C – RECOMMENDED NETWORK SWITCHES

Approved and tested network switches for use with ADIM.

- 3Com SuperStack 4300 model

APPENDIX D – LIST OF COMPATIBLE DVRs

- Hi-Q Series (DVRRT4, DVRRT4EP)

APPENDIX E – PRIMARY, BACKUP, AND REVIEW DVRs

Primary:

DVRs on the input of the Allegiant

Backup:

DVRs used on the output of the Allegiant. When ADIM determines a problem with a Primary DVR, the cameras designated for that Primary DVR are switched over to the Backup DVR for recording.

Review:

DVRs used on the output of the Allegiant. These DVRs are used to record all video from a switched output of the Allegiant. The Review DVRs are useful when reviewing an incident/suspect that involved multiple cameras being switched to a specified Monitor. It is also useful to review alarm / event video from the output of the Allegiant.

- Using the Keyboard to Playback Video from the Review DVR:

1. Select the Monitor you wish to review
2. Select camera number that corresponds to the Hi-Q's MON A output that is connected to the Allegiant Input. (In Figure below this would be camera number 29)

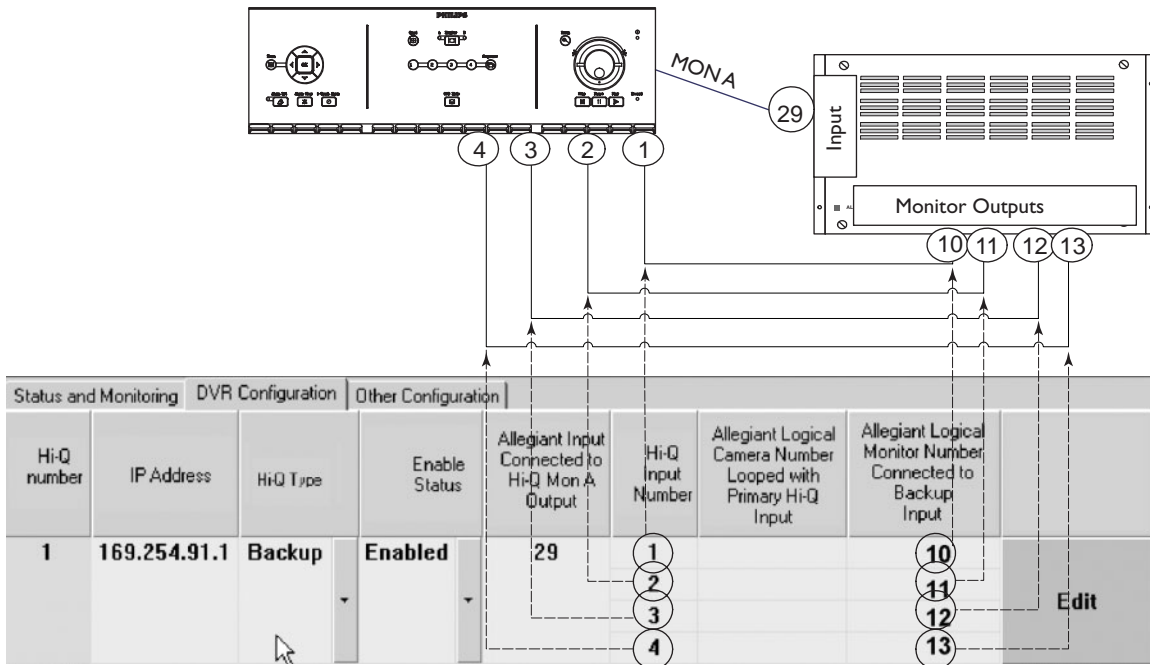

Windows® is a registered trademark of Microsoft Corporation.

3935 890 42712 02-39

© 2002 by Philips Electronics N.V.

© 2002 by Philips Communication, Security & Imaging, Inc.

All Rights Reserved. Philips® is a registered trademark of Philips Electronics N. A. Corp.

Updated September 25, 2002. Data subject to change without notice.

Refer to www.philipscsi.com for latest information.