

MSI 645 Ultra

MICRO-STAR INTERNATIONAL

MS-6547 (v1.X) ATX Mainboard



Version 1.1
G52-MA00514

Manual Rev: 1.1
Release Date: Dec. 2001



FCC-B Radio Frequency Interference Statement

This equipment has been tested and found to comply with the limits for a class B digital device, pursuant to part 15 of the FCC rules. These limits are designed to provide reasonable protection against harmful interference when the equipment is operated in a commercial environment. This equipment generates, uses and can radiate radio frequency energy and, if not installed and used in accordance with the instruction manual, may cause harmful interference to radio communications. Operation of this equipment in a residential area is likely to cause harmful interference, in which case the user will be required to correct the interference at his own expense.

Notice 1

The changes or modifications not expressly approved by the party responsible for compliance could void the user's authority to operate the equipment.

Notice 2

Shielded interface cables and A.C. power cord, if any, must be used in order to comply with the emission limits.

VOIR LA NOTICE D'INSTALLATION AVANT DE RACCORDER AU RESEAU.

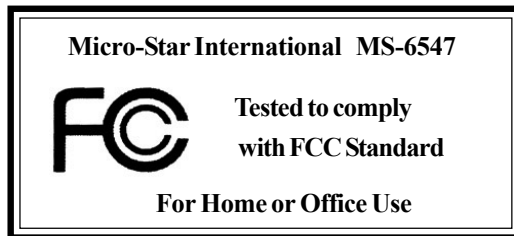

Edition

Dec. 2001

Copyright Notice

The material in this document is the intellectual property of **MICRO-STAR INTERNATIONAL**. We take every care in the preparation of this document, but no guarantee is given as to the correctness of its contents. Our products are under continual improvement and we reserve the right to make changes without notice.

Trademarks

All trademarks used in this manual are the property of their respective owners.

Intel and Pentium are registered trademarks of Intel Corporation.

PS/2 and OS/2 are registered trademarks of IBM Corporation.

Windows 95 and Windows NT are registered trademarks of Microsoft.

Netware is a registered trademark of Novell.

Award is a registered trademark of Award Software Inc.

Revision History

Revision	Revision History	Date
V1.1	First release	Dec. 2001

Safety Instructions

1. Always read the safety instructions carefully.
2. Keep this User's Manual for future reference.
3. Keep this equipment away from humidity.
4. Lay this equipment on a reliable flat surface before setting it up.
5. The openings on the enclosure are for air convection hence protects the equipment from overheating. **DO NOT COVER THE OPENINGS.**
6. Make sure the voltage of the power source and adjust properly 110/220V before connecting the equipment to the power inlet.
7. Place the power cord such a way that people can not step on it. Do not place anything over the power cord.
8. Always Unplug the Power Cord before inserting any add-on card or module.
9. All cautions and warnings on the equipment should be noted.
10. Never pour any liquid into the opening that could damage or cause electrical shock.
11. If any of the following situations arises, get the equipment checked by a service personnel:
 - The power cord or plug is damaged
 - Liquid has penetrated into the equipment
 - The equipment has been exposed to moisture
 - The equipment has not work well or you can not get it work according to User's Manual.
 - The equipment has dropped and damaged
 - If the equipment has obvious sign of breakage
12. **DO NOT LEAVE THIS EQUIPMENT IN AN ENVIRONMENT UNCONDITIONED, STORAGE TEMPERATURE ABOVE 60°C (140°F), IT MAY DAMAGE THE EQUIPMENT.**



CAUTION: Danger of explosion if battery is incorrectly replaced. Replace only with the same or equivalent type recommended by the manufacturer.

CONTENTS

Chapter 1. Getting Started	1-1
Mainboard Specification	1-2
Mainboard Layout	1-4
Quick Components Guide	1-5
Chapter 2. Hardware Setup	2-1
Central Processing Unit: CPU	2-2
CPU Installation Procedures	2-2
Installing the CPU Fan	2-3
CPU Core Speed Derivation Procedure	2-4
Memory	2-5
Introduction to DDR SDRAM	2-5
DDR Module Combination	2-6
Installing DDR Modules	2-6
Power Supply	2-7
ATX 20-Pin Power Connector: JWR1	2-7
ATX 12V Power Connector: JPW1	2-7
Back Panel	2-8
Mouse Connector: JKBMS1	2-8
Keyboard Connector: JKBMS1	2-9
USB Connectors	2-9
Serial Port Connector: COM A & COM B	2-10
Joystick/Midi Connectors	2-10
Audio Port Connectors	2-10
Parallel Port Connector: LPT1	2-11
Connectors	2-12
Floppy Disk Drive Connector: FDD1	2-12
Hard Disk Connectors: IDE1 & IDE2	2-13
CD-In Connector: JCD1	2-14
Aux Line-In Connector: JAUX1	2-14

Modem-In Connector: JMD1	2-14
Fan Power Connectors: CPUFA/SYSFA	2-15
Wake On Ring Connector: JMDM1	2-16
IrDA Infrared Module Header: JIR2	2-16
Front Panel Connector: JFP1 or JFP2	2-17
Front Panel Audio Connector: JP20	2-18
Front USB Connector: JUSB1 or JUSB3	2-19
Jumpers	2-20
Clear CMOS Jumper: JBAT1	2-20
Slots	2-21
AGP (Accelerated Graphics Port) Slot	2-21
PCI Slots	2-21
CNR (Communication Network Riser)	2-21
PCI Interrupt Request Routing	2-22
Chapter 3. BIOS Setup	3-1
Entering Setup	3-2
Control Keys	3-2
Getting Help	3-3
The Main Menu	3-4
Standard CMOS Features	3-6
Advanced BIOS Features	3-8
Advanced Chipset Features	3-12
Integrated Peripherals	3-14
Power Management Setup	3-19
PNP/PCI Configurations	3-23
PC Health Status	3-25
Frequency/Voltage Control	3-26
Load Fail-Safe/Optimized Defaults	3-28
Set Supervisor/User Password	3-29

Glossary G-1

Getting Started

1

Thank you for purchasing the 645 Ultra (MS-6547 v1.X) ATX mainboard. The 645 Ultra is a superior computer mainboard based on SiS645 & SiS961 chipsets for optimal system efficiency. Designed to fit the advanced Intel® Pentium® 4 processors in the 478 pin package, the 645 Ultra delivers a high performance and professional desktop platform solution.

TOPICS

<i>Mainboard Specification</i>	<i>1-2</i>
<i>Mainboard Layout</i>	<i>1-4</i>
<i>Quick Components Guide</i>	<i>1-5</i>
<i>MSI Special Features</i>	<i>1-6</i>

Mainboard Specification

CPU

- Supports Intel® Pentium® 4 processors in the 478 pin package.
- Supports 1.5GHz, 1.6GHz, 1.7GHz, 1.8GHz, 1.9GHz, 2GHz and up.

Chipset

- SiS®645 Open Architecture DDR333 Chipset
 - Supports DIMMs of DDR333/DDR266/DDR200 SDRAM up to 3GB maximum memory.
 - Supports 400MHz system bus with 2X address and 4X data rate.
 - Supports AGP 4X/2X interface with fast write transaction.
- SiS®961 MuTIOL® Media I/O Chipset
 - Bi-directional 16-bit data bus with 533MB bandwidth.
 - 2-channel Ultra ATA 100/66/33 Bus Master IDE controller.
 - Dual USB controllers (expanded capabilities for 6 ports).
 - Supports AC'97 V2.2 audio codec and modem codec.
 - ACPI 1.0b and APM 1.2 compliant.
 - LPC 1.0 interface.
 - PCI 2.2 interface.

Main Memory

- Supports six memory banks using three 184-pin DDR DIMM.
- Supports up to 3GB DDR333/DDR266/DDR200 SDRAM.
- Supports 2.5v DDR SDRAM.

Slots

- One AGP (Accelerated Graphics Port) 4x slot.
- Five PCI 2.2 32-bit PCI bus slots (support 3.3v/5v PCI bus interface).
- One CNR (Communication Network Riser) slot.

On-Board IDE

- An IDE controller on the SiS961 chipset provides IDE HDD/CD-ROM with PIO, Bus Master and Ultra DMA100/66/33 operation modes.
- Can connect up to four IDE devices.

On-Board Peripherals

- On-Board Peripherals include:
 - 1 floppy port supports 2 FDDs with 360K, 720K, 1.2M, 1.44M and

- 2.88Mbytes.
- 2 serial ports (COMA + COMB).
- 1 parallel port supports SPP/EPP/ECP mode.
- 4 USB ports (Rear * 2/ Front * 2).
- 1 IrDA connector for SIR.
- 1 audio/game port.

Audio

- S/W Realtek ALC201AAC'97 Codec.

BIOS

- The mainboard BIOS provides “Plug & Play” BIOS which detects the peripheral devices and expansion cards of the board automatically.
- The mainboard provides a Desktop Management Interface (DMI) function which records your mainboard specifications.

Dimension

- ATX Form Factor: 30.5cm(L) x 22.0cm(W).

Mounting

- 6 mounting holes.

Others

- Modem (Internal/External) Ring Wake Up Function.
- Suspend to RAM/Disk.
- Support PC2001.

Mainboard Layout

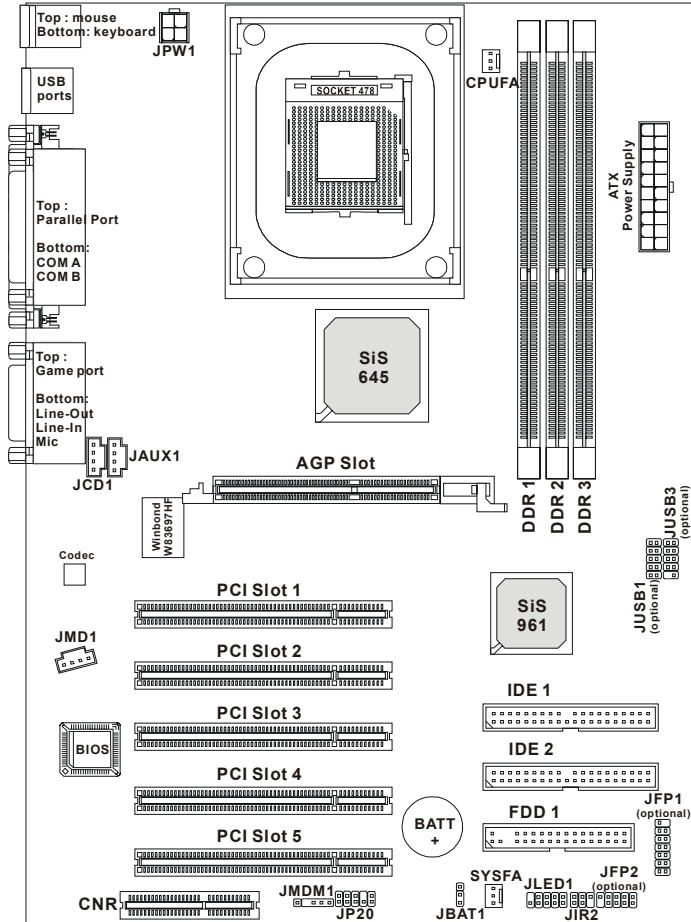

645 Ultra (MS-6547 v1.X) ATX Mainboard

Quick Components Guide

Component	Function	Reference
JWR1/JPW1	ATX power connectors	See p. 2-7
JKBMS1	Mouse/keyboard connector	See p. 2-8
USB Connectors	Connecting to USB devices	See p. 2-9
COM A & COM B	Serial port connector	See p. 2-10
LPT1	Parallel port connector	See p. 2-11
FDD1	Floppy disk drive connector	See p. 2-12
IDE1~ IDE2	Hard disk connectors	See p. 2-13
JCD1/JAUX1/JMD1	CD/AUX/Modem-in connectors	See p. 2-14
CPUFA/SYSFA	Fan power connectors	See p. 2-15
JMDM1	Wake on ring connector	See p. 2-16
JIR2	IrDA infrared module connector	See p. 2-16
JFP1/JFP2	Front panel connectors	See p. 2-17
JP20	Front panel audio connector	See p. 2-18
JUSB1/JUSB3	USB front connector	See p. 2-19
JBAT1	Clear CMOS jumper	See p. 2-20
AGP Slot	Connecting to AGP cards	See p. 2-21
PCI Slots	Connecting to expansion cards	See p. 2-21
CNR Slot	Connecting to expansion cards	See p. 2-21

Hardware Setup **2**

This chapter provides you with the information about hardware setup procedures. While doing the installation, be careful in holding the components and follow the installation procedures. For some components, if you install in the wrong orientation, the components will not work properly.

Use a grounded wrist strap before handling computer components. Static electricity may damage the components.

TOPICS

<i>Central Processing Unit: CPU</i>	2-2
<i>Memory Installation</i>	2-5
<i>Power Supply</i>	2-7
<i>Back Panel</i>	2-8
<i>Connectors</i>	2-12
<i>Jumpers</i>	2-20
<i>Slots</i>	2-21

Central Processing Unit: CPU

The mainboard supports Intel® Pentium® 4 processor in the 478 pin package. The mainboard uses a CPU socket called PGA478 for easy CPU installation. When you are installing the CPU, **make sure the CPU has a heat sink and a cooling fan attached on the top to prevent overheating.** If you do not find the heat sink and cooling fan, contact your dealer to purchase and install them before turning on the computer.

CPU Installation Procedures

1. Pull the lever sideways away from the socket. Then, raise the lever up to a 90-degree angle.
2. Look for the dot/cut edge. The dot/cut edge should point towards the lever pivot. The CPU will only fit in the correct orientation.
3. Hold the CPU down firmly, and then close the lever to complete the installation.

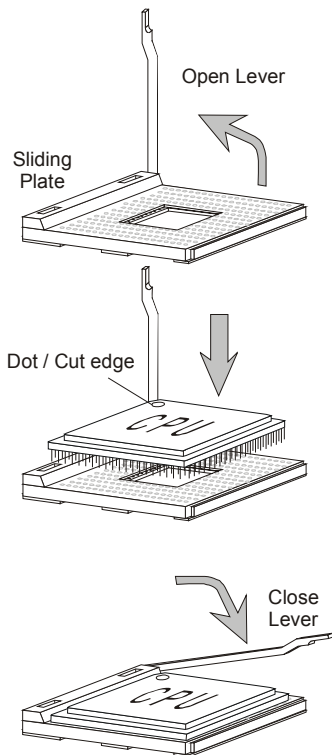

WARNING!

Overheating will seriously damage the CPU and system, always make sure the cooling fan can work properly to protect the CPU from overheating.

Installing the CPU Fan

As processor technology pushes to faster speeds and higher performance, thermal management becomes increasingly important. To dissipate heat, you need to attach the CPU cooling fan and heatsink on top of the CPU. Follow the instructions below to install the Heatsink/Fan:

1. Locate the CPU and its retention mechanism on the motherboard.
2. Position the heatsink onto the retention mechanism.

retention mechanism

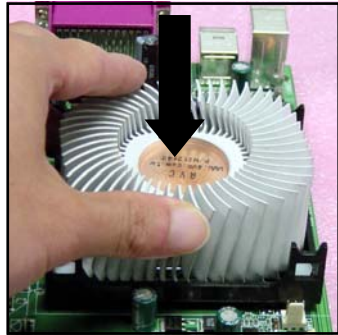
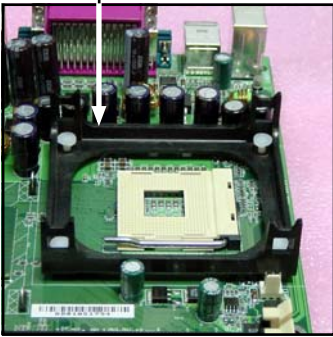

3. Mount the fan on top of the heatsink. Press down the fan until its four clips get wedged in the holes of the retention mechanism.
4. Press the two levers down to fasten the fan. Each lever can be pressed down in only ONE direction.

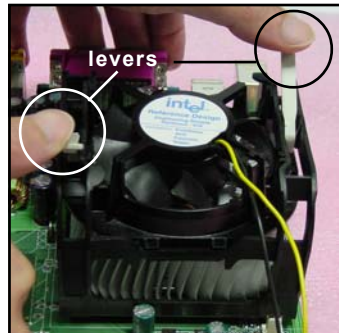
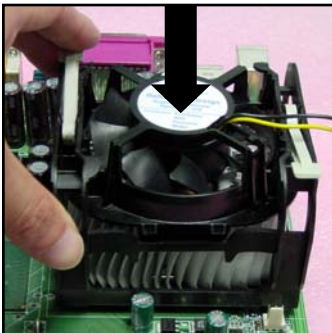

Chapter 2

5. Connect the fan power cable from the mounted fan to the 3-pin fan power connector on the board.

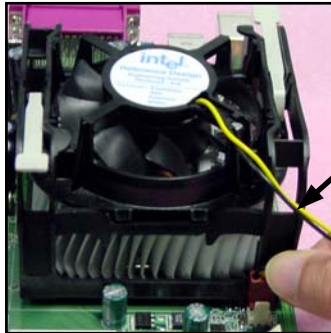

fan power cable

CPU Core Speed Derivation Procedure

If	CPU Clock	=	100MHz
	Core/Bus ratio	=	14
then	CPU core speed	=	Host Clock x Core/Bus ratio
		=	100MHz x 14
		=	1.4GHz



WARNING!

Overclocking

This motherboard is designed to support overclocking. However, please make sure your components are able to tolerate such abnormal setting, while doing overclocking. Any attempt to operate beyond product specifications is not recommended. We do not guarantee the damages or risks caused by inadequate operation or beyond product specifications.

Memory

The mainboard provides 3 slots for 184-pin, 2.5V DDR DIMM with 6 memory banks. You can install PC1600/PC2100 DDR SDRAM modules on the DDR DIMM slots (DDR 1~3). To operate properly, at least one DIMM module must be installed.

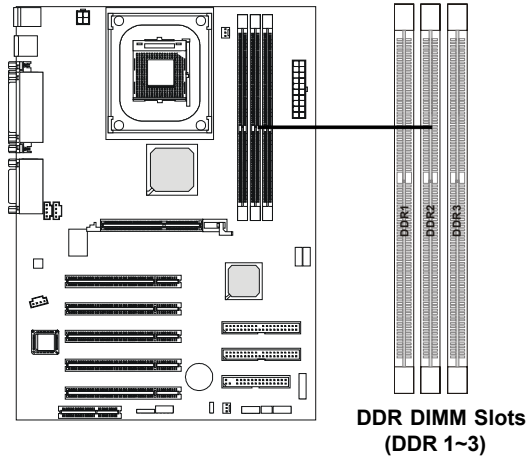

Introduction to DDR SDRAM

DDR (Double Data Rate) SDRAM is similar to conventional SDRAM, but doubles the rate by transferring data twice per cycle. It uses 2.5 volts as opposed to 3.3 volts used in SDR SDRAM, and requires 184-pin DIMM modules rather than 168-pin DIMM modules used by SDR SDRAM. Two types of DDR are available at the time of writing: PC1600 & PC2100. PC1600 DDR SDRAM running at 100MHz will produce about 1.6GB/s memory bandwidth. PC2100 running at 133MHz will produce 2.1GB/s memory bandwidth. High memory bandwidth makes DDR an ideal solution for high performance PC, workstations and servers.

DDR Module Combination

You can install either single sided or double sided 184-pin DDR DIMM modules into DDR DIMM slots to meet your needs. Different from the SDR DIMM, the DDR DIMM has only one notch on the center of module. The number of pins on either side of the breaks are different. The module will only fit in the right orientation.

You can install memory modules in any combination as follows:

Slot	Memory Module	Total Memory
Slot 1 (Bank 0 & Bank 1)	64 M B , 128 M B , 256 M B , 512 M B , 1 G B	64 M B ~ 1 G B
Slot 2 (Bank 2 & Bank 3)	64 M B , 128 M B , 256 M B , 512 M B , 1 G B	64 M B ~ 1 G B
Slot 3 (Bank 4 & Bank 5)	64 M B , 128 M B , 256 M B , 512 M B , 1 G B	64 M B ~ 1 G B
Maximum System Memory Supported		64 M B ~ 3 G B

Installing DDR Modules

1. The DDR DIMM module has only one notch on the center.

Front View

Rear View

2. Insert the DDR module vertically into the DDR DIMM slot. Make sure the notch is on the right orientation.

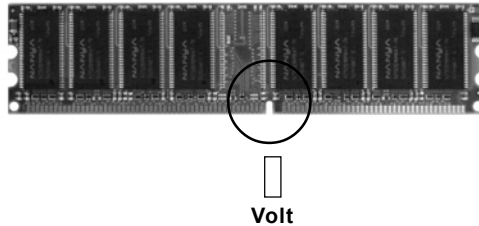

3. The plastic clips at sides of the DIMM slot will automatically close.

Power Supply

The mainboard supports ATX power supply for the power system. Before inserting the power supply connector, always make sure that all components are installed properly to ensure that no damage will be caused.

ATX 20-Pin Power Connector: JWR1

This connector allows you to connect to an ATX power supply. To connect to the ATX power supply, make sure the plugs of the power supply is inserted in the proper orientation and the pins are aligned. Then push down the power supply firmly into the connector. The power connector supports **instant power on** function which means that system will boot up immediately when the power supply connector is inserted on the board.

ATX 12V Power Connector: JPW1

This 12V power connector is used to provide power to the CPU.

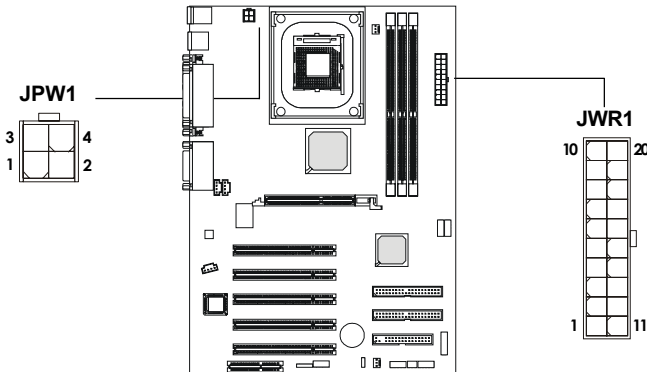

JWR1 Pin Definition

PIN	SIGNAL	PIN	SIGNAL
1	3.3V	11	3.3V
2	3.3V	12	-12V
3	GND	13	GND
4	5V	14	PS_ON
5	GND	15	GND
6	5V	16	GND
7	GND	17	GND
8	PW_OK	18	-5V
9	5V_SB	19	5V
10	12V	20	5V

JPW1 Pin Definition

PIN	SIGNAL
1	GND
2	GND
3	12V
4	12V

Back Panel

The Back Panel provides the following connectors:

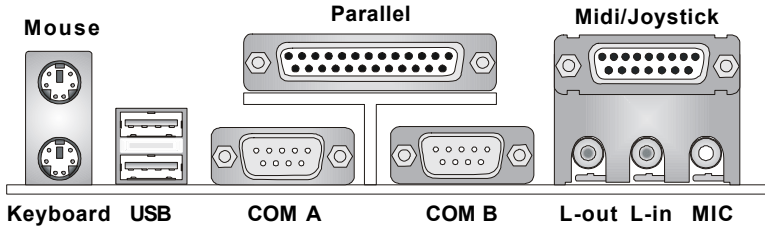

Mouse Connector: JKBMS1

The mainboard provides a standard PS/2[®] mouse mini DIN connector for attaching a PS/2[®] mouse. You can plug a PS/2[®] mouse directly into this connector. The connector location and pin assignments are as follows:

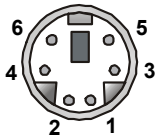

PS/2 Mouse (6-pin Female)

Pin Definition

PIN	SIGNAL	DESCRIPTION
1	Mouse DATA	Mouse DATA
2	NC	No connection
3	GND	Ground
4	VCC	+5V
5	Mouse Clock	Mouse clock
6	NC	No connection

Keyboard Connector: JKBMS1

The mainboard provides a standard PS/2[®] keyboard mini DIN connector for attaching a PS/2[®] keyboard. You can plug a PS/2[®] keyboard directly into this connector.

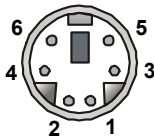

PS/2 Keyboard (6-pin Female)

Pin Definition

PIN	SIGNAL	DESCRIPTION
1	Keyboard DATA	Keyboard DATA
2	NC	No connection
3	GND	Ground
4	VCC	+5V
5	Keyboard Clock	Keyboard clock
6	NC	No connection

USB Connectors

The mainboard provides a UHCI (Universal Host Controller Interface) Universal Serial Bus root for attaching USB devices such as keyboard, mouse or other USB-compatible devices. You can plug the USB device directly into the connector.

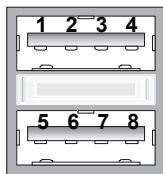

USB Ports

USB Port Description

PIN	SIGNAL	DESCRIPTION
1	VCC	+5V
2	-Data 0	Negative Data Channel 0
3	+Data0	Positive Data Channel 0
4	GND	Ground
5	VCC	+5V
6	-Data 1	Negative Data Channel 1
7	+Data 1	Positive Data Channel 1
8	GND	Ground

Serial Port Connector: COM A & COM B

The mainboard offers two 9-pin male DIN connectors for serial port COM A and COM B. The ports are 16550A high speed communication ports that send/receive 16 bytes FIFOs. You can attach a serial mouse or other serial devices directly to them.

Pin Definition		
PIN	SIGNAL	DESCRIPTION
1	DCD	Data Carry Detect
2	SIN	Serial In or Receive Data
3	SOUT	Serial Out or Transmit Data
4	DTR	Data Terminal Ready)
5	GND	Ground
6	DSR	Data Set Ready
7	RTS	Request To Send
8	CTS	Clear To Send
9	RI	Ring Indicate

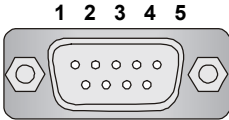

9-Pin Male DIN Connectors

Joystick/Midi Connectors

You can connect a joystick or game pad to this connector.

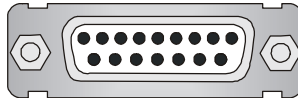

Audio Port Connectors

Line Out is a connector for Speakers or Headphones. **Line In** is used for external CD player, Tape player, or other audio devices. **Mic** is a connector for microphones.

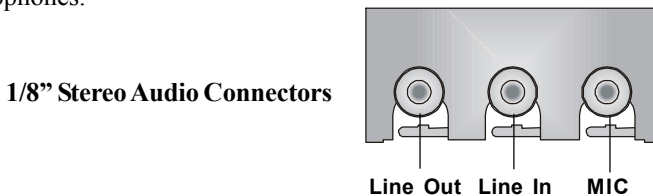

Parallel Port Connector: LPT1

The mainboard provides a 25-pin female centronic connector for LPT. A parallel port is a standard printer port that supports Enhanced Parallel Port (EPP) and Extended Capabilities Parallel Port (ECP) mode.

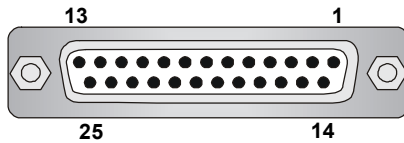

Pin Definition

PIN	SIGNAL	DESCRIPTION
1	STROBE	Strobe
2	DATA0	Data0
3	DATA1	Data1
4	DATA2	Data2
5	DATA3	Data3
6	DATA4	Data4
7	DATA5	Data5
8	DATA6	Data6
9	DATA7	Data7
10	ACK#	Acknowledge
11	BUSY	Busy
12	PE	Paper End
13	SELECT	Select
14	AUTO FEED#	Automatic Feed
15	ERR#	Error
16	INIT#	Initialize Printer
17	SLIN#	Select In
18	GND	Ground
19	GND	Ground
20	GND	Ground
21	GND	Ground
22	GND	Ground
23	GND	Ground
24	GND	Ground
25	GND	Ground

Connectors

The mainboard provides connectors to connect to FDD, IDE HDD, case, modem, LAN, USB Ports, IR module and CPU/System FAN.

Floppy Disk Drive Connector: FDD1

The mainboard provides a standard floppy disk drive connector that supports 360K, 720K, 1.2M, 1.44M and 2.88M floppy disk types.

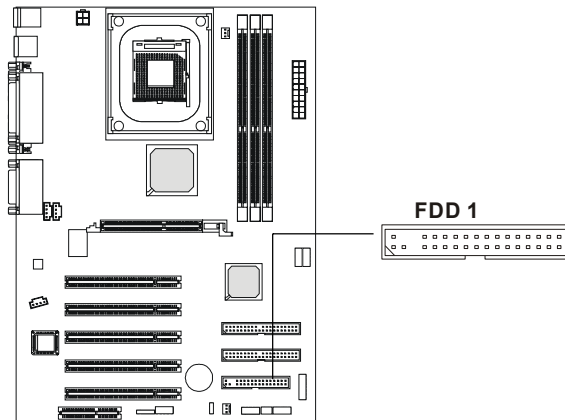

Hard Disk Connectors: IDE1 & IDE2

The mainboard has a 32-bit Enhanced PCI IDE and Ultra DMA 33/66/100 controller that provides PIO mode 0~4, Bus Master, and Ultra DMA/33/66/100 function. You can connect up to four hard disk drives, CD-ROM, 120MB Floppy (reserved for future BIOS) and other devices. These connectors support the provided IDE hard disk cable.

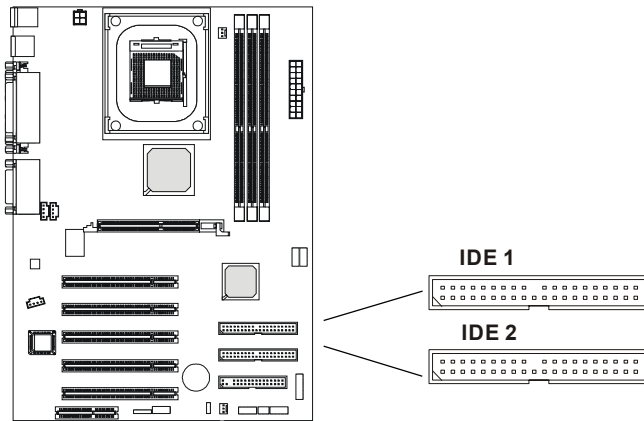

IDE1 (Primary IDE Connector)

The first hard drive should always be connected to IDE1. IDE1 can connect a Master and a Slave drive. You must configure second hard drive to Slave mode by setting the jumper accordingly.

IDE2 (Secondary IDE Connector)

IDE2 can also connect a Master and a Slave drive.



TIP:

If you install two hard disks on cable, you must configure the second drive to Slave mode by setting its jumper. Refer to the hard disk documentation supplied by hard disk vendors for jumper setting instructions.

CD-In Connector: JCD1

The connector is for CD-ROM audio connector.

Aux Line-In Connector: JAUX1

The connector is for DVD add-on card with Line-in connector.

Modem-In Connector: JMD1

The connector is for modem with internal audio connector.

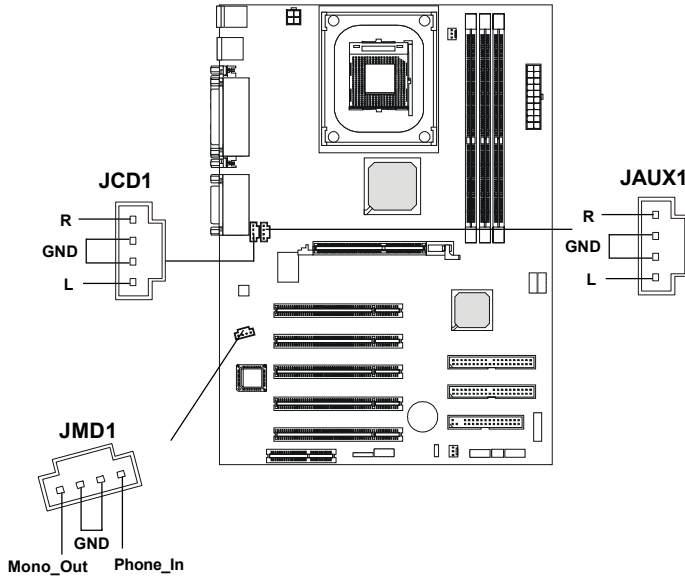

Fan Power Connectors: CPUFA/SYSFA

The CPUFA (processor fan) and SYSFA (system fan) support system cooling fan with +12V. It supports three-pin head connector. When connecting the wire to the connectors, always take note that the red wire is the positive and should be connected to the +12V, the black wire is Ground and should be connected to GND. If the mainboard has a System Hardware Monitor chipset on-board, you must use a specially designed fan with speed sensor to take advantage of the CPU fan control.

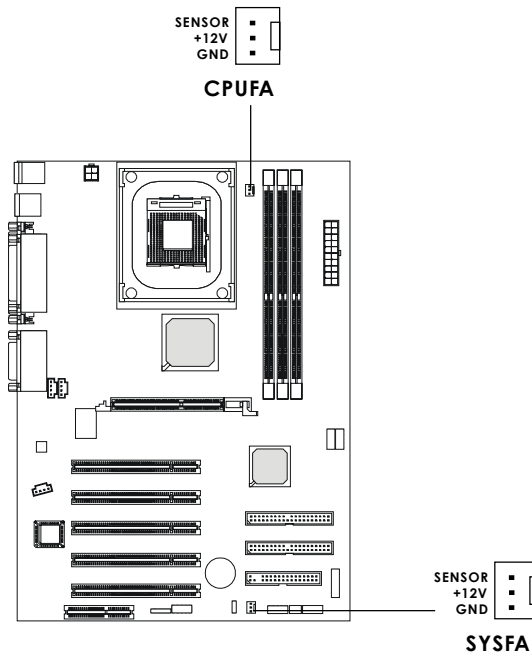

Note:

1. Always consult the vendor for proper CPU cooling fan.
2. CPU Fan supports the fan control. You can install the PC Alert utility that will automatically control the CPU Fan speed according to the actual CPU temperature.

Wake On Ring Connector: JMDM1

This connector allows you to connect to a modem card with Wake On Ring function. The connector will power up the system when a signal is received through the modem card.

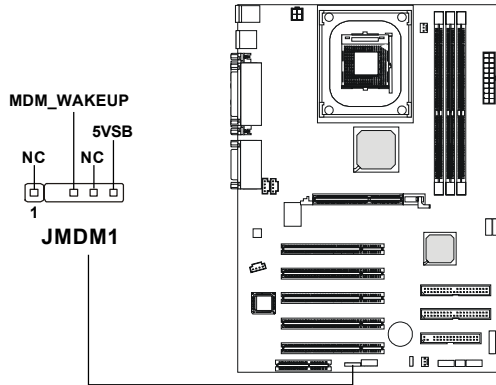

IrDA Infrared Module Header: JIR2

This connector allows you to connect to IrDA Infrared modules. You must configure the setting through the BIOS setup to use the IR function. The JIR2 is compliant to Intel Front Panel I/O Connectivity Design Guide.

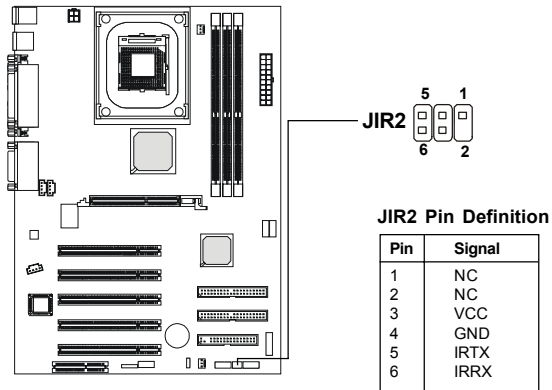

Front Panel Connector: JFP1 or JFP2

The mainboard provides one front panel connector for electrical connection to the front panel switches and LEDs. Users can choose either the JFP1 or the JFP2 depending on their needs. The difference between JFP1 & JFP2 is that JFP2 is compliant with Intel® Front Panel I/O Connectivity Design Guide.

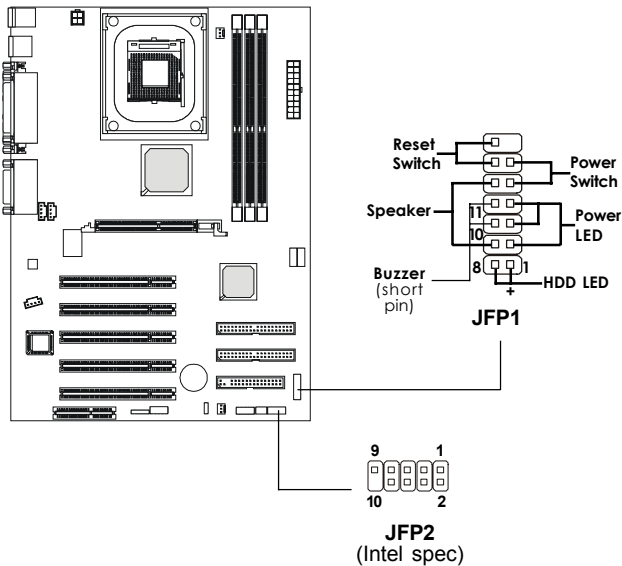

JFP2 Pin Definition

PIN	SIGNAL	DESCRIPTION
1	HD_LED_P	Hard disk LED pull-up
2	FP PWR/SLP	MSG LED pull-up
3	HD_LED_N	Hard disk active LED
4	FP PWR/SLP	MSG LED pull-up
5	RST_SW_N	Reset Switch low reference pull-down to GND
6	PWR_SW_P	Power Switch high reference pull-up
7	RST_SW_P	Reset Switch high reference pull-up
8	PWR_SW_N	Power Switch low reference pull-down to GND
9	RSVD_DNU	Reserved. Do not use.

Front Panel Audio Connector: JP20

The JP20 front panel audio connector allows you to connect to the front panel audio and is compliant with Intel Front Panel I/O Connectivity Design Guide.

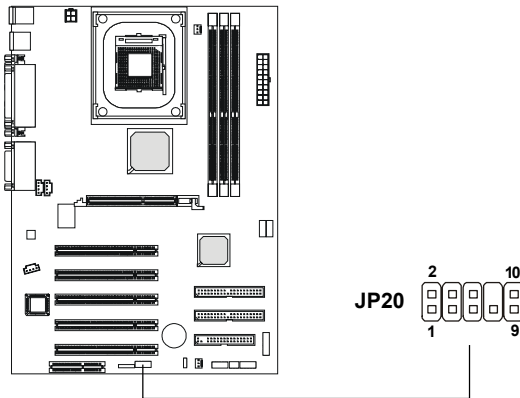

Pin Definition

PIN	SIGNAL	DESCRIPTION
1	AUD_MIC	Front panel microphone input signal
2	AUD_GND	Ground used by analog audio circuits
3	AUD_MIC_BIAS	Microphone power
4	AUD_VCC	Filtered +5V used by analog audio circuits
5	AUD_FPOUT_R	Right channel audio signal to front panel
6	AUD_RET_R	Right channel audio signal return from front panel
7	HP_ON	Reserved for future use to control headphone amplifier
8	KEY	No pin
9	AUD_FPOUT_L	Left channel audio signal to front panel
10	AUD_RET_L	Left channel audio signal return from front panel

Front USB Connector: JUSB1 or JUSB3

The mainboard provides one front Universal Serial Bus connector for users to connect to USB devices. Users can choose either the JUSB1 or the JUSB3 depending on their needs. The JUSB3 is compliant with Intel® Front Panel I/O Connectivity Design Guide.

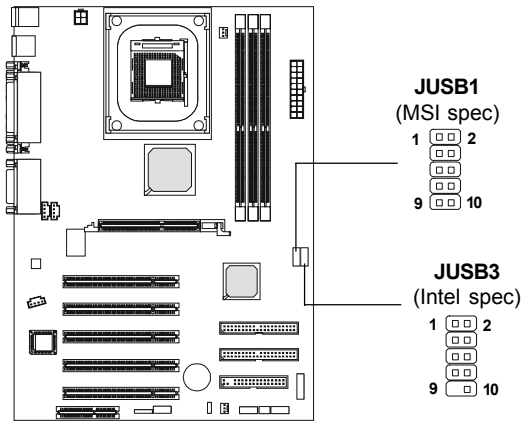

JUSB1 Pin Definition

Pin	Description	Pin	Description
1	VCC	2	GND
3	DATA2-	4	GND
5	DATA2+	6	DATA3+
7	GND	8	DATA3-
9	GND	10	VCC

JUSB3 Pin Definition

Pin	Description	Pin	Description
1	VCC	2	VCC
3	DATA2-	4	DATA3-
5	DATA2+	6	DATA3+
7	GND	8	GND
9	NC	10	OC0

Jumpers

The motherboard provides one jumper for you to set the computer's function. This section will explain how to change your motherboard's function through the use of the jumper.

Clear CMOS Jumper: JBAT1

There is a CMOS RAM on board that has a power supply from external battery to keep the data of system configuration. With the CMOS RAM, the system can automatically boot OS every time it is turned on. That battery has long life time for at least 5 years. If you want to clear the system configuration, use the JBAT1 (Clear CMOS Jumper) to clear data. Follow the instructions below to clear the data:

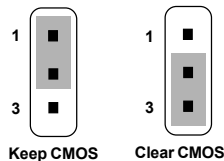
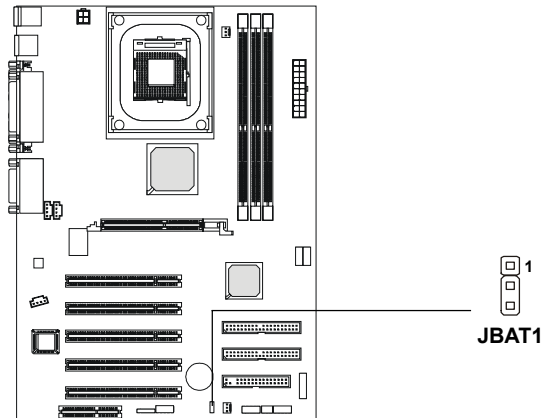

WARNING!

You can clear CMOS by shorting 2-3 pin while the system is off. Then return to 1-2 pin position. Avoid clearing the CMOS while the system is on; it will damage the mainboard.

Slots

The motherboard provides five 32-bit Master PCI bus slots, one AGP slot and one CNR slot.

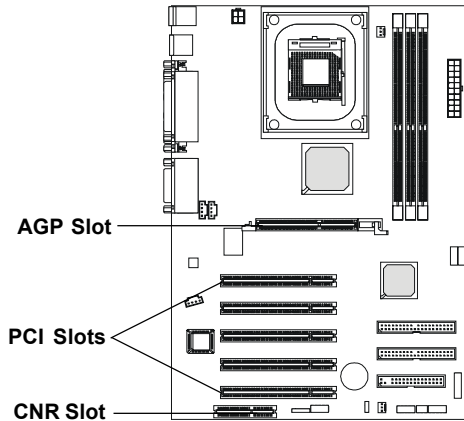

AGP (Accelerated Graphics Port) Slot

The AGP slot allows you to insert the AGP graphics card. AGP is an interface specification designed for the throughput demands of 3D graphics. It introduces a 66MHz, 32-bit channel for the graphics controller to directly access main memory and provides three levels of throughputs: 1x (266Mbps), 2x (533Mbps) and 4x (1.07Gbps).

PCI Slots

Five PCI slots allow you to insert the expansion cards to meet your needs. When adding or removing expansion cards, make sure that you unplug the power supply first. Meanwhile, read the documentation for the expansion card to make any necessary hardware or software settings for the expansion card, such as jumpers, switches or BIOS configuration.

CNR (Communication Network Riser)

The CNR slot allows you to insert the CNR expansion cards. CNR is a specially designed network, audio, or modem riser card for ATX family motherboards. Its main processing is done through software and controlled by the motherboard's chipset.

PCI Interrupt Request Routing

The IRQ, abbreviation of interrupt request line and pronounced I-R-Q, are hardware lines over which devices can send interrupt signals to the microprocessor. The PCI IRQ pins are typically connected to the PCI bus INT A# ~ INT D# pins as follows:

	Order 1	Order 2	Order 3	Order 4
PCI Slot 1	INT A#	INT B#	INT C#	INT D#
PCI Slot 2	INT B#	INT C#	INT D#	INT A#
PCI Slot 3	INT C#	INT D#	INT A#	INT B#
PCI Slot 4	INT D#	INT A#	INT B#	INT C#
PCI Slot 5	INT B#	INT C#	INT D#	INT A#

BIOS Setup

3

This chapter provides information on the BIOS Setup program and allows you to configure the system for optimum use.

You may need to run the Setup program when:

- An error message appears on the screen during the system booting up, and requests you to run SETUP.
- You want to change the default settings for customized features.

TOPICS

<i>Entering Setup</i>	3-2
<i>The Main Menu</i>	3-4
<i>Standard CMOS Features</i>	3-6
<i>Advanced BIOS Features</i>	3-8
<i>Advanced Chipset Features</i>	3-12
<i>Integrated Peripherals</i>	3-14
<i>Power Management Setup</i>	3-19
<i>PNP/PCI Configurations</i>	3-23
<i>PC Health Status</i>	3-25
<i>Frequency/Voltage Control</i>	3-26
<i>Load Fail-Safe/Optimized Defaults</i>	3-28
<i>Set Supervisor/User Password</i>	3-29

Entering Setup

Power on the computer and the system will start POST (Power On Self Test) process. When the message below appears on the screen, press key to enter Setup.

Press DEL to enter SETUP

If the message disappears before you respond and you still wish to enter Setup, restart the system by turning it OFF and On or pressing the RESET button. You may also restart the system by simultaneously pressing <Ctrl>, <Alt>, and <Delete> keys.

Control Keys

<↑>	Move to the previous item
<↓>	Move to the next item
<←>	Move to the item in the left hand
<→>	Move to the item in the right hand
<Enter>	Select the item
<Esc>	Jumps to the Exit menu or returns to the main menu from a submenu
<+/PU>	Increase the numeric value or make changes
<-/PD>	Decrease the numeric value or make changes
<F1>	General help, only for Status Page Setup Menu and Option Page Setup Menu
<F5>	Restore the previous CMOS value from CMOS, only for Option Page Setup Menu
<F6>	Load Fail-Safe Defaults
<F7>	Load Optimized Defaults
<F10>	Save all the CMOS changes and exit

Getting Help

After entering the Setup menu, the first menu you will see is the Main Menu.

Main Menu

The main menu lists the setup functions you can make changes to. You can use the control keys ($\uparrow\downarrow$) to select the item. The on-line description of the highlighted setup function is displayed at the bottom of the screen.

Sub-Menu

If you find a right pointer symbol (as shown in the right view) appears to the left of certain fields that means a sub-menu containing additional options can be launched from this field. You can use control keys ($\uparrow\downarrow$) to highlight the field and press <Enter> to call up the sub-menu. Then you can use the control keys to enter values and move from field to field within a sub-menu. If you want to return to the main menu, just press <Esc>.



```
▶ IDE Primary Master
▶ IDE Primary Slave
▶ IDE Secondary Master
▶ IDE Secondary Slave
```

General Help <F1>

The BIOS setup program provides a General Help screen. You can call up this screen from any menu by simply pressing <F1>. The Help screen lists the appropriate keys to use and the possible selections for the highlighted item. Press <Esc> to exit the Help screen.

The Main Menu

Once you enter Award® BIOS CMOS Setup Utility, the Main Menu (Figure 1) will appear on the screen. The Main Menu allows you to select from twelve setup functions and two exit choices. Use arrow keys to select among the items and press <Enter> to accept or enter the sub-menu.



Standard CMOS Features

Use this Menu for basic system configurations.

Advanced BIOS Features

Use this menu to set the Advanced Features available on your system.

Advanced Chipset Features

Use this menu to change the values in the chipset registers and optimize your system's performance.

Integrated Peripherals

Use this menu to specify your settings for integrated peripherals.

Power Management Setup

Use this menu to specify your settings for power management.

PnP/PCI Configurations

This entry appears if your system supports PnP/PCI.

PC Health Status

This entry shows your PC health status.

Frequency/Voltage Control

Use this menu to specify your settings for frequency/voltage control.

Load Fail-Safe Defaults

Use this menu to load the BIOS default values for minimal but stable system performance.

Load Optimized Defaults

Use this menu to load the BIOS default values that are factory settings for optimal system operations.

Set Supervisor/User Password

Use this menu to set User and Supervisor Passwords.

Save & Exit Setup

Save CMOS value changes to CMOS and exit setup.

Exit Without Saving

Abandon all CMOS value changes and exit setup.

Standard CMOS Features

The items in Standard CMOS Features Menu are divided into 10 categories. Each category includes no, one or more than one setup items. Use the arrow keys to highlight the item and then use the <PgUp> or <PgDn> keys to select the value you want in each item.

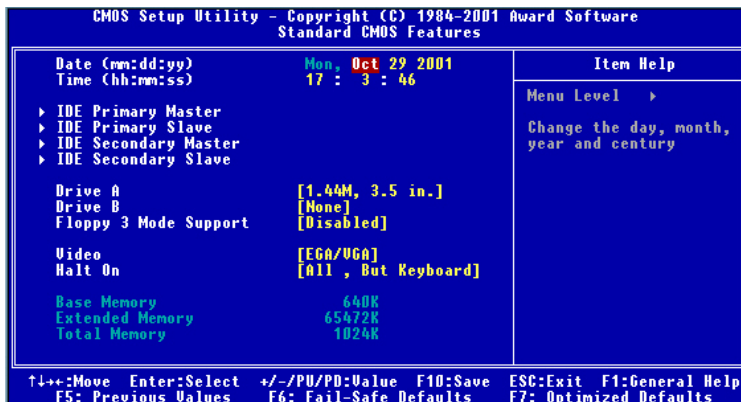

Date

The date format is <day><month> <date> <year>.

day Day of the week, from Sun to Sat, determined by BIOS. Read-only.

month The month from Jan. through Dec.

date The date from 1 to 31 can be keyed by numeric function keys.

year The year, depends on the year of the BIOS

Time

The time format is <hour> <minute> <second>.

IDE Primary/Secondary Master/Slave

Press PgUp/<+> or PgDn/<-> to select Manual, None, Auto type. Note that the specifications of your drive must match with the drive table. The hard disk will not work properly if you enter improper information for this category. If your hard disk drive type is not matched or listed, you can use Manual to define your own drive type manually.

If you select Manual, related information is asked to be entered to the follow-

ing items. Enter the information directly from the keyboard. This information should be provided in the documentation from your hard disk vendor or the system manufacturer.

If the controller of HDD interface is SCSI, the selection shall be “None”.

If the controller of HDD interface is CD-ROM, the selection shall be “None”.

Access Mode	The settings are CHS, LBA, Large, Auto.
Capacity	The formatted size of the storage device.
Cylinder	Number of cylinders.
Head	Number of heads.
Precomp	Write precompensation.
Landing Zone	Cylinder location of the landing zone.
Sector	Number of sectors.

Drive A/B

This item allows you to set the type of floppy drives installed. Available options are *None*, *360K*, *5.25 in.*, *1.2M*, *5.25 in.*, *720K*, *3.5 in.*, *1.44M*, *3.5 in.*, *2.88M*, *3.5 in.*

Floppy 3 Mode Support

Supported by the BIOS, the selected diskette drive can read 720-KB, 1.2-MB, and 1.44-MB diskettes. Setting options: *Disabled*, *Drive A*, *Drive B*, *Both*.

Video

The setting controls the type of video adapter used for the primary monitor of the system. Available options are *EGA/VGA*, *CGA 40*, *CGA 80* and *Mono*.

Halt On

The setting determines whether the system will stop if an error is detected at boot. Available options are:

<i>All Errors</i>	The system stops when any error is detected.
<i>No Errors</i>	The system doesn't stop for any detected error.
<i>All, But Keyboard</i>	The system doesn't stop for a keyboard error.
<i>All, But Diskette</i>	The system doesn't stop for a disk error.
<i>All, But Disk/Key</i>	The system doesn't stop for either a disk or a keyboard error.

Advanced BIOS Features

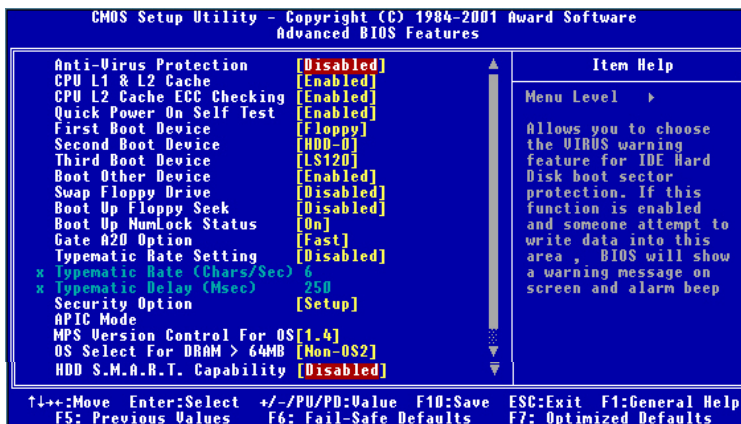

Anti-Virus Protection

The item is to set the Virus Warning feature for IDE Hard Disk boot sector protection. If the function is enabled and any attempt to write data into this area is made, BIOS will display a warning message on screen and beep. Settings: *Disabled* and *Enabled*.

CPU L1 & L2 Cache

The item allows you to turn on or off CPU's internal (L1) and external (L2) cache. Settings: *Enabled* and *Disabled*.

CPU L2 Cache ECC Checking

This setting allows you to enable or disable the ECC (Error-Correcting Code) feature for error detection and correction when data passes through L2 cache memory. Setting options: *Enabled*, *Disabled*.

Quick Power On Self Test

The option speeds up Power On Self Test (POST) after you power on the computer. When setting the item to *Enabled*, BIOS will shorten or skip some check items during POST. Settings: *Enabled* and *Disabled*.

First/Second/Third Boot Device

The items allow you to set the sequence of boot devices where BIOS attempts to load the disk operating system. The settings are:

<i>Floppy</i>	The system will boot from floppy drive.
<i>LS120</i>	The system will boot from LS-120 drive.
<i>HDD-0</i>	The system will boot from the first HDD.
<i>SCSI</i>	The system will boot from the SCSI.
<i>CDROM</i>	The system will boot from the CD-ROM.
<i>HDD-1</i>	The system will boot from the second HDD.
<i>HDD-2</i>	The system will boot from the third HDD.
<i>HDD-3</i>	The system will boot from the fourth HDD.
<i>ZIP</i>	The system will boot from ATAPI ZIP drive.
<i>LAN</i>	The system will boot from the Network drive.
<i>Disabled</i>	Disable this sequence.

Boot Other Device

Setting the option to *Enabled* allows the system to try to boot from other device if the system fails to boot from the 1st/2nd/3rd boot device.

Swap Floppy Drive

Setting to *Enabled* will swap floppy drives A: and B:.

Boot Up Floppy Seek

Setting to *Enabled* will make BIOS seek floppy drive A: before booting the system. Settings: *Disabled* and *Enabled*.

Boot Up NumLock Status

This setting is to set the Num Lock status when the system is powered on. Setting to *On* will turn on the Num Lock key when the system is powered on. Setting to *Off* will allow users to use the arrow keys on the numeric keypad. Setting options: *On*, *Off*.

Gate A20 Option

This item is to set the Gate A20 status. A20 refers to the first 64KB of extended memory. When the default value *Fast* is selected, the Gate A20 is controlled by Port92 or chipset specific method resulting in faster system performance. When *Normal* is selected, A20 is controlled by a keyboard controller or chipset hardware.

Typematic Rate Setting

This item is used to enable or disable the typematic rate setting including Typematic Rate & Typematic Delay.

Typematic Rate (Chars/Sec)

After *Typematic Rate Setting* is enabled, this item allows you to set the rate (characters/second) at which the keys are accelerated. Settings: *6, 8, 10, 12, 15, 20, 24* and *30*.

Typematic Delay (Msec)

This item allows you to select the delay between when the key was first pressed and when the acceleration begins. Settings: *250, 500, 750* and *1000*.

Security Option

This specifies the type of BIOS password protection that is implemented. Settings are described below:

Option	Description
<i>Setup</i>	The password prompt appears only when end users try to run Setup.
<i>System</i>	A password prompt appears every time when the computer is powered on or when end users try to run Setup.

MPS Version Control For OS

This field allows you to select which MPS (Multi-Processor Specification) version to be used for the operating system. You need to select the MPS version supported by your operating system. To find out which version to use, consult the vendor of your operating system. Settings: *1.4* and *1.1*.

OS Select For DRAM > 64MB

This allows you to run the OS/2[®] operating system with DRAM greater than 64MB. Setting options: *Non-OS2, OS2*.

HDD S.M.A.R.T. Capability

This allows you to activate the S.M.A.R.T. (Self-Monitoring Analysis & Reporting Technology) capability for the hard disks. S.M.A.R.T is a utility that monitors your disk status to predict hard disk failure. This gives you an opportunity to move data from a hard disk that is going to fail to a safe place before the hard disk becomes offline. Settings: *Enabled* and *Disabled*.

Advanced Chipset Features

The Advanced Chipset Features Setup option is used to change the values of the chipset registers. These registers control most of the system options in the computer.

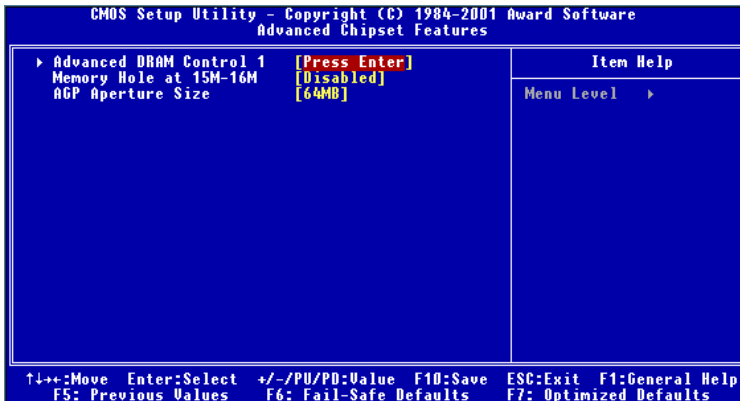

 **Note:** Change these settings only if you are familiar with the chipset.

Advanced DRAM Control 1

Press <Enter> to enter the sub-menu and the following screen appears:

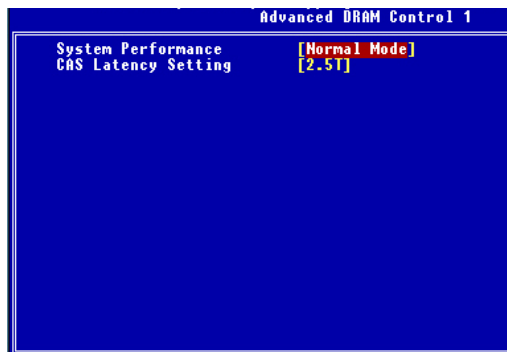

System Performance

The DRAM timing is controlled by the DRAM Timing Registers. The

Timings programmed into this register are dependent on the system design. Slower rates may be required in certain system designs to support loose layouts or slower memory. Setting options: *Safe Mode, Normal Mode, Fast Mode, Turbo Mode, Ultra Mode.*

CAS Latency Setting

When synchronous DRAM is installed, the number of clock cycles of CAS latency depends on the DRAM timing. The settings are: *2T, 2.5T, 3T.*

Memory Hole At 15M-16M

You can reserve this area of system memory for ISA adapter ROM. When this area is reserved, it cannot be cached. The user information of peripherals that need to use this area of system memory usually discusses their memory requirements. The settings are: *Enabled* and *Disabled.*

AGP Aperture Size

This setting controls just how much system RAM can be allocated to AGP for video purposes. The aperture is a portion of the PCI memory address range dedicated to graphics memory address space. Host cycles that hit the aperture range are forwarded to the AGP without any translation. The option allows the selection of an aperture size of *4MB, 8MB, 16MB, 32MB, 64MB, 128MB, and 256 MB.*

Integrated Peripherals

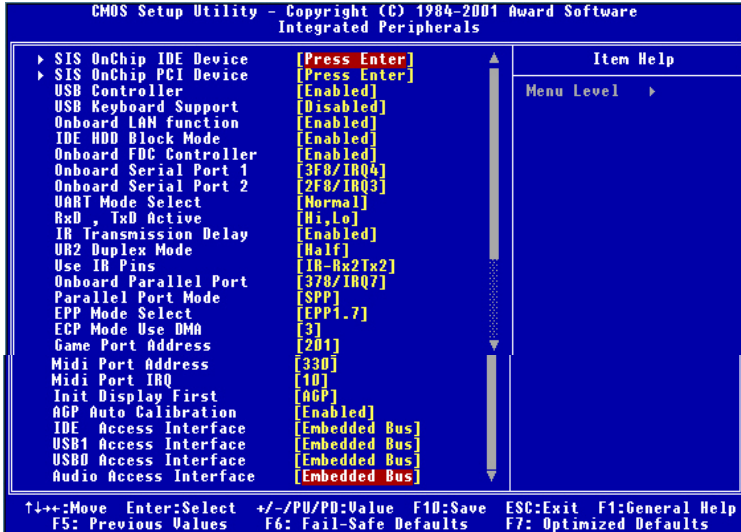

SIS OnChip IDE Device

Press <Enter> to enter the sub-menu and the following screen appears:

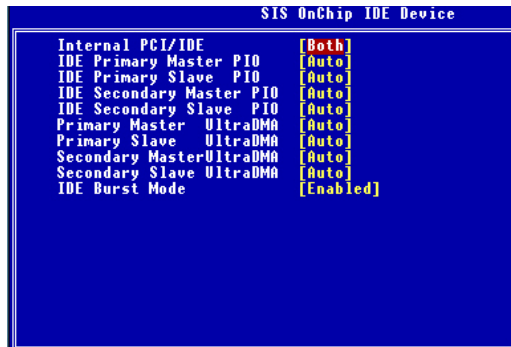

Internal PCI/IDE

This setting enables or disables the internal primary and secondary PCI &

IDE controllers. Setting options: *Disabled, Primary, Secondary, Both*.

IDE Primary/Secondary Master/Slave PIO

The four IDE PIO (Programmed Input/Output) fields let you set a PIO mode (0-4) for each of the four IDE devices that the onboard IDE interface supports. Modes 0 through 4 provide successively increased performance. In Auto mode, the system automatically determines the best mode for each device. The settings are: *Auto, Mode 0, Mode 1, Mode 2, Mode 3, Mode 4*.

Primary/Secondary Master/Slave UltraDMA

Ultra DMA/33 implementation is possible only if your IDE hard drive supports it and the operating environment includes a DMA driver (Windows 95 OSR2 or a third-party IDE bus master driver). If your hard drive and your system software both support Ultra DMA/33, Ultra DMA/66 and Ultra DMA/100 select Auto to enable BIOS support. The settings are: *Auto, Disabled*.

IDE Burst Mode

This allows your hard disk controller to use the fast block mode to transfer data to and from the hard disk drive. Block mode is also called block transfer, multiple commands or multiple sector read/write. *Enabled* enables IDE controller to use block mode; *Disabled* allows the controller to use standard mode. Setting options: *Disabled, Enabled*.

SiS OnChip PCI Device

Press <Enter> to enter the sub-menu and the following screen appears:

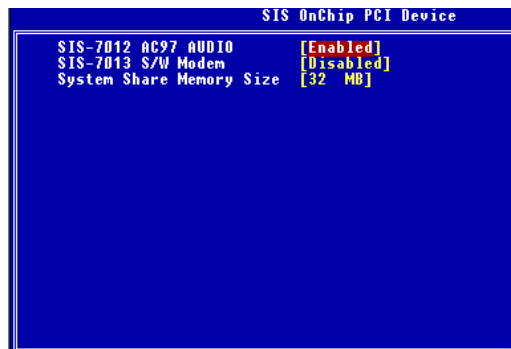

Chapter 3

SiS-7012 AC97 Audio

This setting enables or disables the SiS-7012 AC97 audio. Setting options: *Disabled, Auto*.

SiS-7013 S/W Modem

This setting enables or disables the SiS-7013 S/W modem. Setting options: *Disabled, Auto*.

USB Controller

Select *Enabled* if your system contains a Universal Serial Bus (USB) controller and you have USB peripherals. The settings are: *Enabled, Disabled*.

USB Keyboard Support

Set to *Enabled* if you need to use a USB keyboard in the operating system that does not support or have any USB driver installed, such as DOS and SCO Unix.

Onboard LAN Function (Optional)

Select *Enabled* to activate the onboard LAN controller. Setting options: *Enabled, Disabled*.

IDE HDD Block Mode

Block mode is also called block transfer, multiple commands, or multiple sector read/write. If your IDE hard drive supports block mode (most new drives do), select *Enabled* for automatic detection of the optimal number of block read/writes per sector the drive can support. The settings are: *Enabled, Disabled*.

Onboard FDC Controller

Select *Enabled* if your system has a floppy disk controller (FDD) installed on the system board and you wish to use it. If you install add-on FDC or the system has no floppy drive, select *Disabled* in this field. The settings are: *Enabled* and *Disabled*.

Onboard Serial Port 1/Port 2

Select an address and corresponding interrupt for the first and second serial ports. The settings are: *3F8/IRQ4, 2E8/IRQ3, 3E8/IRQ4, 2F8/IRQ3, Disabled, Auto*.

UART Mode Select

This setting allows you to specify the operation mode for serial port 2. Setting options: *IrDA*, *ASKIR*, *Normal*.

<i>Normal</i>	RS-232C Serial Port
<i>IrDA</i>	IrDA-compliant Serial Infrared Port
<i>ASKIR</i>	Amplitude Shift Keyed Infrared Port

RxD, TxD Active

This setting controls the receiving and transmitting speed of the IR peripheral in use. Setting options: *Hi/Hi*, *Hi/Lo*, *Lo/Hi*, *Lo/Lo*.

IR Transmission Delay

This setting determines whether the IR transmission rate will be delayed while converting to receiving mode. Setting options: *Disabled*, *Enabled*.

UR2 Duplex Mode

This setting controls the operating mode of IR transmission/reception. Setting options: *Full*, *Half*. Under Full Duplex mode, synchronous, bi-directional transmission/reception is allowed. Under Half Duplex mode, only asynchronous, bi-directional transmission/reception is allowed.

Use IR Pins

Please consult your IR peripheral documentation to select the correct setting of the TxD and RxD signals. Setting options: *RxD2/TxD2*, *IR-Rx2Tx2*.

Onboard Parallel Port

There is a built-in parallel port on the on-board Super I/O chipset that provides Standard, ECP, and EPP features. It has the following options:

<i>Disabled</i>	
<i>3BC/IRQ7</i>	Line Printer port 0
<i>278/IRQ5</i>	Line Printer port 2
<i>378/IRQ7</i>	Line Printer port 1

Parallel Port Mode

SPP	: Standard Parallel Port
EPP	: Enhanced Parallel Port
ECP	: Extended Capability Port
ECP + EPP	: Extended Capability Port + Enhanced Parallel Port

SPP/EPP/ECP/ECP+EPP

To operate the onboard parallel port as Standard Parallel Port only, choose “SPP.” To operate the onboard parallel port in the EPP mode simultaneously, choose “EPP.” By choosing “ECP”, the onboard parallel port will operate in ECP mode only. Choosing “ECP + EPP” will allow the onboard parallel port to support both the ECP and EPP modes simultaneously.

EPP Mode Select

The onboard parallel port is EPP Spec. compliant, so after the user chooses the onboard parallel port with the EPP function, the following message will be displayed on the screen: “EPP Mode Select.” At this time either *EPP 1.7* spec or *EPP 1.9* spec can be chosen.

ECP Mode Use DMA

The ECP mode has to use the DMA channel, so choose the onboard parallel port with the ECP feature. After selecting it, the following message will appear: “ECP Mode Use DMA.” At this time, the user can choose between DMA channel 3 or 1.

Game Port Address/Midi Port Address

This setting assigns certain addresses for the game port and midi port.

Midi Port IRQ

This setting assigns an IRQ for the midi port.

Init Display First

This item specifies which VGA card is your primary graphics adapter. Settings: *PCI Slot* and *AGP*.

AGPAuto Calibration

This setting disables/enables the AGP auto calibration. Setting options: *Disabled*, *Enabled*.

IDE/USB1/USB0/Audio Access Interface

These settings control the access interface for specified hardware peripherals. Setting options: *(Auto)*, *Embedded Bus*, *PCI Bus*.

Power Management Setup

The Power Management Setup allows you to configure you system to most effectively save energy while operating in a manner consistent with your own style of computer use.

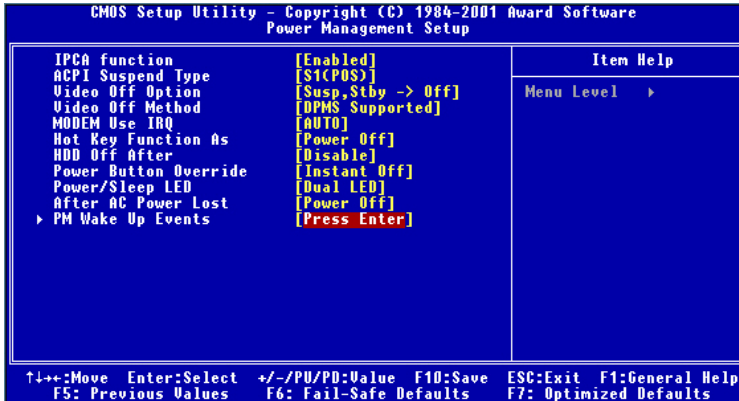

IPCA Function

This item is to activate the ACPI (Advanced Configuration and Power Management Interface) Function. If your operating system is ACPI-aware, such as Windows® 98SE/2000/ME, select *Enabled*. Settings: *Enabled* and *Disabled*.

ACPI Suspend Type

This item specifies the power saving modes for ACPI function. Options are:

- S1 (POS)* The S1 sleep mode is a low power state. In this state, no system context (CPU or chipset) is lost and hardware maintains all system context.
- S3 (STR)* The S3 sleep mode is a power-down state in which power is supplied only to essential components such as main memory and wake-capable devices and all system context is saved to main memory. The information stored in memory will be used to restore the PC to the previous state when an “wake up” event occurs.
- S1 & S3* Both S1 & S3 modes will be adopted.

Chapter 3

Video Off Option

This setting is used to control the mode in which the monitor will shut down.

Setting options:

- Always On* Always turn on.
- Suspend -> Off* During suspend mode, the monitor will shut down.
- Susp, Stby->Off* During suspend or standby mode, the monitor will shut down.
- All Modes ->Off* The monitor is turned off during doze, standby, or suspend mode.

Video Off Method

This determines the manner in which the monitor is blanked.

- V/H SYNC+Blank* This selection will cause the system to turn off the vertical and horizontal synchronization ports and write blanks to the video buffer.
- Blank Screen* This option only writes blanks to the video buffer.
- DPMS Supported* Initial display power management signaling.

Modem Use IRQ

This setting names the interrupt request (IRQ) line assigned to the modem (if any) on your system. Activity of the selected IRQ always awakens the system.

Setting options: 3, 4, 5, 7, 9, 10, 11, AUTO.

Hot Key Function As

This setting specifies the function of the preset hot key. Setting options:

Disable, Power Off, Suspend.

HDD Off After

When enabled and after the set time of system inactivity, the hard disk drive will be powered down while all other devices remain active. The settings are:

Disable, 1~15 Min.

Power Button Override

Pressing the power button for more than 4 seconds forces the system to enter the Soft-Off state. The settings are: *Delay 4 Sec, Instant Off.*

Power/Sleep LED

This item configures how the system uses power LED on the case to indicate

the sleep state. Available options are:

- Single LED* The power LED blinks to indicate the sleep state without changing its color.
- Dual LED* The power LED changes its color to indicate the sleep state.

After AC Power Lost

This setting specifies whether your system will reboot after a power failure or interrupts occurs. Available settings are:

- Power Off* Leaves the computer in the power off state.
- Power On* Reboots the computer.
- Last State* Restores the system to the status before power failure or interrupt occurs.

PM Wake Up Events

Press <Enter> to enter the sub-menu and the following screen appears:

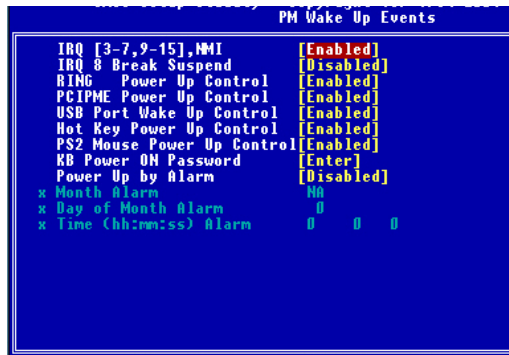

IRQ [3-7,9-15],NMI/IRQ 8 Break Suspend

This setting enables/disables the monitoring of the specified IRQ line. If set to *Enabled*, the activity of the specified IRQ line will prevent the system from entering power saving modes or awaken it from power saving modes. Setting options: *Disabled, Enabled*.



Note: IRQ (Interrupt Request) lines are system resources allocated to I/O devices. When an I/O device needs to gain attention of the operating system, it signals this by causing an IRQ to occur. After

receiving the signal, when the operating system is ready, the system will interrupt itself and perform the service required by the I/O device.

RING Power Up Control, PCI PME Power Up Control, USB Port Wake Up Control, Hot Key Power Up Control, PS2 Mouse Power Up Control

These fields specify whether the system will be awakened from power saving modes when activity or input signal of the specified hardware peripheral or component is detected.



Note: To use the function of “RING Power Up Control”, you need to install a modem supporting power on function.

KB Power On Password

This setting allows you to enter the password to authorize the keyboard to power on the system.

Power Up by Alarm

This function is for setting date and time for your computer to boot up. During *Disabled*, you cannot use this function. During *Enabled*, choose the Month, Day, and Time Alarm:

Month Alarm You can choose which month the system will boot up.

Day of Month Alarm You can choose which day of the preset month the system will boot up. Set to 0, to boot every day.

Time (hh:mm:ss) Alarm You can choose what hour, minute and second the system will boot up.



Note: If you have change the setting, you must let the system boot up until it goes to the operating system, before this function will work.

PNP/PCI Configurations

This section describes configuring the PCI bus system. PCI, or Peripheral Component Interconnect, is a system which allows I/O devices to operate at speeds nearing the speed the CPU itself uses when communicating with its own special components. This section covers some very technical items and it is strongly recommended that only experienced users should make any changes to the default settings.

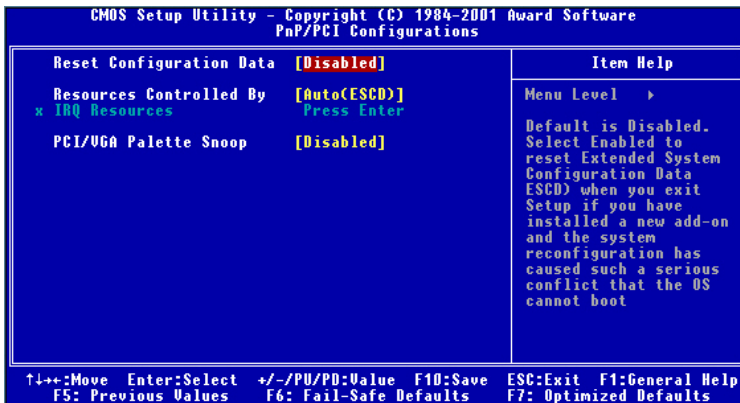

Reset Configuration Data

Normally, you leave this field Disabled. Select Enabled to reset Extended System Configuration Data (ESCD) when you exit Setup if you have installed a new add-on and the system reconfiguration has caused such a serious conflict that the operating system can not boot. The settings are: *Enabled* and *Disabled*.

Resource Controlled By

The Award Plug and Play BIOS has the capacity to automatically configure all of the boot and Plug and Play compatible devices. However, this capability means absolutely nothing unless you are using a Plug and Play operating system such as Windows® 95/98. If you set this field to “manual” choose specific resources by going into each of the sub menu that follows this field (a sub menu is preceded by a “>”). The settings are: *Auto (ESCD)*, *Manual*.

IRQ Resources

The items are adjustable only when *Resources Controlled By* is set to *Manual*.

Chapter 3

Press <Enter> and you will enter the sub-menu of the items. IRQ Resources list IRQ 3/4/5/7/9/10/11/12/14/15 for users to set each IRQ a type depending on the type of device using the IRQ. Settings are:

PCI Device For Plug & Play compatible devices designed for PCI bus architecture.

Reserved The IRQ will be reserved for further request.

PCI/VGA Palette Snoop

When set to *Enabled*, multiple VGA devices operating on different buses can handle data from the CPU on each set of palette registers on every video device. Bit 5 of the command register in the PCI device configuration space is the VGA Palette Snoop bit (0 is disabled). For example, if there are two VGA devices in the computer (one PCI and one ISA) and the:

VGA Palette Snoop Bit Setting	Action
<i>Disabled</i>	Data read or written by the CPU is only directed to the PCI VGA device's palette registers.
<i>Enabled</i>	Data read or written by the CPU is directed to both the PCI VGA device's palette registers and the ISA VGA device's palette registers, permitting the palette registers of both VGA devices to be identical.

The setting must be set to *Enabled* if any ISA bus adapter in the system requires VGA palette snooping.

PC Health Status

This section shows the status of your CPU, fan, warning for overall system status.

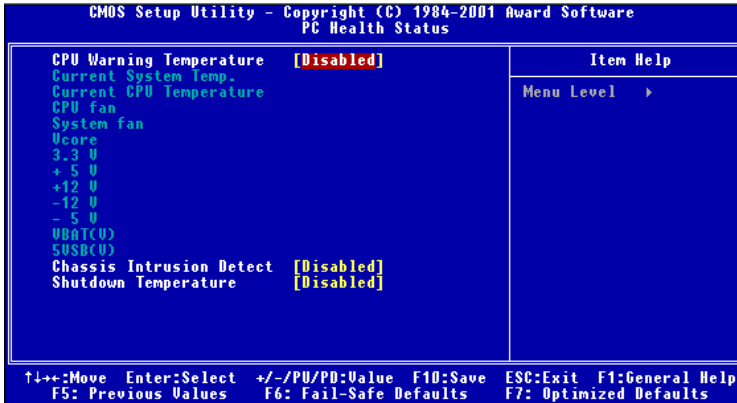

CPU Warning Temperature

If the CPU temperature reaches the upper limit preset in this setting, the warning mechanism will be activated. This helps you to prevent the CPU overheat problem.

Current System/CPU Temperature, CPU/System Fan, Vcore, 3.3V, +5V, +12V, -12V, -5V, VBAT(V), 5VSB(V)

These items display the current status of all of the monitored hardware devices/components such as CPU voltages, temperatures and all fans' speeds.

Chassis Intrusion Detect

Set this option to enable, reset, or disable the chassis intrusion detector. During *Enabled*, any intrusion on the system chassis will be recorded. The next time you turn on the system, it will show a warning message. To be able to clear those warnings, choose *Reset*. After clearing the message it will go back to *Enabled*.

Shutdown Temperature

This option is for setting the shutdown temperature level for the processor. When the processor reaches the temperature you set, the system will be shut down.

Frequency/Voltage Control

This section describes how to set the Chassis Intrusion feature, CPU FSB frequency, monitor the current hardware status including CPU/system temperatures, CPU/System Fan speeds, Vcore etc. Monitor function is available only if there is hardware monitoring mechanism onboard.

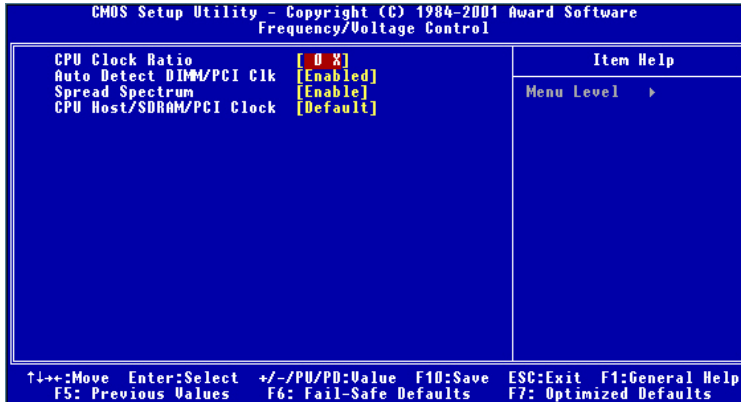

CPU Clock Ratio

This setting controls the multiplier that is used to determine the internal clock speed of the processor relative to the external or motherboard clock speed.

Auto Detect DIMM/PCI Clk

This option allows you to enable/disable the feature of auto detecting the clock frequency of the installed DIMM/PCI bus. The settings are: *Enabled*, *Disabled*.

Spread Spectrum

When the motherboard's clock generator pulses, the extreme values (spikes) of the pulses creates EMI (Electromagnetic Interference). The Spread Spectrum function reduces the EMI generated by modulating the pulses so that the spikes of the pulses are reduced to flatter curves. If you do not have any EMI problem, leave the setting at *Disabled* for optimal system stability and performance. But if you are plagued by EMI, setting to *Enabled* for EMI reduction. Remember to disable Spread Spectrum if you are overclocking be-

cause even a slight jitter can introduce a temporary boost in clockspeed which may just cause your overclocked processor to lock up.

CPU Host/SDRAM/PCI Clock

This setting controls the clock speed of the CPU Host (FSB)/SDRAM memory bus/PCI bus on the motherboard.

Load Fail-Safe/Optimized Defaults

The two options on the main menu allow users to restore all of the BIOS settings to the default Fail-Safe or Optimized values. The Optimized Defaults are the default values set by the mainboard manufacturer specifically for optimal performance of the mainboard. The Fail-Safe Defaults are the default values set by the BIOS vendor for stable system performance.

When you select Load Fail-Safe Defaults, a message as below appears:



Pressing *Y* loads the BIOS default values for the most stable, minimal system performance.

When you select Load Optimized Defaults, a message as below appears:



Pressing *Y* loads the default factory settings for optimal system performance.

Set Supervisor/User Password

When you select this function, a message as below will appear on the screen:



Enter Password:

Type the password, up to six characters in length, and press <Enter>. The password typed now will replace any previously set password from CMOS memory. You will be prompted to confirm the password. Retype the password and press <Enter>. You may also press <Esc> to abort the selection and not enter a password.

To clear a set password, just press <Enter> when you are prompted to enter the password. A message will show up confirming the password will be disabled. Once the password is disabled, the system will boot and you can enter Setup without entering any password.

When a password has been set, you will be prompted to enter it every time you try to enter Setup. This prevents an unauthorized person from changing any part of your system configuration.

Additionally, when a password is enabled, you can also have AMIBIOS to request a password each time the system is booted. This would prevent unauthorized use of your computer. The setting to determine when the password prompt is required is the *Security Option* of the *Advanced BIOS Features* menu. If the *Security Option* is set to *System*, the password is required both at boot and at entry to Setup. If set to *Setup*, password prompt only occurs when you try to enter Setup.



About Supervisor Password & User Password:

Supervisor password: Can enter and change the settings of the setup menu.

User password: Can only enter but do not have the right to change the settings of the setup menu.

Glossary

ACPI (*Advanced Configuration & Power Interface*)

This power management specification enables the OS (operating system) to control the amount of power given to each device attached to the computer. Windows 98/98SE, Windows 2000 and Windows ME can fully support ACPI to allow users managing the system power flexibly.

AGP (*Accelerated Graphics Port*)

A new, high-speed graphics interface that based on PCI construction and designed especially for the throughput demands of 3-D graphics. AGP provides a direct channel (32-bit wide bus) between the display controller and main memory for high graphics quality and performance.

ATX

A modern shape and layout of mainboard that supersedes the widely-used Baby AT form factor. It improves many placement of components and makes a more efficient design.

BIOS (*basic input/output system*)

On PCs, an essential software that contains all the control code of input/output interface (such as keyboard, disk drives, etc.). It executes hardware test on booting the system, starts the OS, and provides an interface between the OS and the components. The BIOS is stored in a ROM chip.

Buffer

A region of memory reserved as a temporary storage area. In most cases, the OS or applications will create buffer areas to save the necessary data, and the applications can find the data in the areas first to increase the processing speed.

Bus

A set of hardware lines within the computer system, through which the data is transferred among different components. In a PC, the term **bus** usually refers to a local bus that connects the internal components to the CPU and main memory.

Cache

A special memory subsystem that is used to speed up the data traffer. It stores the contents of frequently accessed RAM locations and the addresses where these data items are stored.

Chipset

A collection of integrated chips designed to perform one or more related functions. For example, a modem chipset contains all the primary circuits for transmitting and receiving data;

Glossary

a PC chipset provides the electronic interfaces between all subsystems.

CMOS (*complementary metal-oxide semiconductor*)

CMOS is a widely used type of semiconductor, which features high speed and low power consumption. PCs usually contain a small amount of battery-powered CMOS memory to retain the date, time, and system setup parameters.

COM

In MS-DOS system, the name of a serial communications port. DOS supports four serial ports. For example, if a modem is connected to one serial port and a serial mouse to another, they are identified as COM1 and COM2.

DIMM (*dual in-line memory module*)

A small circuit board that holds memory chips. A **SIMM** (*single in-line memory module*) has a 32-bit path to the memory chips whereas a DIMM has 64-bit path.

DMA (*direct memory access*)

A transfer mode between the main memory and the peripheral devices that without passing through the CPU. Using the DMA controller, data is transferred much faster.

DRAM (*Dynamic RAM*)

A most common type of computer memory. It usually uses one transistor and a capacitor to represent a bit. As the development of technology, the memory type and specification used in computer becomes variety, such as SDRAM, DDR SDRAM, and RDRAM. For further instruction, please see the table below:

Dynamic RAM (DRAM) Memory Technologies					
Type	First Used	Clock Rate	Bus* Width	Peak Bandwidth	Volts
FPM (60,70ns)	1990	25MHz	64 bits	200 MBps	5v
EDO (50,60,70ns)	1994	40MHz	64 bits	320 MBps	5v
SDRAM (66MHz)	1996	66MHz	64 bits	528 MBps	3.3v
SDRAM (100MHz)	1998	100MHz	64 bits	800 MBps	3.3v
SDRAM (133MHz)	1999	133MHz	64 bits	1.1 GBps	3.3v
RDRAM (Direct Rambus)	1999	400MHz	16 bits	1.6 GBps	2.5v
DDR SDRAM (100MHz)	2000	100MHz	64 bits	1.6 GBps	3.3v
DDR SDRAM (133MHz)	2000	133MHz	64 bits	2.1 GBps	3.3v

* Memory channel width (64 bits started with 75MHz Pentium)

Source: Computer Desktop Encyclopedia

ECC Memory (*error correcting code memory*)

A type of memory that contains special circuitry for testing the accuracy of data and correcting the errors on the fly.

IDE (*Integrated Drive Electronics*)

A type of disk-drive interface widely used to connect hard disks, CD-ROMs and tape drives to a PC, in which the controller electronics is integrated into the drive itself, eliminating the need for a separate adapter card. The IDE interface is known as the ATA (AT Attachment) specification.

IEEE 1394

A new, high speed external bus standard, also known as *FireWire* or *iLink*, which supports data transfer rates of up to 400 Mbps for connecting up to 63 external devices.

IrDA (*Infrared Data Association*)

A group of device vendors, including computer, component and telecommunications, who have developed a standard for transmitting data via infrared light waves. This enables you to transfer data from one device to another without any cables.

LAN (*local area network*)

A computer network that covers a relatively smaller area, such as in a building or an enterprise. It is made up of servers, workstations, shared resources, a network operating system and a communications link. These individual PCs and devices on a LAN are known as “nodes”, and are connected by cables to access data and devices anywhere on the LAN, so that many users can share expensive devices and data.

LED (*light emitting diode*)

A semiconductor device that converts electrical energy into light. Since it lights up (usually red) when electricity is passed through it, it is usually used for the activity lights on computer’s component, such as disk drivers.

LPT (*line printer terminal*)

Logical device name for a line printer; a name reserved by the MS-DOS for up to three parallel printer ports: LPT1, LPT2, and LPT3. It is frequently used by the OS to identify a printer.

PCI (*Peripheral Component Interconnect*)

A local bus standard developed by Intel that first appeared on PCs in late 1993. PCI provides “plug and play” capability and allows IRQs to be shared. The PCI controller can exchange data with the system’s CPU either 32 bits or 64 bits at a time.

Glossary

PnP (*Plug and Play*)

A set of specifications that allows a PC to configure itself automatically to work with peripherals. The user can "plug" in a peripheral device and "play" it without configuring the system manually. To implement this useful feature, both the BIOS that supports PnP and a PnP expansion card are required.

POST (*Power On Self Test*)

During booting up your system, the BIOS executes a series of diagnostic tests, include checking the RAM, the keyboard, the disk drives, etc., to see if they are properly connected and operating.

PS/2 Port

A type of port developed by IBM for connecting a mouse or keyboard to a PC. The PS/2 port supports a mini DIN plug containing just 6 pins. Most modern PCs equipped with PS/2 ports so that the special port can be used by another device, such as a modem.

USB (*universal serial bus*)

A hardware interface for low-speed peripherals such as the keyboard, mouse, joystick, etc. USB provides a maximum bandwidth of 12 Mbit/sec (Mbps) for connecting up to 127 peripheral devices to PC. USB features hot swap capability and multiple data streams, allows external devices to be plugged in and unplugged without turning the system off.

Virus

A program or a piece of code that infects computer files by inserting in those files copies of itself. The virus code is buried within an existing program, and is activated when that program is executed. All the viruses are man-made, and often have damaging side effects.