

# use & care guide

Electrical Requirements Page 3

Installation Instructions Page 7

How to Use Page 10

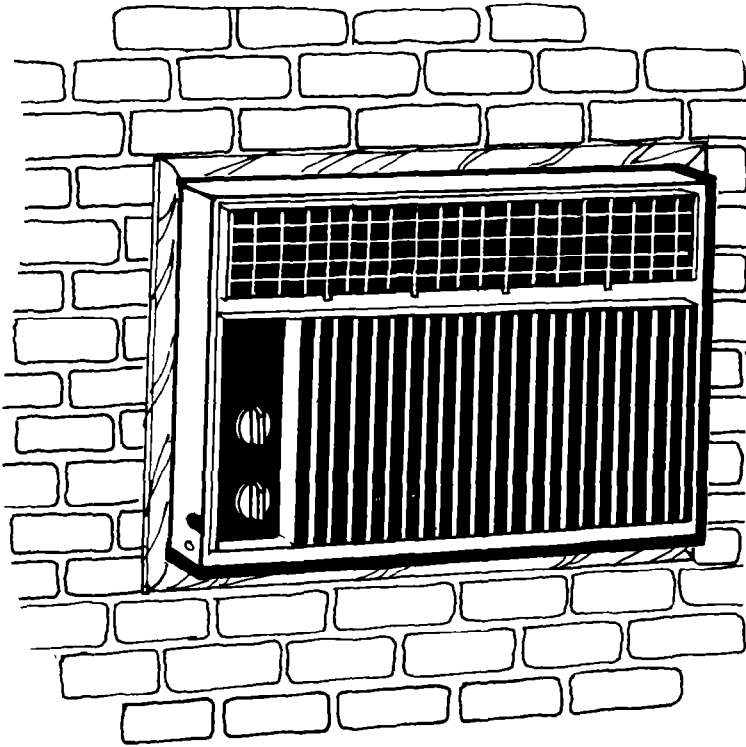

## AIR CONDITIONER

Ovens, Compactors, Room Air Conditioners, Dehumidifiers, Automatic Washers, Clothes Dryers, Freezers, Refrigerator-Freezers, Ice Makers, Dishwashers

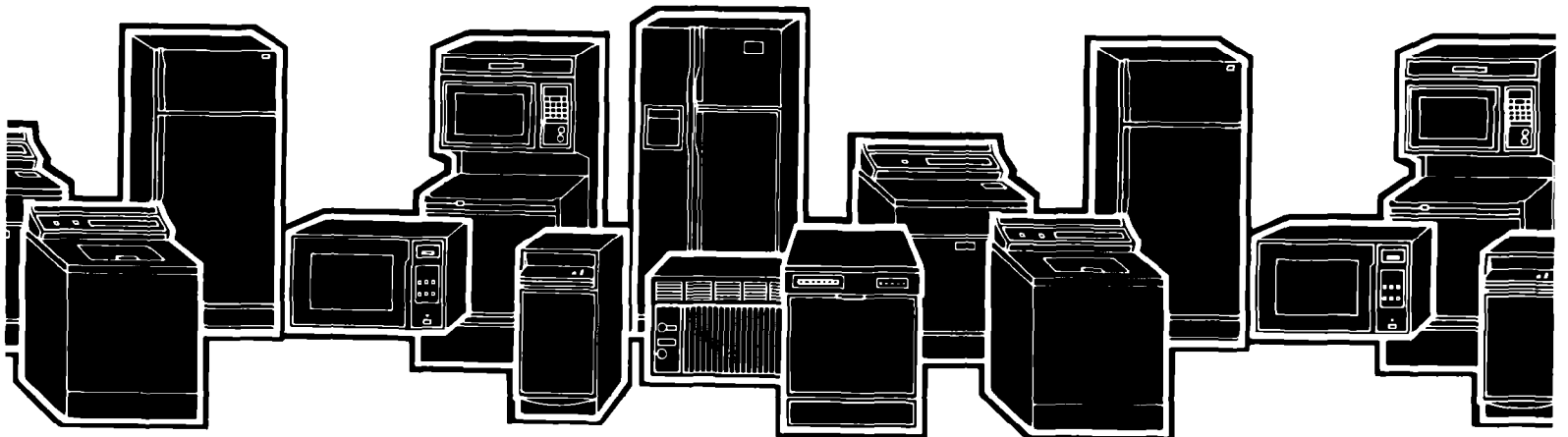

## IMPORTANT...

Please read this use and care guide before installing or using your air conditioner. It tells you how to install and operate it, and gives important electrical information. Save it for future use in case you may have a question or move the air conditioner.

### Copy your Model and Serial Numbers here...

When you need service or call with a question, have this information ready:

- 1. Complete Model and Serial Numbers.** To find Model and Serial Numbers remove the front panel (see page 12). The numbers are located on a label attached to the evaporator coil cover near the top of the unit.

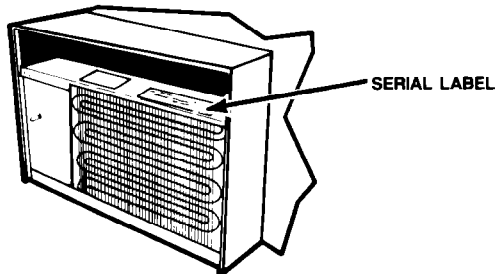

- 2. Purchase date from sales slip.** Copy this information in the spaces below. Keep this book, your warranty and sales slip together in a handy place.

\_\_\_\_\_

Model Number

\_\_\_\_\_

Serial Number

\_\_\_\_\_

Purchase Date

\_\_\_\_\_

Service Company and Telephone Number



**CAUTION:**  
Handle the air conditioner with care. Watch out for the sharp metal fins on the front and rear coils.

## BEFORE YOU USE YOUR AIR CONDITIONER

**It is your responsibility to make sure that your air conditioner:**

- Has been properly installed.
- Is the right size for the area you want to cool.
- Is properly connected to electricity.
- Is properly electrically grounded.
- Is properly used only for the job it was intended to do.
- Is not used by children or anyone not able to operate it properly.
- Is properly maintained.
- Also, remove energy label and buy guide. Use damp cloth to take off any glue residue. Do not use a sharp instrument or any harsh or abrasive cleaners.

### Energy Saving Tips

- Improve home insulation (seal doors, windows, and close fireplace flue).
- Close blinds or drapes on sunny side of house; add window awnings.
- Keep air filter clean. Don't block air flow with drapes or furniture.
- Ventilate attic (high temperature levels add to normal cooling load).
- Try not to use heat producing appliances during the hottest part of the day. Turn lights, radios, televisions, and other appliances off when not needed.
- Keep heat registers and cool air returns closed or blocked off so cooled air won't escape.
- Use a vent fan in areas where cooking, laundry, or bathing is done to pull out extra heat and moisture near its source.

## Contents

	page		page
Before You Use Your Air Conditioner . . . .	2	Cleaning and Caring for Your	
Energy Tips . . . . .	2	Air Conditioner . . . . .	12
Electrical Requirements . . . . .	3	Cooling Load Guide . . . . .	14
Installation Instructions . . . . .	7	Self-Service Checklist . . . . .	15
How to Start and		Service Information . . . . .	15
Use Your Air Conditioner . . . . .	10		

© 1987 Whirlpool Corporation

# Electrical Requirements For Your Air Conditioner

BELOW ARE ELECTRICAL PLUG VARIATIONS, CHOOSE THE ONE WHICH MATCHES THE AMPERE RATING OF YOUR UNIT. THE NUMBER OF AMPERES IS PRINTED ON THE SERIAL LABEL, ATTACHED TO THE FRONT OF THE UNIT, BEHIND THE FRONT PANEL (SEE PAGE 2).

## Chart-A

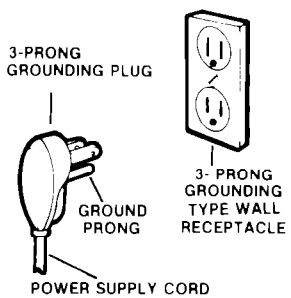
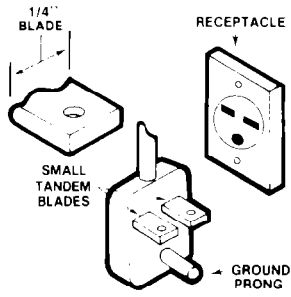
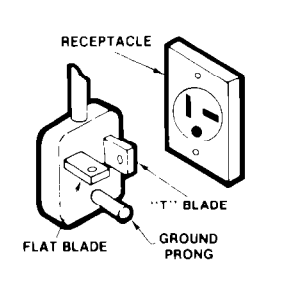
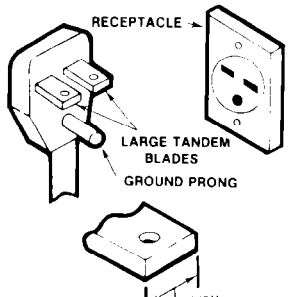
PLUG TYPE	SEE ELECTRICAL REQUIREMENTS
	<h1 style="text-align: center;">A</h1> <p>For 115 volt models with serial plate amperes up through 12.0</p>
	<h1 style="text-align: center;">B</h1> <p>For 230 volt and 230/208 volt models with serial plate amperes up through 12.0</p>
	<h1 style="text-align: center;">C</h1> <p>For 230 volt and 230/208 volt models with serial plate amperes up through 16.0</p>
	<h1 style="text-align: center;">D</h1> <p>For 230 volt and 230/208 volt models with serial plate amperes up through 24.0</p>

# A

## ELECTRICAL REQUIREMENTS

For 115 volt models with serial plate amperes up through 12.0

OBSERVE ALL LOCAL GOVERNING CODES AND ORDINANCES

Do not, under any circumstances, remove the power supply cord ground prong.

## RECEPTACLE WIRING

RECEPTACLE WIRING should be at least as large as 14 gauge. Use copper wire only. It is the personal responsibility and obligation of the customer to provide proper and adequate receptacle wiring installed by a qualified electrician. OBSERVE NATIONAL ELECTRICAL CODE AND ALL LOCAL GOVERNING CODES AND ORDINANCES.

## Electrical Requirements

A 115 volt (103.5 min., 126.5 max.) 60 hertz AC only, 15 ampere fused electrical supply is required (time delay fuse or time delay circuit breaker required). *It is required that a separate circuit, serving only this appliance, be provided. Do not use an extension cord.*

## Electrical Connection

Electrical Ground is Required on this Appliance

### RECOMMENDED GROUNDING METHOD

For your personal safety, this appliance must be grounded. This appliance is equipped with a power supply cord having a 3-prong grounding plug. To minimize possible shock hazard, the cord must be plugged into a mating 3-prong grounding type wall receptacle, grounded in accordance with the National Electrical Code and local codes and ordinances. If a mating wall receptacle is not available, it is the personal responsibility and obligation of the customer to have a properly grounded 3-prong wall receptacle installed by a qualified electrician. See Figure 1 on page 4.

Figure 1

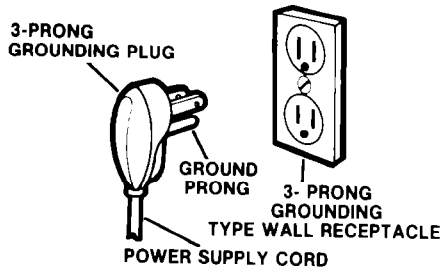

**ALTERNATE GROUNDING METHOD**

If changing and properly grounding the wall receptacle is impossible and where local codes permit (consult your electrical inspector), a temporary adapter may be plugged into the existing 2-prong wall receptacle to mate with the 3-prong power supply cord. See Figure 2. **THIS, HOWEVER, IS NOT RECOMMENDED.**

If this is done, you must connect the grounded eyelet on the adapter to the wall receptacle cover plate screw and from this same screw, you must connect a separate copper ground wire (#14 minimum) to a grounded cold water pipe.\* See Figure 2. Do not ground to a gas supply pipe. Do not connect to electrical supply until appliance is permanently grounded.

Figure 2

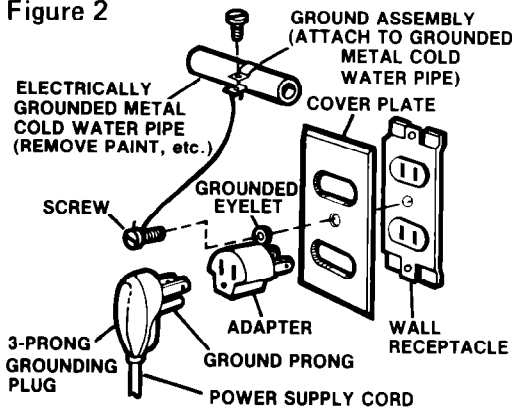

\*Cold water pipe must have metal continuity to electrical ground and not be interrupted by plastic, rubber or other electrically insulating connectors (including water meter or pump) without adding a jumper wire at these connections.

# B ELECTRICAL REQUIREMENTS

For 230 volt and 230/208 volt models with serial plate amperes up through 12.0

Refer to Chart B for specific wiring and receptacle information to be used.

OBSERVE ALL LOCAL GOVERNING CODES AND ORDINANCES.

Do not, under any circumstances, remove the power supply cord ground plug.

**ELECTRICAL GROUND IS REQUIRED ON THIS APPLIANCE.**

A three-wire, single-phase 60 hertz AC only electrical supply is required.

A separate electrical supply is required on a separately fused circuit. Do not fuse ground-neutral.

See Chart B for receptacle voltage requirements, proper fuse size, wire and wiring connections which must conform with rating of the appliance. Do not use an extension cord.

**Chart-B**

PLUG AND RECEPTACLE DATA	RECEPTACLE VOLTAGE (60 HERTZ AC IN ALL INSTANCES)	SERIAL PLATE AMPERES
	MODEL WITH SERIAL PLATE OF 230 VOLTS (207 MIN, 253 MAX.) MODEL WITH SERIAL PLATE OF 230/208 VOLTS (197.8 MIN, 253 MAX.)	up through 12.0
USE TIME-DELAY FUSE OR TIME DELAY CIRCUIT BREAKER RATING IN AMPS	MINIMUM RECEPTACLE WIRE SIZE SEE BELOW	TYPE OF BRANCH CIRCUIT
	14 GAUGE USE COPPER WIRE ONLY	SINGLE OUTLET ONLY

# RECEPTACLE WIRING

RECEPTACLE WIRING should be at least as large as size shown on electrical Chart B. Use copper wire only. It is the personal responsibility and obligation of the customer to provide proper and adequate receptacle wiring installed by a qualified electrician. **OBSERVE NATIONAL ELECTRICAL CODE AND ALL LOCAL GOVERNING CODES AND ORDINANCES.**

## RECOMMENDED GROUNDING METHOD

For your personal safety, this appliance must be grounded. This appliance is equipped with a power supply cord having a 3-prong grounding plug. To minimize possible shock hazard, the cord must be plugged into a mating 3-prong grounding type wall receptacle, grounded in accordance with the National Electrical Code and local codes and ordinances. If a mating wall receptacle is not available, it is the personal responsibility and obligation of the customer to have a properly grounded 3-prong wall receptacle installed by a qualified electrician.

# C ELECTRICAL REQUIREMENTS

For 230 volt and 230/208 volt models with serial plate amperes up through 16.0

Refer to Chart C for specific wiring and receptacle information to be used.

**OBSERVE ALL LOCAL GOVERNING CODES AND ORDINANCES.**

Do not, under any circumstances, remove the power supply cord ground plug.



**ELECTRICAL GROUND IS REQUIRED ON THIS APPLIANCE.**

A three-wire, single-phase 60 hertz AC only electrical supply is required.

A separate electrical supply is required on a separately fused circuit. Do not fuse ground-neutral.

See Chart C for receptacle voltage requirements, proper fuse size, wire and wiring connections which must conform with rating of the appliance. **Do not use an extension cord.**

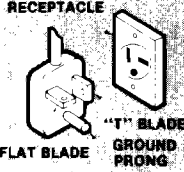
Chart-C

PLUG AND RECEPTACLE DATA	RECEPTACLE VOLTAGE (60 HERTZ AC IN ALL INSTANCES)	SERIAL PLATE AMPERES
	MODEL WITH SERIAL PLATE OF 230 VOLTS (207 MIN. 253 MAX.) MODEL WITH SERIAL PLATE OF 230/208 VOLTS (197.6 MIN. 253 MAX.)	up through 16.0
	USE TIME-DELAY FUSE OR TIME DELAY CIRCUIT BREAKER RATING IN AMPS 20	MINIMUM RECEPTACLE WIRE SIZE 12 GAUGE USE COPPER WIRE ONLY
		TYPE OF BRANCH CIRCUIT SINGLE OUTLET ONLY

# RECEPTACLE WIRING

RECEPTACLE WIRING should be at least as large as size shown on electrical Chart C. Use copper wire only. It is the personal responsibility and obligation of the customer to provide proper and adequate receptacle wiring installed by a qualified electrician. **OBSERVE NATIONAL ELECTRICAL CODE AND ALL LOCAL GOVERNING CODES AND ORDINANCES.**

## RECOMMENDED GROUNDING METHOD

For your personal safety, this appliance must be grounded. This appliance is equipped with a power supply cord having a 3-prong grounding plug. To minimize possible shock hazard, the cord must be plugged into a mating 3-prong grounding type wall receptacle, grounded in accordance with the National Electrical Code and local codes and ordinances. If a mating wall receptacle is not available, it is the personal responsibility and obligation of the customer to have a properly grounded 3-prong wall receptacle installed by a qualified electrician.

# D ELECTRICAL REQUIREMENTS

For 230 volt and 230/208 volt models with serial plate amperes up through 24.0

Refer to Chart D for specific wiring and receptacle information to be used.

OBSERVE ALL LOCAL GOVERNING CODES AND ORDINANCES.

Do not, under any circumstances, remove the power supply cord ground plug.



**ELECTRICAL GROUND IS REQUIRED ON THIS APPLIANCE.**

A three-wire, single-phase 60 hertz AC only electrical supply is required.

A separate electrical supply is required on a separately fused circuit. Do not fuse ground-neutral.

See Chart D for receptacle voltage requirements, proper fuse size, wire and wiring connections which must conform with rating of the appliance. **Do not use an extension cord.**

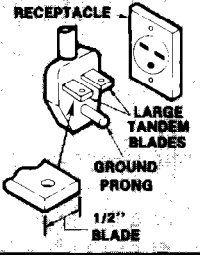
## Chart-D

PLUG AND RECEPTACLE DATA	RECEPTACLE VOLTAGE (60 HERTZ AC IN ALL INSTANCES)	SERIAL PLATE AMPERES
	MODEL WITH SERIAL PLATE OF 230 VOLTS (207 MIN, 253 MAX.)	up through 24.0
	MODEL WITH SERIAL PLATE OF 230/208 VOLTS (197.6 MIN - 253 MAX.)	
USE TIME-DELAY FUSE OR TIME DELAY CIRCUIT BREAKER RATING IN AMPS	MINIMUM RECEPTACLE WIRE SIZE SEE BELOW	TYPE OF BRANCH CIRCUIT
CART. TYPE ONLY  30	10 GAUGE USE COPPER WIRE ONLY	SINGLE OUTLET ONLY

## RECEPTACLE WIRING

RECEPTACLE WIRING should be at least as large as size shown on electrical Chart D. Use copper wire only. It is the personal responsibility and obligation of the customer to provide proper and adequate receptacle wiring installed by a qualified electrician. OBSERVE NATIONAL ELECTRICAL CODE AND ALL LOCAL GOVERNING CODES AND ORDINANCES.

## RECOMMENDED GROUNDING METHOD

For your personal safety, this appliance must be grounded. This appliance is equipped with a power supply cord having a 3-prong grounding plug. To minimize possible shock hazard, the cord must be plugged into a mating 3-prong grounding type wall receptacle, grounded in accordance with the National Electrical Code and local codes and ordinances. If a mating wall receptacle is not available, it is the personal responsibility and obligation of the customer to have a properly grounded 3-prong wall receptacle installed by a qualified electrician.

# INSTALLATION INSTRUCTIONS

## for Your Air Conditioner

### Through-the-wall Installation Instructions

for installing the unit in a pre-installed cabinet.

- It is the personal responsibility and obligation of the customer to have this product installed by qualified technicians familiar with Through-the-wall Room Air Conditioner Installations.
- To help avoid any installation problems and to help assure trouble-free performance of your new air conditioner, read these installation instructions, as well as the operating instructions and electrical requirements **before** installing your unit.
- Because this air conditioner weighs from approximately 125 to 200 pounds, it is recommended that you have somebody help you install your new unit and that you both use proper lifting techniques to avoid personal injury.
- Inspect the condition of the wall where the air conditioner will be installed. Be sure it will support the weight of the unit.

### CAUTION:

- Be sure air conditioner does not fall during installation.
- Handle the air conditioner with care. Watch out for the sharp metal fins on the front and rear coils.
- Do not use the water condensate for drinking purposes. It is not sanitary.



THIS APPLIANCE MUST BE  
INSTALLED ACCORDING TO  
ALL APPLICABLE CODES  
AND ORDINANCES

1. Unpack accessory parts (see Figure 3) before installing your air conditioner.

Figure 3

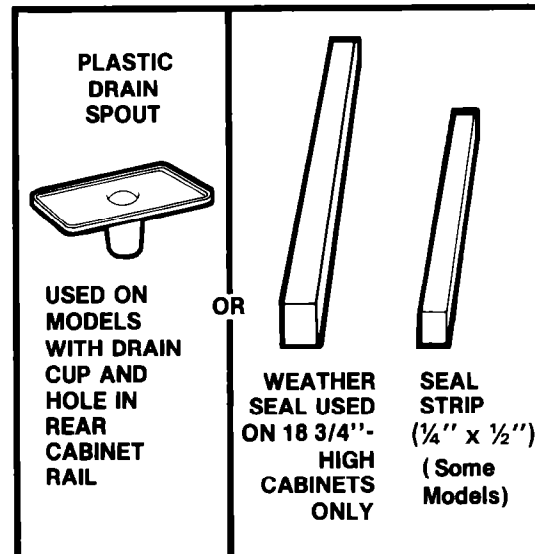

2. Pick the right wall. First, decide what room(s) you want to cool. Then choose a wall that will allow the air-conditioned air to flow freely and directly into the room(s) you want cooled. Remember, it's difficult to move air around corners. Choose a location that's also near an electrical outlet. (Refer to ELECTRICAL REQUIREMENTS for receptacle and wiring needed.) Do not use an extension cord. (CAUTION: DO NOT LOCATE AIR CONDITIONER WHERE PLASTIC CABINET FRONT WILL BE EXPOSED TO A HEAT SOURCE THAT RAISES THE SURFACE TEMPERATURE IN EXCESS OF 120° F.)

- Choose the type of decorative molding you want to use around the room side of the cabinet. Your choice affects the finish frame alignment with the inside wall. When using a wood, metal or plastic molding, the finish frame should almost line up with the inside wall. If the wall is plastered to the cabinet and no molding is used, the finish frame must be set into the wall by 1/2" (see Figure 4 for frame construction or Figure 5 for brick veneer construction). Cut through two studs for support.

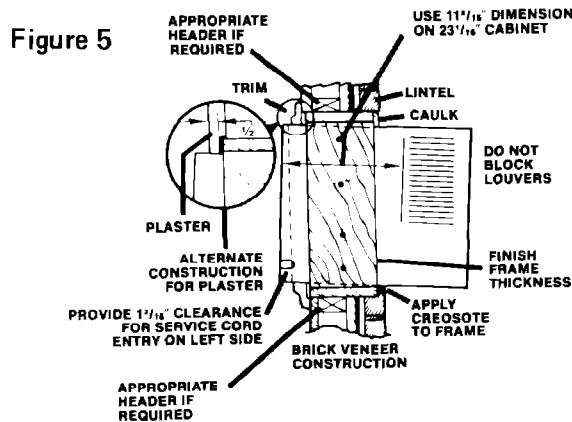
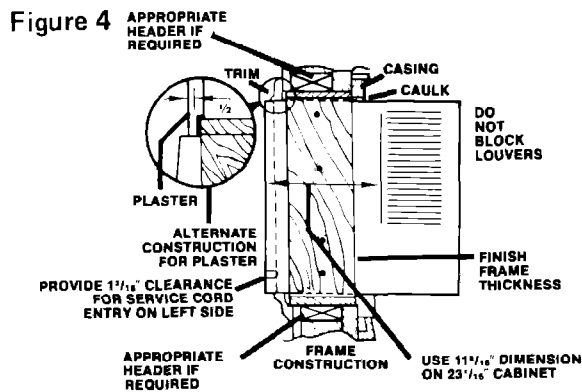

- Provide an opening through the wall for a finish frame. Observe all local governing codes and ordinances. For wall opening dimensions, use those shown in Figure 6 and add wood frame thickness (use 1" lumber or heavier). When determining finish frame thickness, be sure you do not cover side cabinet louvers. A 4" minimum clearance between side cabinet louvers and adjoining wall allows for proper airflow into air conditioner.

**Figure 6**

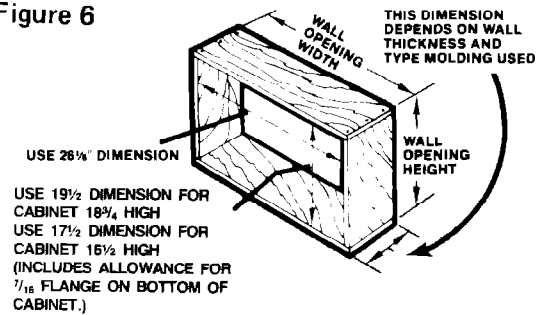

- Construct finish frame. Apply creosote or something equal to the outside exposed surface.
- Install the finish frame in the wall opening. Square and level frame and nail it securely to the studs.
- Remove front panel by pushing top down and out. This protects the panel from damage and makes the air conditioner easier to handle during installation (see Figure 7).

**Figure 7**

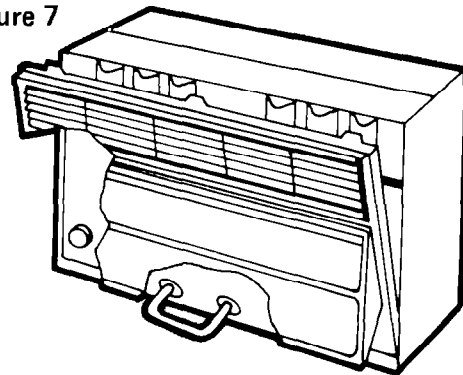

- Slide unit out of cabinet. First, disconnect the green ground wire at the left-front corner of base unit by removing retaining screw (save screw for reuse later). Now slide unit out of cabinet by pulling on handle at bottom (see Figure 7).
- Insert exterior cabinet through wall opening. Leave 1-3/16" minimum projection into the room at service cord exit hole in cabinet, after allowing for trim. For proper outward water drainage, shim or reposition cabinet to provide the proper downward tilt to the outside (1/2" bubble or 1/4" and side-to-side leveling).
- Fill all spaces between cabinet and finish frame with insulation.



**11.** Drill holes in the cabinet and attach it securely to finish frame. Use ten #10 x 1" wood screws (four screws for each side and two screws for the top; not included). Do not overtighten screws or cabinet will distort and provide a poor air seal between cabinet and unit.

**12.** Insert plastic drain-cup spout and metal holder (on certain models) into hole at rear of cabinet, as shown in Figure 8. Spout should be facing downward through hole. OPTIONAL: During high humidity, condensate may drip from the outside of your air conditioner onto the ground below. If your air conditioner is installed where this is undesirable, you can direct the water to a more suitable spot by simply attaching a 5/8" inside-diameter, thin walled hose to the drain spout at rear of cabinet (see Figure 9). On models without plastic drain cup spout, use flashing as needed to guide water.

Note the type of drain parts you have. Insert drain cup according to instructions in Figure 8.

Figure 8

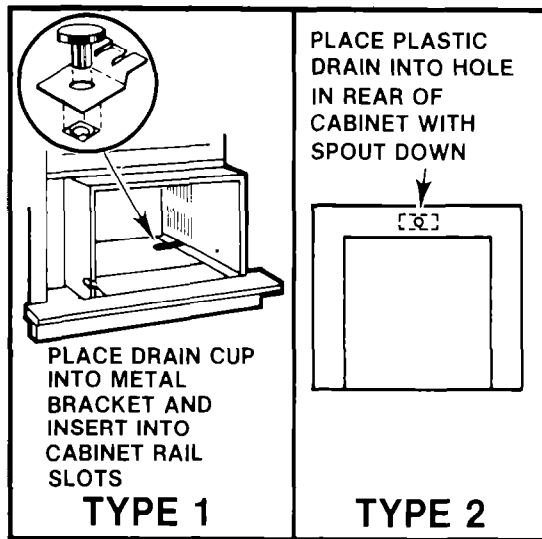
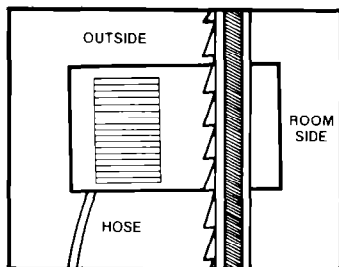
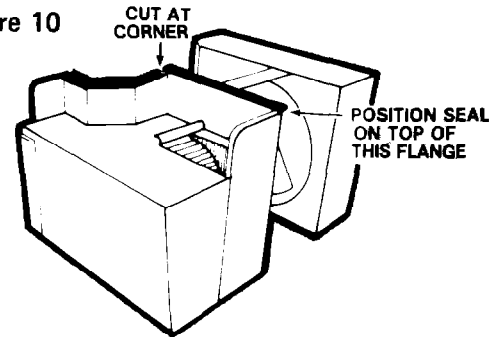

Figure 9



**13.** If you received one adhesive-backed seal strip (1/4" x 1/2"), remove paper backing from seal and install on air conditioner as shown in Figure 10.

Figure 10



**14.** Insert air conditioner into cabinet. Do not push against sharp fins and plastic parts. Attach green ground wire to the left-front corner of unit base by using retainer screw (see Figure 11).

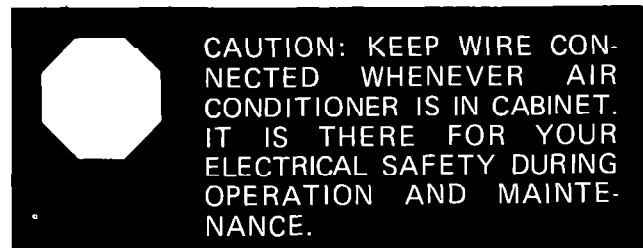

Figure 11

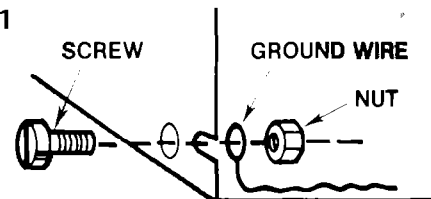
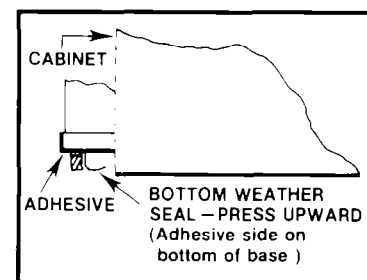

Figure 12



**15.** For installation of bottom weather seal on unit with 18 3/4"-high cabinet, see Figure 12.

**16.** Attach front, by placing bottom edge on clips and pushing top down, then in and up.

**17.** Caulk all outside wall openings around cabinet.

**18.** If needed, install molding around room side of cabinet.

# HOW TO START AND USE YOUR AIR CONDITIONER

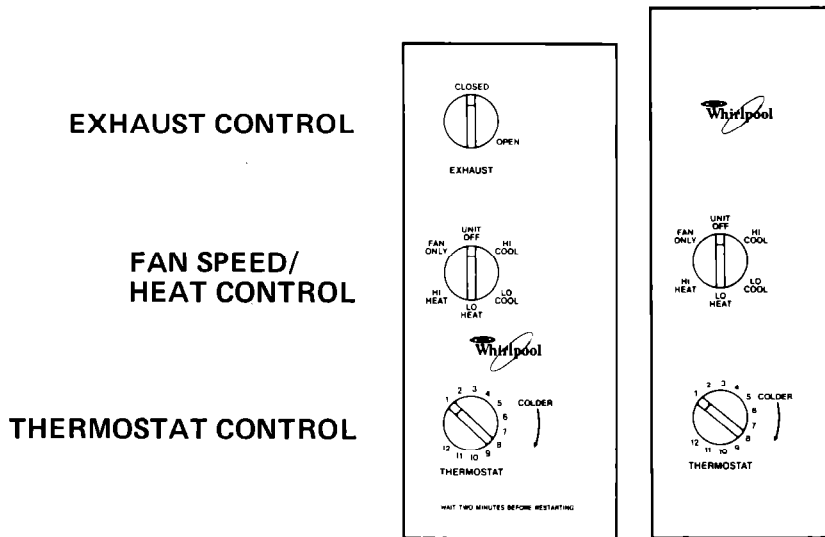

Be sure air conditioner is OFF before plugging it in.

## To Start Your Air Conditioner

1. **Set exhaust control** (if your unit is so equipped) to OFF for maximum cooling or heating results.
2. **Choose a fan speed setting** for cooling or heating.  
 LO COOL . . . . . for sleeping comfort.  
 HI COOL . . . . . for maximum cooling.  
 LO HEAT for reduced air movement with heat.  
 HI HEAT for maximum air movement with heat.
3. **Turn thermostat control** to Number 6 (mid-setting). You can adjust the air conditioner's performance by resetting the thermostat control to a higher number for maximum cooling. Lower the number setting for maximum heating. You will need to experiment to find the settings which suit you best.

When lowering the thermostat control setting, the compressor (motor) may shut off. When the compressor is turned off with either the fan speed control or the thermostat control, wait 2-3 minutes before restarting the air conditioner or, turning the compressor back on.

### IMPORTANT:

- Air conditioners come equipped with two types of heater units. Check your model number, located on the SERIAL PLATE (see page 2) to see which type you have.
- If the model number of your unit begins with "ACH", it is recommended that you **DO NOT USE** the heating cycle if the outdoor temperature falls below 45°F.
- If the model number of your unit begins with "ACE" or "ACR", it can safely be used for heating even when outdoor temperatures fall below freezing.

## Using the Exhaust Control

(on some models)

The Exhaust Control setting draws stale or smoky air from the room.

### 1. To exhaust room air

Set exhaust control to OPEN. Adjust fan control to speed desired. If no cooling is desired, use FAN ONLY setting.

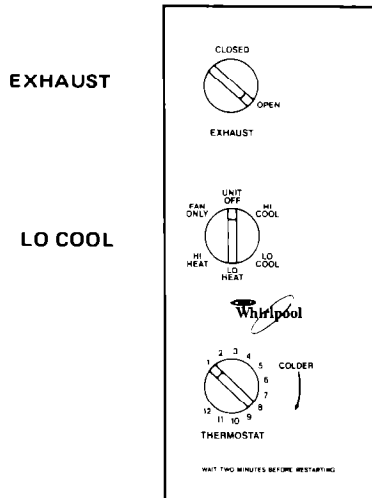

### 2. To circulate room air

Set exhaust control to CLOSED. Adjust fan control to FAN ONLY.

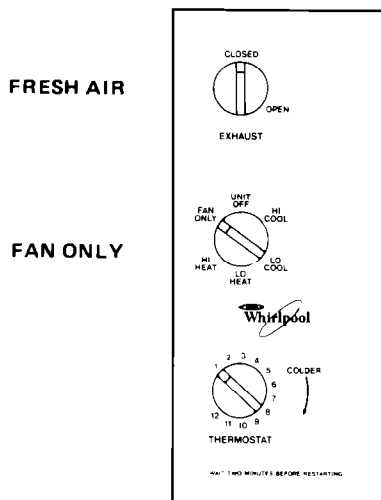

## Changing Air Direction

The louvers in the grille area at the top of the air conditioner control the direction of the cooled air.

1. Move the tabs at the bottom of the grille to the right, left or straight ahead. Simply move the tabs in the direction you want the air to go (see Figure 13).

2. On most models, the louvers can only be adjusted left or right. The front set is fixed and directed upward.

3. On some models, air flow can be directed up or down. Move the tab in the center louver to direct air.

Figure 13

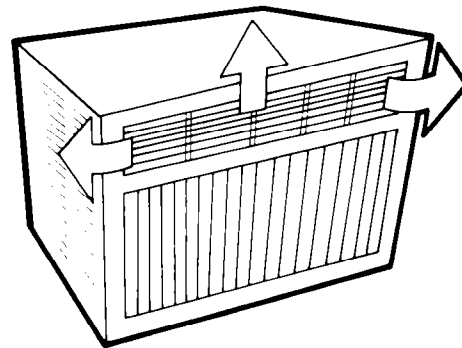

---

## Cleaning and Caring For Your Air Conditioner

Proper use and care of your air conditioner will help insure longer life and lower operating costs. Follow these instructions carefully. Call your dealer for an annual checkup.

### Cleaning of Front Panel



1. Remove the front panel from unit when cleaning. Press down at top edge of the front as shown in Figure 14.
2. When the front moves away from top of cabinet, pull top of front toward you.
3. Lift up and away from the bottom spring clips.

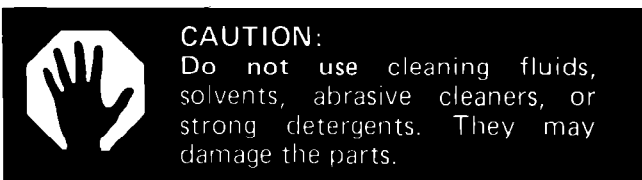
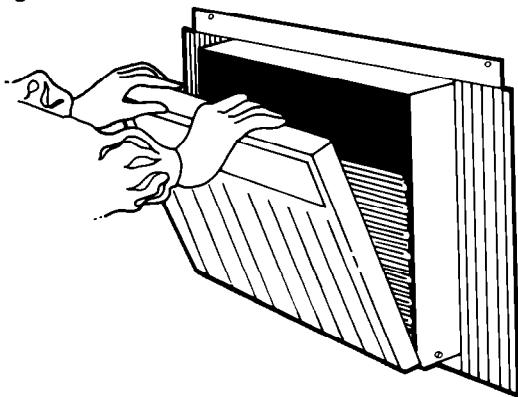

Figure 14



4. Clean front panel with warm water and mild soap or detergent. Use a soft cloth. Rinse and dry. Replace front panel.

5. Wipe control panel clean with a soft dry cloth.

### Cleaning Air Conditioner Filter

The filter is cleanable. A clean filter helps remove dust, lint and other particles from the air. Check every two weeks to see if filter needs cleaning.

1. Remove filter from plastic front frame, by removing elastic band which holds it in place (see Figure 15).
2. Clean filter, using a vacuum cleaner.  
— or —
3. If very dirty, wash filter with warm water and mild detergent. Air dry thoroughly before replacing.

Figure 15

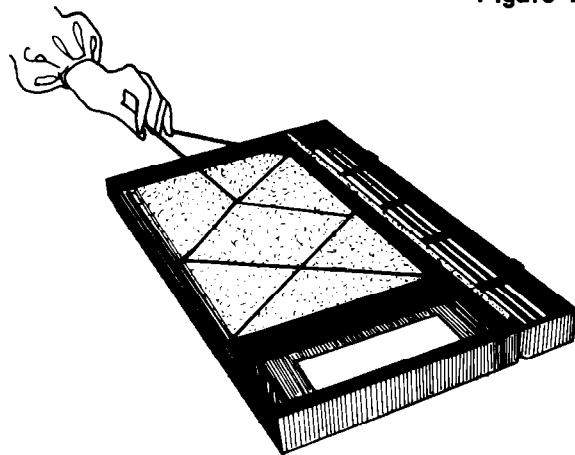

---

## Annual Maintenance for Your Air Conditioner

Your air conditioner needs annual maintenance to help insure steady, top performance throughout the year.

Call the service company recommended by your dealer to:

- Inspect and clean the coils and condensate water passages.
- Check fan and oil the fan motor.
- The compressor is sealed and needs no oiling.

Expense of annual inspection is customer's responsibility.

— or —

If you are familiar with electrical appliances, you can do the cleaning and maintenance yourself. If you decide to go ahead, follow these steps:



### CAUTION:

Be sure no liquid gets into the motor, electrical control box or compressor electrical terminals.



### WARNING:

**SHOCK OR INJURY HAZARD** - Before performing any maintenance, be sure to disconnect power cord from receptacle.

- 1. REMOVE UNIT FROM CABINET.** Wrap the motor, electrical control box and electrical terminals box in plastic film and make sure no water or other liquid gets inside any of these parts. It could damage the insulation and cause serious trouble.
- 2.** Carefully clean and hose out the base, coils and condensate pans. Clean at least once a year or more often, if the condenser coils and pans collect dirt, sand, leaves, insects or algae. Also, clean if you detect an odor from the air conditioner. While the cabinet is open, this is a good time to oil the fan motor.

- 3.** Remove plastic film from motor and electrical parts.
- 4.** Replace unit in cabinet.

**NOTE:** It's a good idea to wait 24 hours before starting the unit again. This allows time for all areas to dry out. The water from rainfall or from normal operation does not harm these components.

## Oiling of the Fan Motor

### WARNING:



**SHOCK OR INJURY HAZARD** - Before performing any maintenance, be sure to disconnect power cord from receptacle.

- 1.** Oil the fan motor per instructions on the motor. To add oil, pull out the oil hole plug at each end of the motor (See Figure 16).

Figure 16

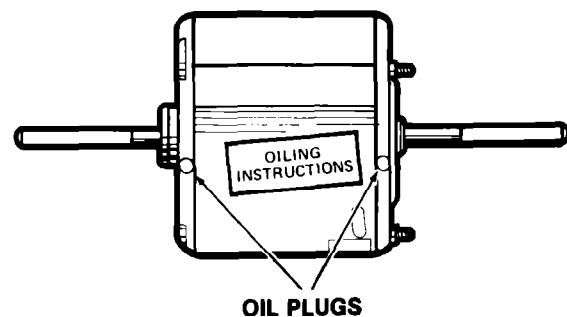

An easy to use one-ounce capsule of especially recommended oil (Part No. 10943) can be ordered from your dealer, or use SAE #20 non-detergent oil.

- 2.** Replace the plug to keep dirt from motor bearings.
- 3.** Reinstall unit in cabinet after performing maintenance.

# COOLING LOAD GUIDE—SQUARE FEET METHOD

## ROOM AIR CONDITIONERS

To make sure you choose the right size unit, use this "COOLING LOAD GUIDE — SQUARE FEET METHOD." It is a quick, easy means of computing capacity.

For extremes in exposure, shading, insulation and building construction, AHAM Cooling Load Estimate Form RAC-1 must be used.

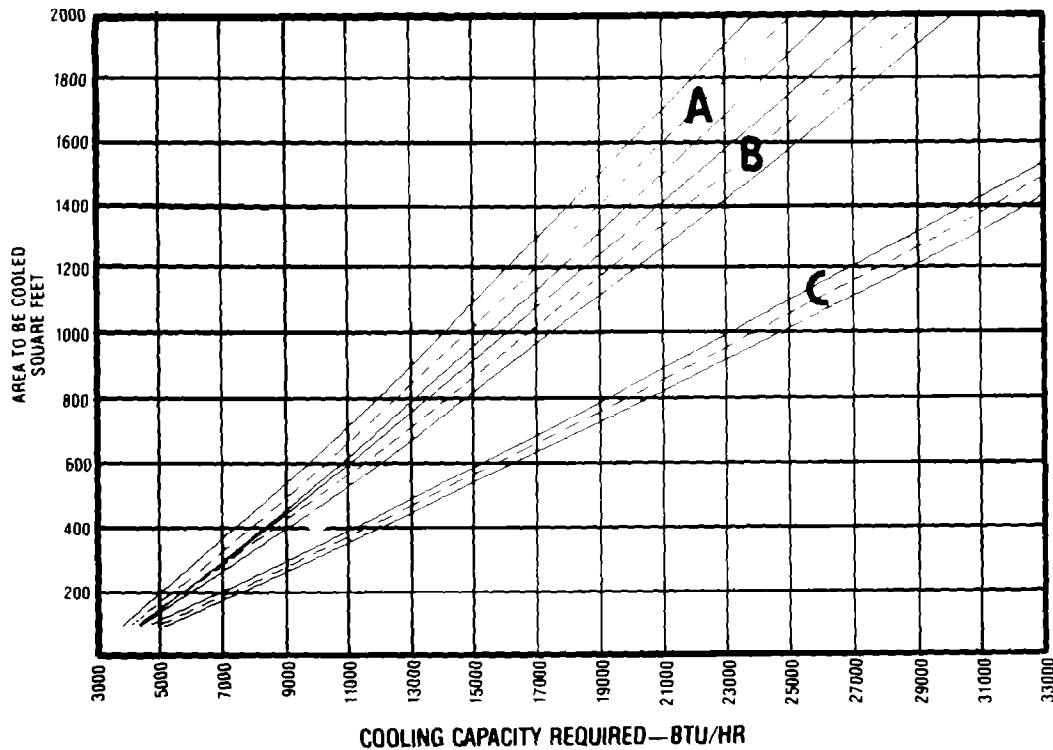

### INSTRUCTIONS:

1. Determine the area to be cooled in square feet and locate that point on the left side of chart.
2. Move horizontally across to the center line of Band A, B or C according to the condition of the ceiling in the area to be cooled.  
**Band A**—Occupied Space Above Ceiling  
**Band B**—Insulated Ceiling Under Attic  
**Band C**—Non-Insulated Ceiling Under Attic
3. From center of band move within the band to left for more northerly exposure or right for more westerly exposure.
4. From this point, read down to bottom of chart to determine required Btu/hr output. Write the Btu/hr figure in the space indicated below.

5. \_\_\_\_\_ Btu/hr (from number 4 above).
6. \_\_\_\_\_ Locate your geographic area on inset map and multiply factor shown by figure in number 5.
7. \_\_\_\_\_ If room air conditioner is intended primarily for night-time cooling, subtract 30% (from figure in number 6).
8. \_\_\_\_\_ Subtract 30 Btu/hr from figure in number 7 (or 6) for each linear foot of wall separating the area to be cooled from another cooled room.
9. \_\_\_\_\_ If more than two people occupy area, add 600 Btu/hr per person (to figure in number 8); if only one person, subtract 600 Btu/hr.
10. \_\_\_\_\_ Add 4000 Btu/hr (to figure in number 9) if area to be cooled includes kitchen.

For best results, a room conditioning unit or units with a cooling capacity rating close to that estimated above should be selected.

A smaller capacity unit operating continuously will contribute more to comfort than a larger capacity unit operating intermittently.

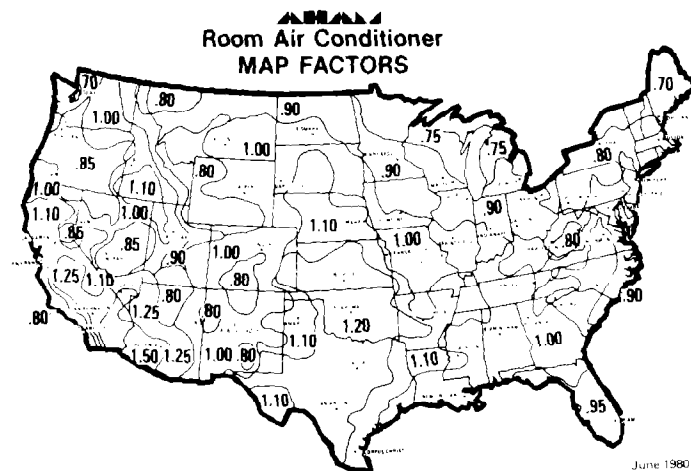

June 1960

# If you need service or assistance, we suggest you follow these five steps:

## 1. Before calling for assistance

Performance problems often result from little things you can find and fix yourself without tools of any kind.

### Air conditioner won't run

1. Is unit plugged into a live circuit with proper voltage?
2. Is switch turned on?
3. Is thermostat set correctly?
4. Have you checked your home's main fuses or circuit breaker box?
5. Has the time-delay fuse blown?
6. Has the local power failed?

### Unit blows fuses:

1. Are time-delay fuses being used?
2. Is an extension cord being used? (**Do not use an extension cord to run your air conditioner.**)
3. Are you waiting two minutes after turning cooling circuit off before trying to restart unit?

### Unit turns on and off, or does not cool room:

1. Is filter clean?
2. Are coils clean (both evaporator [inside] and condenser [outside])?
3. Is there excessive moisture or heat (open vessel cooking, showers, etc.)?
4. Try setting fan to higher speed.
5. Try setting thermostat to a cooler setting.

### Operating sounds:

1. When your room air conditioner is **operating normally**, you will hear sounds such as:
  - Droplets of water hitting the condenser, causing a "pinging" or "clicking" sound. Water droplets help to cool the condenser.
  - Air movement from the fan, especially on high fan speed setting.
  - Clicks from the thermostat cycle.
2. Sounds also may be caused by house construction - such as vibration of the unit due to wall construction or unsteady window mounting area.

## 2. If you need assistance\*...

Call Whirlpool COOL-LINE® service assistance telephone number. Dial free from anywhere in the U.S.:  
**1-800-253-1301**

and talk with one of our trained Consultants. The consultant can instruct you in how to obtain satisfactory operation from your appliance or, if service is necessary, recommend a qualified service company in your area.

## 3. If you need service\*...



Whirlpool has a nationwide network of franchised TECH-CARE® service Companies. TECH-CARE service technicians are trained to fulfill the product warranty and provide after-warranty service, anywhere in the United States. To

locate TECH-CARE service in your area. Call our COOL-LINE service assistance telephone number (see Step 2) or look in your telephone directory Yellow Pages under:

APPLIANCES - HOUSEHOLD — MAJOR - SERVICE & REPAIR		ELECTRICAL APPLIANCES — MAJOR - REPAIRING & PARTS
WHIRLPOOL APPLIANCES FRANCHISED TECH-CARE SERVICE SERVICE COMPANIES	OR	WHIRLPOOL APPLIANCES FRANCHISED TECH-CARE SERVICE SERVICE COMPANIES
XYZ SERVICE CO. 123 Maple ..... 999-9999		XYZ SERVICE CO. 123 Maple ..... 999-9999
OR		
WASHING MACHINES, DRYERS & IRONERS - SERVICING		
WHIRLPOOL APPLIANCES FRANCHISED TECH-CARE SERVICE SERVICE COMPANIES		
XYZ SERVICE CO. 123 Maple ..... 999-9999		

## 4. If you have a problem\*...

Call our COOL-LINE service assistance telephone number (see Step 2) and talk with one of our Consultants, or if you prefer, write to:

Mr. Robert Stanley  
Division Vice President  
Whirlpool Corporation  
2000 M 63  
Benton Harbor, MI 49022

## 5. If you need FSP® replacement parts\*...



FSP is a registered trademark of Whirlpool Corporation for quality parts. Look for this symbol of quality whenever you need a replacement part for your Whirlpool appliance. FSP replacement parts will fit right and work right, because they are made to the same exacting specifications used to build every new Whirlpool appliance.

To locate FSP replacement parts in your area, refer to Step 3 above or call the Whirlpool COOL-LINE service assistance number in Step 2.

\*If you must call or write, please provide: **model number, serial number, date of purchase, and a complete description of the problem.** This information is needed in order to better respond to your request for assistance.

# WHIRLPOOL ROOM AIR CONDITIONER WARRANTY

LENGTH OF WARRANTY	WHIRLPOOL WILL PAY FOR								
<b>FULL ONE-YEAR WARRANTY</b> From Date of Purchase	FSP® replacement parts and repair labor to correct defects in materials or workmanship.								
<b>FULL FIVE-YEAR WARRANTY</b> From Date of Purchase	FSP replacement parts and repair labor to correct defects in materials or workmanship in the sealed refrigeration system. These parts are: <table style="margin-left: 40px; border: none;"> <tr> <td style="padding-right: 20px;">1. Compressor</td> <td>4. Drier-Strainer</td> </tr> <tr> <td>2. Evaporator</td> <td>5. Connecting tubing</td> </tr> <tr> <td>3. Condenser</td> <td></td> </tr> </table>	1. Compressor	4. Drier-Strainer	2. Evaporator	5. Connecting tubing	3. Condenser			
1. Compressor	4. Drier-Strainer								
2. Evaporator	5. Connecting tubing								
3. Condenser									
<b>WHIRLPOOL WILL NOT PAY FOR</b>									
<table style="border: none;"> <tr> <td style="padding-left: 10px;"><b>A. Service calls to:</b></td> </tr> <tr> <td style="padding-left: 20px;">1. Correct the installation of the air conditioner.</td> </tr> <tr> <td style="padding-left: 20px;">2. Instruct you how to use the air conditioner.</td> </tr> <tr> <td style="padding-left: 20px;">3. Replace house fuses or correct house wiring.</td> </tr> <tr> <td style="padding-left: 20px;">4. Clean or replace air filter.</td> </tr> <tr> <td style="padding-left: 10px;"><b>B. Pick up and delivery.</b> This product is designed to be repaired in the home.</td> </tr> <tr> <td style="padding-left: 10px;"><b>C. Damage to the air conditioner caused by accident, misuse, fire, flood, acts of God or use of products not approved by Whirlpool.</b></td> </tr> <tr> <td style="padding-left: 10px;"><b>D. The removal and reinstallation of the air conditioner if it is installed in an overhead or other inaccessible location or not installed in accordance with published installation instructions.</b></td> </tr> </table>		<b>A. Service calls to:</b>	1. Correct the installation of the air conditioner.	2. Instruct you how to use the air conditioner.	3. Replace house fuses or correct house wiring.	4. Clean or replace air filter.	<b>B. Pick up and delivery.</b> This product is designed to be repaired in the home.	<b>C. Damage to the air conditioner caused by accident, misuse, fire, flood, acts of God or use of products not approved by Whirlpool.</b>	<b>D. The removal and reinstallation of the air conditioner if it is installed in an overhead or other inaccessible location or not installed in accordance with published installation instructions.</b>
<b>A. Service calls to:</b>									
1. Correct the installation of the air conditioner.									
2. Instruct you how to use the air conditioner.									
3. Replace house fuses or correct house wiring.									
4. Clean or replace air filter.									
<b>B. Pick up and delivery.</b> This product is designed to be repaired in the home.									
<b>C. Damage to the air conditioner caused by accident, misuse, fire, flood, acts of God or use of products not approved by Whirlpool.</b>									
<b>D. The removal and reinstallation of the air conditioner if it is installed in an overhead or other inaccessible location or not installed in accordance with published installation instructions.</b>									

Service under the full warranties must be provided by a franchised TECH-CARE® service company.

WHIRLPOOL CORPORATION SHALL NOT BE LIABLE FOR INCIDENTAL OR CONSEQUENTIAL DAMAGES. Some states do not allow the exclusion or limitation of incidental or consequential damages so this limitation or exclusion may not apply to you. This warranty gives you specific legal rights, and you may also have other rights which vary from state to state.

Outside the United States, a different warranty may apply. For details, please contact your franchised Whirlpool distributor or military exchange.



Making your world a little easier.