

User Manual

September 2007 Revision 1.1



Kiosk Hardware System



P/N: 48201201

Copyright 2007 Sep.
All Rights Reserved
Manual Version 1.1

The information contained in this document is subject to change without notice. We make no warranty of any kind with regard to this material, including, but not limited to, the implied warranties of merchantability and fitness for a particular purpose. We shall not be liable for errors contained herein or for incidental or consequential damages in connection with the furnishing, performance, or use of this material.

This document contains proprietary information that is protected by copyright. All rights are reserved. No part of this document may be photocopied, reproduced or translated to another language without the prior written consent of the manufacturer.

TRADEMARK

Intel®, Pentium® and MMX are registered trademarks of Intel® Corporation. Microsoft® and Windows® are registered trademarks of Microsoft Corporation. ELO Touch is the registered trademark of ELO Touch Systems.

Safety

IMPORTANT SAFETY INSTRUCTIONS

1. To disconnect the machine from the electrical power supply, turn off the power switch and remove the power cord plug from the wall socket. The wall socket must be easily accessible and in close proximity to the machine.
2. Read these instructions carefully. Save these instructions for future reference.
3. Follow all warnings and instructions marked on the product.
4. Do not use this product near water.
5. Do not place this product on an unstable cart, stand, or table. The product may fall, causing serious damage to the product.
6. Slots and openings in the cabinet and the back or bottom are provided for ventilation; to ensure reliable operation of the product and to protect it from overheating. These openings must not be blocked or covered. The openings should never be blocked by placing the product on a bed, sofa, rug, or other similar surface. This product should never be placed near or over a radiator or heat register, or in a built-in installation unless proper ventilation is provided.
7. This product should be operated from the type of power indicated on the marking label. If you are not sure of the type of power available, consult your dealer or local power company.
8. Do not allow anything to rest on the power cord. Do not locate this product where persons will walk on the cord.
9. Never push objects of any kind into this product through cabinet slots as they may touch dangerous voltage points or short out parts that could result in a fire or electric shock. Never spill liquid of any kind on the product.

CE MARK



This device complies with the requirements of the EEC directive 89/336/EEC with regard to "Electromagnetic compatibility" and 73/23/EEC "Low Voltage Directive".

FCC

This device complies with part 15 of the FCC rules. Operation is subject to the following two conditions:

- (1) This device may not cause harmful interference
- (2) This device must accept any interference received, including interference that may cause undesired operation.

CAUTION ON LITHIUM BATTERIES

There is a danger of explosion if the battery is replaced incorrectly. Replace only with the same or equivalent type recommended by the manufacturer. Discard used batteries according to the manufacturer's instructions.

LEGISLATION AND WEEE SYMBOL

2002/96/EC Waste Electrical and Electronic Equipment Directive on the treatment, collection, recycling and disposal of electric and electronic devices and their components.



The crossed dustbin symbol on the device means that it should not be disposed of with other household wastes at the end of its working life. Instead, the device should be taken to the waste collection centers for activation of the treatment, collection, recycling and disposal procedure.

To prevent possible harm to the environment or human health from uncontrolled waste disposal, please separate this from other types of wastes and recycle it responsibly to promote the sustainable reuse of material resources.

Household users should contact either the retailer where they purchased this product, or their local government office, for details of where and how they can take this item for environmentally safe recycling.

Business users should contact their supplier and check the terms and conditions of the purchase contract.

This product should not be mixed with other commercial wastes for disposal.

Revision History

Revision Number	Description	Revision Date
1.0	Initial Release.	2006 September
1.1	Cover page updated	2007 September

Table of Contents

1. Item Checklist	6
1.1. Standard Items	6
1.2. Optional Items	7
2. System View	8
2.1. Front View	8
2.2. Side View	9
2.3. Rear View.....	10
3. Driver Installation	11
3.1. Driver List	11
3.2. Chipset Driver Installation.....	11
3.3. USB 2.0 Driver Installation	13
3.4. VGA Driver Installation	16
3.5. Audio Driver Installation.....	18
3.6. ELO Touch Driver Installation	19
3.7. POS Touch Driver Installation.....	22
3.8. 10/100Mb LAN Driver Installation.....	25
3.9. MiniPCI IEEE802.11g WLAN Driver Installation	26
3.10. FTP637 Thermal Printer Driver Installation	27
4. System Disassembly	32
4.1. Removing the HDD Drive Bracket.....	32
4.2. Replacing the HDD & Fan	33
4.3. Replacing the Mini PCI.....	34
4.4. Replacing the Power Adapter.....	35
4.5. Replacing the Speakers	36
4.6. Replacing the Motherboard	36
4.7. Replacing the Heatsink & CPU.....	38
4.8. Replacing the Side Fan	38
4.9. Replacing the LCD Panel & Touch Screen.....	39
4.10. Replacing the Touch Board & Inverter Board	42
4.11. Replacing the Laser Scanner	43
4.12. Replacing the Card Reader & Thermal Printer	43
5. Specification	45
6. Connectors and Jumper Settings	47
7. BIOS Settings	54
Appendix A - Airflow Requirements	57

1. Item Checklist

Take the system unit out of the carton. Remove the unit from the carton by holding it by the foam inserts. The following contents should be found in the carton:

1.1. Standard Items



a. System

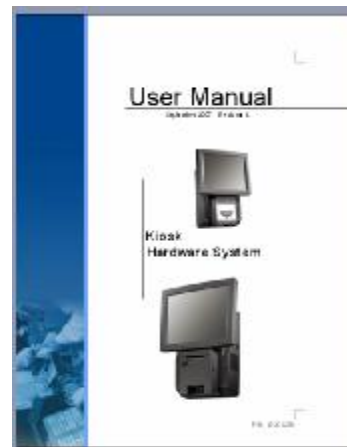

b. Manual



c. Driver CD



d. Power Cable

1.2. Optional Items



a. Omni-directional Laser Scanner



b. 3" Thermal Printer



c. Swipe Magnetic Card Reader



d. Mini PCI Wireless Card

2. System View

2.1. Front View



Swipe Magnetic Card Reader

Laser Scanner



3" Thermal Printer

Button

Insert Type Card Reader

2.2. Side View

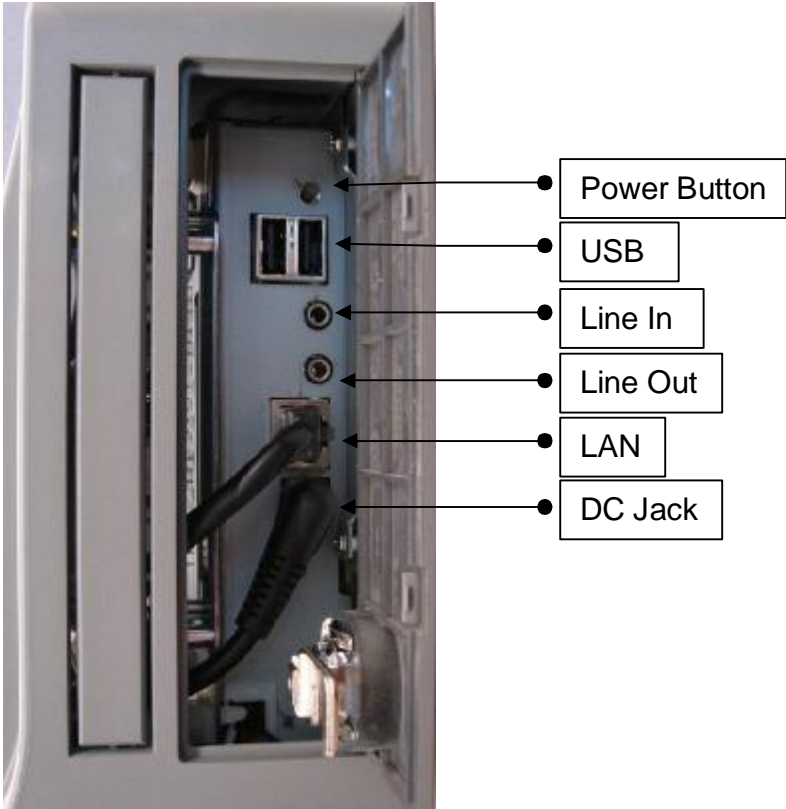

2.3. Rear View

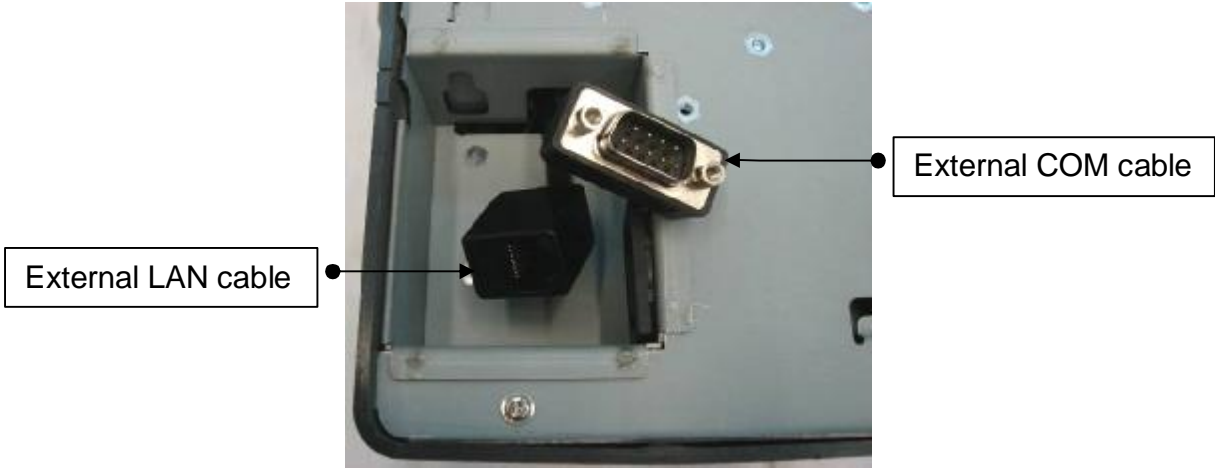

3. Driver Installation

3.1. Driver List

Folder/File	File Description
<CD>:\K81X_B76.htm	B76 Driver List
<CD>:\COMMON\INTEL\Chipset	Chipset Driver
<CD>:\COMMON\INTEL\USB 20	USB 2.0 Driver
<CD>:\COMMON\INTEL\VGA\i85x	VGA Driver
<CD>:\COMMON\Ac97_codec\Realtek\ALC202A	Audio Driver
<CD>:\COMMON\Elo_Touch	ELO Touch Driver
<CD>:\COMMON\POS_Touch	POS Touch Driver
<CD>:\COMMON\Lan_driver\R8139_810x	10/100Mb LAN Driver
<CD>:\COMMON\Wireless_LAN\802.11g\Inprocomm_IPN2220	MiniPCI IEEE802.11g Wireless LAN Driver
<CD>:\COMMON\printer\FTP637	FTP637 Thermal Printer Driver

-The following procedures are for Windows 2000/XP, other platforms are similar.

3.2. Chipset Driver Installation



a. Double click "infinst_enu_6.0.1.1002" on the My computer window.

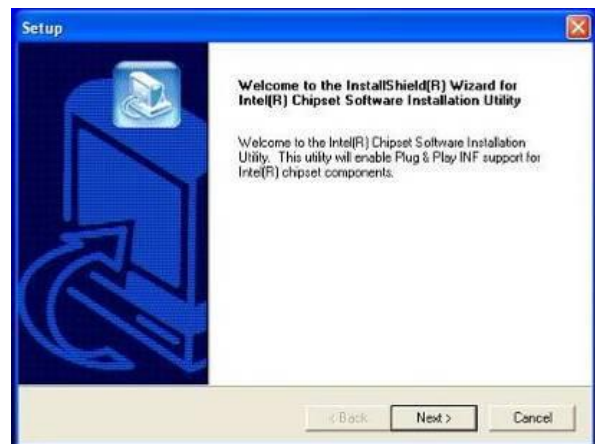

b. Click the "Next" button on the Welcome window.

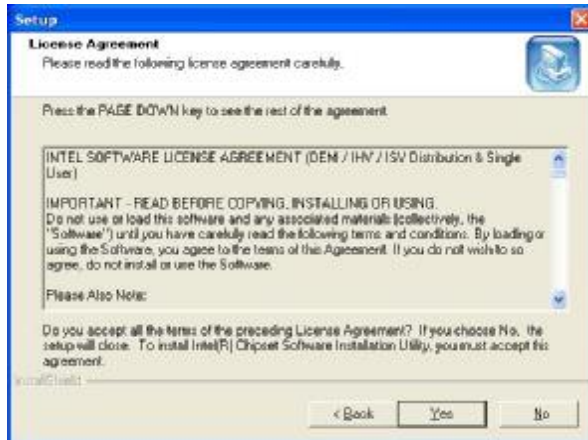

c. Click the "Yes" button on the License Agreement window.

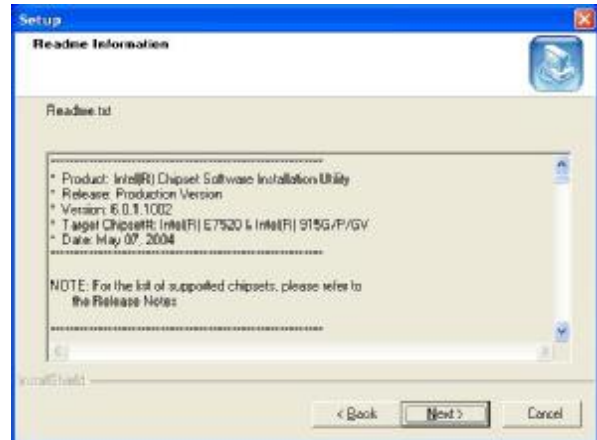

d. Click the "Next" button on the Readme Information window.

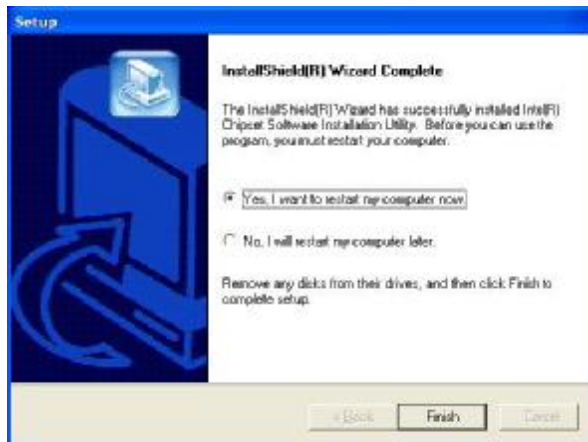

e. Click the "Finish" button and restart your system.

3.3. USB 2.0 Driver Installation

OS Requirements

OS	USB 2.0 requirements
Windows XP	USB 2.0 drivers are provided in Service Pack 1 (SP1) for Windows XP, which is available through Windows Update .
Windows 2000	USB 2.0 drivers are available through Windows Update or Service Pack 4.
Windows 98SE/Me	USB 2.0 drivers are available on the Intel developer site .
Windows 98 (Retail)	Developers and OEMs should contact Orange Ware . For end-users, if your device does not ship with Windows 98 drivers, contact your device or system manufacturer. If USB 2.0 drivers are not available, your device will operate at USB 1.1 speeds
Linux	USB 2.0 support is available in kernel 2.4.19 or later development kernels, or in the 2.4.19 or later production kernel. More information .

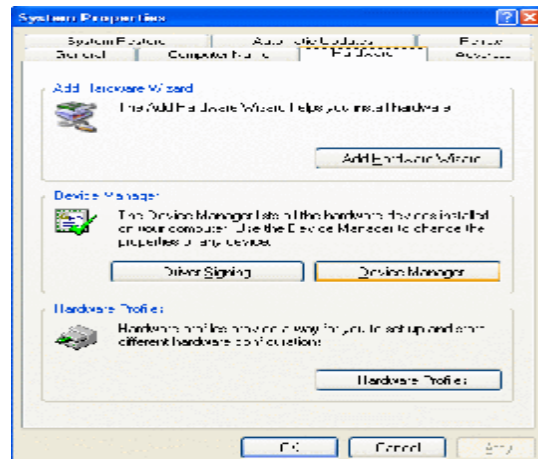
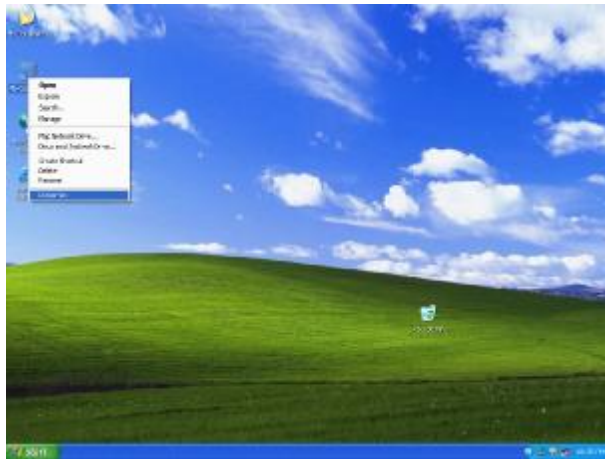

- Right click My Computer on the desktop and select "properties"
- Select "Hardware" and "Device Manager" on system properties.

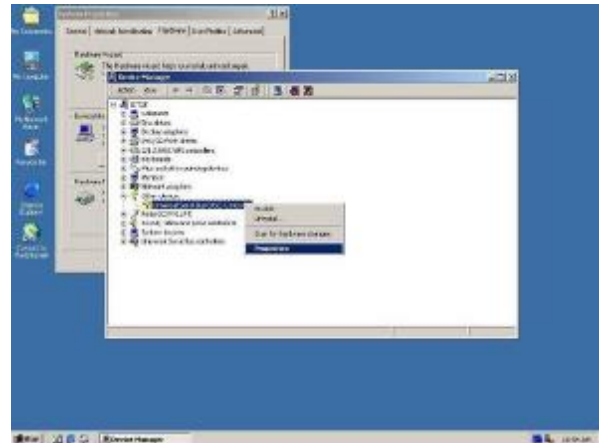
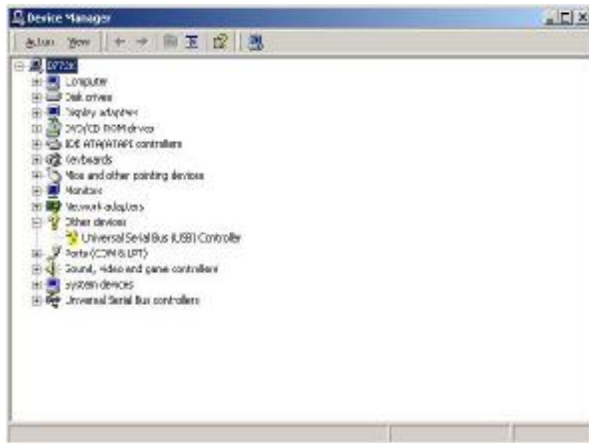

c. Select "Other Devices" à "Universal Serial Bus (USB) Controller" à "Properties" on Device Manager.



d. Select "Device" à "Update Driver...".



e. Click the "Next" button on the welcome window.



- f. Select “Search for a suitable...” and click the “Next” button on the Install Hardware Device Drivers window.



- g. Select “Specify a location” and click the “Next” button on the Locate Driver Files window.



- h. Press “Browse” to select driver and then click the “OK” button to go to the next page.

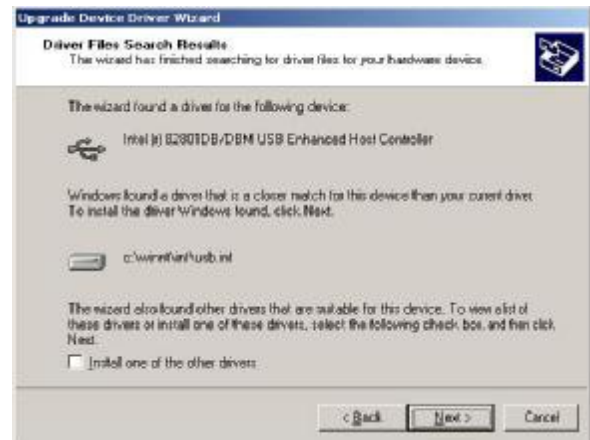

- i. Click the “Next” button on Driver Files Search Results window.



j. Click the "Finish" button to complete this process.

k. Finished.

3.4. VGA Driver Installation

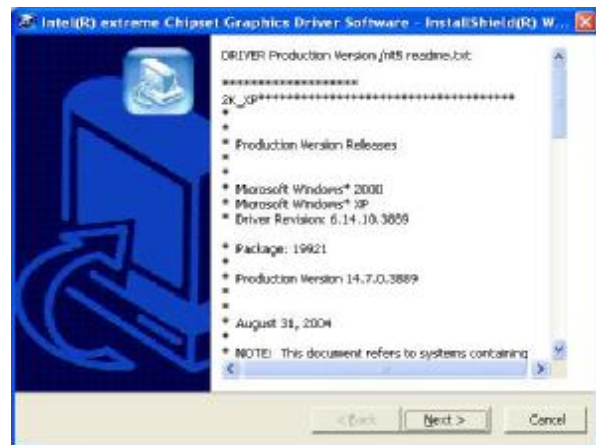

a. Double click "win2k_xp147" on the My Computer window.

b. Click the "Next" button on the Welcome window.



c. Click the "Next" button on the Welcome window.

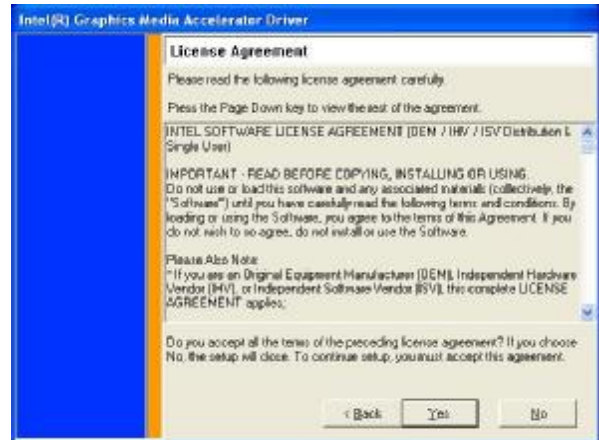

d. Click the "Yes" button on the License Agreement window.



e. Click the "Finish" button and restart your system.

3.5. Audio Driver Installation

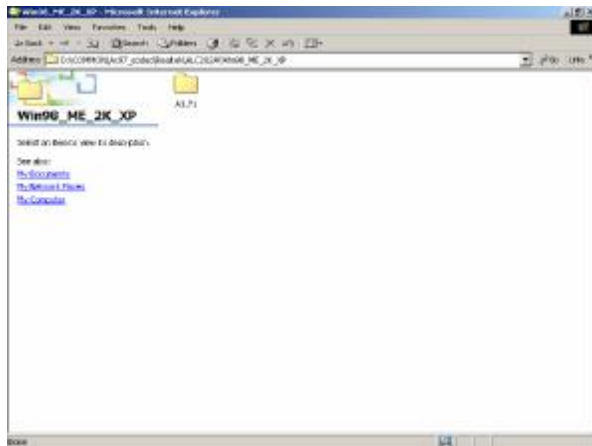

a. Click "A3.71" on the My Computer window.

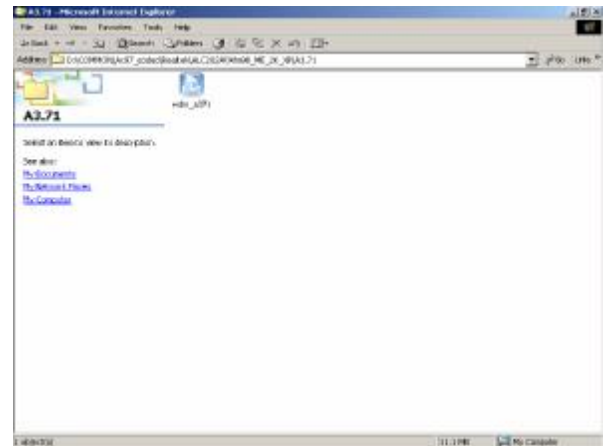

b. Double click "wdm_a371" on the My Computer window.



c. Click "Next" button on the Realtek AC'97 Audio Setup window.



d. Click "Yes" button on the Digital Signature Not Found window.

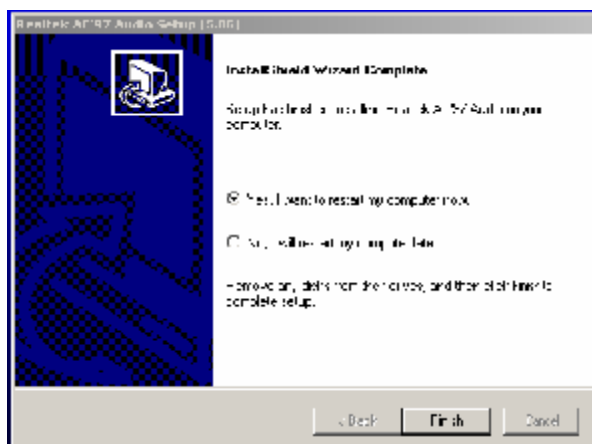

e. Click "Finish" button on the Realtek AC'97 Audio Setup window.

3.6. ELO Touch Driver Installation



a. Click "sw500930" on the My computer window.



b. Click the "OK" button on the Welcome window.



c. Click the "Unzip" button on the WinZip Self-Extractor window.



d. Select "Install Serial Touchscreen Drivers" and then click the "Next" button on the Welcome window.

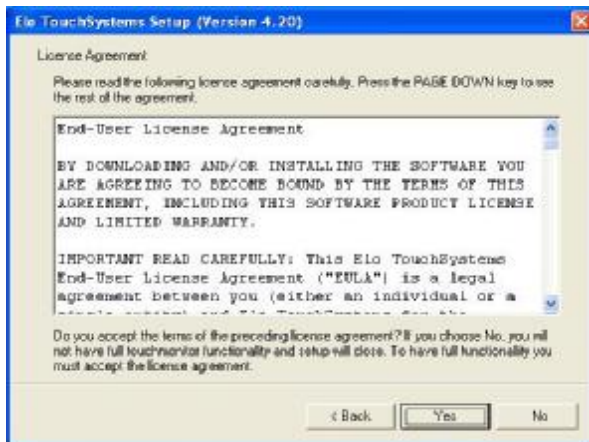

e. Click the “Yes” button on the License Agreement window.



f. Click the “Next” button on the on the “Select the COM ports...” window.

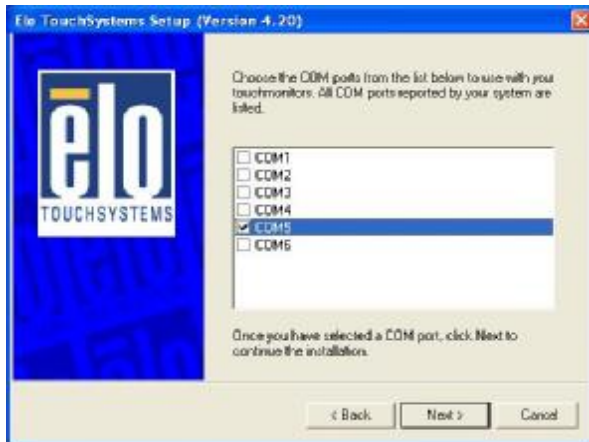

g. Select “COM5” and click the “Next” button on the Choose the COM ports... window.



h. Click the “Next” button on the You have selected the COM ports...window.



i. Click the “Finish” button on the Setup Complete window



j. Click the “Yes” button and restart your system.

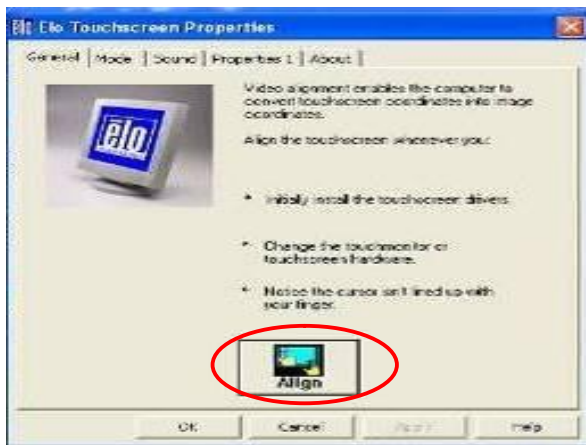

k. After the computer has restarted, click “Align” on the Elo Touchscreen Properties window.



l. Follow the instructions on the screen to calibrate the touch panel.

3.7. POS Touch Driver Installation

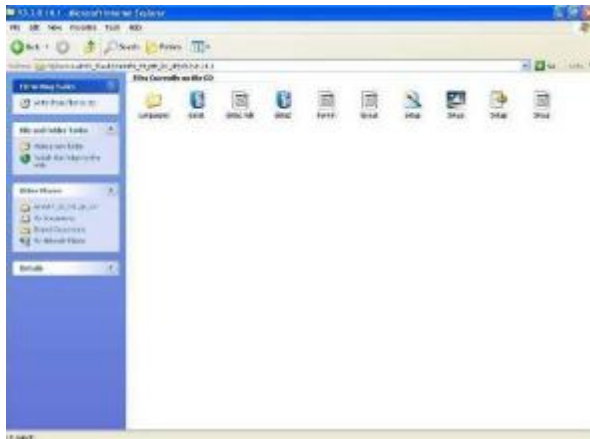

a. Double click the "Setup" on the "My Computer" window.

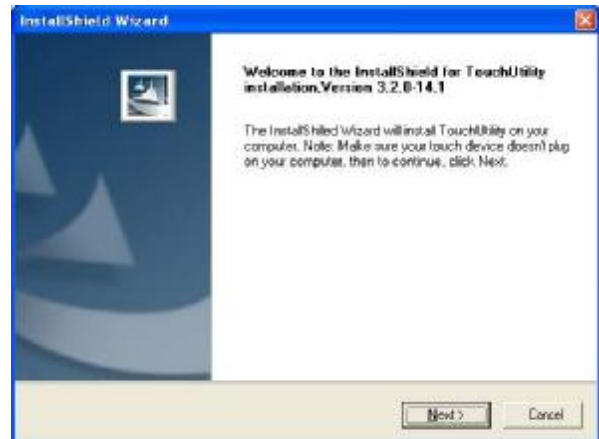

b. Click the "Next" button on the "Welcome window".

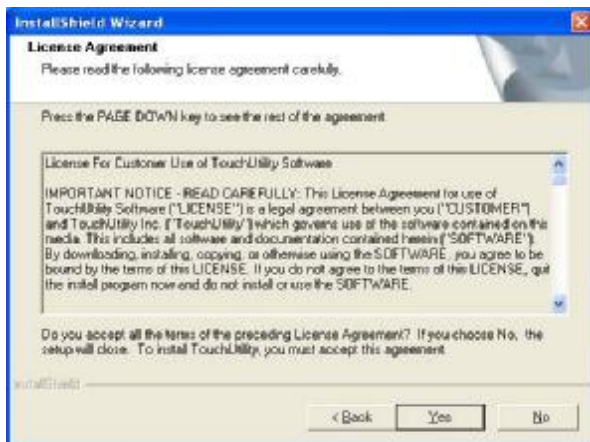

c. Click the "Yes" button on the "License Agreement" window.

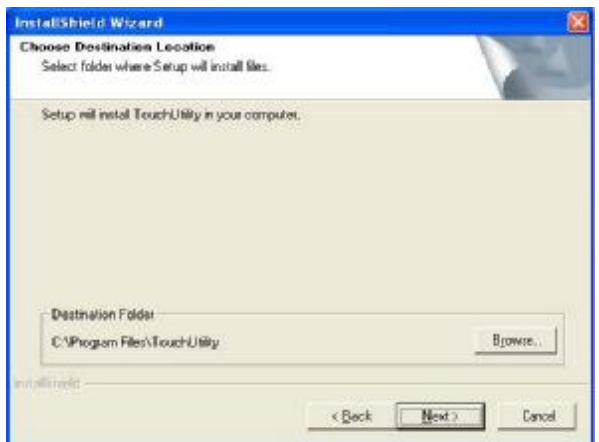

d. Click the "Next" button on the "Choose Destination Location" window.

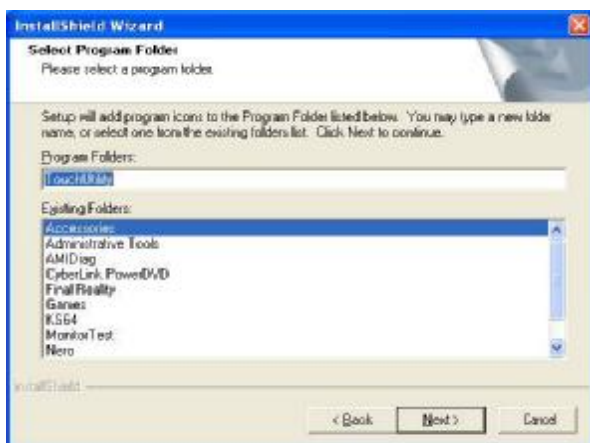

e. Click the "Next" button on the "Select Program Folder" window.

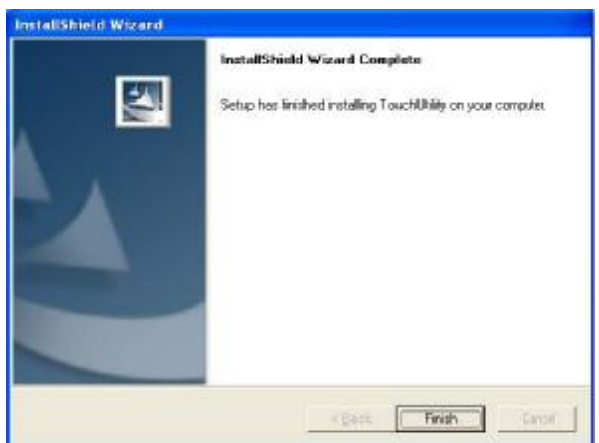

f. Click the "Finish" button on the "Install Shield Wizard Complete" window.

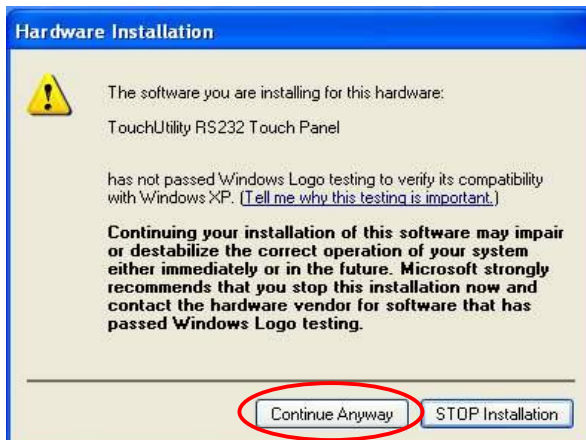

g. Click the “Continue Anyway “ button on the “Hardware Installation” window.



h. Select the “Yes” and click the ”OK” button and restart your system.



i. After the computer has restarted, select “Programs à TouchUtility à Scan RS232 Touch Device”.

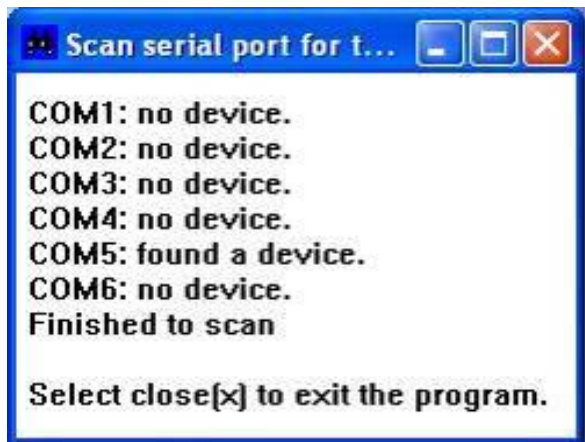

j. The serial ports are scanned for a touch device.



k. Select “Programs à TouchUtility à Touch Utility”.



l. Click “Scale / Offset” on the POSTouch Utility window.



m. Follow the instructions on the screen to do a three point calibration of the touch panel.

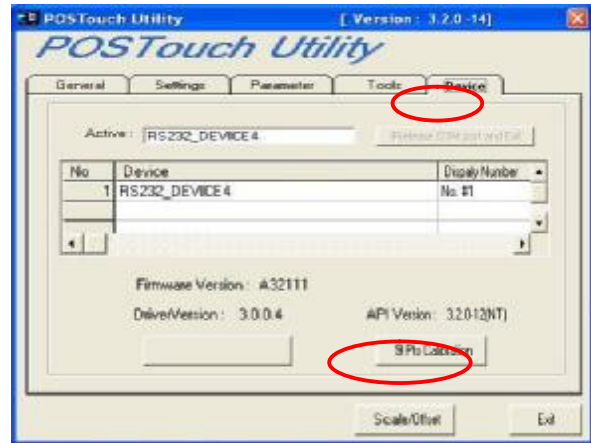

n. Select "Device à 9Pts Calibration" on the POSTouch Utility window.



o. Follow the instructions on the screen to do a nine point calibration of the touch panel.

3.8. 10/100Mb LAN Driver Installation

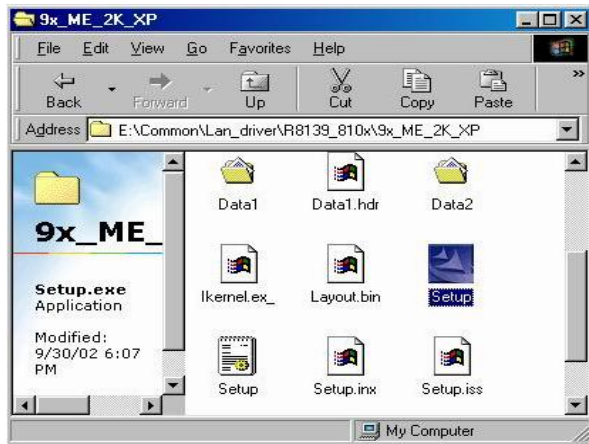

a. Double click "Setup" on the My Computer window.

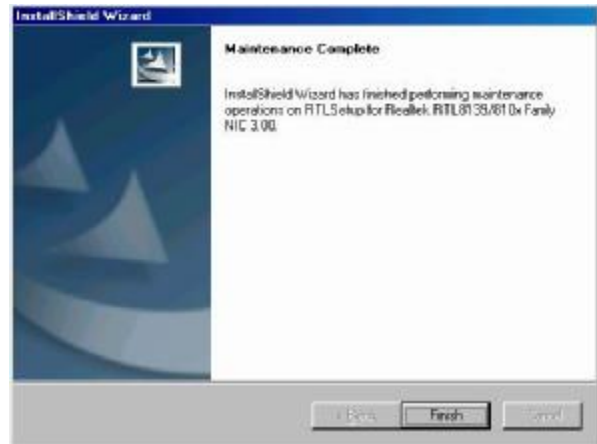

b. Click the "Finish" button on the Maintenance Complete window.

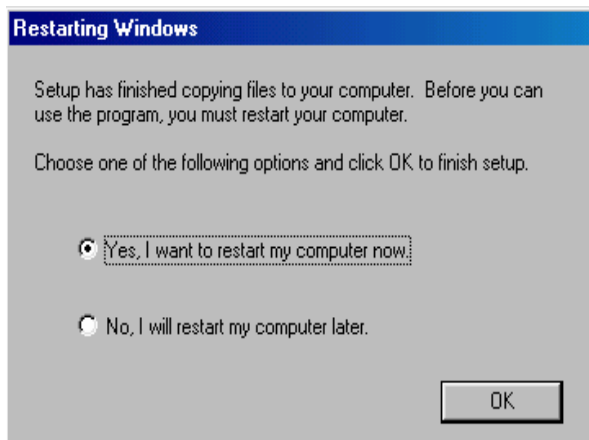

c. Click the "OK" button and restart your system.

3.9. MiniPCI IEEE802.11g WLAN Driver Installation

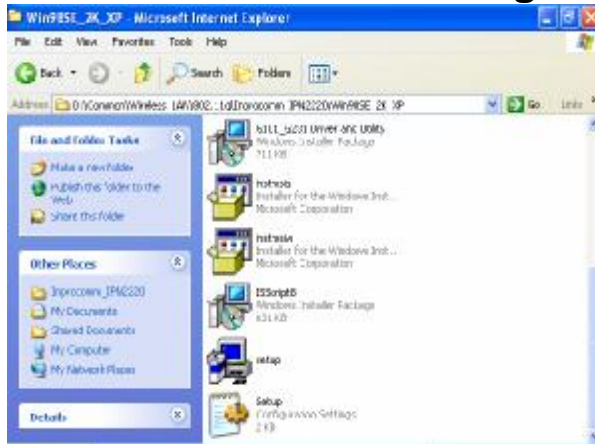

a. Double click the "Setup" on the "My Computer" window.



b. Click the "Next" button on the "Welcome to the InstallShield Wizard for G101_G231 Driver & Utility" window.

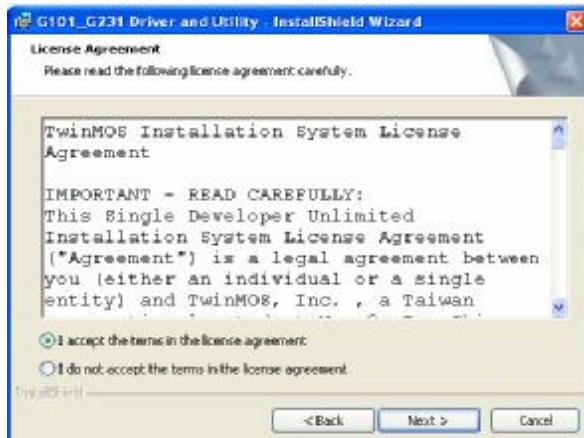

c. Click the "Next" button on the "License Agreement" window.

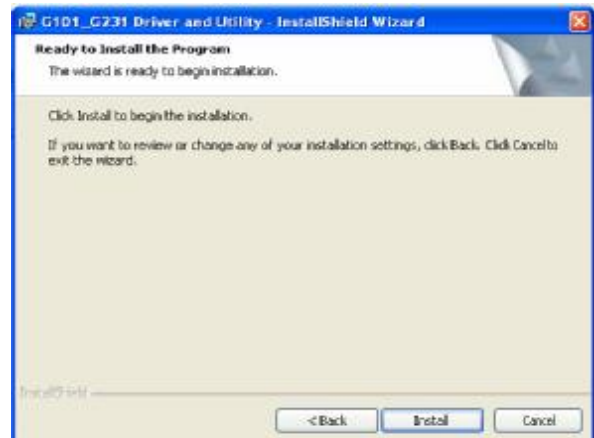

d. Click the "Install" on the "Ready to Install the Program" window.

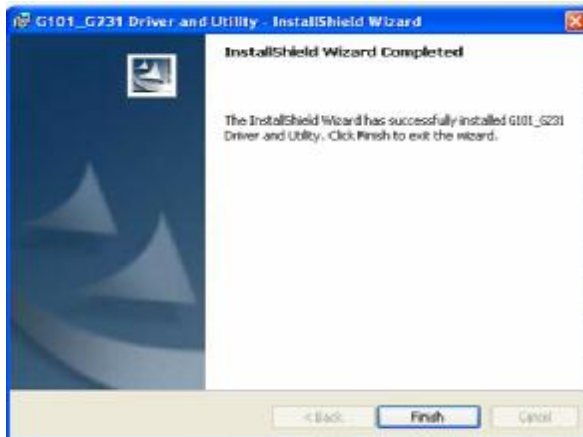

- e. Click the “Finish” on the “InstallShield Wizard Completed” window.

3.10. FTP637 Thermal Printer Driver Installation

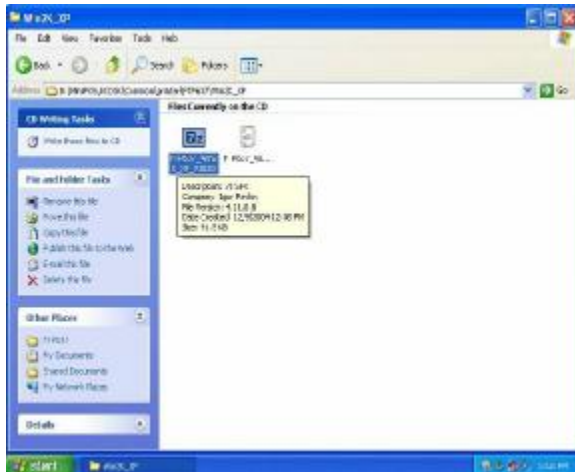

- a. Click “[FTP637 Win2K_XP_V1020](#)” on “My Computer” window.

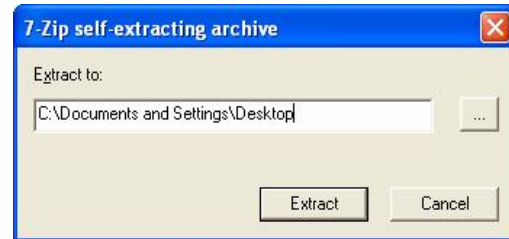

- b. Type extract path: C:\Documents and Settings\Desktop. Click “Extract” button on the “7-Zip self-extracting” window.



c. The file name is [FTP673](#) on the desktop.

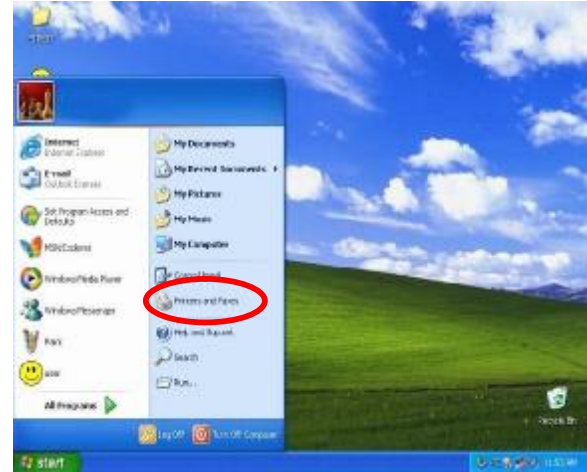

d. Select "Printers and Faxes".

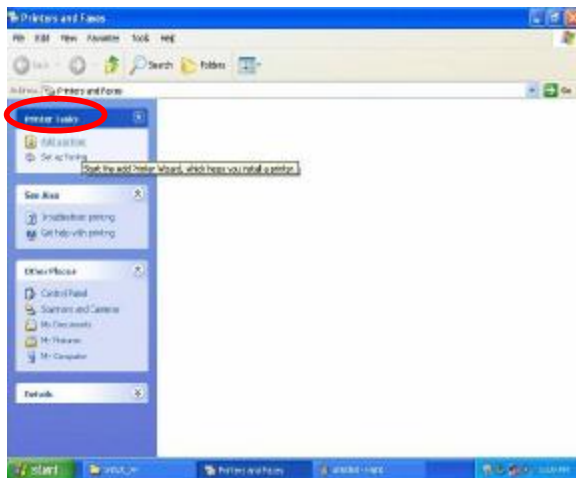

e. Select "Add a printer" on the "Printer and Faxes" window.



f. Click "Next" on the "Add Printer Wizard" window.



g. Select “Local printer attached to this computer” and click “Next” button on the “Add Printer Wizard” window.

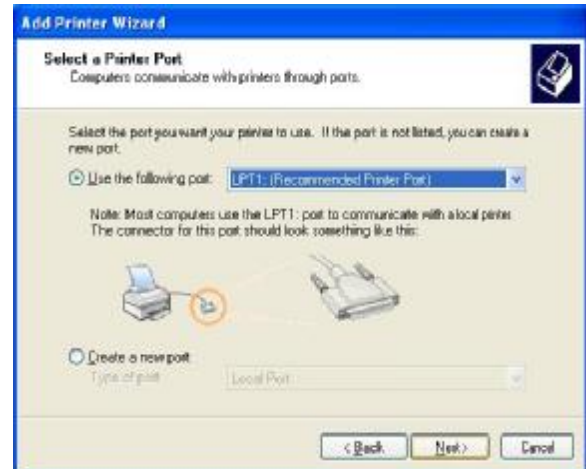

h. Select “Use the following port LPT1” and click “Next” button on the “Add Printer Wizard” window.

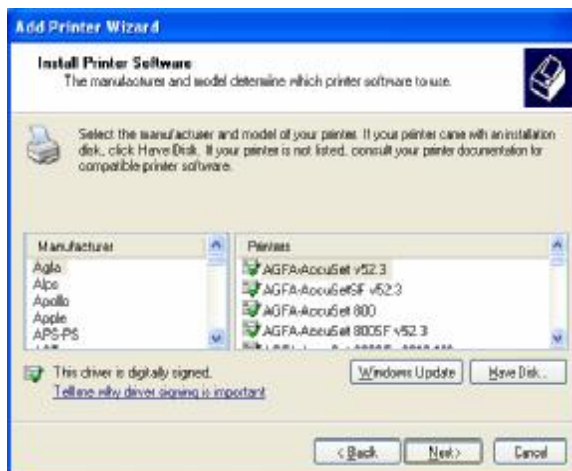

i. Click “Have Disk” button on the “Add Printer Wizard” window.



j. Click “Browse” button and select the file path: C:\Documents and Settings\Desktop\FTP673. Then, click “OK” button.

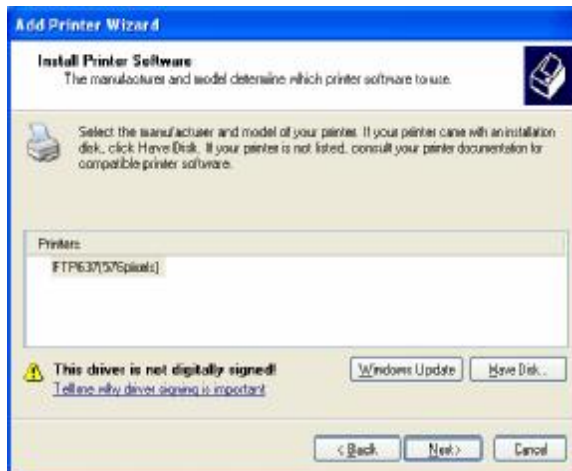

k. Click "Next" button on the "Add Printer Wizard" window.

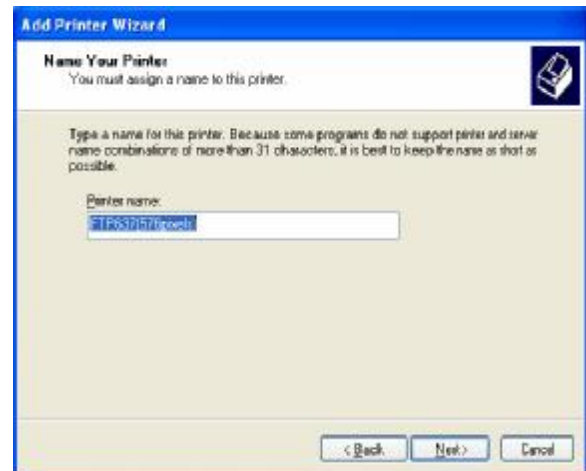

l. Click "Next" button on the "Add Printer Wizard" window.

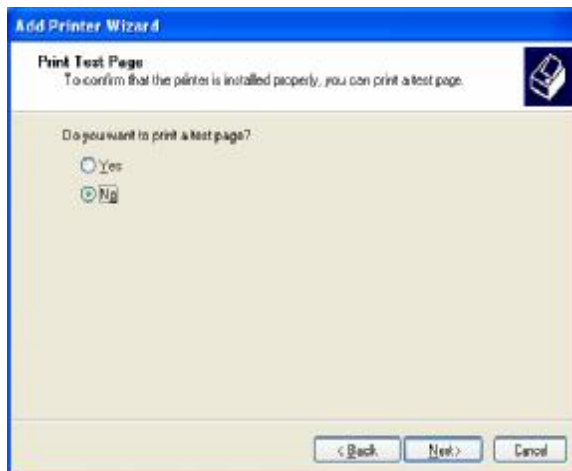

m. Select "No" and click "Next" button on the "Print Test Page" window.



n. Click "Finish" button on the "Add Printer Wizard" window.



o. Click "Continue Anyway" button on the "Hardware Installation" window.

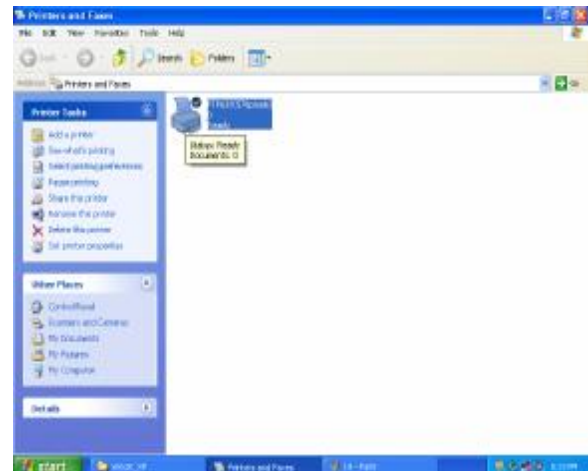

p. The printer driver installation is completed.

4. System Disassembly

4.1. Removing the HDD Drive Bracket



a. Remove the screws (5).



b. Open the main housing to separate it from the base chassis, taking care not to stretch the cables which are still connected. (K811 showed in the picture.)

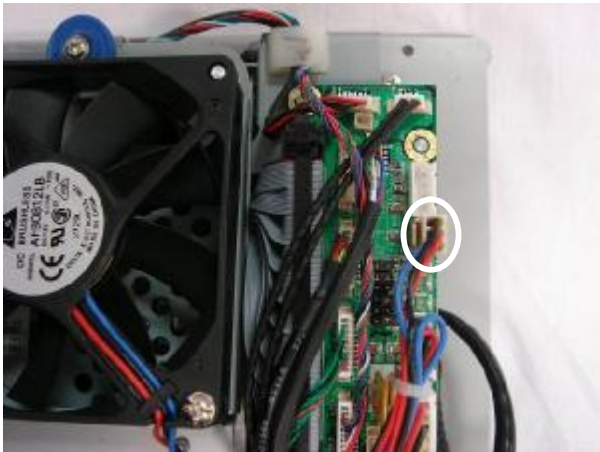

c. Disconnect the fan cable (1).



d. Loosen the screws (2) to lift the HDD bracket up.



Note: Please insert the HDD bracket into the slot at the middle of the rubber as shown in the picture.



e. Pull the pull tape to disonnect the cable (1) from the motherboard. Remove the HDD bracket.

4.2. Replacing the HDD & Fan

To replace the HDD and fan, please first follow the steps in chapter 4.1.



a. Remove the HDD bracket.

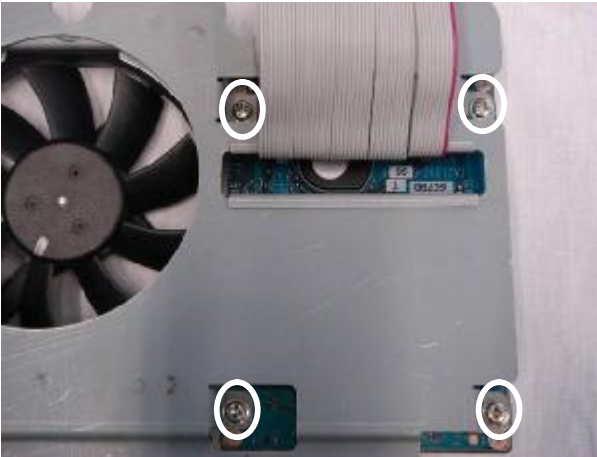

b. Remove the screws (4) to replace the HDD.



- c. Remove the screws (2) to replace the fan.

4.3. Replacing the Mini PCI

To replace the Mini PCI, please first follow the steps in chapter 4.1.



- a. Disconnect the antenna (2).



- b. To remove the Mini PCI card, release the two metal latches as shown in the picture until the card pops up. Remove the Mini PCI card from the slot.

4.4. Replacing the Power Adapter

To replace the power adapter, please first follow the steps in chapter 4.1.



a. Disconnect the power cable (1).



b. Disconnect the DC Jack cable (1).



c. Remove the screw (1) to replace the power adapter.

4.5. Replacing the Speakers

To replace the speakers, please first follow the steps in chapter 4.1.

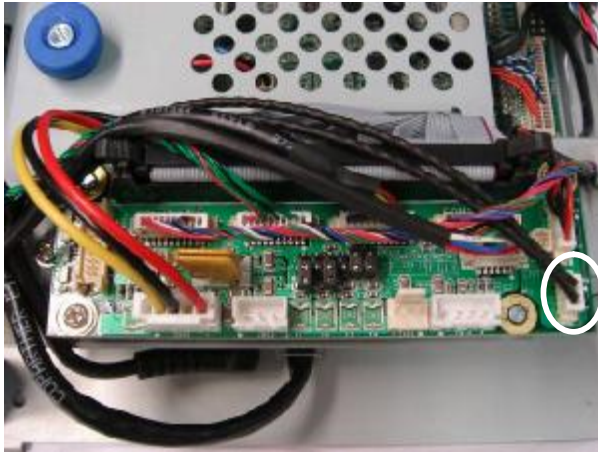

a. Disconnect the speaker cable (1).

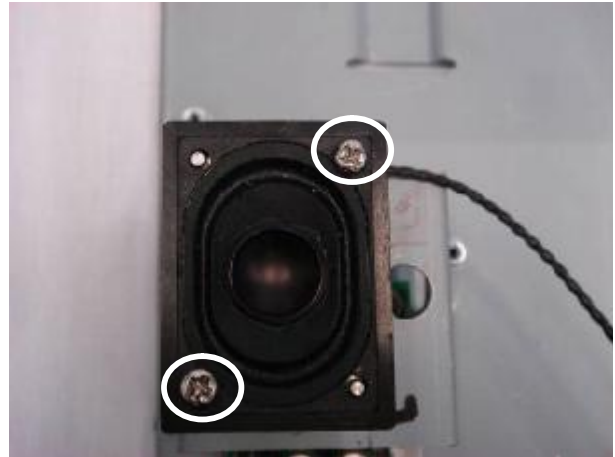

b. Remove the screws (4) (two on each side) to replace speakers (2).

4.6. Replacing the Motherboard

To replace the motherboard, please first follow the steps in chapter 4.1.



a. Disconnect the cables (5): antenna cables (2), inverter cable (CN1), speaker & MIC cable (CN7), and LCD interface cable (CN12) (Refer to 6.1. B76 Motherboard).



b. Disconnect the cables (8) on the daughter board: 100pin cable (CN1), COM 2 cable (CN3), COM3 cable (CN4), COM4 cable (CN5), LPT cable (CN7), speaker out cable (CN8), input power cable (CN12), and output for DC converter cable (CN13) (Refer to 6.5. Daughter Board Connectors).



c. Disconnect the power cable (1).



d. Disconnect the cable (2): DC Jack cable (1) and LAN cable (1).



e. Remove the screws (2).



f. Remove the screws (3) to remove the EMI shielding box.



g. Disconnect the fan cable (1).



h. Remove the screws (6) to replace the motherboard.

4.7. Replacing the Heatsink & CPU

To replace the heatsink and CPU, please first follow the steps in chapter 4.6.

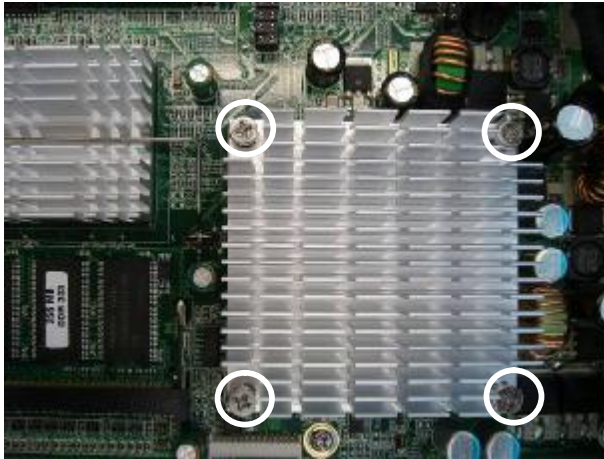

a. Remove the screws (4) that secure the heatsink.



b. Turn the knob 180 degrees to open the key lock to remove the CPU.

4.8. Replacing the Side Fan

To replace the side fan, please first follow the steps in chapter 4.6.



a. Disconnect the fan cable (1) on the motherboard.



b. Remove the screw (1).



- c. Remove the screws (2) to replace the side fan.

4.9. Replacing the LCD Panel & Touch Screen

To replace the LCD panel and touch screen, please first follow the steps in chapter 4.1.



- a. Disconnect the cables (2): printer power cable (1) and card reader cable (1).



- b. Disconnect the cable (4): antenna cables, inverter cable (CN1), and LCD interface cable (CN12).

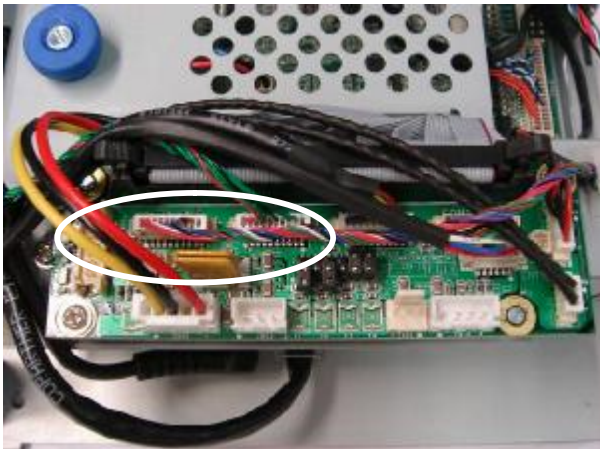

c. Disconnect the cables (3): COM3 cable (CN4), COM4 cable (CN5), and LPT cables (CN7).



d. Remove the screw (1).



e. Remove the screws (2).



f. Remove the screws (2).



g. Remove the screw (1).

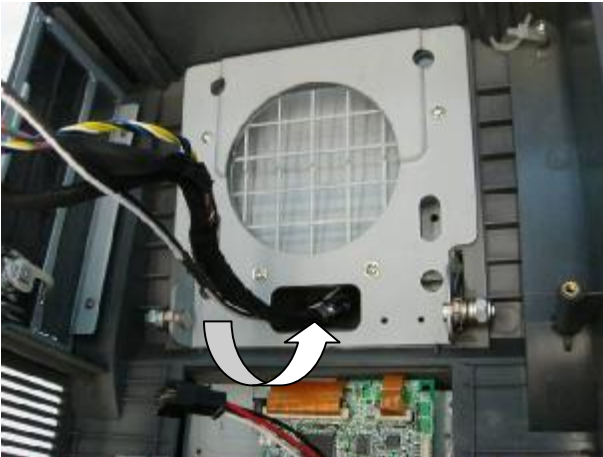

h. Pass the cables through the hole.



- i. Use a screwdriver to carefully press in the four slots to pry off the display cover. Separate the LCD panel and touch screen. Take care not to stretch the touch cable which is still connected.



- j. Remove the screws (2).



- k. Remove the screws (2).

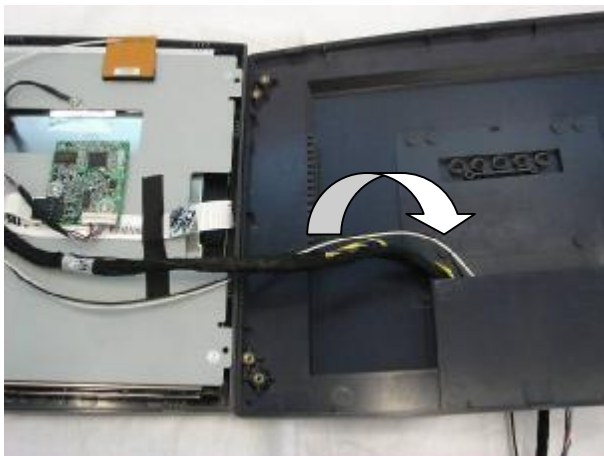

- l. Separate the LCD rear cover and LCD panel. Pass the cables through the hole.



- m. Disconnect the touch cable to separate the touch screen and LCD panel.

4.10. Replacing the Touch Board & Inverter Board

To replace the touch board and inverter board, please first follow the steps in chapter 4.9.



a. Disconnect the touch cable (1).



b. Remove the screws (2) to replace the touch board.



c. Disconnect the cables (3).

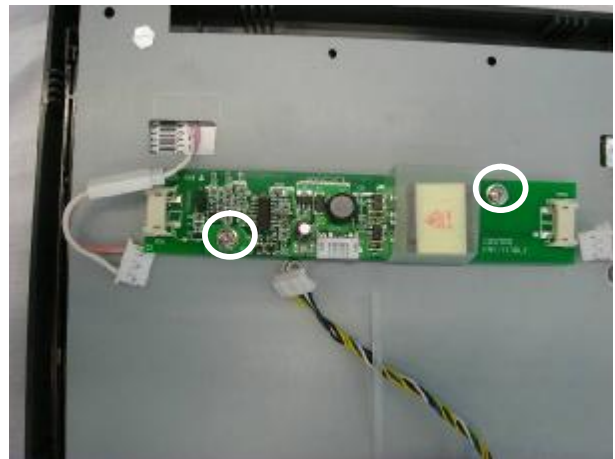

d. Remove the screws (2) to replace the inverter board.

4.11. Replacing the Laser Scanner

To replace the laser scanner, please first follow the steps in chapter 4.1.

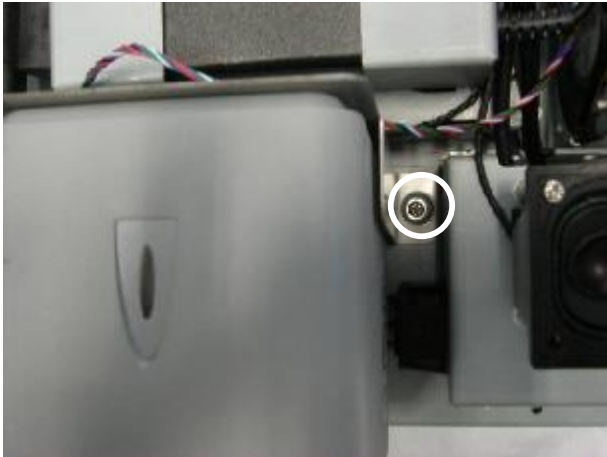

a. Remove the screw (1).



b. Remove the screw (1) to replace the laser scanner.

4.12. Replacing the Card Reader & Thermal Printer



a. Remove the screws (2).



b. Push the button to open the cover.



c. Remove the screws (4) to take the module up.



d. Remove the screws (2) to replace the card reader.



e. Remove the screws (3) to replace the printer control board.

5. Specification

Mainboard		B76
CPU Supports	Intel Celeron M 1.3GHz	
Chipset	Intel 852GM + ICH4	
System Memory	1 x DDR SO-DIMM socket supported with memory size up to 1 GB	
Graphic Memory	Shared Memory up to 64MB	
LCD Touch Panel		
LCD Size	12.1" TFT	
Brightness	425 cd/m ²	
Maximal Resolution	800 x 600	
Touch Screen Type	Resistive	
Tilt Angle (Degree)	80° ~ 90°	
Storage		
HDD	Slim 2.5" HDD	
Flash Memory	Compact Flash (Type I & II)	
Expansion		
Mini-PCI Socket	1	
External I/O Ports		
Line in (Audio)	1	
Line out (Audio)	1	
USB	2 (V 2.0)	
LAN (10/100)	1 (RJ45)	
COM	1 (Option 2 COM ports)	
Internal Speaker	2 x 2W	
DC Jack	1 (19V IN)	
Control / Indicator		
Power Button	1	
Wall Mount Type		
VESA Standard	75 x 75 mm / 100 x 100 mm	
Power		
Power Adapter	Internal 65W (19V / 3.42A)	Internal 120W (19V / 6.3A)
Peripherals		
Hybrid Card Reader	N/A	Three-track MSR or optional IC / smart card reader

Magnetic Card Reader	3 Track (PS/2)	N/A
Laser Scanner	Omni-directional (RS-232)	N/A
Thermal Printer	3" internal thermal printer with auto-cutter	
Wireless LAN	802.11a/b/g wireless support via mini-PCI Adapter	
Environment		
EMC & Safety	FCC, Class A, CE, LVD	
Operating Temperature	5°C ~ 35°C (41°F ~ 95°F)	
Storage Temperature	-10°C ~ 60°C (14°F ~ 140°F)	
Operating Humidity	20% - 90% RH non condensing	
Storage Humidity	20% - 90% RH non condensing	
Dimension (W x D x H mm/inch)	298 x 134 x 397 mm / 11.7" x 5.3" x 15.6"	
OS Support	Microsoft Windows XP Professional, Windows XP Embedded, Windows 2000, WEPOS	

- This specification is subject to change without prior notice.

6. Connectors and Jumper Settings

B76 Motherboard

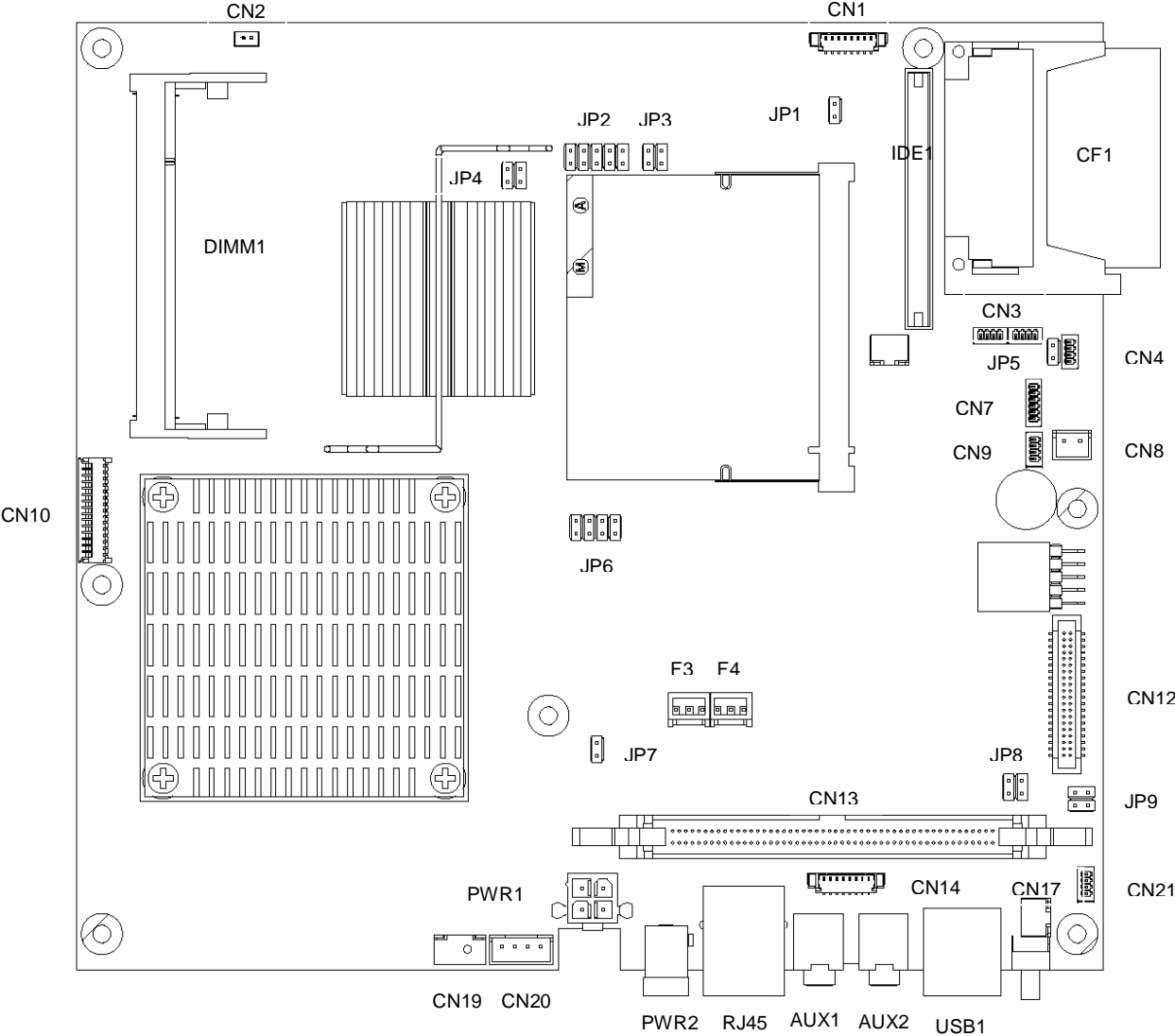

1. Connectors

Connector	Function
CN1	Inverter CONN
CN2	LED
CN3	USB5/6
CN4	LINE-IN CONN
CN7	Speaker & MIC CONN
CN8	I-Bottom CONN
CN9	Support VFD
CN10	Card Reader Connector
CN12	LCD Interface
CN13	100 pin Connector to IO Board
CN14	COM5 CONN for Touch
CN17	Power Switch
CN19	For Power/LAN LED CONN

Connector	Function
CN20	Power Connector For Extend COM Port
CN21	Programmable Keyboard
F3	CPU FAN CONTROL
F4	SYSTEM FAN CONTROL
DIMM1	DDR Memory
IDE1	2.5" IDE Device
PWR1	PWR CONN
PWR2	DC JACK
RJ45_1	LAN Connector
CF1	CF CARD CONN
AUX1	LINE OUT
AUX2	MIC IN
USB1	USB 3 / USB4 port

2. Jumper Settings

1. CMOS Operation Mode

Function	JP1
CMOS Normal	⊙N/C
CMOS Reset	1-2

To clear the CMOS:

- 1) Remove AC power from the unit.
- 2) Open the cabinet.
- 3) Change the JP1 jumper setting from N/C to 1-2.
- 4) Wait 1 minute.
- 5) Change the JP1 jumper setting back to N/C.
- 6) Close the cabinet.
- 7) Apply AC power and continue.

2. Compact Flash Master / Slave Setting

Function	JP5
Master	⊙1-2
Slave	N/C

3. Power Mode Setting

Function	JP7
ATX Power	⊙N/C
AT Power	1-2

4. I-Button Setting

Function	JP8
Use I-Button	N/C
No I-Button	⊙1-2 3-4

5. LCD ID Setting

Panel Number	Resolution	LVDS		JP6			
		Bits	Channel	1-2	3-4	5-6	7-8
0	640 x 480	18	Single	SHORT	SHORT	SHORT	SHORT
1	800 x 600	18	Single	SHORT	SHORT	SHORT	OPEN
2	1024 x 768	18	Single	SHORT	SHORT	OPEN	SHORT
3	1280 x 1024	24	Dual	SHORT	SHORT	OPEN	OPEN
4	1024 x 768	24	Single	SHORT	OPEN	SHORT	SHORT
5	800 x 600	24	Single	SHORT	OPEN	SHORT	OPEN

6. Programming Keyboard Setting

Function	JP9
Use P-KB	N/C
No P-KB	⊙1-2 3-4

3. Connectors Pin Definition

CN1: Inverter CONN

Pin 1	+12V_INV
Pin 3	+12V_INV
Pin 5	VRSET
Pin 7	GND

Pin 2	+12V_INV
Pin 4	BKLEN
Pin 6	GND
Pin 8	GND

CN3: USB 5 / USB 6

Pin 1	+5V_USB 4
Pin 3	USB20_R_P4+
Pin 5	+5V_USB 5
Pin 7	USB20_P5+

Pin 2	USB20_R_P4-
Pin 4	GND
Pin 6	USB20_P5-
Pin 8	GND

CN4: Line-In CONN

Pin 1	GND
Pin 3	LINE_IN_L

Pin 2	LINE_IN_R
Pin 4	GND

CN6: 4 Wire Touch

Pin 1	ESD 1
Pin 3	ESD 3

Pin 2	ESD 2
Pin 4	ESD 4

CN7: Speaker & MIC CONN

Pin 1	AMP_ORL
Pin 3	GND
Pin 5	GND

Pin 2	GND
Pin 4	AMP_ORR
Pin 6	MIC 1

CN9: Support VFD

Pin 1	+12V
Pin 3	RS232_4_RX#

Pin 2	RS232_4_TX#
Pin 4	GND

CN10: Card Reader Connector

Pin 1	+5V
Pin 3	KDATA_SIO_TO_MSR
Pin 5	KDATA_MSR_TO_IBT
Pin 7	RS232_CR_RX#
Pin 9	RS232_CR_CTS#
Pin 11	KB_EN
Pin 13	USB_20_MSR_P4+
Pin 15	GND

Pin 2	+5V
Pin 4	KCLK_SIO_TO_MSR
Pin 6	KCLK_MSR_TO_IBR
Pin 8	RS232_CR_TX#
Pin 10	RS232_CR_RTS#
Pin 12	GND
Pin 14	USB20_MSR_P4+

CN11: Internal Touch

Pin 1	ESD 1
Pin 3	ESD 2
Pin 5	ESD 3
Pin 7	ESD 4
Pin 9	ESD 5
Pin 11	NC

Pin 2	ESD 1
Pin 4	ESD 2
Pin 6	ESD 3
Pin 8	ESD 4
Pin 10	ESD 5
Pin 12	NC

CN12: LVDS Interface

Pin 1	LVDS_B0+
Pin 3	LVDS_B0-
Pin 5	GND
Pin 7	LVDS_B1+
Pin 9	LVDS_B1-
Pin 11	GND
Pin 13	LVDS_B2+
Pin 15	LVDS_B2-
Pin 17	GND
Pin 19	LVDS_B3+

Pin 2	LVDS_A3+
Pin 4	LVDS_A3-
Pin 6	GND
Pin 8	LVDS_CLKA+
Pin 10	LVDS_CLKA-
Pin 12	GND
Pin 14	LVDS_A2+
Pin 16	LVDS_A2-
Pin 18	GND
Pin 20	LVDS_A1+

CN12: LVDS Interface

Pin 21	LVDS_B3-
Pin 23	GND
Pin 25	LVDS_CLKB+
Pin 27	LVDS_CLKB-
Pin 29	GND
Pin 31	+5V_LCDVDD
Pin 33	+5V_LCDVDD
Pin 35	+5V_LCDVDD
Pin 37	+5V_LCDVDD
Pin 39	+5V_LCDVDD

Pin 22	LVDS_A1-
Pin 24	GND
Pin 26	LVDS_A0+
Pin 28	LVDS_A0-
Pin 30	GND
Pin 32	+3.3V_LCDVDD
Pin 34	+3.3V_LCDVDD
Pin 36	+3.3V_LCDVDD
Pin 38	+3.3V_LCDVDD
Pin 40	+3.3V_LCDVDD

CN14: COM 5 CONN for External Touch

Pin 1	RS232_5_DCD#
Pin 3	RS232_5_TX#
Pin 5	GND
Pin 7	RS232_5_RTS#
Pin 9	RS232_5_RI

Pin 2	RS232_5_RX#
Pin 4	RS232_5_DTR#
Pin 6	RS232_5_CTS#
Pin 8	RS232_5_CTS#
Pin 10	+5V

CN16: USB 4

Pin 1	+5V_USB3
Pin 3	USB20_P3+

Pin 2	USB20_P3-
Pin 4	GND

CN18: USB 3

Pin 1	+5V_USB2
Pin 3	USB20_P2+

Pin 2	USB20_P2-
Pin 4	GND

CN19: For Power/LAN LED CONN

Pin 1	GND
Pin 3	LAN_LINK#

Pin 2	+5V
-------	-----

CN20: Power Connector For Extend COM Port

Pin 1	+12V
Pin 3	GND

Pin 2	GND
Pin 4	+5V

5. Daughter Board Connectors

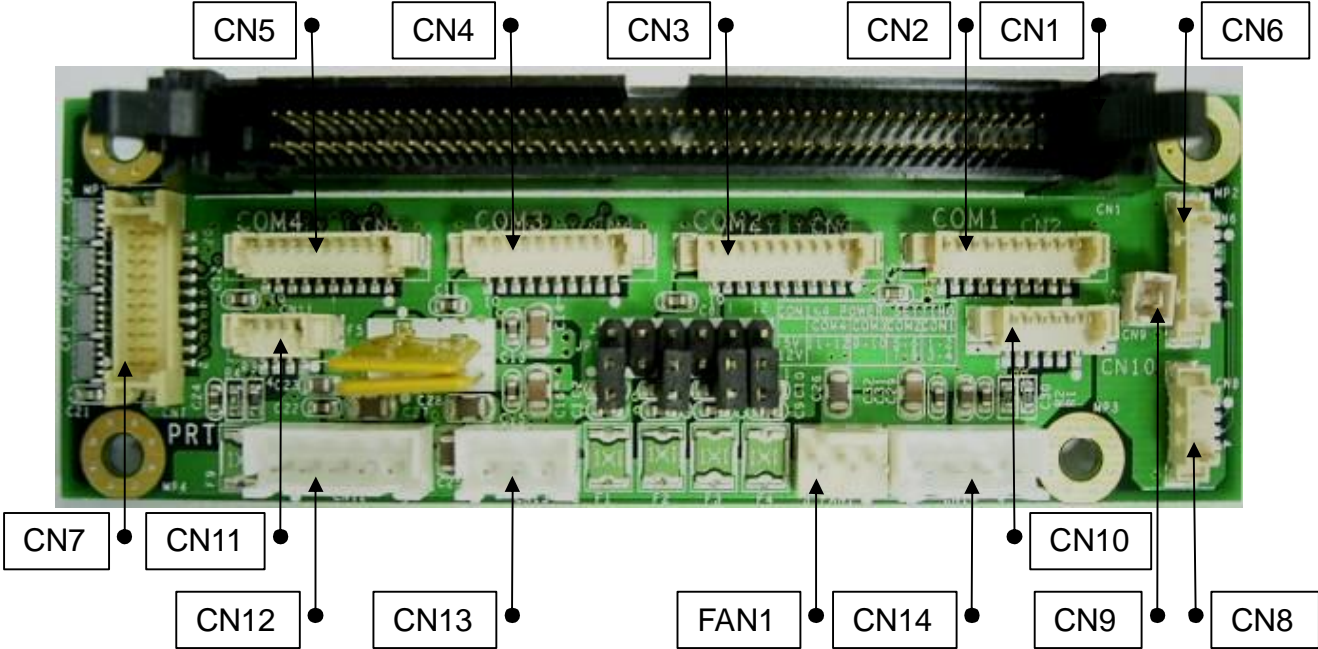

Connector	Function
CN1	100pin Connector to I/O Board
CN2	COM1
CN3	COM2
CN4	COM3
CN5	COM4
CN6	Speaker & MIC CONN (Input)
CN7	LPT Port

Connector	Function
CN8	Speak out
CN9	MIC
CN10	MSR
CN11	USB
CN12	+12V / +5V Input Power
CN13	+12V / +5V Output for DC Converter
CN14	Power Connector for 3.5" HDD

7. BIOS Settings

1. BIOS Setup Utility

The BIOS setup defines how the system is configured. You need to run this program the first time you configure this product. You may need to run it again if you change the configuration.

You need to connect a PC keyboard to the keyboard connector to run the BIOS setup utility.

2. Starting the BIOS Setup

1. Turn on or reboot this product.
2. Press the DEL key immediately after the product is turned on, or press the DEL key when the following message is displayed during POST (the Power on Self-Test).

Press DEL to enter SETUP.

3. The main menu of the BIOS setup is displayed.
4. If the supervisor password is set, you must enter it here.

3. When a Problem Occurs

If, after making and saving system changes with the Setup utility, you find that this product no longer boots, start the BIOS setup and execute the following.

Load Optimized Defaults

4. BIOS Main Menu

When the BIOS Main Menu is displayed, the following items can be selected. Use the arrow keys to select items and the Enter key to accept and enter the sub-menu.

Note: The BIOS menu below is from B76 BIOS version B76MV10.BIN. If you have a different BIOS version, the contents of the menu may differ.

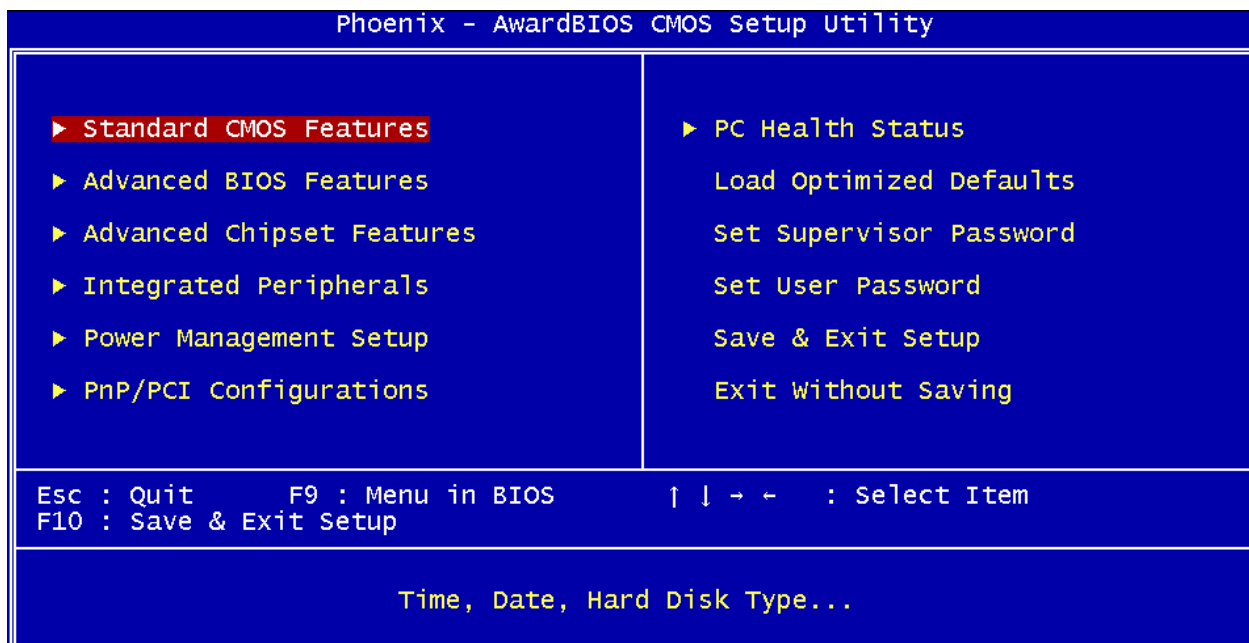

Standard CMOS Features

Use this menu for basic system configuration.

Advanced BIOS Features

Use this menu to set the Advanced Features available on the system.

Advanced Chipset Features

Use this menu to change the values in the chipset registers and optimize the system's performance.

Integrated Peripherals

Use this menu to specify your settings for integrated peripherals.

Power Management setup

Use this menu to specify your settings for power management.

PnP/PCI Configurations

This entry appears if your system supports Plug and Play and PCI Configuration.

PC health status

Displays CPU, System Temperature, Fan Speed, and System Voltages Value.

Load Optimized Defaults

Use this menu to load the BIOS default values, i.e., factory settings for optimal performance system operations. While Award has designed the custom BIOS to maximize performance, the factory has the option to change these defaults to meet their needs.

Set Supervisor Password

Enables you to change, set, or disable the supervisor or user password.

Set Password

Change, set, or disable the password. It allows you to limit access to the system and to the setup, or just to the setup.

Save & exit setup

Save CMOS value changes to CMOS and exits setup.

Exit without saving

Ignores all CMOS value changes and exits setup.

Appendix A - Airflow Requirements

Do not block the air vents on the terminal. These vents are necessary for cooling purposes.



Do not place the terminal in an enclosed area where sufficient ventilation is not available. Leave at least 150 mm (6 in) of clearance on the sides where air vents are located.