

AEG

ADVANCED ENGINEERING FROM GERMANY

MICROMAT_DUO 343 E/U

Microwave Oven



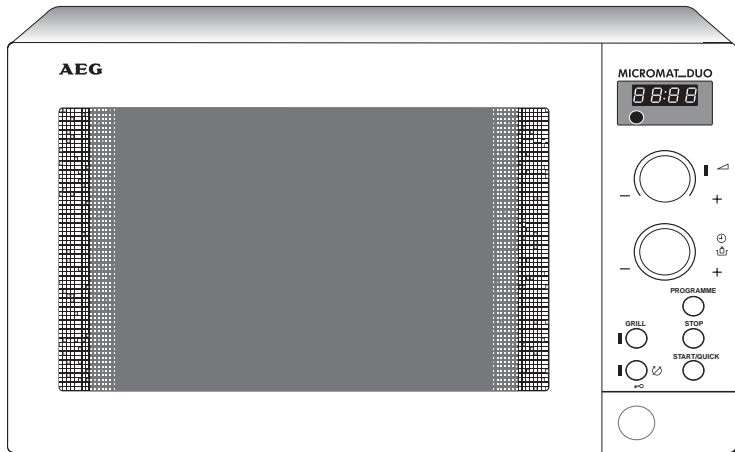

Operating Instructions



Dear customer,

Thank you for buying an AEG microwave oven and putting your trust in the AEG brand name.

Before using your AEG microwave oven for the first time, please read the instruction book thoroughly. This will enable you to take advantage of all the features that the appliance offers. It will also ensure trouble-free operation and minimise unnecessary service calls.

-  Important information concerning your safety or the operation of your appliance is noted by this symbol and/or mentions words such as «Warning», «Take care». Be sure to follow all instructions carefully.
-  Throughout the manual, this symbol guides you step by step when operating the appliance.
-  This symbol indicates further information concerning the use of the appliance.
-  The clover indicates energy-saving tips and hints for environmentally friendly use of your appliance.

In the event of malfunctioning, please follow the instructions given in the section «What to do if...»

Contents

Important information

Ecologically responsible disposal of packaging and old appliances	5
--	---

Safety Instructions

General	6
For trouble free and safe operation	6
Microwaves	7
Grill	8

General operating instructions

Suitable ovenware	9
What else to note	10

Installation and Connection

Table top model	11
Built in model	11
Connecting to the mains	12
Electrical connections	13

Product Description

The Appliance	14
Control panel	15
Dual function grill element	16
Accessories	16

Before using the appliance

Cleaning	16
Setting the clock	17

“At a glance” operating instructions	18
--	----

Modes of operation	20
Microwave only	21
Notes on microwave power	22
Automatic programmes	23
Quick-START	26
Grilling	26
Combined microwave and grill	27
Minute timer with alarm	28
Cooking charts and Tips	
Defrosting	29
Cooking vegetables	32
Cooking fish	32
Practical tips for use	33
Tips on microwaving	34
Test procedures	35
Roasting and Grilling	36
Combined Microwave and Grilling	37
Cleaning and Care	38
What to do if...	39
Service and Spare Parts	40
Customer Service	41
Guarantee conditions	42

Important information

Ecologically responsible disposal of packaging materials and old appliances



Packaging materials

AEG microwave ovens require effective packaging to protect them during transportation. Only the minimum packaging necessary is used.



Packaging materials (e.g. foil or styrofoam) can place children at risk. **Danger of suffocation. Keep packaging material away from children.**



All packaging materials used are environment friendly and can be recycled. The cardboard is made from recycled paper and the wooden parts are untreated. Plastic items are marked as follows :

«PE» polyethylene eg packaging film

«PS» polystyrene eg packaging (CFC-free)

«PP» polypropylene eg packaging straps

By using and re-using the packaging, raw materials are saved and waste volume is reduced.

Packaging should be taken to your nearest recycling centre. Contact your local council for information.



Disposal of old appliances

Old appliances should be made safe before disposal by removing the plug, and cutting off and disposing of the power cable.

It should then be taken to the nearest recycling centre . Check with your local Council or Environmental Health Office to see if there are facilities in your area for recycling the appliance.

Safety instructions



General

- The appliance should only be operated with the turntable and turntable support inserted.
- Only suitable microwave ovenware should be used.
- To protect the appliance against corrosion from moisture (condensation) in the cavity or on the door, wipe these areas dry after each use.
- Do not leave the appliance unattended when warming or cooking food in disposable containers made of plastic, paper, or other flammable materials.
- If smoke is observed, keep the oven door closed, disconnect the power supply and contact your local AEG Service Force Centre. Never use the microwave oven if it is not functioning properly.
- This appliance complies with all relevant safety instructions. In order to maintain the safety of the appliance, repairs should only be carried out by an AEG Service Force Centre. Repairs carried out by unqualified personnel can place the user in severe danger. In the case of any defect or breakdown, please therefore contact your local AEG approved retailer or the AEG Service Force Centre
- Should the door seals and/or door seal surfaces be damaged, the appliance should not be operated until it has been repaired by the AEG Service Force Centre.
- Damaged appliance parts can only be replaced by exactly the same make of parts. Special tools are required for this operation.
- **WARNING:** This appliance is designed to be operated by adults. Children should not be allowed to tamper with the controls or play with the product.



For trouble free and safe operation

- Never jam anything between the door and the door frame.
- Always keep the door seals and their surfaces clean.
- Do not keep any flammable items in the microwave. They could ignite when the unit is switched on.
- Switch the appliance on only when the food has been placed inside the cooking space, as it could overload if there is no food present.

Microwaves



- Whenever heating liquid, please also place a teaspoon in the container to avoid delayed boiling. During delayed boiling, the boiling temperature is attained without the typical steam bubbles rising. When the container is shaken, even gently, the liquid may then suddenly vigorously boil over or spurt - with the risk of scalding the user.
- Food with «skin» or «peel», such as potatoes, tomatoes, sausages, and the like, should be pierced with a fork so that any steam present can escape and the food will not burst.
- Make sure that a minimum temperature of 70°C is attained for the cooking/heating of food. Never use a mercury or liquid thermometer for measuring the temperature of the food.
- Baby food in jars or bottles should always be heated without a lid or top, and well stirred or shaken after heating, to ensure uniform distribution of the heat. **Always check the temperature before feeding your child.**
- The hot food in a microwave oven will heat up the ovenware. For this reason always use **oven gloves** for handling hot dishes.
- Never cook your food for too long or at too high a power setting. Some areas of the food can dry out or even ignite.
- Do not use porcelain or ceramic crockery, or porous earthenware (e.g. on the handles or unglazed bases) in your microwave as these types of dishes can absorb moisture from the food as it is cooking. This can cause vapour pressure to build up which could shatter the dish.



Do not use your microwave oven for the following :

- to boil eggs or escargots in their shells, as they will burst. Eggs can be poached in a microwave oven as long as the yolks are pricked.
- to heat large quantities of cooking oil (fondue or deep frying) and drinks containing a high percentage of alcohol - **there is danger of spontaneous combustion!**
- to heat unopened cans, bottles, etc.
- to dry animals, textiles or paper.

Grill

- The viewing window heats up during grilling (and combination grilling and microwave cooking), so keep small children away from the appliance.
- To close the door when the viewing window is hot, press on the lower right-hand side of the door.
- The cooking area, the grill heating elements, the shelf racks, the turntable and the anti-splash glass plate become very hot during all modes. You should therefore take care before touching anything.

Take care not to be burned!

i General operating instructions

Suitable ovenware

Ovenware material	Mode of operation		
	Micro-wave	Grill	Combination
Ovenproof glass and ceramic dishes (without any metal parts, e.g. Pyrex, Oven-to-tableware)	X	X	X
Non ovenproof glass and porcelain (e.g. table crockery ¹⁾)	X	-	-
Glass ceramic and vitro-ceramic made of fire/frost proof material (e.g. Arcoflam)	X	X	X
Ovenproof earthenware ²⁾	X	-	X
Plastic, heat-resistant up to 200°C ³⁾	X	-	X
Paper, cardboard	X	-	-
Cling film	X	-	-
Microwave cling film	X	-	-
Black-lacquered or silicone-coated baking tins	-	-	-
Roasting bag ⁴⁾	-	X	X

X suitable - non suitable

1) excluding silver, gold, platinum or metal decoration

2) does not include glaze containing metal

3) please note the maximum temperature stated by the manufacturer

4) do not use the grill shelf together with metal recipients.

i What else to note...

- Food comes in all shapes, sizes and textures. The quantities also vary. For these reasons the time and amount of energy needed to defrost, heat or cook will also vary. As a general rule :

Double the quantity/weight = nearly *double the time

* Please refer to the cooking charts. To be on the safe side, always select the shorter cooking time. Then extend the time as necessary.

- Microwaves work by making the food heat itself up. Because of this, not all areas of the food will be heated at the same time. When heating larger quantities of food, it is particularly important to stir or turn them over.
- “**Standing time**” is referred to in the cooking charts. This is the time you should leave the food to stand without power (either inside or outside the appliance). This ensures even distribution of heat throughout the food.

Installation and Connection

The oven should be set on a work surface at least 85 cm above floor level. To ensure the stability of the microwave oven, the front left foot is adjustable (5 positions). Turn it to raise or lower the appliance. Make sure that nothing obstructs the ventilation louvres and that air may circulate freely around the oven.

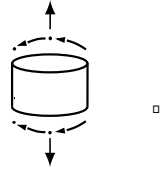
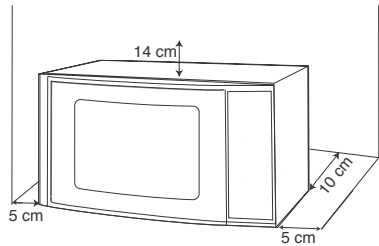

Table top model

A gap all around the oven is necessary in order to ensure perfect ventilation:

Above:	14 cm
Behind:	10 cm
Either side:	5 cm



Built-in model

To install the appliance in a kitchen cabinet, use the appropriate mounting frame. Note the relevant instructions for installation and connection. When building in to a high cabinet, you may use the liftdoor. Note the relevant information for installation and connection given in the operation instructions of the lift door.



Attention !

Never operate the microwave oven with the lift door closed. Such operation would damage your appliance and invalidate the guarantee.



This appliance complies with the following EC Directives :
EMC Directive 89/336/EEC, Low Voltage Directive 73/23/EEC with amendment 90/683/EEC and the CE marking Directive 93/68/EEC.



Installation

1. Remove any promotion label from the door.
2. Install the oven on a flat, level surface. The surface must be strong enough to safely bear the weight (17 kg) of the oven, and the contents. To avoid the possibility of causing vibration or noise the oven must be in a stable position.
3. Keep the microwave oven away from sources of water and extreme heat, e.g. radiators and boilers. This appliance should not be installed next to a radiator or boiler as this can lead to the appliance malfunctioning
4. Do not block air vents on the top and the sides of the cabinet and also do not place any articles on the top of the oven. If air vents are blocked during operation, the oven may overheat, and this may lead to malfunctioning. Hot air escapes from the vents, so be sure not to obstruct it or let curtains come between the oven and the rear wall.
5. Place the oven as far away from radios and TV's as possible. This oven does conform to EEC requirements* of radio interference suppression, but some interference may occur if it is placed too close to a radio or TV, so keep them as far apart as possible.

* *This appliance conforms to the requirements of EEC Radio Interference Directive 87/308/EEC.*



Connecting to the mains

- The oven is delivered with the power cord and a plug for 230–240 V, 50Hz, earthed socket outlet.
- Earth protection minimizes the risks should a short circuit occur. Check to ensure the voltage of the oven matches the supply.

N.B. If the oven is connected to the socket via an extension cord, make sure the cord is earthed.



WARNING! This appliance must not be used on a non earth protected power supply.

- Contact an electrician if you are uncertain regarding electrical connection of the oven or provision of earth protection of the supply.
- This appliance must be earthed. If this appliance is fitted with a non-rewirable plug for which your socket is unsuitable, the plug should be cut off and the appropriate plug fitted. If it is necessary to change the fuse in a nonrewirable plug, the fuse cover must be refitted. If the fuse cover is lost or damaged, the plug must not be used until a replacement is obtained.

Electrical connections



- **WARNING! THIS APPLIANCE MUST BE EARTHED.**
The manufacturer declines any liability should this safety measure not be observed.
- If the plug that is fitted to your appliance is not suitable for your socket outlet, it must be cut off and the appropriate plug fitted.
- Remove the fuse from the cut off plug. The cut off plug should then be disposed of to prevent the hazard of shocks in case it should be plugged into a 13 Amp socket in another part of your home.

IMPORTANT

The wires in the mains lead are coloured in accordance with the following code:

GREEN AND YELLOW	EARTH
BLUE	NEUTRAL
BROWN	LIVE

If you fit your own plug, the colours of the wires in the mains lead of your appliance may not correspond with the markings identifying the terminals in your plug, proceed as follows:

- Connect the green and yellow (earth) wire to the terminal in the plug which is marked with the letter "E" or the earth symbol (\equiv) or coloured green and yellow.
- Connect the blue (neutral) wire to the terminal in the plug which is marked with the letter "N" or coloured black.
- Connect the brown (live) wire to the terminal in the plug which is marked with the letter "L" or coloured red.

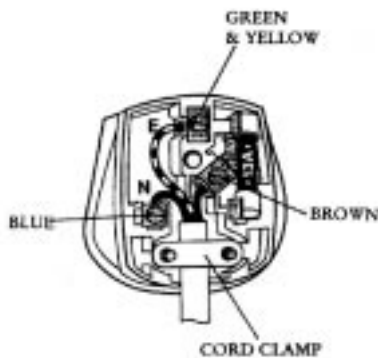

Product Description

The appliance

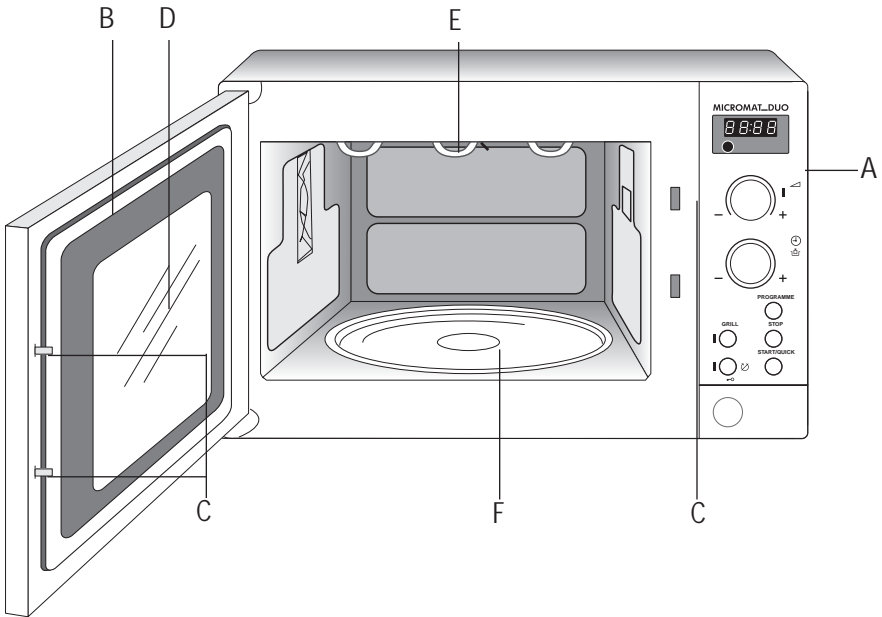

- A** Control panel
- B** Door seal
- C** Door latch and catch
- D** Viewing window
- E** Grill
- F** Turntable

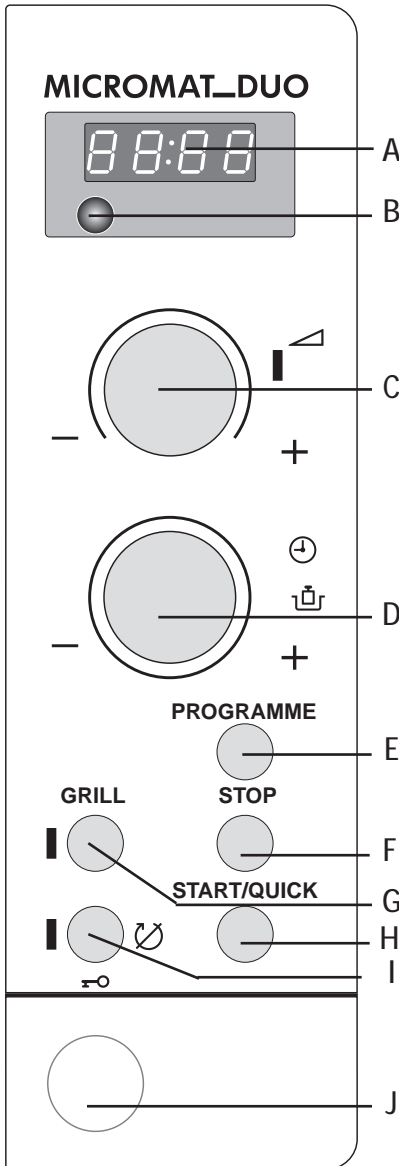

The control panel



A Display for time of day, cooking time, function mode, power etc.

B Multi function button to set the time of day and display the selected microwave power etc.

C Power knob  with signal light to select microwave power.

D Rotary knob to select the cooking time  or the weight  when using automatic programmes.

E Button for automatic programmes 'PROGRAMME' for defrosting and cooking.

F CLEAR button 'STOP' to cancel settings.

G GRILL button to set grill functions with signal light

H START button 'START/QUICK' to start the selected function and to switch on Quick-START.

I Button for switching the turntable off with signal light.

J Button for opening door .

Dual function grill element

The grill element has 2 positions:

1. Horizontal
for grilling snacks and steaks etc.

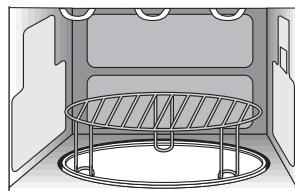

2. Vertical
for cleaning.
Allow the grill element to cool BEFORE cleaning inside the appliance.

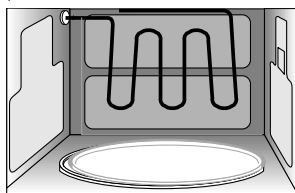

Accessories

The turntable and turntable support should be installed as shown in the diagram.

Take care to ensure the turntable support is properly in place.

The turntable may turn clockwise or counterclockwise during operation.

Do not try to rotate the roller ring manually, as you could damage the drive system.

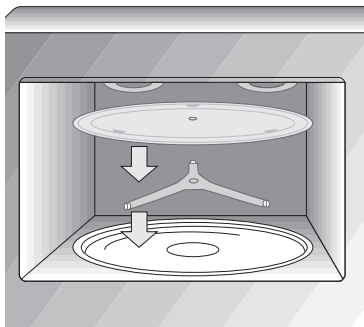

Wire rack

For grilling of e.g., meat and poultry; for gratin or toasting

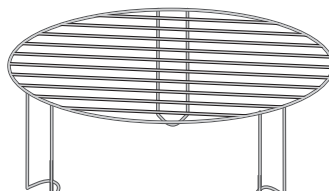

Before using the appliance

Cleaning

Wipe over the front of the appliance with a damp cloth. Do not use abrasive cleaning agents (these can damage the surface).

For stainless steel fronts use a suitable stainless steel cleaning agent that leaves a protective film against fingerprints.

Before you first use the appliance, remove all the accessories (including the turntable and turntable support) from the cooking area. Wash the accessories in warm water and washing up liquid. Wipe clean the cooking space with a soft, damp cloth.

Setting the clock



Example: 12:15 hrs

1. Plug the appliance into the mains. The display starts to flash «FEG» and then «00:00». The dots between the digits blink rapidly.



2. Press the **multi function button** beneath the display (top left side). The dots between the digits blink faster.

3. While keeping the multi function button pressed, set the time of day with the rotary knob \oplus ¹⁾. Release the button as soon as the time of day is displayed. The dots between the digits blink slowly. The appliance is now ready for use.



¹⁾The **rotary knob** \oplus can be turned clockwise (to increase) or counterclockwise (to decrease).

The time of day can be corrected at any moment by pressing the **multi function button** and simultaneously turning the rotary knob \oplus .

«At a glance» operating instructions

Action	Comments
1. Press door release button  .	The door opens.
2. Place food in the cooking space.	
3. Shut the door.	The door will click audibly when it is properly shut. If the door is not shut properly, the appliance will not function.
4. Select according to the instructions given on the following pages.	The order in which you programme functions has no consequence ¹⁾ . Turn the time button clockwise to increase or counterclockwise to decrease time ²⁾
5. If required : switch off the turntable.	When the turntable has been switched off, the appropriate signal lamp lights up. The turntable should only be turned off when using rectangular ovenware that is larger than the turntable and is in danger of jamming.
6. Press the START -button ' START/QUICK '.	The appliance starts. The display shows the selected cooking time, counting down backwards in seconds. (The corresponding indicator light shows which function is selected.)
7. End of cooking sequence.	The end of the cooking sequence is indicated by a triple audible tone. The appliance and the interior light will switch off. The display area once again shows the time of day.



- 1) If the oven is not started within 4 minutes, the settings are automatically cancelled ; time of day reappears in the display.
- 2) If the maximum cooking time setting « 60:00 » is surpassed during the setting, the display shows « 00:00 »



Action :	Comments
<ul style="list-style-type: none"> • Open the door by pressing the door release button  e.g. for stirring. 	The appliance and interior lighting switch off. In the display, the two dots between the digits flash.
<ul style="list-style-type: none"> • Shut the door and press the START button 'START/QUICK' 	The selected settings remain. The remaining time counts down automatically.
<ul style="list-style-type: none"> • Press the CLEAR button 'STOP'. 	The running process is cancelled. The appliance and the interior lighting switch off. Time of day is displayed.
<ul style="list-style-type: none"> • Modify the selected cooking time: turn the rotary knob  clockwise or counterclockwise. 	The cooking time in the display changes when turning the rotary knob. ¹⁾
<ul style="list-style-type: none"> • Modify the selected microwave power: rotate the power knob  	The new power setting is displayed for 5 seconds. The cooking process continues with the new power setting.
<ul style="list-style-type: none"> • Press multi function button. 	The selected parameters are displayed successively for 5 seconds each, e.g. programme name, weight, microwave power .
<ul style="list-style-type: none"> • Operation of the grill by pressing the GRILL button. 	The selected grill power level is displayed. The signal lamp comes on (also refer to chapter "Combination of microwave and grill")



- ¹⁾ If the new selection reaches « 00:00 » in the display, the cooking time is over and an audible signal sounds three times. The appliance and the interior lighting switch off. During a cooking process, the cooking time can be increased to a maximum of 60 minutes.

Modes of operation

The appliance features the following functions:

Microwave only

In this mode, microwaves generate heat directly in the food. This mode is highly suitable for warming, for example, ready cooked food and drinks, the defrosting of meat or vegetables, and for cooking food like fish and vegetables.

Grilling

Heat is generated by a grilling element set in the roof of the oven. This is particularly suitable for toasting and grilling e.g. steaks and sausages.

Combination mode

The microwave mode can be used together with grilling. Dishes will be cooked more quickly, whilst being crisp and brown at the same time.



Microwave Only

How to set

Example: 1 minute 15 seconds on microwave output level 750 W

1. Set the required microwave power by turning the power knob. The signal lamp lights up. The time of day disappears from the display and the required microwave power appears:

turn to the left = lower power

turn to the right= higher power

2. Set the required cooking time by turning the Rotary knob . The chosen time appears in the display.

3. Press the **START** button '**START/QUICK**'. The selected time starts to count down.



Cooking times can be set as follows :

from 0 to 2 min. in 5 second steps

from 2 to 5 min. in 10 second steps

from 5 to 10 min. in 20 second steps

from 10 to 20 min. in 30 second steps

starting from 21 min. in 1-min. steps

Maximum programme length is 60 minutes.



Metal items must be kept at least 2 cm from the cavity wall and the oven door.



Notes on microwave power levels

The following list shows you the power settings and what they can be used for during microwave operation :

750 Watt 700 Watt	<ul style="list-style-type: none"> - Heating liquids - to start a cooking sequence, start roasting, stewing, etc. - cooking vegetables - cooking dishes - defrosting and heating of deep frozen ready made meals - heating refrigerated ready made meals
600 Watt 500 Watt	<ul style="list-style-type: none"> - finish cooking casseroles - cooking egg based dishes
450 Watt 350 Watt 250 Watt	<ul style="list-style-type: none"> - finish cooking dishes - cooking of delicate dishes - heating baby food in glass jars - soaking rice - heating delicate dishes - melting of gelatin
150 Watt 80 Watt	<ul style="list-style-type: none"> - defrosting meat, fish and bread - defrosting cheese, cream and butter - defrosting cakes with cream or butter icing - to let dough rise - warming cold dishes, drinks, softening butter



Automatic Programmes

Programmes for defrosting and cooking are available. After having selected the programme, merely enter the weight of the dish, in grams, the rest of the programming is done automatically. The following gives you an overview of which food can be defrosted and/or cooked with which programme.

Automatic defrost

Programme	Food categories	Examples	Weight from - to
d1	Poultry fresh ¹⁾ Fish ²⁾	Poultry (whole or portions) Fish (whole or fillets)	100 - 2000 g 100 - 2000 g
d2	Meat	Pork roast, goulash	100 - 2000 g
d3	Delicate cakes and pastries	Cream pie	100 - 2000 g

1) Cover legs and wings with aluminium foil before defrosting.

2) Cover tail and thin ends with aluminium foil before defrosting.



Unpack your frozen food item, place on the top of a small overturned dish set inside a larger one to catch the liquid from defrosting.

Be sure and follow our recommended standing time

(general rule : standing time = defrosting time).

A triple bell will ring halfway through defrost time. Turn or mix dish and, if possible, break up into pieces.

Programme	Food categories	Examples	Weight from - to
c1	Fresh vegetables I	Brussel sprouts, cabbage, carrots, celery	100 - 1000 g
c2	Fresh vegetables II	Zucchini, leeks, potatoes, spinach, fennel, cauliflower, broccoli	100 - 1000 g
c3	Frozen vegetables	Carrots, cauliflower, Brussel sprouts, leeks, zucchini, spinach, broccoli	100 - 1000 g



Cook covered, in a heat-resistant glass dish, whenever possible. A triple bell rings halfway through cooktime. If cooking over 500 g of vegetables, stir once or twice.

Please add water in the following amounts :

- for fresh vegetables (I+II):	100 - 500 g	:	3 - 6 tablespoons
	500 - 1000 g	:	9 - 12 tablespoons.
- for frozen vegetables :	100 - 500 g	:	3 - 9 tablespoons
	500 - 1000 g	:	9 - 15 tablespoons.

Combination cooking (Cooking and Grilling)

Programme	Food categories	Weight from - to	Comments
C61	Chicken ¹⁾ (fresh)	200 - 2000 g	If cooking a dish weighing over 500g, a triple bell rings halfway through cooktime to remind you to turn.
C62	Pork roast ²⁾ (fresh)	400 - 1200 g	See above
C63	Gratin ³⁾	200 - 2000 g	If cooking a dish weighing 200-500g you place the dish on the grill shelf



- 1) If working with a weight from 1000 - 1400g, please use a deep heat-resistant dish, set it directly on the turntable, do not cover. Set chicken pieces directly on the grill shelf.
- 2) The pork roast is cooked in a deep heat-resistant dish, set directly on the turntable. Do not cover.
- 3) Enter the total weight of the dish, for instance potatoes with cream sauce and cheese.

The automatic cook times are for refrigerated dishes (+5°C).

The weight can be set as follows:

- from 100 to 1000 g in 25 g steps,
- from 1000 to 2000 g in 50 g steps.

For all dishes not covered by automatic programmes, enter manually microwave output power and time according to cook tables.

How to use automatic programmes



Example : defrosting 1 kg

1. Press the button for automatic programmes '**PROGRAMME**' until the desired programme appears in the display.



2. Use the Rotary knob to set the weight .



3. Press the **START** button '**START/QUICK**'. The display shows the necessary time.



4. If you want to modify the settings, you have to press the Clear-button '**STOP**' and start again.



Midway through the programme, three short bells will be heard. Stir or turn the food item at this time. The oven does not switch off.

Quick-START

How to set



The Quick-START button '**START/QUICK**', provides full microwave power from 30 seconds up to 2 minutes and 30 seconds, by 30 second-intervals. Each time you push the Quick-START button '**START/QUICK**', the programme time is increased by 30 seconds.

Example : heating a cup of water (1 min. 30 sec.)

1. Press the START-button, '**START/QUICK**', three times. The time appears in the display and the programme begins. The microwave power signal lamp comes on.

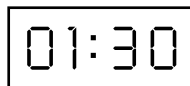

2. You may increase the time by 30 second-intervals while the programme is running up to a limit of 2 minutes and 30 seconds by pressing the START button '**START/QUICK**'.



You cannot use Quick-START for programmes exceeding 2 minutes and 30 seconds.

Grilling

How to set



Example: 20 minutes with GP2

1. Turn the power knob until reaching '0'. The time of day disappears.

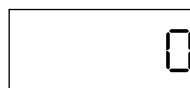

2. Set the required grilling time by using the Rotary knob.

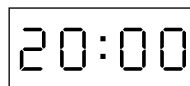

3. Press the button for the grill function. The signal light for grill comes on. The highest grill power level '**GP3**' appears in the display. Each time you press the button, a lower grill power is reached.¹⁾

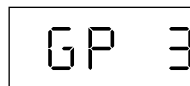

4. Press the START-button '**START/QUICK**'. The pre-set time will start to count down.²⁾

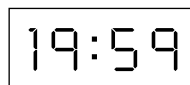



1) Each time you press the grill button, the grill power level appears in the display:

GP3, GP2, GP1. If you press the button again either the clock or the cooktime programmed will appear and the signal light will go off.

2) If you press the grill button while grilling, you may reduce grill power level to **GP1**. The next time you press the button, the oven turns off and the bell rings three times. The clock time appears in the display. If you wish to increase the grill power level during grilling, you must press the Clear button and re-program.

Combined Microwave and Grill



How to set

Example: 20 minutes with 750 microwave power and grill power level **GP2**

1. Set the required microwave power output using the Power knob. The signal light comes on and the time of day disappears. The required microwave power appears in the display in watts.

2. Set the required time by using the Rotary knob.

3. Press the button for the grill function. twice. The grill power level '**GP2**' appears in the display. The signal light comes on

4. Press the START-button, '**START/QUICK**'. The pre-set time will start to count down.



If you press the grill button while grilling, you may reduce grill power level to **GP1**. The next time you press the button, the grill turns off and the signal light for grill goes off. The appliance functions in microwave mode only. If you wish to increase the grill power level during grilling, you have to press the button for Grill again.



Minute timer with alarm

The minute timer with alarm can also be used as a general purpose reminder. For example, you could use it to set the time it takes to boil the egg that you are cooking on the hob.

The timer works without switching on the appliance, as long as no other functions have been selected.



How to set:

1. Select microwave power «0» using the Power knob  (all the way to the left).
2. Set the required time with the Rotary knob . The time of day disappears from the display and the required length of time appears.
3. Press the **START** button, '**START/QUICK**'. The pre-set time will start to count down. An audible triple signal will sound when the timer has finished counting down.

Cooking charts and tips

Defrosting

Dish	Weight in (g)	Power (Watt)	Duration (mins)	Standing time (mins)	Remarks/Hints
Meat					
Whole meat	500	150	10-15	10-15	Turn once. Cover fatty parts with aluminium foil after 1st half of defrosting time.
Steak	200	150	4-6	5-10	Turn once.
Mixed chopped meat	500	150	9-14	10-15	Halfway through the defrosting time remove any pieces of meat that have already defrosted.
Goulash	500	150	10-12	10-15	As above
Poultry					
Chicken	1000	150	25-35	15-30	Turn once. Cover legs and wings with aluminium foil halfway through defrosting time.
Duck	1500-2000	150 150	35-45 45-55	30-40 50-60	As for chicken.
Fish					
Whole fish	500	150	10-15	10-15	Turn once. Cover fins with aluminium foil.
Shrimps/crab	250	150	6-8	10-15	Stir thoroughly.
Dairy produce					
Cottage cheese	500	150	15-20	15-20	Divide and stir frozen pieces from time to time.
Butter	250	150	2-5	15-20	Remove any aluminium foil wrapping.
Cheese	250	150	3-5	20-30	Turn once.
Cream	200 ml	150	6-8	15-20	As for butter. Stir from time to time.
Fruit					
Strawberries	500	150	12-14	5-10	Defrost in covered container, turn once.
Cherries	250	150	6-8	5-10	As for strawberries.
Blackcurrants	250	150	7-9	5-10	As for strawberries.
Redcurrants	250	150	7-9	5-10	As for strawberries.

Defrosting

Description	Weight in (g)	Power (Watt)	Duration (mins)	Standing time (mins)	Remarks/Hints
Bread					
Rolls (50g)	4 units	150	2-4	3-5	Set on a paper towel, turn once.
Wholemeal, mixed, rye loaf	1 slice (60-80g) 500	150 150	40-50sec 6-8	3-5 15-20	Defrost in a covered container. Cover cutting surface.
Pastry					
Dry cakes eg cakes with short crust pastry	300	80	4-6	8-10	Set on a paper towel, cover.
Fruit flans baked on a baking sheet	400-450	80	8-12	5-10	As for dry cakes.
1 slice cheese cake	400	80	8-12	5-10	As for dry cakes.
1 slice covered apple tart	400	80	8-12	5-10	As for dry cakes.
Cream and butter-cake	300-400	80	5-8	10-20	Begin defrosting with micro waves, then remove.
Melting of food					
Chocolate/toppings	100	750	1-2		Break up into pieces, stir from time to time.
Butter	50	750	1		To warm set time for 30 sec. longer.
Heating of refrigerated food and drink					
1 jar baby food	125-250	450	1-2	2-3	Heat jar without lid. Stir after warming. Check temperature.
1 ready meal on a plate	350-400	750	2-4	2-3	Heat in a covered container. Place gravy alongside in a cup.
1 portion meat	approx. 150	750	1-2	2-3	All meat, except breaded meat, should be heated in a covered container.

Description	Weight in (g)	Power (Watt)	Duration (mins)	Standing time (mins)	Remarks/Hints
1 portion vegetables, potatoes or rice	approx. 200	750	2-3	2-3	Heat in covered container, stir once.
1 cup soup	approx. 200 ml	750	1-2	2-3	Heat clear soup uncovered, cover thick soups. Stir.
Drinks					
Milk or baby food	200 ml	750	45-50 sec	2-3	Remove any lids. Stir after warming!
Boil 1 cup water	180 ml	750	1½-2	2-3	Stir instant coffee or tea when the water has stopped boiling.
1 cup milk	200 ml	750	1-2	2-3	Heat milk till it is just hot enough to drink. Stir.
1 cup coffee (reheat)	200 ml	750	45-50sec	2-3	Stir. Check the temperature!
Defrosting and heating of frozen convenience foods					
1 portion meat with gravy	150	750	2-3	2-3	Stir now and again. Heat in a covered container.
1 portion meat with vegetables, garnish	350-450	750	7-9	2-3	As for meat with gravy.

Cooking vegetables ¹⁾

Description	Weight in (g)	Liquid added	Power (Watt)	Duration (mins)	Standing time (mins)	Remarks/Hints
Cauliflower	500	1/8 l	750	9-11	2-3	Dot with butter.
Frozen broccoli	300	1/8 l	750	6-8	2-3	Stalks facing outwards.
Mushrooms	250	none	750	6-8	2-3	Cut into slices.
Frozen peas and carrots	300	1/2 cup	750	7-9	2-3	
Carrots	250	2-3 tsp	750	8-10	2-3	Cut into cubes or slices.
Potatoes	250	2-3 tsp	750	5-7	2-3	Peel and quarter.
Kohlrabi	250	1/2 cup	750	8-10	2-3	Cut into spikes or slices.
Red/green peppers	250	none	750	5-7	2-3	Cut into spikes or slices.
Leeks	250	1/2 cup	750	5-7	2-3	Cut into rings or pieces.
Frozen Brussel sprouts	300	1/2 cup	750	6-8	2-3	
Sauerkraut	250	1/2 cup	750	8-10	2-3	

¹⁾ Cook all vegetables in a covered container.

l = litre

Cooking fish

Description	Weight in (g)	Power (Watt)	Duration (mins)	Standing time (mins)	Remarks/Hints
Fish fillets	500	600	10-12	3	Cook covered. Turn half-way through cooking time.
Whole fish	800	1. 750	3-5	3	Cover during cooking. Turn half-way through cooking time.
		2. 450	10-12		



The times stated here are for guidance only, and depend on the nature and type of food being cooked.

Practical tips for use

General

- After switching off your appliance, let food stand inside for a few minutes to allow even heat distribution (**standing time**).
- Remove any aluminium foil or packaging containing metal before preparing the food.
- Metal objects must be placed at least 2cm away from the cooking space walls and door. Otherwise arcing can occur, resulting in damage to the appliance.
- Check food frequently when grilling, **especially when using the high grill rack**.

Cooking

- Whenever possible cook food covered. Only pastry dishes with crust should be cooked uncovered.
- Refrigerated or frozen food require longer cooking times.
- Foods containing sauces should be stirred from time to time.
- Cook firm vegetables such as carrots, peas and cauliflower with a little water.
- Cook soft vegetables such as mushrooms, peppers and tomatoes without liquid.
- Increase cooking time by approximately 50% for larger pieces. Whenever possible, cut vegetables into equal-sized pieces.

Defrosting of meat, poultry and fish

- Place frozen, unpacked meat on an inverted plate in a glass or porcelain container, or use a sieve, so that the meat juice can drain.
- Halfway through defrosting, turn the food, dividing it where possible and removing the pieces that have defrosted.

Defrosting of butter, pieces of layer cake and cottage cheese

- Do not fully defrost in the appliance, but leave to adjust out-side. This will give a more even result.
- Remove any metal or aluminium foil packaging and/or accessories before defrosting

Defrosting of fruit and vegetables

- Fruit and vegetables that are to be used raw later should not be fully defrosted in the appliance, but left to complete defrosting at room temperature outside the microwave oven.
- Fruit and vegetables that are to be cooked immediately afterwards can be cooked straight from frozen using a higher power level.

Ready made meals

- Ready made meals in metal packages or plastic containers with metal lids should be heated or defrosted in your microwave oven only if they are explicitly marked as being suitable for microwave use. Please follow the operating instructions printed on the packages (e.g. remove the metal lid and prick the plastic foil).



Tips on microwaving

1. You can't find cooking details for a specific quantity of food.

Base programming on a similar type of food. Lengthen or shorten the cooking time accordingly:
Double quantity = almost double time : Half quantity = half time
2. The food is too dry.

Set a shorter cooking time or reduce the microwave power output.
3. The food is not yet defrosted, heated through or cooked on completion of programme time.

Select a longer programme time or a higher microwave power setting. Note that larger food will require a longer time.
4. The food is overcooked on the outside and undercooked in the middle on completion of cooking time.

Next time, try a lower power setting for a longer time. Stir liquids, such as soup, periodically.

Test procedures

(Microwave output power 750 Watt)

The quality and operation of microwave ovens are established by recognised test institutes by testing specific dishes.

DIN Nr. 44 566 Part 2	Power	Time (mins)	Standing time (mins)	Comments ¹⁾
Defrost and cook fish fillets	750 Watt	9-11	3	Cover. Halfway through cooking turn fillets so that inner edges face outwards.
Toast ²⁾	GP3	4-5	-	Pre-heat for 2 minutes.
Grill 2 fillet steaks ³⁾	GP3	28-30	-	Turn the first side when brown.
Grill chicken ³⁾	450 Watt GP2	28-30	3	Turn the first side when brown.

IEC 705	Power	Time (mins)	Standing time (mins)	Comments
Egg custard (test A)	350 Watt	20-21	120	
Sponge mixture (test B)	750 Watt	6-7	5	
Meat loaf (test C)	750 watt	14-15	5	
Defrost minced meat	150 Watt	7-9	5	Place directly on turntable. Turn over halfway through.
Defrost raspberries	150 Watt	16-8	3	Cover.

¹⁾ Place directly on turntable unless otherwise instructed. The turntable has to be switched on.

²⁾ Place toast on wire rack

³⁾ Place fillet steaks & chicken on wire rack. Place the oven-proof glass dish underneath.

Roasting/Grilling Table

Description	Weight (gram)	Grill output power	Time (min.)	Notes
Fish ¹⁾				
mackerel	800-1000	GP3	18-24	Brush with oil. Season with salt and pepper
sardines ¹⁾	6 pieces	GP3	15-20	
Meat ¹⁾				
Sausages ²⁾	6-8 pieces	GP3	22-26	Brush with oil. Season with salt and pepper
Frozen chopped meat	4 pieces	GP3	18-20	
2 Rumpsteak ²⁾ (2-3 cm thick)	400 g each	GP3	25-30	
Snacks				
Toast ²⁾	4 slices	GP3	1-3	Turn over to ensure even browning
Cheese on Toast ³⁾ Toasted snacks time.	2 slices	GP3	5-10	Turn all foods except pizza, halfway through cooking

1) Place dish on turntable under grill rack to catch any liquid.

2) First pre-heat the oven for 2 minutes.

3) Turn the toast halfway through cooking and add the cheese.



The grill temperatures and times given are for guidance only, as they are dependent upon the type and quality of the meat.

Grilling is ideal for flat, pieces of meat and fish.

Unless otherwise stated, the settings given in the table are for use in a cold oven.

Flat foods should be turned only once. Larger, rounder pieces should be turned more often.

Fish are best placed head to tail on the wire shelf.

Combined microwave and grilling table

Description	Weight in (gram)	Accessories	Microwave power (watt)	Grill level	Time (min.)
Noodle casserole	Approx. 500 g pasta	shallow dish	250	GP3	12-17
Potatoes au gratin	Approx 800 g potatoes	shallow dish	750	GP3	20-22
Lasagne	Approx. 800 g	shallow dish	750	GP1	15-20
2 Kippers fresh ¹⁾	Approx 200 g	shallow dish	450	GP3	12-14
Meatloaf	Approx 500 g	deep dish	600	GP3	14-16
Onion soup au gratin	2 bowls (200 g)	soup bowls	450	GP3	4-6

- i** ¹⁾ Place dish on turntable under grill rack to catch any liquid. The range of times given are for guidance only, as they are dependent upon the composition and size of the item being cooked, as well as the desired consistency at the end

Tips on roasting and grilling

The gratin is too dark in colour.

Check the shelf level and both microwave output and grill level power. Next time choose a lower microwave and/or grilling output power

You cannot find any setting in the tables for the weight of your meal.

Choose the setting for something which is closest in weight to the item you want to cook and lengthen or shorten the cooking time accordingly.

i Cleaning and care

The Appliance Exterior

Wipe the front of the appliance using a soft cloth and a mild, warm detergent solution.

Do not use abrasive cleaning substances, strong detergents or coarse abrasive cleaning materials.

Cooking area

The interior will remain in good condition for a long time so long as you don't use scouring pads or rough abrasive materials. Use mild dishwashing liquid to clean the interior.

The grill heating element can be moved into the vertical position for cleaning. **Allow the grill element to cool BEFORE** cleaning inside the appliance. The element may be stained with spattered fat or oil while the oven is in use. Wait until the cavity cools down and wipe off the spattered oil before the oven is used again. Stained grills may cause unpleasant odours and smoke.

You can neutralise odours inside the cooking area by boiling a cup of water with a little lemon juice for a few minutes in your oven.

Through normal operation, liquid may evaporate and condensation may occur. This is normal and is especially noticeable when the room temperature is low and the humidity of the air is high. After operation, be sure and wipe off the condensation with a soft cloth.

Turntable and Turntable support

The turntable and turntable support should be removed for cleaning straight after each use. Clean the turntable using washing-up liquid, or put it in the dishwasher. Clean the turntable support with washing-up liquid.

Care of accessories

Place the wire rack in soapy water immediately after use so it can be easily cleaned with a sponge.

What to do if...

-  ... **the microwave appliance is not working properly ?**
 Check that

 - the fuses in the fuse box are working,
 - there has not been a power outage.
 - If the fuses continue to blow, please contact a qualified electrician.

-  ... **the microwave mode is not working ?**
 Check that

 - the door is properly closed,
 - the door seals and their surfaces are clean,
 - the START-button has been pressed

-  ... **the turntable is not turning ?**
 Check that

 - the turntable support is correctly connected to the drive,
 - the ovenware does not extend beyond the turntable,
 - food does not extend beyond the edge of the turntable preventing it from rotating.
 - there is nothing in the well beneath the turntable.

-  ... **"-d1-" (" -d2-", "-d3-") appears in the display window>**

 - The microwave remains too hot from previous grilling. Let it cool down 15 minutes before reprogramming.

-  ... **the microwave will not switch off ?**

 - Isolate the appliance from the fuse box.
 - Contact your local AEG Service Force Centre.

-  ... **the interior light is not working ?**

 - Call your local AEG Service Force Centre. The interior light bulb can be exchanged only by trained AEG technicians.

-  ... **the food is taking longer to heat through and cook than before ?**

 - Set a longer cooking time (double quantity = nearly double time) or
 - if the food is colder than usual, rotate or turn from time to time or
 - set a higher power setting.

Service and Spare Parts

In the event of your appliance requiring service, or if you wish to purchase spare parts, contact your local AEG Service Force Centre by telephoning:

08705 929 929

Your call will be automatically routed to the Service Centre covering your post code area.

In-guarantee customers should read the section headed 'What to do if...!' and ensure all checks have been made, as the engineer will make a charge if the fault is not a mechanical or electrical breakdown.

Please note that proof of purchase is required for in-guarantee service calls.



Help us to help you

Please determine your type of enquiry before writing or telephoning. When you contact us we need to know:

- Your name
- Address and post code
- Telephone number
- Clear and concise details of the fault.
- Name and model of the appliance
- E number (9 digit number found on the rating plate)

This information can be found on the rating plate in the interior of the appliance at the left.

Customer Service

For general enquiries or information regarding AEG appliances contact:

Customer Services Department
AEG Domestic Appliances
55-77 High Street
Slough
Berkshire
SL1 1DZ
Tel.: 08705 350 350

Guarantee Conditions

Guarantee Conditions

AEG offer the following guarantee to the first purchaser of this appliance.

1. The guarantee is valid for 12 months commencing when the appliance is handed over to the first retail purchaser, which must be verified by purchase invoice or similar documentation.
The guarantee does not cover commercial use.
2. The guarantee covers all parts or components which fail due to faulty workmanship or faulty materials. The guarantee does not cover appliances where defects or poor performance are due to misuse, accidental damage, neglect, faulty installation, unauthorised modification or attempted repair, commercial use or failure to observe requirements and recommendations set out in the instruction book.
This guarantee does not cover such parts as light bulbs or removable glassware.
3. Should guarantee repairs be necessary the purchaser must inform the nearest customer service office (manufacturer's service or authorised agent). AEG reserves the right to stipulate the place of the repair (i.e. the customer's home, place of installation or AEG workshop).
4. The guarantee or free replacement includes both labour and materials.
5. Repairs carried out under guarantee do not extend the guarantee period of the appliance. Parts removed during guarantee repairs become the property of AEG.
6. The purchaser's statutory rights are not affected by this guarantee.

European Guarantee

If you should move to another country within Europe then your guarantee moves with you to your new home subject to the following qualifications:

- The guarantee starts from the date you first purchased your product.
- The guarantee is for the same period and to the same extent for labour and parts as exist in the new country of use for this brand or range of products.
- This guarantee relates to you and cannot be transferred to another user.
- Your new home is within the European Community (EC) or European Free Trade Area.
- The product is installed and used in accordance with our instructions and is only used domestically, i.e. a normal household.
- The product is installed taking into account regulations in your new country.

Before you move please contact your nearest Customer Care Centre, listed below, to give them details of your new home. They will then ensure that the local Service Organisation is aware of your move and able to look after you and your appliances.

France	Senlis	+33 (0) 44 62 29 29
Germany	Nürnberg	+49 (0) 911 323 2600
Italy	Pordenone	+39 (0) 1678 47053
Sweden	Stockholm	+46 (0) 8 738 7910
UK	Slough	+44 (0) 1753 219899

AEG Domestic Appliances
Cornwall House
55 - 77 High Street
SLOUGH
SL1 1DZ

Telephone: 08705 350350

©Copyright by AEG

8221912-24 -01/200 9862401