

13. QUALITY CERTIFICATE

The DN 310 is suited for usage.

Production date _____

Serial number _____

Quality control _____

Purchase date _____

Salesman _____

Quality inspector _____

(Signature)



NIGHT VISION RIFLESCOPE
DN310
(Camera/Video Adaptable)

IMPORTANT INFORMATION

Read prior to activation

You have just purchased a complicated electronic device. To operate it properly, please read this manual carefully. Here are some common precautions that must be noted.

- **NEVER** disassemble the unit. This device contains high voltage, which may be hazardous to your health!
- **NEVER** aim active unit at intense light sources (i.e. lights, headlamps, campfires, the moon, etc.)
- **NEVER** reverse the polarity of a battery
- **NEVER** connect the unit to external power sources
- **ALWAYS** remove batteries when not in use for a long period
- **ALWAYS** keep the objective lenses covered when not in use
- **ALWAYS** store in a warm dry place when not in use

FEATURES OF THE DN 310 NIGHT-VISION SCOPE

- Long range of vision (400-700 m)
- High photo cathode sensitivity for low light levels (10^{-3} - 10^{-4} Lux - cloudy night sky).
- High resolution 25 mm 2nd. Gen. Tube and special light-collecting optics provide bright, sharp image of consistent quality in the center and on the edges
- Recoil proof at large caliber rifles (bullet output energy up to 6500 J)
- Manual brightness override allows choosing an optimum ratio between light amplification, brightness and noise, useful for different observation circumstances.

11. WARRANTY

NEWCON OPTIK warrants this product against defects in material and workmanship for one year from the date of the original date of consumer's purchase, but no more than 18 months from the date of manufacturing. Should your Newcon product prove defective during this period, please bring the product securely packaged in its original container or an equivalent, along with proof of the date of original purchase, to your Newcon Dealer. Newcon will repair (or at its option replace), the product or part thereof, which, on inspection by Newcon, is found to be defective in materials or workmanship.

What This Warranty Does Not Cover:

NEWCON is not responsible for warranty service should the product fail to be properly maintained or fail to function properly as a result of misuse, abuse, improper installation, neglect, damage caused by disasters such as fire, flood, lightning, improper electrical current, or service other than by a NEWCON Authorized Service. Postage, insurance, or shipping costs incurred in presenting your NEWCON product for warranty service are your responsibility. Please include a check or money order made out to NEWCON OPTIK for the amount of \$10.00 to cover shipping and handling. This covers products shipped in USA or Canada only.

12. CUSTOMER SUPPORT

Should you experience any difficulties with your Newcon OPTIK product, consult the enclosed manual. If the problem remains unresolved, contact our customer support department at (416) 663-6963 or Toll free at 1-877-398-6666. Our operating hours are 9am-5pm, Monday - Friday, Standard East Time. At no time should equipment be sent back to Newcon without following the instructions of our technical support department.

Newcon accepts no responsibility for unauthorized returns.

To locate NEWCON Authorized Dealer call:

Tel: (416) 663-6963 Fax: (416) 663-9065

Email: NEWCONSALES@NEWCON-OPTIK.COM

INTERNET: <http://WWW.NEWCON-OPTIK.COM>

The defective products should be shipped to:

In USA: 3310 Prospect Ave. Cleveland, OH 44115

In Canada: 1183 Finch Ave. W., Suite 302, Toronto, ON M3J 2G2

International: 1183 Finch Ave. W., Suite 302, Toronto, ON M3J 2G2

10. TROUBLE SHOOTING

The scope does not work.

Check that the batteries are installed properly. Check the charge of the batteries. Replace if they are weak. Do not use old batteries with new ones.

The image does not appear in focus.

Bring the inspected object to the center of the image. Turning the objective lens ring (10), and/or the eyepiece (3) adjust to achieve the clearest image on the screen. Repeat the steps of focusing if necessary. If the view still does not seem in focus, clean the lenses. They could be foggy or dusty.

Image has disappeared.

When bright light gets into the objective lens of the night vision device it may result in disappearing of the image as the automatic shut-off feature comes into action to protect the device. Whenever this happens, turn the switch to the OFF position. In a minute or two the device will be ready for further operation.

If the image has been lost at the moment of a shot, check contacts in the battery compartment.

Condensation accumulates on the parts

In order to avoid misting of the eyepiece lens in cold time use special protective covers.

Indistinct movement of aiming reticule.

When adjusting the scope it is desirable to rotate the screw of horizontal replacement for 2-5 clicks in one direction, and then put the vertical adjustment screw in the initial position.

Black dots on the screen

These are the cosmetic blemishes in the image intensifier, that do not affect the performance or reliability of a night vision device and some number of varying size are inherent in the manufacturing process. Most of them are seen at daytime only and become almost invisible during the nighttime operation.

Bright spots on the screen

The image may contain some bright spots caused by gradual relief of static electricity from the cathode. This feature may appear immediately after the assembling of the device or attaching/detaching of the objective lens, and it always disappears within 5-14 days of usage or storage.

- Water-resistant
- Built-in powerful I/R illuminator (good for over 200 m)
- Automatic brightness protection
- Camera/video adaptable
- Precision internal windage/elevation adjustments
- Standard weaver mount
- Long eye relief
- Low power consumption. Standard and commonly available 2AA batteries ensure nonstop operation of the device for no less than 50 hours.
- Protection from the lateral and dot light sources
- Compact size and light weight

CONTENTS

1. Brief description
2. Appearance of the device
3. Technical characteristics
4. Supplied accessories
5. Operation instructions
 - a. Battery installation
 - b. Testing of operation
 - c. Operation at night
 - d. Using the optional 2x magnifier lens
6. Installing on a hunting rifle
 - a. Variant I – Adapter rail with Standard prism type.
 - b. Variant II – Adapter rail with 7/8” Weaver prism type
 - c. Variant III – Side rail for East European (Warsaw Pact) rifles
7. Adjustment of the scope on the rifle
8. Taking photos and video shooting
9. Storage and maintenance instructions
10. Trouble shooting
11. Warranty
12. Customer Support
13. Quality certificate

BEFORE USE CAREFULLY READ ALL THE INSTRUCTIONS!

FAILURE TO OBEY THE INSTRUCTIONS WILL VOID THE WARRANTY.

1. BRIEF DESCRIPTION

DN 310 Night Vision Scope is a modern, universal night vision device designed for a wide range of activities from amateur to professional needs:

- Nighttime observation and hunting
- Law enforcement and security
- Search and rescue
- Wildlife observation
- Nighttime photography and video

The device is equipped with a Second Generation high-quality electro-optical image intensifier (Gen. II, 25mm MCP) utilizing the principle of multiple intensification of the image brightness in the visible and IR spectrum which guarantees an up to 400 – 700 m observation range.

NOTE.

Detection and recognition range provided by the device depends on the type of the objective lens used and the observation conditions: light available, transparency of the atmosphere and target quality. The identification range increases in the conditions of high light, at moon night, if the target is situated on a light background (sand, snow). The identification range decreases in the conditions of low light, low transparency of the atmosphere, if the target is situated on a dark background (plough-land, stems of trees, etc.).

9. STORAGE AND MAINTENANCE INSTRUCTIONS.

Warning!

After transportation or keeping the device at temperature lower than -40°C (-40°F), the device must be warmed up to ambient temperature, from -10°C (14°F) to +40°C (104°F), relative humidity of 80% max. at 20°C (68°F).

Precautions

DN-310 is a sophisticated precision optical instrument equipped with electronics.

Therefore, it should be handled with due care.

- Keep your device away from direct sunlight, impacts, dust, moisture, and sudden changes of temperatures.
- Do not keep the device at temperatures higher than 60°C (140°F).
- Do not touch the optical surfaces with fingers. Doing so may damage the anti-reflection coating.
- Cleaning of optical surfaces is only allowed with professional camera lens cleaning supplies.
- To clean the exterior of the device, use a soft clean cloth.
- Do not take the cover off the lens if not necessary.
- Keep away from heating appliances and central heating.
- Make sure to switch off the unit during periods of non-operation and when storing the device for long period of time.
- Do not apply superfluous efforts at work with lens assembly, agile elements and thread connections.
- Due to considerable optical magnification of the eyepiece some small structures inside the tube coating in the form of dark and/or white points may be seen in the field of view, which does not affect the serviceability of the device.

2. Remove the rubber eyepiece guard from the scope.
3. Set the eyepiece in the medium position.
4. Screw the adapter ring with the camera in an internal groove of an eyepiece.
5. Switch on the device and focus the assembled system with the help of the objectives of the device and camera. If the image cannot be focused the camera with the ring should be removed and the coupling of the eyepiece of the device should be rotated a little. Assemble the system again and check it's focusing. At some position of the eyepiece and objective of the camera the system will be focused exactly.
6. Fasten the adapter ring with the camera to the body of the eyepiece of the device with the help of three locking screws. During further photo shooting sharpness of the system is obtained with the help of the objective of the DN 310 only;
7. Set diaphragm on the objective of the camera equal 2.8 or 4 (shooting is possible even at lower diaphragm settings, for example 2, but the obtained pictures will have worse resolution). Taking photos with a completely opened diaphragm of the objective is justified for the shooting of quickly moving objects only.

The TTL system, which is installed at most SLR cameras, easily estimates exposure during the shooting with the device. If your camera is not equipped with the TTL system, the table can approximately estimate the shutter speed at the diaphragm number of the camera equal 2.0:

ISO	50	100	200	400	800	1600	3200
Shutter speed, sec.	1	1/2	1/4	1/8	1/15	1/30	1/60

NOTES.

Use an ISO 400 film or higher. Usage of a tripod is strongly recommended to achieve higher quality photos.

2. EXTERNAL APPEARANCE OF THE DEVICE

Objective lens 64mm / F1.2

Objective lens 100mm / F1.5

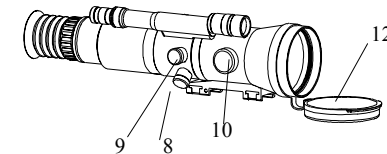
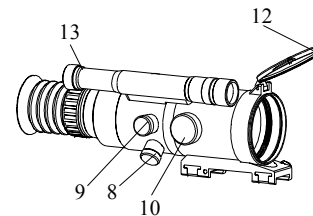
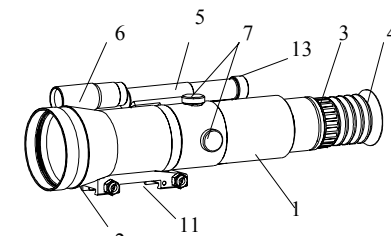
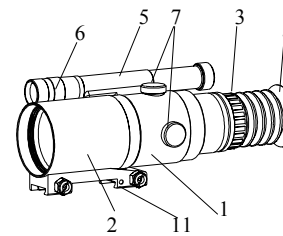

- 1 – Body of the device;
- 2 – Objective lens;
- 3 – Eyepiece;
- 4 – Rubber eyepiece guard;
- 5 – Battery compartment;
- 6 – I/R illuminator;
- 7 – Internal windage/elevation adjustment knobs;
- 8 – On/Off/power alteration switch for the IR illuminator;
- 9 – Brightness control knob;
- 10 – Objective lens focus ring;
- 11 – Weaver mount;
- 12 – Objective lens cover;
- 13 – On/Off switch of the unit.

3. TECHNICAL CHARACTERISTICS

<u>General</u>		
Magnification, x	2.8 (5.2*)	4.4
Field of view, degree	17 (9*)	10
<u>Objective lens</u>		
Focus length, mm	64 (128)	100
F-number	1.2	1.5
Focus range	10 m to infinity	
<u>Eyepiece</u>		
Focus length, mm	35	
Eye Relief Distance, mm	45	
Dioptr setting	+3, -4	
<u>Mechanical characteristics</u>		
Overall dimensions, mm	225 x 82 x 74	252 x 82 x 74
Weight, kg	0.97	1.10
<u>Working conditions</u>		
Temperature range	-40 °C to +50 °C	
Relative humidity	0 to 98%	

* with optional 2x lens (doubled magnification).

<u>Electrical parameters</u>	
Power supply	2 batteries (AA type)
Voltage, V	3
Continuous work time, h, minimum	
- Stand-by mode (no I/R)	60
- Active mode (with I/R)	5
<u>Image intensifier tube</u>	
Type	Gen. II, 25mm MCP
Photo cathode sensitivity, $\mu\text{A}/\text{lm}$	230-440
Gain, maximum	50,000
Resolution, Lp/mm	41-45
<u>Infrared illuminator</u>	
Type	IR diode
Power, mW	75
Illumination angle, degree	8-10
Illumination Spectrum, nm	805

P.S. Technical characteristics may be improved without prior notice.

- Make a control shot and find out whether the aiming point coincides with the bullet hit point. (Make the correction again if necessary);
- Set the protective caps into their places.
The device is ready for operation.

While performing the adjustment it should be considered that the marking displacement mechanism of the device is equipped with a click holder that displaces the marking both in vertical and horizontal direction.

Focus length of the objective lens, mm	64	100
One click shift of the marking at the distance of 100 m, mm	54	34
At 100 yards, inches (")	1.944	1.244

8. TAKING PHOTOS AND VIDEO SHOOTING

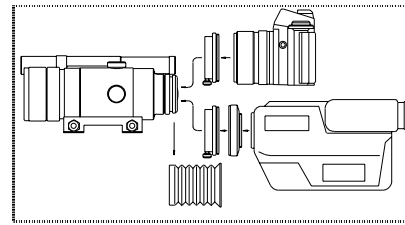

DN 310 can be supplied with an optional adapter for photo/video devices for night photo/video shooting.

Night photo shooting with DN 310 is easily performed using 35mm SLR cameras such as

Nikon, Canon, Pentax etc. with standard objective lens (50-58 mm focus).

Preparation of the device for photo shooting:

- Screw the adapter ring supplied in the set (diameter 52mm or 37mm) into the setting place of the light filter of the objective lens in your camera. If the objective lens of your camera has another setting diameter for a light filter (for example, 49mm or 58mm) you have to purchase step up or step down adapter rings from the 52 mm to your size. Such adapters are typically sold at camera stores.

7. ADJUSTMENT OF THE SCOPE ON THE RIFLE

Dimensions of the Reticule

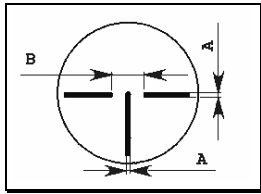

The dimensions listed below are good for shooting range of 100m. For a distance other than 100m the dimensions must be calculated accordingly in proportion.

Focus length of the objective lens, mm	64	100
Crosshair width - A, mm	17	11
Interval - B, m	1.4	0.9

Before adjusting of the scope its objective should be set for a distant object (select infinity) in daylight or at dark time with the opened cover of the objective.

The adjustment of the scope should be performed either in daytime with the closed cover of the objective or in the twilight on the adjusted target or on the remote point.

Adjustment of the sight is performed in the following way:

1. Fix the scope on the rifle.
2. Set a panel with a target or select the point of aiming.
3. Set the rifle on the scoped machine.
4. Direct the rifle to the point of aiming by mechanical sight (bead with a slot) (if it is possible). At this stage it is suitable to apply laser of cold test shooting (LCTS) inserted in the barrel of the rifle, which indicates geometrical point of the barrel position (sold separately).
5. Unscrew the protective caps of the reticule adjustment screws. Turning those screws obtain the matching of reticule crosshairs with the aimed point, set by the mechanical sight or LCTS;
6. Remove the rifle from scoped machine and take out LCTS;
7. Make 2-3 shots. Having examined the target make necessary corrections (for example, in order to move the hit point downwards and leftwards, screws of the mechanism should be turned counter clockwise, in the directions Down and Left correspondingly. The aiming point is moving upwards and rightwards);

4. SUPPLIED ACCESSORIES

DN310 is supplied in the following assembly:

- Device	1 pc.
- Objective lens cap	1 pc.
- Built-in IR illuminator	1 pc.
- Rubber eyepiece guard	1 pc.
- Weaver rifle mount	1 pc.
- Camera/video adapter (52mm/37mm)	1 pc./each
- User's manual	1 pc.
- Warranty card	1 pc.
- Case	1 pc.
<u>Optional accessories:</u>	
-2x Magnification Lens	1 pc.
-Weaver rail rifle mount (7/8")	1 pc.
-Side mount for East European type rifle.	1 pc.

5. OPERATION INSTRUCTIONS

WARNING!

**NEVER OPERATE YOUR NIGHT VISION DEVICE IN DAYLIGHT AREAS WITHOUT THE LENS COVER ON!
NEVER AIM THE LENS IN THE DIRECTION OF BRIGHT LIGHT!**

a. Battery installation

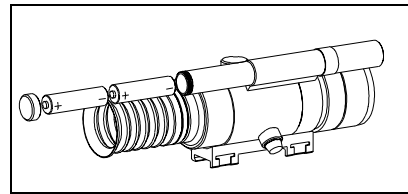

DN 310 requires two AA batteries. Make sure that the batteries are in good condition and polarity is installed as it is indicated on the body of battery compartment (5).

In order to change the batteries unscrew the cover of battery compartment (5) and install the new batteries, observing correct polarity.

NOTE. In order to ensure the longest operation time of the device and full power of the IR illuminator (using one set of batteries) it is recommended to use Alkaline batteries, which ensure the most stable performance.

b. Testing of operation

During the bright time of the day:

Turn on the on/off switch (13). Lens cap (12) must be on. Direct the device at an object placed within 10-20 m from the viewer. Turning the focus ring (10), eye-piece (3) and the brightness control (9) try to achieve the sharpest image on the screen of the image tube.

CAUTION!

The device is not supposed to be directed at a bright source of light: bright lamps, the sun, welding and etc – it may result in the reduction of the light gain of the device. In order to avoid the fatigue of photo-cathode it is not allowed to leave the active device motionless in the excessively bright environment (dawn, dusk, daylight, etc.) for more than 30 minutes.

c. Operation at night

AT MOON LIGHT: Take off the lens cover (12). Turn on the device-using switch (13). Turning the eyepiece (3) adjust to achieve the most clear image on the screen. Then obtain the most clear-cut image of the object focusing with ring (10). Repeat the steps of focusing if necessary.

AT INSUFFICIENT AMBIENT ILLUMINATION: use the Infra/Red illuminator (6) activated by rotating switch (8) clockwise. Select one of three positions of the switch for different power settings (10, 25 or 75 mW). Furthermore, turn the brightness control knob (9) for a brighter image.

If brightness of the screen is decreasing, replace the batteries. Take out the batteries during long periods of non-operation.

Do not forget to switch the device off after end of WORK!

- Place the scope on the rail of the rifle in such a position when your eye coincides with the edge of the Eyepiece Guard or in case of a large caliber (for example, .375 H&H Mag) your eye should be situated at the distance of 2-5cm from the edge of the Eyepiece Guard. The device should be located in the position which allows comfortable observation without stretching forward;
- Place inserts (4,5) in the apertures of the rail (3). The insert (4) is placed with a projection (B) looking downwards in the nearest slot on the rail of the rifle. If there is no such a slot, the insert (4) is placed with a projection (B) looking upwards. It is recommended to place the inserts at the maximum possible distance from each other;

Place clamps (6) and clamp screws (7) in the inserts (4,5). Tighten screws (6,7) in order to obtain hard fixation. When necessary the excessive front part of the rail (3) can be removed.

Adaptation has been completed and the device is ready for use as a hunter's scope.

c. Variant III – side rail for East European (Warsaw Pact) rifles.

Side rail can be used for the installation of DN 310 on a hunting rifle with side rail.

The appearance of the device with a side rail is shown below:

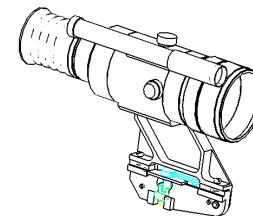

It is recommended to contact NEWCON OPTIK for installation of the side rail.

ATTENTION! In case you use other type of binding, to eliminate the phenomenon of shooting point displacement, device binding should be advised with Newcon Optik, because usually such displacement is caused by unqualified installation.

- 1- body of the device
- 2- adapter rail with 7/8" Weaver prism encompassing:

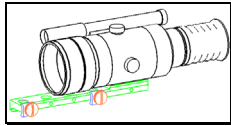

- 3- fastening screws
- 4- insert rest
- 5- insert
- 6- clamp
- 7- clamp screw.

(All parts of the alignment are supplied by Newcon Optik).

Installation of the device is performed as follows:

- Check the elevation of the fastening screws (2), pulling the rail (3) to the body of the device (1) above the upper surface of the rail. The height of elevation must not exceed 3.0mm and must not be less than 2.5mm. It is especially important when the body of the device has a blind aperture with a thread (front hole for the device with a 64 mm objective). The elevation should not exceed 3.5mm for through holes and should not be less than 2.5mm. This requirement can be met by cutting axle length of the screws from the side of the thread;
- Prepare the glue (glue is needed, for example, epoxy with the tear strength not less than 200kg/cm²) according to its preparation instruction, and put it on the surface (A) of the plate. The surface of the screws should not have any glue. This condition is of a considerable importance, since it provides an opportunity to repair the device and remove the alignment plate for further adaptation to another rifle;
- Apply a hermetic substance (of silicone type) on the thread of the screws (2);
- Fix the rail to the body of the scope with the help of the screws (2) cut at the required length;
- Remove glue surpluses appeared in the place of alignment of the rail with the body with a dry napkin and let the glue solidify in accordance to its instruction (for example, 24 hours in case of epoxy glue);

d. Using 2x magnifier lens

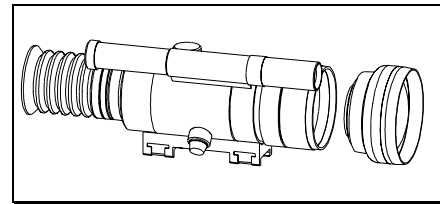

Your DN 310 (equipped with the 64mmF/1.2 objective lens) can be used with an optional 2x magnifier lens in order to obtain double magnification. The lens (marked as 2x) doubles focal length of the objective. It can be mounted on a setting thread behind the light filter of the objective lens (external side of the objective). The 2x magnifier lens must be tightened to the rest.

NOTE! In case of simultaneous usage of the IR illuminator and 2x magnifier lens partial darkening of the image may occur, as the large 2x lens overlays the light beam from the IR illuminator. To avoid this the device should be ordered with Z-like shape I/R illuminator.

Prior to ordering of the 2x magnifier lens for the device with a weaver mount, it is necessary to check if it is possible to install the 80 mm diameter 2x lens.

6. INSTALLING ON A HUNTING RIFLE

Night vision device DN 310 may be used as a nighttime hunting scope.

Recommendation. The usage of night vision riflescopes for hunting may be limited or illegal in your area. Please, check with local authorities prior to usage.

Device may be used with various mounts that facilitates reliable fixation of the device to a particular rifle.

For convenient installation the device is supplied without stiff fixation of the binding to the device, and in most cases that enables to perform the device installation to a specific rifle model. For installation you should contact a specialised armourer workshop (gunsmith) or – if you are qualified enough – perform the installation yourself.

INSTALLATION RULES.

a. Variant I – Adapter rail with Standard Prism type.

Device is fixed with the help of the following parts:

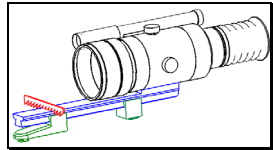
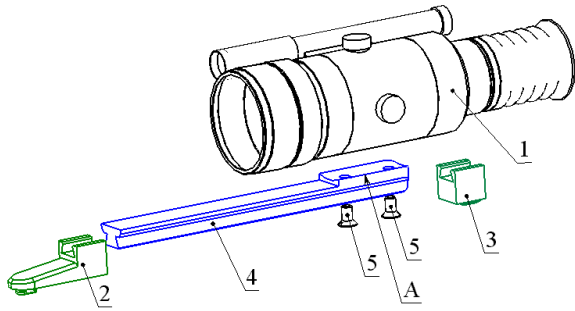

- 1- Device body
- 2- Front cradle for Standard prism
- 3- Rear feet for Standard prism
- 4- Mount of the Standard prism type
- 5- Fixing screws

Front and rear feet (2, 3) are the standard feet with Standard prism (4), manufactured by the companies that produce mounts (for example, Ernst Apel GmbH Germany)). The mount of Standard prism type (4) and screws (5) are optional. Installation of the device should be performed according to the following rules:

- Check the prominence of fixation screws (5) that bind the prism (4) to the body (1) of the device over the top surface of the prism. The prominence must not be less than 2.5 mm or more than 3.0 mm. This is especially important if in the body of the device there is a dead threaded hole. For the reach-through holes the prominence may reach 3.5 mm, but must not be less than 2.5 mm. In order to meet this requirement you can cut the threaded part of the screws at length;

- Install the feet onto the rail (4). Insert the feet (2, 3) in the rifle. Sliding the rail in the feet, find the position, in which your eye will meet the edge of the eyeshade of the device or will be 2-5 cm apart for big calibres (like .375 H&H Mag). The position of the device must be comfortable enough so that you would not have to reach forward for convenient observation;
- Cut the excessive part of the rail (4);
- Keeping the chosen position of the device, fix the feet (2, 3) to the rail (4) according on the instruction of the feet producer;
- Prepare the glue according to an instruction (the glue need to be of a certain strength not less than 200 kg/cm^2 , for example epoxy) and apply it to (A) surface of the rail. The surface of the screws must remain free of the glue. This is especially important for possibility to repair the device or to remove the binding rail for installation on a different rifles;
- Apply hermetic (silicone type) to the threading of the screws (5).
- Fix the bar to the body of the device with the help of the screws (5), cut to meet the needed length;
- Remove excessive glue (that is pushed out in the points the rail is connected to the body of the device) with the help of dry cloth and alcohol-moistened cotton wool, and let the glue take according to its instruction (for example, 24 hours for epoxy).

Installation is completed and the device is ready for use as a hunting scope.

b. Variant II – Adapter rail with 7/8" Weaver prism type.

Fastening of the device is made with the help of the following parts:

