

User's Guide

**EVGA X58 FTW<sup>3</sup>**

**Motherboard**



# Table of Contents

User's Guide .....	1
EVGA X58 FTW <sup>3</sup> .....	1
Motherboard.....	1
Before You Begin... ..	8
Parts NOT in the Kit.....	9
Intentions of the Kit.....	9
Motherboard.....	10
Motherboard Specifications .....	10
Unpacking and Parts Descriptions.....	12
Unpacking .....	12
Equipment .....	12
EVGA X58 FTW3 Motherboard.....	14
Hardware Installation .....	17
Safety Instructions.....	17
Preparing the Motherboard.....	18
Installing the CPU.....	18
Installing the CPU Fan.....	19
Installing System Memory (DIMMs) .....	20
Installing the Motherboard .....	21
Installing the I/O Shield.....	21
Securing the Motherboard into a System Case .....	22
Connecting Cables.....	22
24-pin ATX Power (PW1).....	23

8-pin ATX 12V Power (PW12).....	24
Connecting IDE Hard Disk Drives .....	24
Connecting SATA Cables.....	25
Connecting Internal Headers.....	26
Front Panel Header .....	26
IEEE1394a (Firewire) .....	27
USB Headers .....	28
Audio .....	29
Fan Connections .....	30
COM1 .....	31
Expansion Slots.....	31
PCI Slots.....	32
PCI-E x1 Slots .....	32
PCI-E x16/x8 Slots .....	32
Onboard Buttons .....	33
Clear CMOS Button .....	33
RESET and POWER Button .....	33
Post Port Debug LED and LED Status Indicators.....	34
Post Port Debug LED .....	34
LED Status Indicators.....	34
Configuring the BIOS .....	35
Enter BIOS Setup.....	36
Main Menu .....	36
Standard CMOS Features Menu.....	39
Date and Time.....	40
SATA Channel.....	40
Halt On.....	42
Memory.....	42

Advanced BIOS Features .....	43
Hard Disk Boot Priority .....	44
CD-ROM Device Priority .....	44
First/Second/Third Boot Device .....	44
Boot Other Device .....	45
Boot Up NumLock Status .....	45
Security Option .....	45
Integrated Peripherals Menu .....	46
Legacy Devices .....	46
OnChip PATA/SATA Device .....	47
Onboard Device .....	48
USB Device Settings .....	49
Power Management Setup Menu .....	50
ACPI Function .....	50
ACPI Suspend Type .....	51
Run VGABIOS if S3 Resume .....	51
Soft-Off by PWR-BTTN .....	51
Wake-Up by PCI Card .....	51
USB KB Wake-Up From S3 .....	51
Resume by Alarm .....	51
POWER ON Function .....	52
Hot Key Power On .....	52
PWRON after PWR-Fail .....	52
PnP/PCI Configuration Menu .....	53
Init Display First .....	53
Reset Configuration Data .....	54
Resources Controlled By .....	54
IRQ Resources .....	54

EVGA X58 FTW3 Motherboard

PCI/VGA Palette Snoop .....	55
INT Pin 1/2/3/4/5/6/7/8 Assignment.....	55
Maximum Payload Size .....	55
PC Health Status Menu .....	56
SmartFan Function.....	57
Frequency/Voltage Control Menu.....	58
Memory Feature.....	59
Voltage Control.....	61
CPU Feature.....	63
Installing Drivers and Software .....	65
Windows XP/Vista/Win 7 Driver Installation.....	65
Appendix A. POST Codes.....	67
EVGA Glossary of Terms.....	74
Compliance Information .....	77

## List of Figures

Figure 1.	EVGA X58 FTW3 Motherboard Layout .....	14
Figure 2.	Chassis Back Panel Connectors .....	16
Figure 3.	PW1 Motherboard Connector .....	23
Figure 4.	BIOS CMOS Setup Utility Main Menu .....	37
Figure 5.	Standard CMOS Features Menu .....	39
Figure 6.	Advanced BIOS Features Menu .....	43
Figure 7.	Integrated Peripherals Menu .....	46
Figure 8.	Power Management Setup Menu .....	50
Figure 9.	PnP/PCI Configuration Menu .....	53
Figure 10.	PC Health Status Menu .....	56
Figure 11.	Frequency/Voltage Control Menu .....	58
Figure 12.	Memory Feature Menu .....	59
Figure 13.	Voltage Control .....	61
Figure 14.	CPU Feature Menu .....	63

## Before You Begin...

Thank you for purchasing the EVGA X58 FTW3 Motherboard. This board is designed to take the already excellent performance of the EVGA lineup and push it into the future by adding support for SATA 6Gbps and USB 3.0. Also we have included EVBot support to facilitate your tweaking needs.

As always with this board you also get the added bonus of EVGA's industry leading 24/7 technical support in case you ever have any issues or questions.



---

## Parts NOT in the Kit

This kit contains all the hardware necessary to install and connect your new EVGA X58 FTW3 Motherboard. However, it does not contain the following items that must be purchased separately to make the motherboard functional.

- ❑ **Intel Microprocessor**
- ❑ **System Memory**
- ❑ **Cooling fan for the Microprocessor**
- ❑ **Graphics Card**
- ❑ **Power Supply**

EVGA assumes you have purchased all the necessary parts needed to allow for proper system functionality.

---

## Intentions of the Kit

This kit provides you with the motherboard and all connecting cables necessary to install the motherboard into a system case. If you are *building* a PC, you will use most of the cables provided in the kit. If however, you are *replacing* a motherboard, you will not need many of the cables.

When *replacing* a motherboard in a system case, you will need to reinstall an operating system even though the current Hard Disk Drive may already have an operating system.

# EVGA X58 FTW<sup>3</sup>

## Motherboard

Thank you for purchasing the EVGA X58 FTW3 Motherboard. This motherboard offers enthusiast performance and when combined with two or three SLI-Ready NVIDIA® GeForce® graphics cards, you get innovative NVIDIA® SLI® technology for enhanced system performance.

---

### Motherboard Specifications

- ❑ Size  
ATX form factor of 12 inch x 9.6 inch
- ❑ Microprocessor support  
Intel Core i7 processor
- ❑ Operating systems:  
Supports Windows XP, Windows Vista and Win 7 32 and 64 bit
- ❑ Contains Intel X58 and ICH10R chipset
- ❑ System Memory support  
Supports triple channel DDR3-1600+. Officially supports up to 24GBs of DDR3 memory.
- ❑ USB 2.0 Ports  
Supports hot plug  
Twelve USB 2.0 ports (Eight rear panel ports, four onboard USB headers)  
Supports wake-up from S1 and S3 mode  
Supports USB 2.0 protocol up to a 480 Mbps transmission rate
- ❑ USB 3.0 Ports  
Two USB 3.0 ports (on I/O panel.)  
Backwards compatible USB 2.0 and USB 3.0 support.  
Supports transfer speeds up to 4.8Gbps

- ❑ Six(6) onboard SATA II Ports + 2 onboard SATA3 ports  
300MBps data transfer rate  
Six SATA II connectors from south bridge with support for RAID 0, RAID 1, RAID 0+1, and RAID 5
- ❑ Two (2) SATA3 600MBps onboard ports from Marvell 88SE9128 Chipset
- ❑ Onboard LAN  
Integrated Dual LAN ports  
Supports 10/100/1000 Mbit/sec Ethernet
- ❑ Onboard IEEE1394a (Firewire)  
Support hot plug  
Two IEEE1394a ports (one rear panel port, one onboard header) with a rate transmission of 400 Mbps
- ❑ Onboard Audio  
Realtek High-Definition audio  
Supports 8-channel audio  
Supports Jack-Sensing function
- ❑ Triple PCI-E Support  
Three (3) PCI-E 2.0 Slots  
Supports 4 GB/sec (8 GB/sec concurrent) bandwidth  
Low power consumption and power management features
- ❑ Green Function  
Supports ACPI (Advanced Configuration and Power Interface)  
Supports S0 (normal), S1 (power on suspend), S3 (suspend to RAM), S4 (Suspend to disk - depends on OS), and S5 (soft - off)
- ❑ Expansion Slots  
Two PCI slots  
One PCI-E x1 slot  
Three PCI-E x8/x16 slots

# Unpacking and Parts Descriptions

---

## Unpacking

The EVGA X58 FTW3 Motherboard comes with all the necessary cables for adding a motherboard to a system case. If replacing a motherboard, you may not need many of these cables.

All parts shipped in this kit are RoHS-compliant (lead-free) parts.

---

## Equipment

The following accessories are included with the EVGA X58 FTW3 Motherboard.

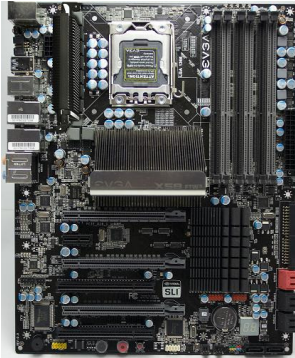

---

### **The EVGA X58 FTW3 Motherboard**

This PCI-E motherboard contains the Intel X58 and ICH10R chipset and is SLI-ready for both 2-Way and 3-Way SLI configurations.



---

### **1 - Visual Guide**

Helps to quickly and visually guide you through the hardware installation of the motherboard.

---



**1 - I/O Shield**

Installs in the system case to block radio frequency transmissions, protect internal components from dust, foreign objects, and aids in proper airflow within the chassis.



**3 - 2-Port SATA Power Cables**

Allows a Molex power connector to adapt to a SATA power connector.



**1 - IEEE1394a (Firewire) Bracket**

Provides one (1) additional IEEE1394a port to the back panel of the chassis.



**1 - 4-Port USB 2.0 Bracket**

Provides four additional USB ports to either the front or back panels of the chassis.



**6 - SATA Data Cables**

Used to support the SATA protocol and each one connects a single drive to the motherboard.



**1 - IDE Data Cable**

Passes data between the IDE connection on the motherboard and IDE device.



**1 - 2-Way SLI Bridge**

Bridges two (2) graphic cards together which allows for 2-Way SLI.



**1 - 3-Way SLI Bridge**

Bridges three (3) graphic cards together which allows for 3-Way SLI.



**1 - Installation CD**

Contains drivers and software needed to setup the motherboard.

---

## EVGA X58 FTW3 Motherboard

The EVGA X58 FTW3 Motherboard with the Intel X58 and ICH10R chipset is a PCI-E, SLI-ready motherboard. Figure 1 shows the motherboard and Figures 2 shows the back panel connectors.

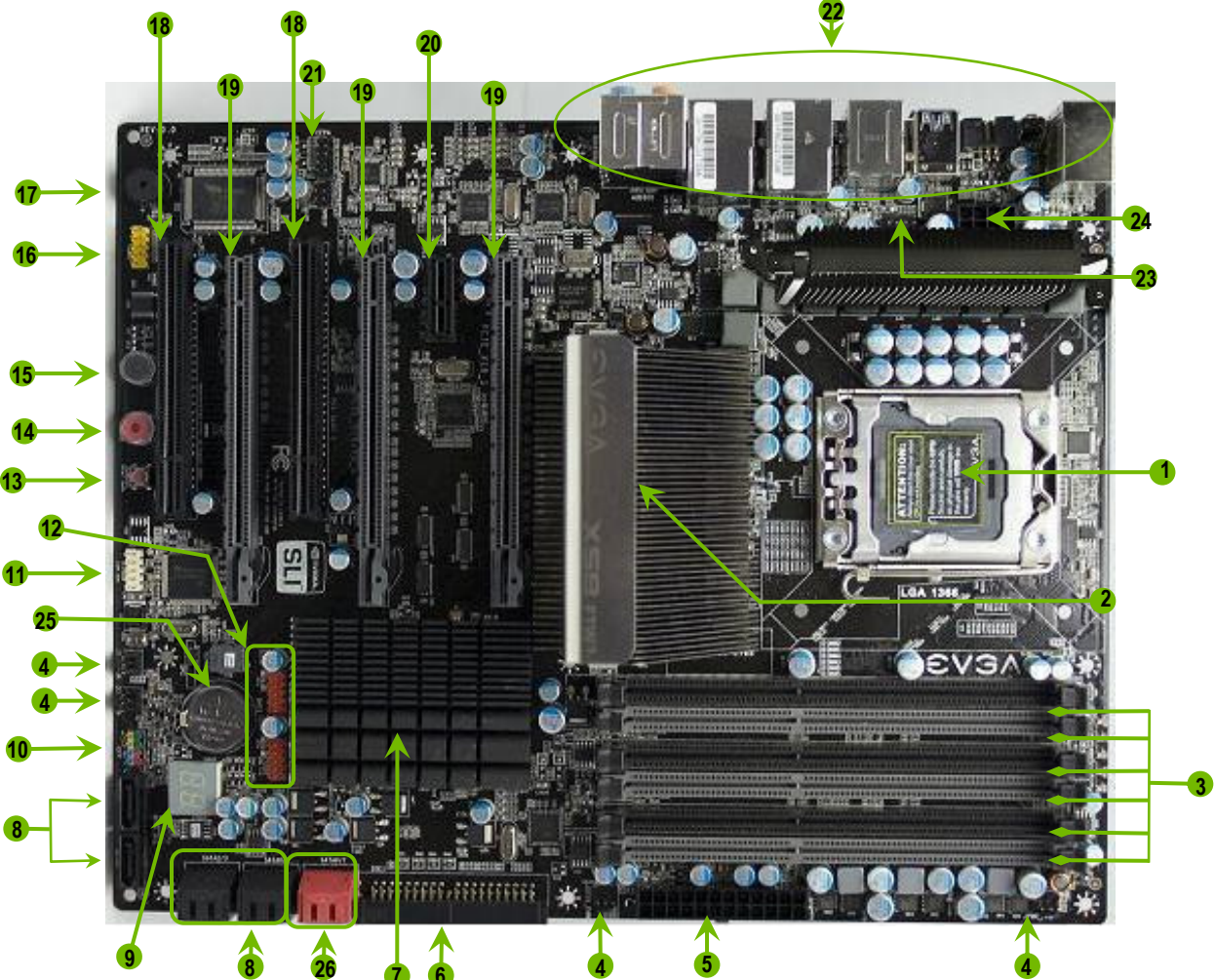

1. CPU Socket 1366	11. IEEE1394a Connector	21. Front Panel Audio Connector
2. Intel X58 Chipset	12. USB Headers	22. Back Panel Connectors (Figure 2)
3. DDR3 DIMM Slots 1 – 6	13. Clear CMOS Button	23. CPU Fan Connector
4. Fan Connectors	14. Power Button	24. 8-pin ATX_12V Power Connector
5. 24-Pin ATX Power Connector	15. Reset Button	25. Motherboard Battery
6. IDE Connector	16. Serial Connector	26. SATA3 600Mbps Ports
7. Intel ICH10R Chipset	17. PC Speaker	
8. Serial-ATA (SATA) Connectors	18. PCI slots	
9. Debug LED Display - CPU Temperature Monitor	19. PCI-E 2.0 Slots	
10. Front Panel Connector	20. PCI-E x1 Slot	

Figure 1. EVGA X58 FTW3 Motherboard Layout

EVGA X58 FTW3 Motherboard

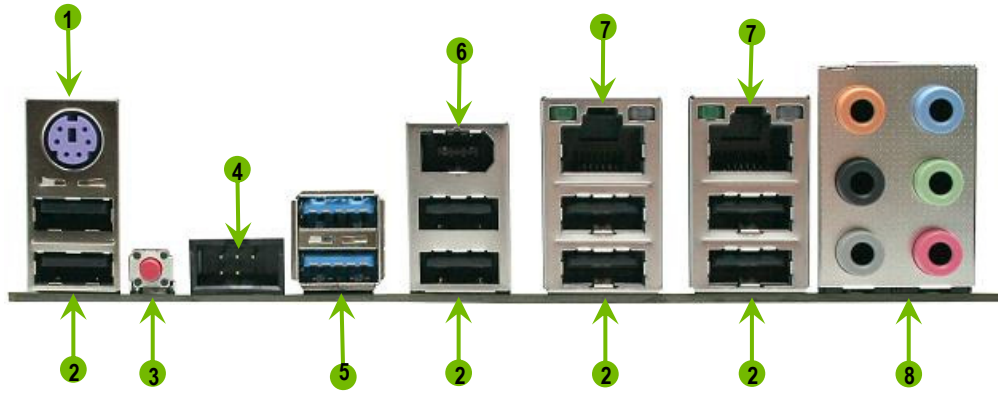

1. PS/2 Keyboard Port
2. USB 2.0 Ports (Eight)
3. Clear CMOS Button
4. EVBot Connector
5. USB 3.0 ports (two)
6. IEEE1394a (Firewire) Port
7. Dual LAN Ports with LEDs to indicate status:

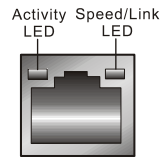

Activity LED Status	Description
Off	No data transmission
Blinking (Green)	Data transmission

Speed/Link LED Status	Description
Yellow	1000 Mbps data rate
Green	100 Mbps data rate
Off	10 Mbps data rate

8. Audio Port	2-Channel	6-Channel	8-Channel
Blue	Line-In	Line-In	Line-In
Green	Line-Out	Front Speaker Out	Front Speaker Out
Pink	Mic In	Mic In	Mic In
Orange		Center/Subwoofer	Center/Subwoofer
Black		Rear Speaker Out	Rear Speaker Out
Grey			Side Speaker Out

Figure 2. Chassis Back Panel Connectors



# Hardware Installation

This section will guide you through the installation of the motherboard. The topics covered in this section are:

- ❑ Preparing the motherboard
  - Installing the CPU
  - Installing the CPU fan
  - Installing the memory
- ❑ Installing the motherboard
- ❑ Connecting cables

---

## Safety Instructions

**To reduce the risk of fire, electric shock, and injury, always follow basic safety precautions.**

**Remember to remove power from your computer by disconnecting the AC main source before removing or installing any equipment from/to the computer chassis.**

---

## Preparing the Motherboard

### Installing the CPU

Be very careful when handling the CPU. Hold the processor only by the edges and do not touch the bottom of the processor.

Use the following procedure to install the CPU onto the motherboard:

Unhook the socket lever by pushing *down* and *away* from the socket.

Put your finger on the tail of the load plate and press down with light pressure to lift the load plate up.

Lift the load plate. There is a protective socket cover within the CPU socket to protect the socket when there is no CPU installed.

Remove the protective socket cover from the CPU Socket.

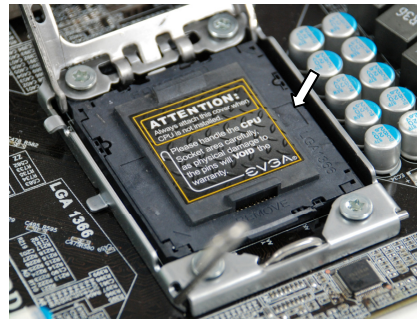

---

**Note:** After removing the CPU socket cover, it is recommended that you keep it in case you need to remove CPU for any reason you can replace the cover to avoid damaging the CPU socket pins.

---

Align the notches in the processor with the notches on the socket.

Lower the processor straight down into the socket without tilting or sliding it into the socket.

---

**Note:** Make sure the CPU is fully seated and level in the socket.

---

Close the load plate over the CPU and press down while you close and engage the socket lever.

The CPU installation is complete.

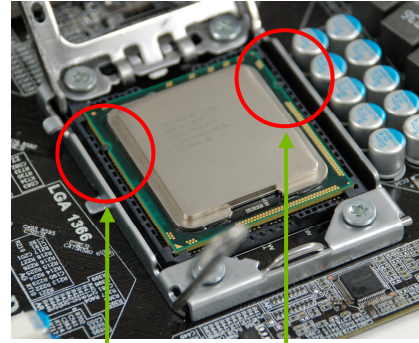

Align notches with notches on the CPU



## Installing the CPU Fan

There are many different fan types that can be used with this motherboard. Follow the instruction that came with your fan assembly. Be sure that the fan orientation is correct for your chassis type and your fan assembly.

## Installing System Memory (DIMMs)

Your new motherboard has six 240-pin slots for DDR3 memory. These slots support 1GB, 2GB, 4GB DDR3 technologies. There must be at least one memory bank populated to ensure normal operation. Use the following recommendations for installing memory. (See Figure 1 on page 15 for the location of the memory slots.)

- ❑ **One DIMM:** If using 1 DIMM (**Single Channel**), install into: **DIMM slot 1.**
- ❑ **Two or Four DIMMs:** If using 2 DIMMs (**Dual Channel**), install into: **DIMM slots 1 and 3.** If using 4 DIMMs (**Dual Channel**), install into: **DIMM slots 2, 1, 4, and 3.**
- ❑ **Three DIMMs:** If using 3 DIMMs (**Triple Channel**), install into: **DIMM slots 1, 3 and 5.**
- ❑ **Six DIMMs:** If using more than 4 DIMMs, use: **DIMM slots 2, 1, 4, and 3** then proceed to occupy the following DIMM slots **in this order: 5 and 6.**



Use the following procedure to install DIMMs. Note that there is only one gap near the center of the DIMM slot. This slot matches the slot on the DIMM to ensure the component is installed properly.

1. Unlock a DIMM slot by pressing the module clips outward.

Align the memory module to the DIMM slot, and insert the module vertically into the DIMM slot. The plastic clips at both sides of the DIMM slot automatically lock the DIMM into the connector.

---

## Installing the Motherboard

The sequence of installing the motherboard into a system case depends on the chassis you are using and if you are replacing an existing motherboard or working with an empty system case. Determine if it would be easier to make all the connections prior to this step or to secure the motherboard and then make all the connections. It is normally easier to secure the motherboard first.

Use the following procedure to install the I/O shield and secure the motherboard into the chassis.

**Note:** Be sure that the CPU fan assembly has enough clearance for the system case covers to lock into place and for the expansion cards. Also make sure the CPU Fan assembly is aligned with the vents on the covers. This will depend on the system case being used.

## Installing the I/O Shield

The motherboard kit comes with an I/O shield that is used to block radio frequency transmissions, protects internal components from dust and foreign objects, and promotes correct airflow within the chassis.

Before installing the motherboard, install the I/O shield from the *inside* of the chassis. Press the I/O shield into place and make sure it fits securely. If the I/O shield does not fit into the chassis, you would need to obtain the proper size from the chassis supplier.

## Securing the Motherboard into a System Case

Most system cases have a base with mounting studs or spacers to allow the motherboard to be secured to the chassis and help to prevent short circuits. If there are studs that do not align with a mounting hole on the motherboard, it is recommended that you remove that stud to prevent the possibility of a short circuit. In most cases, it is recommended to secure the motherboard using a minimum of nine (9) spacers and screws.

1. Carefully place the motherboard onto the stand off /spacers located inside the chassis.

Align the mounting holes with the studs/spacers.

Align the connectors to the I/O shield.

Ensure that the fan assembly is aligned with the chassis vents according to the fan assembly instruction.

Secure the motherboard with a recommended minimum of nine (9) screws.

---

## Connecting Cables

This section takes you through all the necessary connections on the motherboard. This will include:

- ❑ Power Connections
  - 24-pin ATX power (**PW1**)
  - 8-pin ATX 12V power (**PW12**)
- ❑ Internal Headers
  - Front panel
  - IEEE 1394a
  - USB Headers
  - Audio
  - COM
- ❑ IDE
- ❑ SATA II
- ❑ SATA 3

- ❑ Chassis Fans
- ❑ USB 2.0
- ❑ USB 3.0
- ❑ Expansion slots
- ❑ CMOS Clear Button

## 24-pin ATX Power (PW1)

**PW1** is the main power supply connector located along the edge of the board next to the DIMM slots. Make sure that the power supply cable and pins are properly aligned with the connector on the motherboard. Firmly plug the power supply cable into the connector and make sure it is secure.



**PW1** connector  
Plug power cable from system power supply to PW1

Figure 3. PW1 Motherboard Connector

Table 1. PW1 Pin Assignments

Connector	Pin	Signal	Pin	Signal
	1	+3.3V	13	+3.3V
	2	+3.3V	14	-12V
	3	GND	15	GND
	4	+5V	16	PS_ON
	5	GND	17	GND
	6	+5V	18	GND
	7	GND	19	GND
	8	PWROK	20	RSVD
	9	+5V_AUX	21	+5V
	10	+12V	22	+5V
	11	+12V	23	+5V
	12	+3.3V	24	GND

## 8-pin ATX 12V Power (PW12)

**PW12**, the 8-pin ATX 12V power connection, is used to provide power to the CPU. Align the pins to the connector and press firmly until seated.

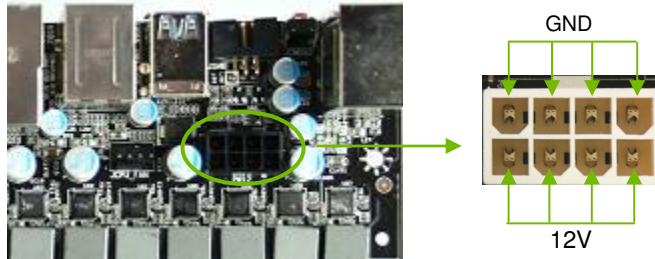

## Connecting IDE Hard Disk Drives

The IDE connector supports Ultra ATA 133/100 IDE hard disk drives.

1. Connect the blue connector (the cable end with a single connector) to the motherboard.
2. Connect the black connector (the cable with the two closely spaced black and gray connectors) to the Ultra ATA master device.
3. Connect the grey connector to a slave device.

If you install two hard disk drives, you must configure the second drive as a slave device by setting its jumper accordingly. Refer to the hard disk documentation for the jumper settings.

**Note:** If an ATA-100 disk drive and a disk drive using any other IDE transfer protocol are attached to the same cable, the maximum transfer rate between the drives may be reduced to that of the slowest drive.

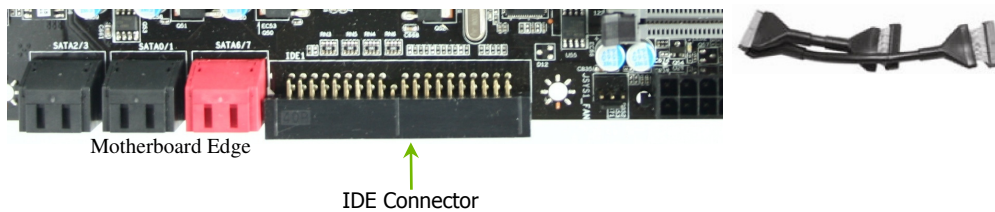



## Connecting SATA Cables

The SATA II connector is used to connect the SATA II device to the motherboard. These connectors support the thin SATA II cables for primary storage devices. The current SATA II interface allows up to 300MB/s data transfer rate.

There Eight (8) internal SATA connectors on this motherboard. Connection points SATA0 - SATA5, are controlled by the South Bridge Chipset and operate at a speed up to 300MB/s.

The Onboard ports that are red in color are SATA3 ports and operate from the Marvell 88SE9128 chipset at a transfer rate up to 600MB/s

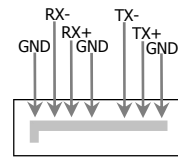
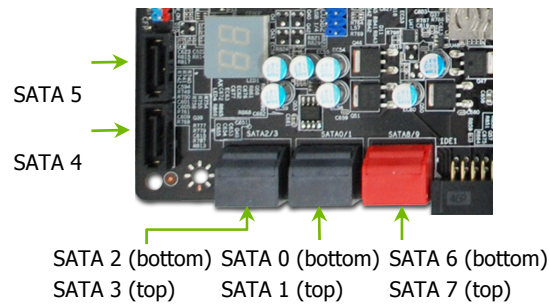

Connect the locking cable end to the motherboard connector.  
Connect the end without the lock to the SATA device.

## Connecting Internal Headers

### Front Panel Header

The front panel header on this motherboard is one connector used to connect the following four cables. (see Table 2 for pin definitions):

❑ **PWRLED**

Attach the front panel power LED cable to these two pins of the connector. The Power LED indicates the system's status. When the system is turn on status, the LED is on. When the system is turned off, the LED is off. When the system is in S1, S1, S3, S4 status, the LED will blink.

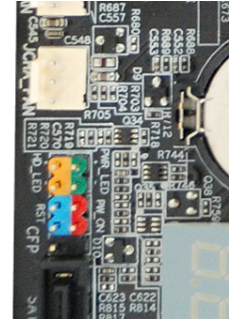
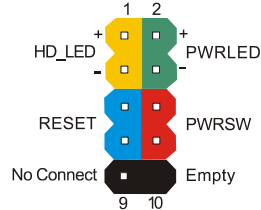

Note: Some system cases do not have all four cables. Be sure to match the name on the connectors to the corresponding pins.

❑ **PWRSW**

Attach the power button cable from the case to these two pins. Pressing the power button on the front panel turns the system on and off rather than using the onboard button.

❑ **HD\_LED**

Attach the hard disk drive indicator LED cable to these two pins. The HDD indicator LED indicates the activity status of the hard disks.

❑ **RESET**

Attach the Reset switch cable from the front panel of the case to these two pins. The system restarts when the **RESET** switch is pressed.

Table 2. Front Panel Header Pins

	Pin	Signal
<b>HD_LED</b>	1	HD_PWR
	3	HD Active
<b>PWRLED</b>	2	PWR LED
	4	STBY LED
<b>RESET</b>	5	Ground
	7	RST BTN
<b>PWRSW</b>	6	PWR BTN
	8	Ground
<b>No Connect</b>	9	+5V
<b>Empty</b>	10	Empty

### IEEE1394a (Firewire)

The IEEE 1394a expansion cable bracket is provided in the box but if you do not require the additional external connections, you do not need to install it.

1. Secure the bracket to either the front or rear panel of the system case (not all system cases are equipped with the front panel option).

Connect the end of the cable(s) to the IEEE1394a headers on the motherboard.

Table 3. IEEE 1394a Connector Pins

Connector	Pin	Signal
IEEE 1394a Connector	1	TPA+
	2	TPA-
	3	GND
	4	GND
	5	TPB+
	6	TPB-
	7	+12V
	8	+12V
	9	Empty
	10	GND

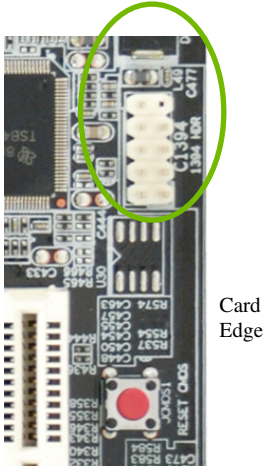

## USB Headers

This motherboard contains eight (8) USB 2.0 ports that are exposed on the rear panel of the chassis (Figure 2). The motherboard also contains two 10-pin internal header connectors onboard that can be used to connect an optional external bracket containing four (4) USB 2.0 ports.

1. Secure the bracket to either the front or rear panel of your chassis (not all chassis are equipped with the front panel option).
2. Connect the two ends of the cables to the USB 2.0 headers on the motherboard.

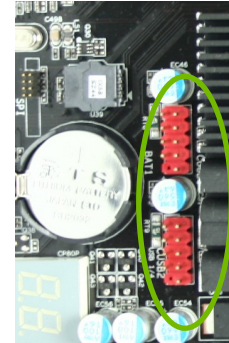
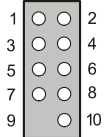

Table 4. USB 2.0 Header Pins

Connector	Pin	Signal	
USB 2.0 Header Connector  	1	5V_DUAL	
	3	D-	
	5	D+	
	7	GND	
	9	Empty	
	Pin	Signal	
	2	5V_DUAL	
	4	D-	
	6	D+	
	8	GND	
10	No Connect		

### Audio

The audio connector supports HD audio standard and provides two kinds of audio output choices: the Front Audio, the Rear Audio. The front Audio supports re-tasking function.

Table 5. Front Audio Connector

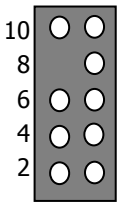
Connector	Pin	Signal
Front Audio Connector  	1	PORT1_L
	2	AUD_GND
	3	PORT1_R
	4	PRECENCE_J
	5	PORT2_R
	6	SENSE1_RETURN
	7	SENSE_SEND
	8	Empty
	9	PORT2_L
	10	SENSE2_RETURN

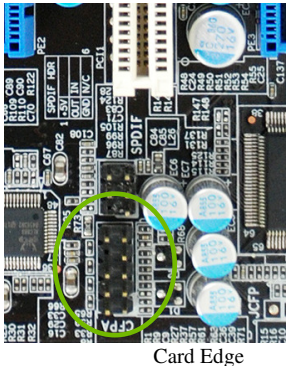

Card Edge

## Fan Connections

There are six fan connections on the motherboard. The fan speed can be detected and viewed in the **PC Health Status** section of the CMOS Setup. The fans are automatically turned off after the system enters S3, S4 and S5 mode.

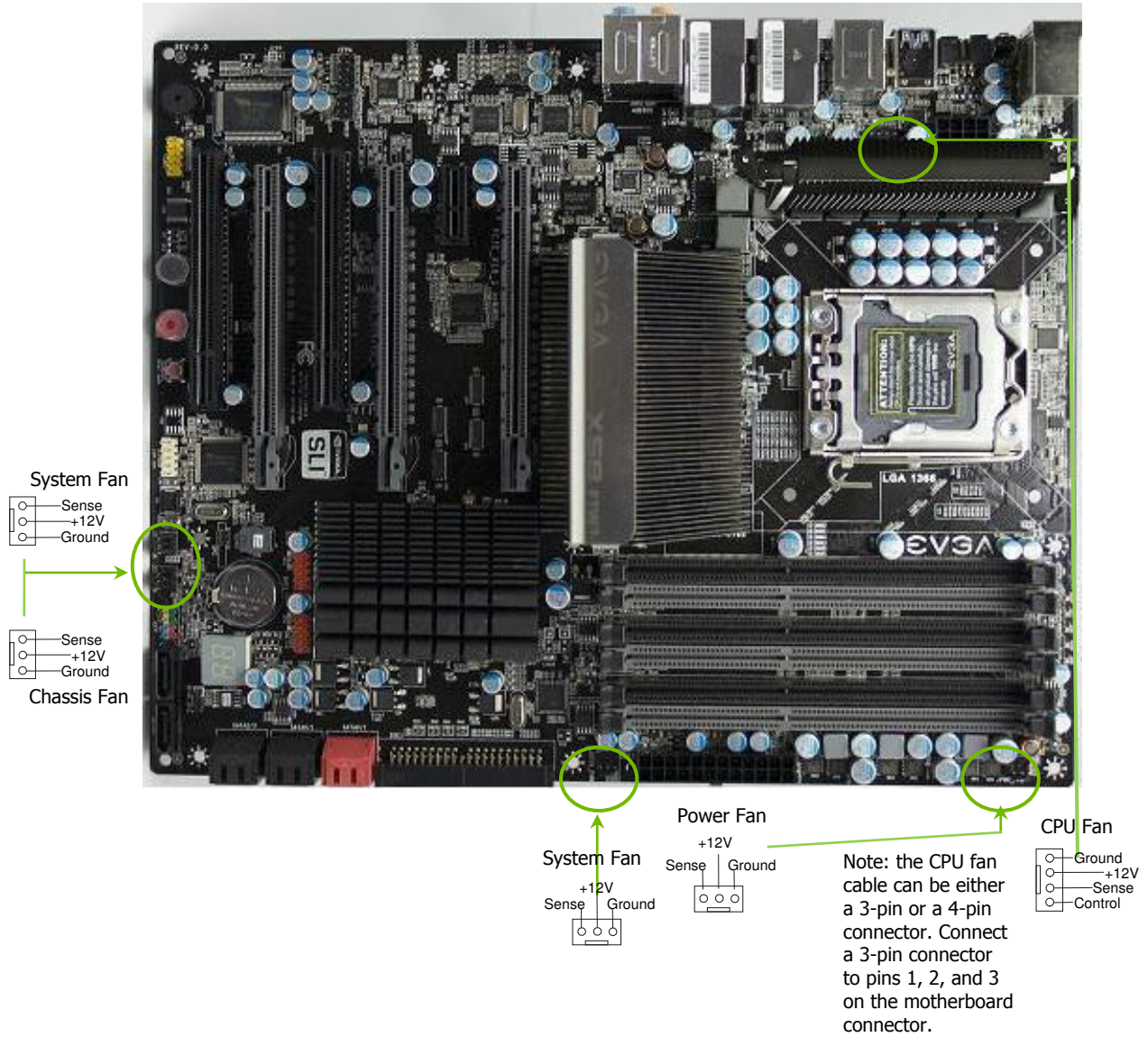

## COM1

The motherboard kit provides an additional serial COM header for the system. Connect one side of the cable to the headers on the motherboard then, attach the serial COM device to the other side of the cable.

## Expansion Slots

The EVGA X58 FTW3 Motherboard contains six (6) expansion slots, four (4) PCI-E slots and two (2) PCI slots. For a full list of PCI-E graphic cards supported by this motherboard, visit: [www.EVGA.com/Products](http://www.EVGA.com/Products)

6 5 4 3 2 1

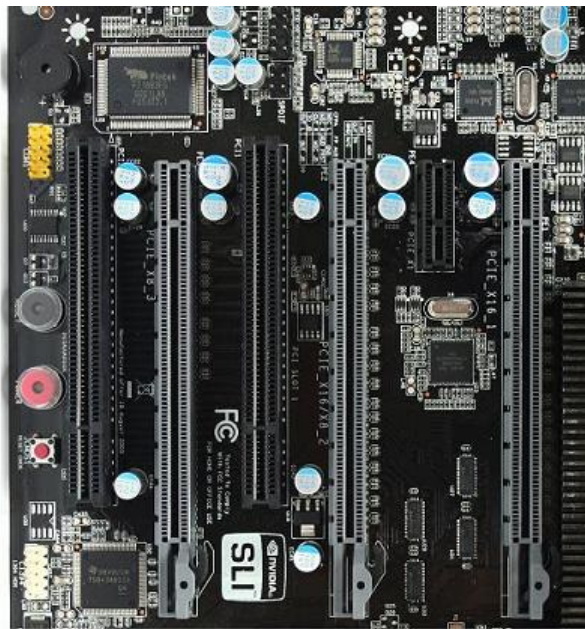

### Slot Listing

- 1 – PCI-E 2.0 x16 - Slot 1 (Primary)
- 2 – PCI-E x1 - Slot 1
- 3 – PCI-E 2.0 x8/x16 - Slot 2
- 4 – PCI - Slot 1
- 5 – PCI-E 2.0 x8 - Slot 3
- 6 – PCI - Slot 2

**Note:** When using 1 Graphic Card in PCI-E: Slot 1, a speed of x16 will be used. When using 2 Graphic Cards in PCI-E Slots: 1 and 3, a speed of x16/x16 will be used. When running 3 Graphic Cards in PCI-E Slots: 1, 3, and 5 a speed of x16/x8/x8 will be used.

## PCI Slots

The two PCI slots support many expansion cards such as a LAN card, USB card, SCSI card and other cards that comply with PCI specifications. When installing a card into the PCI slot, be sure that it is fully seated. Secure the card's metal bracket to the chassis back panel with the screw used to hold the blank cover.

## PCI-E x1 Slots

There is one PCI-E x1 slot that is designed to accommodate less bandwidth-intensive cards, such as a modem or LAN card. The x1 slots provide 250 MB/sec bandwidth.

## PCI-E x16/x8 Slots

These PCI-E slots are reserved for Graphic Cards and PCI-E x1 and x4 devices. The design of this motherboard supports multiple Graphic Card technology.

When installing a PCI-E Graphic Card, be sure the retention clip snaps and locks the card into place. If the card is not seated properly, it could cause a short across the pins. Secure the card's metal bracket to the chassis back panel with the screw used to hold the blank cover.



## Onboard Buttons

These onboard buttons include RESET, POWER and Clear CMOS. These functions allow you to easily reset the system, turn on/off the system, or clear the CMOS.

### Clear CMOS Button

The motherboard uses the CMOS RAM to store all the set parameters. The CMOS can be cleared by pressing the Clear CMOS button either onboard or on the external I/O Panel.



External Clear CMOS Button

### RESET and POWER Button

These onboard buttons allow you to easily turn on/off the system. These buttons allow for easy debugging and testing of the system during troubleshooting situations.

The POWER button with LED indicates the system's status. When the system is powered on, the LED remains a solid green.

The RESET button with an integrated LED indicates the activity status of the hard disk drives and will flicker accordingly.



RESET Button    POWER Button    Clear CMOS Button

---

## Post Port Debug LED and LED Status Indicators

### Post Port Debug LED

Provides two-digit POST codes to show why the system may be failing to boot. It is useful during troubleshooting situations. This Debug LED will also display current CPU temperatures after the system has fully booted into the Operating System.

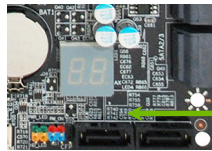

Debug LED with CPU Temperature Monitor

### LED Status Indicators

These LEDs indicate the system's status.

- ❑ POWER LED (Green):  
When the System is powered on: This LED is on.
- ❑ DIMM LED (Yellow):  
When the Memory slot is functional: This LED is on.
- ❑ STANDBY LED (Blue):  
When the System is in Standby Mode: This LED is on. This LED will remain on as long as the motherboard is receiving constant power.

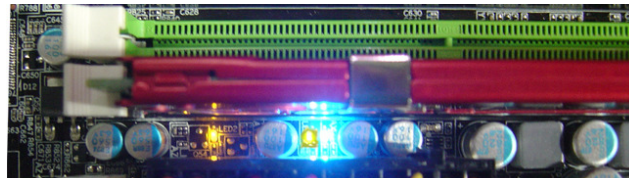

DIMM LED (YELLOW)

Power LED (GREEN)

STANDBY LED (BLUE)

# Configuring the BIOS

This section discusses how to change the system settings through the BIOS Setup menus. Descriptions of the BIOS parameters are also provided.

This section includes the following information:

- ❑ Enter BIOS Setup
- ❑ Main Menu
- ❑ Standard CMOS Features
- ❑ Advanced BIOS Features
- ❑ Integrated Peripherals
- ❑ Power Management Setup
- ❑ PnP/PCI Configurations
- ❑ PC Health Status
- ❑ Frequency/Voltage Control

---

## Enter BIOS Setup

The BIOS is the communication bridge between hardware and software. Correctly setting the BIOS parameters is critical to maintain optimal system performance.

Use the following procedure to verify/change BIOS settings.

3. Power on the computer.
4. Press the **Del** key when the following message briefly displays at the bottom of the screen during the Power On Self Test (POST).

**Press F1 to continue, DEL to enter Setup.**

Pressing **Del** takes you to the Phoenix-Award BIOS CMOS Setup Utility.

---

**Note:** It is *strongly* recommended that you do not change the default BIOS settings. Changing some settings could damage your computer.

---

---

## Main Menu

The main menu allows you to select from the list of setup functions and two exit choices. Use the **Page Up** and **Page Down** keys to scroll through the options or press **Enter** to display the associated submenu. Use the **↑↓** arrow keys to position the selector in the option you choose. To go back to the previous menu, press **Esc**.

---

**Note:** that on the BIOS screens all data in **white** is for information only, data in **yellow** is changeable, data in **blue** is non-changeable, and data in a **red box** is highlighted for selection.

---

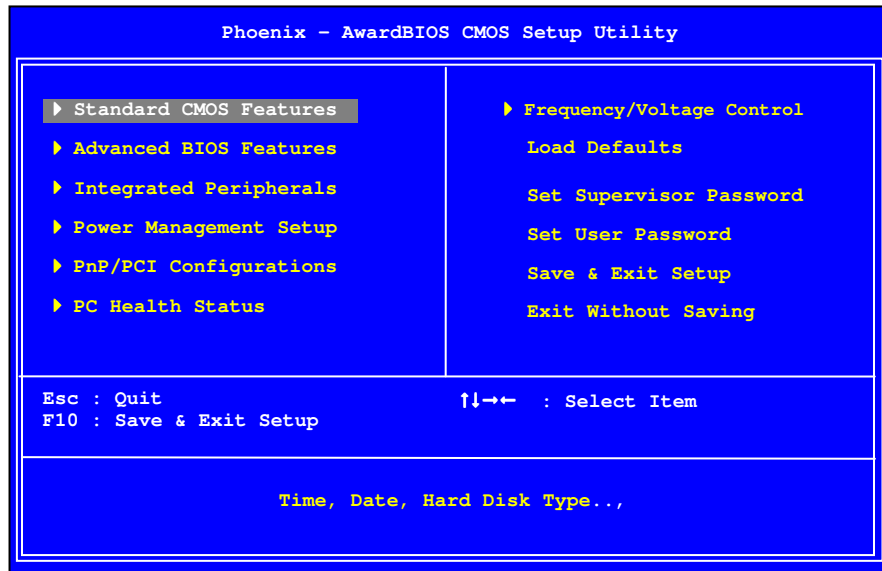

Figure 4. BIOS CMOS Setup Utility Main Menu

- ❑ **Standard CMOS Features**  
Use this menu to set up the basic system configuration.
- ❑ **Advanced BIOS Features**  
Use this menu to set up the advanced system features and boot sequence.
- ❑ **Integrated Peripherals**  
Use this menu to set up onboard peripherals such as IDE, RAID, USB, LAN, and MAC control.
- ❑ **Power Management Setup**  
Use this menu to configure power management, power on, and sleep features.
- ❑ **PnP/PCI Configurations**  
Use this menu to modify the system's Plug-and-Play and PCI configurations.
- ❑ **PC Health Status**  
Use this menu to monitor the real-time system status of your PC, including temperature, voltages, and fan speed.

❑ **Frequency/Voltage Control**

Use this menu to optimize system performance and configure clocks, voltages, memory timings, and more.

The following items on the CMOS Setup Utility main menu are commands rather than submenus:

❑ **Load Defaults**

Load defaults system settings.

❑ **Set Supervisor Password/Set User Password**

Use this command to set, change, and disable the password used to access the BIOS menu.

❑ **Save & Exit Setup**

Use this command to save settings to CMOS and exit setup.

❑ **Exit Without Saving**

Use this command to abandon all setting changes and exit setup.

## Standard CMOS Features Menu

The Standard CMOS Features menu is used to configure the standard CMOS information, such as the date, time, HDD model, and so on. Use the **Page Up** and **Page Down** keys to scroll through the options or press **Enter** to display the sub-menu. Use the **↑↓** arrow keys to position the selector in the option you choose. To go back to the previous menu, press **Esc**.

The information shown in **Item Help** corresponds to the option highlighted.

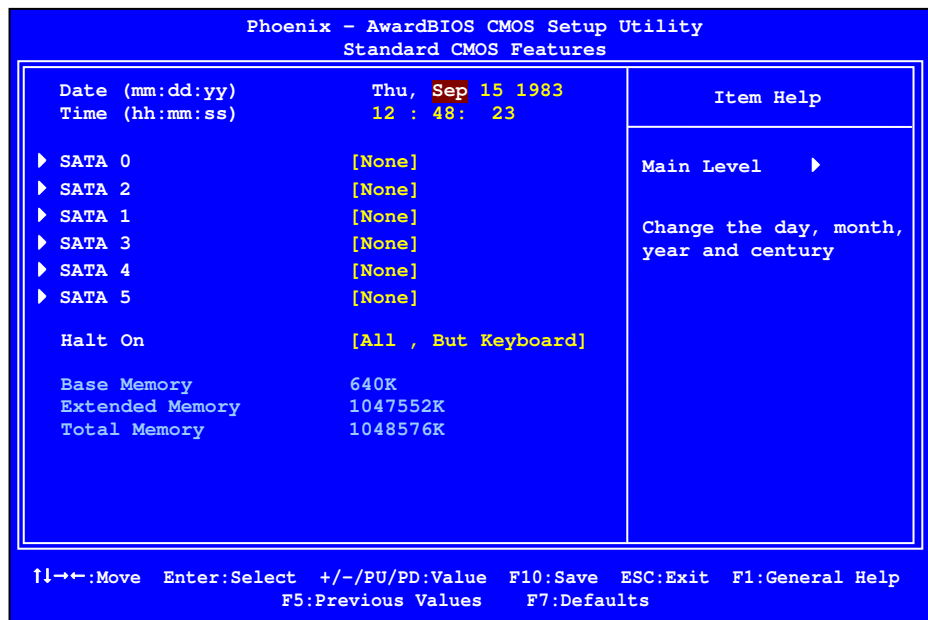

Figure 5. Standard CMOS Features Menu

Note that all data in **white** is for information only, data in **yellow** is changeable, data in **blue** is non-changeable, and data in a **red box** is highlighted for selection.

## Date and Time

Using the arrow keys, position the cursor over the month, day, and year. Use the **Page Up** and **Page Down** keys to scroll through dates and times. Note that the weekday (Sun through Sat) cannot be changed. This field changes to correspond to the date you enter. Note that the hour value is shown in a 24-hour clock format. Time is represented as `hour : minute : second`.

```
Date (mm:dd:yy)      Sat, Jul 01 2006
Time (hh:mm:ss)     14 : 48 : 43
```

## SATA Channel

Use these functions to detect and configure the SATA channels. Select a channel and press **Enter** to display the SATA sub-menu.

```
▶ SATA 0      [None]
▶ SATA 2      [None]
▶ SATA 1      [None]
▶ SATA 3      [None]
▶ SATA 4      [None]
▶ SATA 5      [None]
```

Press ENTER to display  
SATA Channel sub-menu

```
IDE Auto-Detect      [Press Enter]

SATA 0               [None]
Access Mode          Auto

Capacity              0 MB

Cylinder              0
Head                  0
Precomp               0
Landing Zone         0
Sector                0
```



Press **Enter** to auto-detect IDE and SATA channels in the system. Once the channel is detected, the values for Capacity, Cylinder, Heads, Precomp, Landing Zone, and Sector are automatically filled in.

❑ **None**

There is no HDD installed or set.

❑ **Auto**

The system can auto-detect the hard disk when booting up.

❑ **Manual**

When you set the channel to **[Manual]** and change **Access Mode** to **[CHS]**, you can then enter the number of cylinders, heads, Precomp, landing zone, and sector. You can manually enter the values or you can press **Enter** to display a window that tells you the min and max values.

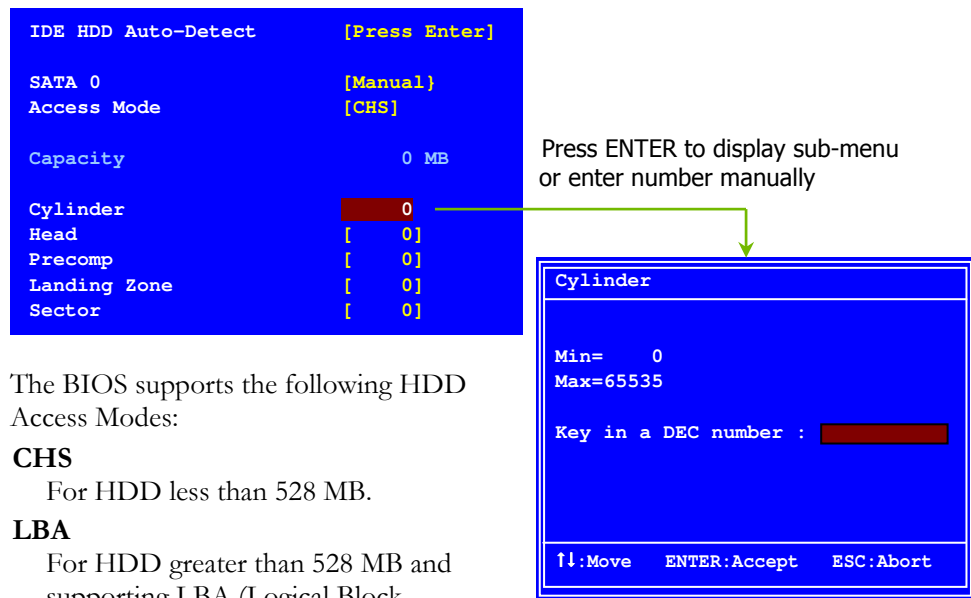

The BIOS supports the following HDD Access Modes:

**CHS**

For HDD less than 528 MB.

**LBA**

For HDD greater than 528 MB and supporting LBA (Logical Block Addressing).

**Large**

For HDD greater than 528 MB but not supporting LBA.

**Auto**

Recommended mode.

## Halt On

**Halt On** determines whether or not the computer stops if an error is detected during power on. Use the **Page Up** and **Page Down** keys to scroll through the options or press **Enter** to display the **Halt On** sub-menu. Use the **↑↓** arrow keys to position the selector in the option you choose. Press **Enter** to accept the changes and return to the Standard CMOS Features menu.

Halt On                      [All , But Keyboard]	Press ENTER to display sub-menu
---	---------------------------------

- **All Errors**  
 Whenever the BIOS detects a nonfatal error, the system stops and prompts you.
- **No Errors**  
 System boot does not stop for any detected errors.
- **All, But Keyboard**  
 System boot does not stop for keyboard errors, but does stop for all other errors.

Halt On		
All Errors	.....	[ ]
No Errors	.....	[ ]
All , But Keyboard	.....	[■]
↑↓:Move    ENTER:Accept    ESC:Abort		

## Memory

These settings are *display-only values* that are determined by the BIOS POST (Power-On Self Test).

- **Base Memory**  
 BIOS POST determines the amount of base (or conventional) memory installed in the system.
- **Extended Memory**  
 BIOS determines how much extended memory is present during the POST.
- **Total Memory**  
 This value represents the total memory of the system.

Base Memory	640K
Extended Memory	1047552K
Total Memory	1048576K

## Advanced BIOS Features

Access the Advanced BIOS Features menu from the CMOS Utility Setup screen. Use the **Page Up** and **Page Down** keys to scroll through the options or press **Enter** to display the sub-menu. Use the **↑↓** arrow keys to position the selector in the option you choose. To go back to the previous menu, press **Esc**.

The options that have associated sub-menus are designated by a **▶**, which precedes the option. Press **Enter** to display the sub-menus.

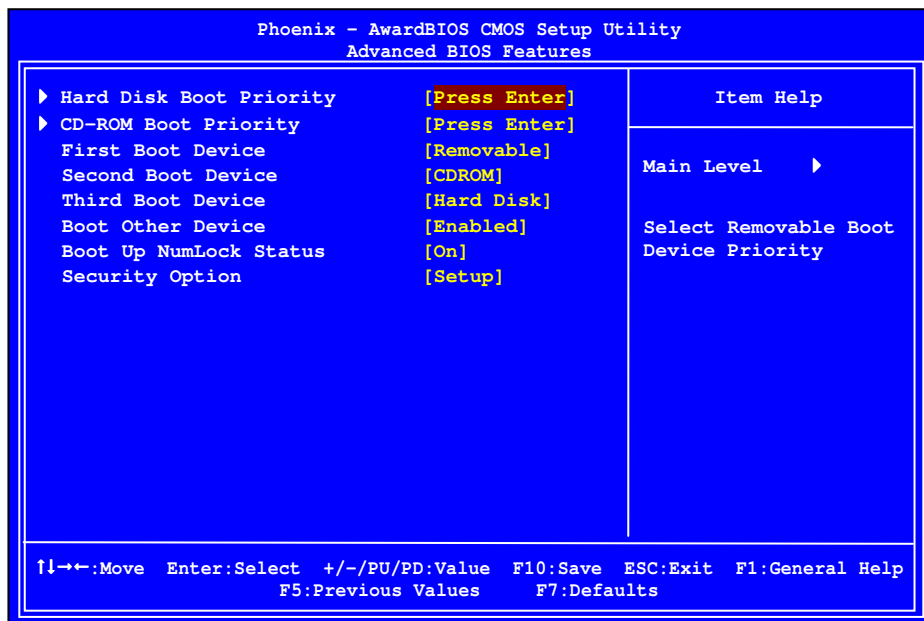

Figure 6. Advanced BIOS Features Menu

Note: That all data in **white** is for information only, data in **yellow** is changeable, data in **blue** is non-changeable, and data in a **red box** is highlighted for selection.

## Hard Disk Boot Priority

Use this option to select the priority for HDD startup. Press **Enter** to see the list of bootable devices in your system. Use the **↑↓** arrow keys to go to the various devices. Then use the **+** or **-** keys to move the device priority up or down in the list. To go back to the previous menu, press **Esc**.

```
1. SATA 0 : ST3802110A
2. Bootable Add-in Cards
```

Use the **+** and **-** keys to move the priority of the device within the list

## CD-ROM Device Priority

Use this option to select the priority for CD-ROM startup. Press **Enter** to see the list of removable devices in your system. Use the **↑↓** arrow keys to go to the various devices. Then use the **+** or **-** keys to move the device priority up or down in the list. To go back to the previous menu, press **Esc**.

```
1. SATA 1 : BENQ DVD DC DW1810
```

## First/Second/Third Boot Device

Use this option to set the priority sequence of the devices booted at power on. Use the **Page Up** and **Page Down** keys to scroll through the options or press **Enter** to display the sub-menu. Use the **↑↓** arrow keys to position the selector in the option you choose.

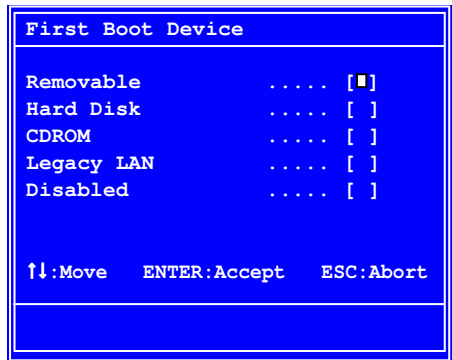

## Boot Other Device

With the option set to **Enable**, the system boots from some other device if the first/second/third boot devices fail.

## Boot Up NumLock Status

This option allows you to select the power-on state of **NumLock**. Select **On** to activate the keyboard **NumLock** when the system is started. Select **Off** to disable the **NumLock** key.

## Security Option

The Security Options allows you to require a password every time the system boots or only when you enter setup. Select **Setup** to require a password to gain access to the CMOS Setup screen. Select **System** to require a password to access the CMOS Setup screen and when the system boots.

---

## Integrated Peripherals Menu

Select **Integrated Peripherals** from the CMOS Setup Utility menu and press **Enter** to display the Integrated Peripherals menu.

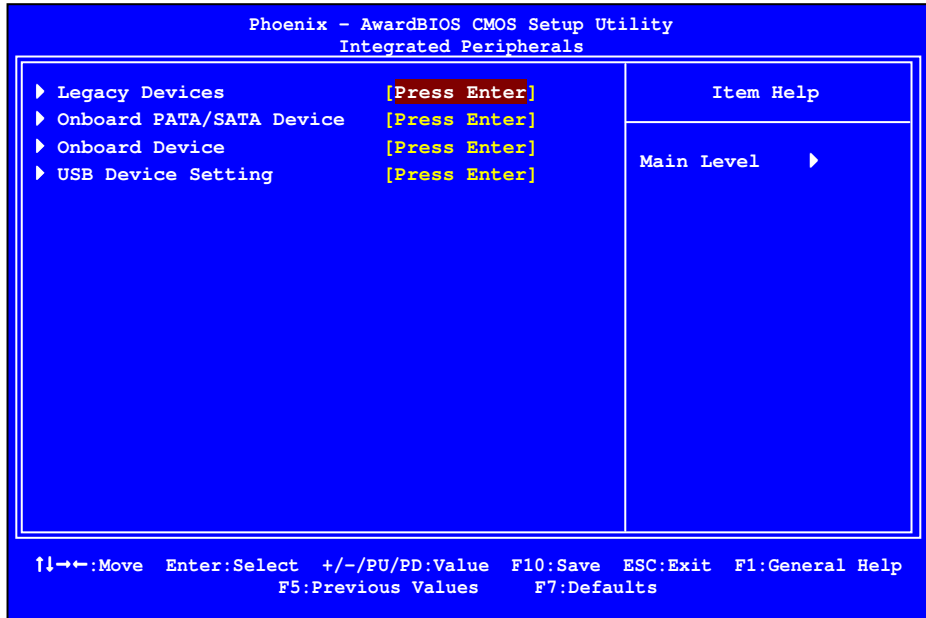
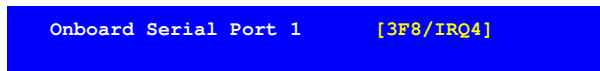

Figure 7. Integrated Peripherals Menu

## Legacy Devices

Press **Enter** to display the Legacy Devices menu.



### ■ Onboard Serial Port 1

This function on the Integrated Peripherals menu allows you to select the

onboard serial port 1 function. Options are [3F8/IRQ4], [2F8/IRQ3], [3E8/IRQ4], [2E8/IRQ3], [Auto], and [Disabled]

## OnChip PATA/SATA Device

Press **Enter** to display the OnChip PATA/SATA Device menu.

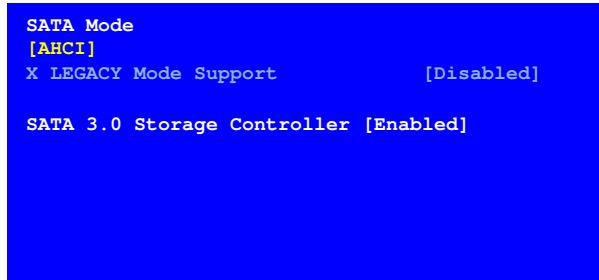

```
SATA Mode
[AHCI]
X LEGACY Mode Support      [Disabled]

SATA 3.0 Storage Controller [Enabled]
```

### ❑ **SATA Mode**

This allows you to set the onboard Serial SATA mode.

**IDE:** Use the SATA hard disk drivers as Parallel ATA storage devices.

**RAID:** Create a RAID 0, 1, 0+1, and 5 configuration

**AHCI:** Use the AHCI (Advanced Host Controller Interface) to enable advanced SATA features for improved performance with NCQ and Hot-plug features

### ❑ **LEGACY Mode Support**

This function allows the SATA controller to operate in LEGACY mode. Selected Disabled if you install an operating system that supports Native mode.

## Onboard Device

Press **Enter** to display the Onboard Device menu.

Realtek GigaLan (LAN1)	[Auto]
Realtek GigaLan (LAN2)	[Auto]
PE4 Slot (PCIE x1)	[Auto]
Realtek Lan PXE Boot ROM	[Disabled]
TI 1394 Setting	[Enabled]
High Definition Audio	[Enabled]
P80 Show CPU Temp.	[Enabled]

- Realtek GigaLan (LAN1)**  
Use this function to set the onboard Realtek GigaLan function for LAN1. The options are Auto, Enabled and Disabled.
- Realtek GigaLan (LAN2)**  
Use this function to set the onboard Realtek GigaLan function for LAN2. The options are Auto, Enabled and Disabled.
- PE4 Slot (PCIE x1)**  
Use this function to set the PCI-e x1 Slot function. The options are Auto, Enabled and Disabled.
- Realtek Lan PXE Boot ROM**  
This function allows you to enable or disable the onboard Realtek Lan PXE Boot ROM for booting from LAN.
- High Definition Audio**  
This function allows you to enable or disable the onboard Realtek High Definition Audio.
- TI 1394 Setting**  
This function allows you to enable or disable the IEEE1394 (Firewire) interface.
- P80 Show CPU Temp.**  
When this function is enabled the onboard Post Port LED will display the CPU temperature.



## USB Device Settings

Press **Enter** to display the USB Device Settings menu.

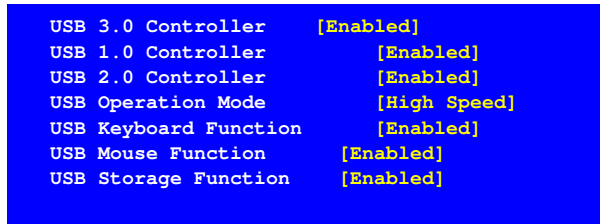

USB 3.0 Controller	[Enabled]
USB 1.0 Controller	[Enabled]
USB 2.0 Controller	[Enabled]
USB Operation Mode	[High Speed]
USB Keyboard Function	[Enabled]
USB Mouse Function	[Enabled]
USB Storage Function	[Enabled]

- ❑ **USB 1.0 Controller**  
Use this function to enable the USB 1.0 controller.
- ❑ **USB 2.0 Controller**  
Use this function to enable the USB 2.0 (EHCI) controller.
- ❑ **USB Operation Mode**  
Select the USB Operation Mode for USB device. Options are Full/Low Speed and High Speed.
- ❑ **USB Keyboard Function**  
Use this function to enable or disable support for USB keyboard under DOS.
- ❑ **USB Mouse Function**  
Use this function to enable or disable support for USB mouse under DOS
- ❑ **USB Storage Function**  
Use this function to enable or disable legacy support of USB Mass Storage

## Power Management Setup Menu

Select **Power Management Setup** from the CMOS Setup Utility menu and press **Enter** to display the Power Management Setup menu.

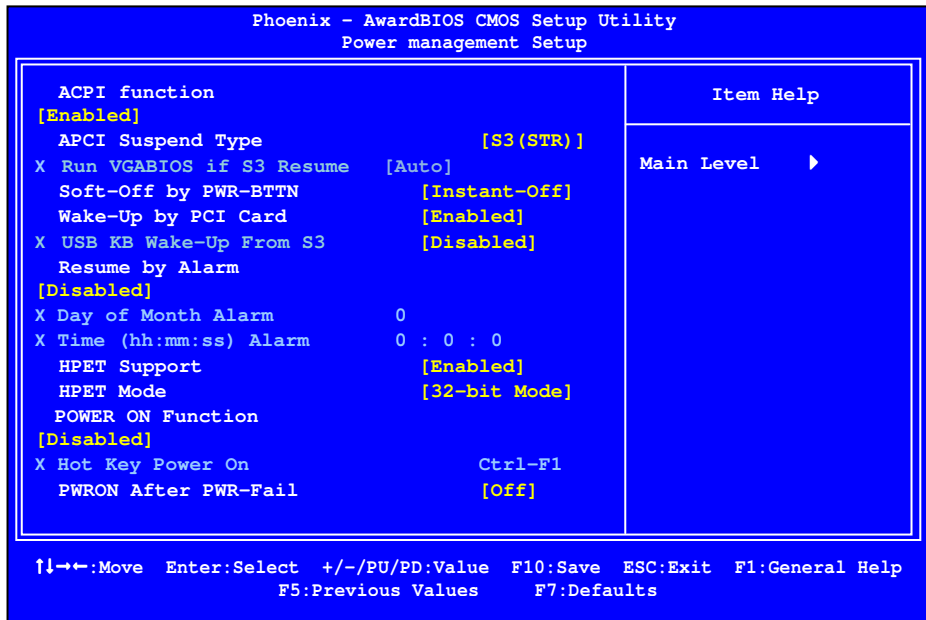

Figure 8. Power Management Setup Menu

## ACPI Function

This function on the Power Management Setup menu allows you to enable or disable the ACPI function.

## ACPI Suspend Type

This function on the Power Management Setup menu allows you to select an ACPI Suspend Type. Types to select from are **[S1&S3]**, **[S1 (POS) ]**, and **[S3 (STR) ]**.

## Run VGABIOS if S3 Resume

This function on the Power Management Setup menu allows you determines whether or not to enable the system to run the VGA BIOS when resuming from S3(STR) or S1&S3. The Options are Auto, Yes and No.

## Soft-Off by PWR-BTTN

This function on the Power Management Setup menu allows you to set Soft-Off by PBNT to **[Instant-Off]** or **[Delay 4 Sec]**.

## Wake-Up by PCI Card

This function on the Power Management Setup menu allows PCI Card to wake-up the system from Soft-off state.

## USB KB Wake-Up From S3

This function on the Power Management Setup menu allows a USB keyboard device to wake-up the system from S3 state.

## Resume by Alarm

This function on the Power Management Setup menu allows you to enable or disable the Power-on by alarm function. Set to **[Disable]** to prevent power-on by alarm. When set to **[Enable]**, you can manually put in the day of the month and the time of the alarm.

```
Day of Month Alarm      [ 0 ]
Time (hh:mm:ss) Alarm  [0 : 0 : 0]
```

To enter a day or time, use the **Page Up** and **Page Down** keys to scroll through numbers or enter the number using the keyboard number or the **+** and **-** keys.

## POWER ON Function

This function on the Power Management Setup menu allows you to define the power-on function. Options for this function are:

- Disabled
- Keyboard

## Hot Key Power On

Use this function with the above “POWER ON Function” to set a combination of keys that can be used to power on the system. Options for this function are:

- Ctrl-Esc
- Ctrl-F1
- Ctrl-Space
- Anykey

## PWRON after PWR-Fail

- This function enables your computer to automatically restart or return to its last operating status after power returns from a power failure.
- Off: The system stays off after a power failure.
- On: The system stays on after a power failure

## PnP/PCI Configuration Menu

Select **PnP/PCI Configuration** from the CMOS Setup Utility menu and press **Enter** to display the PnP/PCI Configuration menu.

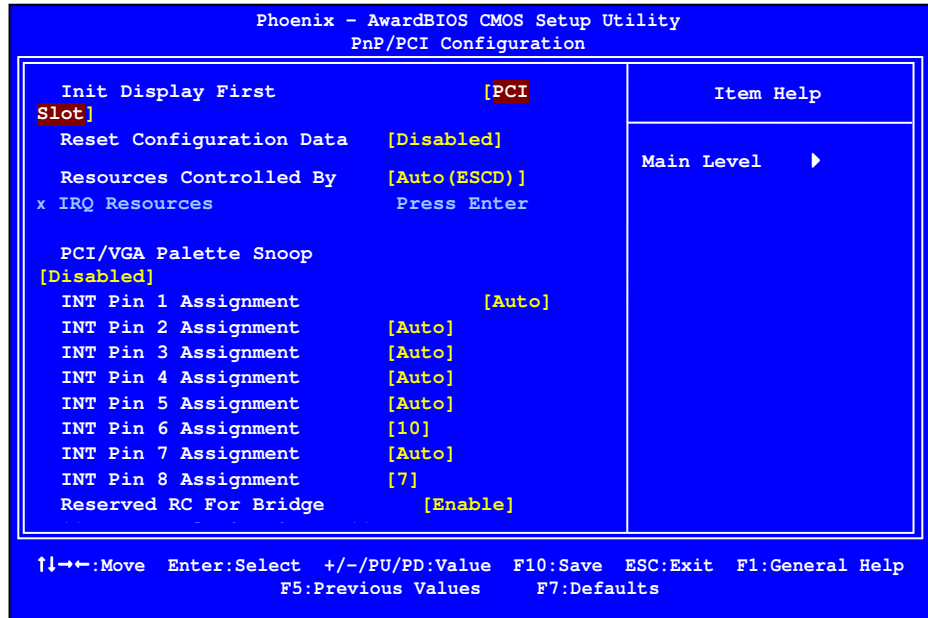

Figure 9. PnP/PCI Configuration Menu

### Init Display First

This function on the PnP/PCI Configuration menu allows you to define if the initial display is in the PCI slot or in the PCI-E slot. Options are **[PCI Slot]** and **[PCIEx]**.

## Reset Configuration Data

This function on the PnP/PCI Configuration menu allows you to enable or disable the resetting of Extended System Configuration Data (ESCD) when you exit Setup. Set this to [Enabled] if you have installed a new add-on and the system reconfiguration has caused a serious conflict that prevents the OS from booting. The default setting is [Disabled].

## Resources Controlled By

This function on the PnP/PCI Configuration menu allows you to define if the BIOS can automatically configure all the boot and plug-and-play compatible devices or if you can manually select IRQ, DMA, and memory base address fields. Select **[Auto (ESCD)]** if you want the BIOS to automatically populate these fields. If you select **[Manual]** so you can assign the resources, **IRQ Resources** is enabled for input.

```
Resources Controlled By [Auto (ESCD)]
x IRQ Resources          Press Enter
```

```
Resources Controlled By [Manual]
IRO Resources           [Press Enter]
```

## IRQ Resources

To enable this field for input, set **Resources Controlled By** to **[Manual]**. With this field enabled, press **Enter** to see options.

```
IRQ-5 assigned to [PCI Device]
IRQ-9 assigned to [Reserved]
IRQ-10 assigned to [PCI Device]
IRQ-11 assigned to [PCI Device]
IRQ-12 assigned to [PCI Device]
IRQ-14 assigned to [PCI Device]
IRQ-15 assigned to [PCI Device]
```

Use Legacy ISA for devices compliant with the original PC AT Bus specification. Use PCI/ISA PnP for devices compliant with the plug-and-play standard, whether designed for PCI or ISA Bus architecture.

## PCI/VGA Palette Snoop

This item is designed to overcome problems that may be caused by some nonstandard VGA cards..

## INT Pin 1/2/3/4/5/6/7/8 Assignment

This function on the PnP/PCI Configuration menu allows you to set the INT Pin 1/2/3/4/5/6/7/8 Assignment.

## Maximum Payload Size

This function on the PnP/PCI Configuration menu allows you to set the maximum TLP payload size (in bytes) for the PCI-E devices. Use the **Page Up** and **Page Down** keys to scroll through sizes or enter the number using the keyboard numbers or use the **+** and **-** keys to go up and down the list of sizes.

## PC Health Status Menu

Select **PC Health Status** from the CMOS Setup Utility menu and press **Enter** to display the PC Health Status menu.

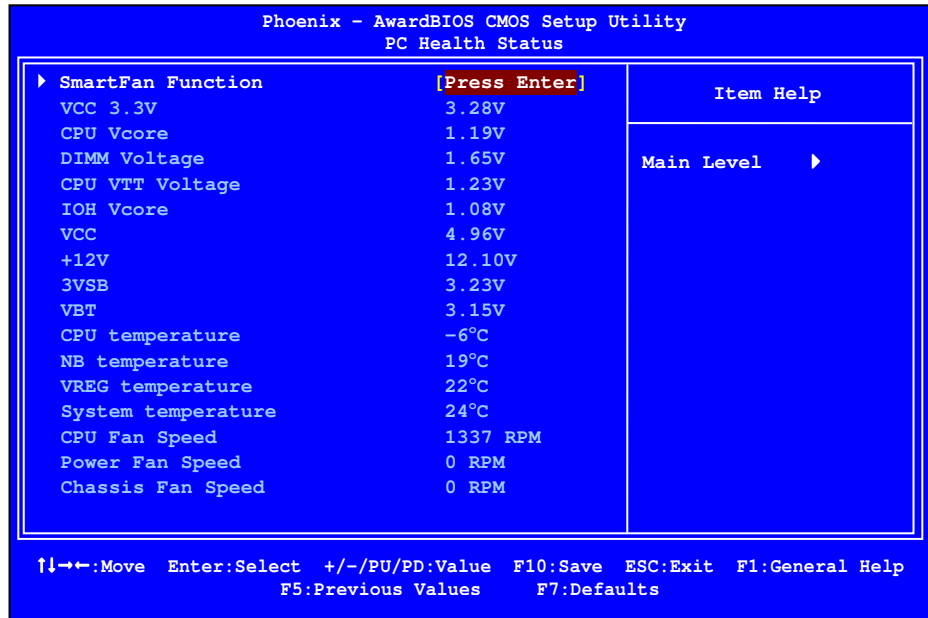

Figure 10. PC Health Status Menu

All of the values shown in **Blue** are dynamic and change as the speed and voltages of the various components change with system usage.



## SmartFan Function

Press **Enter** to display the SmartFan Function menu.

```
CPU Fan Type           [PWM Fan (4pin)]
CPU Speed Control      [SmartFan]
x Manual Fan Speed, %   100
  If temp > 100°C, Set Fan Speed 100%
  If temp < 30°C, Set Fan Speed  50%

Power Speed Control    [SmartFan]
x Manual Fan Speed, %   100
  If temp > 100°C, Set Fan Speed 100%
  If temp < 30°C, Set Fan Speed  50%

Chassis Speed Control  [SmartFan]
x Manual Fan Speed, %   100
  If temp > 100°C, Set Fan Speed 100%
  If temp < 30°C, Set Fan Speed  50%
```

Use this menu to control the speed of the various fans on the motherboard. Set CPU fan speed to **[SmartFan]** when you want the speed of the fans automatically controlled based on temperature. To set the fan speed to a constant rate, select **[Manual]** and then enter the speed from 0% to 100%.

Set the desired speed for the Power and Chassis fans from 0% to 100%. The system defaults to 100%.

## Frequency/Voltage Control Menu

Select **Frequency/Voltage Control** from the CMOS Setup Utility menu and press **Enter** to display the Frequency/Voltage Control menu.

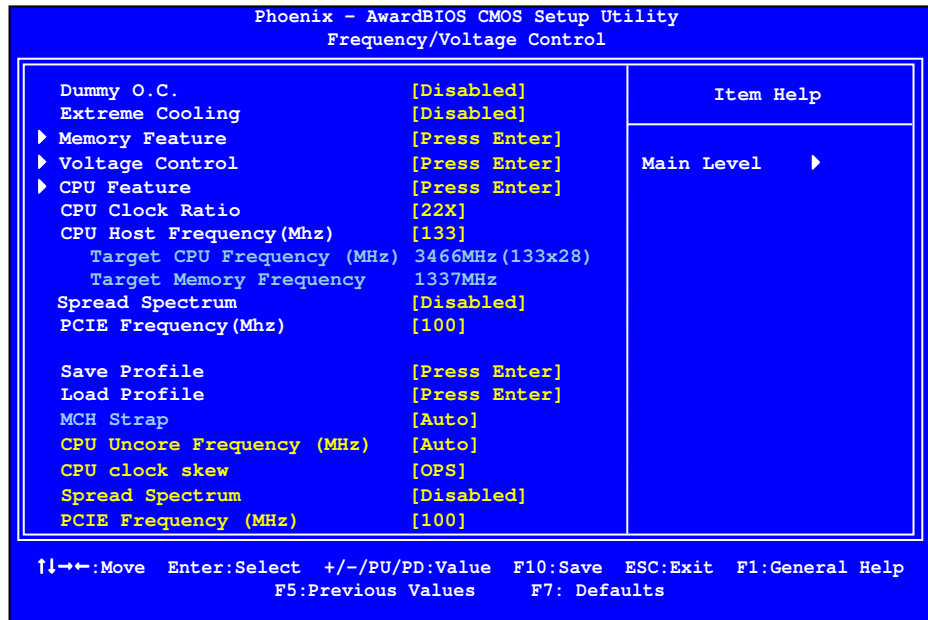

Figure 11. Frequency/Voltage Control Menu

## Memory Feature

Select **Memory Feature** from the Frequency/Voltage Control menu and press **Enter** to display the Memory Feature menu.

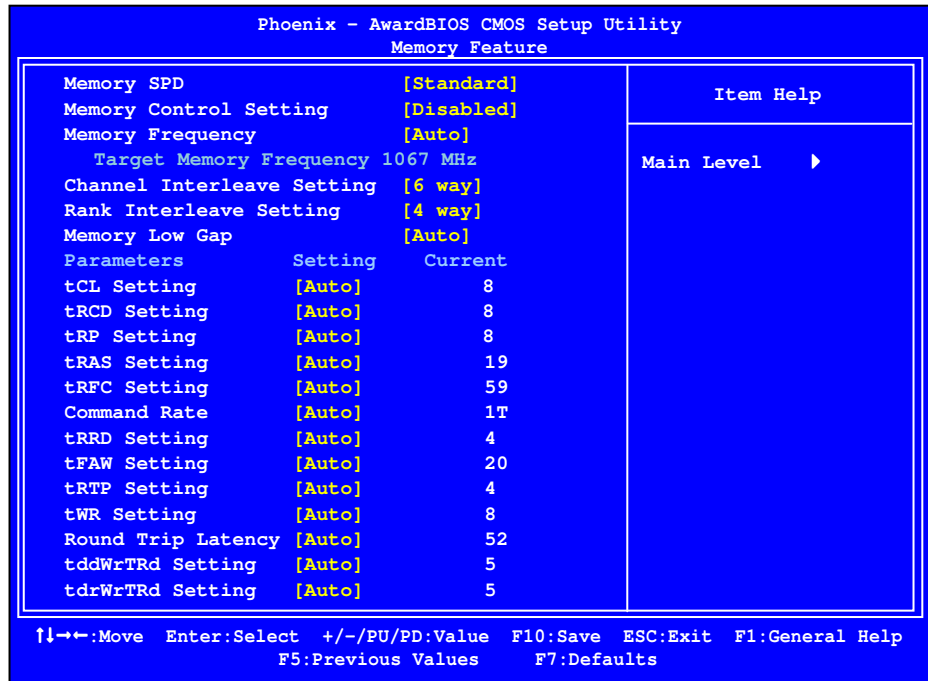

Figure 12. Memory Feature Menu

### ❑ Memory Control Setting

This function is allows you to select the Memory Control Setting.

### ❑ Memory Frequency

This function is allows you to select the Memory Frequency. The options are Auto, 800Mhz, 1067Mhz, 1333Mhz, and 1600Mhz.

### ❑ Channel Interleave Setting

This function is allows you to select the Channel Interleave Setting. The options are 1 way, 2 way, 3 way, 4 way, 5 way and 6 way.

❑ **Rank Interleave Setting**

This function allows you to select the Rank Interleave Setting. The options are 1 way, 2 way and 4 way.

❑ **tCL Setting**

This function sets the CAS latency. The options are 0 through 18.

❑ **tRCD Setting**

This function sets the RAS to CAS Delay for Read/Write commands to the same bank. The options are 0 through 15.

❑ **tRP Setting**

This function sets the Row Precharge time. This is the Precharge-to-Active or Auto-to-Refresh of the same bank. The options are 0 through 15.

❑ **tRAS Setting**

This function sets the minimum RAS# active time. The options are 0 through 31.

❑ **Command Rate**

This function sets the command timing setting on a per clock unit basis. The options are Auto, 1T and 2T.

## Voltage Control

Select **Voltage Control** from the Frequency/Voltage Control menu and press **Enter** to display the Voltage Control menu.

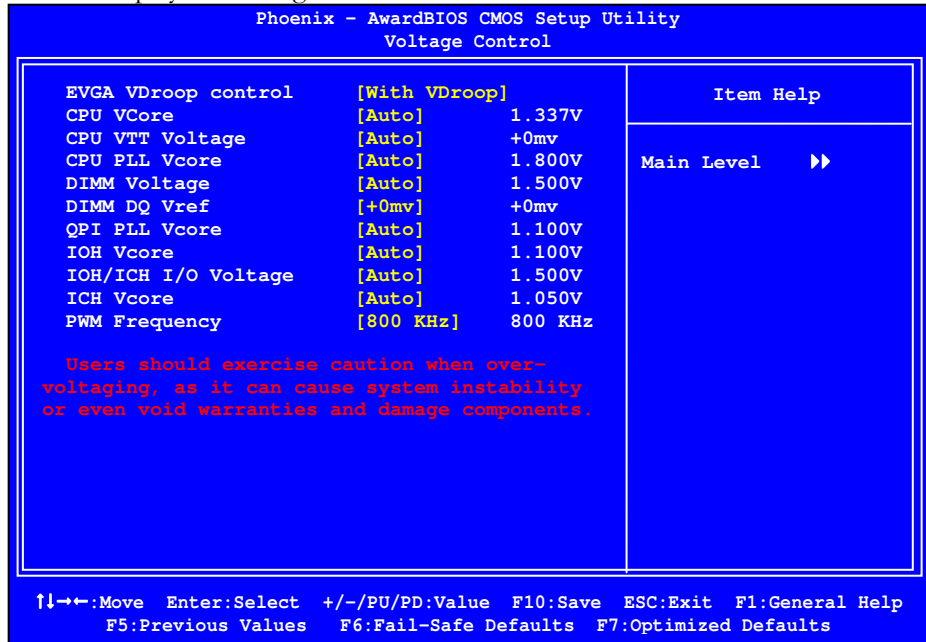

Figure 13. Voltage Control

- ❑ **EVGA VDroop Control**

EVGA VDroop control is a safety measure by motherboards to protect the CPU. Select [With VDroop] to calibrate CPU VDroop or select [Without VDroop] to disable this function
- ❑ **CPU VCore**

Use the **Page Up** and **Page Down** keys to scroll through the voltages or select [Auto] to automatically set the voltage level for the CPU Core.
- ❑ **CPU VTT Voltage**

Use the **Page Up** and **Page Down** keys to scroll through the voltages or select [Auto] to automatically set the voltage level for the CPU VTT Voltage.

- ❑ **CPU PLL VCore**  
Use the **Page Up** and **Page Down** to scroll through the voltages or select [Auto] to automatically set the voltage level for the CPU PLL Voltage.
- ❑ **DIMM Voltage**  
This function defines the voltage level for the DRAM. Use the **Page Up** and **Page Down** keys to select a voltage or select [Auto] to automatically set the voltage.
- ❑ **DIMM DQ Vref**  
This function defines the voltage level for the DRAM DQ Vref. Use the **Page Up** and **Page Down** keys to select and set the voltage.
- ❑ **QPI PLL VCore**  
Use the **Page Up** and **Page Down** keys to scroll through the voltages or select [Auto] to automatically set the voltage level for the QPI PLL voltage.
- ❑ **IOH VCore**  
This function defines the core voltage level for the Intel IOH chip. Use the **Page Up** and **Page Down** keys to select a voltage or select [Auto] to automatically set the voltage.
- ❑ **IOH/ICH I/O Voltage**  
This function defines the core voltage level for the Intel IOH/ICH I/O voltage. Use the **Page Up** and **Page Down** keys to select a voltage or select [Auto] to automatically set the voltage.
- ❑ **ICH VCore**  
This function defines the core voltage level for the Intel ICH chip. Use the **Page Up** and **Page Down** keys to select a voltage or select [Auto] to automatically set the voltage.
- ❑ **PWM Frequency**  
This function allows you to select the PWM frequency. For the following options, higher is cleaner, lower is more energy efficient: 800 KHz, 933 KHz, and 1066 KHz.

## CPU Feature

Select **CPU Feature** from the Frequency/Voltage Control menu and press **Enter** to display the CPU Feature menu.

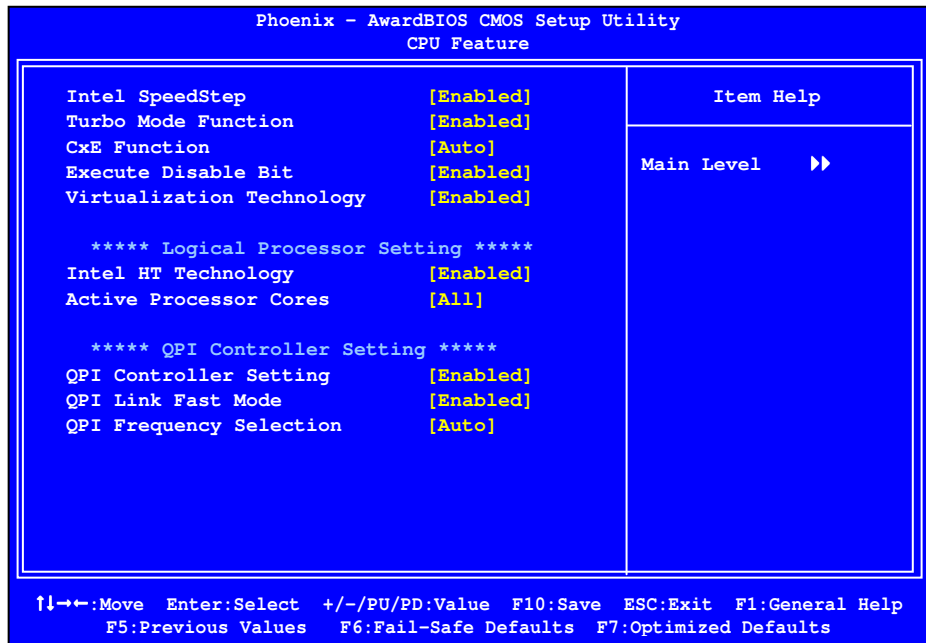

Figure 14. CPU Feature Menu

- ❑ **Intel SpeedStep**  
Use this function to enable the Intel SpeedStep technology (EIST). The options are Enabled and Disabled.
- ❑ **Turbo Mode Function**  
Use this function to enable the Intel Turbo Mode Function. The options are Enabled and Disabled.

- ❑ **CxE Function**  
This function allows you to select the lowest C state supported according as CPU and MB. The options are Auto, Disabled, C1, C1E, C3 and C6.
- ❑ **Execute Disable Bit**  
When this function is disabled, it forces the XD feature flag to always return to zero (0).
- ❑ **Virtualization Technology**  
When this function is enabled, it allows a VMM to utilize the additional hardware capabilities provided by Intel Virtualization Technology.

## Logical Processor Setting

- ❑ **Intel HT Technology**  
This function is allows you to enable the Intel HT Technology. The options are Enabled and Disabled.
- ❑ **Active Processor Cores**  
This function active number of cores to enable in each processor package. The options are All, 1 and 2.

## QPI Controller Setting

- ❑ **QPI Controller Setting**  
This function is allows you to enable the QPI (QuickPath Interconnect) Controller Setting. The options are Enabled and Disabled.
- ❑ **QPI Link Fast Mode**  
This function is allows you to enable the QPI Link Fast Mode. The options are Enabled and Disabled.
- ❑ **QPI Frequency Selection**  
This function is allows you to select the QPI Frequency. The options are Auto, 4.800 GT/s, 5.866 GT/s and 6.400 GT/s.



# Installing Drivers and Software

**Note:** It is important to remember that *before* installing the driver CD that is shipped in the kit, you need to load your operating system. The motherboard supports Windows XP 32bit and 64bit and is Vista-capable.

The kit comes with a CD that contains utilities, drivers, and additional software.

The CD that has been shipped with the EVGA X58 FTW3 Motherboard contains the following software and drivers:

- ❑ Chipset Drivers
- ❑ Audio Drivers
- ❑ RAID Drivers
- ❑ LAN Drivers
- ❑ Matrix Storage
- ❑ Marvell SATA 6 Drivers
- ❑ NEC USB 3.0 Drivers
- ❑ EVGA E-LEET
- ❑ User's Manual

---

## Windows XP/Vista/Win 7 Driver Installation

5. Insert the Intel X58 Express installation CD for the motherboard included in the kit.
6. The CD will autorun, install the drivers and utilities listed on the install screen.

## EVGA X58 FTW3 Motherboard

If the CD does not run, go to My Computer and click on the CD to open.

## Appendix A. POST Codes

This section provides the Award POST Codes (Table 6) for the EVGA X58 FTW3 Motherboard during system boot up.

The POST Codes are displayed on the Debug LED readout located directly onboard the motherboard.

This Debug LED will also display current CPU temperatures after the system has fully booted into the Operating System.

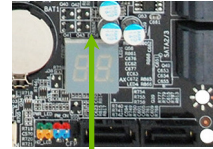

Debug LED with CPU Temperature Monitor

Table 6. Award POST Code

Award POST Codes		
Code	Name	Description
01	Reserved	
02	Jumps to E000 segment	Execution of POST routines in E000
03	Early SuperIO	Init Early Initialized the super IO
04	Reserved	
05	Blank video	Reset Video controller
06	Reserved	
07	Init KBC	Keyboard controller init
08	KB test	Test the Keyboard
09	Reserved	
0A	Mouse Init	Initialized the mouse
0B	Reserved	
0C	Reserved	
0D	Reserved	
0E	Checksum Check	Check the integrity of the ROM, BIOS and message

<b>Award POST Codes</b>		
<b>Code</b>	<b>Name</b>	<b>Description</b>
0F	Reserved	
10	Autodetect EEPROM	Check Flash type and copy flash write/erase routines
11	Reserved	
12	Test CMOS	Test and Reset CMOS
13	Reserved	
14	Load Chipset	Load Chipset Defaults
15	Reserved	
16	Init Clock	Initialize onboard clock generator
17	Reserved	
18	Init CPU	CPU ID and initialize L1/L2 cache
19	Reserved	
1A	Reserved	
1B	Setup Interrupt Vector Table	Initialize first 120 interrupt vectors with SPURIOUS_INT_HDLR and initialize INT 00h-1Fh according to INT_TBL
1C	CMOS Battery Check	Test CMOS and check Battery Fail
1D	Early PM	Early PM initialization
1E	Reserved	
1F	Re-initial KB	Load keyboard matrix
20	Reserved	
21	HPM init	Init Heuristic Power Management (HPM)
22	Reserved	
23	Program chipset	Early Programming of chipset registers
24	Init PNP	Init PNP
25	Shadow VBIOS	Shadow system/video BIOS
26	Clock Gen	Init onboard clock generator and sensor
27	Setup BDA	Setup BIOS DATA AREA (BDA)
28	Reserved	
29	CPU Speed	Chipset programming and CPU Speed detect

<b>Award POST Codes</b>		
<b>Code</b>	<b>Name</b>	<b>Description</b>
	detect	
2A	Reserved	
2B	Init video	Initialize Video
2C	Reserved	
2D	Video memory test	Test Video Memory and display Logos
2E	Reserved	
2F	Reserved	
30	Reserved	
31	Reserved	
32	Reserved	
33	Early keyboard reset	Early Keyboard Reset
34	Reserved	
35	Test DMA Controller 0	Test DMA channel 0
36	Reserved	
37	Test DMA Controller 1	Test DMA channel 1
38	Reserved	
39	Test DMA Page Registers	Test DMA Page Registers
3A	Reserved	
3B	Reserved	
3C	Test Timer	Test 8254 Timer 0 Counter 2.
3D	Reserved	
3E	Test 8259-1 Mask	Verify 8259 Channel 1 masked interrupts by alternately turning off and on the interrupt lines.
3F	Reserved	
40	Test 8259-2 Mask	Verify 8259 Channel 2 masked interrupts by alternately turning off and on the interrupt lines.
41	Reserved	

<b>Award POST Codes</b>		
<b>Code</b>	<b>Name</b>	<b>Description</b>
42	Reserved	
43	Test Stuck Interrupt	Turn off interrupts then verify no 8259's interrupt mask register is on. Test 8259 Force an interrupt and verify the interrupt occurred.
44	Reserved	
45	Reinit serial port	Reinitialize Preboot agent serial port
46	Reserved	
47	EISA Test	If EISA non-volatile memory checksum is good, execute EISA initialization. If not, execute ISA tests and clear EISA mode flag.
48	Reserved	
49	Size Memory	Size base memory from 256K to 640K and extended memory above 1MB.
4A	Reserved	
4B	Reserved	
4C	Reserved	
4D	Reserved	
4E	Init APIC	Initialize APIC and set MTRR
4F	Reserved	
50	USB init	Initialize USB controller
51	Reserved	
52	Memory Test	Test all memory of memory above 1MB using Virtual 8086 mode, page mode and clear the memory
53	Reserved	
54	Reserved	
55	CPU display	Detect CPU speed and display CPU vendor specific version string and turn on all necessary CPU features
56	Reserved	
57	PnP Init Display	PnP logo and PnP early init
58	Reserved	
59	Setup Virus	Setup virus protect according to Protect Setup

<b>Award POST Codes</b>		
<b>Code</b>	<b>Name</b>	<b>Description</b>
5A	Reserved	
5B	Awdflash Load	If required, will auto load Awdflash.exe in POST
5C	Reserved	
5D	Onboard I/O	Init Initializing onboard superIO
5E	Reserved	
5F	Reserved	
60	Setup enable	Display setup message and enable setup functions
61	Reserved	
62	Reserved	
63	Initialize Mouse	Detect if mouse is present, initialize mouse, install interrupt vectors.
64	Reserved	
65	PS2 Mouse special	Special treatment to PS2 Mouse port
66	Reserved	
67	ACPI init	ACPI sub-system initializing
68	Reserved	
69	Init Cache	Initialize cache controller
6A	Reserved	
6B	Setup	Enter setup check and autoconfiguration check up
6C	Reserved	
6D	Initialize Floppy	Initialize floppy disk drive
6E	Reserved	
6F	FDD install	Install FDD and setup BIOS data area parameters
70	Reserved	
71	Reserved	
72	Reserved	
73	Initialize Hard Drive	Initialize hard drive controller
74	Reserved	

<b>Award POST Codes</b>		
<b>Code</b>	<b>Name</b>	<b>Description</b>
75	Detect HDD	IDE device detection
76	Reserved	
77	Detect serial ports	Initialize serial ports.
78	Reserved	
79	Reserved	
7A	Detect parallel ports	Initialize parallel ports.
7B	Reserved	
7C	HDD Write Protect	HDD check for write protection
7D	Reserved	
7E	Reserved	
7F	POST error check	Check POST error and display them and ask for user intervention
80	Reserved	
81	Reserved	
82	Security Check	Ask password security.
83	Write CMOS	Write all CMOS values back to RAM and clear screen.
84	Display PNP	Display PNP devices
85	USB Final Init	Final USB initialization
86	Reserved	
87	Reserved	
88	Reserved	
89	Setup ACPI tables	Setup ACPI tables
8A	Reserved	
8B	Option ROM Detect	Scan for Option ROMs
8C	Reserved	
8D	Enable Parity Check	Enable Parity Check



<b>Award POST Codes</b>		
<b>Code</b>	<b>Name</b>	<b>Description</b>
8E	Reserved	
8F	IRQ12 Enable	Enable IRQ12 if mouse present
90	Reserved	
91	Reserved	
92	Reserved	
93	Boot Medium Read	Detect and store boot partition head and cylinders values in RAM
94	Final Init	Final init for last micro details before boot
95	NumLock	Set NumLock status according to Setup
96	Boot Attempt	Set low stack Boot via INT 19h.
C0	Base CPU test	Read/Write CPU registers
C1	Memory Presence	Base memory detect
C2	Early Memory	Board Initialization
C3	Extend Memory	Turn on extended memory, cache initialization
C4	Special Display	First display initialization
C5	Early Shadow	Early shadow enable for fast boot
C6	Cache presence	External cache size detection
CF	CMOS Check	CMOS checkup
B0	Spurious	If interrupt occurs in protected mode.
B1	Unclaimed NMI	If unmasked NMI occurs, display Press F1 to disable NMI, F2 reboot.
BF	Program MCP	To program chipset from defaults values
E1-EF	Setup Pages	E1- Page 1, E2 - Page 2, etc.
FF	Boot	

# EVGA Glossary of Terms

ACPI - Advanced Configuration and Power Interface

AFR – Alternate Frame Rendering

APIC - Advanced Programmable Interrupt Controller

BIOS - Basic Input Output System

CD-ROM - Compact Disc Read-Only Memory

CMOS - Complementary Metal-Oxide Semiconductor

CPU – Central Processing Unit

D-ICE – Dry Ice Cooling

DDR2 - Double Data Rate 2

DDR3 - Double Data Rate 3

DIMM - Dual In-line Memory Module

DRAM - Dynamic random access memory

DVD - Digital Versatile Disc

DVI – Digital Video Interface

FDC - Floppy Disk Controller

FSB – Front Side Bus

FTW – For The Win!

GHz – Gigahertz

GPU – Graphics Processing Unit

HDD - Hard Disk Drive

HDMI - High-Definition Multimedia Interface

HDR – High Dynamic Range Lighting

HPET - High Precision Event Timer

HT – Hyper-Threading

HSF - Heat Sink Fan

I/O - Input/Output  
IDE - Integrated Drive Electronics  
IEEE - Institute of Electrical and Electronics Engineers  
IGP - Integrated Graphics Processors  
IRQ - Interrupt Request  
JBOD - Just a Bunch of Disks  
JEDEC - Joint Electron Device Engineering Council  
LAN - Local Area Network  
LCD - Liquid Crystal Display  
LGA – Land Grid Array  
LN2 – Liquid Nitrogen Cooling  
MAC - Media Access Control  
MCP - Media and Communications Processor  
MHz - Megahertz  
NB - Northbridge  
NCQ - Native Command Queuing  
NIC - Network Interface Card  
NTFS - New Technology File System  
OEM - Original Equipment Manufacturer  
PATA - Parallel Advanced Technology Attachment  
PCB - Printed Circuit Board  
PCI - Peripheral Component Interconnect  
PCIe - Peripheral Component Interconnect Express  
PCI-x - Peripheral Component Interconnect Extended  
POST – Power on Self Test  
PWM – Pulse Width Modulation  
QDR - Quad Data Rate  
QPI – Quick Path Interconnect  
RAID - Redundant Array of Inexpensive Disks  
RGB - Red Green Blue

## EVGA X58 FTW3 Motherboard

SATA - Serial Advanced Technology Attachment

SB - Southbridge

SCSI - Small Computer System Interface

SFR – Split Frame Rendering

SLI - Scalable Link Interface

SPD - Serial Presence Detect

SPDIF - Sony/Philips Digital Interconnect Format

SPP - System Platform Processors

TCP/IP - Transmission Control Protocol/Internet Protocol

USB - Universal Serial Bus

VDroop - V-core Voltage Drop

VGA - Video Graphics Array

# Compliance Information

## FCC Compliance Information

This device complies with FCC Rules Part 15. Operation is subject to the following two conditions: (1) This device may not cause harmful interference, and (2) this device must accept any interference received, including interference that may cause undesired operation. This equipment has been tested and found to comply with the limits for a Class B digital device, pursuant to Part 15 of the FCC Rules. These limits are designed to provide reasonable protection against harmful interference in a residential installation. This equipment generates, uses and can radiate radio frequency energy and, if not installed and used in accordance with the manufacturer's instructions, may cause harmful interference to radio communications. However, there is no guarantee that interference will not occur in a particular installation. If this equipment does cause harmful interference to radio or television reception, which can be determined by turning the equipment off and on, the user is encouraged to try to correct the interference by one or more of the following measures: (1) Increase the separation between the equipment and signal source, or (2) connect the equipment to an outlet on a circuit different from that to which the signal source is connected. Consult the dealer or an experienced computer technician for help. The use of shielded cables for connection of peripheral devices to the PC systems is required to ensure compliance with FCC regulations. Changes or modifications to this unit not expressly approved by the party responsible for compliance could void the user's authority to operate the equipment.

## CE Compliance Information

Generic Radiation Interference Standard for Information Technology Equipment. (EN 55022: 2006, Class B), (EN 61000-3-2: 2006), (EN 61000-3-3: 1995 + A1: 2001 + A2: 2005). Warning: This is a Class B product. In a domestic environment this product may cause radio interference in which case the user may be required to take adequate measure. Generic Immunity Standard for Information Technology Equipment. (EN 55024: 1998 + A1: 2001 + A2: 2003).

## Trademark & Copyright Information

2001-2010 EVGA Corp. EVGA, the EVGA logo and combinations thereof are trademarks of EVGA Corp. All brand names, company names, service marks, logos, and trademarks of the company, or its affiliates or licensors are trademarks or registered trademarks of the company or its subsidiaries, affiliates or licensors in the US and other countries. Other company, products and service names may be trademarks or service marks of others. EVGA reserves the right to terminate this license if there is a violation of its terms or default by the Original Purchaser. Upon termination, for any reason, all copies of Software and materials must be immediately returned to EVGA and the Original Purchaser shall be liable to EVGA.com CORP for any and all damages suffered as a result of the violation or default.

## Legal Information

All material including but not limited to, text, data, design specifications, diagnostics, graphics, logos, reference boards, files, images, drawings, and software including this document and the software itself (together and separately) is owned, controlled by, licensed to, or used with permission by Company and is protected by copyright, trademark, and other intellectual property rights. All is being provided "as is", EVGA Corporation makes no warranties, whether express or implied, statutory or otherwise with respect to the materials and expressly disclaims all implied warranties of non-infringement, merchantability, and fitness for a particular purpose. In no event shall the liability of EVGA Corporation for claims arising from the use of the materials by anyone exceed the original purchase price of the materials (or replacement of the materials at EVGA Corporation's option). All information furnished is believed to be accurate and reliable. However, EVGA Corporation assumes no responsibility for the consequences of use of such information or for any infringement of patents or other rights of third parties that may result from its use, or use of the Software. No license is granted by implication or otherwise under any patent or patent rights of EVGA Corporation except as expressly provided herein. All specifications mentioned in this publication are subject to change without notice.