

Dell™ PowerEdge Expandable RAID Controller 3/QC, 3/DC, 3/DCL and 3/SC

# PERC 3 User's Guide



---

**Information in this document is subject to change without notice.  
© 2002 Dell Computer Corporation. All rights reserved.**

Reproduction in any manner whatsoever without the written permission of Dell Computer Corporation is strictly forbidden.

Trademarks used in this text: *Dell*, the *DELL* logo, *PowerEdge*, *PowerVault*, and *Dell OpenManage* are trademarks and *DellWare* is a registered service mark of Dell Computer Corporation. *MegaRAID* is a registered trademark of LSI Logic Corporation. *Microsoft*, *Windows NT*, *MS-DOS* and *Windows* are registered trademarks of Microsoft Corporation. *Intel* and *Pentium* are registered trademarks of Intel Corporation. *Novell* and *NetWare* are registered trademarks of Novell Corporation. *ASPI* is a registered trademark of Adaptec, Inc. *IBM* is a registered trademark of International Business Machines.

Other trademarks and trade names may be used in this document to refer to either the entities claiming the marks and names or their products. Dell Computer Corporation disclaims any proprietary interest in trademarks and trade names other than its own.

**July 2002      P/N 5C229      Rev. A04**

# Safety Instructions

## **CAUTION: Safety Instructions**

Use the following safety guidelines to help ensure your own personal safety and to help protect your computer and working environment from potential damage.

### **General**

- Do not attempt to service the computer yourself unless you are a trained service technician. Always follow installation instructions closely.
- To help prevent electric shock, plug the computer and device power cables into properly grounded electrical outlets. These cables are equipped with 3-prong plugs to help ensure proper grounding. Do not use adapter plugs or remove the grounding prong from a cable. If you must use an extension cable, use a 3-wire cable with properly grounded plugs.
- To help avoid the potential hazard of electric shock, do not use your computer during an electrical storm.
- To help avoid the potential hazard of electric shock, do not connect or disconnect any cables or perform maintenance or reconfiguration of this product during an electrical storm.
- If your computer includes a modem, the cable used with the modem should be manufactured with a minimum wire size of 26 American wire gauge (AWG) and an FCC-compliant RJ-11 modular plug.
- Before you clean your computer, disconnect the computer from the electrical outlet. Clean your computer with a soft cloth dampened with water. Do not use liquid or aerosol cleaners, which may contain flammable substances.
- To help avoid possible damage to the system board, wait 5 seconds after turning off the computer before disconnecting a device from the computer.
- To avoid shorting out your computer when disconnecting a network cable, first unplug the cable from the network adapter on the back of your computer, and then from the network jack. When reconnecting a network cable to your computer, first plug the cable into the network jack, and then into the network adapter.

- To help protect your computer from sudden, transient increases and decreases in electrical power, use a surge suppressor, line conditioner, or uninterruptible power supply (UPS).
- Ensure that nothing rests on your computer's cables and that the cables are not located where they can be stepped on or tripped over.
- Do not push any objects into the openings of your computer. Doing so can cause fire or electric shock by shorting out interior components.
- Keep your computer away from radiators and heat sources. Also, do not block cooling vents. Avoid placing loose papers underneath your computer; do not place your computer in a closed-in wall unit or on a bed, sofa, or rug.

### When Using Your Computer

As you use your computer, observe the following safe-handling guidelines.

 **CAUTION: Do not operate your computer with any cover(s) (including computer covers, bezels, filler brackets, front-panel inserts, and so on) removed.**

Your computer is equipped with one of the following:

- A fixed-voltage power supply — Computers with a fixed-voltage power supply do not have a voltage selection switch on the back panel and operate at only one voltage (see the regulatory label on the outside of the computer for its operating voltage).
- An auto-sensing voltage circuit — Computers with an auto-sensing voltage circuit do not have a voltage selection switch on the back panel and automatically detect the correct operating voltage.
- A manual voltage selection switch — Computers with a voltage selection switch on the back panel must be manually set to operate at the correct operating voltage.

To help avoid damaging a computer with a manual voltage selection switch, ensure that the voltage selection switch is set to match the AC power available at your location:

- 115 V/60 Hz in most of North and South America and some Far Eastern countries such as South Korea and Taiwan

- 100 V/50 Hz in eastern Japan and 100 V/60 Hz in western Japan
- 230 V/50 Hz in some regions in the Caribbean and South America and most of Europe, the Middle East, and the Far East

Also, ensure that your monitor and attached devices are electrically rated to operate with the AC power available in your location.

- Before working inside the computer, unplug the computer to help prevent electric shock or system board damage. Certain system board components continue to receive power any time the computer is connected to AC power.

 **NOTE:** The voltage selection switch must be set to the 115-V position even though the AC power available in Japan is 100 V.

### When Working Inside Your Computer

Before you open the computer cover, perform the following steps in the sequence indicated.

 **CAUTION:** Do not attempt to service the computer yourself, except as explained in your online Dell™ documentation or in instructions otherwise provided to you by Dell. Always follow installation and service instructions closely.

 **NOTICE:** To help avoid possible damage to the system board, wait 5 seconds after turning off the computer before removing a component from the system board or disconnecting a device from the computer.

- 1 Perform an orderly computer shutdown using the operating system menu.
- 2 Turn off your computer and any devices connected to the computer.
- 3 Ground yourself by touching an unpainted metal surface on the chassis, such as the metal around the card-slot openings at the back of the computer, before touching anything inside your computer.

While you work, periodically touch an unpainted metal surface on the computer chassis to dissipate any static electricity that might harm internal components.

- 4 Disconnect your computer and devices, including the monitor, from their electrical outlets. Also, disconnect any telephone or telecommunication lines from the computer.

Doing so reduces the potential for personal injury or shock.

In addition, take note of these safety guidelines when appropriate:

- When you disconnect a cable, pull on its connector or on its strain-relief loop, not on the cable itself. Some cables have a connector with locking tabs; if you are disconnecting this type of cable, press in on the locking tabs before disconnecting the cable. As you pull connectors apart, keep them evenly aligned to avoid bending any connector pins. Also, before you connect a cable, ensure that both connectors are correctly oriented and aligned.
- Handle components and cards with care. Do not touch the components or contacts on a card. Hold a card by its edges or by its metal mounting bracket. Hold a component such as a microprocessor chip by its edges, not by its pins.



**CAUTION: There is a danger of a new battery exploding if it is incorrectly installed. Replace the battery only with the same or equivalent type recommended by the manufacturer. Do not dispose of the battery along with household waste. Contact your local waste disposal agency for the address of the nearest battery deposit site.**

### Protecting Against Electrostatic Discharge

Static electricity can harm delicate components inside your computer. To prevent static damage, discharge static electricity from your body before you touch any of your computer's electronic components, such as the microprocessor. You can do so by touching an unpainted metal surface on the computer chassis.

As you continue to work inside the computer, periodically touch an unpainted metal surface to remove any static charge your body may have accumulated.

You can also take the following steps to prevent damage from electrostatic discharge (ESD):

- Do not remove components from their antistatic packing material until you are ready to install the component in your computer. Just before unwrapping the antistatic packaging, discharge static electricity from your body.
- When transporting an electrostatic sensitive component, first place it in an antistatic container or packaging.
- Handle all electrostatic sensitive components in a static-safe area. If possible, use antistatic floor pads and workbench pads.

### **Ergonomic Computing Habits**



**CAUTION:** Improper or prolonged keyboard use may result in injury.



**CAUTION:** Viewing the monitor screen for extended periods of time may result in eye strain.

### **Battery Disposal**

Do not dispose of the battery along with household waste. Contact your local waste disposal agency for the address of the nearest battery deposit site.





# Contents

<b>Safety Instructions</b> . . . . .	<b>1</b>
--------------------------------------	----------

## 1 Overview

<b>PERC 3 Overview</b> . . . . .	<b>24</b>
<b>PERC 3 Features</b> . . . . .	<b>24</b>
SCSI Channels . . . . .	25
Non-volatile Random Access Memory (NVRAM) and Flash Read-only Memory (ROM) . . . . .	25
SCSI Connectors . . . . .	25
Single-Ended and LVD SCSI Buses . . . . .	26
Maximum Cable Length for SCSI Standards . . . . .	26
SCSI Bus Widths and Maximum Throughput . . . . .	26
Operating System Support . . . . .	27

## 2 Introduction to RAID

<b>RAID Definition</b> . . . . .	<b>30</b>
<b>PERC 3 Host-Based RAID Solution</b> . . . . .	<b>30</b>
<b>Components and Features</b> . . . . .	<b>31</b>
Physical Array . . . . .	31
Logical Drive . . . . .	31
Fault Tolerance . . . . .	31
Consistency Check . . . . .	32
Disk Striping . . . . .	32
Disk Mirroring . . . . .	34
Disk Spanning . . . . .	35
Spanning for RAID 10 or RAID 50 . . . . .	36

Parity . . . . .	36
Hot Spares . . . . .	37
Disk Rebuilds . . . . .	38
Hot Swap . . . . .	39
SCSI Drive States . . . . .	39
Logical Drive States . . . . .	40
Enclosure Management . . . . .	40

### 3 RAID Levels

<b>Overview . . . . .</b>	<b>42</b>
<b>Selecting a RAID Level . . . . .</b>	<b>42</b>
<b>RAID 0 . . . . .</b>	<b>43</b>
<b>RAID 1 . . . . .</b>	<b>45</b>
<b>RAID 5 . . . . .</b>	<b>46</b>
<b>RAID 10 . . . . .</b>	<b>48</b>
<b>RAID 50 . . . . .</b>	<b>50</b>

### 4 PERC 3/SC Features

<b>Hardware Requirements . . . . .</b>	<b>54</b>
<b>Configuration Features . . . . .</b>	<b>54</b>
SMART Technology . . . . .	55
Configuration on Disk Configuration . . . . .	55
<b>Hardware Architecture Features . . . . .</b>	<b>56</b>
<b>Array Performance Features . . . . .</b>	<b>56</b>
<b>PERC 3/SC Fault Tolerance Features . . . . .</b>	<b>57</b>
<b>Software Utilities . . . . .</b>	<b>57</b>
<b>Operating System Software Drivers . . . . .</b>	<b>58</b>

<b>PERC 3/SC Specifications</b> . . . . .	<b>58</b>
PCI Bridge/CPU . . . . .	59
Cache Memory . . . . .	59
PERC 3/SC BIOS . . . . .	60
Onboard Speaker . . . . .	60
Serial Port . . . . .	60
SCSI Bus . . . . .	60
SCSI Connectors . . . . .	60
SCSI Termination . . . . .	60
SCSI Firmware . . . . .	61
RAID Management . . . . .	61

## 5 PERC 3/DC and PERC 3/DCL Features

<b>Hardware Requirements</b> . . . . .	<b>64</b>
<b>Configuration Features</b> . . . . .	<b>64</b>
SMART Technology . . . . .	65
Configuration on Disk . . . . .	65
<b>Hardware Architecture Features</b> . . . . .	<b>66</b>
<b>Array Performance Features</b> . . . . .	<b>67</b>
<b>Fault Tolerance Features</b> . . . . .	<b>67</b>
<b>Software Utilities</b> . . . . .	<b>68</b>
<b>Operating System Software Drivers</b> . . . . .	<b>68</b>
<b>PERC 3/DC and PERC 3/DCL Specifications</b> . . . . .	<b>68</b>
PCI Bridge/CPU . . . . .	69
Cache Memory . . . . .	70
PERC 3/DC and PERC 3/DCL BIOS . . . . .	70
Onboard Speaker . . . . .	70
Serial Port . . . . .	70
SCSI Bus . . . . .	70
SCSI Connectors . . . . .	71
SCSI Termination . . . . .	71

SCSI Firmware . . . . .	71
RAID Management . . . . .	72

## 6 PERC 3/QC Features

<b>Hardware Requirements . . . . .</b>	<b>74</b>
<b>Configuration Features . . . . .</b>	<b>74</b>
SMART Technology . . . . .	75
Configuration on Disk . . . . .	75
<b>Hardware Architecture Features . . . . .</b>	<b>76</b>
<b>Array Performance Features . . . . .</b>	<b>76</b>
<b>Fault Tolerance Features . . . . .</b>	<b>77</b>
<b>Software Utilities . . . . .</b>	<b>77</b>
<b>Operating System Software Drivers . . . . .</b>	<b>78</b>
<b>PERC 3/QC Specifications . . . . .</b>	<b>78</b>
PCI Bridge/CPU . . . . .	79
Cache Memory . . . . .	79
PERC 3/QC BIOS . . . . .	80
Onboard Speaker . . . . .	80
Serial Port . . . . .	80
SCSI Bus . . . . .	80
SCSI Connectors . . . . .	80
SCSI Termination . . . . .	80
SCSI Firmware . . . . .	81
RAID Management . . . . .	81

## 7 Configuring PERC 3

<b>Configuring SCSI Physical Drives . . . . .</b>	<b>84</b>
<b>Current Configuration . . . . .</b>	<b>84</b>
<b>Logical Drive Configuration . . . . .</b>	<b>87</b>

<b>Physical Device Layout</b> . . . . .	<b>89</b>
<b>Configuring Arrays</b> . . . . .	<b>92</b>
Arranging Arrays . . . . .	93
Creating Hot Spares . . . . .	93
Creating Logical Drives . . . . .	93
<b>Configuration Strategies</b> . . . . .	<b>93</b>
Maximizing Capacity . . . . .	94
Maximizing Drive Availability . . . . .	94
Maximizing Drive Performance . . . . .	95
<b>Assigning RAID Levels</b> . . . . .	<b>95</b>
<b>Configuring Logical Drives</b> . . . . .	<b>96</b>
<b>Optimizing Data Storage</b> . . . . .	<b>96</b>
Data Access Requirements . . . . .	96
Array Functions . . . . .	97
<b>Planning the Array Configuration</b> . . . . .	<b>97</b>
Using the Array Configuration Planner . . . . .	98
<b>Random Array Deletion</b> . . . . .	<b>99</b>
Overview . . . . .	99
Configuration Module . . . . .	100

## 8 PERC 3/SC Hardware Installation

<b>Requirements</b> . . . . .	<b>102</b>
Optional Equipment . . . . .	102
<b>PERC 3/SC Card Layout</b> . . . . .	<b>103</b>
<b>Installation Steps</b> . . . . .	<b>103</b>
Step 1—Unpack . . . . .	104
Step 2—Power Down . . . . .	104
Step 3—Set Jumpers . . . . .	105
Step 4—Set SCSI Termination . . . . .	108

Step 5—Install PERC 3/SC . . . . .	111
Step 6—Connect SCSI Cables . . . . .	113
Step 7—Set Target IDs . . . . .	114
Step 8—Power On Host System . . . . .	115
Step 9—Run PERC 3 BIOS Configuration Utility or WebBIOS Utility . . . . .	116
Step 10—Install Operating System Software Drivers . . . . .	116

## 9 PERC 3/DC or PERC 3/DCL Hardware Installation

<b>Requirements . . . . .</b>	<b>118</b>
Optional Equipment . . . . .	118
<b>PERC 3/DC Card Layout . . . . .</b>	<b>119</b>
<b>PERC 3/DCL Card Layout . . . . .</b>	<b>120</b>
<b>Installation Steps . . . . .</b>	<b>120</b>
Step 1—Unpack the PERC 3/DC or PERC 3/DCL . . . . .	121
Step 2—Power Down . . . . .	121
Step 3—Set Jumpers . . . . .	121
Step 4—Set SCSI Termination . . . . .	125
Step 5—Install the PERC 3/DC or PERC 3/DCL Controller . . . . .	126
Step 6—Select and Set Target IDs for SCSI Devices . . . . .	128
Step 7—Connect SCSI Cables . . . . .	128
Step 8—Power On Host System . . . . .	130
Step 9—Run the PERC 3 BIOS Configuration Utility or WebBIOS Configuration Utility . . . . .	130
Step 10—Install Operating System Software Driver . . . . .	131
<b>Replacing a PERC 3/DC Containing a BC Chip with a PERC 3/DC Containing a BE Chip . . . . .</b>	<b>131</b>
Using Driver 5.22.1 or 5.22.2 and Firmware 161J or 161N . . . . .	131
Using Driver 5.30 and Firmware 1.70 . . . . .	131

## 10 PERC 3/QC Hardware Installation

<b>Requirements . . . . .</b>	<b>134</b>
-------------------------------	------------

Optional Equipment . . . . .	134
<b>PERC 3/QC Card Layout . . . . .</b>	<b>135</b>
<b>Installation Steps . . . . .</b>	<b>136</b>
Step 1—Unpack the PERC 3/QC Controller . . . . .	136
Step 2—Power Down . . . . .	137
Step 3—Set Jumpers . . . . .	137
Step 4—Set SCSI Termination . . . . .	140
SCSI Termination . . . . .	141
Step 5—Install PERC 3/QC . . . . .	143
Step 6—Connect SCSI Cables . . . . .	145
Step 7—Set Target IDs . . . . .	146
Step 8—Power on Host System . . . . .	146
Step 9—Run the PERC 3 BIOS Configuration Utility or WebBIOS Configuration Utility . . . . .	147
Step 10—Install Operating System Driver . . . . .	147

## 11 PERC 3 BIOS Configuration Utility

<b>Configuration On Disk . . . . .</b>	<b>150</b>
<b>Starting the PERC 3 BIOS Configuration Utility . . . . .</b>	<b>150</b>
<b>BIOS Configuration Utility Menu Options . . . . .</b>	<b>151</b>
Configure Menu . . . . .	152
Initialize Menu . . . . .	153
Objects Menu . . . . .	153
Format Menu . . . . .	158
Rebuild Menu . . . . .	158
Check Consistency Menu . . . . .	159
<b>Configuring Arrays and Logical Drives . . . . .</b>	<b>159</b>
<b>Choosing the Configuration Method . . . . .</b>	<b>160</b>
Easy Configuration . . . . .	160
New Configuration . . . . .	160
View/Add Configuration . . . . .	161

PERC 3/QC and PERC 3/DC Default Settings . . . . .	161
PERC 3/SC and PERC 3/DCL Default Settings . . . . .	161
Reserved Disk Space during Configuration . . . . .	162
<b>Designating Drives as Hot Spares . . . . .</b>	<b>162</b>
<b>Using Easy Configuration . . . . .</b>	<b>163</b>
<b>Using New Configuration . . . . .</b>	<b>167</b>
<b>Using View/Add Configuration . . . . .</b>	<b>173</b>
<b>Initializing Logical Drives . . . . .</b>	<b>178</b>
Batch Initialization . . . . .	178
Individual Initialization . . . . .	179
<b>Deleting Logical Drives (Random Array Deletion) . . . . .</b>	<b>179</b>
<b>Formatting Physical Drives . . . . .</b>	<b>180</b>
Media Errors . . . . .	180
Formatting Drives . . . . .	180
<b>Rebuilding Failed Disk Drives . . . . .</b>	<b>182</b>
Manual Rebuild – Rebuilding an Individual Drive . . . . .	182
Manual Rebuild – Batch Mode . . . . .	182
<b>Using a Pre-loaded SCSI Drive “As-is” . . . . .</b>	<b>183</b>
<b>Exiting the PERC 3 BIOS Configuration Utility . . . . .</b>	<b>184</b>
<b>Setting Hardware Termination . . . . .</b>	<b>184</b>
<b>Clustering . . . . .</b>	<b>185</b>
Cluster Mode . . . . .	185
Enabling and Disabling the Cluster Mode . . . . .	185

## 12 Dell Manager

<b>Starting Dell Manager . . . . .</b>	<b>188</b>
Management Menu Options . . . . .	189
Using Dell Manager in Red Hat Linux GUI Mode . . . . .	189



<b>Dell Manager Menu Options</b> . . . . .	<b>190</b>
Initialize Menu . . . . .	190
Objects Menu . . . . .	190
Format Menu . . . . .	194
Rebuild Menu . . . . .	195
Check Consistency Menu . . . . .	195
Reconstruct Menu . . . . .	195
<b>Designating Drives as Hot Spares</b> . . . . .	<b>195</b>
<b>Parameters</b> . . . . .	<b>196</b>
<b>Initializing Logical Drives</b> . . . . .	<b>197</b>
Batch Initialization . . . . .	197
Individual Initialization . . . . .	198
<b>Deleting Logical Drives (Random Array Deletion)</b> . . . . .	<b>198</b>
<b>Formatting Physical Drives</b> . . . . .	<b>199</b>
Media Errors . . . . .	199
Formatting Drives . . . . .	200
<b>Rebuilding Failed Disk Drives</b> . . . . .	<b>201</b>
Manual Rebuild – Rebuilding an Individual Drive . . . . .	201
Manual Rebuild – Batch Mode . . . . .	202
<b>Exiting Dell Manager</b> . . . . .	<b>202</b>

## 13 Troubleshooting

<b>Overview</b> . . . . .	<b>204</b>
<b>BIOS Boot Error Messages</b> . . . . .	<b>205</b>
<b>Other BIOS Error Messages</b> . . . . .	<b>208</b>
<b>Other Potential Problems</b> . . . . .	<b>209</b>
<b>Audible Warnings</b> . . . . .	<b>210</b>

**14** Appendix A: SCSI Cables and Connectors

**15** Appendix B: Warranties and Return Policy

Glossary . . . . . 237

Index . . . . . 247

## Figures

Figure 2-1. Example of Disk Striping . . . . .	33
Figure 2-2. Example of Disk Mirroring . . . . .	34
Figure 2-3. Example of Disk Spanning . . . . .	35
Figure 2-4. Example of Parity . . . . .	37
Figure 3-1. RAID 0 Array . . . . .	44
Figure 3-2. RAID 1 Array . . . . .	46
Figure 3-3. RAID 5 Array . . . . .	48
Figure 3-4. RAID 10 Array . . . . .	50
Figure 3-5. RAID 50 Array . . . . .	52
Figure 8-1. PERC 3/SC Card Layout . . . . .	103
Figure 8-2. Example of SCSI Termination . . . . .	108
Figure 8-3. Termination of Internal SCSI Disk Arrays . . . . .	110
Figure 8-4. PCI Slots on Motherboard . . . . .	111
Figure 8-5. Installation of PERC 3/SC Card into Motherboard . . . . .	112
Figure 8-6. Connecting SCSI Cables . . . . .	113
Figure 9-1. PERC 3/DC Card Layout . . . . .	119
Figure 9-2. PERC 3/DCL Card Layout . . . . .	120
Figure 9-3. J11 Serial Port Pinout . . . . .	123
Figure 9-4. Termination of Internal SCSI Disk Arrays for PERC 3/DC and 3/DCL . . . . .	126
Figure 9-5. Installation of the PERC 3/DC and 3/DCL . . . . .	127
Figure 9-6. Connecting SCSI Cables to PERC 3/DC and 3/DCL . . . . .	129
Figure 10-1. PERC 3/QC Card Layout . . . . .	135
Figure 10-2. J14 Serial Port Diagram . . . . .	139
Figure 10-3. Example of Termination . . . . .	141
Figure 10-4. Termination of Internal SCSI Disk Arrays . . . . .	142
Figure 10-5. PCI Slots on Motherboard . . . . .	143
Figure 10-6. Installation of the PERC 3/QC Card . . . . .	144
Figure 10-7. Connecting SCSI Cables . . . . .	145



## Tables

Table 1-1. Maximum Cable Length for SCSI Standards . . . . .	26
Table 1-2. SCSI Bus Widths and Maximum Throughput . . . . .	27
Table 2-1. Spanning for RAID 10 and RAID 50 . . . . .	36
Table 2-2. Types of Parity . . . . .	36
Table 2-3. SCSI Drive States . . . . .	39
Table 2-4. Logical Drive States . . . . .	40
Table 3-1. RAID Levels . . . . .	42
Table 3-2. RAID 0 Overview . . . . .	43
Table 3-3. RAID 1 Overview . . . . .	45
Table 3-4. RAID 5 Overview . . . . .	47
Table 3-5. RAID 10 Overview . . . . .	49
Table 3-6. RAID 50 Overview . . . . .	51
Table 4-1. Configuration Features . . . . .	54
Table 4-2. Configuration on Disk Features . . . . .	55
Table 4-3. Hardware Architecture Features . . . . .	56
Table 4-4. Array Performance Features . . . . .	56
Table 4-5. PERC 3/SC Fault Tolerance Features . . . . .	57
Table 4-6. Software Utilities Features . . . . .	57
Table 4-7. PERC 3/SC Specifications . . . . .	58
Table 4-8. SCSI Firmware Support . . . . .	61
Table 5-1. Configuration Features . . . . .	64
Table 5-2. Configuration on Disk Features . . . . .	65
Table 5-3. Hardware Architecture Features . . . . .	66
Table 5-4. Array Performance Features . . . . .	67
Table 5-5. Fault Tolerance Features . . . . .	67
Table 5-6. Software Utilities . . . . .	68
Table 5-7. PERC 3/DC and PERC 3/DCL Specifications . . . . .	68
Table 5-8. SCSI Firmware . . . . .	71
Table 6-1. Configuration Features . . . . .	74
Table 6-2. Configuration on Disk Features . . . . .	75

Table 6-3. Hardware Architecture Features . . . . .	76
Table 6-4. Array Performance Features . . . . .	76
Table 6-5. Fault Tolerance Features . . . . .	77
Table 6-6. Software Utilities . . . . .	78
Table 6-7. PERC 3/QC Specifications . . . . .	78
Table 6-8. SCSI Firmware . . . . .	81
Table 7-1. Current Configuration for SCSI Channel 0 . . . . .	84
Table 7-2. Current Configuration for SCSI Channel 1 . . . . .	85
Table 7-3. Current Configuration for SCSI Channel 2 . . . . .	86
Table 7-4. Current Configuration for SCSI Channel 3 . . . . .	87
Table 7-5. Logical Drive Configuration . . . . .	87
Table 7-6. Physical Device Layout . . . . .	89
Table 7-7. Drives and Capacities for Each RAID Level . . . . .	94
Table 7-8. Fault Tolerance Features for RAID Levels 0, 1 and 5 . . . . .	94
Table 7-9. Performance Characteristics for Each RAID Level . . . . .	95
Table 7-10. Physical Drives Required for Each RAID Level . . . . .	95
Table 7-11. Factors to Consider for Array Configuration . . . . .	97
Table 7-12. Array Configuration Planner . . . . .	98
Table 8-1. PERC 3/SC Jumpers . . . . .	105
Table 8-2. J1 Termination Enable Settings . . . . .	105
Table 8-3. J9 I2C Interface Connector Pinout . . . . .	106
Table 8-4. J5 Serial Port Pinout . . . . .	106
Table 8-5. J8 Hard Disk LED . . . . .	107
Table 8-6. J15 RUBI Slot Interrupt Steering . . . . .	107
Table 8-7. J16, J17 RUBI Slot Interrupt Steering . . . . .	108
Table 8-8. Target IDs . . . . .	115
Table 9-1. Jumper Settings . . . . .	121
Table 9-2. J2 and J3 Termination Enable Settings . . . . .	122
Table 9-3. J9 Onboard BIOS Enable Settings . . . . .	122
Table 9-4. J10 NVRAM Clear Pinout . . . . .	123
Table 9-5. J11 Serial Port Pinout . . . . .	123

Table 9-6. J13 Dirty Cache LED Pinout . . . . .	124
Table 9-7. J14 SCSI Activity Pinout . . . . .	124
Table 9-8. J16 and J18 TERMPWR Enable Settings . . . . .	124
Table 9-9. J17 I2C Connector Pinout . . . . .	125
Table 9-10. Target IDs for SCSI Devices . . . . .	128
Table 10-1. PERC 3/QC Jumper Settings . . . . .	137
Table 10-2. J2, J3, J5 and J7 Termination Enable Pinout . . . . .	138
Table 10-3. J9, J10, J11 and J12 TERMPWR Enable Pinout . . . . .	138
Table 10-4. J14 Serial Port Pinout . . . . .	139
Table 10-5. J17 Dirty Cache LED Pinout . . . . .	139
Table 10-6. J19 Onboard BIOS Enable Settings . . . . .	140
Table 10-7. J23 External Battery Pinout . . . . .	140
Table 10-8. Target IDs . . . . .	146
Table 11-1. BIOS Configuration Utility Menu Options . . . . .	151
Table 11-2. Configuration Menu Options . . . . .	152
Table 11-3. Adapter Menu Options . . . . .	153
Table 11-4. Logical Drive Menu Options . . . . .	155
Table 11-5. Physical Drive Menu Options . . . . .	156
Table 11-6. SCSI Channel Menu Options . . . . .	157
Table 11-7. Battery Information Menu Options . . . . .	157
Table 11-8. PERC 3/QC and PERC 3/DC Default Settings . . . . .	161
Table 11-9. PERC 3/SC and PERC 3/DCL Default Settings . . . . .	161
Table 11-10. Rebuild Types . . . . .	182
Table 12-1. Command Used to Start Dell Manager . . . . .	188
Table 12-2. Management Menu Options . . . . .	189
Table 12-3. Adapter Menu Options . . . . .	190
Table 12-4. Logical Drive Menu Options . . . . .	191
Table 12-5. Logical Drive Default Settings . . . . .	191
Table 12-6. Physical Drive Menu Options . . . . .	192
Table 12-7. SCSI Channel Options . . . . .	193
Table 12-8. Battery Backup Menu Items . . . . .	193

Table 12-9. Rebuild Types . . . . .	201
Table 13-1. General Problems and Suggested Solutions . . . . .	204
Table 13-2. BIOS Boot Error Messages . . . . .	205
Table 13-3. Other BIOS Error Messages . . . . .	208
Table 13-4. Other Potential Problems . . . . .	209
Table 13-5. Audible Warnings . . . . .	210



SECTION 1

## Overview

---

[PERC 3 Overview](#)

[PERC 3 Features](#)



**NOTE:** The information in this document applies to PERC 3/QC, PERC 3/DC, PERC 3/DCL and PERC 3/SC.

## PERC 3 Overview

The Dell™ PowerEdge™ Expandable RAID Controller 3 (PERC 3) PCI card is a high-performance, intelligent peripheral component interconnect (PCI)-to-SCSI host adapter with RAID control capabilities. PERC 3 provides system availability, high performance, and fault-tolerant disk subsystem management. PERC 3 is an ideal RAID solution for the internal storage of Dell's workgroup, departmental, and enterprise systems. PERC 3 offers a cost-effective way to implement RAID in a server.

The PERC 3/QC low voltage differential (LVD) PCI RAID card provides four SCSI channels. The PERC 3/DC and PERC 3/DCL LVD PCI RAID card provides two SCSI channels. The PERC 3/SC LVD PCI RAID card provides one SCSI channel.

With LVD, you can use cables up to 25 meters long. Throughput on each SCSI channel can be as high as 160 MB/s. PERC 3 supports both an LVD SCSI bus and a single-ended SCSI bus.

PERC 3 64-bit LVD is a high-performance, intelligent PCI-to-SCSI host adapter with RAID control capabilities. PERC 3 64-bit LVD requires no special motherboard PCI expansion slot.

## PERC 3 Features

The PERC 3 features include:

- Wide Ultra3 LVD SCSI performance of up to 160 MB/s
- PERC 3/QC and PERC 3/DC support 128 MB of synchronous dynamic random access memory (SDRAM.)
- The PERC 3/DCL supports 64 MB of SDRAM.
- The PERC 3/SC supports 32 MB of SDRAM.
- 64-bit PCI host interface (only on PERC 3/QC and PERC 3/DC)
- The PERC 3/QC, PERC 3/DC and PERC 3/DCL have an on-board i960RN processor to improve controller performance and offload host Central Processing Unit (CPU.)
- The PERC 3/SC has a on-board i960RM processor to improve controller performance and offload host CPU.

- Two internal and four external connectors for the PERC 3/QC, two internal and two external connectors for the PERC 3/DC and PERC 3/DCL, and one internal and one external connector for the PERC 3/SC
- RAID levels 0 (striping), 1 (mirroring), 5 (distributed parity), 10 (combination of striping and mirroring), and 50 (combination of striping and distributed parity)
- Advanced array configuration and management utilities
- Battery backup for up to 72 hours for the PERC 3/QC and PERC 3/DC
- Up to 12 SCSI drives per channel using the Dell PowerVault 21xS storage system or 14 SCSI drives using the Dell PowerVault 22xS

 **NOTE:** Clustering is not supported by PERC 3/QC or PERC 3/DCL.

### SCSI Channels

The PERC 3/QC controller card includes four SCSI channels. There are two QLogic® 12160 chips; each chip controls two SCSI channels.

The PERC 3/DC and PERC 3/DCL controller cards include two SCSI channels. There is one QLogic 12160 chip, which controls two SCSI channels.

The PERC 3/SC controller card has one SCSI channel. There is one QLogic 10160 chip.

### Non-volatile Random Access Memory (NVRAM) and Flash Read-only Memory (ROM)

A 32 KB x 8 NVRAM stores RAID system configuration information. The PERC 3 firmware is stored in flash ROM for easy upgrade.

### SCSI Connectors

PERC 3/QC has four ultra-high-density 68-pin external connectors for the external storage subsystem and two high-density 68-pin internal connectors.

PERC 3/DC and PERC 3/DCL have two ultra-high-density 68-pin external connectors for the external storage subsystem and two high-density 68-pin internal connectors.

PERC 3/SC has one ultra-high-density 68-pin external connector for the external storage subsystem and one high-density 68-pin internal connector.

### Single-Ended and LVD SCSI Buses

The SCSI standard defines two electrical buses: a single-ended bus and an LVD bus. PERC 3 supports both standards.

### Maximum Cable Length for SCSI Standards

Table 1-1 displays the maximum length of cable that you can use for various SCSI standards.

**Table 1-1. Maximum Cable Length for SCSI Standards**

SCSI Standard	Single-ended	LVD	Maximum # of Drives
SCSI I	6 m	12 m	7
Fast SCSI	6 m	12 m	7
Fast Wide SCSI	6 m	12 m	15
Ultra SCSI	1.5 m	12 m	7
Ultra SCSI	3 m	12 m	3
Wide Ultra SCSI	N/A	12 m	15
Wide Ultra SCSI	1.5 m	12 m	7
Wide Ultra SCSI	3 m	12 m	3
Ultra 2 SCSI	N/A	25 m	1
Ultra 2 SCSI	N/A	12 m	7
Wide Ultra 2 SCSI	N/A	25 m	1
Wide Ultra 2 SCSI	N/A	12 m	15

### SCSI Bus Widths and Maximum Throughput

Table 1-2 displays the SCSI bus widths and maximum throughput for each of the SCSI standards.

**Table 1-2. SCSI Bus Widths and Maximum Throughput**

<b>SCSI Standard</b>	<b>SCSI Bus Width</b>	<b>SCSI Throughput</b>
SCSI I	8 bits	5 MB/s
Fast SCSI	8 bits	10 MB/s
Fast Wide SCSI	16 bits	20 MB/s
Ultra SCSI	8 bits	20 MB/s
Wide Ultra SCSI	16 bits	40 MB/s
Ultra 2 SCSI	8 bits	40 MB/s
Wide Ultra 2 SCSI	16 bits	80 MB/s
160M SCSI	8 bits	80 MB/s
Wide 160M SCSI	16 bits	160 MB/s

### **Operating System Support**

PERC 3 supports the following operating systems:

- Microsoft® Windows® 2000: Server, Advanced Server, Small Business Server
- Microsoft Windows NT® 4: Server, Terminal Server, Enterprise Server, Small Business Server
- Microsoft NET: Server, Advanced Server
- Microsoft SBS 2000
- Novell® NetWare® 5.x, 6.x
- Red Hat Linux 7.x
- DOS, including ASPI® support



SECTION 2

## **Introduction to RAID**

---

[RAID Definition](#)

[PERC 3 Host-Based RAID Solution](#)

[Components and Features](#)

## RAID Definition

RAID is an array of multiple independent hard disk drives that provides high performance and fault tolerance. The RAID array appears to the host computer as a single storage unit or as multiple logical units. Input/output (I/O) improves because several disks can be accessed simultaneously. Although hard drive capabilities have improved drastically, actual performance has improved only three to four times in the last decade. In comparison, computing performance has improved over 50 times during the same time period. Implementing RAID improves the performance of the disk subsystem.

RAID systems also improve data storage availability and fault tolerance. Data loss caused by a hard drive failure can be recovered by reconstructing missing data from the remaining data and parity drives.

## PERC 3 Host-Based RAID Solution

PERC 3 is a peripheral component interconnect (PCI) adapter card that is installed in any available PCI expansion slot in a host system. It is a host-based RAID solution, meaning that the RAID controller puts all of the RAID intelligence on an adapter card that is installed in a network server.

The array controller resides on the bus (for example, a PCI or EISA bus) in the host computer and has its own central processing unit (CPU) to generate the parity and handle other RAID functions. A bus-based controller can transfer data at the speed of the host bus (PCI, ISA, EISA, VL-Bus), but is limited to the bus it is designed for. PERC 3 resides on a PCI bus, which can handle data transfer at up to 528 MB/s. With PERC 3, each channel can handle data transfer rates up to 160 MB/s per SCSI channel. The available sequential data transfer rate is determined by the following factors:

- The sustained data transfer rate on the motherboard PCI bus
- The sustained data transfer rate on the i960RN (i960RM for the PERC 3/SC) PCI to PCI bridge
- The sustained data transfer rate of the SCSI controller
- The sustained data transfer rate of the SCSI devices



- The number of SCSI channels and SCSI hard drives

## Components and Features

RAID versions, or levels, are specifications that describe a system for ensuring the availability and stability of data stored on large disk subsystems. A RAID system can be implemented in a number of different levels). PERC 3 supports RAID levels 0, 1, 5, 10 (1+0), and 50 (5+0).

### Physical Array

A RAID array is a collection of physical disk drives governed by the RAID management software. A RAID array appears to the host computer as one or more logical drives.

### Logical Drive

A logical drive is a partition in a physical array of disks that is made up of contiguous data segments on the physical disks. A logical drive can consist of an entire physical array, more than one entire physical array, a part of an array, parts of more than one array, or a combination of any two of these conditions.

### Fault Tolerance

Fault tolerance is the capability of the subsystem to undergo a single failure without compromising data integrity, and processing capability. The RAID controller provides this support through redundant arrays in RAID levels 1, 5, 10 and 50. The system can still work properly even with a single disk failure in an array, though performance can be degraded to some extent.

Fault tolerance is often associated with system availability (high mean time between failure, MTFB) because it allows the system to be available during the failures. However, this means it is also important for the system to be available during the repair of the problem. To make this possible, PERC 3 supports hot spare disks, and the auto-rebuild feature.

A hot spare is an unused online disk that, in case of a disk failure in a redundant RAID array, can be used to rebuild the data and re-establish redundancy. After the hot spare is automatically moved into the RAID subsystem, the failed drive is automatically rebuilt on the spare drive. The RAID disk array continues to handle requests while the rebuild occurs.

Auto-rebuild allows a failed drive to be replaced and automatically rebuilt by “hot-swapping” the drive in the same drive bay. The RAID disk array continues to handle requests while the rebuild occurs.

### **Consistency Check**

In RAID, check consistency verifies the correctness of redundant data in an array. For example, in a system with parity, checking consistency means computing the data on one drive and comparing the results to the contents of the parity drive.

### **Disk Striping**

Disk striping allows you to write data across multiple disk drives instead of just one disk drive. Disk striping involves partitioning each drive storage space into stripes that can vary in size from 2 KB to 128 KB. These stripes are interleaved in a repeated sequential manner. The combined storage space is composed of stripes from each drive. PERC 3 supports stripe sizes of 2 KB, 4 KB, 8 KB, 16 KB, 32 KB, 64 KB, and 128 KB.

For example, in a four-disk system using only disk striping (as in RAID level 0), segment 1 is written to disk 1, segment 2 is written to disk 2, and so on. Disk striping enhances performance because multiple drives are accessed simultaneously, but disk striping does not provide data redundancy.

Figure 2-1 shows an example of disk striping.

**Figure 2-1. Example of Disk Striping**

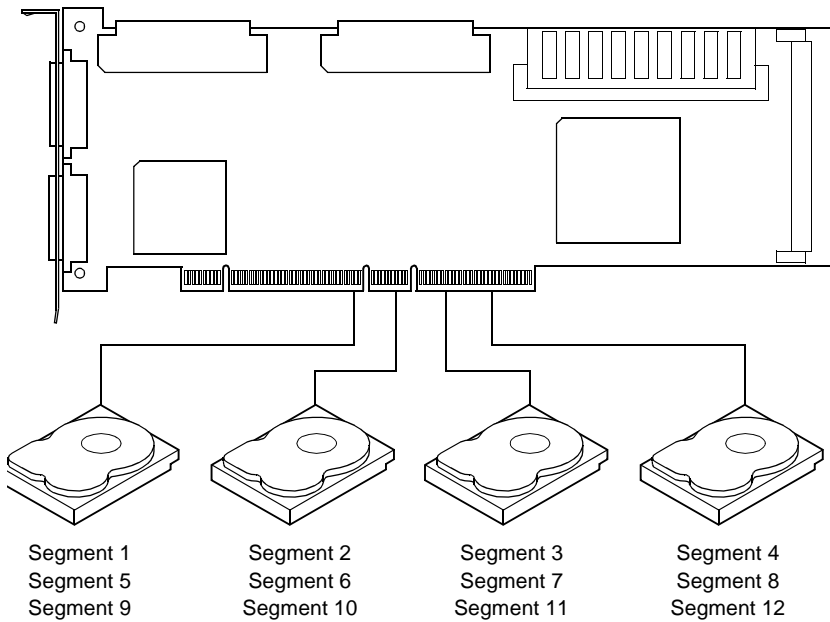

**Stripe Width**

Stripe width is the number of disks involved in an array where striping is implemented. For example, a four-disk array with disk striping has a stripe width of four.

**Stripe Size**

The stripe size is the length of the interleaved data segments that PERC 3 writes across multiple drives. PERC 3 supports stripe sizes of 2 KB, 4 KB, 8 KB, 16 KB, 32 KB, 64 KB, or 128 KB.

### Disk Mirroring

With mirroring (used in RAID 1), data written to one disk is simultaneously written to another disk. If one disk fails, the contents of the other disk can be used to run the system and reconstruct the failed disk. The primary advantage of disk mirroring is that it provides 100% data redundancy. Because the contents of the disk are completely written to a second disk, it does not matter if one of the disks fails. Both disks contain the same data at all times. Either drive can act as the operational drive.

Disk mirroring provides 100% redundancy, but is expensive because each drive in the system must be duplicated.

Figure 2-2. Example of Disk Mirroring

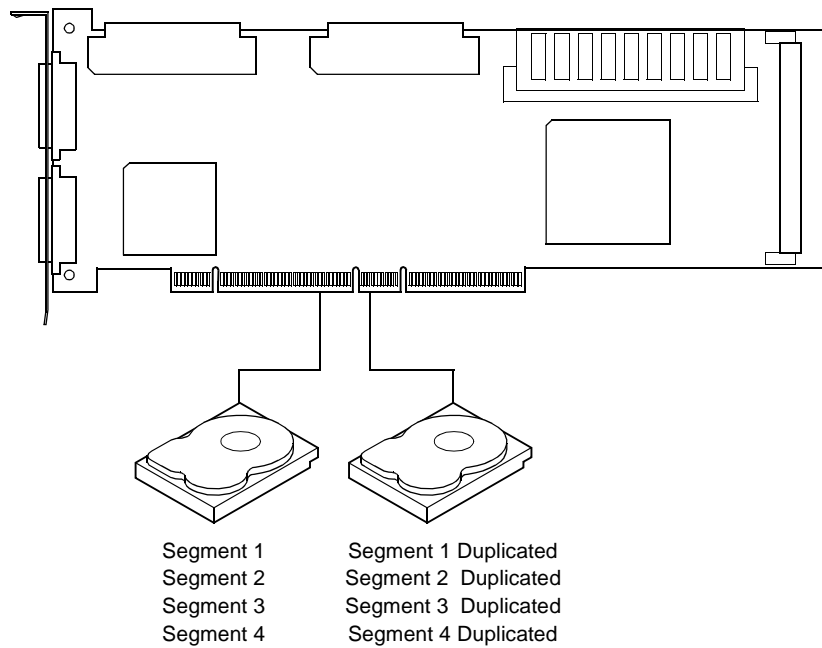



## Disk Spanning

Disk spanning allows multiple physical drives to function like one big drive. Spanning overcomes lack of disk space and simplifies storage management by combining existing resources or adding relatively inexpensive resources. For example, four 20 GB drives can be combined to appear to the operating system as a single 80 GB drive.

Spanning alone does not provide reliability or performance enhancements. Spanned logical drives must have the same stripe size and must be contiguous. In the following graphic, RAID 1 array is turned into a RAID 10 array.

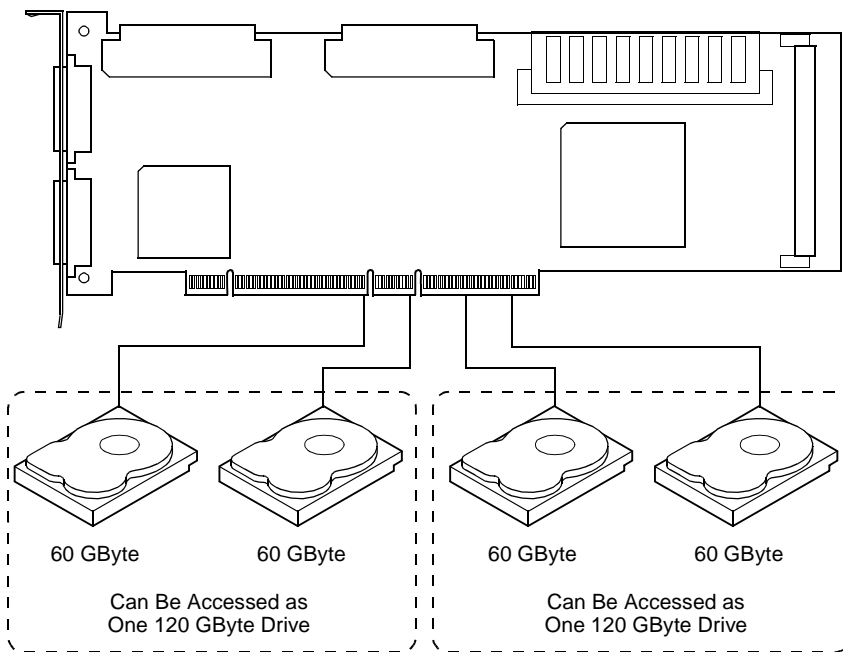
**Figure 2-3. Example of Disk Spanning**





 **NOTE:** Spanning two contiguous RAID 0 logical drives does not produce a new RAID level or add fault tolerance. It does increase the size of the logical volume and improves performance by doubling the number of spindles.

## Spanning for RAID 10 or RAID 50

Table 2-1 describes how to configure RAID 10 and RAID 50 by spanning.

**Table 2-1. Spanning for RAID 10 and RAID 50**

Level	Description
10	Configure RAID 10 by spanning two contiguous RAID 1 logical drives. The RAID 1 logical drives must have the same stripe size.  <b>NOTE:</b> Refer to Chapter 11 "PERC 3 BIOS Configuration Utility" for the configuration procedure for spanning RAID 1 logical drives.
50	Configure RAID 50 by spanning two contiguous RAID 5 logical drives. The RAID 5 logical drives must have the same stripe size.  <b>NOTE:</b> Refer to Chapter 11 "PERC 3 BIOS Configuration Utility" for the configuration procedure for spanning RAID 5 logical drives.

## Parity

Parity generates a set of redundancy data from two or more parent data sets. The redundancy data can be used to reconstruct one of the parent data sets. Parity data does not fully duplicate the parent data sets. In RAID, this method is applied to entire drives or stripes across all disk drives in an array. The types of parity are shown in Table 2-2.

**Table 2-2. Types of Parity**

Parity Type	Description
Dedicated	The parity of the data on two or more disk drives is stored on an additional disk.
Distributed	The parity data is distributed across all drives in the system.

If a single disk drive fails, it can be rebuilt from the parity and the data on the remaining drives. RAID level 5 combines distributed parity with disk striping. Parity provides redundancy for one drive failure without duplicating the contents of entire disk drives, but parity generation can slow the write process. A dedicated parity scheme during normal read/write operations is shown in Figure 2-4.

**Figure 2-4. Example of Parity**

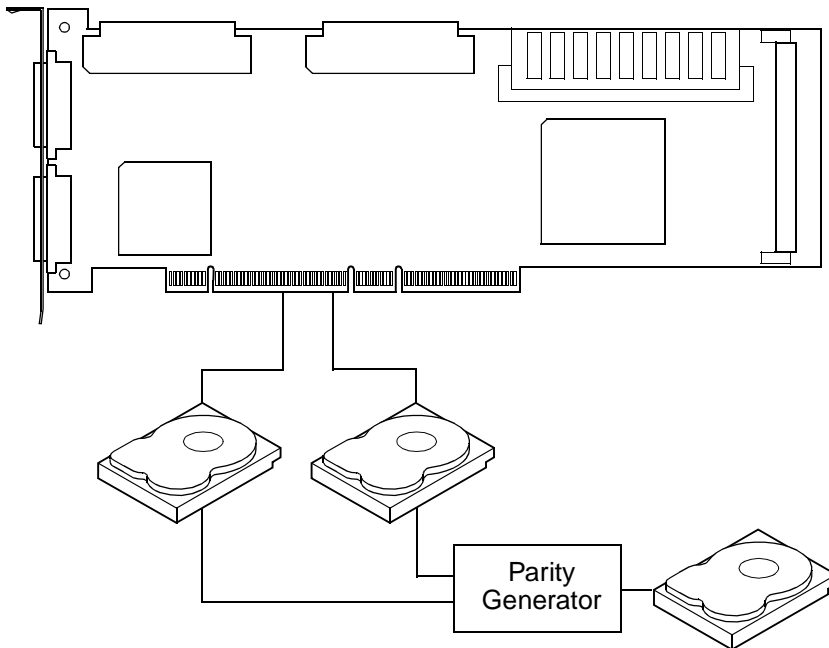

### **Hot Spares**

A hot spare is an extra, unused disk drive that is part of the disk subsystem. It is usually in standby mode, ready for service if a drive fails. Hot spares permit you to replace failed drives without system shutdown or user intervention.

PERC 3 implements automatic and transparent rebuilds using hot spare drives, providing a high degree of fault tolerance and zero downtime. The PERC 3 RAID management software allows you to specify physical drives as hot spares. When a hot spare is needed, PERC 3 assigns the hot spare that has a capacity closest to and at least as great as that of the failed drive to take the place of the failed drive.

 **NOTE:** Refer to Chapter 11 "PERC 3 BIOS Configuration Utility" for the procedures used to designate a drive as a hot spare.

 **NOTE:** Refer to Chapter 11 "PERC 3 BIOS Configuration Utility" for the procedures used to designate a drive as a hot spare.

There are two types of hot spares:

- Global Hot Spare
- Dedicated Hot Spare

### **Global Hot Spare**

A global hot spare drive can be used to replace any failed drive in a redundant array as long as its capacity is equal to or larger than the coerced capacity of the failed drive. A global hot spare defined on any channel should be available to replace a failed drive on both channels.

### **Dedicated Hot Spare**

A dedicated hot spare can be used to replace a failed drive only in a selected array. One or more drives can be designated as member of a spare drive pool; the most suitable drive from the pool is selected for fail over. A dedicated hot spare is used before one from the global hot spare pool.

Hot spare drives can be located on any RAID channel. Standby hot spares (not being used in RAID array) are polled every 60 seconds at a minimum, and their status made available in the array management software. PERC 3 offers the ability to rebuild with a disk that is in a system, but not initially set to be a hot spare.

Observe the following parameters when using hot spares:

- Hot spares are used only in arrays with redundancy, for example, RAID levels 1, 5, 10, and 50.
- A hot spare connected to a specific PERC 3 controller can be used to rebuild a drive that is connected to the same controller only.
- You must assign the hot spare to one or more drives through the controller's BIOS or use array management software to place it in the hot spare pool.
- A hot spare must have free space equal to or greater than the drive it would replace. For example, to replace an 18 GB drive, the hot spare must be 18 GB or larger.

### **Disk Rebuilds**

You can rebuild a disk drive by recreating the data that had been stored on the drive before the drive failed.



Rebuilding can be done only in arrays with data redundancy, which includes as RAID 1, 5, 10 and 50.

A hot spare can be used to rebuild disk drives in RAID 1, 5, 10, or 50 systems. If a hot spare is not available, the failed disk drive must be replaced with a new disk drive so that the data on the failed drive can be rebuilt.

Using hot spares, PERC 3 can automatically and transparently rebuild failed drives with user-defined rebuild rates. If a hot spare is available, the rebuild can start automatically when a drive fails. PERC 3 automatically restarts the system and the rebuild if the system goes down during a rebuild.

### **Rebuild Rate**

The rebuild rate is the percentage of the compute cycles dedicated to rebuilding failed drives. A rebuild rate of 100 percent means the system is totally dedicated to rebuilding the failed drive.

The PERC 3 rebuild rate can be configured between 0% and 100%. At 0%, the rebuild is done only if the system is not doing anything else. At 100%, the rebuild has a higher priority than any other system activity. The default rebuild rate is 30%.

### **Hot Swap**

A hot swap is the manual replacement of a defective physical disk unit while the computer is still running. When a new drive has been installed, a rebuild will occur automatically if it is placed in the same drive bay as the failed drive it is replacing. PERC 3 can be configured to detect the new disks and to rebuild the contents of the disk drive automatically.

### **SCSI Drive States**

The SCSI drive states are listed in Table 2-3.

**Table 2-3. SCSI Drive States**

<b>State</b>	<b>Description</b>
Online (ONLIN)	The drive is working normally and is a part of a configured logical drive.

**Table 2-3. SCSI Drive States (continued)**

State	Description
Ready (READY)	The drive is functioning normally but is not part of a configured logical drive and is not designated as a hot spare.
Hot Spare (HOTSP)	The drive is powered up and ready for use as a spare in case an online drive fails.
Fail (FAIL)	A fault has occurred in the drive, placing it out of service.
Rebuild (REB)	The drive is being rebuilt with data from a failed drive.

### Logical Drive States

The logical drive states are listed in Table 2-4.

**Table 2-4. Logical Drive States**

State	Description
Optimal	The drive operating condition is good. All configured drives are online.
Degraded	The drive operating condition is not optimal. One of the configured drives has failed or is offline.
Failed	The drive has failed.
Offline	The drive is not available to the RAID controller.

### Enclosure Management

Enclosure management is the intelligent monitoring of the disk subsystem by software and/or hardware. The disk subsystem can be part of the host computer or separate from it. Enclosure management helps you stay informed of events in the disk subsystem, such as a drive or power supply failure. Enclosure management increases the fault tolerance of the disk subsystem.

SECTION 3

## RAID Levels

---

[Overview](#)

[Selecting a RAID Level](#)

[RAID 0](#)

[RAID 1](#)

[RAID 5](#)

[RAID 10](#)

[RAID 50](#)

## Overview

There are six official RAID levels (RAID 0 through RAID 5.) PERC 3 supports RAID levels 0, 1, 5, 10, and 50. The RAID levels that PERC 3 supports are shown in Table 3-1.

**Table 3-1. RAID Levels**

<b>RAID Level</b>	<b>Type</b>
0	Standard
1	Standard
5	Standard
1+0	Combination of RAID 0 and RAID 1
5+0	Combination of RAID 0 and RAID 5

PERC 3 also supports independent drives (configured as RAID 0.)

## Selecting a RAID Level

To ensure the best performance, you should select the optimal RAID level when you create a system drive. The optimal RAID level for your disk array depends on a number of factors:

- The number of physical drives in the disk array
- The capacity of the physical drives in the array
- The need for data redundancy
- The disk performance requirements

## RAID 0

RAID 0 provides disk striping across all drives in the RAID subsystem. RAID 0 does not provide any data redundancy, but does offer the best performance of any RAID level. RAID 0 breaks up data into smaller blocks and then writes a block to each drive in the array. The size of each block is determined by the stripe size parameter, set during the creation of the RAID set. RAID 0 offers high bandwidth.

By breaking up a large file into smaller blocks, PERC 3 can use several drives to read or write the file faster. RAID 0 involves no parity calculations to complicate the write operation. This makes RAID 0 ideal for applications that require high bandwidth but do not require fault tolerance. RAID 0 is also used to denote an “independent” or single drive.

Table 3-2 provides an overview of RAID 0.

**Table 3-2. RAID 0 Overview**

<b>Uses</b>	RAID 0 provides high data throughput, especially for large files. Any environment that does not require fault tolerance.
<b>Strong Points</b>	Provides increased data throughput for large files. No capacity loss penalty for parity.
<b>Weak Points</b>	Does not provide fault tolerance. All data lost if any drive fails.
<b>Drives</b>	1 to 32

Figure 3-1 displays an example of a RAID 0 array.

**Figure 3-1. RAID 0 Array**

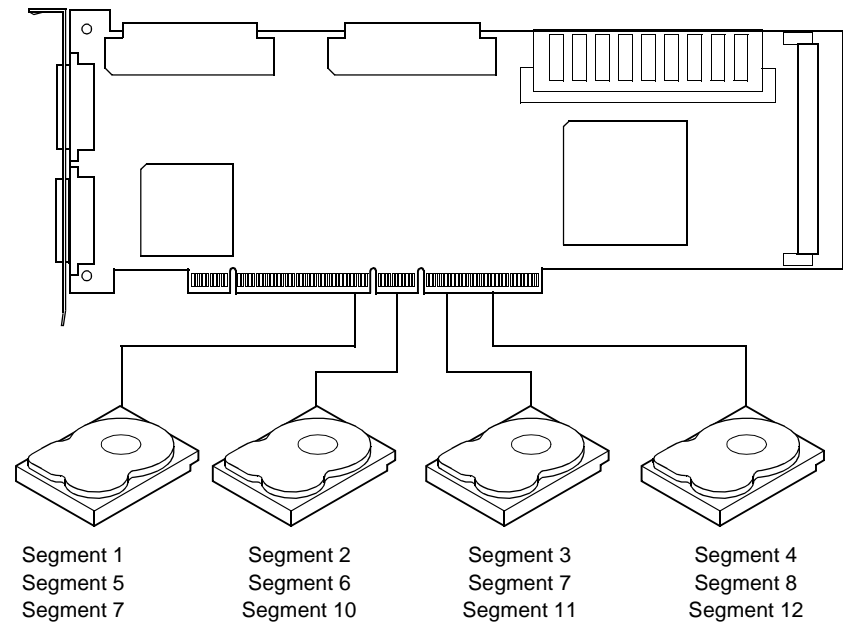

## RAID 1

In RAID 1, the RAID controller duplicates all data from one drive to a second drive. RAID 1 provides complete data redundancy, but at the cost of doubling the required data storage capacity, as shown in Figure 3-2. Table 3-3 provides an overview of RAID 1.

**Table 3-3. RAID 1 Overview**

<b>Uses</b>	Use RAID 1 for small databases or any other environment that requires fault tolerance but small capacity.
<b>Strong Points</b>	RAID 1 provides complete data redundancy. RAID 1 is ideal for any application that requires fault tolerance and minimal capacity.
<b>Weak Points</b>	RAID 1 requires twice as many disk drives. Performance is impaired during drive rebuilds.
<b>Drives</b>	2

Figure 3-2. RAID 1 Array

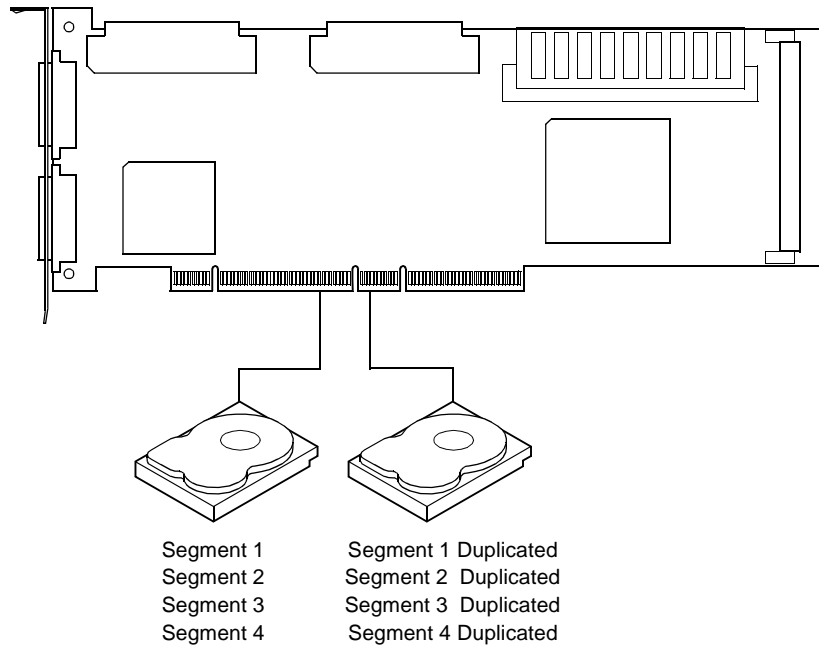

## RAID 5

RAID 5 includes disk striping at the block level and parity. In RAID 5, the parity information is written to several drives. RAID 5 is best suited for networks that perform a lot of small input/output (I/O) transactions simultaneously.

RAID 5 addresses the bottleneck issue for random I/O operations. Because each drive contains both data and parity numerous writes can take place concurrently. In addition, robust caching algorithms and hardware based exclusive-or assist make RAID 5 performance exceptional in many different environments.

Table 3-4 provides an overview of RAID 5.

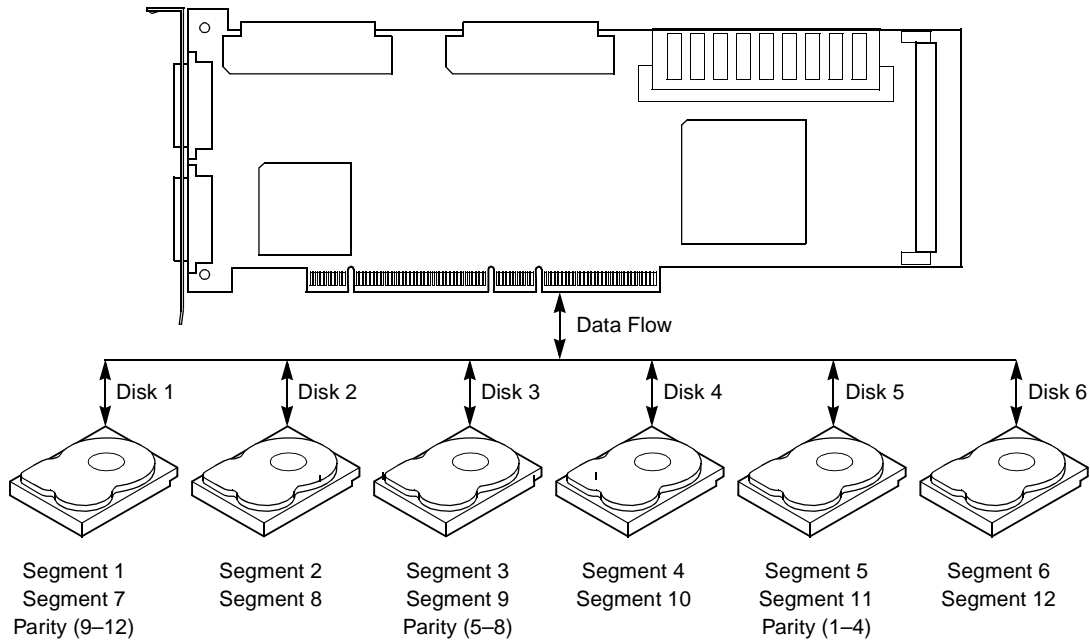

**Table 3-4. RAID 5 Overview**

<b>Uses</b>	RAID 5 provides high data throughput, especially for large files. Use RAID 5 for transaction processing applications because each drive can read and write independently. If a drive fails, PERC 3 uses the parity drive to recreate all missing information. Use also for office automation and online customer service that requires fault tolerance. Use for any application that has high read request rates but low write request rates.
<b>Strong Points</b>	Provides data redundancy and good performance in most environments
<b>Weak Points</b>	Disk drive performance will be reduced if a drive is being rebuilt. Environments with few processes do not perform as well because the RAID overhead is not offset by the performance gains in handling simultaneous processes.
<b>Drives</b>	3 to 32

Figure 3-3 displays an example of a RAID 5 array.

**Figure 3-3. RAID 5 Array**



Note: Parity is distributed across drives in the array.

## RAID 10

RAID 10 is a combination of RAID 0 and RAID 1. RAID 10 has mirrored drives. RAID 10 breaks up data into smaller blocks, and then mirrors the blocks of data to each RAID 1 RAID set. Each RAID 1 RAID set then duplicates its data to its other drive. The size of each block is determined by the stripe size parameter, which is set during the creation of the RAID set. RAID 10 can sustain one to four drive failures while maintaining data integrity if each failed disk is in a different RAID 1 array.

Table 3-5 provides an overview of RAID 10.

**Table 3-5. RAID 10 Overview**

<b>Uses</b>	RAID 10 works best for data storage that needs 100% redundancy of mirrored arrays and that also needs the enhanced I/O performance of RAID 0 (striped arrays.) RAID 10 works well for medium-sized databases or any environment that requires a higher degree of fault tolerance and moderate to medium capacity.
<b>Strong Points</b>	RAID 10 provides both high data transfer rates and complete data redundancy.
<b>Weak Points</b>	RAID 10 requires twice as many drives as all other RAID levels except RAID 1.
<b>Drives</b>	$2n$ , where $n$ is greater than 1. The maximum number of drives is 16.

Figure 3-4. RAID 10 Array

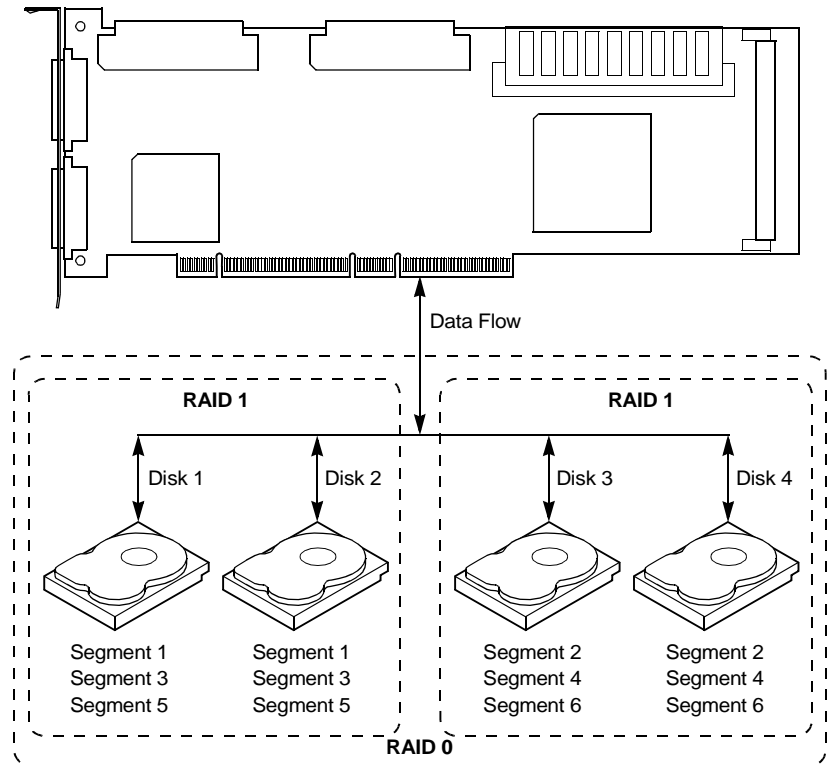

## RAID 50

RAID 50 provides the features of both RAID 0 and RAID 5. RAID 50 includes both parity and disk striping across multiple drives. RAID 50 is best implemented on two RAID 5 disk arrays with data striped across both disk arrays.

RAID 50 breaks up data into smaller blocks, and then stripes the blocks of data to each RAID 5 array. RAID 5 breaks up data into smaller blocks, calculates parity by performing an exclusive-or on the blocks, and then writes the blocks of data and parity to each drive in the array. The size of each block is determined by the stripe size parameter, which is set during the creation of the RAID set.

RAID 50 can sustain one to four drive failures while maintaining data integrity if each failed disk is in a different RAID 5 array.

Table 3-6 provides an overview of RAID 50.

**Table 3-6. RAID 50 Overview**

<b>Uses</b>	RAID 50 works best when used with data that requires high reliability, high request rates, and high data transfer and medium to large capacity.
<b>Strong Points</b>	RAID 50 provides high data throughput, data redundancy, and very good performance.
<b>Weak Points</b>	Requires 2 to 4 times as many parity drives as RAID 5.
<b>Drives</b>	6 to 256 (Eight arrays x 32 stripes = 256 drives)

Figure 3-5 displays an example of a RAID 50 array.

Figure 3-5. RAID 50 Array

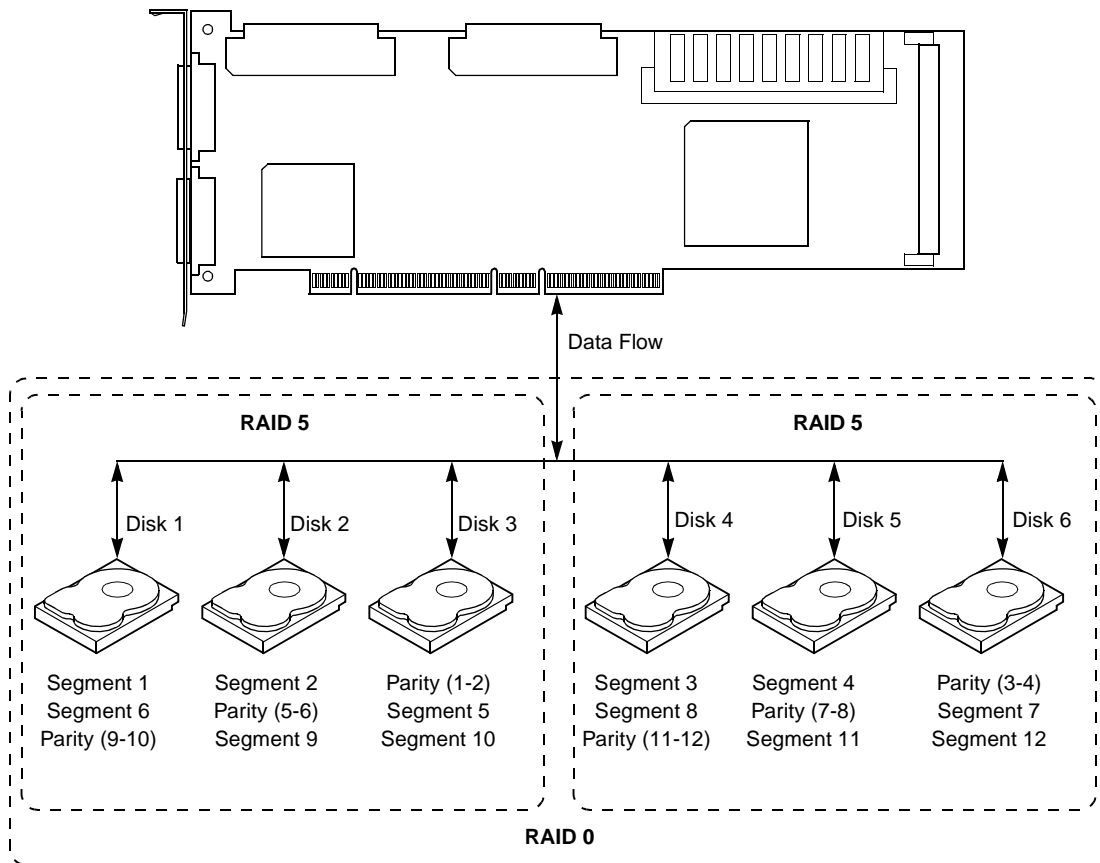

SECTION 4

## **PERC 3/SC Features**

---

Hardware Requirements

Configuration Features

Hardware Architecture Features

Array Performance Features

PERC 3/SC Fault Tolerance Features

Software Utilities

Operating System Software Drivers

PERC 3/SC Specifications

## Hardware Requirements

PERC 3/SC has one SCSI channel that supports 160M and Wide SCSI at data transfer rates up to 160 MB/s. The SCSI channel supports up to 15 Wide devices or up to seven narrow devices.

PERC 3/SC can be installed in a Dell™ PowerEdge™ computer with a motherboard that has 5 V, 32- or 64-bit PCI expansion slots. The computer should have an Intel® Pentium® II or higher central processing unit (CPU), a diskette drive, a color monitor and video graphics adapter (VGA) card, and a keyboard. A mouse is recommended.

## Configuration Features

Table 4-1 lists the configuration features for the PERC 3/SC controller.

**Table 4-1. Configuration Features**

Specification	Feature
RAID levels	0, 1, 5, 10, and 50.
SCSI channels	1
Maximum number of drives per channel	15
Array interface to host	PCI 2.2
Drive interface	Wide 160M
Cache memory size	32 MB
Cache function	Write-back, write-through, adaptive read-ahead, non-read-ahead, read-ahead
Multiple logical drives/arrays per controller	Up to 40 logical drives per controller
Maximum number of PERC 3/SC controller per system	Contact your Dell representative.
Online capacity expansion	Yes
Dedicated and pool hot spare	Yes
Flashable firmware	Yes
Hot swap devices supported	Yes



**Table 4-1. Configuration Features (continued)**

Specification	Feature
Non-disk devices supported	No
Mixed capacity hard disk drives	Yes
Number of 16-bit internal connectors	1

### SMART Technology

The PERC 3/SC self-monitoring analysis and reporting technology (SMART) detects predictable drive failures. SMART monitors the internal performance of all motors, heads, and drive electronics.

### Configuration on Disk Configuration

Configuration on Disk (drive roaming) saves configuration information both in non-volatile random access memory (NVRAM) on PERC 3/SC and on the disk drives attached to PERC 3/SC. If the controller is replaced, the new controller detects the actual RAID configuration from the configuration information on the drives. This maintains the integrity of the data on each drive, even if the drives have changed their target ID.

Drive roaming is supported across channels on the same controller. Drive roaming across channels is **not** supported when cluster mode is enabled. Table 4-2 lists the Configuration on Disk features for the PERC 3/SC controller.

 **NOTE:** Configuration on Disk does not work if you change both the adapter, and the SCSI connectors to different connectors on the new adapter. It will work only if you make one change at a time.

**Table 4-2. Configuration on Disk Features**

Specification	Feature
Support for hard disk drives with capacities of more than 8 gigabytes (GB)	Yes
Online RAID level migration	Yes
RAID remapping	Yes
No reboot necessary after expansion	Yes (only if virtual sizing is enabled)
More than 200 qtags per array	Yes
Hardware clustering support on the board	Yes

**Table 4-2. Configuration on Disk Features (continued)**

Specification	Feature
User-specified rebuild rate	Yes

## Hardware Architecture Features

The PERC 3/SC hardware architecture features are shown in Table 4-3.

**Table 4-3. Hardware Architecture Features**

Specification	Feature
Processor	Intel i960RM 100MHz
SCSI controller(s)	One QLogic® 10160 Single SCSI controller
Size of flash ROM	1 MB
Amount of NVRAM	32 KB
Hardware-exclusive OR (XOR) assistance	Yes
Direct I/O	Yes
SCSI bus termination	Active, single-ended or low voltage differential (LVD)
Double-sided dual in-line memory modules (DIMMs)	Yes
Auxiliary TermPWR source	No
Direct I/O bandwidth	132 MB/s

## Array Performance Features

The PERC 3/SC array performance features are shown in Table 4-4.

**Table 4-4. Array Performance Features**

Specification	Feature
Host data transfer rate	132 MB/s
Drive data transfer rate	160 MB/s

**Table 4-4. Array Performance Features (continued)**

<b>Specification</b>	<b>Feature</b>
Maximum scatter/gathers	26 elements
Maximum size of I/O requests	6.4 MB in 64 KB stripes
Maximum queue tags per drive	As many as the drive can accept.
Stripe sizes	2 KB, 4 KB, 8 KB, 16 KB, 32 KB, 64 KB, or 128 KB
Maximum number of concurrent commands	255
Support for multiple initiators	Yes

## PERC 3/SC Fault Tolerance Features

The PERC 3/SC fault tolerance features are shown in Table 4-5.

**Table 4-5. PERC 3/SC Fault Tolerance Features**

<b>Specification</b>	<b>Feature</b>
Support for SMART	Yes
Drive failure detection	Automatic
Drive rebuild using hot spares	Automatic
Manual replacement of drives without system shutdown	Yes
Parity generation and checking	Yes

## Software Utilities

The PERC 3/SC software utilities are shown in Table 4-6.

**Table 4-6. Software Utilities Features**

<b>Specification</b>	<b>Feature</b>
Graphical user interface	Yes
Management utility	Yes

**Table 4-6. Software Utilities Features (continued)**

Specification	Feature
Bootup configuration using the PERC BIOS configuration utility (Ctrl-M)	Yes
Online read, write, and cache policy switching	Yes
Intranet support	Yes

## Operating System Software Drivers

### Operating System Drivers

PERC 3/SC includes a disk operating system (DOS) software configuration utility and drivers for Microsoft® Windows NT® V4.0, Windows® 2000, Novell® NetWare® 5.x, 6.x, and Red Hat Linux 7.x.

## PERC 3/SC Specifications

The PERC 3/SC specifications are shown in Table 4-7.

**Table 4-7. PERC 3/SC Specifications**

Parameter	Specification
Card size	Half-length PCI adapter card size (6.875" X 4.2")
Processor	Intel i960RM™ 64-bit RISC processor @ 100 MHz
Bus type	PCI 2.2
PCI controller	Intel i960RM
Bus data transfer rate	Up to 132 MB/s at 32/33 MHz
Basic input/output system (BIOS)	PERC 3/SC BIOS
Cache configuration	32 MB
Firmware	1 MB × 8 flash ROM
Non-volatile random access memory (RAM)	32 KB × 8 for storing RAID configuration
Operating voltage	5 V, 3.3 V

**Table 4-7. PERC 3/SC Specifications (continued)**

<b>Parameter</b>	<b>Specification</b>
SCSI controller	One SCSI controller for 160M and Wide support
SCSI data transfer rate	Up to 160 MB/s per channel
SCSI bus	Low-voltage differential (LVD) or single-ended
SCSI termination	Active
Termination disable	Automatic through cable and device detection
Devices per SCSI channel	Up to 15 wide or seven narrow SCSI devices
SCSI device types	Synchronous or asynchronous
RAID levels supported	0, 1, 5, 10, and 50
SCSI connectors	One 68-pin internal high-density connectors for 16-bit SCSI devices. One ultra-high density 68-pin external connectors for 160M and Wide SCSI.
Serial port	3-pin RS232C-compatible connector (for manufacturing use only)

### **PCI Bridge/CPU**

PERC 3/SC uses the Intel i960RM PCI bridge with an embedded i960RM RISC processor running at 100 MHz. The RM bridge handles data transfers between the primary (host) PCI bus, the secondary PCI bus, cache memory, and the SCSI bus. The DMA controller supports chaining and unaligned data transfers. The embedded i960JT CPU directs all controller functions, including command processing, SCSI bus transfers, RAID processing, drive rebuilding, cache management, and error recovery.

### **Cache Memory**

32 MB of PERC 3/SC cache memory resides in a memory bank. PERC 3/SC supports write-through or write-back caching, selectable for each logical drive. To improve performance in sequential disk accesses, the PERC 3/SC controller uses read-ahead caching by default. You can disable read-ahead caching.

## PERC 3/SC BIOS

The BIOS resides on a 1 MB × 8 flash ROM for easy upgrade. The PERC 3/SC BIOS supports INT 13h calls to boot DOS without special software or device drivers. The PERC 3/SC BIOS provides an extensive setup utility that can be accessed by pressing <Ctrl> <M> at BIOS initialization. The PERC 3/SC BIOS Configuration Utility is described in Chapter 11.

## Onboard Speaker

The PERC 3/SC controller has an onboard tone generator for audible warnings when system errors occur. Audible warnings can be generated through this speaker. The audible warnings are listed in Chapter 13.

## Serial Port

PERC 3/SC includes a 3-pin RS232C-compatible serial port connector. This is for manufacturing use only.

## SCSI Bus

PERC 3/SC has one Wide 160M SCSI channels that support both LVD and single-ended devices with active termination. Synchronous and asynchronous devices are supported. PERC 3/SC provides automatic termination disable via cable detection. The SCSI channel supports up to 15 wide or seven non-wide SCSI devices at speeds up to 160 MB/s.

## SCSI Connectors

PERC 3/SC has two types of SCSI connectors:

- One 68-pin high density internal connector
- One 68-pin external ultra-high-density connector

Only one connector *type* can be used for the SCSI channel at any one time.

## SCSI Termination

PERC 3/SC uses active termination on the SCSI bus conforming to SCSI-2 and SCSI-3 specifications. Termination enable/disable is automatic through cable detection.

## SCSI Firmware

The PERC 3/SC firmware handles all RAID and SCSI command processing and also supports the features shown in Table 4-8.

**Table 4-8. SCSI Firmware Support**

<b>Feature</b>	<b>Description</b>
Disconnect/reconnect	Optimizes SCSI bus utilization
Tagged command queuing	Multiple tags to improve random access
Scatter/gather	Single command can transfer data to and from different memory locations
Multi-threading	Up to 255 simultaneous commands with elevator sorting and concatenation of requests per SCSI channel
Stripe size	Variable for all logical drives: 2 KB, 4 KB, 8 KB, 16 KB, 32 KB, 64 KB, or 128 KB.
Rebuild	Multiple rebuilds and consistency checks with user-definable priority

## RAID Management

RAID management is provided by software utilities that manage and configure the RAID system and PERC 3/SC, create and manage multiple disk arrays, control and monitor multiple RAID servers, provide error statistics logging, and provide online maintenance. They include:

- PERC 3 BIOS Configuration utility (Ctrl-M)
- Dell Manager
- WebBIOS Configuration Utility
- Dell™ OpenManage™ Array Manager

### PERC 3 BIOS Configuration Utility

You can use the PERC 3 BIOS Configuration Utility to configure and maintain RAID arrays, format disk drives, and manage the RAID system. It is independent of any operating system. See Chapter 11 "PERC 3 BIOS Configuration Utility" for additional information.

### **Dell Manager**

Dell Manager is a character-based, non-GUI utility that changes policies and parameters, and monitors RAID systems. Dell Manager runs under Novell NetWare 5.x, 6.x, and Red Hat Linux 7.x. See Chapter 12 "Dell Manager" for additional information.

### **WebBIOS Configuration Utility**

WebBIOS is used to configure and manage a RAID system using an HTML interface. See the *WebBIOS Configuration Utility Guide* for more information.

### **Dell OpenManage Array Manager**

Dell OpenManage Array Manager is used to configure and manage a storage system that is connected to a server, while the server is active and continues to handle requests. Array Manager runs under NetWare, Windows NT, and Windows 2000. Refer to Dell documentation on the Dell web site at [support.dell.com](http://support.dell.com) for more information.



# 5

## SECTION 5

# **PERC 3/DC and PERC 3/DCL Features**

---

Hardware Requirements

Configuration Features

Hardware Architecture Features

Array Performance Features

Fault Tolerance Features

Software Utilities

Operating System Software Drivers

PERC 3/DC and PERC 3/DCL Specifications

 **NOTE:** The PERC 3/DC has a battery option, while the PERC 3/DCL does not have a battery option.

## Hardware Requirements

PERC 3/DC and PERC 3/DCL have two SCSI channels that support 160M and Wide SCSI at data transfer rates up to 160 MB/s. The SCSI channel supports up to 15 Wide devices or up to seven narrow devices.

PERC 3/DC and PERC 3/DCL can be installed in a system with a motherboard that has 5 V, 32- or 64-bit PCI expansion slots. The system should have an Intel® Pentium® II or higher central processing unit (CPU), a diskette drive, a color monitor, video graphics adapter (VGA) card, and a keyboard. A mouse is recommended.

## Configuration Features

The PERC 3/DC and PERC 3/DCL configuration features are shown in Table 5-1.

**Table 5-1. Configuration Features**

Specification	Feature
RAID levels	0, 1, 5, 10, and 50
SCSI channels	2
Maximum number of drives per channel	15
Array interface to host	PCI 2.2
Drive interface	Wide 160M
Cache memory size	64 MB (PERC 3/DCL) 128 MB DIMM (PERC 3/DC)
Cache function	Write-back, write-through, adaptive read-ahead, non read-ahead, read-ahead
Multiple logical drives/arrays per controller	Up to 40 logical drives per controller
Maximum number of PERC 3/DC and PERC 3/DCL controllers per system	Contact your Dell™ representative.
Online capacity expansion	Yes
Dedicated and pool hot spare	Yes

**Table 5-1. Configuration Features (continued)**

Specification	Feature
Flashable firmware	Yes
Hot swap devices supported	Yes
Non-disk devices supported	No
Mixed capacity hard disk drives	Yes
Number of 16-bit internal connectors	2
Cluster support	Yes (PERC 3/DC only)

### SMART Technology

The PERC 3/DC and PERC 3/DCL self-monitoring analysis and reporting technology (SMART) detects predictable drive failures. SMART monitors the internal performance of all motors, heads, and drive electronics.

### Configuration on Disk

Configuration on Disk (drive roaming) saves configuration information both in NVRAM on PERC 3/DC and PERC 3/DCL and on the disk drives attached to PERC 3/DC and PERC 3/DCL. If PERC 3/DC and PERC 3/DCL are replaced, the new PERC 3/DC and PERC 3/DCL controllers detect the actual RAID configuration, maintaining the integrity of the data on each drive, even if the drives have changed channel and/or target ID.

Drive roaming is supported across channels on the same controller. Drive roaming across channels is **not** supported when cluster mode is enabled. Table 5-2 shows the features for Configuration on Disk.

 **NOTE:** Configuration on Disk does not work if you change both the adapter, and the SCSI connectors to different connectors on the new adapter. It works only if you make one change at a time.

**Table 5-2. Configuration on Disk Features**

Specification	Feature
Support for hard disk drives with capacities of more than 8 gigabytes (GB)	Yes
Online RAID level migration	Yes
RAID remapping	Yes
No reboot necessary after expansion	Yes (Only if virtual sizing is enabled.)

**Table 5-2. Configuration on Disk Features (continued)**

Specification	Feature
More than 200 qtags per array	Yes
Hardware clustering support on the board	Yes
User-specified rebuild rate	Yes

## Hardware Architecture Features

Table 5-3 displays the PERC 3/DC and PERC 3/DCL hardware architecture features.

**Table 5-3. Hardware Architecture Features**

Specification	Feature
Processor	Intel i960RN 100MHz
SCSI controller(s)	One QLogic® 12160 Dual SCSI controller
Size of flash ROM	1 MB
Amount of non-volatile random access memory (NVRAM)	32 KB
Hardware-exclusive OR (XOR) assistance	Yes
Direct input/output (I/O)	Yes
SCSI bus termination	Active, single-ended or low voltage differential (LVD)
Double-sided dual in-line memory modules (DIMMs)	Yes
Auxiliary TermPWR source	No
Direct I/O bandwidth	533 MB/s (greater than 200 MB/s sustained)

## Array Performance Features

Table 5-4 displays the PERC 3/DC and PERC 3/DCL array performance features.

**Table 5-4. Array Performance Features**

<b>Specification</b>	<b>Feature</b>
Host data transfer rate	533 MB/s
Drive data transfer rate	160 MB/s
Maximum scatter/gathers	26 elements
Maximum size of I/O requests	6.4 MB in 64 KB stripes
Maximum queue tags per drive	As many as the drive can accept.
Stripe sizes	2 KB, 4 KB, 8 KB, 16 KB, 32 KB, 64 KB, or 128 KB
Maximum number of concurrent commands	255
Support for multiple initiations	Yes

## Fault Tolerance Features

Table 5-5 lists the fault tolerance features.

**Table 5-5. Fault Tolerance Features**

<b>Specification</b>	<b>Feature</b>
Support for SMART	Yes
Optional battery backup for cache memory	Yes. Up to 72 hours data retention.
Drive failure detection	Automatic
Drive rebuild using hot spares	Automatic
Manual replacement of hard drives without system shutdown	Yes
Parity generation and checking	Yes

## Software Utilities

Table 5-6 lists the software utilities.

**Table 5-6. Software Utilities**

Specification	Feature
Graphical user interface (GUI)	Yes
Management utility	Yes
Bootup configuration using BIOS Configuration Utility (Ctrl-M)	Yes
Online read, write, and cache policy switching	Yes
Intranet support	Yes

## Operating System Software Drivers

PERC 3/DC and PERC 3/DCL include a Disk Operating System (DOS) software configuration utility and drivers for Microsoft® Windows NT® V4.0, Windows® 2000, Novell® NetWare® 5.x, 6.x, and Red Hat Linux 7.x.

## PERC 3/DC and PERC 3/DCL Specifications

Table 5-7 lists the PERC 3/DC and PERC 3/DCL specifications.

**Table 5-7. PERC 3/DC and PERC 3/DCL Specifications**

Parameter	Specification
Card size	Half-length PCI card size (6.875" X 4.2").
Processor	Intel i960RN™ 64-bit RISC processor @ 100 MHz
Bus type	PCI 2.2
PCI controller	Intel i960RN
Bus data transfer rate	Up to 533 MB/s at 64/66 MHz
Basic input/output system (BIOS)	PERC 3/DC and PERC 3/DCL BIOS

**Table 5-7. PERC 3/DC and PERC 3/DCL Specifications**

<b>Parameter</b>	<b>Specification</b>
Cache configuration	64 MB or 128 MB DIMM
Firmware	1 MB × 8 flash ROM
Nonvolatile random access memory (RAM)	32 KB × 8 for storing RAID configuration
Operating voltage	5 V, 3.3 V
SCSI controller	Two SCSI controllers for 160M and Wide support.
SCSI data transfer rate	Up to 160 MB/s per channel
SCSI bus	LVD or single-ended
SCSI termination	Active
Termination disable	Automatic through cable and device detection
Devices per SCSI channel	Up to 15 wide or seven narrow SCSI devices.
SCSI device types	Synchronous or asynchronous.
RAID levels supported	0, 1, 5, 10, and 50
SCSI connectors	Two 68-pin internal high-density connectors for 16-bit SCSI devices. Two ultra-high density 68-pin external connectors for 160M and Wide SCSI.
Serial port	3-pin RS232C-compatible connector (for manufacturing use only)

### **PCI Bridge/CPU**

Both PERC 3/DC and PERC 3/DCL use the Intel i960RN PCI bridge with an embedded i960RN RISC processor running at 100 MHz. The RN bridge handles data transfers between the primary (host) PCI bus, the secondary PCI bus, cache memory, and the SCSI bus. The DMA controller supports chaining and unaligned data transfers. The embedded i960JN CPU directs all controller functions, including command processing, SCSI bus transfers, RAID processing, drive rebuilding, cache management, and error recovery.

### **Cache Memory**

Either 64 MB or 128 MB of PERC 3/DC and PERC 3/DCL cache memory reside in a memory bank that uses a 64 MB or 128 MB SDRAM DIMM. PERC 3/DC and PERC 3/DCL support write-through or write-back caching, selectable for each logical drive. To improve performance in sequential disk accesses, the PERC 3/DC and PERC 3/DCL controllers use read-ahead caching by default. You can disable read-ahead caching.

### **PERC 3/DC and PERC 3/DCL BIOS**

The BIOS resides on a 1 MB × 8 flash ROM for easy upgrade. The PERC 3/DC and PERC 3/DCL BIOS supports INT 13h calls to boot DOS without special software or device drivers. The PERC 3/DC and PERC 3/DCL BIOS provides an extensive setup utility that can be accessed by pressing <Ctrl> <M> at BIOS initialization. PERC 3/DC and PERC 3/DCL BIOS Configuration utility is described in Chapter 11 "PERC 3 BIOS Configuration Utility."

### **Onboard Speaker**

The PERC 3/DC and PERC 3/DCL controller has an onboard tone generator for audible warnings when system errors occur. Audible warnings can be generated through this speaker. The audible warnings are listed in Chapter 13 "Troubleshooting."

### **Serial Port**

PERC 3/DC and PERC 3/DCL includes a 3-pin RS232C-compatible serial port connector. This is for manufacturing use only.

### **SCSI Bus**

The PERC 3/DC and PERC 3/DCL controller has four Wide 160M SCSI channels that support both LVD and single-ended devices with active termination. Synchronous and asynchronous devices are supported. PERC 3/DC and PERC 3/DCL provides automatic termination disable via cable detection. The SCSI channel supports up to 15 wide or seven non-wide SCSI devices at speeds up to 160 MB/s.



## SCSI Connectors

The PERC 3/DC and PERC 3/DCL adapter has two types of SCSI connectors:

- Two 68-pin high density internal connectors
- Two 68-pin external ultra-high-density connectors

Only one connector *type* can be used for the SCSI channel at any one time.

## SCSI Termination

PERC 3/DC and PERC 3/DCL uses active termination on the SCSI bus conforming to SCSI-2 and SCSI-3 specifications. Termination enable/disable is automatic through cable detection.

## SCSI Firmware

The PERC 3/DC and PERC 3/DCL firmware handles all RAID and SCSI command processing and supports the feature listed in Table 5-8.

**Table 5-8. SCSI Firmware**

<b>Feature</b>	<b>Description</b>
Disconnect/reconnect	Optimizes SCSI bus seek.
Tagged command queuing	Multiple tags to improve random access
Scatter/gather	A single command can transfer data to and from different memory locations.
Multi-threading	Up to 255 simultaneous commands with elevator sorting and concatenation of requests per SCSI channel
Stripe size	Variable for all logical drives: 2 KB, 4 KB, 8 KB, 16 KB, 32 KB, 64 KB, or 128 KB
Rebuild	Multiple rebuilds and consistency checks with user-definable priority

## RAID Management

RAID management is provided by software utilities that manage and configure the RAID system and PERC 3/DC and PERC 3/DCL, create and manage multiple disk arrays, control and monitor multiple RAID servers, provide error statistics logging, and provide online maintenance. The utilities are:

- PERC 3 BIOS Configuration utility (Ctrl-M)
- Dell Manager
- WebBIOS Configuration Utility
- Dell OpenManage™ Array Manager

### PERC 3 BIOS Configuration Utility

You can use the PERC 3 BIOS Configuration Utility to configure and maintain RAID arrays, format disk drives, and manage the RAID system. It is independent of any operating system. See Chapter 11 "PERC 3 BIOS Configuration Utility" for additional information.

### Dell Manager

Dell Manager is a character-based, non-GUI utility that changes policies, and parameters, and monitors RAID systems. Dell Manager runs under Novell NetWare 5.x, 6.x, and Red Hat Linux 7.x. See Chapter 12 "Dell Manager" for additional information.

### WebBIOS Configuration Utility

WebBIOS is used to configure and manage a RAID system using an HTML interface. See the *WebBIOS Configuration Utility Guide* for more information.

### Dell OpenManage Array Manager

Dell OpenManage Array Manager is used to configure and manage a storage system that is connected to a server, while the server is active and continues to handle requests. Array Manager runs under NetWare, Windows NT, and Windows 2000. Refer to Dell documentation on the Dell web site at [support.dell.com](http://support.dell.com) for more information.

# 6

## SECTION 6

# **PERC 3/QC Features**

---

- Hardware Requirements
- Configuration Features
- Hardware Architecture Features
- Array Performance Features
- Fault Tolerance Features
- Software Utilities
- Operating System Software Drivers
- PERC 3/QC Specifications

## Hardware Requirements

PERC 3/QC is a high-performance intelligent peripheral component interconnect (PCI)-to-SCSI host adapter with RAID control capabilities. PERC 3/QC has four SCSI channels that support 160M and Wide SCSI at data transfer rates up to 160 MB/s. Each SCSI channel supports up to 15 Wide devices or up to seven narrow devices.

PERC 3/QC can be installed in a system with a motherboard that has 5 V, 32- or 64-bit PCI expansion slots. The system should have an Intel® Pentium® II or higher central processing unit (CPU), a diskette drive, a color monitor, video graphics adapter (VGA) card, and a keyboard. A mouse is recommended.

## Configuration Features

Table 6-1 lists the PERC 3/QC configuration features.

**Table 6-1. Configuration Features**

Specification	Feature
RAID levels	0, 1, 5, 10, and 50
SCSI channels	4
Maximum number of drives per channel	15
Array interface to host	PCI 2.2
Drive interface	Wide 160M
Cache memory size	128 MB DIMM
Cache function	Write-back, write-through, adaptive read-ahead, non read-ahead, read-ahead
Multiple logical drives/arrays per controller	Up to 40 logical drives per controller
Maximum number of PERC 3/QC controllers per system	Contact your Dell™ representative.
Online capacity expansion	Yes
Dedicated and pool hot spare	Yes
Flashable firmware	Yes

**Table 6-1. Configuration Features (continued)**

Specification	Feature
Hot swap devices supported	Yes
Non-disk devices supported	No
Mixed-capacity hard drives	Yes
Number of 16-bit internal connectors	2

### SMART Technology

The PERC 3/QC self-monitoring analysis and reporting technology (SMART) detects predictable drive failures. SMART monitors the internal performance of all motors, heads, and drive electronics.

 **NOTE:** The PERC 3/QC does not support clustering.

### Configuration on Disk

Configuration on Disk (drive roaming) saves configuration information both in non-volatile random access memory (NVRAM) on PERC 3/QC and on the disk drives attached to PERC 3/QC. If PERC 3/QC is replaced, the new PERC 3/QC controller detects the actual RAID configuration, maintaining the integrity of the data on each drive, even if the drives have changed channel and/or target ID.

 **NOTE:** Configuration on Disk does not work if you change both the adapter, and the SCSI connectors to different connectors on the new adapter. It works only if you make one change at a time.

Drive roaming is supported across channels on the same controller. Drive roaming across channels is **not** supported when cluster mode is enabled. Table 6-2 lists the Configuration on Disk features.

**Table 6-2. Configuration on Disk Features**

Specification	Feature
Support for hard drives with capacities of more than 8 gigabytes (GB)	Yes
Online RAID level migration	Yes
RAID remapping	Yes
No reboot necessary after expansion	Yes (only if virtual sizing is enabled)
More than 200 qtags per array	Yes
Hardware clustering support on the board	Yes

**Table 6-2. Configuration on Disk Features (continued)**

Specification	Feature
User-specified rebuild rate	Yes

## Hardware Architecture Features

Table 6-3 lists the PERC 3/QC hardware architecture features.

**Table 6-3. Hardware Architecture Features**

Specification	Feature
Processor	Intel i960RN 100MHz
SCSI controller(s)	Two QLogic® 12160 dual SCSI controller
Size of flash ROM	1 MB
Amount of NVRAM	32 KB
Hardware exclusive OR (XOR) assistance	Yes
Direct input/output (I/O)	Yes
SCSI bus termination	Active, single-ended or low-voltage differential (LVD)
Double-sided dual in-line memory modules (DIMMs)	Yes
Auxiliary TermPWR source	No
Direct I/O bandwidth	533 MB/s (greater than 200 MB/s sustained)

## Array Performance Features

Table 6-4 lists the array performance features.

**Table 6-4. Array Performance Features**

Specification	Feature
Host data transfer rate	533 MB/s

**Table 6-4. Array Performance Features (continued)**

<b>Specification</b>	<b>Feature</b>
Drive data transfer rate	160 MB/s
Maximum scatter/gathers	26 elements
Maximum size of I/O requests	6.4 MB in 64 KB stripes
Maximum queue tags per drive	As many as the drive can accept.
Stripe sizes	2 KB, 4 KB, 8 KB, 16 KB, 32 KB, 64 KB, or 128 KB
Maximum number of concurrent commands	255
Support for multiple initiations	Yes

## Fault Tolerance Features

The fault tolerance features are listed in Table 6-5.

**Table 6-5. Fault Tolerance Features**

<b>Specification</b>	<b>Feature</b>
Support for SMART	Yes
Optional battery backup for cache memory	Yes. Up to 72 hours data retention.
Drive failure detection	Automatic
Drive rebuild using hot spares	Automatic
Manual replacement of drives without system shutdown	Yes
Parity generation and checking	Yes

## Software Utilities

The software utilities are listed in Table 6-6.

**Table 6-6. Software Utilities**

Specification	Feature
Graphical user interface	Yes
Management utility	Yes
Bootup configuration using PERC BIOS configuration utility (Ctrl-M)	Yes
Online read, write, and cache policy switching	Yes
Intranet support	Yes

## Operating System Software Drivers

PERC 3/QC includes a DOS software configuration utility and drivers for Microsoft® Windows NT® 4.0, Windows® 2000, Novell® NetWare® and Red Hat Linux.

## PERC 3/QC Specifications

The PERC 3/QC specifications are listed in Table 6-7.

**Table 6-7. PERC 3/QC Specifications**

Parameter	Specification
Card size	12.3" x 4.2" (full length PCI)
Processor	Intel i960RN™ 64-bit RISC processor @ 100 MHz
Bus type	PCI 2.2
PCI controller	Intel i960RN
Bus data transfer rate	Up to 533 MB/s at 64/66 MHz
Basic input/output system (BIOS)	PERC 3/QC BIOS
Cache configuration	64 MB or 128 MB DIMM
Firmware	1 MB × 8 flash ROM
Non-volatile random access memory (RAM)	32 KB × 8 for storing RAID configuration



**Table 6-7. PERC 3/QC Specifications (continued)**

<b>Parameter</b>	<b>Specification</b>
Operating voltage	5 V, 3.3 V
SCSI controller	Four SCSI controllers for 160M and Wide support.
SCSI data transfer rate	Up to 160 MB/s per channel
SCSI bus	LVD or single-ended
SCSI termination	Active
Termination disable	Automatic through cable and device detection
Devices per SCSI channel	Up to 15 wide or seven narrow SCSI devices.
SCSI device types	Synchronous or asynchronous.
RAID levels supported	0, 1, 5, 10, and 50
SCSI connectors	Two 68-pin internal high-density connectors for 16-bit SCSI devices. Four ultra-high density 68-pin external connectors for 160M and Wide SCSI.
Serial port	9-pin RS232C-compatible connector (for manufacturing use only)

### **PCI Bridge/CPU**

PERC 3/QC uses the Intel i960RN PCI bridge with an embedded i960RN RISC processor running at 100 MHz. The RN bridge handles data transfers between the primary (host) PCI bus, the secondary PCI bus, cache memory, and the SCSI bus. The DMA controller supports chaining and unaligned data transfers. The embedded i960JN CPU directs all controller functions, including command processing, SCSI bus transfers, RAID processing, drive rebuilding, cache management, and error recovery.

### **Cache Memory**

128 MB of PERC 3/QC cache memory resides in a memory bank that uses a 64 MB or 128 MB SDRAM DIMM. PERC 3/QC supports write-through or write-back caching, selectable for each logical drive. To improve performance in sequential disk accesses, the PERC 3/QC controller uses read-ahead caching by default. You can disable read-ahead caching.

### **PERC 3/QC BIOS**

The BIOS resides on a 1 MB × 8 flash ROM for easy upgrade. The PERC 3/QC BIOS supports INT 13h calls to boot DOS without special software or device drivers. The PERC 3/QC BIOS provides an extensive setup utility that can be accessed by pressing <Ctrl> <M> at BIOS initialization. PERC 3 BIOS Configuration Utility is described in Chapter 11 "Troubleshooting."

### **Onboard Speaker**

The PERC 3/QC controller has an onboard tone generator for audible warnings when system errors occur. Audible warnings can be generated through this speaker. The audible warnings are listed in Chapter 13.

### **Serial Port**

PERC 3/QC includes a 9-pin RS232C-compatible serial port connector. This is for manufacturing use only.

### **SCSI Bus**

PERC 3/QC has four Wide 160M SCSI channels that support both LVD and single-ended devices with active termination. Synchronous and asynchronous devices are supported. PERC 3/QC provides automatic termination disable by using cable detection. The SCSI channel supports up to 15 wide or seven non-wide SCSI devices at speeds up to 160 MB/s.

### **SCSI Connectors**

PERC 3/QC has two types of SCSI connectors:

- Two 68-pin high density internal connectors
- Four 68-pin external ultra-high-density connectors

Only one connector *type* can be used for the SCSI channel at any one time.

### **SCSI Termination**

PERC 3/QC uses active termination on the SCSI bus conforming to SCSI-2 and SCSI-3 specifications. Termination enable/disable is automatic through cable detection.

## SCSI Firmware

The PERC 3/QC firmware handles all RAID and SCSI command processing and supports the features described in Table 6-8.

**Table 6-8. SCSI Firmware**

<b>Feature</b>	<b>Description</b>
Disconnect/reconnect	Optimizes SCSI bus utilization
Tagged command queuing	Multiple tags to improve random access
Scatter/gather	A single command can transfer data to and from different memory locations.
Multi-threading	Up to 255 simultaneous commands with elevator sorting and concatenation of requests per SCSI channel
Stripe size	Variable for all logical drives: 2 KB, 4 KB, 8 KB, 16 KB, 32 KB, 64 KB, or 128 KB.
Rebuild	Multiple rebuilds and consistency checks with user-definable priority

## RAID Management

RAID management is provided by software utilities that manage and configure the RAID system and PERC 3/QC, create and manage multiple disk arrays, control and monitor multiple RAID servers, provide error statistics logging, and provide online maintenance. They include:

- PERC 3/QC BIOS Configuration Utility (Ctrl-M)
- Dell Manager
- WebBIOS Configuration Utility
- Dell™ OpenManage™ Array Manager

### PERC 3 BIOS Configuration Utility

You can use the PERC 3 BIOS Configuration Utility to configure and maintain RAID arrays, format disk drives, and manage the RAID system. It is independent of any operating system. See Chapter 11 "PERC 3 BIOS Configuration Utility" for additional information.

### **Dell Manager**

Dell Manager is a character-based, non-GUI utility that changes policies, and parameters, and monitors RAID systems. Dell Manager runs under Novell NetWare 5.x, 6.x, and Red Hat Linux 7.x. See Chapter 12 "Dell Manager" for additional information.

### **WebBIOS Configuration Utility**

WebBIOS is used to configure and manage a RAID system using an HTML interface. See the *WebBIOS Configuration Utility Guide* for more information.

### **Dell OpenManage™ Array Manager**

Dell OpenManage Array Manager is used to configure and manage a storage system that is connected to a server, while the server is active and continues to handle requests. Array Manager runs under NetWare, Windows NT, and Windows 2000. Refer to Dell documentation on the Dell web site at [support.dell.com](http://support.dell.com) for more information.

SECTION 7

## **Configuring PERC 3**

---

Configuring SCSI Physical Drives

Current Configuration

Logical Drive Configuration

Physical Device Layout

Configuring Arrays

Configuration Strategies

Assigning RAID Levels

Configuring Logical Drives

Optimizing Data Storage

Planning the Array Configuration

Random Array Deletion

## Configuring SCSI Physical Drives

Physical SCSI drives must be organized into logical drives. The arrays and logical drives that you construct must be able to support the RAID level that you select.

Observe the following guidelines when connecting and configuring SCSI devices in a RAID array:

- You can place up to 32 physical disk drives in an array.
- Include all drives that have the same capacity in the same array. If the drives are not the same size, the array uses the size of the smallest drive and the same amount of space on the other drives to construct the arrays.
- Make sure any hot spare has a capacity that is at least as large as the largest drive that may be replaced by the hot spare.
- When replacing a failed drive, make sure that the replacement drive has a capacity that is at least as large as the drive being replaced.

## Current Configuration

Your PERC 3 card has one (SC), two (DC, DCL), or four channels (QC), depending on which card you have. Use Table 7-1 to list the devices that you assign to each SCSI ID for SCSI Channel 0.

**Table 7-1. Current Configuration for SCSI Channel 0**

SCSI ID	Device Description
<b>SCSI Channel 0</b>	
0	
1	
2	
3	
4	
5	
6	

**Table 7-1. Current Configuration for SCSI Channel 0 (continued)**

<b>SCSI ID</b>	<b>Device Description</b>
<b>SCSI Channel 0</b>	
8	
9	
10	
11	
12	
13	
14	
15	

Use Table 7-2 to list the devices that you assign to each SCSI ID for SCSI Channel 1.

**Table 7-2. Current Configuration for SCSI Channel 1**

<b>SCSI ID</b>	<b>Device Description</b>
<b>SCSI Channel 1</b>	
0	
1	
2	
3	
4	
5	
6	
8	
9	
10	
11	
12	

**Table 7-2. Current Configuration for SCSI Channel 1** *(continued)*

<b>SCSI ID</b>	<b>Device Description</b>
<b>SCSI Channel 1</b>	
13	
14	
15	

Use Table 7-3 to list the devices that you assign to each SCSI ID for SCSI Channel 2.

**Table 7-3. Current Configuration for SCSI Channel 2**

<b>SCSI ID</b>	<b>Device Description</b>
<b>SCSI Channel 2</b>	
0	
1	
2	
3	
4	
5	
6	
8	
9	
10	
11	
12	
13	
14	
15	



Use Table 7-4 to list the devices that you assign to each SCSI ID for SCSI Channel 3.

**Table 7-4. Current Configuration for SCSI Channel 3**

SCSI ID	Device Description
<b>SCSI Channel 3</b>	
0	
1	
2	
3	
4	
5	
6	
8	
9	
10	
11	
12	
13	
14	
15	

## Logical Drive Configuration

Use Table 7-5 to list the details for each logical drive that you configure.

**Table 7-5. Logical Drive Configuration**

Logical Drive	RAID	Stripe Size	Logical Drive Size	Cache Policy	Read Policy	Write Policy	# of Physical Drives
LD0							
LD1							

Logical Drive	RAID	Stripe Size	Logical Drive Size	Cache Policy	Read Policy	Write Policy	# of Physical Drives
LD2							
LD3							
LD4							
LD5							
LD6							
LD7							
LD8							
LD9							
LD10							
LD11							
LD12							
LD13							
LD14							
LD15							
LD16							
LD17							
LD18							
LD19							
LD20							
LD21							
LD22							
LD23							
LD24							
LD25							
LD26							
LD27							
LD28							
LD29							
LD30							

Logical Drive	RAID	Stripe Size	Logical Drive Size	Cache Policy	Read Policy	Write Policy	# of Physical Drives
LD31							
LD32							
LD33							
LD34							
LD35							
LD36							
LD37							
LD38							
LD39							

## Physical Device Layout

Use Table 7-6 to list the details for each physical device on the channels.

**Table 7-6. Physical Device Layout**

	Channel 0	Channel 1	Channel 2	Channel 3
Target ID				
Device type				
Logical drive number/ Drive number				
Manufacturer/Model number				
Firmware level				
Target ID				
Device type				
Logical drive number/ Drive number				
Manufacturer/Model number				
Firmware level				
Target ID				

**Table 7-6. Physical Device Layout (continued)**

	<b>Channel 0</b>	<b>Channel 1</b>	<b>Channel 2</b>	<b>Channel 3</b>
Device type				
Logical drive number/ Drive number				
Manufacturer/Model number				
Firmware level				
Target ID				
Device type				
Logical drive number/ Drive number				
Manufacturer/Model number				
Firmware level				
Target ID				
Device type				
Logical drive number/ Drive number				
Manufacturer/Model number				
Firmware level				
Target ID				
Device type				
Logical drive number/ Drive number				
Manufacturer/Model number				
Firmware level				
Target ID				
Device type				
Logical drive number/ Drive number				

**Table 7-6. Physical Device Layout (continued)**

	<b>Channel 0</b>	<b>Channel 1</b>	<b>Channel 2</b>	<b>Channel 3</b>
Manufacturer/Model number				
Firmware level				
Target ID				
Device type				
Logical drive number/ Drive number				
Manufacturer/Model number				
Firmware level				
Target ID				
Device type				
Logical drive number/ Drive number				
Manufacturer/Model number				
Firmware level				
Target ID				
Device type				
Logical drive number/ Drive number				
Manufacturer/Model number				
Firmware level				
Target ID				
Device type				
Logical drive number/ Drive number				
Manufacturer/Model number				
Firmware level				
Target ID				

**Table 7-6. Physical Device Layout (continued)**

	<b>Channel 0</b>	<b>Channel 1</b>	<b>Channel 2</b>	<b>Channel 3</b>
Device type				
Logical drive number/ Drive number				
Manufacturer/Model number				
Firmware level				
Target ID				
Device type				
Logical drive number/ Drive number				
Manufacturer/Model number				
Firmware level				
Target ID				
Device type				
Logical drive number/ Drive number				
Manufacturer/Model number				
Firmware level				

## Configuring Arrays

Connect the physical drives to the RAID controller, configure the disks, then initialize them. PERC 3 supports up to 40 arrays. An array is a group of physical disk drives. An array can consist of one to 32 physical disk drives (256 drives when used with the span feature in a RAID 50 configuration). The number of drives in an array determines the RAID levels that can be supported. The maximum number of drives that can be used is 60, consisting of four channels with 15 drives each. PERC 3 supports up to 40 logical drives per controller.

## **Arranging Arrays**

You must arrange the arrays to provide additional organization for the drive array. You must arrange arrays so that you can create system drives that can function as boot devices.

You can sequentially arrange arrays with an identical number of drives so that the drives in the group are spanned. Spanned drives can be treated as one large drive. Data can be striped across multiple arrays as one logical drive.

You can create spanned drives using the PERC 3 BIOS Configuration Utility.

## **Creating Hot Spares**

Any drive that is present, formatted, and initialized but is not included in an array or logical drive can be designated as a hot spare.

You can designate drives as hot spares using the PERC 3 BIOS Configuration Utility.

## **Creating Logical Drives**

Logical drives are arrays or spanned arrays that are presented to the operating system. You must create one or more logical drives. The logical drive capacity must include all of the disk space in an array. If an array with drives with mixed sizes, the smallest common size is used and larger disk drives are truncated. The logical drive capacity can also be larger than an array by using spanning. PERC 3 supports up to 40 logical drives.

# **Configuration Strategies**

The most important factors in RAID array configuration are:

- Drive capacity
- Drive availability (fault tolerance)
- Drive performance

You cannot configure a logical drive that optimizes all three factors, but it is easy to choose a logical drive configuration that maximizes one factor at the expense of the other two.

## Maximizing Capacity

RAID 0 achieves maximum drive capacity, but does not provide data redundancy. Maximum drive capacity for each RAID level is shown below. original equipment manufacturer (OEM) level firmware that can span up to four logical drives is assumed. Table 7-7 displays the drives required, and capacity for the various RAID levels.

**Table 7-7. Drives and Capacities for Each RAID Level**

RAID Level	Description	Drives Required	Capacity
0	Striping without parity	1 – 32	(Number of disks) X (capacity of smallest disk)
1	Mirroring	2	(Capacity of smallest disk) X (1)
5	Striping with floating parity drive	3 – 32	(Number of disks) X (capacity of smallest disk) - (capacity of 1 disk)
10	RAID 1 and striping	4 – 16 (Must be a multiple of 2)	(Number of disks) X (capacity of smallest disk) / (2)
50	RAID 5 and striping	6 – 256 (Must be a multiple of arrays)	(Number of disks) X (capacity of smallest disk) – (capacity of 1 disk X number of arrays)

## Maximizing Drive Availability

You can maximize the availability of data on the physical disk drive in the logical array by maximizing the level of fault tolerance. The levels of fault tolerance provided by the RAID levels are shown in Table 7-8.

**Table 7-8. Fault Tolerance Features for RAID Levels 0, 1 and 5**

RAID Level	Fault Tolerance Protection
0	No fault tolerance
1	Disk mirroring, which provides 100% data redundancy.



**Table 7-8. Fault Tolerance Features for RAID Levels 0, 1 and 5 (continued)**

<b>RAID Level</b>	<b>Fault Tolerance Protection</b>
5	100% protection through striping and parity. The data is striped and parity data is written across a number of physical disk drives.

### Maximizing Drive Performance

You can configure an array for optimal performance; however, optimal drive configuration for one type of application will probably not be optimal for any other application. A basic guideline of the performance characteristics for RAID drive arrays at each RAID level is shown in Table 7-9.

**Table 7-9. Performance Characteristics for Each RAID Level**

<b>RAID Level</b>	<b>Performance Characteristics</b>
0	Excellent for all types of input/output (I/O) activity, but provides no data security.
1	Provides data redundancy and good performance.
5	Provides data redundancy and good performance in most environments.
10	Provides high data transfers and complete data redundancy.
50	Provides high data transfers and data redundancy.

## Assigning RAID Levels

Only one RAID level can be assigned to each logical drive. The drives required per RAID level shown in Table 7-10.

**Table 7-10. Physical Drives Required for Each RAID Level**

<b>RAID Level</b>	<b>Minimum Number of Physical Drives</b>	<b>Maximum Number of Physical Drives</b>
0	1	32
1	2	2

**Table 7-10. Physical Drives Required for Each RAID Level**

<b>RAID Level</b>	<b>Minimum Number of Physical Drives</b>	<b>Maximum Number of Physical Drives</b>
5	3	32
10	4	16
50	6	256 (PERC has a limit of 60, using PERC 4/QC with 15 drives on each of the 4 channels.)

## Configuring Logical Drives

After you have installed the PERC 3 controller in the server and have attached all physical disk drives, perform the following steps to prepare a RAID disk array:

- 1 Optimize the PERC 3 controller options for your system.
- 2 Press <Ctrl> <M> to run the BIOS Configuration Utility.
- 3 Define and configure one or more logical drives.
- 4 Select **Easy Configuration** in the PERC 3 BIOS Configuration Utility or select **New Configuration** to customize the RAID array.
- 5 Create and configure one or more system drives (logical drives).
- 6 Select the RAID level, cache policy, read policy, and write policy.
- 7 Save the configuration.
- 8 Initialize the system drives.

After initialization, you can install the operating system.

## Optimizing Data Storage

### Data Access Requirements

Each type of data stored in the disk subsystem has a different frequency of read and write activity. If you know the data access requirements, you can more successfully determine a strategy for optimizing the disk subsystem capacity, availability, and performance.

Servers that support Video on Demand typically read the data often, but write data infrequently. Both the read and write operations tend to be long. Data stored on a general-purpose file server involves relatively short read and write operations with relatively small files.

### Array Functions

You must first define the major purpose of the disk array. Will this disk array increase the system storage capacity for general-purpose file and print servers? Does this disk array support any software system that must be available 24 hours per day? Will the information stored in this disk array contains large audio or video files that must be available on demand? Will this disk array contain data from an imaging system?

You must identify the purpose of the data to be stored in the disk subsystem before you can confidently choose a RAID level and a RAID configuration.

## Planning the Array Configuration

Complete the items in Table 7-11 to help you plan the array configuration.

**Table 7-11. Factors to Consider for Array Configuration**

Question	Answer
Number of physical disk drives in the array	
Purpose of this array. Rank the following factors:	
Maximize drive capacity	
Maximize the safety of the data (fault tolerance)	
Maximize hard drive performance and throughput	
How many hot spares?	
Amount of cache memory installed on PERC 3	
Are all of the disk drives and the server protected by a UPS?	

## Using the Array Configuration Planner

Table 7-12 lists RAID levels, fault tolerance, and effective capacity for some possible drive configurations for an array consisting of one to 32 drives. This table does not take into account any hot spare (standby) drives. You should always have a hot spare drive in case of drive failure. RAID 1 requires two drives. RAID 5 requires at least three drives. RAID 10 requires at least four drives. RAID 50 requires at least six drives.

**Table 7-12. Array Configuration Planner**

Number of Drives	Possible RAID Levels	Relative Performance	Fault Tolerance	Effective Capacity
1	RAID 0	Excellent	No	100%
2	RAID 0	Excellent	No	100%
2	RAID 1	Good	Yes	50%
3	RAID 0	Excellent	No	100%
3	RAID 5	Good	Yes	67%
4	RAID 0	Excellent	No	100%
4	RAID 5	Good	Yes	75%
4	RAID 10	Good	Yes	50%
5	RAID 0	Excellent	No	100%
5	RAID 5	Good	Yes	80%
6	RAID 0	Excellent	No	100%
6	RAID 5	Good	Yes	83%
6	RAID 10 (spanned)	Excellent	Yes	50%
6	RAID 50 (spanned)	Good	Yes	67%
7	RAID 0	Excellent	No	100%
7	RAID 5	Good	Yes	86%
8	RAID 0	Excellent	No	100%
8	RAID 5	Good	Yes	87%
8	RAID 10 (spanned)	Excellent	Yes	50%

**Table 7-12. Array Configuration Planner (continued)**

<b>Number of Drives</b>	<b>Possible RAID Levels</b>	<b>Relative Performance</b>	<b>Fault Tolerance</b>	<b>Effective Capacity</b>
8	RAID 50 (spanned)	Good	Yes	75%
16	RAID 10 (spanned)	Excellent	Yes	50%
16	RAID 50 (spanned)	Good	Yes	88%
32	RAID 0	Excellent	No	100%
32	RAID 10	Good	Yes	50%
32	RAID 50	Good	Yes	94%

## Random Array Deletion

The PERC controllers support random array deletion, which is the ability to delete any unwanted logical drives and use that space for a new logical drive.

This section describes the impact of random array deletion from the user perspective. It discusses the configuration module architecture modification, and the data structure.

### Overview

On a running operating system, you can not delete a physical drive entry in the drive object repository. Additions and deletions can be done only at the end of the repository. The operating system driver receives this support from the firmware and maintains the same object repository table for that session of the operating system.

 **NOTE:** Refer to Chapter 11 and Chapter 12 for the procedures for random array deletion.

 **NOTE:** When a 'delete' request reaches the operating system driver, the driver stops all the running input/output (I/O) for other logical drives and processes the delete request first. Normal read/write operation starts after the delete request is completed.

 **NOTE:** Drive size expansion is not possible, even though you can use non-contiguous free space to create a new logical drive.

 **NOTE:** You cannot move an existing logical drive to another area to protect it from defragmentation caused by random deletion.

After you delete a logical drive, you can create a new one. You can use the configuration utilities to create the next logical drive from the non-contiguous free space ('holes'), and from the newly created arrays. The configuration utility provides a list of configurable arrays where there is a space to configure.

 **NOTICE:** The deletion of the logical drive can fail under certain conditions. You cannot delete a logical drive during a reconstruction. Deletion can fail during a rebuild, initialization or check consistency of a logical drive, if that drive has a higher logical drive number than the drive you want to delete.

## Configuration Module

The main benefit of random array deletion on the configuration module is that you are not restricted to sequential or contiguous logical drives when you create logical drives. You can use non-contiguous segments to create logical drives.

The random deletion of logical drives creates non-contiguous segments in the configuration, which prevents the sequential creation of the next logical drive. You can create logical drives from these non-contiguous segments. To create such a logical drive, you can span these segments, as long as they have the same number of physical drives.

You can still create sequential logical drives, without using the non-contiguous segments. The utilities provide information about sequential segments, non-contiguous segments and physical drives that have not been configured. You can use this information when you create logical drives.

SECTION 8

## **PERC 3/SC Hardware Installation**

---

[Requirements](#)

[PERC 3/SC Card Layout](#)

[Installation Steps](#)

## Requirements

This chapter describes the installation procedures for the PERC 3/SC board. You must have the following:

- A PERC 3/SC controller
- A host computer with an available 5 V, 32- or 64-bit PCI expansion slot
- The PERC 3 installation diskettes
- The necessary SCSI cables (This depends on the number and type of SCSI devices to be attached.)
- Fast, Ultra, Ultra II, and 160M SCSI hard drives

Dell™ strongly recommends that you have an uninterruptible power supply (UPS) for the entire system.

### Optional Equipment

You may also want to install SCSI cables that connect the PERC 3/SC to external SCSI devices.



# PERC 3/SC Card Layout

Figure 8-1 shows the PERC 3/SC card, jumpers, and connectors.

Figure 8-1. PERC 3/SC Card Layout

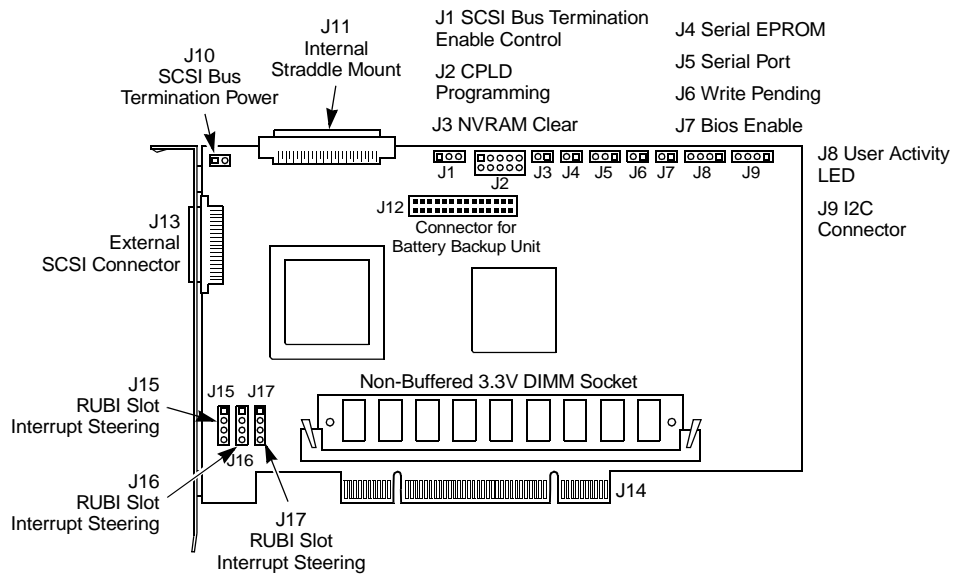

## Installation Steps

This section provides an overview of installing the RAID controller. See the following sections for more information about each step.

- 1 Unpack the PERC 3/SC controller and inspect for damage.

Make sure all items are in the package. If damaged, call your Dell™ original equipment manufacturer (OEM) support representative.

- 2 Turn the computer off and remove the cover.
- 3 Check the jumper settings on the PERC 3/SC controller.
- 4 Set SCSI termination.
- 5 Install the PERC 3/SC card.

- 6 Connect the SCSI cables to SCSI devices.

Make sure all cables are properly attached, and that the PERC 3/SC card is properly installed.

- 7 Set the target IDs for the SCSI devices.

- 8 Replace the computer cover and turn the power on.

Be sure the SCSI devices are powered up before or at the same time as the host computer.

- 9 Run the PERC 3 BIOS Configuration Utility or WebBIOS Configuration Utility to configure arrays and logical drives.

- 10 Install software drivers for the desired operating systems.

### **Step 1—Unpack**

Unpack and install the hardware in a static-free environment. The PERC 3 is packed inside an anti-static bag between two sponge sheets. Remove the controller card and inspect it for damage. If the card appears damaged, or if any item listed below is missing, contact your Dell support representative. The PERC 3 controller also comes with:

- The *PERC 3 User's Guide*
- A license agreement
- The PERC 3 configuration utilities diskette

### **Step 2—Power Down**

Turn off the computer and remove the cover. Make sure the computer is disconnected from any networks before you install the controller card.

### Step 3—Set Jumpers

Make sure the jumper settings on the PERC 3/SC card are correct. The jumpers and connectors are shown in Table 8-1.

**Table 8-1. PERC 3/SC Jumpers**

Connector	Description	Type
J1	SCSI bus termination enable control	3-pin header
J2	CPLD programming	10-pin header
J3	Non-volatile random access memory (NVRAM) clear	2-pin header
J4	Serial erasable programmable read-only memory (EPROM)	2-pin header
J5	Serial port	3-pin header
J6	Write pending	2-pin header
J7	BIOS enable	2-pin header
J8	User activity light-emitting diode (LED)	4-pin connector
J9	I2C connector	4-pin header
J10	SCSI bus termination power	2-pin header
J11	Internal straddle-mount connector	68-pin connector
J13	External SCSI connector	68-pin connector
J15	RUBI slot interrupt steering	3-pin header
J16	RUBI slot interrupt steering	3-pin header
J17	RUBI slot interrupt steering	3-pin header

#### J1 Termination Enable

J1 is a three-pin header that specifies hardware or software control of SCSI termination. The default is OPEN. The settings are shown in Table 8-2.

**Table 8-2. J1 Termination Enable Settings**

Type of SCSI Termination	J10 Setting
Software control of SCSI termination using drive detection.	Short pins 1-2

**Table 8-2. J1 Termination Enable Settings (continued)**

Type of SCSI Termination	J10 Setting
Permanently disable all onboard SCSI termination.	Short pins 2-3
Permanently enable all onboard SCSI termination.	OPEN (default)

**J9 I2C Interface Connector**

J9 is a four-pin header that allows the i960RM core processor to serve as a master and slave device that resided on the I2C bus when used with the I2C bus interface unit. Attach a four-wire cable from J9 to the I2C Bus Interface Unit. Table 8-3 shows the J9 connector pinout.

**Table 8-3. J9 I2C Interface Connector Pinout**

Pin	Description
1	SDA
2	GND
3	SCL
4	VCC

**J5 Serial Port**

J5 is a 3-pin connector that attaches to a serial cable. Table 8-4 displays the pinout for J5.

**Table 8-4. J5 Serial Port Pinout**

Pin	Description
1	RXD
2	TXD
3	GND

### J8 Hard Disk LED

J8 is a four-pin connector that attaches to a cable that connects to the hard disk light emitting diode (LED) mounted on the computer enclosure. The LED indicates data transfers. Table 8-5 shows the pinout for J8.

**Table 8-5. J8 Hard Disk LED**

Pin	Description
1	VCC through pull-up
2	SCSI activity signal
3	SCSI activity signal
4	VCC through pull-up

### J10 Term Power

J10 is a 2-pin jumper. The factory setting is pins 1-2 shorted. Pins 1-2 should always be shorted for J10 to enable onboard term power.

### J15 RUBI Slot Interrupt Steering

J15 is a 3-pin jumper. You can short the pins for a standard PCI slot or a PCI RUBI slot. The default is to have the jumper installed to short pins 1 and 2. Table 8-6 shows the pinout for J15.

**Table 8-6. J15 RUBI Slot Interrupt Steering**

Short...	For...
Pins 1-2	Standard PCI slot (default)
Pins 2-3	PCI RUBI slot

### J16, J17 RUBI Slot Interrupt Steering

J16 and J17 are 3-pin jumpers. You can short them for a one-channel or two-channel motherboard. The default is OPEN; the pins are not shorted. Table 8-7 shows the settings for shorting J16 and J17.

**Table 8-7. J16, J17 RUBI Slot Interrupt Steering**

Short...	For...
Pins 1-2 on both jumpers	2-channel motherboard RAID
Pins 2-3 on both jumpers	1-channel motherboard

### Step 4—Set SCSI Termination

The SCSI bus is an electrical transmission line and must be terminated properly to minimize reflections and losses. Termination should be set at each end of the SCSI cable(s), as shown in the following illustration:

**Figure 8-2. Example of SCSI Termination**

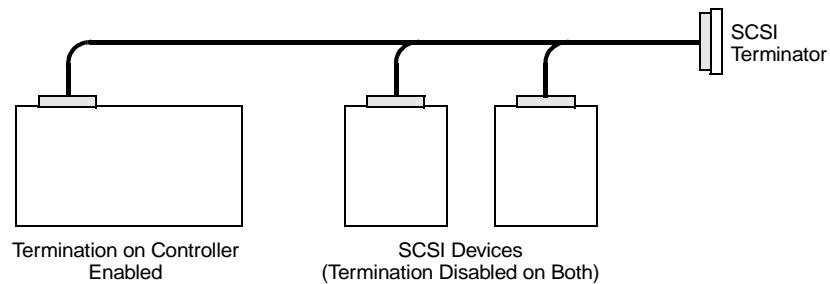

For a disk array, set SCSI bus termination so that removing or adding a SCSI device does not disturb termination. An easy way to do this is to connect the PERC 3/SC card to one end of the SCSI cable and to connect an external terminator module at the other end of the cable. The connectors between the two ends can connect SCSI devices. Disable termination on the SCSI devices. See the manual for each SCSI device to disable termination.

### **SCSI Termination**

The SCSI bus is an electrical transmission line and it must be terminated properly to minimize reflections and losses. You complete the SCSI bus by setting termination at both ends.

You can let PERC 3/SC automatically provide SCSI termination at one end of the SCSI bus. You can terminate the other end of the SCSI bus by attaching an external SCSI terminator module to the end of the cable or by attaching a SCSI device that internally terminates the SCSI bus at the end of the SCSI channel.

### **Selecting a Terminator**

Use standard external SCSI terminators on a SCSI channel operating at 10 MB/s or higher synchronous data transfer.

### **Terminating Internal SCSI Disk Arrays**

Set the termination so that SCSI termination and termination power are intact when any physical drive is removed from a SCSI channel, as shown in Figure 8-3.

Figure 8-3. Termination of Internal SCSI Disk Arrays

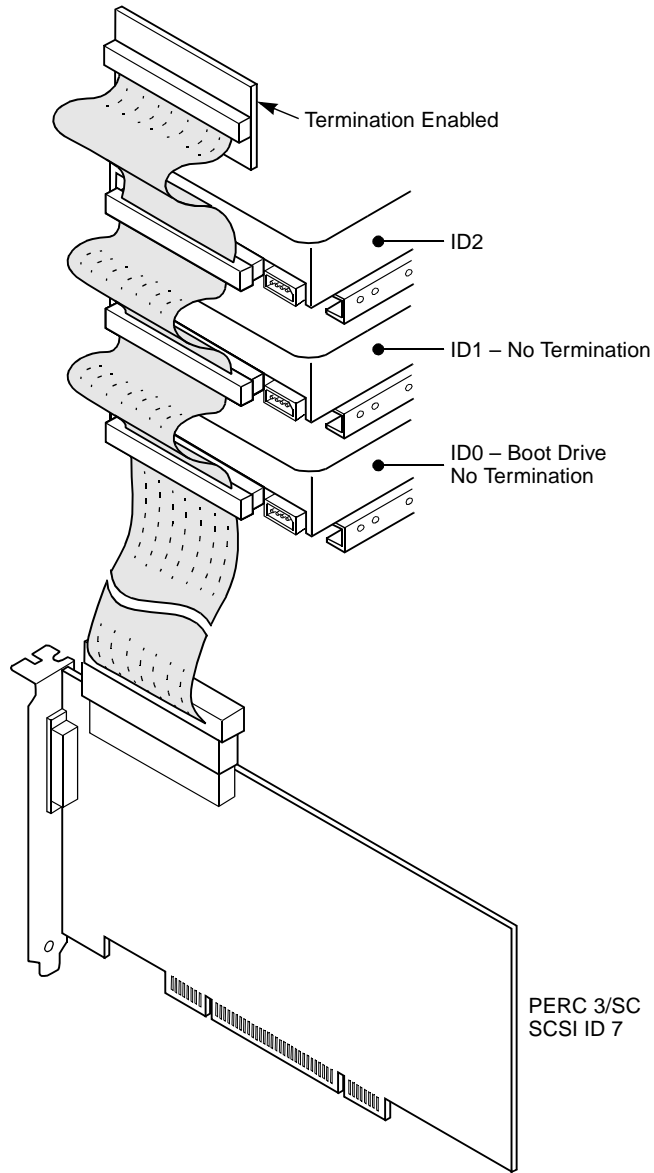



### Step 5—Install PERC 3/SC

Choose a 3.3 V or 5 V PCI slot and align the PERC 3/SC card bus connector to the slot. Press down gently but firmly to make sure that the card is properly seated in the slot. The bottom edge of the controller card should be flush with the slot. Figure 8-4 shows PCI slots on a motherboard.

Figure 8-4. PCI Slots on Motherboard

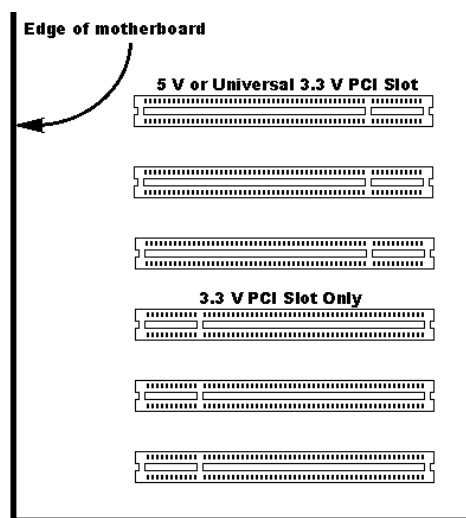

Insert the PERC 3/SC card in a PCI slot, as shown in Figure 8-5. Screw the bracket to the computer chassis.

**Figure 8-5. Installation of PERC 3/SC Card into Motherboard**

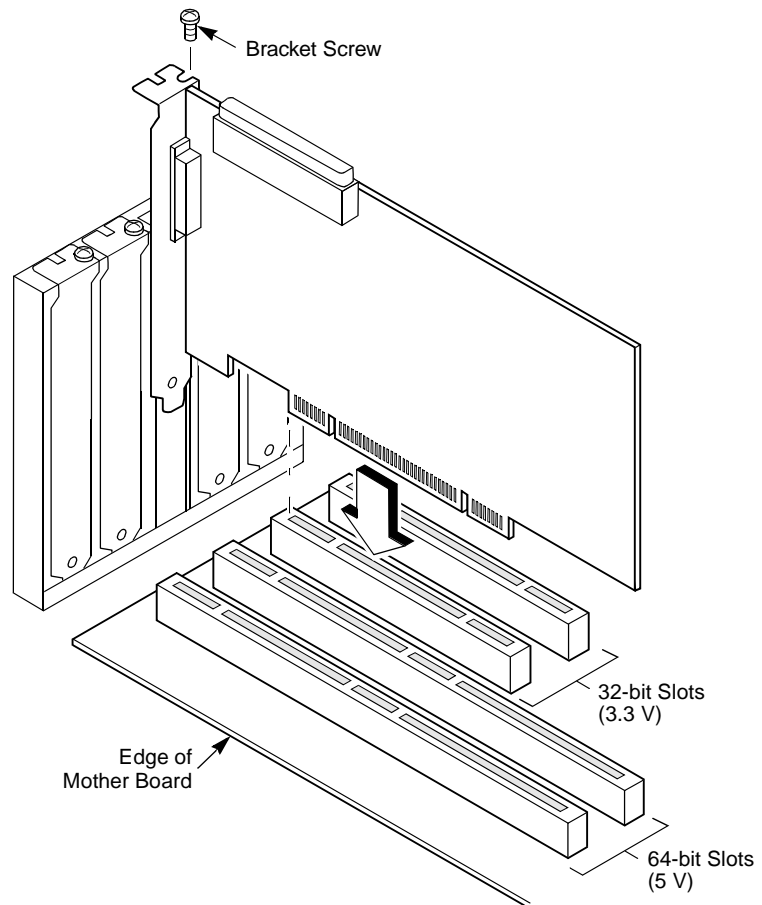

## Step 6—Connect SCSI Cables

Connect the SCSI cables to SCSI devices, as shown in Figure 8-6. PERC 3/SC provides two SCSI connectors:

- J11, the SCSI channel internal high-density 68-pin connector for Wide (16-bit) SCSI
- J13, the SCSI channel external ultra high-density 68-pin connector for Wide (16-bit) SCSI

Make sure all cables are properly attached, and that the PERC 3/SC card is properly installed.

**Figure 8-6. Connecting SCSI Cables**

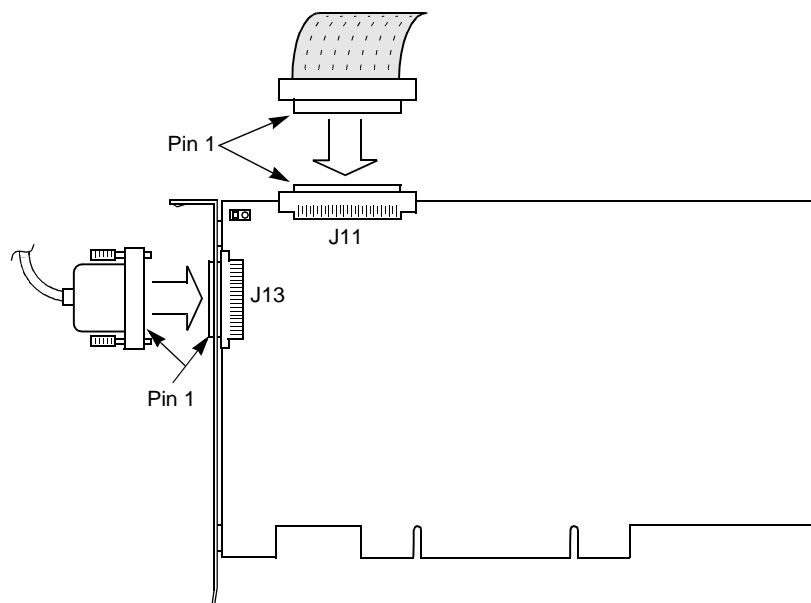

### Connect SCSI Devices

The cable length should not exceed 3 meters for Fast SCSI (10 MB/s) devices or single ended 1.5 meters for Ultra SCSI devices. The cable length can be up to 12 meters for low voltage differential (LVD) devices.

The cable length should not exceed six meters for non-Fast SCSI devices.

Perform the following steps to connect SCSI devices:

- 1 Disable termination on any SCSI device that does *not* sit at the end of the SCSI bus.
- 2 Configure all SCSI devices to supply termination power (TermPWR.)
- 3 Set proper target IDs (TIDs) for all SCSI devices.

### Cable Suggestions

System throughput problems can occur if SCSI cable use is not maximized. You should:

- Use cables up to 12 meters for LVD devices.
- For single-ended SCSI devices, use the shortest SCSI cables (no more than 3 meters for Fast SCSI, no more than 1.5 meters for an 8-drive Ultra SCSI system, and no more than 3 meters for a 6-drive Ultra SCSI system.)
- Use active termination.
- Avoid clustering the cable nodes.
- Note that cable stub length should be no more than 0.1 meter (4 inches.)
- Route SCSI cables carefully.
- Use high impedance cables.
- Do not mix cable types. (Choose either flat or rounded and shielded or non-shielded.)
- Note that ribbon cables have fairly good cross-talk rejection characteristics.

### Step 7—Set Target IDs

Set target identifiers (TIDs) on the SCSI devices. Each device in a specific SCSI channel must have a unique TID in that channel. Non-disk devices (CD or tapes) should have unique SCSI IDs *regardless of the channel where they are connected*. See the documentation for each SCSI device to set the TIDs.

The PERC 3/SC controller automatically occupies TID 7 in the SCSI channel. Eight-bit SCSI devices can use the TIDs from 0 to 6 only. 16-bit devices can use the TIDs from 0 to 15. The arbitration priority for a SCSI device depends on its TID. Table 8-8 shows the target IDs.

**Table 8-8. Target IDs**

Priority	Highest						Lowest					
TID	7	6	5	...	2	1	0	15	14	...	9	8

**NOTICE:** Non-disk devices (CD-ROM or tapes) should have unique SCSI IDs regardless of the channel they are connected to. ID 0 cannot be used for non-disk devices because they are limited to IDs 1 through 6. There is a limit of six IDs for non-disk devices per controller.

### Step 8—Power On Host System

Replace the computer cover and reconnect the alternating current (AC) power cords. Turn power on to the host computer. Set up the power supplies so that the SCSI devices are powered up at the same time as or before the host computer. If the computer is powered up before a SCSI device, the device might not be recognized.

During boot, the PERC 3 BIOS message appears:

```
PowerEdge Expandable RAID Controller BIOS Version x.xx
date

Copyright (c) Dell Computer Corporation

Firmware Initializing... [Scanning SCSI Device...(etc)...]
```

The firmware takes several seconds to initialize. During this time the adapter scans the SCSI channel. When ready, the following appears:

```
HA -0 (Bus 1 Dev 6) Type: PERC 3/SC Standard FW x.xx SDRAM=
xxxMB

0 Logical Drives found on the Host Adapter

0 Logical Drive(s) handled by BIOS

Press <Ctrl><M> to run PERC 3 BIOS Configuration Utility
Or press <Ctrl><H> to run WebBIOS
```

The PERC 3 BIOS Configuration Utility prompt times out after several seconds. The PERC 3 host adapter (controller) number, firmware version, and cache synchronized dynamic random access memory (SDRAM) size display in the second portion of the BIOS message. The numbering of the controllers follows the PCI slot scanning order used by the host motherboard.

### **Step 9—Run PERC 3 BIOS Configuration Utility or WebBIOS Utility**

Press <Ctrl><M> to run the PERC 3 BIOS Configuration Utility or <Ctrl><H> to run the WebBIOS Configuration Utility. See Chapter 11 "PERC 3 BIOS Configuration Utility" for additional information about running the BIOS Configuration Utility. WebBIOS is an HTML-based utility. See the *WebBIOS Configuration Utility Guide* for additional information about running the WebBIOS Configuration Utility.

### **Step 10—Install Operating System Software Drivers**

See the *PERC 3 Operating System Driver Installation Guide* for additional information about installing the drivers for Windows NT®, Windows® 2000, Novell® NetWare® 5.x, 6.x, and Red Hat Linux 7.x.

SECTION 9

## **PERC 3/DC or PERC 3/DCL Hardware Installation**

---

Requirements

PERC 3/DC Card Layout

PERC 3/DCL Card Layout

Installation Steps

Replacing a PERC 3/DC Containing a BC Chip with a  
PERC 3/DC Containing a BE Chip

 **NOTE:** The PERC 3/DC or PERC 3/DCL controller must be installed in a PCI expansion slot.

 **NOTE:** The PERC 3/DC has a battery option; the PERC 3/DCL does not.

## Requirements

This chapter describes the installation procedures for the PERC 3/DC, and PERC 3/DCL boards. It also contains the procedure for replacing the PERC 3/DC that has a BC chip with a PERC 3/DC that has a BE chip. You must have the following:

- A PERC 3/DC or PERC 3/DCL controller
- A host computer with an available 32- or 64-bit, 5 V peripheral component interconnect (PCI) expansion slot
- The PERC 3/DC or PERC 3/DCL installation diskettes
- The necessary SCSI cables (This depends on the number and type of SCSI devices to be attached.)
- Low-voltage differential (LVD) or 160M SCSI hard drives

Dell™ strongly recommends that you have an uninterruptible power supply (UPS) for the entire system.

### Optional Equipment

You may also want to install SCSI cables that connect PERC 3/DC or PERC 3/DCL to external SCSI devices.



# PERC 3/DC Card Layout

Figure 9-1. PERC 3/DC Card Layout

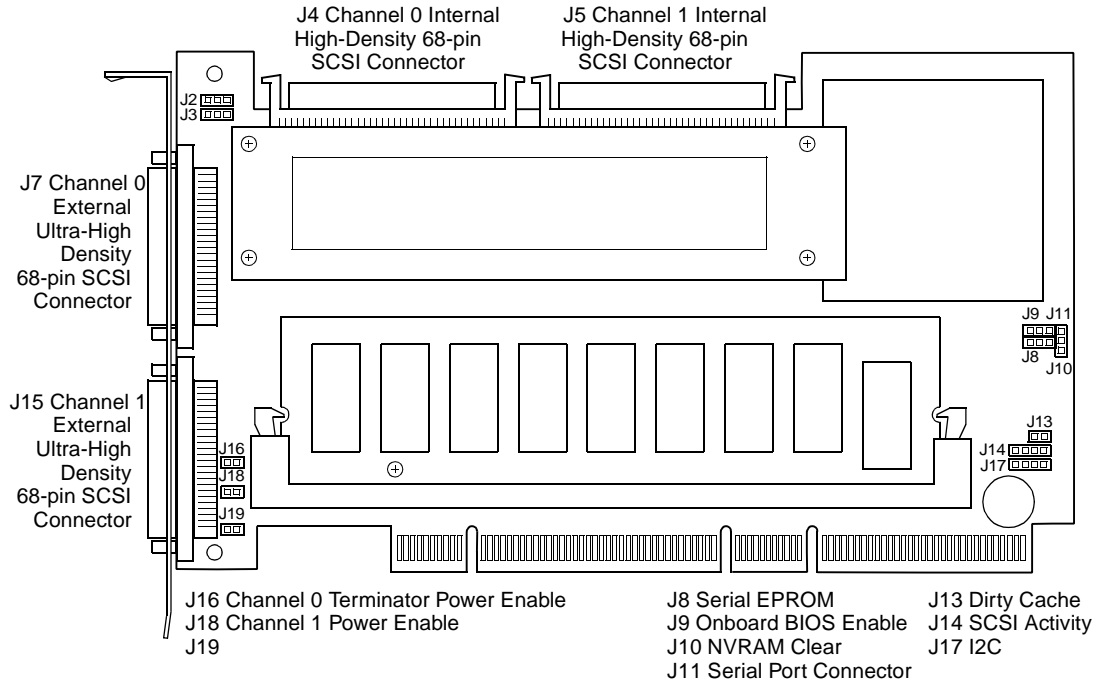

# PERC 3/DCL Card Layout

Figure 9-2. PERC 3/DCL Card Layout

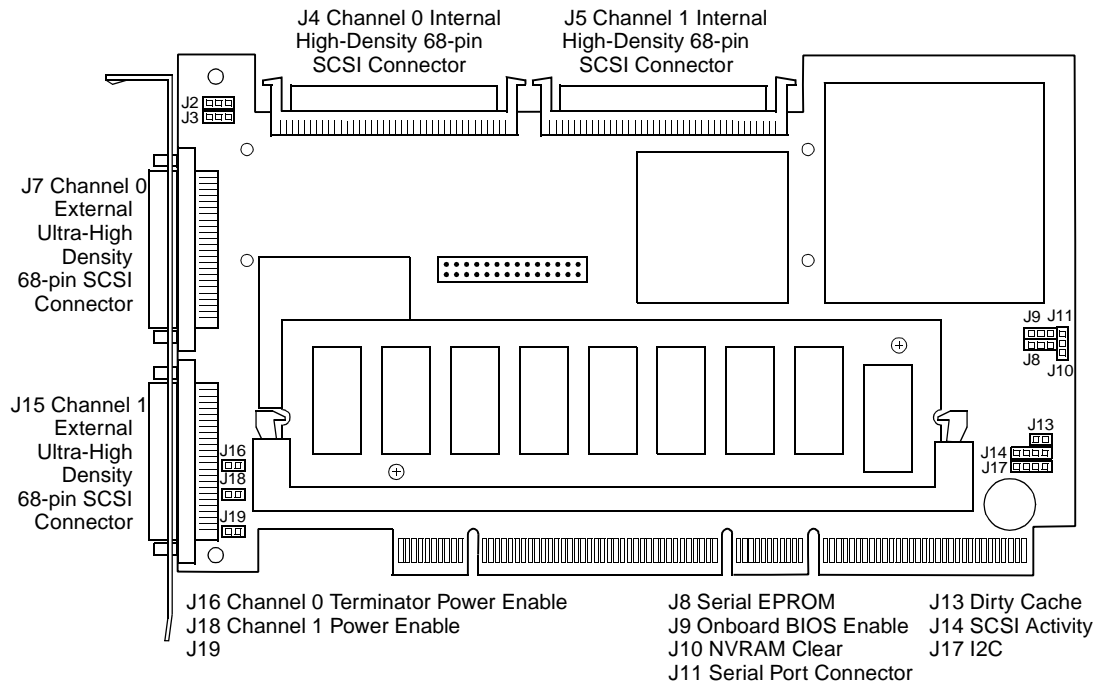

## Installation Steps

The steps for installing the RAID controller are shown below. See the following pages for more information about each step.

1. Unpack the PERC 3/DC or PERC 3/DCL.
2. Power off the host system.
3. Set jumpers.
4. Set SCSI termination.
5. Install the PERC 3/DC or PERC 3/DCL controller.
6. Select and set target IDs for SCSI devices.

- 7 Connect SCSI devices.
- 8 Power on the host system.
- 9 Run the BIOS Configuration Utility or the WebBIOS Configuration Utility.
- 10 Install the operating system software driver.

### Step 1—Unpack the PERC 3/DC or PERC 3/DCL

Unpack and install the hardware in a static-free environment. Remove the controller card and inspect it for damage. If the card appears damaged, please contact your Dell support representative.

### Step 2—Power Down

Turn off the computer and remove the AC power cord. Ensure that the computer is disconnected from any networks before installing the controller. Remove the system cover. For information regarding removal of system covers, please consult the system documentation.

### Step 3—Set Jumpers

Make sure the jumper settings on the PERC 3/DC or PERC 3/DCL card are correct. The jumpers and connectors are shown in Table 9-1.

**Table 9-1. Jumper Settings**

Connector	Description	Type
J2	Channel 1 termination enable	3-pin header
J3	Channel 0 termination enable	3-pin header
J4	Channel 0 internal Wide SCSI	68-pin connector
J5	Channel 1 internal Wide SCSI	68-pin connector
J7	Channel 0 external Wide SCSI	68-pin connector
J8	Serial erasable programmable read-only memory (EEPROM) port	2-pin header
J9	Onboard BIOS enable	2-pin header
J10	Non-volatile random access memory (NVRAM) clear	2-pin connector
J11	Serial port connector	3-pin header

**Table 9-1. Jumper Settings (continued)**

Connector	Description	Type
J13	Dirty cache (Write Pending) LED	2-pin header
J14	SCSI activity LED	4-pin header
J15	Channel 1 external Wide SCSI	68-pin connector
J16	Channel 0 TERMPWR enable	2-pin header
J17	I2C connector	4-pin header
J18	Channel 1 TERMPWR enable	2-pin header

**J2, and J3 Termination Enable**

J2, and J3 are 3-pin connectors that set the SCSI termination for each SCSI channel. The default is OPEN. Table 9-2 displays the termination enable settings.

**Table 9-2. J2 and J3 Termination Enable Settings**

Jumper	SCSI Channel	SCSI Termination Controlled by Software	SCSI Termination Always Disabled	SCSI Termination Always Enabled
J2	0	Short pins 1-2	Short pins 2-3	OPEN (default)
J3	1	Short pins 1-2	Short pins 2-3	OPEN (default)

**J9 Onboard BIOS Enable**

J9 is a 2-pin connector that enables or disables the PERC 3/DC or PERC 3/DCL onboard BIOS. The onboard BIOS should be enabled (J9 unjumpered) for normal board operation. Unjumpered is the default. Table 9-3 displays the settings for J9.

**Table 9-3. J9 Onboard BIOS Enable Settings**

J9 Setting	Onboard BIOS Status
Unjumpered	Enabled (default)
Jumpered	Disabled

### J10 NVRAM Clear

J10 is a 2-pin connector used to clear the memory from the NVRAM, which stores RAID configuration information. Table 9-4 displays the pinout for J10.

**Table 9-4. J10 NVRAM Clear Pinout**

Pin	Description
1	Signal
2	GND

### J11 Serial Port

J11 is a 3-pin header that attaches to a serial cable. Table 9-5 and Figure 9-3 display the pinout.

**Table 9-5. J11 Serial Port Pinout**

Pin	Description
1	Receive data
2	Transmit data
3	Ground

**Figure 9-3. J11 Serial Port Pinout**

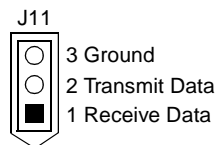

### J13 Dirty Cache LED

J13 is a two-pin connector for an LED mounted on the computer enclosure. The LED indicates when the data in the cache has yet to be written to the storage devices. Table 9-6 displays the J13 pinout.

**Table 9-6. J13 Dirty Cache LED Pinout**

Pin	Description
1	Signal pulled high
2	Dirty cache signal

**J14 SCSI Activity LED**

J14 is a four-pin connector for an LED mounted on the computer enclosure. Table 9-7 displays the J14 pinout.

**Table 9-7. J14 SCSI Activity Pinout**

Pin	Description
1	VCC
2	SCSI activity signal
3	SCSI activity signal
4	VCC

**J16 and J18 TERMPWR Enable**

J16, and J18 are 2-pin connectors that enable termination power to the SCSI bus for each SCSI channel. The default is pins 1 and 2 jumpered. Table 9-8 displays the settings for J16 and J18.

**Table 9-8. J16 and J18 TERMPWR Enable Settings**

Jumper	Termination Power Channel	Settings
J16	0	Short pins 1-2 to have the PCI bus on the host computer provide TermPWR. This is the default setting. Leave open to let the SCSI bus provide TermPWR.
J18	1	Short pins 1-2 to have the PCI bus on the host computer provide TermPWR. This is the default setting. Leave open to let the SCSI bus provide TermPWR.

### **J17 I2C Connector**

J17 is a 4-pin header. Table 9-9 displays the J17 pinout.

**Table 9-9. J17 I2C Connector Pinout**

<b>Pin</b>	<b>Description</b>
1	Data
2	GND
3	Clock
4	Power (fused)

### **Step 4—Set SCSI Termination**

Each PERC 3/DC or PERC 3/DCL SCSI channel can be individually configured for termination enable mode by setting the J2 and J3 jumpers. You must terminate the SCSI bus properly. Set termination at both ends of the SCSI cable. The SCSI bus is an electrical transmission line and must be terminated properly to minimize reflections and losses. Termination should be set at each end of the SCSI bus, as shown in the figures.

#### **Terminating Internal SCSI Disk Arrays**

Set the termination so that SCSI termination and termination power are intact when any disk drive is removed from a SCSI channel, as shown in Figure 9-4.

**Figure 9-4. Termination of Internal SCSI Disk Arrays for PERC 3/DC and 3/DCL**

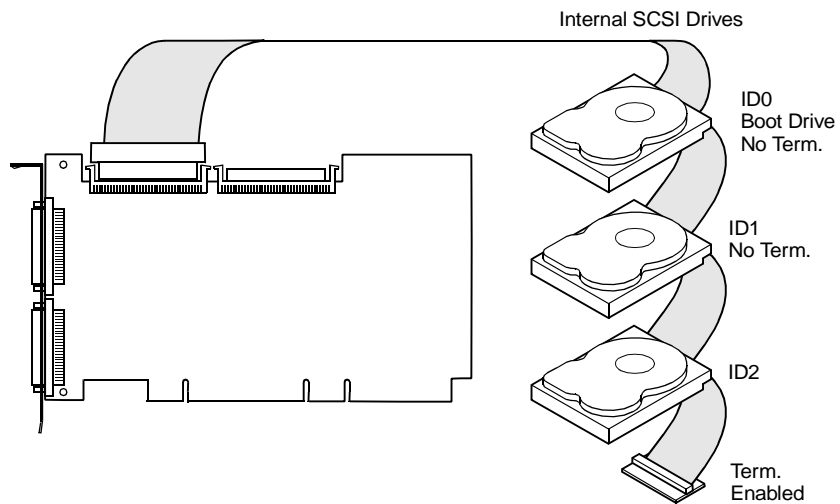

For a disk array, set SCSI bus termination so that removing or adding a SCSI device does not disturb termination. The connectors between the two ends of the channel can connect SCSI devices that have termination enabled. See the manual for each SCSI device to disable termination.

The PERC 3/DC or PERC 3/DCL can provide SCSI termination automatically at one end of the SCSI bus. The other end of the SCSI bus can be terminated by attaching an external SCSI bus terminator module to the end of the cable, or by attaching a SCSI device that internally terminates the SCSI bus at the end of the SCSI channel.

### **Step 5—Install the PERC 3/DC or PERC 3/DCL Controller**

Choose a 3.3 V or 5 V PCI slot and align the PERC 3/DC or PERC 3/DCL bus connector to the slot. Press down gently but firmly to make sure that the card is properly seated in the slot. The bottom edge of the controller card should be flush with the slot.

Insert the PERC 3/DC or PERC 3/DCL card into a 64-bit PCI slot, as shown in Figure 9-5. Screw the bracket to the computer frame.



Figure 9-5. Installation of the PERC 3/DC and 3/DCL

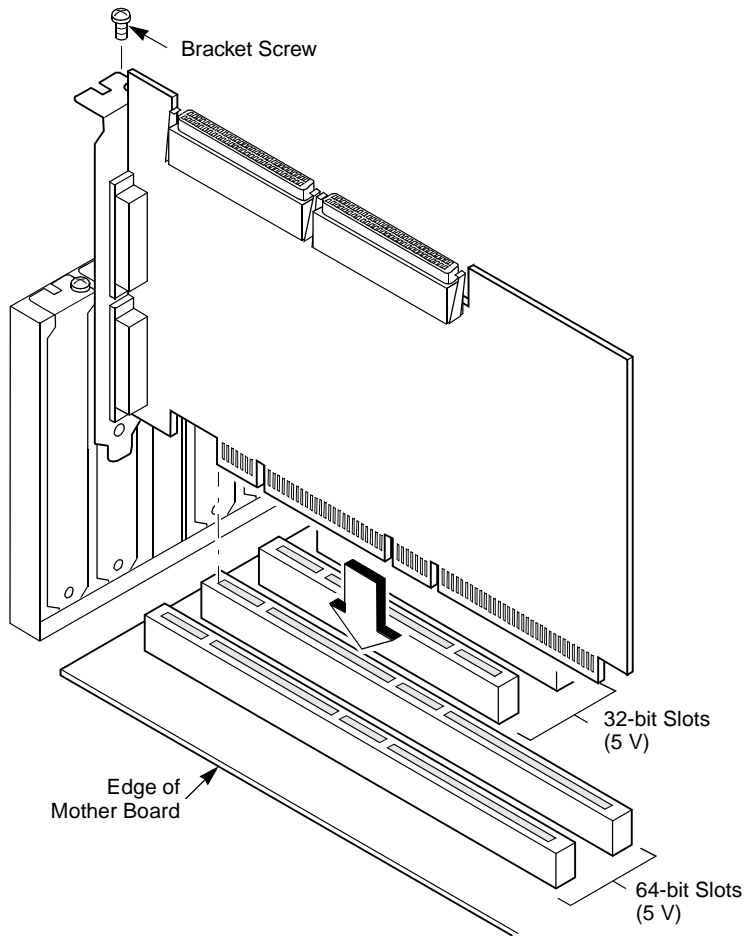

### Step 6—Select and Set Target IDs for SCSI Devices

Set target identifiers (TIDs) on the SCSI devices. Each device in a specific SCSI channel must have a unique TID in that channel. See the documentation for each SCSI device to set the TIDs. The PERC 3/DC or PERC 3/DCL controller automatically occupies TID 7 in the SCSI channel. 8-bit SCSI devices can use the TIDs from 0 to 6 only. 16-bit devices can use the TIDs from 0 to 15. The arbitration priority for a SCSI device depends on its TID.

**Table 9-10. Target IDs for SCSI Devices**

Priority	Highest						Lowest					
TID	7	6	5	...	2	1	0	15	14	...	9	8

### Step 7—Connect SCSI Cables

Connect SCSI cables to SCSI devices. PERC 3/DC or PERC 3/DCL provides internal SCSI connectors, J4 and J5, which are the SCSI channel internal high-density 68-pin connectors for Wide (16-bit) SCSI. PERC 3/DC or PERC 3/DCL also provides two external SCSI connectors: J7 and J15, the SCSI channel external ultra high-density 68-pin connectors for Wide (16-bit) SCSI. Make sure pin 1 on the card is connected to pin 1 of the cable.

**Figure 9-6. Connecting SCSI Cables to PERC 3/DC and 3/DCL**

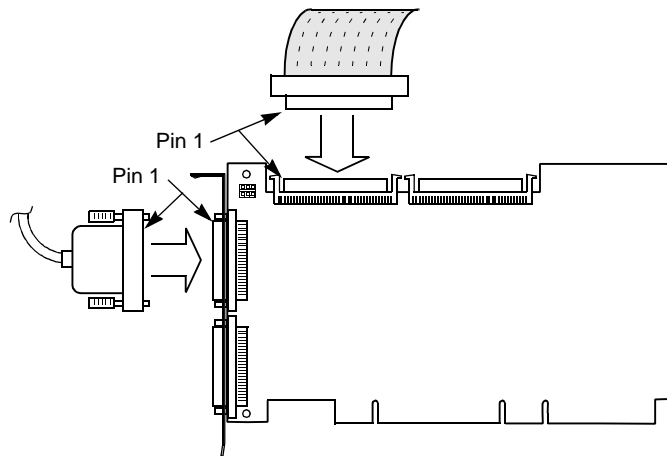

### **Connect SCSI Devices**

When connecting SCSI devices:

- 1** Disable termination on any SCSI device that is *not* at the end of the SCSI bus.  
If the cable is terminated, do not terminate SCSI devices.
- 2** Configure all SCSI devices to supply TermPWR.
- 3** Set proper target IDs (TIDs) for all SCSI devices.
- 4** The cable length should not exceed 12 meters for LVD and 160M SCSI devices.

### **Cable Suggestions**

SCSI disk subsystem throughput can be impaired if SCSI cabling is not optimized. Dell suggests using the following:

- Actively terminated cables
- Dell-approved cables

## Step 8—Power On Host System

Replace the computer cover and reconnect the alternating current (AC) power cords. Power on the host computer. Ensure that all SCSI devices are connected, including SCSI and power cables. If the computer is powered up before a SCSI device, the device might not be recognized.

During boot, the PERC 3/DC or PERC 3/DCL BIOS message appears: (For simplicity, only the PERC 3/DC message is shown.)

```
PowerEdge Expandable RAID Controller BIOS Version xwxx  
date
```

```
Copyright (c) Dell Computer Corporation
```

```
Firmware Initializing... [Scanning SCSI Device...(etc)...]
```

The firmware takes several seconds to initialize. During this time the adapter will scan the SCSI channel. When ready, the following appears:

```
HA -0 (Bus 1 Dev 6) Type: PERC 3/DC Standard FW xwxx SDRAM=  
128MB
```

```
Battery Module is Present on Adapter
```

```
0 Logical Drives found on the Host Adapter
```

```
0 Logical Drive(s) handled by BIOS
```

```
Press <Ctrl><H> to run WebBIOS Configuration Utility
```

The PERC 3 BIOS Configuration Utility prompt times out after several seconds. The PERC 3/DC or PERC 3/DCL host adapter (controller) number, firmware version, and cache SDRAM size display in the second portion of the BIOS message. The numbering of the controllers follows the PCI slot scanning order used by the host motherboard.

## Step 9—Run the PERC 3 BIOS Configuration Utility or WebBIOS Configuration Utility

Press <Ctrl><M> to run the PERC 3 BIOS Configuration Utility or <Ctrl> <H> to run the PERC 3 WebBIOS Configuration Utility.

WebBIOS is an HTML-based configuration utility. See Chapter 11 "PERC 3 BIOS Configuration Utility" for information about running the BIOS Configuration Utility. See the *WebBIOS Configuration Utility Guide* for more information about running the WebBIOS Configuration Utility.

## **Step 10—Install Operating System Software Driver**

See the documentation for the PERC 3/DC or PERC 3/DCL operating systems driver for additional information about installing the drivers for Windows NT, Windows 2000, Novell NetWare 5.x, 6.x, and Red Hat Linux 7.x.

# **Replacing a PERC 3/DC Containing a BC Chip with a PERC 3/DC Containing a BE Chip**

## **Using Driver 5.22.1 or 5.22.2 and Firmware 161J or 161N**

Perform the following steps to replace the PERC 3/DC card if you are using the 5.22.1 or 5.22.2 driver, and 161J or 161N firmware.

- 1 If the driver is not updated to 5.30 or later before you switch controllers, shut down the machine that will have its controller replaced.
- 2 Replace the controller (using the procedures in this chapter.)
- 3 Boot to Windows.
- 4 When logging into Windows, cancel the **New Hardware Device Found** prompts.
- 5 Power down the machine.
- 6 Power on the machine again.
- 7 Log into Windows.
- 8 Proceed to the **Windows Device Manager**.  
There will be a yellow marker on the RAID controller.
- 9 Choose the update driver by selecting **Display a list of the Known drivers for this device** and specifying the location of the driver.

## **Using Driver 5.30 and Firmware 1.70**

Perform the following steps if the driver is updated to 5.30 or later before you replace the controller, and the firmware on the new controller is updated to 1.70.

- 1** Upgrade the existing driver from 5.22.1 or 5.22.2 to 5.30 or later.
- 2** Shut down the machine in which you are going to replace the controller.
- 3** Replace the controller (using the procedures in this chapter.)
- 4** Boot to Windows.  
When you log into Windows, **New Device Prompts** appears.
- 5** Load the driver if prompted.

# 10

SECTION 10

## **PERC 3/QC Hardware Installation**

---

[Requirements](#)

[PERC 3/QC Card Layout](#)

[Installation Steps](#)

## Requirements

This chapter describes the installation procedures for the PERC 3/QC board. You must have the following:

- A PERC 3/QC controller
- A host computer with an available 5 V, 32- or 64-bit peripheral component interconnect (PCI) expansion slot
- The PERC 3/QC installation diskettes
- The necessary SCSI cables (This depends on the number and type of SCSI devices to be attached.)
- Fast, Ultra, Ultra II, and 160M SCSI hard drives

Dell™ strongly recommends that you have an uninterruptible power supply (UPS) for the entire system.

### Optional Equipment

You may also want to install SCSI cables that connect PERC 3/QC to external SCSI devices.



# PERC 3/QC Card Layout

Figure 10-1 displays the PERC 3/QC card and jumpers.

Figure 10-1. PERC 3/QC Card Layout

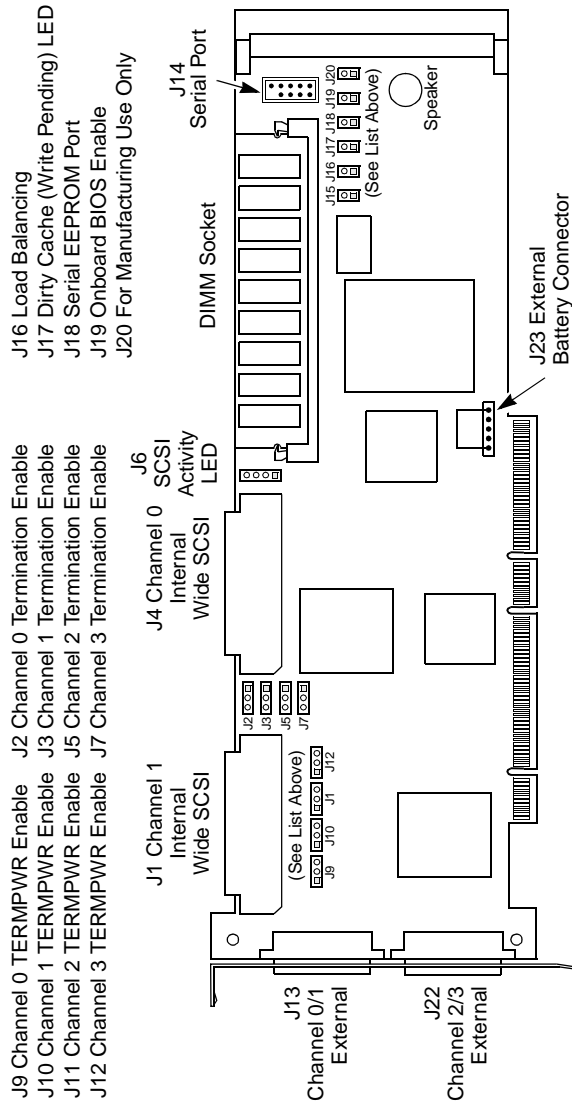

## Installation Steps

This section provides an overview of installing the RAID controller. See the following sections for more information about each step.

- 1 Unpack the PERC 3/QC controller and inspect for damage.  
Make sure all items are in the package. If damaged, call your Dell original equipment manufacturer (OEM) support representative.
- 2 Turn the computer off and remove the cover.
- 3 Check the jumper settings on the PERC 3/QC controller.
- 4 Set SCSI termination.
- 5 Install the PERC 3/QC card.
- 6 Connect the SCSI cables to SCSI devices.
- 7 Set the target IDs for the SCSI devices.
- 8 Replace the computer cover and turn the power on.  
Be sure the SCSI devices are powered up before or at the same time as the host computer.
- 9 Run the PERC 3/QC Basic Input/Output System (BIOS) Configuration Utility or WebBIOS Configuration Utility.
- 10 Install software drivers for the desired operating systems.

### Step 1—Unpack the PERC 3/QC Controller

Unpack and install the hardware in a static-free environment. The PERC 3/QC is packed inside an anti-static bag between two sponge sheets. Remove the controller card and inspect it for damage. If the card appears damaged, or if any item listed below is missing, contact your Dell support representative. The PERC 3/QC card comes with:

- The *PERC 3 User's Guide*
- A license agreement
- The PERC 3/QC Configuration Utilities diskette

## Step 2—Power Down

Turn off the computer and remove the cover. Make sure the computer is turned off and disconnected from any networks before installing the controller.

## Step 3—Set Jumpers

Make sure the jumper settings on the PERC 3/QC card are correct. Table 10-1 displays the jumpers and connectors.

**Table 10-1. PERC 3/QC Jumper Settings**

Connector	Description	Type
J1	Channel 1 internal Wide SCSI	68-pin connector
J2	Channel 0 termination enable	3-pin header
J3	Channel 1 termination enable	3-pin header
J4	Channel 0 internal Wide SCSI	68-pin connector
J5	Channel 2 termination enable	3-pin header
J6	SCSI activity light emitting diode (LED)	4-pin header
J7	Channel 3 termination enable	3-pin header
J9	Channel 0 TERMPWR enable	2-pin header
J10	Channel 1 TERMPWR enable	2-pin header
J11	Channel 2 TERMPWR enable	2-pin header
J12	Channel 3 TERMPWR enable	2-pin header
J13	Channel 0/1 external Wide SCSI	Dual 68-pin connector
J14	Serial port connector	9-pin connector
J17	Dirty cache LED	2-pin connector
J18	Serial EEPROM port	2-pin header
J19	Onboard BIOS enable	2-pin header
J22	Channel 2/3 external Wide SCSI	Dual 68-pin connector
J23	External battery connector	5-pin connector

**J2, J3, J5, and J7 Termination Enable**

J2, J3, J5, and J7 are 3-pin connectors that set the SCSI termination for each SCSI channel. The Dell default is termination always enabled (OPEN.) Table 10-2 displays the pinout.

**Table 10-2. J2, J3, J5 and J7 Termination Enable Pinout**

Jumper	SCSI Channel	SCSI Termination Controlled by Software	SCSI Termination Always Disabled	SCSI Termination Always Enabled
J2	0	Short pins 1-2	Short pins 2-3	OPEN (default)
J3	1	Short pins 1-2	Short pins 2-3	OPEN (default)
J5	2	Short pins 1-2	Short pins 2-3	OPEN (default)
J7	3	Short pins 1-2	Short pins 2-3	OPEN (default)

**J9, J10, J11, and J12 TERMPWR Enable**

J9, J10, J11, and J12 are 2-pin connectors that enable TERMPWR to the SCSI bus for each SCSI channel. The default is pins 1 and 2 shorted. Table 10-3 displays the pinout.

**Table 10-3. J9, J10, J11 and J12 TERMPWR Enable Pinout**

Jumper	Term. Power Channel	Settings
J9	0	Short pins 1-2 to have the host PCI bus provide TermPWR. This is the factory setting. Leave open to let the SCSI bus provide TermPWR.
J10	1	Short pins 1-2 to have the host PCI bus provide TermPWR. This is the factory setting. Leave open to let the SCSI bus provide TermPWR.
J11	2	Short pins 1-2 to have the host PCI bus provide TermPWR. This is the factory setting. Leave open to let the SCSI bus provide TermPWR.
J12	3	Short pins 1-2 to have the host PCI bus provide TermPWR. This is the factory setting. Leave open to let the SCSI bus provide TermPWR.

### J14 Serial Port

J14 attaches to a serial cable. Figure 10-2 and Table 10-4 show the pinout for J14.

**Figure 10-2. J14 Serial Port Diagram**

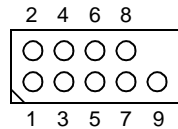

**Table 10-4. J14 Serial Port Pinout**

Pin	Description	Pin	Description
1	Carrier detect	2	Data set ready
3	Receive data	4	Request to send
5	Transmit data	6	Clear to send
7	Data terminal ready	8	Ring indicator
9	Ground	10	CUT

### J17 Dirty Cache LED

J17 is a two-pin connector for an LED mounted on the computer enclosure. The LED indicates when the data in the cache has yet to be written to the storage devices. Table 10-5 displays the pinout for J17.

**Table 10-5. J17 Dirty Cache LED Pinout**

Pin	Description
1	Signal pulled high
2	Dirty cache signal

### J19 Onboard BIOS Enable

J19 is a 2-pin connector which enables or disables PERC 3/QC onboard BIOS. The onboard BIOS should be enabled (J19 unjumpered) for normal board position. Unjumpered is the default. Table 10-6 displays the J19 settings.

**Table 10-6. J19 Onboard BIOS Enable Settings**

J19 Setting	Onboard BIOS Status
Unjumped	Enabled
Jumped	Disabled

**J23 External Battery**

J23 is a 5-pin connector that attaches to the optional battery pack. Table 10-7 displays the J23 pinout.

**Table 10-7. J23 External Battery Pinout**

Pin	Description
1	+BATT Terminal (red wire)
2	Thermistor (white wire)
3	-BATT Terminal (black wire)
4	BATDQ (no wire)
5	Ground (no wire)

**Step 4—Set SCSI Termination**

You must terminate the SCSI bus properly. Set termination at both ends of the SCSI cable. The SCSI bus is an electrical transmission line and must be terminated properly to minimize reflections and losses. Termination should be set at each end of the SCSI cable(s), as shown below. Termination is always enabled, regardless of the configuration. However, you can override this setting by setting another state. The Dell default is termination by jumper. Figure 10-3 displays an example of termination.

**Figure 10-3. Example of Termination**

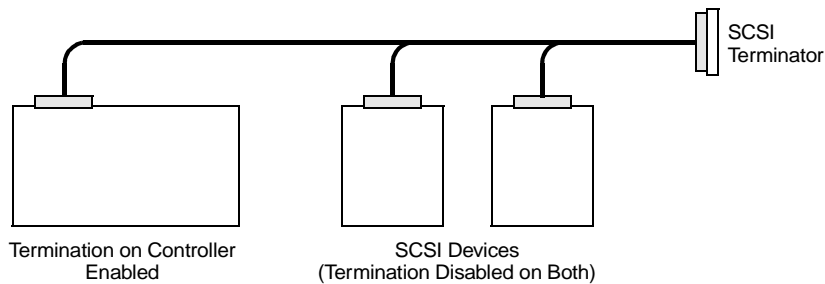

For a disk array, set SCSI bus termination so that removing or adding a SCSI device does not disturb termination. An easy way to do this is to connect the PERC 3/QC card to one end of the SCSI cable and to connect an external terminator module at the other end of the cable. The connectors between the two ends can connect SCSI devices. Disable termination on the SCSI devices. See the manual for each SCSI device to disable termination.

### **SCSI Termination**

The SCSI bus is an electrical transmission line and it must be terminated properly to minimize reflections and losses. You complete the SCSI bus by setting termination at both ends.

You can let PERC 3/QC automatically provide SCSI termination at one end of the SCSI bus. You can terminate the other end of the SCSI bus by attaching an external SCSI terminator module to the end of the cable or by attaching a SCSI device that internally terminates the SCSI bus at the end of the SCSI channel.

### **Selecting a Terminator**

Use standard external SCSI terminators on a SCSI channel operating at 10 MB/s or higher synchronous data transfer.

### Terminating Internal SCSI Disk Arrays

Set the termination so that SCSI termination and termination power are intact when any disk drive is removed from a SCSI channel, as shown in Figure 10-4.

Figure 10-4. Termination of Internal SCSI Disk Arrays

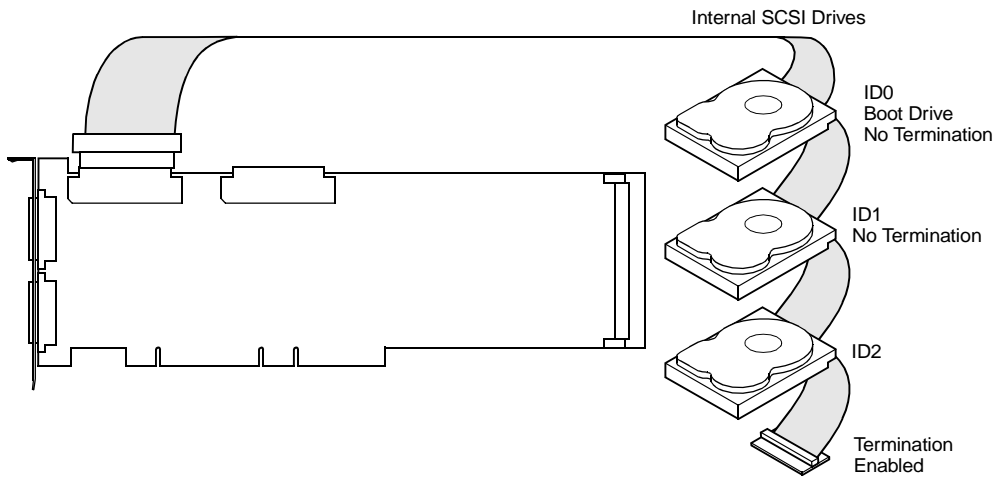



### Step 5—Install PERC 3/QC

Choose a 3.3 V or 5 V PCI slot and align the PERC 3/QC bus connector to the slot. Press down gently but firmly to make sure that the card is properly seated in the slot. The bottom edge of the controller card should be flush with the slot. Figure 10-5 displays the PCI slots on a motherboard.

Figure 10-5. PCI Slots on Motherboard

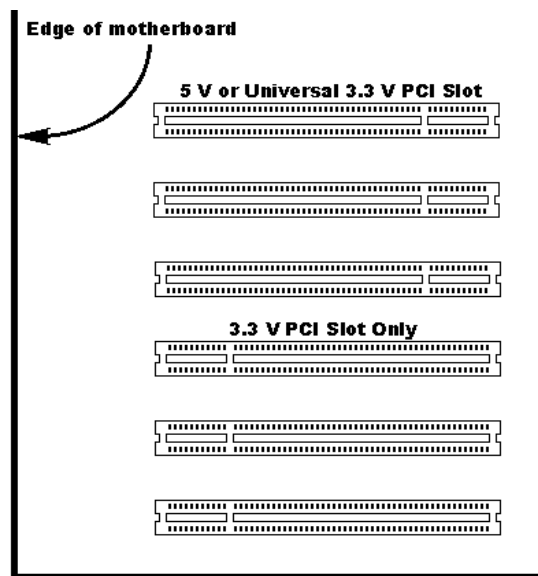

Insert the PERC 3/QC card into a PCI slot as shown in Figure 10-6. Screw the bracket to the computer frame.

**Figure 10-6. Installation of the PERC 3/QC Card**

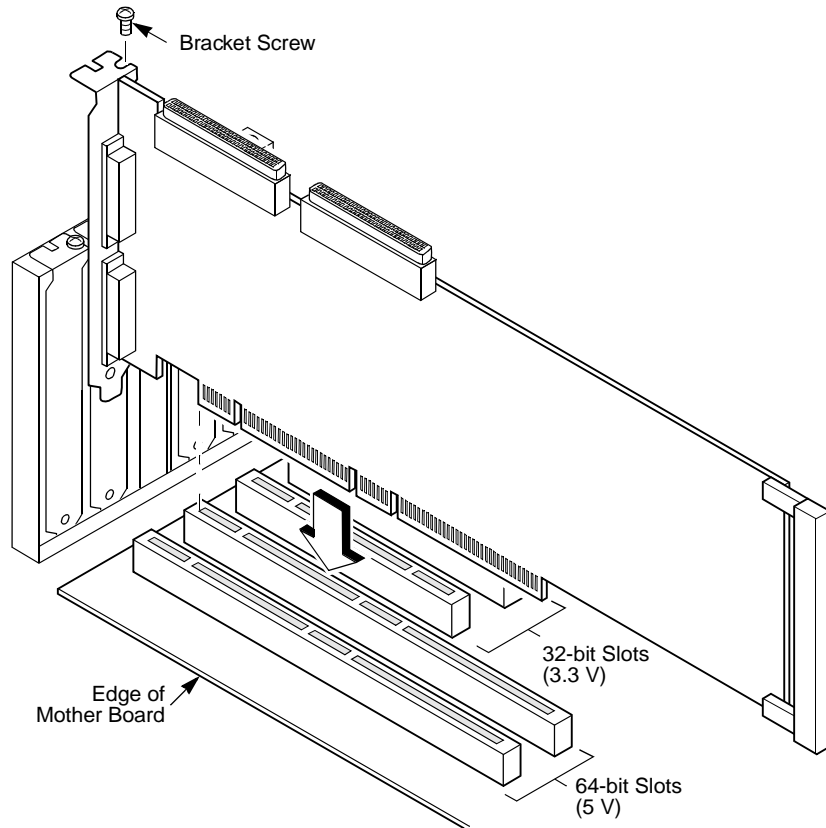

## Step 6—Connect SCSI Cables

Connect SCSI cables to SCSI devices. PERC 3/QC provides two internal SCSI connectors, J1 (channel 1) and J4 (channel 0), which are the SCSI channel internal high-density 68-pin connectors for Wide (16-bit) SCSI. PERC 3/QC provides four external SCSI connectors: J13 (channels 0 and 1) and J22 (channels 2 and 3), the SCSI channel external ultra high-density 68-pin connectors for Wide (16-bit) SCSI. Only one cable should be connected to any available channel.

Make sure that pin 1 on the cable is connected to pin 1 on the PERC 3/QC card. Figure 10-7 displays SCSI cables being connected to the card.

**Figure 10-7. Connecting SCSI Cables**

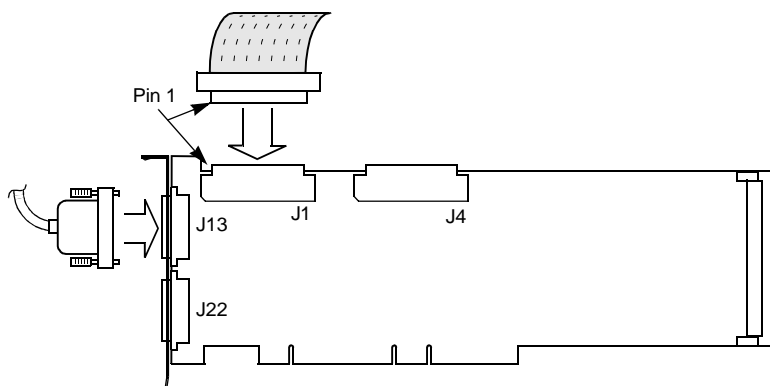

### Connect SCSI Devices

The cable length should not exceed three meters for Fast SCSI (10 MB/s) devices or three meters for a four drive Ultra2 SCSI drive system. The cable length can be up to 12 meters for low-voltage differential (LVD) devices.

The cable length should not exceed six meters for non-Fast SCSI devices. Perform the following steps to connect SCSI devices:

- 1 Disable termination on any SCSI device that does *not* sit at the end of the SCSI bus.
- 2 Configure all SCSI devices to supply TermPWR.
- 3 Set proper target IDs (TIDs) for all SCSI devices.

### Cable Suggestions

System throughput problems can occur if SCSI cable use is not maximized. You should:

- Use cables up to 12 meters for LVD devices.
- For single ended SCSI devices, use the shortest SCSI cables (no more than 3 meters for Fast SCSI, no more than 1.5 meters for an 8-drive Ultra2 SCSI system and no more than 3 meters for a 6-drive Ultra2 SCSI system.)
- Use active termination.
- Use only Dell-approved cables.

### Step 7—Set Target IDs

Set target identifiers (TIDs) on the SCSI devices. Each device in a specific SCSI channel must have a unique TID in that channel. See the documentation for each SCSI device to set the TIDs. The PERC 3/QC controller automatically occupies TID 7 in the SCSI channel. Eight-bit SCSI devices can only use the TIDs from 0 to 6. 16-bit devices can use the TIDs from 0 to 15. The arbitration priority for a SCSI device depends on its TID.

**Table 10-8. Target IDs**

Priority	Highest					Lowest						
TID	7	6	5	...	2	1	0	15	14	...	9	8

### Step 8—Power on Host System

Replace the computer cover and reconnect the AC power cords. Turn power on to the host computer. Set up the power supplies so that the SCSI devices are powered up at the same time as or before the host computer. If the computer is powered up before a SCSI device, the device might not be recognized.

During boot, the PERC 3/QC BIOS message appears:

```
PowerEdge Expandable RAID Controller BIOS Version x.xx
date
```

```
Copyright (c) Dell Computer Corporation
```

Firmware Initializing... [Scanning SCSI Device...(etc)...]

The firmware takes several seconds to initialize. During this time the adapter will scan the SCSI channel. When ready, the following appears:

```
HA -0 (Bus 1 Dev 6) Type: PERC 3/QC Standard FW x.xx SDRAM=
xxxMB
```

```
Battery Module is Present on Adapter
```

```
0 Logical Drives found on the Host Adapter
```

```
0 Logical Drive(s) handled by BIOS
```

```
Press <Ctrl><M> to run PERC 3 BIOS Configuration Utility
```

```
Or press <Ctrl><H> to run WebBIOS
```

The BIOS Configuration Utility prompt times out after several seconds. The PERC 3/QC host adapter (controller) number, firmware version, and cache SDRAM size are displayed in the second portion of the BIOS message. The numbering of the controllers follows the PCI slot scanning order used by the host motherboard.

### **Step 9—Run the PERC 3 BIOS Configuration Utility or WebBIOS Configuration Utility**

Press <Ctrl><M> to run the PERC 3 BIOS Configuration Utility or <Ctrl> <H> to run the WebBIOS Configuration Utility. See Chapter 11 "PERC 3 BIOS Configuration Utility" for additional information about running the PERC 3 BIOS Configuration Utility. WebBIOS is an HTML-based configuration utility. See the *WebBIOS Configuration Utility Guide* for additional information about running WebBIOS.

### **Step 10—Install Operating System Driver**

See the *PERC 3 Operating System Driver Installation Guide* for additional information about installing the drivers for Windows NT<sup>®</sup>, Windows<sup>®</sup> 2000, Novell<sup>®</sup> NetWare<sup>®</sup>, and Red Hat Linux.



## SECTION 11

# **PERC 3 BIOS Configuration Utility**

---

- Configuration On Disk
- Starting the PERC 3 BIOS Configuration Utility
- BIOS Configuration Utility Menu Options
- Configuring Arrays and Logical Drives
- Choosing the Configuration Method
- Designating Drives as Hot Spares
- Using Easy Configuration
- Using New Configuration
- Using View/Add Configuration
- Initializing Logical Drives
- Deleting Logical Drives (Random Array Deletion)
- Formatting Physical Drives
- Rebuilding Failed Disk Drives
- Using a Pre-loaded SCSI Drive "As-is"
- Exiting the PERC 3 BIOS Configuration Utility
- Setting Hardware Termination
- Clustering

The PERC 3 BIOS Configuration Utility configures disk arrays and logical drives. Because the utility resides in the PERC 3 BIOS, its operation is independent of the operating systems on your computer. This chapter describes the utility, and the configuration options it offers. Clustering is described at the end of the chapter.

## Configuration On Disk

PERC 3 supports Configuration on Disk (drive roaming.) Configuration on Disk saves configuration information both in the PERC 3 non-volatile random access memory (NVRAM) and on the physical drives attached to the PERC 3. If the PERC 3 is replaced, the new PERC 3 controller can detect the RAID configuration, maintaining the integrity of the data on each drive even if the drives have changed target ID.

Perform the following steps to enable configuration on disk support:

- 1 Press <Ctrl> <M> at the PERC 3 power-on self test (POST) screen to run the BIOS Configuration Utility.
- 2 Select **Configure Menu**—> **View/Add Configuration**.
- 3 Select **Disk** when asked to use **Disk** or **NVRAM**.
- 4 Select **Save**.
- 5 Press <Esc> to exit the utility.
- 6 Reboot the computer.

## Starting the PERC 3 BIOS Configuration Utility

When the host computer boots, hold the <Ctrl> key and press the <M> key when the following appears:

```
HA -0 (Bus 1 Dev 6) Type: PERC 3/QC Standard FW x.xx SDRAM=
128MB

0 Logical Drives found on the Host Adapter
Adapter BIOS Disabled, No Logical Drives handled by BIOS

0 Logical Drive(s) handled by BIOS
```



Press <Ctrl><H> to Enable BIOS

For each PERC adapter in the host system, the firmware version, dynamic random access memory (DRAM) size, and the status of logical drives on the card display. If you do not press <Ctrl><M> within a few seconds of the prompt, the computer continues normal booting.

After you press a key to continue, the **Management Menu** screen displays. See the next section, “BIOS Configuration Utility Management Menu Options,” for more information.

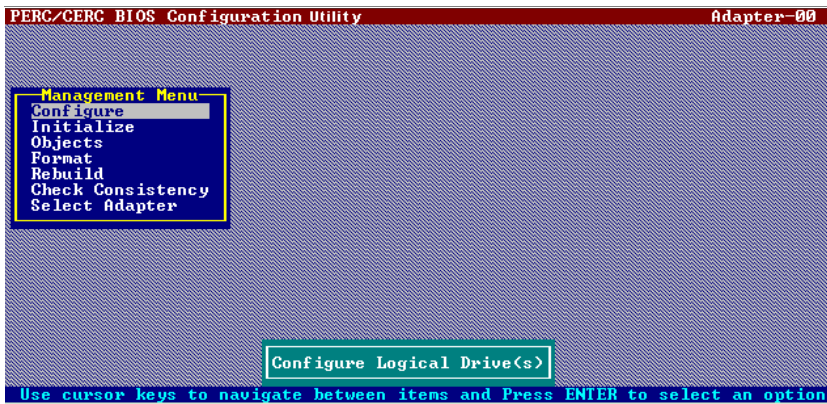

## BIOS Configuration Utility Menu Options

Table 11-1 describes the options for the BIOS Configuration Utility Management Menu. The menu and sub-menu options are explained in the following sections.

**Table 11-1. BIOS Configuration Utility Menu Options**

Option	Description
Configure	Select this option to configure physical arrays and logical drives.
Initialize	Select this option to initialize one or more logical drives.

**Table 11-1. BIOS Configuration Utility Menu Options**

<b>Option</b>	<b>Description</b>
Objects	Select this option to individually access controllers, logical drives, and physical drives.
Format	Select this option to low-level format hard disk drives.
Rebuild	Select this option to rebuild failed disk drives.
Check Consistency	Select this option to verify that the redundancy data in logical drives using RAID level 1, 5, 10, or 50 is correct.
Select Adapter	Select this option to list the adapters and select the adapter that you want to configure. The number of the selected adapter displays in the top right corner of the screen, along with its mode, either standard or cluster.

### Configure Menu

Choose **Configure** to select a method for configuring arrays and logical drives. Table 11-2 displays the configuration methods, clear configuration option, and boot drive option.

**Table 11-2. Configuration Menu Options**

<b>Option</b>	<b>Description</b>
Easy Configuration	Select this method to perform a logical drive configuration where every physical array you define is automatically associated with exactly one logical drive.
New Configuration	Select this method to discard the existing configuration information and to configure new arrays and logical drives. In addition to providing the basic logical drive configuration functions, <b>New Configuration</b> allows you to associate logical drives with multiple arrays (spanning.)
View/Add Configuration	Select this method to examine the existing configuration and/or to specify additional arrays and logical drives. <b>View/Add Configuration</b> provides the same functions available in <b>New Configuration</b> .
Clear Configuration	Select this option to erase the current configuration information from the PERC 3 non-volatile memory.
Specify Boot Logical Drive	Select this option to specify a logical drive as the boot drive on this adapter.

## Initialize Menu

Choose **Initialize** from the BIOS Configuration Utility **Management Menu** to initialize one or more logical drives. Press the space bar to select a single driver or the <F2> key to select all drives for initialization. This action typically follows the configuration of a new logical drive.

 **NOTE:** See page 178 for procedures for initializing logical drives.

 **NOTICE:** Initializing a logical drive destroys all data on the logical drive.

## Objects Menu

Choose **Objects** from the **Management Menu** to access the adapters, logical drives, physical drives, and SCSI channels individually. You can also change settings for each object. The **Objects** menu options are described in the following sections.

### Adapter

Choose **Objects**→**Adapter** to select a controller (if the computer has more than one) and to modify parameters. You can install only one PERC 3 controller, but you can install other PERC controllers.

Table 11-3 describes the **Adapter** menu options.

**Table 11-3. Adapter Menu Options**

Option	Description
Clear Configuration	Choose this option to erase the current configuration from the controller non-volatile memory.
FlexRAID PowerFail	Choose this option to enable or disable the FlexRAID PowerFail feature. This option allows drive reconstruction, rebuild, and check consistency to continue when the system restarts because of a power failure, reset, or hard boot.
Fast Initialization	Select this option to write zeros to the first sector of the logical drive so that initialization occurs in 2 – 3 seconds.  When this option is set to <b>Disabled</b> , a full initialization takes place on the entire logical drive. On a larger array (over 5 arrays), it is best to set fast initialization to <b>Disabled</b> , then initialize. Otherwise, the controller will run a background consistency check within five minutes of reboot or RAID 5 creation.

**Table 11-3. Adapter Menu Options (continued)**

<b>Option</b>	<b>Description</b>
Disk Spin up Timings	Choose this option to set the method and timing for spinning up the hard disk drives.
Cache Flush Timings	Choose this option to set the cache flush interval to once every 2, 4, 6, 8, or 10 seconds. The default is 4.
Rebuild Rate	Use this option to select the rebuild rate for drives attached to the selected adapter.  The rebuild rate is the percentage of the system resources dedicated to rebuilding a failed drive. A rebuild rate of 100 percent means the system is totally dedicated to rebuilding the failed drive. The default is 30 percent.
Alarm Control	Choose this option to enable, disable, or silence the onboard alarm tone generator. The alarm sounds when there is a change in a drive state, such as when a drive fails or when a rebuild is complete.
Other Adapter Information	Provides general information about the adapter, such as the firmware version, and BIOS version.
Factory Default	Choose this option to load the default BIOS Configuration Utility settings.
Enable BIOS	Choose this option to enable or disable the BIOS on the adapter. If the boot device is on the RAID controller, the BIOS must be enabled; otherwise, the BIOS should be disabled or it might not be possible to use a boot device elsewhere.
Emulation	You can operate in the I2O mode or mass storage mode. Dell recommends that you use only mass storage mode, and Dell drivers only.
Auto Rebuild	Set to <b>Enabled</b> to automatically rebuild drives when they fail.
Initiator ID	ID for the cluster card. It cannot have the same ID as the other node. The default is 7.
Cluster Mode	You can enable or disable cluster mode. When you disable cluster mode, the system operates in standard mode.  Cluster:Adapter or Standard:Adapter displays in the upper right corner of the screen.

### Cluster Mode and the Initiator ID

You can enable or disable cluster mode. When you disable cluster mode, the system operates in standard mode. In addition, when you enable cluster mode, the system automatically disables the BIOS.

You can change the Initiator ID only when you are in cluster mode. You cannot change the ID while in standard mode. The ID can be a number from 0 to 15. We recommend that you use 6 or 7. When you are in standard mode, the ID is always 7.

### Logical Drive

Choose **Objects**—> **Logical Drive** to select a logical drive and to perform the actions listed in Table 11-4.

**Table 11-4. Logical Drive Menu Options**

Option	Description
Initialize	Initializes the selected logical drive. Do this for every logical drive that is configured.
Check Consistency	Verifies the correctness of the redundancy data in the selected logical drive. This option is available only if RAID level 1, 5, 10, or 50 is used. PERC 3 automatically corrects any differences found in the data.
View/Update Parameters	Displays the properties of the selected logical drive. You can modify the cache write policy, read policy, and the input/output (I/O) policy and can enable virtual sizing from this menu.

### Virtual Sizing

Virtual sizing allows the PERC 3 controller to determine the drive capacity. The operating system reports the drive capacity as determined by PERC. *Virtual sizing is not supported in cluster mode.*

Set virtual sizing to **Enabled** before you add a physical drive to a logical drive. Perform the following steps to enable virtual sizing.

- 1 Select **Objects**—> **Logical Drive**.
- 2 Select **Logical Drive**—> **View/Update Properties**.
- 3 Select **View/Update Properties**—> **Virtual Sizing**.

#### 4 Select **Enabled** to enable **Virtual Sizing**.

After you have created a logical drive set, the partition of the drive should be as large as the virtual size of the logical drive. After you have created a logical array set, the drive partition can be as large as the full size of the logical drive. However, this is the full virtual drive size, not the actual physical drive size.

#### Physical Drive

Select **Objects**—> **Physical Drive** to select a physical device and to perform the operations listed in the table below. The physical drives in the computer are listed. Move the cursor to the desired device and press <Enter> to display the screen.

Table 11-5 displays the operations you can perform on the physical drives.

**Table 11-5. Physical Drive Menu Options**

<b>Option</b>	<b>Description</b>
Rebuild	Rebuilds the selected physical drive.
Format	Low-level formats the selected disk drive.
Force Online	Changes the state of the selected disk drive to online.
Force Offline/ Remove HSP	Changes the state of the selected disk drive to offline.
Make HotSpare	Designates the selected disk drive as a hot spare.
View Drive Information	Displays the drive properties for the selected physical device.
View Rebuild Progress	Indicates how much of the rebuild has been completed.
SCSI Command Qtagging	Sets the number of queue tags per command. The options are <b>Disabled Command Tagging</b> , <b>2 Queue Tags</b> , <b>3 Queue Tags</b> , <b>4 Queue Tags</b> , or <b>Enhanced QTag Scheduling</b> . The default is <b>Enhanced QTag Scheduling</b> .
Transfer Speed Option	Selects the speed at which data is transferred. Displays a menu that contains the options <b>Negotiation=Wide</b> , and <b>Set Transfer Speed</b> . The maximum transfer speed is <b>160M</b> .

## Channel

Choose **Objects**—> **Channel** to select a SCSI channel on the currently selected controller. After you select a channel, press <Enter> to display the options for that channel. Table 11-6 describes the SCSI channel menu options.

**Table 11-6. SCSI Channel Menu Options**

Option	Description
Termination Enabled/Disabled	When set to enabled, the PERC 3 controller is terminated. When set to disabled, it is not terminated. Normally, you do not need to change this setting; PERC 3 automatically sets this option.
SCSI Transfer Rate	Used to select the SCSI transfer rate. The options are <b>Fast</b> , <b>Ultra</b> , <b>Ultra-2</b> , and <b>160M</b> .  <b>NOTE:</b> The disk transfer rate is set for each disk, while the SCSI channel transfer rate controls the speed of the bus. No matter how fast you set the disk transfer rate, the speed depends on the SCSI channel transfer rate.

## Battery Information

Choose **Objects**—> **Battery Information** to view the battery backup information. Table 11-7 describes the battery information options.

 **NOTE:** The battery information is valid only for the PERC 3/QC and PERC 3/DC. The PERC 3/DCL and PERC 3/SC do not have a battery option.

**Table 11-7. Battery Information Menu Options**

Menu Item	Explanation
Backup Module	<b>PRESENT</b> appears if there is a battery module; <b>ABSENT</b> if there is not.
Battery Pack	<b>PRESENT</b> appears if the battery pack is properly installed; <b>ABSENT</b> if it is not.
Temperature	<b>GOOD</b> appears if the temperature is within the normal range. <b>HIGH</b> appears if the module is too hot.
Voltage	<b>GOOD</b> appears if the voltage is within the normal range. <b>BAD</b> appears if the voltage is out of range.
Fast Charging	<b>COMPLETED</b> appears if the fast charge cycle is done. <b>CHARGING</b> appears if the battery pack is charging.

**Table 11-7. Battery Information Menu Options (continued)**

<b>Menu Item</b>	<b>Explanation</b>
No of Cycles	Displays the number of charge cycles. After 1100 charge cycles, the life of the battery pack is assumed to be over and you must replace it.

**Reset Battery Charge Counter**

Choose **Objects**—> **Reset Battery Charge Counter** to reset the charge cycle count. Perform the following steps to configure the charge cycle:

- 1** When you first install a battery pack, set the **Charge Cycle** to 0.
- 2** Select **Reset Battery Charge Counter**.
- 3** Select **YES** to reset the number of cycles to zero and press <Enter>.

After 1100 charge cycles, the life of the battery pack is assumed to be over and you must replace it.

**Format Menu**

Choose **Format** from the **Management Menu** to low-level format one or more physical drives.

 **NOTICE:** Formatting a hard drive destroys all data on the drive.

Because most SCSI disk drives are low-level formatted at the factory, this step is usually not necessary. You must format a disk only if:

- The disk drive was not low-level formatted at the factory, or
- An excessive number of media errors have been detected on the disk drive.

You do not have to choose **Format** to erase existing information on your SCSI disks, such as a system partition. That information is erased when you initialize the logical drive(s).

**Rebuild Menu**

Choose **Rebuild** from the **Management Menu** to rebuild one or more failed physical drives.



## Check Consistency Menu

Choose **Check Consistency** to verify the redundancy data in logical drives that use RAID levels 1, 5, 10, and 50.

The parameters of the existing logical drives appear. Discrepancies are automatically corrected, *assuming always that the data is correct*. However, if the failure is a read error on a data drive, the bad data block is reassigned with the generated data.

Perform the following steps to run a consistency check:

- 1 Select **Check Consistency** on the **Management Menu**.  
The currently configured logical drives display.
- 2 Press the arrow keys to choose the desired logical drives.
- 3 Press the spacebar to select or deselect a drive for consistency checking.
- 4 Press <F2> to select or deselect all the logical drives.
- 5 Press <F10> to begin the consistency check.  
A progress indicator for each selected logical drive displays.
- 6 When the check is finished, press any key to clear the progress display. Press <Esc> to display the **Management Menu**.  
(To check an individual drive, you can select **Objects—> Logical Drives**, the desired logical drive(s), and **Check Consistency** on the action menu.)

## Configuring Arrays and Logical Drives

You can configure physical arrays and logical drives with the BIOS Configuration Utility using:

- Easy Configuration
- New Configuration
- View/Add Configuration

Each configuration method requires a different level of user input. The general flow of operations for array and logical drive configuration is:

- 1 Choose a configuration method.
- 2 Designate hot spares (optional).
- 3 Create arrays using the available physical drives.
- 4 Define logical drives using the space in the arrays.
- 5 Save the configuration information.
- 6 Initialize the new logical drives.

## Choosing the Configuration Method

### Easy Configuration

In **Easy Configuration**, each physical array you create is associated with exactly one logical drive, and you can modify the following parameters:

- RAID level
- Stripe size
- Write policy
- Read policy
- I/O policy

If logical drives have already been configured when you select **Easy Configuration**, the configuration information is not disturbed.

### New Configuration

In **New Configuration**, you can modify the following logical drive parameters:

- RAID level
- Stripe size
- Write policy
- Read policy
- I/O policy
- Logical drive size
- Spanning of arrays

If you select **New Configuration**, the existing configuration information on the selected controller is *destroyed when the new configuration is saved*.

### View/Add Configuration

**View/Add Configuration** allows you to control the same logical drive parameters as **New Configuration** *without disturbing* the existing configuration information. You can also choose to enable the **Configuration on Disk** feature.

### PERC 3/QC and PERC 3/DC Default Settings

Table 11-8 displays the default settings for PERC 3/QC and PERC 3/DC.

**Table 11-8. PERC 3/QC and PERC 3/DC Default Settings**

Stripe size	64 KB
Write policy	Write-back
Read-ahead policy	Adaptive
Cache policy	Direct I/O
FlexRAID virtual sizing	OFF
FlexRAID PowerFail	ON (OFF for cluster enabled)

 **NOTE:** In cluster mode, PERC 3/DC allows write-through cache policy only.

### PERC 3/SC and PERC 3/DCL Default Settings

Table 11-9 displays the default settings for PERC 3/SC and PERC 3/DCL.

**Table 11-9. PERC 3/SC and PERC 3/DCL Default Settings**

Stripe size	64 KB
Write policy	Write-through
Read-ahead policy	Adaptive
Cache policy	Direct I/O
FlexRAID virtual sizing	OFF
FlexRAID PowerFail	ON

### Reserved Disk Space during Configuration

Up to 20.6 MB of disk space is reserved when a hard drive is being configured.

## Designating Drives as Hot Spares

Hot spares are physical drives that are powered up along with the RAID drives and usually stay in a standby state. The hot spare drive should be larger than or equal to the smallest logical drive. If a hard drive used in a RAID logical drive fails, a hot spare will automatically take its place and the data on the failed drive is reconstructed on the hot spare. Hot spares can be used for RAID levels 1 and 5. Each PERC 3 controller supports up to eight hot spares.

The methods for designating physical drives as hot spares are:

- Pressing <F4> while creating arrays in **Easy, New or View/Add Configuration** mode, or
- Using the **Objects—> Physical Drive** menu.

### Press <F4>

When you choose any configuration option, a list of all physical devices connected to the current controller appears. Perform the following steps to designate a drive as a hot spare.

- 1 Press the arrow keys to choose a disk drive that has a **READY** indicator
- 2 Press <F4> to designate the drive as a hot spare.  
The indicator will change to **HOTSP**.
- 3 Save the configuration.

### Objects Menu

Perform the following steps to designate a drive as a hot spare.

- 1 Select **Objects—> Physical Drive** from the **Management Menu**.  
A physical drive selection screen displays.
- 2 Select a hard drive and press <Enter> to display the action menu for the drive.

- 3 Press the arrow keys to select **Make HotSpare** and press <Enter>.  
The indicator for the selected drive changes to **HOTSP**.
- 4 Save the configuration.

## Using Easy Configuration

In Easy Configuration, each array is associated with exactly one logical drive. Perform the following steps to create arrays using Easy Configuration.

- 1 Choose **Configure** from the **Management Menu**.

The **Configure** options menu displays.

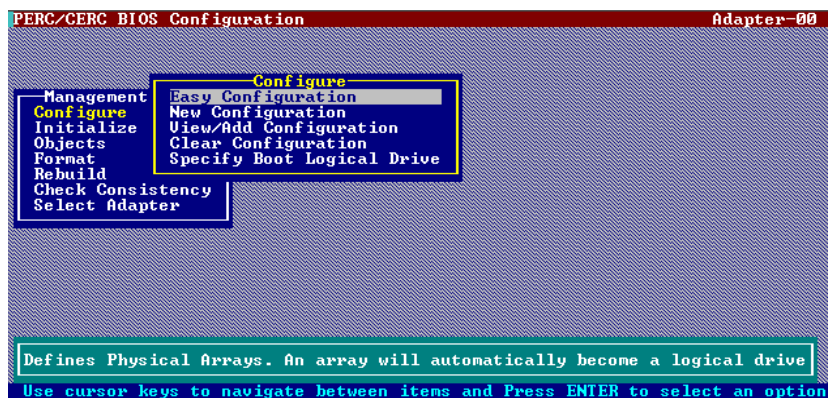

- 2 Choose **Configure**—> **Easy Configuration**.

The array selection menu appears. Hot key information displays at the bottom of the screen. The hot key functions are:

- <F2> Display the manufacturer data and error count for the selected drive.
- <F3> Display the logical drives that have been configured.
- <F4> Designate the selected drive as a hot spare.

**NOTE:** Try to use drives of the same capacity in a specific array. If you use drives with different capacities in an array, all drives in the array are treated as if they have the capacity of the smallest drive in the array.

- 3 Press the arrow keys to highlight specific physical drives.
- 4 Press the spacebar to associate the selected physical drive with the current array.

The indicator for the selected drive changes from **READY** to **ONLIN A[*array number*]-[*drive number*]**. For example, **ONLIN A2-3** means disk drive 3 in array 2.

- 5 Add physical drives to the current array as desired.

The number of physical drives in a specific array determines the RAID levels that can be implemented with the array.

- RAID 0 requires one or more physical drives.
- RAID 1 requires exactly two physical drives.
- RAID 5 requires at least three physical drives.
- RAID 10 requires at least four physical drives.
- RAID 50 requires at least six physical drives.

- 6 Press <Enter> after you finish creating the current array.

A window entitled **Select Configurable Array(s)** appears. It displays the array, and array number, such as A-00.

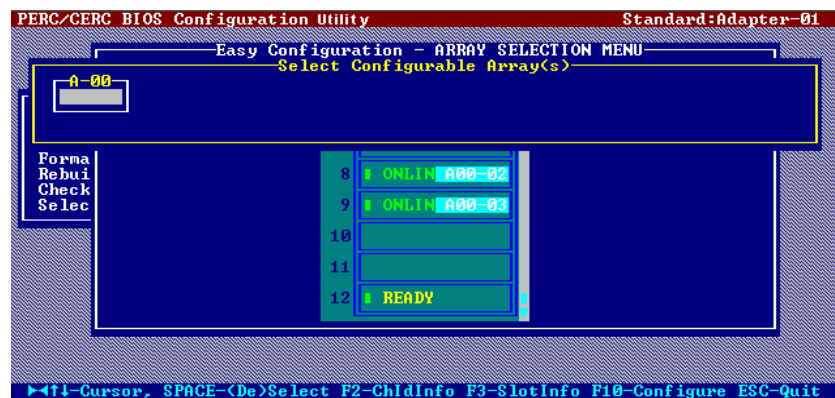

- 7 Press the spacebar to select the array.

Span information, such as **Span-1**, displays in the array box. You can create multiple arrays, then select them to span them.

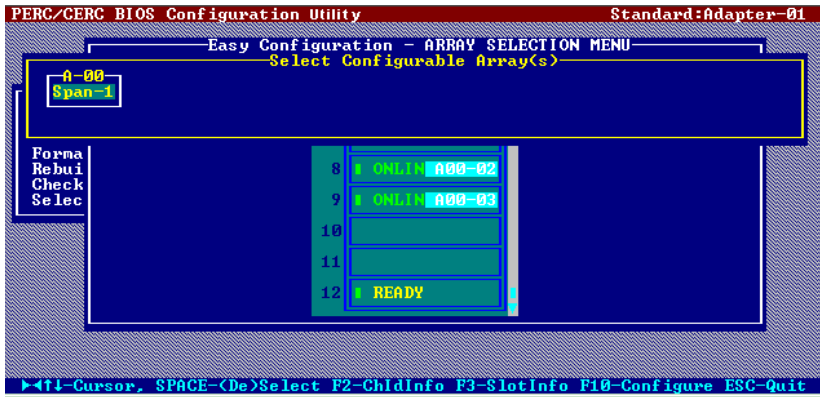

**NOTE:** You can press <F2> to display the number of drives in the array, their channel and ID, and <F3> to display array information, such as the stripes, slots, and free space.

- 8 Press <F10> to configure logical drives.

The logical drive configuration screen appears. **Span=Yes** displays on this screen if you select two or more arrays to span.

The window from the top of the screen shows the logical drive that is currently being configured as well as any existing logical drives.

The column headings are:

- **LD:** The logical drive number
- **RAID:** The RAID level
- **Size:** The logical drive size
- **#Stripes:** The number of stripes (physical drives) in the associated physical array
- **StrpSz:** The stripe size
- **DriveState:** The state of the logical drive

- 9 Highlight **RAID** and press <Enter>.

The available RAID levels for the current logical drive display.

- 10 Select a RAID level for the logical drive and press <Enter> to confirm.

See Chapter 3 for an explanation of the RAID levels.

- 11 Set the **Stripe Size** from the **Advanced Menu**.



**NOTE:** In Cluster mode, PERC 3/DC allows write-through cache policy only.

**Stripe Size** specifies the size of the segments written to each disk in a RAID 1 or 5 logical drive. You can set the stripe size to 2 KB, 4 KB, 8 KB, 16 KB, 32 KB, 64 KB, or 128 KB. A larger stripe size produces better read performance, especially if your computer does mostly sequential reads. If you are sure that your computer does random read requests more often, choose a small stripe size. The default is 64 KB.

## 12 Set the Write Policy from the Advanced Menu.

**Write Policy** sets the caching method to write-back or write-through.

- In **Write-back** caching, the controller sends a data transfer completion signal to the host when the controller cache has received all the data in a transaction. This setting is recommended in standard mode.
- In **Write-through** caching, the controller sends a data transfer completion signal to the host when the disk subsystem has received all the data in a transaction. This is the default setting if cluster mode is enabled.

**Write-through** caching has a data security advantage over **write-back** caching. **Write-back** caching has a performance advantage over **write-through** caching.

## 13 Set the Read Policy from the Advanced Menu.

The **Read-ahead** option enables the SCSI read-ahead feature for the logical drive. You can set this parameter to **No-Read-Ahead**, **Read-ahead**, or **Adaptive**. **Adaptive** is the default setting.

- **No-Read-Ahead** specifies that the controller does not use read-ahead for the current logical drive.
- **Read-ahead** specifies that the controller uses read-ahead for the current logical drive.
- **Adaptive** specifies that the controller begins using read-ahead if the two most recent disk accesses occurred in sequential sectors. If all read requests are random, the algorithm reverts to No-Read-Ahead, however, all requests are still evaluated for possible sequential operation.

## 14 Set the Read Policy from the Advanced Menu.

**Cache Policy** applies to reads on a specific logical drive. It does not affect the **Read-ahead** cache.

- **Cached I/O** specifies that all reads are buffered in cache memory.



- **Direct I/O** specifies that reads are not buffered in cache memory. **Direct I/O** does not override the cache policy settings. Data is transferred to cache and the host concurrently. If the same data block is read again, it comes from cache memory. This is the default setting.

**15** Press <Esc> to exit the **Advanced Menu**.

**16** After you define the current logical drive, choose **Accept** and press <Enter>.

The array selection screen appears if any unconfigured disk drives remain.

**17** Repeat steps 3 through 16 to configure another array and logical drive.

PERC 3 supports up to forty logical drives per controller.

**18** If you are finished configuring logical drives, press <Esc> to exit **Easy Configuration**.

A list of the currently configured logical drives appears.

**19** Save the configuration at the prompt.

After you respond to the **Save** prompt, the **Configure** menu appears.

**20** Initialize the logical drives you have just configured.



**NOTE:** The PERC 3 family supports spanning across RAID 1 and 5 arrays only.

## Using New Configuration

The **New Configuration** option allows you to associate logical drives with multiple physical arrays (spanning of arrays.)



**NOTICE:** Choosing the **New Configuration** option *erases* the existing configuration information on the selected controller. To use the spanning feature and keep the existing configuration, use **View/Add Configuration**.

Perform the following steps to configure the arrays using **New Configuration**.

- 1** Choose **Configure**—> **New Configuration** from the **Management Menu**.

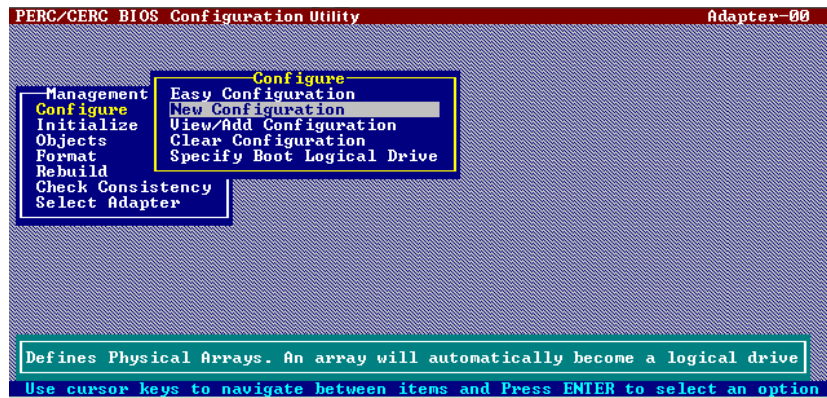

An array selection window displays the devices connected to the current controller. Hot key information appears at the bottom of the screen. The hot key functions are:

- <F2> Display drive data and PERC 3 error count for the selected drive.
- <F3> Display the logical drives that have been configured.
- <F4> Designate the selected drive as a hot spare.
- <F10> Display the logical drive configuration screen.

**NOTE:** Try to use drives of the same capacity in a specific array. If you use drives with different capacities in an array, all drives in the array are treated as if they have the capacity of the smallest drive in the array.

- 2 Press the arrow keys to choose specific physical drives.
- 3 Press the spacebar to associate the selected physical drive with the current array.

The indicator for the selected drive changes from **READY** to **ONLINE A**[array number]-[drive number]. For example, **ONLINE A2-3** means disk drive 3 in array 2.

- 4 Add physical drives to the current array as desired.

The number of physical drives in a specific array determines the RAID levels that can be implemented with the array.

- RAID 0 requires one or more physical drives per array.
- RAID 1 requires two physical drives per array.
- RAID 5 requires at least three physical drives per array.
- RAID 10 requires at least four physical drives per array.

- RAID 50 requires at least six physical drives per array.
- 5 Press <Enter> after you finish creating the current array.  
A window entitled **Select Configurable Array(s)** appears. It displays the array, and array number, such as A-00.

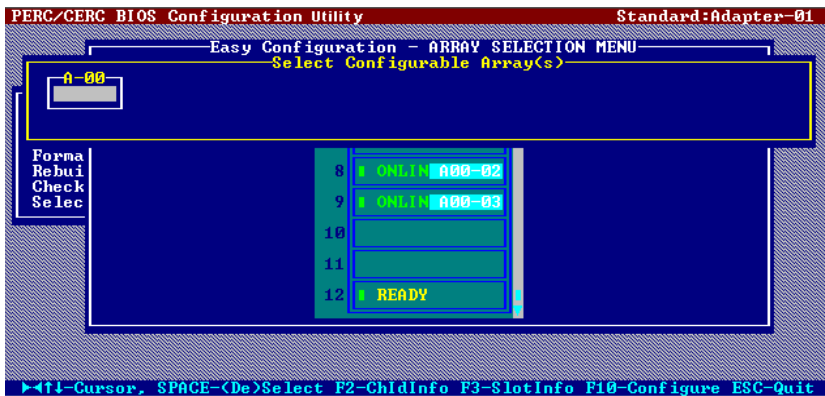

- 6 Press the spacebar to select the array.  
Span information, such as **Span-1**, displays in the array box. You can create multiple arrays, then select them to span them.

**NOTE:** You can press <F2> to display the number of drives in the array, their channel and ID, and <F3> to display array information, such as the stripes, slots, and free space.

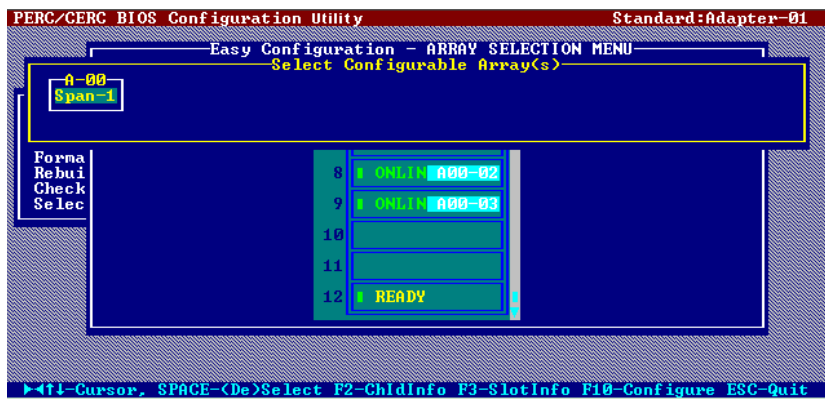

- 7 Press <F10> to configure a logical drive.

The logical drive configuration screen appears. **Span=Yes** displays on this screen if you select two or more arrays to span.

The window at the top of the screen shows the logical drive that is currently being configured as well as any existing logical drives. The column headings are:

- **LD:** The logical drive number
- **RAID:** The RAID level
- **Size:** The logical drive size
- **#Stripes:** The number of stripes (physical drives) in the associated physical array
- **StrpSz:** The stripe size
- **Drive-State:** The state of the logical drive

**8** Highlight **RAID** and press <Enter>.

A list of the available RAID levels for the current logical drive appears.

**9** Select a RAID level for the logical drive and press <Enter> to confirm.

See Chapter 3 for an explanation of the RAID levels.

**10** Set the spanning mode for the current logical drive.

**11** Highlight **Span** and press <Enter>.

The choices are:

- **CanSpan:** Array spanning is enabled for the current logical drive. The logical drive can occupy space in more than one array.
- **NoSpan:** Array spanning is disabled for the current logical drive. The logical drive can occupy space in only one array.

PERC 3 supports spanning of RAID 1 and 5 arrays only. You can span two or more contiguous RAID 1 logical drives into a RAID 10 array, and two or more contiguous RAID 5 logical drives into a RAID 50 array.

For two arrays to be spanned, they must have the same stripe width (they must contain the same number of physical drives) and must be consecutively numbered. For example, assuming Array 2 contains four disk drives, it can be spanned only with Array 1 and/or Array 3, and only if Arrays 1 and 3 also contain four physical drives. If the two criteria for spanning are met, PERC 3 automatically allows spanning. If

the criteria are not met, the span setting makes no difference for the current logical drive.

**12** Highlight a spanning option and press <Enter>.

**13** Set the logical drive size.

**14** Move the cursor to **Size** and press <Enter>.

By default, the logical drive size is set to all available space in the array(s) being associated with the current logical drive, accounting for the span setting.

**15** Open the **Advanced Menu** to set the remaining options:

**16** Set the **Stripe Size**.

**Stripe size** specifies the size of the segments written to each disk in a RAID 1 or 5 logical drive. You can set the stripe size to 2 KB, 4 KB, 8 KB, 16 KB, 32 KB, 64 KB, or 128 KB. A larger stripe size produces higher read performance, especially if your computer does mostly sequential reads. However, if you are sure that your computer does random read requests more often, select a small stripe size. The default stripe size is 64 KB.

**17** Set the **Write Policy**.

**Write Policy** sets the caching method to write-back or write-through.

- In **Write-back** caching, the controller sends a data transfer completion signal to the host when the controller cache has received all the data in a transaction. This setting is recommended in standard mode.
- In **Write-through** caching, the controller sends a data transfer completion signal to the host when the disk subsystem has received all the data in a transaction. This is the default setting in cluster mode.

**Write-through** caching has a data security advantage over **write-back** caching, whereas **write-back** caching has a performance advantage over **write-through** caching.

**18** Set the **Read Policy**.

**Read-ahead** This option enables the SCSI read-ahead feature for the logical drive. You can set this parameter to **No-Read-Ahead**, **Read-ahead**, or **Adaptive**. The default setting is **Adaptive**.

- **No-Read-Ahead** specifies that the controller does not use read-ahead for the current logical drive.
- **Read-ahead** specifies that the controller uses read-ahead for the current logical drive.
- **Adaptive** specifies that the controller begins using read-ahead if the two most recent disk accesses occurred in sequential sectors. If all read requests are random, the algorithm reverts to No-Read-Ahead, however, all requests are still evaluated for possible sequential operation. This is the default setting.

**19** Set the **Cache Policy**.

**Cache Policy** applies to reads on a specific logical drive. It does not affect the read ahead cache.

- **Cached I/O** specifies that all reads are buffered in cache memory.
- **Direct I/O** specifies that reads are not buffered in cache memory. This is the default setting. **Direct I/O** does not override the cache policy settings. Data is transferred to cache and the host concurrently. If the same data block is read again, it comes from cache memory.

**20** Press <Esc> to exit the **Advanced Menu**.

**21** After you define the current logical drive, choose **Accept** and press <Enter>.

If space remains in the arrays, the next logical drive to be configured appears.

**22** Repeat steps 3 to 22 to create an array and configure another logical drive.

If the array space has been used, a list of the existing logical drives appears.

**23** Press any key to continue and respond to the **Save** prompt.

**24** Initialize the logical drives you have just configured.

## Using View/Add Configuration

View/Add Configuration allows you to associate logical drives with physical arrays (this is called spanning of arrays.) The existing configuration is left intact, so you can also use **View/Add Configuration** simply to look at the current configuration. Perform the following steps to configure the arrays using **View/Add Configuration**.

- 1 Choose **Configure** from the **Management Menu**.

The **Configure** menu options display.

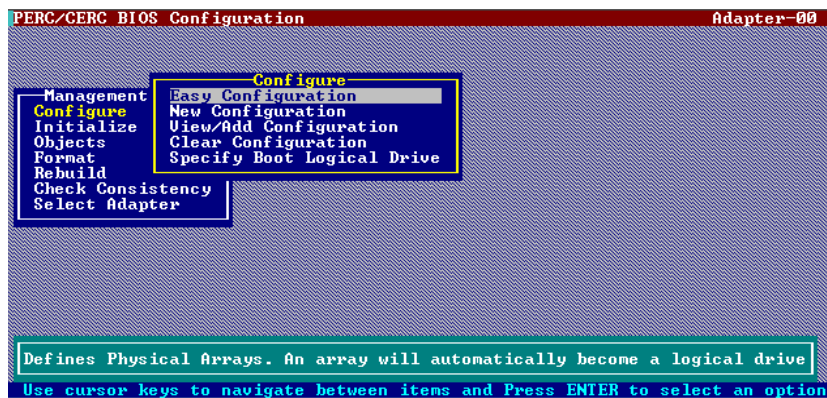

- 2 Choose **Configure**—> **View/Add Configuration**.

An array selection window displays the devices connected to the current controller.

Hot key information appears at the bottom of the screen. The hot key functions are:

- <F2> Display the manufacturer data and PERC 3 error count for the selected drive.
- <F3> Display the logical drives that have been configured.
- <F4> Designate the selected drive as a hot spare.
- <F10> Display the logical drive configuration screen.

**NOTE:** Try to use drives of the same capacity in a specific array. If you use drives with different capacities in an array, all drives in the array are treated as if they have the capacity of the smallest drive in the array.

**NOTE:** Dell does not recommend using RAID 0 in the cluster environment. RAID 0 is not redundant and provides no data protection.

- 3 Press the arrow keys to highlight specific physical drives.
- 4 Press the spacebar to associate the selected physical drive with the current array.

The indicator for the selected drive changes from **READY** to **ONLIN A[array number]-[drive number]**. For example, **ONLIN A2-3** means physical drive 3 in array 2.

- 5 Add physical drives to the current array as desired.

The number of physical drives in a specific array determine the RAID levels that can be implemented with the array.

- RAID 0 requires one or more physical drives per array.
- RAID 1 requires two physical drives per array.
- RAID 5 requires at least three physical drives per array.
- RAID 10 requires at least four physical drives per array.
- RAID 50 requires at least six physical drives per array.

- 6 Press <Enter> after you finish creating the current array.

A window entitled **Select Configurable Array(s)** appears. It displays the array, and array number, such as A-00.

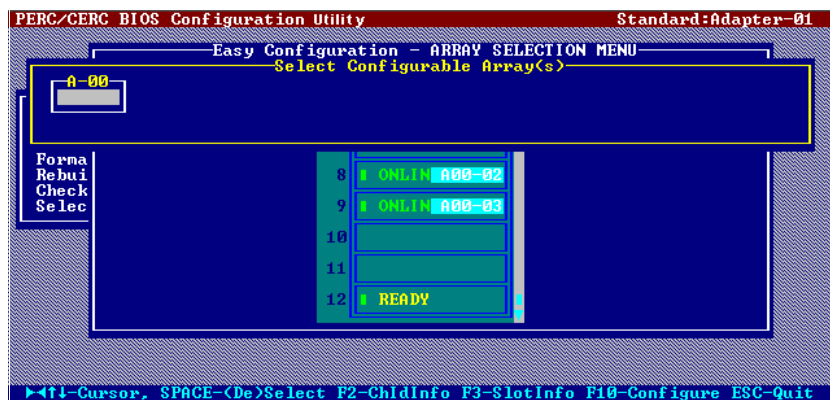

- 7 Press the spacebar to select the array.

Span information, such as **Span-1**, displays in the array box. You can create multiple arrays, then select them to span them.



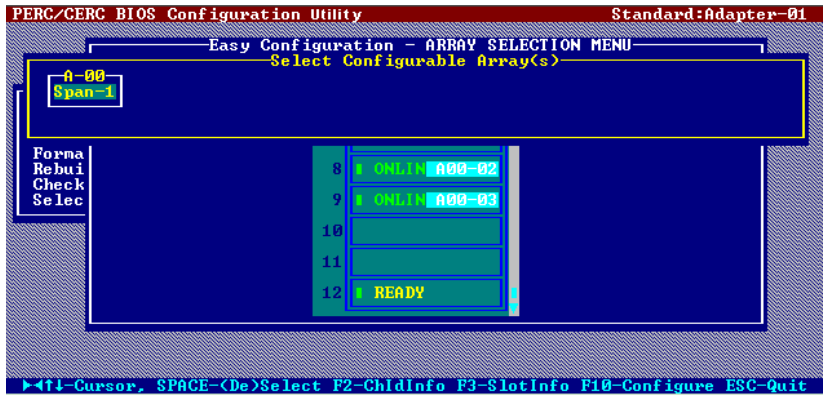

**NOTE:** You can press <F2> to display the number of drives in the array, their channel and ID, and <F3> to display array information, such as the stripes, slots, and free space.

- 8 Press <F10> to configure a logical drive.

The logical drive configuration screen appears. **Span=Yes** displays on this screen if you select two or more arrays to span.

The logical drive that is currently being configured and any existing logical drives are displayed. The column headings are:

- **LD:** The logical drive number
- **RAID:** The RAID level
- **Size:** The logical drive size
- **#Stripes:** The number of stripes (physical drives) in the associated physical array
- **StrpSz:** The stripe size
- **Drive-State:** The state of the logical drive

- 9 Highlight **RAID** and press <Enter>.

The available RAID levels for the current logical drive appear.

- 10 Select a RAID level for the logical drive and press <Enter> to confirm.

See Chapter 3 for an explanation of the RAID levels.

- 11 Set the spanning mode for the current logical drive. Highlight **Span** and press <Enter>.

The choices are:

- **CanSpan:** Array spanning is enabled for the current logical drive. The logical drive can occupy space in more than one array.
- **NoSpan:** Array spanning is disabled for the current logical drive. The logical drive can occupy space in only one array.

PERC 3 supports spanning for RAID 1 and RAID 5 arrays only. You can span two or more contiguous RAID 1 logical drives into a RAID 10 array, or two or more contiguous RAID 5 logical drives into a RAID 50 array.

For two arrays to be spanned, they must have the same stripe width (they must contain the same number of physical drives) and they must be consecutively numbered. For example, assuming Array 2 contains four disk drives, it can be spanned only with Array 1 and/or Array 3, and only if Arrays 1 and 3 also contain four physical drives.

If the two criteria for spanning are met, PERC 3 automatically activates spanning. If the criteria are not met, the span setting makes no difference for the current logical drive.

**12** Highlight a spanning option and press <Enter>.

**13** Set the logical drive size.

**14** Move the cursor to **Size** and press <Enter>.

By default, the logical drive size is set to all available space in the array(s) associated with the current logical drive, accounting for the span setting.

**15** Open the **Advanced Menu** to set the remaining options.

**16** Set the **Stripe Size**.

**Stripe size** specifies the size of the segment written to each disk in a RAID 1 or 5 logical drive. You can set the stripe size to 2 KB, 4 KB, 8 KB, 16 KB, 32 KB, 64 KB, or 128 KB. A larger stripe size produces higher read performance, especially if your computer does mostly sequential reads. However, if your computer does random read requests more often, choose a smaller stripe size. The default is 64 KB.

**17** Set the **Write Policy**.

**Write Policy** specifies the cache write policy. You can set the write policy to **Write-back** or **Write-through**:

- In **Write-back** caching, the controller sends a data transfer completion signal to the host when the controller cache has received all the data in a transaction. This setting is not recommended.
- In **Write-through** caching, the controller sends a data transfer completion signal to the host when the disk subsystem has received all the data in a transaction. This is the default setting for cluster mode.

**Write-through** caching has a data security advantage over **write-back** caching, whereas **write-back** caching has a performance advantage over **write-through** caching.

**18** Set the **Read Policy**.

**Read-ahead** enables the SCSI read-ahead feature for the logical drive. You can set this parameter to **No-Read-Ahead**, **Read-ahead**, or **Adaptive**. **Adaptive** is the default setting.

- **No-Read-Ahead** specifies that the controller does not use read-ahead for the current logical drive.
- **Read-ahead** specifies that the controller uses read-ahead for the current logical drive.
- **Adaptive** specifies that the controller begins using read-ahead if the two most recent disk accesses occurred in sequential sectors. If all read requests are random, the algorithm reverts to **No-Read-Ahead**, however, all requests are still evaluated for possible sequential operation.

**19** Set the **Read Policy**.

**Cache Policy** applies to reads on a specific logical drive. It does not affect the **Read-ahead** cache.

- **Cached I/O** specifies that all reads are buffered in cache memory.
- **Direct I/O** specifies that reads are not buffered in cache memory. This is the default setting.

**Direct I/O** does not override the cache policy settings. Data is transferred to cache and the host concurrently. If the same data block is read again, it comes from cache memory.

**20** Press <Esc> to exit the **Advanced Menu**.

**21** After you define the current logical drive, choose **Accept** and press <Enter>.

If space remains in the arrays, the next logical drive to be configured appears.

- 22 Repeat steps 3 to 21 to create an array and configure another logical drive.

If all array space is used, a list of the existing logical drives appears.

- 23 Press any key to continue.
- 24 Respond to the **Save** prompt.
- 25 Initialize the logical drives you have just configured.

## Initializing Logical Drives

Initialize each new logical drive you configure. You can initialize the logical drives using:

- *Batch Initialization.* The **Initialize** option on the **Management Menu** lets you initialize up to eight logical drives simultaneously.
- *Individual Initialization.* The **Objects—> Logical Drive** action menu for an individual logical drive has an **Initialize** option.

### Batch Initialization

To initialize logical drives using the batch initialization procedure:

- 1 Choose **Initialize** from the BIOS Configuration Utility **Management Menu**.

A list of the current logical drives appears.

- 2 Press the spacebar to select the desired logical drives for initialization or press <F2> to select/deselect all logical drives.

- 3 After you select the logical drives to initialize, press <F10>.

- 4 Select **Yes** from the confirmation prompt.

The progress of the initialization for each drive displays in bar graph format.

- 5 When initialization is complete, press any key to continue.
- 6 Press <Esc> to display the **Management Menu**.

## Individual Initialization

- 1 Choose **Objects**—> **Logical Drive** option from the **Management Menu**.
- 2 Select the logical drive to be initialized.
- 3 Choose **Initialize** from the action menu.  
Initialization progress appears as a bar graph on the screen.
- 4 When initialization completes, press any key to display the previous menu.

## Deleting Logical Drives (Random Array Deletion)

This RAID controller supports random array deletion. Random array deletion is the ability to delete any unwanted logical drives and use that space for a new logical drive.

The main benefit of random array deletion on the configuration module is that you are not restricted to sequential or contiguous logical drives when you create logical drives. You can use non-contiguous segments to create logical drives.

After you delete a logical drive, you can create a new one. You can use the configuration utilities to create the next logical drive from the non-contiguous free space ('holes'), and from the newly created arrays. The configuration utility provides a list of configurable arrays where there is a space to configure.

-  **NOTICE:** The deletion of the logical drive can fail under certain conditions. Deletion can fail during a rebuild, initialization or check consistency of a logical drive, if that drive has a higher logical drive number than the drive you want to delete.

Perform the following steps to delete logical drives:

- 1 Choose **Objects**—> **Logical Drive** from the **Management Menu**.  
The logical drives display.
- 2 Use the arrow key to highlight the logical drive you want to delete.
- 3 Press <F5> to delete the logical drive.

 **NOTE:** For more information about random array deletion, refer to page 99.

This deletes the logical drive and makes the space it occupied available for you to make another logical drive.

## Formatting Physical Drives

You can do low-level formatting of SCSI drives using the BIOS Configuration Utility. Because most SCSI disk drives are low-level formatted at the factory, this step is usually not necessary. Usually, you must format a disk if:

- The disk drive was not low-level formatted at the factory, or
- An excessive number of media errors have been detected on the disk drive.

### Media Errors

Perform the following steps to view the media errors for the drive to be formatted.

- 1 Select **Objects**—> **Physical Drives** from the **Management Menu**.
- 2 Select the **Physical Drives** option, and choose a device.
- 3 Press <F2>.

The **View Drive Information** screen displays. The error count displays at the bottom of the properties screen. If you feel that the number of errors is excessive, you should probably format the disk drive. If more than 32 media errors were detected, PERC 3 automatically puts the drive in **FAIL** state. This occurs even in a degraded RAID set. The errors display as they occur. When there are errors, formatting the drive can clear up the problem.

You do not have to choose **Format** to erase existing information on your SCSI disks, such as a DOS partition. That information is erased when you initialize logical drives.

### Formatting Drives

You can format the physical drives using:

- *Batch Formatting*. The **Format** option in the PERC 3 BIOS Configuration Utility main menu lets you format up to eight disk drives simultaneously.

- *Individual Formatting.* Choose the **Format** option from **Objects—> Physical Drive** action menu for a physical drive.

### **Batch Formatting**

- 1** Select **Format** from the **Management Menu**.

A device selection window displays the devices connected to the current controller.

- 2** Press the arrow keys to highlight the drives.
- 3** Press the spacebar to select the desired physical drives for formatting.

The indicators for the selected drives flashes.

- 4** After you select the physical drives, press <F10> and choose **Yes** from the confirmation prompt.

The indicators for the selected drives changes to FRMT[*number*], where *number* reflects the order of drive selection. Formatting may take some time, depending on the number of drives you have selected and the drive capacities.

- 5** When formatting is complete, press any key to continue.
- 6** Press <Esc> to display the **Management Menu**.

### **Individual Formatting**

- 1** Choose **Objects—> Physical Drive** from the **Management Menu**.

A device selection window displays the devices connected to the current controller.

- 2** Press the arrow keys to select the physical drive to be formatted, then press <Enter>.

- 3** Choose the **Format** option.

Formatting can take some time, depending on the drive capacity.

- 4** When formatting completes, press any key to display the previous menu.

## Rebuilding Failed Disk Drives

If a disk drive fails in an array that is configured as a RAID 1 or 5 logical drive, you can recover the lost data by rebuilding the drive. Table 11-10 describes the types of rebuilds.

**Table 11-10. Rebuild Types**

Type	Description
Automatic Rebuild	If you have configured hot spares, PERC 3 automatically tries to use them to rebuild failed disks. Display the <b>Objects—&gt; Physical Drive</b> screen while a rebuild is in progress. The drive indicator for the hot spare disk drive has changed to REBLD A[ <i>array number</i> ]-[ <i>drive number</i> ], indicating the disk drive being replaced by the hot spare.
Manual Rebuild	Manual rebuild is necessary if no hot spares with enough capacity to rebuild the failed drives are available. Select <b>Rebuild</b> on the <b>Management Menu</b> or <b>Rebuild</b> on the <b>Objects—&gt; Physical Drive</b> menu.

### Manual Rebuild – Rebuilding an Individual Drive

Perform the following steps to rebuild an individual drive.

- 1 Choose **Objects—> Physical Drive** from the **Management Menu**.  
A device selection window displays the devices connected to the current controller.
- 2 Press the arrow keys to select the physical drive to rebuild, then press <Enter>.
- 3 Choose **Rebuild** from the action menu and respond to the confirmation prompt.  
Rebuilding can take some time, depending on the drive capacity.
- 4 When rebuild completes, press any key to display the previous menu.

### Manual Rebuild – Batch Mode

Perform the following steps to rebuild drives in batch mode.

- 1 Choose **Rebuild** from the **Management Menu**.



A device selection window displays the devices connected to the current controller. The failed drives have **FAIL** indicators.

- 2 Press the arrow keys to highlight any failed drives to be rebuilt.,
- 3 Press the spacebar to select the desired physical drives for rebuild.
- 4 After you select the physical drives, press <F10>.
- 5 Select **Yes** at the prompt.

The indicators for the selected drives change to **REBLD**. Rebuilding can take some time, depending on the number of drives selected and the drive capacities.

- 6 When rebuild is complete, press any key to continue.
- 7 Press <Esc> to display the **Management Menu**.

## Using a Pre-loaded SCSI Drive “As-is”

You may have a SCSI hard drive that is already loaded with software. The drive may be a boot disk containing an operating system. If so, add the PERC device driver to this system drive before you switch to the PERC 3 and attempt to boot from it. You can use the PERC 3 controller as a SCSI adapter for such a drive by performing the following steps.

- 1 Connect the SCSI drive to the channel on the PERC 3 controller, with proper termination and TID settings.
- 2 Boot the computer.
- 3 Press <Ctrl><M> to start the BIOS Configuration Utility.
- 4 Select **Configure**—> **Easy Configuration**.
- 5 Press the cursor keys to select the pre-loaded drive.
- 6 Press the spacebar.

The pre-loaded drive should now become an array element.

- 7 Press <Enter>.

You have now declared the pre-loaded drive as a one-disk array. The logical drive configuration screen displays.

- 8 Set the **Read Policy** on the **Advanced Menu**.
- 9 Set the **Cache Policy** on the **Advanced Menu**.



**NOTE:** To use a pre-loaded system drive in the manner described here, you must make it the first logical drive defined (for example: LD1) on the controller it is connected to. This will make the drive ID 0 LUN 0. If the drive is not a boot device, the logical drive number is not critical.

- 10 Press <Esc> to exit the **Advanced Menu**.  
You are prompted to accept the settings.
- 11 Highlight **Accept** and press <Enter>.  
Do not initialize the logical drive.
- 12 Press <Esc>. and choose **Yes** at the **Save** prompt.
- 13 Exit the BIOS Configuration Utility.
- 14 Reboot the system.
- 15 Set the host system to boot from SCSI, if such a setting is available.

## Exiting the PERC 3 BIOS Configuration Utility

Perform the following steps to exit the BIOS Configuration Utility.

- 1 Press <Esc> when the **Management Menu** displays.
- 2 Choose **Yes** at the prompt.
- 3 Reboot the computer.  
The PERC 3 BIOS message appears again.
- 4 Press <Esc> when the BIOS Configuration Utility prompt appears.

## Setting Hardware Termination

If you are using the PERC 3/DC for clustering, you must use hardware termination. Otherwise, software termination may be used. The headers used for SCSI termination are:

- J2 Termination Enable is a three-pin header that specifies control of the SCSI termination for channel 0.
- J3 Termination Enable is a three-pin header that specifies control of the SCSI termination for channel 1.
- J5 Termination Enable is a three-pin header that specifies control of the SCSI termination for channel 2.
- J7 Termination Enable is a three-pin header that specifies control of the SCSI termination for channel 3.

To enable hardware termination, leave the pins open. The default is hardware termination.

## Clustering

Physically, a cluster is a grouping of two independent servers that can access the same data storage and provide services to a common set of clients. With current technology, this usually means servers connected to common I/O buses and a common network for client access.

Logically, a cluster is a single management unit. Any server can provide any available service to any authorized client. The servers must have access to the same data and must share a common security model. Again, this generally means that the servers in a cluster will have the same architecture and run the same version of the same operating system.

### Cluster Mode

You can use the PERC BIOS Configuration Utility to enable or disable cluster mode. When you enable cluster mode, the system operates in cluster mode. When you disable cluster mode, the system operates in standard mode. The following section explains how to do this.

### Enabling and Disabling the Cluster Mode

You can enable or disable cluster mode. When you enable cluster mode, the system automatically disables the BIOS. If any of the controllers are set for clustering, the following warning appears when you press <Ctrl> <M> to access the BIOS Configuration Utility:

```
!!!STOP!!!
```

This operation may change the configuration of disks and can cause loss of data! Ensure:

1. Peer server is powered up for its controller NVRAM to be updated. Otherwise, disk configuration should be read from disk and saved to the controller's NVRAM.
2. The second server must not be configuring the disks.
3. There is no I/O activity against shared drives.
4. Press Any Key to Continue.

 **NOTE:** Clustering is not supported by PERC 3/QC, PERC 3/DCL or PERC 3/SC. It is supported by PERC 3/DC.

 **NOTE:** You can ignore this section on enabling and disabling cluster mode if you do not use clustering.

After you start the BIOS configuration utility, perform the following steps to enable or disable the cluster mode:

**1** Select **Objects**—> **Adapter**—> **Cluster Mode**.

**2** Select **Enable** or **Disable**.

After you select **Disable** or **Enable**, a dialog box displays for you to confirm your choice to change the parameter. If **Cluster Mode** is enabled and you select **Disable**, a warning against connecting to shared cluster storage appears, and the dialog box asks whether you want to continue.

If you select **YES** to disable, **Cluster Mode** is disabled, and the **Initiator ID** is set to 7.

**3** Reboot your system after the cluster mode is disabled.

**4** To change **Cluster Mode** from disabled to enabled, select **Cluster Mode**.

A dialog box displays for you to choose to enable **Cluster Mode**.

**5** Select **Enable**.

After you select **Enable**, a dialog box displays for you to confirm your choice to change the parameter.

**6** Select **Yes** to confirm.

**Cluster Mode** changes to enabled.

**7** After you enable **Cluster Mode**, move the cursor to **Initiator ID** to change the **Initiator ID**.

**8** Press <Enter>.

**9** At the **Change Initiator ID** dialog box, select **Yes**.

You can change the **Initiator ID** only when you are in cluster mode. You cannot change the ID while in standard mode. The ID can be a number from 0 to 15. It is recommended that you use 6 or 7. When you are in standard mode, the ID is always 7.

After you change the **Initiator ID**, the system prompts you to reboot.

**10** Reboot the system.

After you reboot, the **Adapter** menu displays the new **Initiator ID**.

## SECTION 12

# Dell Manager

---

[Starting Dell Manager](#)

[Dell Manager Menu Options](#)

[Designating Drives as Hot Spares](#)

[Parameters](#)

[Initializing Logical Drives](#)

[Deleting Logical Drives \(Random Array Deletion\)](#)

[Formatting Physical Drives](#)

[Rebuilding Failed Disk Drives](#)

[Exiting Dell Manager](#)

## Starting Dell Manager

Dell™ Manager is a character-based, non-GUI utility that changes policies, and parameters, and monitors RAID systems. Dell Manager runs under Novell® NetWare® 5.x, 6.x, and Red Hat Linux 7.x.

To start Dell Manager from any directory, make sure the program file is in the usr/sbin directory. Type the command shown in Table 12-1.

**Table 12-1. Command Used to Start Dell Manager**

In...	Type this:
Red Hat Linux, Novell NetWare	Dellmgr

The first Dell Manager screen displays the Management Menu.

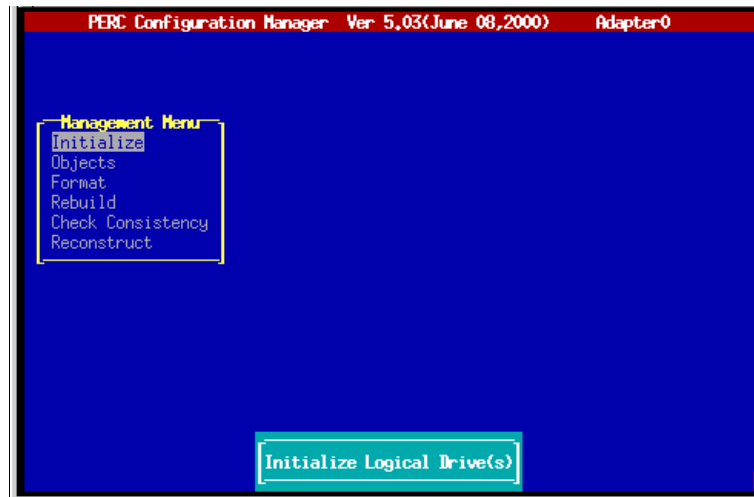

## Management Menu Options

Table 12-2 displays the options for the Dell Manager **Management Menu**.

**Table 12-2. Management Menu Options**

Option	Description
Initialize	Select this option to initialize one or more logical drives.
Objects	Select this option to individually access controllers, logical drives, and physical drives.
Format	Select this option to low-level format physical drives.
Rebuild	Select this option to rebuild failed physical drives.
Check Consistency	Select this option to verify redundancy data in logical drives using RAID level 1 or 5. PERC 3 automatically corrects any differences found in the data.
Reconstruct	Select this option to reconstruct an array.

## Using Dell Manager in Red Hat Linux GUI Mode

On a Red Hat Linux system, for Dell Manager to work correctly in a terminal in GUI Mode, you must:

- Set the terminal type to linux.
- Set the keyboard mappings to linux.

Perform the procedure in this section if you use konsole, gnome terminal, or xterm.

The linux console mode, which you select from the terminal with the **File—> Linux Console** command, works correctly by default. The text mode console (non-GUI) also works correctly by default.

Perform the following steps to prepare the system to use Dell Manager in Red Hat Linux GUI mode:

- 1 Start the Terminal.
- 2 Before you enter *dellmgr* to start Dell Manager, type the following commands:

```
TERM=linux
Export TERM
```

- 3 Select **Settings**→**Keyboard**→**Linux Console** from the Terminal menu.

## Dell Manager Menu Options

The following sections list the menu and sub-menu options available from the Dell Manager **Management Menu**.

### Initialize Menu

Choose **Initialize** from the Dell Manager **Management Menu** to initialize one or more logical drives. This action typically follows the configuration of a new logical drive.

### Objects Menu

Choose **Objects** from the Dell Manager **Management Menu** to access the controllers, logical drives, physical drives, and SCSI channels individually. You can also change certain settings for each object. The **Objects** menu options are described in Table 12-3.

### Adapter

Select **Objects**→**Adapter** select a PERC controller (if your computer has more than one) and modify parameters. You can install only one PERC 3 controller, but you can install other PERC controllers in the computer.

Table 12-3 displays the **Adapter** menu options.

**Table 12-3. Adapter Menu Options**

Option	Description
FlexRAID PowerFail	Select this option to allow drive reconstruction to continue when the system restarts if a power failure occurs. This will reduce the size of the logical drive by [1 MB times the number of drives in the logical drive].
Disk Spin up Timings	Select this option to set the method and timing for spinning up the hard drives in the computer.
Alarm Control	Select this option to enable, disable, or silence the onboard alarm tone generator.



**Table 12-3. Adapter Menu Options (continued)**

<b>Option</b>	<b>Description</b>
View/Update Parameters	Select this option to display the firmware version number and the cache memory size. You can also change the rebuild rate for the adapter through this option.
Adapter Type	The model of adapter that is being used.

### **Logical Drive**

Choose **Objects**—> **Logical Drive** to select a logical drive and to perform the actions described in Table 12-4.

**Table 12-4. Logical Drive Menu Options**

<b>Option</b>	<b>Description</b>
Initialize	Select this option to initialize the selected logical drive. This should be done for every logical drive you configure.
Check Consistency	Select this option to verify the correctness of the redundancy data in the selected logical drive. This option is available only if RAID level 1 or 5 is used. PERC 3 automatically corrects any differences found in the data.
View/Update Parameters	Select this option to display the properties of the selected logical drive. You can modify the cache write policy, the cache read policy, virtual sizing and the I/O policy from this menu.  <b>Virtual Sizing:</b> Set this option to <b>Enabled</b> before adding a physical drive to a logical drive. After you have created a logical drive set, the partition of the drive should be as large as the virtual size of the logical drive.

### **Logical Drive Settings**

Table 12-5 displays the default logical drive settings. You can change the write policy, read policy, and cache policy after configuration is complete.

**Table 12-5. Logical Drive Default Settings**

<b>Parameter</b>	<b>Setting</b>
Stripe Size	64 KB
Write Policy	Write-back

**Table 12-5. Logical Drive Default Settings**

Parameter	Setting
Read Policy	Adaptive Readahead
Cache Policy	Direct I/O
Spanning	Off

**Physical Drive**

Select **Objects**—> **Physical Drive** to select a physical device and to perform the operations listed in Table 12-5. When you choose this option, the physical drives in the system are listed. Move the cursor to the desired device and press <Enter> to display the options for physical drives.

**Physical Drive Menu**

Table 12-6 displays the options in the physical drive menu.

**Table 12-6. Physical Drive Menu Options**

Option	Description
Rebuild	Choose this option to rebuild the selected physical drive.
Format	Choose this option to low-level format the selected physical drive.
Force Online	Choose this option to change the state of the selected physical drive to online.
Force Offline	Choose this option to change the state of the selected physical drive to offline.
Prepare to Remove	Choose this option before you remove a physical drive from an array.
Make HotSpare	Choose this option to designate the selected physical drive as a hot spare.
View Drive Information	Choose this option to see the manufacturer data for the selected physical device.
View Rebuild Progress	Choose this option to see the progress of the rebuild process for the selected physical drive.

### SCSI Channel

Choose **Objects**—> **SCSI Channel** to select a SCSI channel on a controller. Table 12-7 displays the operations you can perform on the selected channel.

**Table 12-7. SCSI Channel Options**

Option	Description
State	Choose this option to enable termination.
Termination	Choose this option to set the type of termination.

### Battery Backup

Choose **Objects**-> **Battery Backup** to view the battery backup information. You can use the battery backup menu to reset the charge cycle count. Table 12-8 displays the menu items.

**Table 12-8. Battery Backup Menu Items**

Menu Item	Explanation
Backup Module	<b>PRESENT</b> will appear if there is a battery module; <b>ABSENT</b> if there is not.
Battery Pack	<b>PRESENT</b> will appear if the battery pack is properly installed; <b>ABSENT</b> if it is not.
Temperature	<b>GOOD</b> appears if the temperature is within the normal range. <b>HIGH</b> appears if the module is too hot.
Voltage	<b>GOOD</b> appears if the voltage is within the normal range. <b>BAD</b> appears if the voltage is out of range.
Fast Charging	<b>COMPLETED</b> appears if the fast charge cycle is done. <b>CHARGING</b> appears if the battery pack is charging.

**Table 12-8. Battery Backup Menu Items (continued)**

Menu Item	Explanation
No of Cycles	This must be configured. When first installing a battery pack, set the <b>Charge Cycle</b> to 0. The dialog box below appears when you select <b>No of Cycles</b> . Choose <b>YES</b> to reset the number of cycles to zero and press <Enter>.

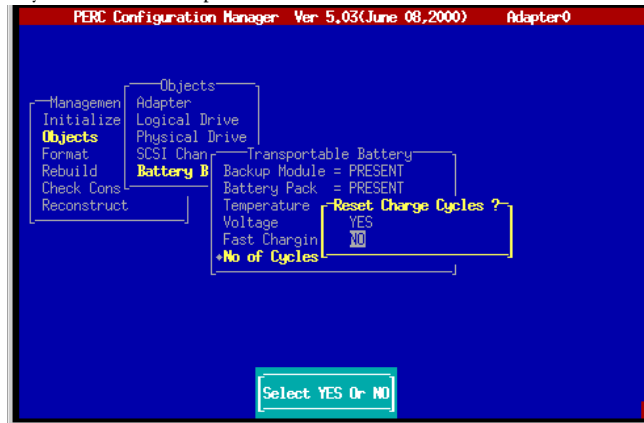

After 1100 charge cycles, the life of the battery pack is assumed to be over, and you must replace it.

### Format Menu

Choose **Format** from the Dell Manager **Management Menu** to low-level format one or more physical drives.

Because most SCSI disk drives are low-level formatted at the factory, this step is usually not necessary. You typically must format a disk if:

- The disk drive was not low-level formatted at the factory, or
- An excessive number of media errors has been detected on the disk drive.

You do not need to use the **Format** option if you simply want to erase existing information on your SCSI disks, such as a DOS partition. That information is erased when you initialize the logical drive(s).

## Rebuild Menu

Choose **Rebuild** from the **Management Menu** to rebuild one or more failed disk drives.

## Check Consistency Menu

Choose this option to verify the redundancy data in logical drives using RAID levels 1 or 5. When you choose **Check Consistency**, the parameters of the existing logical drives on the current controller appear. The logical drives are listed by number. PERC 3 automatically corrects any differences found in the data. Perform the following steps to run a consistency check.

- 1 Press the arrow keys to select the desired logical drives.
- 2 Press the spacebar to select or deselect a drive for the consistency check.
- 3 Press <F2> to select or deselect all the logical drives.
- 4 Press <F10> to begin the consistency check.  
A progress indicator for each selected logical drive appears.
- 5 When the consistency check is finished, press any key to clear the progress display.
- 6 Press <Esc> to display the **Management Menu**.

## Reconstruct Menu

You can select or deselect a logical drive to be recreated using this option. Choose this option before you add or remove a physical drive.

# Designating Drives as Hot Spares

Hot spares are physical drives that are powered up along with the RAID drives and usually stay in a standby state. If a physical drive used in a RAID logical drive fails, a hot spare will automatically take its place and the data on the failed drive is reconstructed on the hot spare. Hot spares can be used for RAID levels 1 and 5. Each PERC 3 controller supports up to eight hot spares. See Chapter 2 "Introduction to RAID" for an explanation of hot spares.

Perform the following steps to designate physical drives as hot spares:

- 1 Select **Objects**—> **Physical Drive** and press <Enter>. The **Physical Drive Selection Menu** displays.
- 2 Highlight a drive on the **Physical Drive Selection Menu** using the arrow keys and press <Enter>. The action menu for the physical drive displays.
- 3 Use the arrow key to select **Make HotSpare**, then press <Enter>. The indicator for the selected physical drive changes to **HOTSP**.

## Parameters

The parameters contain the settings for the stripe size, write policy, read policy and cache policy. The policies and default settings are described in the following information.

- **Stripe Size** specifies the size of the segment written to each disk in a RAID 1 or 5 logical drive. You can set the stripe size to 2 KB, 4 KB, 8 KB, 16 KB, 32 KB, 64 KB, or 128 KB. A larger stripe size produces better read performance, especially if your computer does mostly sequential reads. If you are sure that your computer does random reads more often, select a small stripe size. The default stripe size is 64 KB.
- **Write Policy** specifies the cache write policy. You can set the write policy to write-back or write-through.
  - In **Write-back** caching, the controller sends a data transfer completion signal to the host when the controller cache has received all the data in a transaction. This is the default setting.
  - In **Write-through** caching, the controller sends a data transfer completion signal to the host when the disk subsystem has received all the data in a transaction.

**Write-through** caching has a data security advantage over **write-back** caching. **Write-back** caching has a performance advantage over **write-through** caching.
- **Read Policy** specifies that the SCSI read-ahead feature is used for the logical drive. You can set this parameter to **Normal**, **Read-ahead**, or **Adaptive**. The default setting is **Adaptive**.
  - **Normal** specifies that the controller does not use read-ahead for the current logical drive.

- **Read-ahead** specifies that the controller uses read-ahead for the current logical drive.
- **Adaptive** specifies that the controller begins using read-ahead if the two most recent disk accesses occurred in sequential sectors. If all read requests are random, the algorithm reverts to **Normal**, however, all requests are still evaluated for possible sequential operation.
- **Cache Policy** applies to reads on a specific logical drive. It does not affect the **Read-ahead** cache.
  - **Cached I/O** specifies that all reads are buffered in cache memory.
  - **Direct I/O** specifies that reads are not buffered in cache memory. This is the default setting. **Direct I/O** does not override the cache policy settings. Data is transferred to cache and the host concurrently. If the same data block is read again, it comes from cache memory.

## Initializing Logical Drives

You should initialize each new logical drive you configure. You can initialize the logical drives in two ways:

- *Batch Initialization.* The **Initialize** option on the **Management Menu** lets you initialize up to eight logical drives simultaneously.
- *Individual Initialization.* The **Objects—> Logical Drive** action menu for an individual logical drive has an **Initialize** option.

### Batch Initialization

Perform the following steps to initialize more than one logical drive.

- 1 Select **Initialize** from the Dell Manager **Management Menu**.  
A list of the current logical drives appears.
- 2 Press the arrow keys to highlight the drives to be initialized.
- 3 Press the spacebar to select the desired logical drives for initialization or press <F2> to select or deselect all the logical drives.
- 4 After you select the logical drives, press <F10>.
- 5 Select **Yes** at the confirmation prompt.

The progress of the initialization for each drive displays in bar graph format.

- 6 When initialization is complete, press any key to continue.
- 7 Press <Esc> to display the **Management Menu**.

### Individual Initialization

Perform the following steps to initialize one logical drive.

- 1 Select **Objects**—> **Logical Drive**.
- 2 Select the logical drive to be initialized.
- 3 Choose **Initialize** from the action menu.

The progress of the initialization displays as a graph on the screen.

- 4 When initialization completes, press any key to display the previous menu.

## Deleting Logical Drives (Random Array Deletion)

This RAID controller supports random array deletion. Random array deletion is the ability to delete any unwanted logical drives and use that space for a new logical drive.

 **NOTE:** For more information about random array deletion, refer to page 99.

The main benefit of random array deletion on the configuration module is that you are not restricted to sequential or contiguous logical drives when you create logical drives. You can use non-contiguous segments to create logical drives.

After you delete a logical drive, you can create a new one. You can use the configuration utilities to create the next logical drive from the non-contiguous free space ('holes'), and from the newly created arrays. The configuration utility provides a list of configurable arrays where there is a space to configure.

 **NOTICE:** The deletion of the logical drive can fail under certain conditions. You cannot delete a logical drive during a reconstruction. Deletion can fail during a rebuild, initialization or check consistency of a logical drive, if that drive has a higher logical drive number than the drive you want to delete.



Perform the following steps to delete logical drives:

- 1 Choose **Objects**—> **Logical Drive**.

The logical drives display.

- 2 Use the arrow key to highlight the logical drive you want to delete.
- 3 Press <F5> to delete the logical drive.

This deletes the logical drive and makes the space it occupied available for you to make another logical drive.

## Formatting Physical Drives

You can do low-level formatting of SCSI drives using Dell Manager. Because most SCSI disk drives are low-level formatted at the factory, this step is usually not necessary. You typically must format a disk if:

- The disk drive was not low-level formatted at the factory, or
- An excessive number of media errors have been detected on the disk drive.

### Media Errors

Perform the following steps to check the properties screen for media errors for the drive you wish to format.

- 1 Select **Physical Drive**—> **Objects**.
- 2 Press the arrow keys to select the desired drive.
- 3 Press <F2>.

The error count appears at the bottom of the properties screen. If you feel that the number of errors is excessive, you should probably format the disk drive. If more than 32 media errors were detected, PERC 3 automatically puts the drive in **FAIL** state. In that case, formatting the drive can clear up the problem.

You do not have to use the **Format** option to erase existing information on your SCSI disks, such as a DOS partition. That information is erased when you initialize logical drives.

## Formatting Drives

You can format the physical drives using:

- *Batch Formatting* The **Format** option in the Dell Manager **Management Menu** lets you format up to eight disk drives simultaneously.
- *Individual Formatting*. Choose the **Format** option from the **Objects—> Physical Drive** options menu for an individual disk drive.

### Batch Formatting

- 1 Choose **Format** on the **Management Menu**.

A device selection window displays the devices connected to the current controller.

- 2 Press the arrow keys to select the drives to be formatted.

The indicators for selected drives flash.

- 3 When you have selected the physical drives, press <F10>.

- 4 Select **Yes** to the confirmation prompt to begin formatting.

The indicators for the selected drives change to **FRMT**[*number*], where *number* reflects the drive selection order. Formatting can take some time, depending on the number of drives you have selected and the drive capacities.

- 5 When formatting is complete, press any key to continue.

- 6 Press <Esc> to display the **Management Menu**.

### Individual Formatting

- 1 Select **Objects—> Physical Drive** on the **Management Menu**.

A device selection window displays the devices connected to the current controller.

- 2 Press the arrow keys to select the physical drive to be formatted and press <Enter>.

The physical drive action menu displays.

- 3 Choose the **Format** option from the physical drive action menu and respond to the confirmation prompt.

Formatting can take some time, depending on the drive capacity.

- 4 When formatting completes, press any key to display the previous menu.

## Rebuilding Failed Disk Drives

If a physical drive fails in an array configured as a RAID 1 or 5 logical drive, you can recover the lost data by rebuilding the drive. If a rebuilding spare fails, a new rebuild is started using a second spare, if available. The capacity of the second spare must be equal to or greater than the failed drive.

Table 12-9 describes the rebuild types.

**Table 12-9. Rebuild Types**

Type	Description
Automatic Rebuild	If you have configured hot spares, PERC 3 automatically tries to use them to rebuild failed disks. Display the <b>Objects—&gt; Physical Drive</b> screen while a rebuild is in progress. The drive indicator for the hot spare disk drive has changed to <b>REBLD A[<i>array number</i>]-[<i>drive number</i>]</b> , indicating the disk drive being replaced by the hot spare.
Manual Rebuild	Manual rebuild is necessary if no hot spares with enough capacity to rebuild the failed drives are available. Select the <b>Rebuild</b> option on the <b>Management Menu</b> or the <b>Objects—&gt; Physical Drive</b> menu.

### Manual Rebuild – Rebuilding an Individual Drive

Perform the following steps to rebuild one drive:

- 1 Choose **Objects—> Physical Drive** on the **Management Menu**.  
A window displays the devices connected to the current controller.
- 2 Press the arrow keys to select the physical drive to be rebuilt and press <Enter>.
- 3 Choose **Rebuild** from the physical drive action menu and respond to the confirmation prompt.  
Rebuilding can take some time, depending on the drive capacity.
- 4 When rebuild completes, press any key to display the previous menu.

## Manual Rebuild – Batch Mode

Perform the following steps to rebuild more than one drive:

- 1 Choose **Rebuild** from the **Management Menu**.

A device selection window displays the devices connected to the current controller. The failed drives have **FAIL** indicators.

- 2 Press the arrow keys to select the drives to be rebuilt.

- 3 After you select the physical drives, press <F10>.

- 4 Type **Yes** at the confirmation prompt.

The indicators for the selected drives change to **REBLD**. Rebuilding can take some time, depending on the number of drives you have selected and their capacities.

- 5 When rebuild is complete, press any key to continue.

- 6 Press <Esc> to display the **Management Menu**.

## Exiting Dell Manager

To exit Dell Manager, press <Esc> from the main menu and choose **Yes** at the prompt. A message appears if uninitialized logical drives remain in the system.

# 13

SECTION 13

## Troubleshooting

---

[Overview](#)

[BIOS Boot Error Messages](#)

[Other BIOS Error Messages](#)

[Other Potential Problems](#)

[Audible Warnings](#)

## Overview

This chapter describes the problems that you might encounter during installation and use of PERC, and how to resolve them. Table 13-1 describes general problems you might encounter.

**Table 13-1. General Problems and Suggested Solutions**

<b>Problem</b>	<b>Suggested Solution</b>
Some operating systems do not load in a computer with a PERC 3 adapter.	Check the system basic input/output system (BIOS) configuration for PCI interrupt assignments. Make sure a unique interrupt is assigned for PERC 3. Initialize the logical drive before installing the operating system.
One of the hard drive in the array fails often.	Check the drive error counts. Format the drive. Rebuild the drive. If the drive continues to fail, replace the drive with another drive with the same capacity. Also, check the SCSI cables.
Pressed <Ctrl> <M> and tried to make a new configuration. The system hangs when scanning devices.	Check the drives IDs on each channel to make sure each device has a different ID. Check the termination. The device at the end of the channel must be terminated. Replace the drive cable.
Multiple drives connected to PERC 3 using the same power supply. There is a problem spinning the drives all at once.	Set the drives to spin on command. This will allow PERC 3 to spin two devices simultaneously.
Pressing <Ctrl> <M> does not display a menu.	These utilities require a color monitor.
At system power-up with the PERC 3 installed, the PERC 3 BIOS banner display is garbled or does not appear at all.	PERC 3 cache memory may be defective or missing.
Cannot flash or update the EEPROM.	Contact Dell™ support.

**Table 13-1. General Problems and Suggested Solutions**

<b>Problem</b>	<b>Suggested Solution</b>
The following displays: Firmware Initializing...	<p>Make sure that termination power (TERMPWR) is being properly provided to each peripheral device- populated channel.</p> <p>Make sure that each end of the SCSI channel chain is properly terminated using the recommended terminator type for the peripheral device. The channel is automatically terminated at the PERC 3 card if only one cable is connected to a channel.</p> <p>Make sure that the PERC 3 controller is properly seated in the PCI slot.</p>
Why does a failed logical array still get a drive assignment?	To maintain the integrity of the DOS path statement.

## BIOS Boot Error Messages

Table 13-2 explains the error messages that can display when there is an error during bootup.

**Table 13-2. BIOS Boot Error Messages**

<b>Message</b>	<b>Problem</b>	<b>Suggested Solution</b>
Adapter BIOS Disabled. No Logical Drives Handled by BIOS	The PERC 3 BIOS is disabled. Sometimes the BIOS is disabled to prevent booting from the BIOS. This is the default when cluster mode is enabled.	Enable the BIOS by pressing <Ctrl> <M> at the boot prompt to run the BIOS Configuration Utility.
Host Adapter at Baseport xxxx Not Responding	The BIOS cannot communicate with the adapter firmware.	Make sure PERC 3 is properly installed. Check SCSI termination and cables.
No PERC 3 Adapter	The BIOS cannot communicate with the adapter firmware.	Make sure PERC 3 is properly installed.

**Table 13-2. BIOS Boot Error Messages (continued)**

<b>Message</b>	<b>Problem</b>	<b>Suggested Solution</b>
Configuration of NVRAM and drives mismatch. Run View/Add Configuration option of PERC 3 BIOS Configuration Utility.  Press any key to run the Configuration Utility.	The configuration stored in the PERC 3 adapter does not match the configuration stored in the drives.	Press <Ctrl><M> to run the BIOS Configuration Utility. Choose <b>Configure—&gt; View/Add Configuration</b> to examine both the configuration in non-volatile random access memory (NVRAM) and the configuration stored on the hard drives. Resolve the problem by selecting one of the configurations.
Unresolved configuration mismatch between disks and NVRAM on the adapter after creating a new configuration	Some legacy configurations in the drives cannot be cleared.	Clear the configuration.  Low-level format the related drives and re-create the configuration.
1 Logical Drive Failed	A logical drive failed to sign on.	Make sure all physical drives are properly connected and are powered on. Run the BIOS Configuration Utility to find out if any physical drives are not responding. Reconnect, replace, or rebuild any drive that is not responding.
TBBU Cache-data seems to be INVALID for current adapter.	The data on the transportable battery backup (TBBU) unit is not valid for the current controller.	Power off and put the TBBU on the proper adapter. Or if you want to discard the Cache-data and proceed, press Y.



**Table 13-2. BIOS Boot Error Messages (continued)**

<b>Message</b>	<b>Problem</b>	<b>Suggested Solution</b>
X Logical Drives Degraded	x number of logical drives signed on in a degraded state.	Make sure all physical drives are properly connected and are powered on. Run the BIOS Configuration Utility to find whether any physical drives are not responding. Reconnect, replace, or rebuild a drive that is not responding.
1 Logical Drive Degraded	A logical drive signed on in a degraded state.	Make sure all physical drives are properly connected and are powered on. Run the BIOS Configuration Manager to find out if any physical drives are not responding. Reconnect, replace, or rebuild any drive that is not responding.
Insufficient memory to run BIOS. Press any key to continue...	Not enough PERC 3 memory to run PERC 3 BIOS.	Make sure PERC 3 cache memory has been properly installed.
Insufficient Memory	Not enough memory on the PERC 3 adapter to support the current configuration.	Make sure PERC 3 cache memory has been properly installed.
The following SCSI IDs are not responding: Channel x:a.b.c	The physical drives with SCSTO IDs a, b, and c are not responding on SCSI channel x.	Make sure the physical drives are properly connected and are powered on.

## Other BIOS Error Messages

Table 13-3 explains the other BIOS error messages that can display.

**Table 13-3. Other BIOS Error Messages**

Message	Problem	Suggested Solution
Following SCSI disk not found and no empty slot available for mapping it	The physical disk roaming feature did not find the physical disk with the displayed SCSI ID. No slot is available to map the physical drive. PERC 3 cannot resolve the physical drives into the current configuration.	Reconfigure the array.
Following SCSI IDs have the same data y, z Channel x: a, b, c	The physical drive roaming feature found the same data on two or more physical drives on channel x with SCSI IDs a, b, and c. PERC 3 cannot determine the drive that has the duplicate information.	Remove the drive or drives that should not be used.
Unresolved configuration mismatch between disks and NVRAM on the adapter	The PERC 3 is unable to determine the proper configuration after reading both NVRAM and Configuration on Disk.	Press <Ctrl><M> to run the BIOS Configuration Utility. Choose <b>Configure</b> → <b>New Configuration</b> to create a new configuration. <b>CAUTION:</b> This will delete any existing configuration.

## Other Potential Problems

Table 13-4 describes other items that might cause problems.

**Table 13-4. Other Potential Problems**

Topic	Information
Physical drive errors	To display the <b>Media Error and Other Error</b> options, select the <b>Objects—&gt; Physical Drive</b> menu and press <F2> after you select a physical drive. A <b>Media Error</b> is an error that occurred while actually transferring data. An <b>Other Error</b> is an error that occurs at the hardware level, such as a device failure, poor cabling, bad termination, or signal loss.
Virtual sizing	The virtual sizing option enables RAID expansion. Virtual sizing must be enabled to increase the size of a logical drive or add a physical drive to an existing logical drive. To enable virtual sizing, run the BIOS Configuration Utility by pressing <Ctrl> <M> at bootup. Select <b>Objects—&gt; Logical Drive</b> . Then select <b>View—&gt; Update Parameters</b> . Set virtual sizing to <b>Enabled</b> .
PERC 3 Power Requirements	The maximum PERC 3 power requirements are 15 watts at 5 v and 3 amps.
Windows NT® does not detect the PERC 3	Refer to the <i>PERC 3 Operating System Driver Installation Guide</i> for the chapter about Windows NT driver installation.

## Audible Warnings

The PERC card onboard tone generator indicates events and errors. Table 13-5 describes the warnings and their meanings.

**Table 13-5. Audible Warnings**

<b>Tone Pattern</b>	<b>Meaning</b>	<b>Examples</b>
Three seconds on and one second off	A logical drive is offline.	One or more drives in a RAID 0 configuration failed. Two or more drives in a RAID 1 or 5 configuration failed.
One second on and one second off	A logical drive is running in degraded mode.	One drive in a RAID 5 configuration failed.
One second on and three seconds off	An automatically initiated rebuild has been completed.	While you were away from the system, a disk drive in a RAID 1 or 5 configuration failed and was rebuilt.

SECTION 14

## **Appendix A: SCSI Cables and Connectors**

Visit Dell's web site at [www.dell.com](http://www.dell.com) for information about qualified SCSI cables and connectors, or contact your Dell representative for information.



SECTION 15

## **Appendix B: Warranties and Return Policy**

---

Dell-branded hardware products purchased in the U.S. or Canada come with either a one-year, two-year, three-year, or four-year (U.S. only) limited warranty. To determine which warranty you purchased, see the Dell invoice that accompanied your computer. The following sections describe these limited warranties, the manufacturer guarantee for Latin America and the Caribbean, and the return policy for the U.S.

### **One-Year Limited Warranty (U.S. Only)**

Dell Computer Corporation ("Dell") manufactures its hardware products from parts and components that are new or equivalent to new in accordance with industry-standard practices. Dell warrants that the hardware products it manufactures will be free from defects in materials and workmanship. The limited warranty term is one year beginning on the date of invoice, as further described in the following text.

Damage due to shipping the products to you is covered under this limited warranty. Otherwise, this limited warranty does not cover damage due to external causes, including accident, abuse, misuse, problems with electrical power, servicing not authorized by Dell, usage not in accordance with product instructions, failure to perform required preventive maintenance, and problems caused by use of parts and components not supplied by Dell.

This limited warranty does not cover any items that are in one or more of the following categories: software; external devices (except as specifically noted); accessories or parts added to a Dell system after the system is shipped from Dell; accessories or parts added to a Dell system through Dell's system integration department; accessories or parts that are not installed in the Dell factory; or Dell Software and Peripherals products. Monitors, keyboards, and mice that are Dell-branded or that are included on Dell's standard price list are covered under this limited warranty; all other monitors, keyboards, and mice (including those sold through the Dell Software and Peripherals program) are not covered.



Dell will repair or replace products covered under this limited warranty that are returned to Dell's facility. To request warranty service, you must contact Dell's Customer Technical Support within the limited warranty period. If warranty service is required, Dell will issue a Return Material Authorization Number. You must ship the products back to Dell in their original or equivalent packaging, prepay shipping charges, and insure the shipment or accept the risk of loss or damage during shipment. Dell will ship the repaired or replacement products to you (freight prepaid) if you use an address in the continental U.S., where applicable. Shipments to other locations will be made freight collect.

Dell owns all parts removed from repaired products. Dell uses new and reconditioned parts made by various manufacturers in performing warranty repairs and building replacement products. If Dell repairs or replaces a product, its warranty term is not extended.

THIS LIMITED WARRANTY GIVES YOU SPECIFIC LEGAL RIGHTS, AND YOU MAY ALSO HAVE OTHER RIGHTS, WHICH VARY FROM STATE TO STATE (OR JURISDICTION TO JURISDICTION). DELL'S RESPONSIBILITY FOR MALFUNCTIONS AND DEFECTS IN HARDWARE IS LIMITED TO REPAIR AND REPLACEMENT AS SET FORTH IN THIS LIMITED WARRANTY STATEMENT. ALL EXPRESS AND IMPLIED WARRANTIES FOR THE PRODUCT, INCLUDING BUT NOT LIMITED TO ANY IMPLIED WARRANTIES OF AND CONDITIONS OF MERCHANTABILITY AND FITNESS FOR A PARTICULAR PURPOSE, ARE LIMITED IN DURATION TO THE WARRANTY PERIOD SET FORTH ABOVE AND NO WARRANTIES, WHETHER EXPRESS OR IMPLIED, WILL APPLY AFTER SUCH PERIOD.

SOME STATES (OR JURISDICTIONS) DO NOT ALLOW LIMITATIONS ON HOW LONG AN IMPLIED WARRANTY LASTS, SO THE PRECEDING LIMITATION MAY NOT APPLY TO YOU.

DELL DOES NOT ACCEPT LIABILITY BEYOND THE REMEDIES SET FORTH IN THIS LIMITED WARRANTY STATEMENT OR LIABILITY FOR INCIDENTAL OR CONSEQUENTIAL DAMAGES, INCLUDING WITHOUT LIMITATION ANY LIABILITY FOR PRODUCTS NOT BEING AVAILABLE FOR USE OR FOR LOST DATA OR SOFTWARE.

 **NOTE:** Before you ship the product(s) to Dell, back up the data on the hard drive(s) and any other storage device(s) in the product(s). Remove any removable media, such as diskettes, CDs, or PC Cards. Dell does not accept liability for lost data or software.

SOME STATES (OR JURISDICTIONS) DO NOT ALLOW THE EXCLUSION OR LIMITATION OF INCIDENTAL OR CONSEQUENTIAL DAMAGES, SO THE PRECEDING EXCLUSION OR LIMITATION MAY NOT APPLY TO YOU.

These provisions apply to Dell's one-year limited warranty only. For provisions of any service contract covering your system, see your invoice or the separate service contract that you will receive.

If Dell elects to exchange a product or portion of a product, the exchange will be made in accordance with Dell's Exchange Policy in effect on the date of the exchange. In any instance in which Dell issues a Return Material Authorization Number, Dell must receive the product(s) for repair prior to the expiration of the warranty period in order for the repair(s) to be covered by the limited warranty.

### **Two-Year Limited Warranty (U.S. Only)**

Dell Computer Corporation ("Dell") manufactures its hardware products from parts and components that are new or equivalent to new in accordance with industry-standard practices. Dell warrants that the hardware products it manufactures will be free from defects in materials and workmanship. The limited warranty term is two years beginning on the date of invoice, as further described in the following section.

Damage due to shipping the products to you is covered under this warranty. Otherwise, this limited warranty does not cover damage due to external causes, including accident, abuse, misuse, problems with electrical power, servicing not authorized by Dell, usage not in accordance with product instructions, failure to perform required preventive maintenance, and problems caused by use of parts and components not supplied by Dell.

This limited warranty does not cover any items that are in one or more of the following categories: software; external devices (except as specifically noted); accessories or parts added to a Dell system after the system is shipped from Dell; accessories or parts added to a Dell system through Dell's system integration department; accessories or parts that are not installed in the Dell factory; or Dell Software and Peripherals products. Monitors, keyboards, and mice that are Dell-branded or that are included on Dell's standard price list are covered under this warranty; all other monitors, keyboards, and mice (including those sold through the Dell Software and Peripherals program) are not covered. Batteries for portable computers are covered only during the initial one-year period of this limited warranty.

### **Limited Warranty Coverage During Year One**

During the one-year period beginning on the invoice date, Dell will repair or replace products covered under this limited warranty that are returned to Dell's facility. To request warranty service, you must contact Dell's Customer Technical Support within the warranty period. If warranty service is required, Dell will issue a Return Material Authorization Number. You must ship the products back to Dell in their original or equivalent packaging, prepay shipping charges, and insure the shipment or accept the risk of loss or damage during shipment. Dell will ship the repaired or replacement products to you freight prepaid if you use an address in the continental U.S., where applicable. Shipments to other locations will be made freight collect.

Dell owns all parts removed from repaired products. Dell uses new and reconditioned parts made by various manufacturers in performing warranty repairs and building replacement products. If Dell repairs or replaces a product, its warranty term is not extended.

 **NOTE:** Before you ship the product(s) to Dell, back up the data on the hard drive(s) and any other storage device(s) in the product(s). Remove any removable media, such as diskettes, CDs, or PC Cards. Dell does not accept liability for lost data or software.

### **Limited Warranty Coverage During Year Two**

During the second year of this limited warranty, Dell will provide, on an exchange basis and subject to Dell's Exchange Policy in effect on the date of the exchange, replacement parts for the Dell hardware product(s) covered under this limited warranty when a part requires replacement. You must report each instance of hardware failure to Dell's Customer Technical Support in advance to obtain Dell's concurrence that a part should be replaced and to have Dell ship the replacement part. Dell will ship parts (freight prepaid) if you use an address in the continental U.S., where applicable. Shipments to other locations, where applicable, will be made freight collect. Dell will include a prepaid shipping container with each replacement part for your use in returning the replaced part to Dell. Replacement parts are new or reconditioned. Dell may provide replacement parts made by various manufacturers when supplying parts to you. The warranty term for a replacement part is the remainder of the limited warranty term.

You will pay Dell for replacement parts if the replaced part is not returned to Dell. The process for returning replaced parts, and your obligation to pay for replacement parts if you do not return the replaced parts to Dell, will be in accordance with Dell's Exchange Policy in effect on the date of the exchange.

You accept full responsibility for your software and data. Dell is not required to advise or remind you of appropriate backup and other procedures.

## **General Provisions**

THIS LIMITED WARRANTY GIVES YOU SPECIFIC LEGAL RIGHTS, AND YOU MAY ALSO HAVE OTHER RIGHTS, WHICH VARY FROM STATE TO STATE (OR JURISDICTION TO JURISDICTION). DELL'S RESPONSIBILITY FOR MALFUNCTIONS AND DEFECTS IN HARDWARE IS LIMITED TO REPAIR AND REPLACEMENT AS SET FORTH IN THIS LIMITED WARRANTY STATEMENT. ALL EXPRESS AND IMPLIED WARRANTIES FOR THE PRODUCT, INCLUDING BUT NOT LIMITED TO ANY IMPLIED WARRANTIES OF AND CONDITIONS OF MERCHANTABILITY AND FITNESS FOR A PARTICULAR PURPOSE, ARE LIMITED IN DURATION TO THE WARRANTY PERIOD SET FORTH ABOVE AND NO WARRANTIES, WHETHER EXPRESS OR IMPLIED, WILL APPLY AFTER SUCH PERIOD. SOME STATES (OR JURISDICTIONS) DO NOT ALLOW LIMITATIONS ON HOW LONG AN IMPLIED WARRANTY LASTS, SO THE PRECEDING LIMITATION MAY NOT APPLY TO YOU.

DELL DOES NOT ACCEPT LIABILITY BEYOND THE REMEDIES SET FORTH IN THIS LIMITED WARRANTY STATEMENT OR LIABILITY FOR INCIDENTAL OR CONSEQUENTIAL DAMAGES, INCLUDING WITHOUT LIMITATION ANY LIABILITY FOR PRODUCTS NOT BEING AVAILABLE FOR USE OR FOR LOST DATA OR SOFTWARE. SOME STATES (OR JURISDICTIONS) DO NOT ALLOW THE EXCLUSION OR LIMITATION OF INCIDENTAL OR CONSEQUENTIAL DAMAGES, SO THE PRECEDING EXCLUSION OR LIMITATION MAY NOT APPLY TO YOU.

These provisions apply to Dell's two-year limited warranty only. For provisions of any service contract covering your system, see your invoice or the separate service contract that you will receive.

If Dell elects to exchange a system or component, the exchange will be made in accordance with Dell's Exchange Policy in effect on the date of the exchange. In any instance in which Dell issues a Return Material Authorization Number, Dell must receive the product(s) for repair prior to the expiration of the warranty period in order for the repair(s) to be covered by the limited warranty.

### **Three-Year Limited Warranty (U.S. Only)**

Dell Computer Corporation ("Dell") manufactures its hardware products from parts and components that are new or equivalent to new in accordance with industry-standard practices. Dell warrants that the hardware products it manufactures will be free from defects in materials and workmanship. The limited warranty term is three years beginning on the date of invoice, as described in the following text.

Damage due to shipping the products to you is covered under this limited warranty. Otherwise, this limited warranty does not cover damage due to external causes, including accident, abuse, misuse, problems with electrical power, servicing not authorized by Dell, usage not in accordance with product instructions, failure to perform required preventive maintenance, and problems caused by use of parts and components not supplied by Dell.

This limited warranty does not cover any items that are in one or more of the following categories: software; external devices (except as specifically noted); accessories or parts added to a Dell system after the system is shipped from Dell; accessories or parts added to a Dell system through Dell's system integration department; accessories or parts that are not installed in the Dell factory; or Dell Software and Peripherals products. Monitors, keyboards, and mice that are Dell-branded or that are included on Dell's standard price list are covered under this limited warranty; all other monitors, keyboards, and mice (including those sold through the Dell Software and Peripherals program) are not covered. Batteries for portable computers are covered only during the initial one-year period of this limited warranty.

### **Limited Warranty Coverage During Year One**

During the one-year period beginning on the invoice date, Dell will repair or replace products covered under this limited warranty that are returned to Dell's facility. To request warranty service, you must contact Dell's Customer Technical Support within the warranty period. If warranty service is required, Dell will issue a Return Material Authorization Number. You must ship the products back to Dell in their original or equivalent packaging, prepay shipping charges, and insure the shipment or accept the risk of loss or damage during shipment. Dell will ship the repaired or replacement products to you freight prepaid if you use an address in the continental U.S., where applicable. Shipments to other locations will be made freight collect.

Dell owns all parts removed from repaired products. Dell uses new and reconditioned parts made by various manufacturers in performing warranty repairs and building replacement products. If Dell repairs or replaces a product, its warranty term is not extended.

### **Limited Warranty Coverage During Years Two and Three**

During the second and third years of this limited warranty, Dell will provide, on an exchange basis and subject to Dell's Exchange Policy in effect on the date of the exchange, replacement parts for the Dell hardware product(s) covered under this limited warranty when a part requires replacement. You must report each instance of hardware failure to Dell's Customer Technical Support in advance to obtain Dell's concurrence that a part should be replaced and to have Dell ship the replacement part. Dell will ship parts (freight prepaid) if you use an address in the continental U.S., where applicable. Shipments to other locations will be made freight collect. Dell will include a prepaid shipping container with each replacement part for your use in returning the replaced part to Dell. Replacement parts are new or reconditioned. Dell may provide replacement parts made by various manufacturers when supplying parts to you. The warranty term for a replacement part is the remainder of the limited warranty term.

 **NOTE:** Before you ship the product(s) to Dell, back up the data on the hard drive(s) and any other storage device(s) in the product(s). Remove any removable media, such as diskettes, CDs, or PC Cards. Dell does not accept liability for lost data or software.

You will pay Dell for replacement parts if the replaced part is not returned to Dell. The process for returning replaced parts, and your obligation to pay for replacement parts if you do not return the replaced parts to Dell, will be in accordance with Dell's Exchange Policy in effect on the date of the exchange.

You accept full responsibility for your software and data. Dell is not required to advise or remind you of appropriate backup and other procedures.

### **General Provisions**

THIS LIMITED WARRANTY GIVES YOU SPECIFIC LEGAL RIGHTS, AND YOU MAY ALSO HAVE OTHER RIGHTS, WHICH VARY FROM STATE TO STATE (OR JURISDICTION TO JURISDICTION). DELL'S RESPONSIBILITY FOR MALFUNCTIONS AND DEFECTS IN HARDWARE IS LIMITED TO REPAIR AND REPLACEMENT AS SET FORTH IN THIS LIMITED WARRANTY STATEMENT. ALL EXPRESS AND IMPLIED WARRANTIES FOR THE PRODUCT, INCLUDING BUT NOT LIMITED TO ANY IMPLIED WARRANTIES OF AND CONDITIONS OF MERCHANTABILITY AND FITNESS FOR A PARTICULAR PURPOSE, ARE LIMITED IN DURATION TO THE WARRANTY PERIOD SET FORTH ABOVE AND NO WARRANTIES, WHETHER EXPRESS OR IMPLIED, WILL APPLY AFTER SUCH PERIOD.

SOME STATES (OR JURISDICTIONS) DO NOT ALLOW LIMITATIONS ON HOW LONG AN IMPLIED WARRANTY LASTS, SO THE PRECEDING LIMITATION MAY NOT APPLY TO YOU.

DELL DOES NOT ACCEPT LIABILITY BEYOND THE REMEDIES SET FORTH IN THIS LIMITED WARRANTY STATEMENT OR LIABILITY FOR INCIDENTAL OR CONSEQUENTIAL DAMAGES, INCLUDING WITHOUT LIMITATION ANY LIABILITY FOR PRODUCTS NOT BEING AVAILABLE FOR USE OR FOR LOST DATA OR SOFTWARE.

SOME STATES (OR JURISDICTIONS) DO NOT ALLOW THE EXCLUSION OR LIMITATION OF INCIDENTAL OR CONSEQUENTIAL DAMAGES, SO THE PRECEDING EXCLUSION OR LIMITATION MAY NOT APPLY TO YOU.



These provisions apply to Dell's three-year limited warranty only. For provisions of any service contract covering your system, see your invoice or the separate service contract that you will receive.

If Dell elects to exchange a system or component, the exchange will be made in accordance with Dell's Exchange Policy in effect on the date of the exchange. In any instance in which Dell issues a Return Material Authorization Number, Dell must receive the product(s) for repair prior to the expiration of the warranty period in order for the repair(s) to be covered by the limited warranty.

#### **Four-Year Limited Warranty (U.S. Only)**

Dell Computer Corporation ("Dell") manufactures its hardware products from parts and components that are new or equivalent to new in accordance with industry-standard practices. Dell warrants that the hardware products it manufactures will be free from defects in materials and workmanship. The limited warranty term is four years beginning on the date of invoice, as further described in the following text.

Damage due to shipping the products to you is covered under this limited warranty. Otherwise, this limited warranty does not cover damage due to external causes, including accident, abuse, misuse, problems with electrical power, servicing not authorized by Dell, usage not in accordance with product instructions, failure to perform required preventive maintenance, and problems caused by use of parts and components not supplied by Dell.

This limited warranty does not cover any items that are in one or more of the following categories: software; external devices (except as specifically noted); accessories or parts added to a Dell system after the system is shipped from Dell; accessories or parts added to a Dell system through Dell's system integration department; accessories or parts that are not installed in the Dell factory; or Dell Software and Peripherals products. Monitors, keyboards, and mice that are Dell-branded or that are included on Dell's standard price list are covered under this limited warranty; all other monitors, keyboards, and mice (including those sold through the Dell Software and Peripherals program) are not covered. Batteries for portable computers are covered only during the initial one-year period of this limited warranty.



**NOTE:** Before you ship the product(s) to Dell, back up the data on the hard drive(s) and any other storage device(s) in the product(s). Remove any removable media, such as diskettes, CDs, or PC Cards. Dell does not accept liability for lost data or software.

### **Limited Warranty Coverage During Year One**

During the one-year period beginning on the invoice date, Dell will repair or replace products covered under this limited warranty that are returned to Dell's facility. To request limited warranty service, you must contact Dell's Customer Technical Support within the limited warranty period. See "Contacting Dell" in your user documentation to find the appropriate contact information for obtaining customer assistance. If limited warranty service is required, Dell will issue a Return Material Authorization Number. You must ship the products back to Dell in their original or equivalent packaging, prepay shipping charges, and insure the shipment or accept the risk of loss or damage during shipment. Dell will ship the repaired or replacement products to you freight prepaid if you use an address in the continental U.S., where applicable. Shipments to other locations will be made freight collect.

Dell owns all parts removed from repaired products. Dell uses new and reconditioned parts made by various manufacturers in performing limited warranty repairs and building replacement products. If Dell repairs or replaces a product, its limited warranty term is not extended.

### **Limited Warranty Coverage During Years Two, Three, and Four**

During the second, third, and fourth years of this limited warranty, Dell will provide, on an exchange basis and subject to Dell's Exchange Policy in effect on the date of the exchange, replacement parts for the Dell hardware product(s) covered under this limited warranty when a part requires replacement. You must report each instance of hardware failure to Dell's Customer Technical Support in advance to obtain Dell's concurrence that a part should be replaced and to have Dell ship the replacement part. Dell will ship parts (freight prepaid) if you use an address in the continental U.S., where applicable. Shipments to other locations will be made freight collect. Dell will include a prepaid shipping container with each replacement part for your use in returning the replaced part to Dell. Replacement parts are new or reconditioned. Dell may provide replacement parts made by various manufacturers when supplying parts to you. The limited warranty term for a replacement part is the remainder of the limited warranty term.

You will pay Dell for replacement parts when the replaced part is not returned to Dell. The process for returning replaced parts, and your obligation to pay for replacement parts if you do not return the replaced parts to Dell, will be in accordance with Dell's Exchange Policy in effect on the date of the exchange.

You accept full responsibility for your software and data. Dell is not required to advise or remind you of appropriate backup and other procedures.

### **General Provisions**

THIS LIMITED WARRANTY GIVES YOU SPECIFIC LEGAL RIGHTS, AND YOU MAY ALSO HAVE OTHER RIGHTS, WHICH VARY FROM STATE TO STATE (OR JURISDICTION TO JURISDICTION). DELL'S RESPONSIBILITY FOR MALFUNCTIONS AND DEFECTS IN HARDWARE IS LIMITED TO REPAIR AND REPLACEMENT AS SET FORTH IN THIS LIMITED WARRANTY STATEMENT. ALL EXPRESS AND IMPLIED WARRANTIES FOR THE PRODUCT, INCLUDING BUT NOT LIMITED TO ANY IMPLIED WARRANTIES OF AND CONDITIONS OF MERCHANTABILITY AND FITNESS FOR A PARTICULAR PURPOSE, ARE LIMITED IN DURATION TO THE LIMITED WARRANTY PERIOD SET FORTH ABOVE AND NO WARRANTIES, WHETHER EXPRESS OR IMPLIED, WILL APPLY AFTER SUCH PERIOD. SOME STATES (OR JURISDICTIONS) DO NOT ALLOW LIMITATIONS ON HOW LONG AN IMPLIED WARRANTY LASTS, SO THE PRECEDING LIMITATION MAY NOT APPLY TO YOU.

DELL DOES NOT ACCEPT LIABILITY BEYOND THE REMEDIES SET FORTH IN THIS LIMITED WARRANTY STATEMENT OR LIABILITY FOR INCIDENTAL OR CONSEQUENTIAL DAMAGES, INCLUDING WITHOUT LIMITATION ANY LIABILITY FOR PRODUCTS NOT BEING AVAILABLE FOR USE OR FOR LOST DATA OR SOFTWARE. SOME STATES (OR JURISDICTIONS) DO NOT ALLOW THE EXCLUSION OR LIMITATION OF INCIDENTAL OR CONSEQUENTIAL DAMAGES, SO THE PRECEDING EXCLUSION OR LIMITATION MAY NOT APPLY TO YOU.

If Dell elects to exchange a system or component, the exchange will be made in accordance with Dell's Exchange Policy in effect on the date of the exchange. In any instance in which Dell issues a Return Material Authorization Number, Dell must receive the product(s) for repair prior to the expiration of the limited warranty period in order for the repairs to be covered by the limited warranty.

These provisions apply to Dell's four-year limited warranty only. For provisions of any on-site service contract covering your system, see the separate on-site service contract that you will receive.

### **One-Year Limited Warranty (Canada Only)**

Dell Computer Corporation ("Dell") manufactures its hardware products from parts and components that are new or equivalent to new in accordance with industry-standard practices. Dell warrants that the hardware products it manufactures will be free from defects in materials and workmanship. The limited warranty term is one year beginning on the date of invoice, as further described in the following text.

Damage due to shipping the products to you is covered under this limited warranty. Otherwise, this limited warranty does not cover damage due to external causes, including accident, abuse, misuse, problems with electrical power, servicing not authorized by Dell, usage not in accordance with product instructions, failure to perform required preventive maintenance, and problems caused by use of parts and components not supplied by Dell.

This limited warranty does not cover any items that are in one or more of the following categories: software; external devices (except as specifically noted); accessories or parts added to a Dell system after the system is shipped from Dell; accessories or parts added to a Dell system through Dell's system integration department; accessories or parts that are not installed in the Dell factory; or Dell Software and Peripherals products. Monitors, keyboards, and mice that are Dell-branded or that are included on Dell's standard price list are covered under this limited warranty; all other monitors, keyboards, and mice (including those sold through the Dell Software and Peripherals program) are not covered.

Dell will repair or replace products covered under this limited warranty that are returned to Dell's facility. To request warranty service, you must contact Dell's Customer Technical Support within the warranty period. If warranty service is required, Dell will issue a Return Material Authorization Number. You must ship the products back to Dell in their original or equivalent packaging, prepay shipping charges, and insure the shipment or accept the risk of loss or damage during shipment. Dell will ship the repaired or replacement products to you (freight prepaid) if you use an address in Canada, where applicable. Shipments to other locations will be made freight collect.

Dell owns all parts removed from repaired products. Dell uses new and reconditioned parts made by various manufacturers in performing warranty repairs and building replacement products. If Dell repairs or replaces a product, its warranty term is not extended.

DELL MAKES NO EXPRESS WARRANTIES OR CONDITIONS BEYOND THOSE STATED IN THIS LIMITED WARRANTY STATEMENT. DELL DISCLAIMS ALL OTHER WARRANTIES AND CONDITIONS, EXPRESS OR IMPLIED, INCLUDING WITHOUT LIMITATION IMPLIED WARRANTIES AND CONDITIONS OF MERCHANTABILITY AND FITNESS FOR A PARTICULAR PURPOSE. SOME STATES (OR JURISDICTIONS) DO NOT ALLOW LIMITATIONS ON IMPLIED WARRANTIES OR CONDITIONS, SO THIS LIMITATION MAY NOT APPLY TO YOU.

DELL'S RESPONSIBILITY FOR MALFUNCTIONS AND DEFECTS IN HARDWARE IS LIMITED TO REPAIR AND REPLACEMENT AS SET FORTH IN THIS LIMITED WARRANTY STATEMENT. THESE WARRANTIES GIVE YOU SPECIFIC LEGAL RIGHTS, AND YOU MAY ALSO HAVE OTHER RIGHTS, WHICH VARY FROM STATE TO STATE (OR JURISDICTION TO JURISDICTION).

DELL DOES NOT ACCEPT LIABILITY BEYOND THE REMEDIES SET FORTH IN THIS LIMITED WARRANTY STATEMENT OR LIABILITY FOR INCIDENTAL, INDIRECT, SPECIAL, PUNITIVE, OR CONSEQUENTIAL DAMAGES, INCLUDING WITHOUT LIMITATION ANY LIABILITY FOR PRODUCTS NOT BEING AVAILABLE FOR USE OR FOR LOST DATA OR SOFTWARE.

 **NOTE:** Before you ship the product(s) to Dell, back up the data on the hard drive(s) and any other storage device(s) in the product(s). Remove any removable media, such as diskettes, CDs, or PC Cards. Dell does not accept liability for lost data or software.

SOME STATES (OR JURISDICTIONS) DO NOT ALLOW THE EXCLUSION OR LIMITATION OF INCIDENTAL, INDIRECT, SPECIAL, PUNITIVE, OR CONSEQUENTIAL DAMAGES, SO THE PRECEDING EXCLUSION OR LIMITATION MAY NOT APPLY TO YOU.

These provisions apply to Dell's one-year limited warranty only. For provisions of any service contract covering your system, see your invoice or the separate service contract that you will receive.

If Dell elects to exchange a product or portion of a product, the exchange will be made in accordance with Dell's Exchange Policy in effect on the date of the exchange. In any instance in which Dell issues a Return Material Authorization Number, Dell must receive the product(s) for repair prior to the expiration of the warranty period in order for the repair(s) to be covered by the limited warranty.

### **Two-Year Limited Warranty (Canada Only)**

Dell Computer Corporation ("Dell") manufactures its hardware products from parts and components that are new or equivalent to new in accordance with industry-standard practices. Dell warrants that the hardware products it manufactures will be free from defects in materials and workmanship. The warranty term is two years beginning on the date of invoice, as described in the following text.

Damage due to shipping the products to you is covered under this limited warranty. Otherwise, this limited warranty does not cover damage due to external causes, including accident, abuse, misuse, problems with electrical power, servicing not authorized by Dell, usage not in accordance with product instructions, failure to perform required preventive maintenance, and problems caused by use of parts and components not supplied by Dell.

This limited warranty does not cover any items that are in one or more of the following categories: software; external devices (except as specifically noted); accessories or parts added to a Dell system after the system is shipped from Dell; accessories or parts added to a Dell system through Dell's system integration department; accessories or parts that are not installed in the Dell factory; or Dell Software and Peripherals products. Monitors, keyboards, and mice that are Dell-branded or that are included on Dell's standard price list are covered under this limited warranty; all other monitors, keyboards, and mice (including those sold through the Dell Software and Peripherals program) are not covered. Batteries for portable computers are covered only during the initial one-year period of this limited warranty.

### **Limited Warranty Coverage During Year One**

During the one-year period beginning on the invoice date, Dell will repair or replace products covered under this limited warranty that are returned to Dell's facility. To request warranty service, you must contact Dell's Customer Technical Support within the warranty period. If warranty service is required, Dell will issue a Return Material Authorization Number. You must ship the products back to Dell in their original or equivalent packaging, prepay shipping charges, and insure the shipment or accept the risk of loss or damage during shipment. Dell will ship the repaired or replacement products to you freight prepaid if you use an address in Canada, where applicable. Shipments to other locations will be made freight collect.

Dell owns all parts removed from repaired products. Dell uses new and reconditioned parts made by various manufacturers in performing warranty repairs and building replacement products. If Dell repairs or replaces a product, its warranty term is not extended.

 **NOTE:** Before you ship the product(s) to Dell, back up the data on the hard drive(s) and any other storage device(s) in the product(s). Remove any removable media, such as diskettes, CDs, or PC Cards. Dell does not accept liability for lost data or software.

### **Limited Warranty Coverage During Year Two**

During the second year of this limited warranty, Dell will provide, on an exchange basis and subject to Dell's Exchange Policy in effect on the date of the exchange, replacement parts for the Dell hardware product(s) covered under this limited warranty when a part requires replacement. You must report each instance of hardware failure to Dell's Customer Technical Support in advance to obtain Dell's concurrence that a part should be replaced and to have Dell ship the replacement part. Dell will ship parts (freight prepaid) if you use an address in Canada, where applicable. Shipments to other locations will be made freight collect. Dell will include a prepaid shipping container with each replacement part for your use in returning the replaced part to Dell. Replacement parts are new or reconditioned. Dell may provide replacement parts made by various manufacturers when supplying parts to you. The warranty term for a replacement part is the remainder of the limited warranty term.

You will pay Dell for replacement parts if the replaced part is not returned to Dell. The process for returning replaced parts, and your obligation to pay for replacement parts if you do not return the replaced parts to Dell, will be in accordance with Dell's Exchange Policy in effect on the date of the exchange.

You accept full responsibility for your software and data. Dell is not required to advise or remind you of appropriate backup and other procedures.

### **General Provisions**

DELL MAKES NO EXPRESS WARRANTIES OR CONDITIONS BEYOND THOSE STATED IN THIS LIMITED WARRANTY STATEMENT. DELL DISCLAIMS ALL OTHER WARRANTIES AND CONDITIONS, EXPRESS OR IMPLIED, INCLUDING WITHOUT LIMITATION IMPLIED WARRANTIES AND CONDITIONS OF MERCHANTABILITY AND FITNESS FOR A PARTICULAR PURPOSE. SOME STATES (OR JURISDICTIONS) DO NOT ALLOW LIMITATIONS ON IMPLIED WARRANTIES OR CONDITIONS, SO THIS LIMITATION MAY NOT APPLY TO YOU.



DELL'S RESPONSIBILITY FOR MALFUNCTIONS AND DEFECTS IN HARDWARE IS LIMITED TO REPAIR AND REPLACEMENT AS SET FORTH IN THIS LIMITED WARRANTY STATEMENT. THESE WARRANTIES GIVE YOU SPECIFIC LEGAL RIGHTS, AND YOU MAY ALSO HAVE OTHER RIGHTS, WHICH VARY FROM STATE TO STATE (OR JURISDICTION TO JURISDICTION).

DELL DOES NOT ACCEPT LIABILITY BEYOND THE REMEDIES SET FORTH IN THIS LIMITED WARRANTY STATEMENT OR LIABILITY FOR INCIDENTAL, INDIRECT, SPECIAL, PUNITIVE, OR CONSEQUENTIAL DAMAGES, INCLUDING WITHOUT LIMITATION ANY LIABILITY FOR PRODUCTS NOT BEING AVAILABLE FOR USE OR FOR LOST DATA OR SOFTWARE.

SOME STATES (OR JURISDICTIONS) DO NOT ALLOW THE EXCLUSION OR LIMITATION OF INCIDENTAL, INDIRECT, SPECIAL, PUNITIVE, OR CONSEQUENTIAL DAMAGES, SO THE PRECEDING EXCLUSION OR LIMITATION MAY NOT APPLY TO YOU.

These provisions apply to Dell's two-year limited warranty only. For provisions of any service contract covering your system, see your invoice or the separate service contract that you will receive.

If Dell elects to exchange a system or component, the exchange will be made in accordance with Dell's Exchange Policy in effect on the date of the exchange. In any instance in which Dell issues a Return Material Authorization Number, Dell must receive the product(s) for repair prior to the expiration of the warranty period in order for the repair(s) to be covered by the limited warranty.

### **Three-Year Limited Warranty (Canada Only)**

Dell Computer Corporation ("Dell") manufactures its hardware products from parts and components that are new or equivalent to new in accordance with industry-standard practices. Dell warrants that the hardware products it manufactures will be free from defects in materials and workmanship. The warranty term is three years beginning on the date of invoice, as described in the following text.

Damage due to shipping the products to you is covered under this limited warranty. Otherwise, this limited warranty does not cover damage due to external causes, including accident, abuse, misuse, problems with electrical power, servicing not authorized by Dell, usage not in accordance with product instructions, failure to perform required preventive maintenance, and problems caused by use of parts and components not supplied by Dell.

This limited warranty does not cover any items that are in one or more of the following categories: software; external devices (except as specifically noted); accessories or parts added to a Dell system after the system is shipped from Dell; accessories or parts added to a Dell system through Dell's system integration department; accessories or parts that are not installed in the Dell factory; or Dell Software and Peripherals products. Monitors, keyboards, and mice that are Dell-branded or that are included on Dell's standard price list are covered under this limited warranty; all other monitors, keyboards, and mice (including those sold through the Dell Software and Peripherals program) are not covered. Batteries for portable computers are covered only during the initial one-year period of this limited warranty.

### **Limited Warranty Coverage During Year One**

During the one-year period beginning on the invoice date, Dell will repair or replace products covered under this limited warranty that are returned to Dell's facility. To request warranty service, you must contact Dell's Customer Technical Support within the warranty period. To request warranty service, you must contact Dell's Customer Technical Support within the warranty period. If warranty service is required, Dell will issue a Return Material Authorization Number. You must ship the products back to Dell in their original or equivalent packaging, prepay shipping charges, and insure the shipment or accept the risk of loss or damage during shipment. Dell will ship the repaired or replacement products to you freight prepaid if you use an address in Canada, where applicable. Shipments to other locations will be made freight collect.

Before you ship the product(s) to Dell, back up the data on the hard drive(s) and any other storage device(s) in the product(s). Remove any removable media, such as diskettes, CDs, or PC Cards. Dell does not accept liability for lost data or software.

Dell owns all parts removed from repaired products. Dell uses new and reconditioned parts made by various manufacturers in performing warranty repairs and building replacement products. If Dell repairs or replaces a product, its warranty term is not extended.

### **Limited Warranty Coverage During Years Two and Three**

During the second and third years of this limited warranty, Dell will provide, on an exchange basis and subject to Dell's Exchange Policy in effect on the date of the exchange, replacement parts for the Dell hardware product(s) covered under this limited warranty when a part requires replacement. You must report each instance of hardware failure to Dell's Customer Technical Support in advance to obtain Dell's concurrence that a part should be replaced and to have Dell ship the replacement part. Dell will ship parts (freight prepaid) if you use an address in Canada, where applicable. Shipments to other locations will be made freight collect. Dell will include a prepaid shipping container with each replacement part for your use in returning the replaced part to Dell. Replacement parts are new or reconditioned. Dell may provide replacement parts made by various manufacturers when supplying parts to you. The warranty term for a replacement part is the remainder of the limited warranty term.

These provisions apply to Dell's three-year limited warranty only. For provisions of any service contract covering your system, see your invoice or the separate service contract that you will receive.

If Dell elects to exchange a system or component, the exchange will be made in accordance with Dell's Exchange Policy in effect on the date of the exchange. In any instance in which Dell issues a Return Material Authorization Number, Dell must receive the product(s) for repair prior to the expiration of the warranty period in order for the repair(s) to be covered by the limited warranty.

### **"Total Satisfaction" Return Policy (U.S. Only)**

If you are an end-user customer who bought new products directly from a Dell company, you may return them to Dell within 30 days of the date of invoice for a refund or credit of the product purchase price. If you are an end-user customer who bought reconditioned or refurbished products from a Dell company, you may return them to Dell within 14 days of the date of invoice for a refund or credit of the product purchase price. In either case, the refund or credit will not include any shipping and handling charges shown on your invoice. If you are an organization that bought the products under a written agreement with Dell, the agreement may contain different terms for the return of products than specified by this policy.

To return products, you must contact Dell Customer Service to receive a Credit Return Authorization Number. To expedite the processing of your refund or credit, Dell expects you to return the products to Dell in their original packaging within five days of the date that Dell issues the Credit Return Authorization Number. You must also prepay shipping charges and insure the shipment or accept the risk of loss or damage during shipment. You may return software for refund or credit only if the sealed package containing the diskette(s) or CD(s) is unopened. Returned products must be in as-new condition, and all of the manuals, diskette(s), CD(s), power cables, and other items included with a product must be returned with it. For customers who want to return, for refund or credit only, either applications software or an operating system that has been installed by Dell, the whole system must be returned, along with any media and documentation that may have been included in the original shipment.

This "Total Satisfaction" Return Policy does not apply to Dell Software and Peripherals products, which may be returned under Dell Software and Peripherals's then-current return policy. The "Total Satisfaction" Return Policy also does not apply to Dell | EMC storage products.

## **One-Year End-User Manufacturer Guarantee (Latin America and the Caribbean Only)**

### **Guarantee**

Dell Computer Corporation ("Dell") warrants to the end user in accordance with the following provisions that its branded hardware products, purchased by the end user from a Dell company or an authorized Dell distributor in Latin America or the Caribbean, will be free from defects in materials, workmanship, and design affecting normal use, for a period of one year from the original purchase date. Products for which proper claims are made will, at Dell's option, be repaired or replaced at Dell's expense. Dell owns all parts removed from repaired products. Dell uses new and reconditioned parts made by various manufacturers in performing repairs and building replacement products.

### **Exclusions**

This Guarantee does not apply to defects resulting from: improper or inadequate installation, use, or maintenance; actions or modifications by unauthorized third parties or the end user; accidental or willful damage; or normal wear and tear.

### **Making a Claim**

Claims must be made in Latin America or the Caribbean by contacting the Dell point of sale within the guarantee period. The end user must always supply proof of purchase, indicating name and address of the seller, date of purchase, model and serial number, name and address of the customer, and details of symptoms and configuration at the time of malfunction, including peripherals and software used. Otherwise, Dell may refuse the guarantee claim. Upon diagnosis of a warranted defect, Dell will make arrangements and pay for ground freight and insurance to and from Dell's repair/replacement center. The end user must ensure that the defective product is available for collection properly packed in original or equally protective packaging together with the details listed above and the return number provided to the end user by Dell.

### **Limitation and Statutory Rights**

Dell makes no other warranty, guarantee or like statement other than as explicitly stated above, and this Guarantee is given in place of all other guarantees whatsoever, to the fullest extent permitted by law. In the absence of applicable legislation, this Guarantee will be the end user's sole and exclusive remedy against Dell or any of its affiliates, and neither Dell nor any of its affiliates shall be liable for loss of profit or contracts, or any other indirect or consequential loss arising from negligence, breach of contract, or howsoever.

This Guarantee does not impair or affect mandatory statutory rights of the end user against and/or any rights resulting from other contracts concluded by the end user with Dell and/or any other seller.

#### **Dell World Trade LP**

One Dell Way, Round Rock, TX 78682, USA

#### **Dell Computadores do Brasil Ltda (CNPJ No. 72.381.189/0001-10)/**

#### **Dell Commercial do Brasil Ltda (CNPJ No. 03 405 822/0001-40)**

Avenida Industrial Belgraf, 400

92990-000 - Eldorado do Sul – RS - Brasil

#### **Dell Computer de Chile Ltda**

Coyancura 2283, Piso 3- Of.302,

Providencia, Santiago - Chile

#### **Dell Computer de Colombia Corporation**

Carrera 7 #115-33 Oficina 603

Bogota, Colombia

#### **Dell Computer de Mexico SA de CV**

Paseo de la Reforma 2620 - 11° Piso

Col. Lomas Altas

11950 México, D.F.

# Glossary

**Array**—A grouping of hard disk drives combines the storage space on the hard drives into a single segment of contiguous storage space. The RAID controller can group hard drives on one or more channels into an array. A hot spare drive does not participate in an array.

**Array Management Software**—Software that provides common control and management for a disk array. Array Management Software most often executes in a disk controller or intelligent host bus adapter, but it can also execute in a host computer. When it executes in a disk controller or adapter, Array Management Software is often called *firmware*.

**Array Spanning**—Array spanning by a logical drive combines storage space in two arrays of hard drives into a single, contiguous storage space in a logical drive. The logical drive can span consecutively numbered arrays, each having the same number of hard drives. Array spanning promotes RAID level 1 to RAID level 10. See also *Disk Spanning*, and *Spanning*.

**Asynchronous Operations**—Operations that are not related to each other in time and can overlap. The concept of asynchronous I/O operations is central to independent access arrays in throughput-intensive applications.

**ATA** —(Advanced Technology Attachment) Also known as IDE (Integrated Device Electronics), this is a type of hard disk drive interface in which the controller electronics are integrated onto the drive itself. A separate adapter card is no longer needed, which reduces interface costs and makes it easier to implement firmware.

**Cache Input/Output (I/O)**—A small amount of fast memory that holds recently accessed data. Caching speeds subsequent access to the same data. It is most often applied to processor-memory access, but can also be used to store a copy of data accessible over a network. When data is read from or written to main memory, a copy is also saved in cache memory with the associated main memory address. The cache memory software monitors the addresses of subsequent reads to see if the required data is already stored in cache memory. If it is already in cache memory (a cache hit), it is read from cache memory immediately and the main memory read is aborted (or not started.) If the data is not cached (a cache miss), it is fetched from main memory and saved in cache memory.

**Channel**—An electrical path for the transfer of data and control information between a disk and a disk controller.

**Consistency Check**—An examination of the disk system to determine whether all conditions are valid for the specified configuration (such as parity).

**Cold Swap**—A cold swap requires that you turn the power off before replacing defective hard drive in a disk subsystem.

**Data Transfer Capacity**—The amount of data per unit time moved through a channel. For disk I/O, bandwidth is expressed in megabytes per second (MB/s).

**Degraded Drive**—A disk drive that has become non-functional or has decreased in performance.

**Disk**—A non-volatile, randomly addressable, rewritable mass storage device, including both rotating magnetic and optical disks and solid-state disks, or non-volatile electronic storage elements. It does not include specialized devices such as write-once-read-many (WORM) optical disks, nor does it include so-called RAM disks implemented using software to control a dedicated portion of a host computer's volatile random access memory.

**Disk Array**—A collection of disks from one or more disk subsystems combined with array management software. It controls the disks and presents them to the array operating environment as one or more virtual disks.



**Disk Duplexing**—A variation on disk mirroring in which a second disk adapter or host adapter and redundant hard drives are present.

**Disk Mirroring**—Writing duplicate data to more than one (usually two) hard disks to protect against data loss in the event of device failure. Disk mirroring is a common feature of RAID systems.

**Disk Spanning**—Disk spanning allows multiple hard drives to function like one big drive. Spanning overcomes lack of disk space and simplifies storage management by combining existing resources or adding relatively inexpensive resources. For example, four 400 MB hard drives can be combined to appear to the operating system as one single 1600 MB drive. See also *Array Spanning* and *Spanning*.

**Disk Striping**—A type of disk array mapping. Consecutive stripes of data are mapped round-robin to consecutive array members. A striped array (RAID level 0) provides high I/O performance at low cost, but provides lower data reliability than any of its member disks.

**Disk Subsystem**—A collection of disks and the hardware that connects them to one or more host computers. The hardware can include an intelligent controller, or the disks can attach directly to a host computer.

**Double Buffering**—A technique that achieves maximum data transfer bandwidth by constantly keeping two I/O requests for adjacent data outstanding. A software component begins a double-buffered I/O stream by issuing two requests in rapid sequence. Thereafter, each time an I/O request completes, another is immediately issued. If the disk subsystem is capable of processing requests fast enough, double buffering allows data to be transferred at the full-volume transfer rate.

**Failed Drive**—A drive that has ceased to function or consistently functions improperly.

**Firmware**—Software stored in read-only memory (ROM) or Programmable ROM (PROM). Firmware is often responsible for the behavior of a system when it is first turned on. A typical example would be a monitor program in a computer that loads the full operating system from disk or from a network and then passes control to the operating system.

**FlexRAID Power Fail Option**—The FlexRAID Power Fail option allows a reconstruction to restart if a power failure occurs. This is the advantage of this option. The disadvantage is, once the reconstruction is active, the performance is slower because an additional activity is running.

**Formatting**—The process of writing zeros to all data fields in a physical drive (hard drive) to map out unreadable or bad sectors. Because most hard drives are factory formatted, formatting is usually only done if a hard disk generates many media errors.

**GB**—(gigabyte) 1,000,000,000 (10 to the ninth power) bytes. It is the same as 1,000 MB (megabytes).

**Host-based Array**—A disk array with an Array Management Software in its host computer rather than in a disk subsystem.

**Host Computer**—Any computer to which disks are directly attached. Mainframes, servers, workstations, and personal computers can all be considered host computers.

**Hot Spare**—A stand-by drive ready for use if another drive fails. It does not contain any user data. Up to eight hard drives can be assigned as hot spares for an adapter. A hot spare can be dedicated to a single redundant array or it can be part of the global hot-spare pool for all arrays controlled by the adapter.

**Hot Swap**—The substitution of a replacement unit in a disk subsystem for a defective one, where the substitution can be performed while the subsystem is running (performing its normal functions). Hot swaps are manual.

**Input/Output (I/O) Driver**—A host computer software component (usually part of the operating system) that controls the operation of peripheral controllers or adapters attached to the host computer. I/O drivers communicate between applications and I/O devices, and in some cases participates in data transfer.

**Integrated Device Electronics (IDE)**— Also known as Advanced Technology Attachment (ATA), this is a type of interface for the hard drive, in which the controller electronics are integrated onto the drive itself. With IDE, a separate adapter card is no longer needed; this reduces interface costs and makes it easier to implement firmware.

**Initialization**—The process of writing zeros to the data fields of a logical drive and generating the corresponding parity to bring the logical drive to a ready state. Initializing erases previous data and generates parity so that the logical drive will pass a consistency check. Arrays can work without initializing, but they can fail a consistency check because the parity fields have not been generated.

**Logical Disk**—A set of contiguous chunks on a physical disk. Logical disks are used in array implementations as constituents of logical volumes or partitions. Logical disks are normally transparent to the host environment, except when the array containing them is being configured.

**Logical Drive**—A virtual drive within an array that can consist of more than one physical drive. Logical drives divide the contiguous storage space of an array of hard drives or a spanned group of arrays of drives. The storage space in a logical drive is spread across all the physical drives in the array or spanned arrays. Configure at least one logical drive for each array.

**Mapping**—The conversion between multiple data addressing schemes, especially conversions between member disk block addresses and block addresses of the virtual disks presented to the operating environment by Array Management Software.

**Megabyte (MB)**— An abbreviation for 1,000,000 (10 to the sixth power) bytes. It is the same as 1,000 KB (kilobytes).

**Multi-threaded**—Having multiple concurrent or pseudo-concurrent execution sequences. Used to describe processes in computer systems. Multi-threaded processes allow throughput-intensive applications to efficiently use a disk array to increase I/O performance.

**Operating Environment**—The operating environment includes the host computer where the array is attached, any I/O buses and adapters, the host operating system, and any additional software required to operate the array. For host-based arrays, the operating environment includes I/O driver software for the member disks, but does not include Array Management Software, which is regarded as part of the array itself.

**Parity**—Parity is an extra bit added to a byte or word to reveal errors in storage (in random access memory, RAM, or disk) or transmission. Parity is used to generate a set of redundancy data from two or more parent data sets. The redundancy data can be used to reconstruct one of the parent data sets. However, parity data does not fully duplicate the parent data sets. In RAID, this method is applied to entire drives or stripes across all hard drives in an array. Parity consists of dedicated parity, in which the parity of the data on two or more drives is stored on an additional drive, and distributed parity, in which the parity data are distributed among all the drives in the system. If a single drive fails, it can be rebuilt from the parity of the respective data on the remaining drives.

**Partition**—An array virtual disk made up of logical disks rather than physical ones. Also known as logical volume.

**Physical Drive**—A hard drive that stores data. A hard drive consists of one or more rigid magnetic discs rotating about a central axle with associated read/write heads and electronics.

**Physical Drive Roaming**—The ability of some adapters to detect when hard drives have been moved to a different slots in the computer, for example, after a hot swap.

**Protocol**—A set of formal rules describing how to transmit data, especially across a network. Low level protocols define the electrical and physical standards to be observed, bit- and byte- ordering, and the transmission and error detection and correction of the bit stream. High level protocols deal with the data formatting, including the message syntax, the terminal-to-computer dialogue, character sets, and sequencing of messages.

**RAID**—Redundant Array of Independent Disks. An array of multiple independent hard disk drives that yields better performance than a Single Large Expensive Disk (SLED). A RAID disk subsystem improves I/O performance on a server using only a single drive. The RAID array appears to the host server as a single storage unit. I/O is expedited because several disks can be accessed simultaneously.

**RAID Levels**—A style of redundancy applied to a logical drive. It can increase the performance of the logical drive and can decrease usable capacity. Each logical drive must have a RAID level assigned to it. The RAID level drive requirements are: RAID 0 requires one to eight physical drives, RAID 1 requires exactly two physical drives, RAID 5 requires three to eight physical drives and RAID 10 requires four, six or eight physical drives. RAID 10 results when a RAID 1 logical drive spans arrays.

**RAID Migration**—RAID migration is used to move between optimal RAID levels or to change from a degraded redundant logical drive to an optimal RAID 0. In Novell, the utility used for RAID migration is MEGAMGR. If a RAID 1 is being converted to a RAID 0, instead of performing RAID migration, one drive can be removed and the other reconfigured on the controller as a RAID 0. This is due to the same data being written to each drive.

**Read-Ahead**—A memory caching capability in some adapters that allows them to read sequentially ahead of requested data and store the additional data in cache memory, anticipating that the additional data will be needed soon. Read-Ahead supplies sequential data faster, but is not as effective when accessing random data.

**Ready State**—A condition in which a workable hard drive is neither online nor a hot spare and is available to add to an array or to designate as a hot spare.

**Rebuild**—The regeneration of all data from a failed disk in a RAID level 1, or 5 array to a replacement disk. A disk rebuild normally occurs without interruption of application access to data stored on the array virtual disk.

**Rebuild Rate**—The percentage of CPU resources devoted to rebuilding.

**Reconstruct**—The act of remaking a logical drive after changing RAID levels or adding a physical drive to an existing array.

**Redundancy**—The provision of multiple interchangeable components to perform a single function to cope with failures or errors. Redundancy normally applies to hardware; a common form of hardware redundancy is disk mirroring.

**Replacement Disk**—A disk available to replace a failed member disk in a RAID array.

**Replacement Unit**—A component or collection of components in a disk subsystem that are always replaced as a unit when any part of the collection fails. Typical replacement units in a disk subsystem includes disks, controller logic boards, power supplies, and cables. Also called a hot spare.

**SCSI**—Small Computer System Interface. A processor-independent standard for system-level interfacing between a computer and intelligent devices, including hard disks, diskettes, CD drives, printers, scanners, etc. SCSI can connect up to seven devices to a single adapter (or host adapter) on the computer's bus. SCSI transfers eight or 16 bits in parallel and can operate in either asynchronous or synchronous modes. The synchronous transfer rate is up to 160 MB/s. SCSI connections normally use single ended drivers, as opposed to differential drivers.

The original standard is now called SCSI-1 to distinguish it from SCSI-2 and SCSI-3, which include specifications of Wide SCSI (a 16-bit bus) and Fast SCSI (10 MB/s transfer.) Ultra 160M SCSI is a subset of Ultra3 SCSI and allows a maximum throughput of 160 MB/s, which is more than twice as fast as Wide Ultra2 SCSI.

**Service Provider**—The Service Provider (SP) is a program that resides in the desktop system or server and is responsible for all Desktop Management Interface (DMI) activities. This layer collects management information from products (whether system hardware, peripherals or software) stores that information in the DMI database and passes it to management applications as requested.

**SNMP**—Simple Network Management Protocol, the most widely used protocol for communication management information between the managed elements of a network and a network manager. SNMP focuses primarily on the network backbone. The Internet standard protocol that manages nodes on an Internet Protocol (IP) network.

**Spanning**—Array spanning by a logical drive combines storage space in two arrays of hard drives into a single, contiguous storage space in a logical drive. Logical drives can span consecutively numbered arrays that each consist of the same number of hard drives. Array spanning promotes RAID level 1 to RAID levels 10. See also *Array Spanning*, and *Disk Spanning*.

**Spare**—A hard drive available to back up the data of other drives.

**Stripe Size**—The amount of data contiguously written to each disk. You can specify stripe sizes of 4 KB, 8 KB, 16 KB, 32 KB, 64 KB, and 128 KB for each logical drive. For best performance, choose a stripe size equal to or smaller than the block size used by the host computer.

**Stripe Width**—The number of hard drives across which the data are striped.

**Striping**—Segmentation of logically sequential data, such as a single file, so that segments can be written to multiple physical devices in a round-robin fashion. This technique is useful if the processor can read or write data faster than a single disk can supply or accept it. While data is being transferred from the first disk, the second disk can locate the next segment. Data striping is used in some modern databases and in certain RAID devices.

**Stripe Size**—The amount of data contiguously written to each disk. Also called "stripe depth." You can specify stripe sizes of 4 KB, 8 KB, 16 KB, 32 KB, 64 KB, and 128 KB for each logical drive. A larger stripe size produces improved read performance, especially if most of the reads are sequential. For mostly random reads, select a smaller stripe size.

**Stripe Width**—The number of drives across which data is striped.

**Terminator**—A resistor connected to a signal wire in a bus or network for impedance matching to prevent reflections, e.g., a resistor connected across signal wires at the end of a SCSI cable.

**Wide SCSI**—A variant on the SCSI-2 interface. Wide SCSI has a 16-bit bus, double the width of the original SCSI-1.

**Write-Back**—In Write-Back caching mode, the controller sends a data transfer completion signal to the host when the controller cache has received all the data in a disk write transaction. Data are written to the disk subsystem in accordance with policies set up by the controller. These policies include the amount of dirty/clean cache lines, the number of cache lines available, elapsed time from the last cache flush, and others.

**Write-Through**—In Write-Through caching, the controller sends a data transfer completion signal to the host when the disk subsystem has received all the data in a transaction. The controller cache is not used.





# Index

## A

- Array, 237
- Array Configuration Planner, 98
- Array Management Software, 237
- Array Performance Features, 56, 67, 76
- Array Spanning, 237
- Arrays, 92-93, 109, 125-126, 142, 170, 176
- Asynchronous Operations, 237
- ATA, 237
- Audible Warnings, 210

## B

- Battery Backup, 193
- BIOS, 58, 60, 68, 70, 72, 78, 80-81, 93, 96, 104-105, 115-116, 121-122, 130, 136-137, 139-140, 146-147, 149-159, 163, 167, 173, 178-185, 188-193, 199, 204-208
- BIOS Boot Error Messages, 205

- BIOS Configuration
  - Utility, 72, 81, 115-116, 147, 149-159, 163, 167, 173, 178-185, 188-193, 199, 206, 208
- Check Consistency Menu, 159
- Configure Menu, 152
- Format Menu, 158
- Initialize Menu, 153
- Menu Options, 151, 153
- Objects Menu, 153
- Rebuild Menu, 158
- Starting, 150
- BIOS Error Messages,
  - Other, 208

## C

- Cables
  - SCSI, 102, 104, 113-114, 118, 128, 134, 136, 146, 204
- Cache I/O, 238
- Cache Memory, 59, 70, 79
- Cache Policy, 87, 161, 166, 172, 177, 192, 197
- Channel, 238
- Cluster, 65, 154-155, 161, 166, 185-186

- Cluster Mode, 154-155, 185-186
  - Enabling and Disabling, 185
  - Initiator ID, 154-155, 186
- Cold Swap, 238
- Configuration Features, 54-55, 64, 74
- Configuration Method, 160
  - Easy Configuration, 96, 152, 159-160, 163, 167, 183
  - New Configuration, 96, 152, 159-161, 167, 208
  - View/Add Configuration, 150, 152, 159, 161-162, 167, 173, 206
- Configuration on Disk, 55, 65, 75, 150, 161, 208
- Configuration Strategies, 93
  - Maximizing Capacity, 94
  - Maximizing Drive Availability, 94
  - Maximizing Drive Performance, 95
- Configuring Arrays and Logical Drives, 159
- Consistency Check, 32, 238

## D

- Data Storage, 96

- Optimizing, 96
- Data Transfer Capacity, 238
- Degraded, 238
- Dell Manager, 61-62, 72, 81-82, 187-190, 194-195, 197-202
  - Check Consistency, 195
  - Format Menu, 194
  - Initialize Menu, 190
  - Objects Menu, 190
  - Rebuild Menu, 195
  - Starting, 188
- Disk, 238
- Disk Array, 238
- Disk Duplexing, 239
- Disk Mirroring, 34, 239
- Disk Spanning, 35, 239
- Disk Striping, 32, 239
- Disk Subsystem, 239
- Double Buffering, 239

## **E**

- Easy Configuration, 96, 152, 159-160, 163, 167, 183
- Enclosure Management, 40

## **F**

- Failed Drive, 239
- Fault Tolerance, 31, 57, 67, 77, 94, 98
  - Features, 57, 67, 77

- Firmware, 239
- FlexRAID Power Fail Option, 240
- Format, 240
- Formatting, 100, 158, 179-181, 194, 198-200
  - Batch, 180-181, 200
  - Individual, 181, 200
  - Media Errors, 180, 199
  - Physical Drives, 180, 199

## **G**

- GB, 240

## **H**

- Hardware Architecture
  - Features, 56, 66, 76
- Hardware Installation, 101, 117, 133
  - Installation Steps, 103, 136
- Hardware Requirements, 54, 64, 74
- Hardware Termination, 184
- Host Computer, 240
- Host-based Array, 240
- Hot Spares, 37, 162, 195, 240
  - Creating, 93
  - Designating Drives as, 162, 195
- Hot Swap, 39, 240

## **I**

- I/O Driver, 240
- IDE, 240
- Initialization, 153, 179, 241
  - Batch, 178, 197
  - Individual, 178-179, 197-198
  - Logical Drives, 178-180, 199

## **J**

- Jumpers Setting
  - J10 TERMPWR Enable, 105, 107, 121, 123, 137-138
  - J11 TERMPWR Enable, 105, 113, 121, 123-124, 137-138
  - J12 TERMPWR Enable, 137-138, 140
  - J14 Serial Port, 122, 124, 137, 139
  - J17 Dirty Cache LED, 105, 108, 122, 125, 139
  - J19 Onboard BIOS
    - Enable, 137, 139
  - J2 Termination Enable, 105, 121-122, 125, 137-138, 184
  - J23 External Battery, 137, 140
  - J3 Termination Enable, 105, 121-122, 125, 137-138, 184
  - J5 Termination Enable, 105-106, 121, 128, 137-138, 184
  - J7 Termination Enable, 105, 121, 128, 137-138, 184
  - J9 TERMPWR Enable, 105-106, 121-122, 137-138

## L

Logical Disk, 241  
Logical Drives, 115, 130, 147,  
150, 159, 205, 207, 241  
  Configuring, 96  
  Creating, 93  
  Definition, 183  
  Initializing, 178, 197  
  Spanning, 35  
  States, 40

## M

Mapping, 241  
MB, 241  
Media Errors, 180, 199  
Multi-threaded, 241

## N

New Configuration, 96, 152,  
159-161, 167, 208

## O

Operating Environment, 241  
Operating System Software  
  Drivers, 58, 68, 78

## P

Parameters, 155, 191, 196,  
209  
Parity, 36, 57, 67, 77, 242

Partition, 242

PCI Bridge, 59, 69, 79

PERC, 24-27, 30-33, 37-40,  
42-43, 45, 47, 53-84, 92-  
93, 96-97, 101-105, 108-  
109, 111-113, 115-122,  
125-128, 130-131, 133-  
137, 139-141, 143-144,  
146-147, 149-155, 157,  
159, 161-163, 166-168,  
170, 173, 176, 178-185,  
189-191, 195, 199, 201,  
204-210

  BIOS, 58, 60-61, 72

  Features, 53

  PERC Configuration  
    Manager, 93, 96, 206-207,  
    209

  Physical Disk, 242

  Physical Disk Roaming, 242

  Physical Drives, 84, 87, 95,  
  180

    Formatting, 180, 199

    Media Errors, 180, 199

  Pre-loaded SCSI Drive  
    Using As-Is, 183

  Protocol, 242

## R

RAID, 24-25, 29-32, 34-39,  
41-43, 45-51, 54-55, 58-  
59, 61-62, 64-65, 69, 71-  
72, 74-75, 78-79, 81-82,  
84, 87, 92-99, 108, 115,  
123, 130, 146, 150, 152,  
155, 159-160, 162, 164-

171, 174-176, 180, 182,  
188-189, 191, 195-196,  
201, 209-210, 242

  Levels, 31, 41, 54, 59, 64, 69,  
  74, 79, 98

  Management, 61, 72, 81

  Overview, 31

  RAID 0, 36, 42-43, 48-50, 94,  
  98-99, 164, 168, 174, 210

  RAID 1, 34-36, 39, 45, 48-49,  
  98-99, 164, 166-168, 170-  
  171, 174, 176, 182, 196,  
  201, 210

  RAID 10, 35-36, 48-49, 98-99,  
  168, 170, 174, 176

  RAID 5, 36, 42, 46-47, 50-51,  
  92, 94, 98-99, 164, 168-  
  170, 174, 176, 210

  RAID 50, 36, 50-51, 92, 98-99,  
  169-170, 174, 176

  RAID Levels, 31, 41, 54, 59,  
  64, 69, 74, 79, 98, 243

    Assigning, 95

  RAID Migration, 243

  Read Policy, 87, 192, 196

  Read-Ahead, 243

  Ready State, 243

  Rebuild Rate, 243

  Rebuilding, 39, 182-183, 201-  
  202

    Failed Disk Drives, 182, 201

    Rebuild Types, 182, 201

  Reconstruction, 243

  Redundancy, 243

  Replacement Disk, 243

Replacement Unit, 244  
Return Policy, 213, 234

## S

Safety Instructions, 1  
SCSI, 24-27, 30-31, 39, 54,  
56, 59-61, 64, 66, 69-71,  
74, 76, 79-81, 84-87, 89,  
102-109, 113-115, 118,  
120-122, 124-126, 128-  
130, 134, 136-138, 140-  
142, 145-147, 153, 156-  
158, 166, 171, 177, 180,  
183-184, 190, 193-194,  
196, 199, 204-205, 207-  
208, 211, 244  
Bus, 26, 59-61, 69-71, 79-81  
Bus Widths and Maximum  
Throughput, 26  
Cables, 113, 129, 145, 211  
Channel, 25, 27, 54, 59, 64,  
69, 74, 79, 84-87, 89,  
122, 138, 157, 193  
Connectors, 25, 59-60, 69,  
71, 79-80  
Firmware, 61, 71, 81  
Termination, 59-60, 69, 71,  
79-80, 105, 108-109,  
122, 125, 138, 141  
Serial Port, 59-60, 69-70, 79-  
80, 106, 123-124, 139  
Service Provider, 244  
SMART Technology, 55, 65,  
75  
SNMP, 244  
Software Utilities, 77

Spanning, 244  
Spare, 244  
Stripe Size, 33, 57, 61, 67, 71,  
81, 87, 161, 166, 196, 245  
Stripe Width, 245  
Striping, 245

## T

Termination, 59-60, 69, 71,  
79-80, 105, 108, 121-122,  
125-126, 137-138, 140,  
157, 184, 193  
Hardware, 184  
SCSI, 59-60, 69, 71, 79-80,  
105, 108-109, 122, 125,  
138, 141  
Troubleshooting  
BIOS Boot Error  
Messages, 205

## V

View/Add Configuration, 150,  
152, 159, 161-162, 167,  
173, 206  
Virtual Sizing, 55, 65, 75, 155,  
161, 191, 209

## W

Warranties, 213  
WebBIOS Configuration  
Utility, 61-62, 72, 81-82,  
104, 116, 130, 136, 147

Write Policy, 87, 161, 166,  
171, 176, 191, 196





Printed in the U.S.A.

P/N 5C229 Rev. A04



[www.dell.com](http://www.dell.com) | [support.dell.com](http://support.dell.com)