

# Operation Guide DQ-970

**ILLUSTRATION**

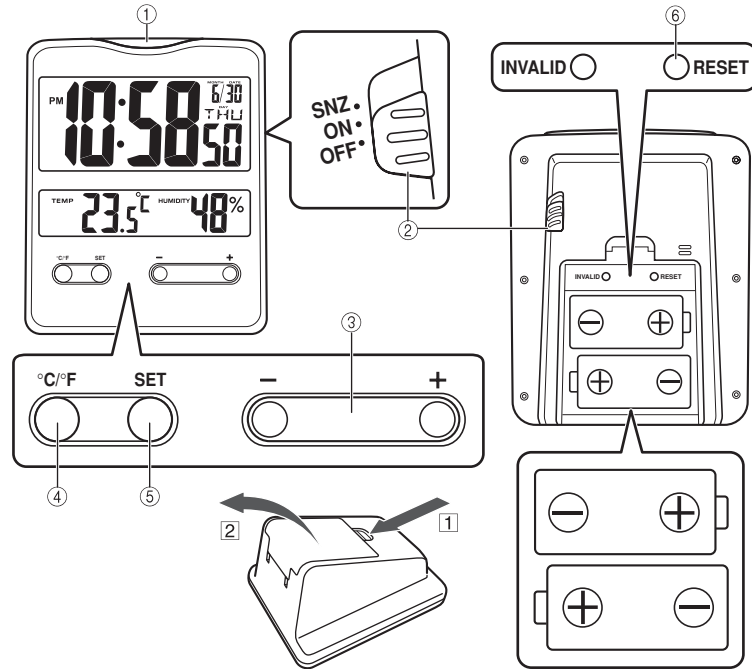

- A sticker is affixed to the glass of the clock when you purchase it. Be sure to remove the sticker before using the clock.
- Depending on the clock model, its configuration may differ somewhat from that shown in the illustration.

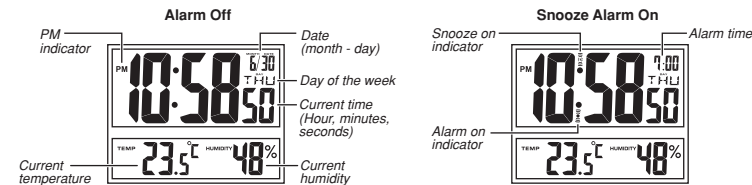

**GENERAL GUIDE**

- ① **SNOOZE/LIGHT button**
  - Press this button to illuminate the display for about five seconds.
  - Pressing this button while the alarm is sounding stops the alarm.
- ② **Alarm Mode selector**
  - SNZ: Snooze alarm on
  - ON: Alarm on
  - OFF: Alarm off
- ③ **+/- buttons**
  - Use these buttons to change the alarm time or the setting that is flashing on the display.
- ④ **°C/°F button**
  - Press this button to toggle the temperature units between Celsius and Fahrenheit.
- ⑤ **SET button**
  - Use this button when setting the current time.
- ⑥ **RESET button**
  - Press this button to reset the clock after replacing its batteries.
  - Buttons marked "INVALID" have no function.

**USING THE CLOCK**

1. Press the **SET button** (⑤) to cycle through the setting screens as shown below.

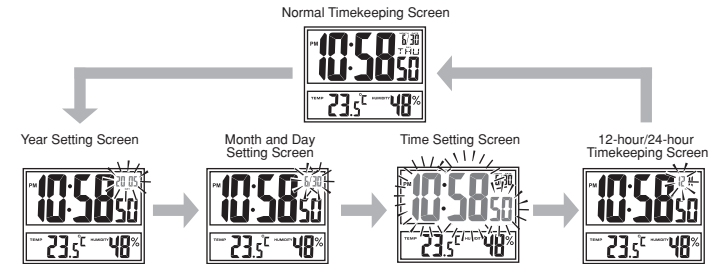

2. While the screen you want is displayed, use the **+** and **-** buttons (③) to change the flashing digits.

- Holding down **+** or **-** changes the flashing digits at high speed.
- You can set the year in the range of 2000 to 2039. The day of the week is set automatically in accordance with the date setting.
- Pressing **+** or **-** while the Time Setting Screen is on the display causes the seconds count to be reset to 00.
- Each press of **+** or **-** while the 12-hour/24-hour Timekeeping Screen is on the display toggles between 12-hour and 24-hour timekeeping.

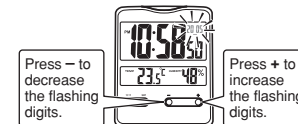

3. After making the settings you want, use the **SET button** (⑤) to display the Normal Timekeeping Screen.
- The clock automatically returns to the Normal Timekeeping Screen if you leave a setting screen on the display for about three minutes without performing any operation.

# Operation Guide DQ-970

CASIO®

## USING THE ALARM

The alarm sounds when the alarm time you set is reached. You can also use the **Alarm Mode** selector (2) to select the snooze alarm feature.

### Setting the Alarm Time

Use the + and – buttons (3) to set the alarm time. Pressing the + and – buttons (3) causes the alarm time to appear in place of the date on the display.

- Holding down + or – changes the digits at high speed.

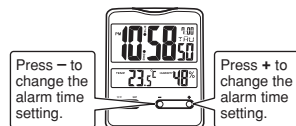

### Turning the Alarm On and Off

Use the **Alarm Mode** selector (2) on the side of the clock to turn the alarm on and off, and to select the snooze feature.

Alarm Mode selector	Description
SNZ (SNOOZE)	The alarm sounds at the preset time for one minute, and up to seven more times every five minutes thereafter. Even if you stop the alarm by pressing the SNOOZE/LIGHT button (1), the alarm sounds again five minutes later. <ul style="list-style-type: none"> <li>• The indicator  flashes on the display to indicate that the snooze feature is activated.</li> </ul>
ON (ALARM)	The alarm sounds at the preset time for one minute.
OFF	The alarm does not sound.

- The alarm time appears in place of the date on the display whenever the **Alarm Mode** selector (2) is set to ON or SNZ.
- The light also turns on for the first four seconds that the alarm sounds.
- The alarm sound changes over four levels as it sounds.

### Stopping the Alarm

- When alarm is sounding, press the SNOOZE/LIGHT button (1) to stop it. When the snooze feature is turned on, the alarm will sound again in about five minutes.
- To turn off the snooze feature, slide the **Alarm Mode** selector (2) to OFF.

## USING THE LIGHT

Pressing the SNOOZE/LIGHT button (1) turns on the light and illuminates the display for easy reading in the dark.

### Important!

- Overuse of the light can shorten battery life.

## THERMOMETER FUNCTIONS

- A built-in sensor measures temperature and shows the measured value on the display.
- The temperature display shows "LO" for temperatures below -50°C (-58°F) and "HI" for temperatures above 70°C (158°F).
- Though temperature readings are displayed up to 0°C (32°F) and greater than 41°C (105°F), note that such readings are actually outside the guaranteed temperature range of this clock.

### Switching between Celsius and Fahrenheit

- Push the °C/°F button (4) to select either Celsius (°C) or Fahrenheit (°F).

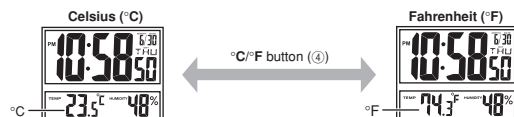

## HYGROMETER FUNCTIONS

A built-in sensor measures humidity and shows the measured value on the display.

- The humidity display shows "LO" for humidity below 10% and "HI" for humidity above 90%.

## BATTERY REPLACEMENT

Replace batteries whenever the display of the clock becomes dim and difficult to read.

1. Open the battery compartment cover as shown in the illustration.
2. Remove all of the old batteries.
3. Load a full set of new batteries. Make sure that their positive (+) and negative (-) ends face in the correct directions. If you load batteries incorrectly, they can burst and damage the clock.
4. Press the RESET button (5). Be sure to press the RESET button (5) after replacing batteries.
5. Replace the battery compartment cover.

### Battery precautions

- Keep batteries out of the reach of small children. If a battery is accidentally swallowed, contact your physician immediately.
- Be sure to load the batteries with their positive (+) and negative (-) ends facing correctly.
- Never mix old and new batteries, or batteries of different brands.
- Never charge the batteries that come with the clock.
- Should batteries ever leak while in the clock, wipe out the fluid with a cloth, taking care not to let any get onto your skin.
- Replace the batteries at least once a year, even if the current batteries are working properly.
- The batteries that come with the clock lose some of their power during transport and storage.