

ÖKO-LAVAMAT 62600

The environmentally friendly washing machine

Operating instructions



Dear customer,

Please read these operating instructions through carefully.

Please make sure you read the safety instructions on the first pages of these operating instructions! Keep the operating instructions for future reference. Pass them on to any future owners.



With the warning triangle and/or by means of key words (**Warning!**, **Caution!**, **Attention!**), information is emphasized which is important for your safety or the correct functioning of the appliance. It is essential that this information is observed.



This symbol guides you step by step when operating the appliance.



Next to this symbol you receive additional information and practical tips on using the appliance.



Tips and information about the economical and environmentally friendly use of the machine are marked with the clover.

These operating instructions contain information about how to independently solve any problems which may arise. See "Troubleshooting".

If this information is not sufficient, please contact your local Customer Service Centre. Addresses and phone numbers can be found in the separate "Guarantee Conditions/Service Departments" (supplied with the appliance).

In connection with this please refer to the "Service" section.

Printed on environmentally friendly paper.
Whoever thinks ecologically also acts ecologically

Contents

Safety instructions	5
Disposal	7
Environmental tips	7
The most important features of your appliance	8
Structure of the appliance	9
Front view	9
Control panel	10
Program selector	10
Program selector as program progress display	11
Temperature selector	11
Type of washing buttons	12
Final spin speed/(Rinse Hold) button	12
Delay Timer button	12
(On/Off) button	12
Compartment for washing powder and fabric softener	13
Consumption values and time required for selected programs	14
Before using your machine for the first time	14
Preparing the washing cycle	15
Sorting out and preparing washing	15
Washing Types and Care Symbols	16
Washing powders and conditioners	16
Which washing powder and conditioner?	16
How much washing powder and fabric softener?	17
Using a water softener	17
Run wash cycle	18
Brief instructions	18
Filling in the washing	19
Adding washing powder/fabric softener	20
Setting the washing program	21
Start the washing program, set delay timer and the final spin speed.	22
During the washing program	23
Washing cycle finished/Removing the washing	23

Program tables	24
Washing	24
Separate Soaking	26
Separate Conditioning/Starching/Treatment	26
Separate Rinsing	27
Separate Spinning	27
Cleaning and caring	28
In daily use	28
Control panel	28
Detergent compartment	28
Washing machine drum	29
Door	29
Precautionary measures in the event of a risk of frost	29
Troubleshooting	30
Remedy	30
If the washing results are not satisfactory	33
Executing an emergency emptying	34
Cleaning the suds pump	35
Additional Rinse/Water Cooling	36
Technical data	37
Power supply	37
Information for the electrician	37
Index	38
Service	39



Safety instructions

The safety standards of AEG electric appliances are in keeping with the recognised rules of technology and the law governing the safety of appliances. Nevertheless as a manufacturer we are committed to familiarise you with the following safety instructions:

General safety

- Repairs to the washing machine may only be carried out by qualified personnel. As a result of incorrect repairs considerable dangers for the user may result. Please contact our customer service department or an authorised AEG dealer in the event of repairs being necessary.
- Never start the washing machine if the mains flex is damaged or the control panel, work top or base area are so damaged that the inside of the washing machine is accessible.
- Switch off the washing machine before carrying out any cleaning, care and maintenance work! You can make totally sure by pulling the mains plug out of the socket or - if permanently connected – by switching off the fuse switch in the fuse box or by unscrewing the plug fuse right out.
- Multiway plugs, joints and extension cables must not be used. There is risk of overheating!
- Never use the flex to pull the plug out of the socket but pull the actual plug.
- Do not spray the washing machine with a water jet – danger of an electric shock!
- During washing programs at a high temperature, the glass of the door heats up. Do not touch!
- Allow the suds to cool down before cleaning the pump or carrying out emergency emptying.
- Small animals can nibble at power cables and water hoses. Electric shock hazard and danger of damages from water!

Installation, connection and initial operation

- Please follow the separate **Installation and connection instructions**.
- Run the first washing cycle without washing (면/린넨 /Cottons 95, with half the amount of washing powder) to remove residues on the drum and suds container caused during production.
- If the machine is delivered during the winter at freezing temperatures: store the washing machine for 24 hours at room temperature before starting it.

Safety of children

- Often children are not aware of the dangers involved in handling electrical equipment. Therefore please ensure they are adequately supervised whilst the appliance is on and do not allow children to play with the washing machine – there is a risk that the children may lock themselves in the appliance.
- Packaging (e.g. plastic films, polystyrene) could be dangerous for children – danger of suffocation! Keep packaging away from children.
- Please make sure that children or small animals do not climb into the drum of the washing machine.
- When disposing of the washing machine pull out the plug, cut off the flex, dispose of the plug and remaining flex and destroy the door lock. This hinders children from locking themselves in and endangering their lives.

Intended use

- Only use the washing machine to wash normal domestic washing. If the washing machine is used for any other purpose or is incorrectly used, the manufacturer adopts no liability for any damages which may result.
- Conversions or changes to washing machines are not permitted due to safety reasons.
- Only use washing powder which is suitable for washing machines. Please follow the instructions of the washing powder manufacturers.
- The washing may not contain any flammable solvents. Please observe this above all when washing prewashed laundry.
- Do not use your washing machine for dry cleaning.
- Dyes and bleaching agents may only be used if specifically permitted by the manufacturer of these products. We cannot be held liable for any damages.
- Please only use water from the mains. Only use rain or industrial water if it meets the requirements of DIN 1986 and DIN 1988.



Disposal

Dispose of the packaging!

Dispose of the packaging material of your washing machine correctly. All packaging materials are environmentally friendly and can be disposed of without any danger or burnt in the refuse incinerator.

The plastic parts can be reused:

- The external plastic cover and the bags inside are made of polyethylene (marking >PE<).
- The padding is made of CFC free expanded polystyrene (marking >PS<).

The boxes are made from recycled paper and should be returned to the old paper collection.

Dispose of your old washing machine!

When you eventually stop using your washing machine please bring it to the nearest recycling centre or to your dealer who will take it back for a small fee.



Environmental tips

- For normally soiled washing you do not need a prewash. In this way you can save washing powder, water and time (and not pollute the environment!).
- The washing machine works particularly economically if you exploit the maximum loads.
- For small quantities of washing use half to two thirds of the recommended washing powder quantity.
- By suitable pretreatment stains and a certain amount of dirt can be removed. Then you can wash at a low temperature.
- Wash slightly soiled to normally soiled cottons with the energy saving program.
- Often you do not need a fabric softener. Just try it! If you use a washing machine your washing will become soft and fluffy without softener.
- For medium to high water hardness (from hardness range II, see "Washing powder and conditioners") you should use a water softener. The washing powder can then always be measured as for hardness area I (= soft).

The most important features of your appliance

- Setting the program using the program selector, temperature selector and type of washing buttons.
- **Stain program** for effectively treating stained washing.
- **Energy saving program** for slightly soiled to normally soiled linen.
- Maximum **spin speed 1200 revolutions per minute**, speed for the final spin is automatically adapted depending on the washing program:

면		
린넨	(Cottons/Linen)	1200 revolutions per minute
취급용이물	(Easy Cares)	1000 revolutions per minute
섬세물	(Delicates)	1000 revolutions per minute
울재물	(Woollens)	1000 revolutions per minute

- Speed for the final spin can be changed to 1000, 700, or 400 revolutions per minute.
- **헹굼물멈춤 (Rinse hold)** can be added: the washing remains in the final rinse water, it is not spun.
- **Delay timer**: program start can be delayed by 2, 4, 8 or 12 hours (e.g. to times with a more economical power rate).
- **Automatic load adaptation** with fuzzy logic: sensor controlled washing process, water quantity dependent on foam and load. This ensures the best washing and rinsing results with the lowest automatically adapted water consumption.
- **4-chamber compartment** for washing powder and fabric softener: temporally delayed addition of softener, washing powder and stain removing agent enables environmentally friendly washing and improves the effectiveness of the detergents.
- **ÖKO gate**: ensures that the washing powder is fully exploited by automatically closing the suds container during the wash cycle.
- **Scoop ribs** in the washing machine drum: ensure washing is wet fast and equally.
- **Anti-unbalance control system**: for stability and smooth running.
- **Extra water switch**: suds cooling only or suds cooling with extra rinse can be set.
- **All-round water protection**.

Structure of the appliance

Front view

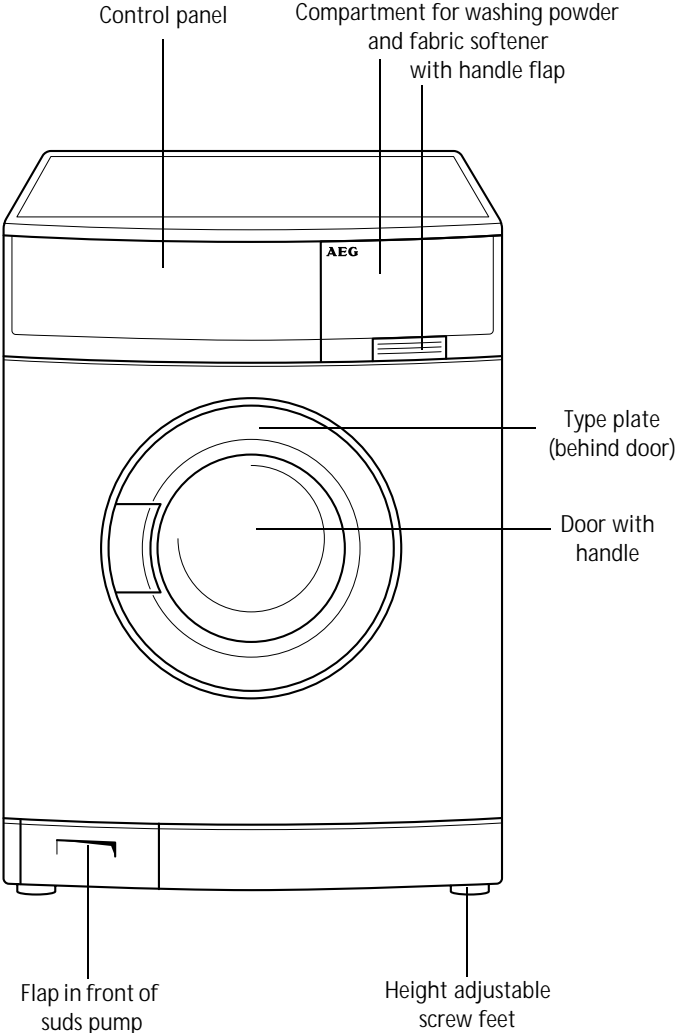

Control panel

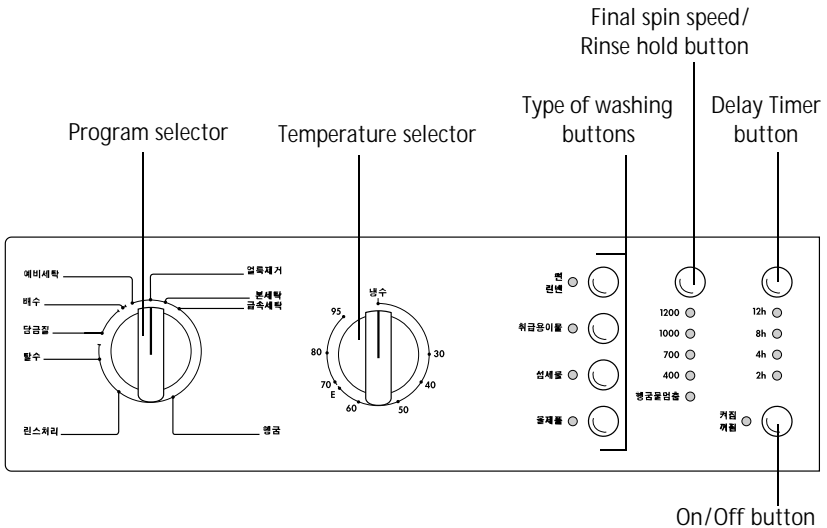

Program selector

The program selector determines the type of the washing cycle. The different setting positions have the following effect:

예비세탁 (PREWASH)

Cold prewash before the main wash which follows automatically (not selectable for the Woollens setting).

얼룩제거 (STAIN)

To treat heavily soiled washing or stained washing with stain remover (extended main wash with time optimised stain remover rinse, not selectable for Woollens setting).

본세탁 (MAIN WASH)

Main wash for normally soiled washing (washing rinsing/fabric softening, spinning).

금속세탁 (QUICK WASH)

Shortened main wash cycle for slightly soiled washing

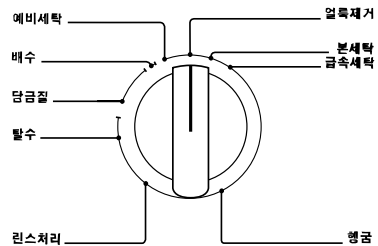

헹굼 (RINSE)

Separate rinse, e.g. for rinsing fabrics washed by hand (spin according to the type of washing).

린스처리 (CONDITIONER)

Separate fabric softening, separate starching, separate impregnating (one rinse runs, liquid conditioner from the compartment  is added).

탈수 (SPIN)

Spin after a **헹굼물멈춤** (Rinse hold), or separate spinning of hand-washed fabrics.

담금질 (SOAKING)

Separate soaking (maximum 40°C), the washing stays in the suds at the end (not selectable for Woollens setting).

 After soaking the main washing cycle required must be set, the program does not continue automatically.

배수 (PUMP OUT)

Pumping out the water after a **헹굼물멈춤** /Rinse hold (without spin).

Program selector as program progress display

The program selector serves as a program progress display by turning clockwise to the end of the program. For the programs Stain, Main wash and Quick wash, the program selector moves to a position directly behind Quick wash immediately after the program starts. Then it displays the program progress as usual.

Temperature selector

The following temperatures can be set on the temperature selector:

냉수 (Cold), 30, 40, 50, 60, E, 70, 80, 95

 Position E (energy saving program) is suitable for slightly to normally soiled linen; reduced temperature to approx. 67°C.

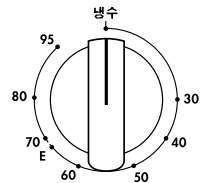

Type of washing buttons

With the type of washing buttons the progress of the programs (e.g. max. possible temperature, water level, drum movement, number of rinses, spin speed) is influenced in accordance with the type of washing to be treated.

편 린넨 (COTTONS/LINEN)

For cottons and linen.

취급용이물 (EASY CARES)

For easy cares (temperature automatically limited to maximum 60°C.)

섬세물 (DELICATES)

For delicates (higher water level and reduced drum movement, temperature automatically limited to maximum 40°C).

울재물 (WOOLLENS)

For machine washable woollens and particularly sensitive fabrics (higher water level and considerably reduced drum movement, temperature automatically limited to maximum 40°C).

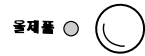
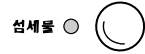
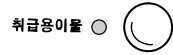
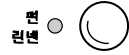

Final spin speed/헹굼물멈춤 (Rinse Hold) button

With this key you can change the maximum speed for the final spin. For 헹굼물멈춤 (Rinse hold) the washing stays in the final rinse water and is not spun.



1200

1000

700

400

헹굼물멈춤

Delay Timer button

With this button you can delay the start of a washing program by 2, 4, 8 or 12 hours.



12h

8h

4h

2h



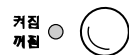

켜짐 꺼짐 (ON/OFF) button

This button switches the washing machine on and starts the program selected or switches the washing machine off.

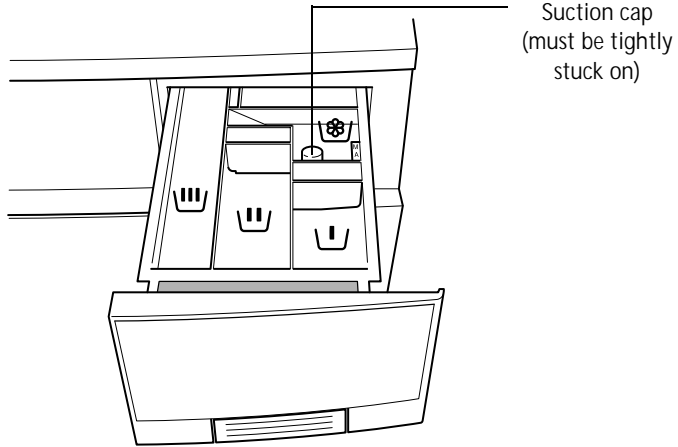

Compartment for washing powder and fabric softener



-  Compartment for prewash detergent/soaking agent or water softener.
They are added right at the beginning of the washing program.
-  Compartment for non-liquid i.e. powder main detergents and possibly softeners.
They are added right at the beginning of the main washing program.
-  Compartment for stain remover.
This is added during the Stain program in the main wash at the optimal time.
-  Compartment for liquid conditioners (fabric softener, starch).
They are added to the final rinse water.



Consumption values and time required for selected programs

The values in the following table were determined under standard conditions. They provide a useful guide for household use.

Program Selector	Temperature Selector	Type of Washing Button	Load in kg	Water in Litres	Energy in kWh	Time in minutes
본세탁 (MAIN WASH)	95	면/린넨 (COTTONS/LINEN)	5	58	1.70	134
	60 ¹⁾	면/린넨 (COTTONS/LINEN)	5	58	1.05	120
	40	면/린넨 (COTTONS/LINEN)	5	58	0.63	120
	40	취급용이물 (EASY CARES)	2.5	50	0.43	93
	30	섬세물 (DELICATES)	2.5	52	0.43	83
	30	울재폴 (WOOLLENS)	2	51	0.32	58

1) Note: program setting for testing in accordance with EN 60 456

Before using your machine for the first time

-  Slightly pull the detergent compartment out of the control panel.
-  Pour about 1 litre of water through the detergent compartment into the washing machine.

Only once this has been done does the suds container close and the ÖKO gate can function correctly.

-  Run through a wash cycle without washing (**면/린넨** /COTTONS 95, with half the amount of washing powder).

This removes residues on the drum and suds container caused during production.

Preparing the washing cycle

Sorting out and preparing washing

- Sort out washing according to the type and care symbol (see "Types of washing and care symbols").
- Empty the pockets.
- Remove any metal parts (paper clips, safety pins etc.).
- To prevent washing from getting damaged and forming bundles: close zips, button up duvet covers and pillow cases, tie up loose straps such as from aprons.
- Turn clothes made from double layer fabric inside out (e.g. anoraks, sleeping bags).
- For knitted coloured fabrics as well as woollens and fabrics with appliqué: turn inside out.
- Put small and delicate pieces (baby socks, tights) in a washing net, a pillow case with zip or in larger socks.
- Handle curtains with special care. Remove metal strips or plastic fins or tie them in a net or a bag.
We accept no liability for damages.
- Keep coloureds and whites separately in different washing cycles, otherwise whites will turn grey.
- New coloured fabric often contains excess dyes. Wash this laundry separately for the first time.
- Mix small and large pieces of washing! This improves the effectiveness of the wash and the washing is distributed better when spinning.
- Shake out washing before putting it into the machine.
- Unfold the washing before putting it into the drum.
- Observe tips for proper care such as "wash separately" and "wash separately several times"!

Washing Types and Care Symbols

Care symbols assist in the selection of the correct washing program. Washing should be sorted according to type and care symbol. The temperatures indicated in the care symbols are maximum temperatures.

Cottons

Cotton and linen fabrics with this care symbol are resistant to the mechanical action of the washing machine and high temperatures. The **면/린넨** (COTTONS/LINEN) program is suitable for this type of washing.

Linen

Cotton and linen fabrics with this care symbol are resistant to the mechanical action of the washing machine. The **면/린넨** (COTTONS/LINEN) program is suitable for this type of washing.

Easy-care washing



Fabrics such as treated cottons, cotton mixtures and synthetics with this care symbol need careful handling. The **취급용이물** (EASY-CARES) program is suitable for this type of washing.

Delicates

Fabrics such as those with layered fibres, micro-fibres, as well as synthetics and net curtains with this care symbol need particularly careful handling. The **섬세물** (DELICATES) program is suitable for this type of washing.

Woollens and particularly delicate washing

Fabrics such as woollens, wool mixtures and silk with this care symbol are particularly delicate in respect of the mechanical action of the washing machine. The **울제품** (WOOLLENS) program is suitable for this type of fabrics.

Important! Fabrics with the  (hand washing) or  (do not wash!) care symbols must not be washed in the washing machine!

Washing powders and conditioners

Which washing powder and conditioner?

Only use washing powders and fabric softeners suitable for washing machine use. As a general rule follow the instructions of the producers.

How much washing powder and fabric softener?

The amount to be used depends on

- the load:

If the washing powder producer does not make any specifications for small loads, use a third less for half loads, and for very small loads only use half of the amount of washing powder recommended for a full load.

- the degree of soiling of the washing:

For only slightly soiled washing use less washing powder. Follow the instructions of the washing powder producer and load.

- on the degree of hardness of the tap water:

The harder the water, the higher the dosage! You will find the quantities to use according to water hardness on the washing powder packaging.

Liquid detergent

Add liquid detergent using the dosing device provided by the detergent industry. Please follow the instructions on the package.

Using a water softener

For a medium to high degree of water hardness (from water hardness area II) water softener should be used. Follow the manufacturers instructions! Then always dose detergent for hardness area I (= soft). You can find information about the local degree of water hardness from your water utility.



As the water softener has to be added **before** the main detergent (pre-softening of the water), 80% of the water softener otherwise needed is sufficient.







Specifications of water hardness

Hardness Band	Water hardness in °dH (German hardness scale)	Water hardness in mmol/l (millimol per litre)
I – soft	0 – 7	to 1.3
II – medium-hard	7 – 14	1.3 – 2.5
III – hard	14 – 21	2.5 – 3.8
IV – very hard	greater than 21	greater than 3.8

Run wash cycle



Brief instructions

A washing cycle consists of the following steps:

-  Open the door, put in the washing.
-  Shut the door.
-  Add detergent/conditioner.
-  Set the correct washing program:
 - Set the program on the program selector;
 - Set the temperature on the temperature selector;
 - Select type of washing with the type of washing buttons.
-  Press **켜짐** (ON/OFF) button.
Washing program starts automatically after six seconds. During these six seconds:
 -  Set any delay timer if required.
 -  If applicable change final spin speed/select a **헹굼물멈춤** (Rinse hold). You can change this setting and the temperature during the entire washing cycle.

After the washing program has finished:

Attention! If the washing cycle ends with a **헹굼물멈춤** (Rinse hold), run **배수** (PUMP OUT) or **탈수** (SPIN) before opening the door.

-  Open the door, remove the washing.
-  Press the **켜짐** (ON/OFF) button!

Filling in the washing

 Sort the washing according to the type and prepare it correctly.

 For information about the correct preparation of the washing see "Types of washing and care symbols".

 Open the door: pull at the handle of the door.

 Fill in the washing.



 See the "Program tables" for the maximum load.

 Firmly shut the door.

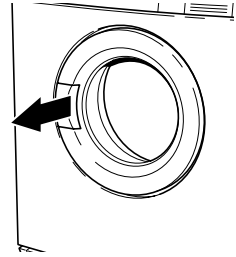





Attention! When shutting the door be careful not to catch any pieces of washing! The fabric and machine could get damaged.

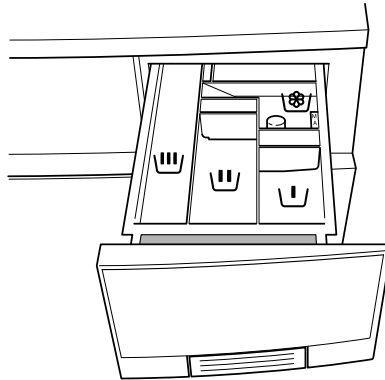
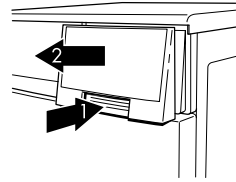

Adding washing powder/fabric softener

-  Open the compartment: reach into the recess under the compartment, pull the compartment out as far as it will go.
-  Fill in washing powder/fabric softener.
-  For information about washing powder and fabric softeners see section "Washing powder and conditioners".



-  Prewash agent/soaking agent
예비세탁 (PRE WASH)/담금질 (SOAKING),
or water softener
 -  Main detergent in powder form
(If you use water softener and need compartment  for the prewash/soaking agent, add the water softener to the main detergent compartment )
 -  Stain remover (only with additional program **얼룩제거 /STAIN**)
 -  Liquid conditioners (fabric softener, starch).
Caution! Fill up the compartment to the MAX mark at the most.
If necessary dilute thick detergents to the MAX mark, dissolve powdery starch.
-  Push the compartment right in.

Setting the washing program

- i** See "Program tables" for suitable program and correct temperature for the respective type of washing.

Set washing program

Attention! Only turn the program selector clockwise!

- ☞** Set the program selector to the washing program selected.

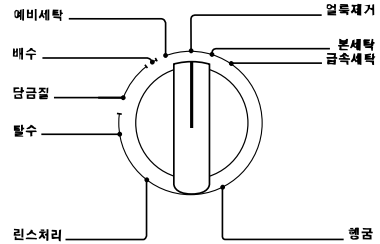

Set temperature

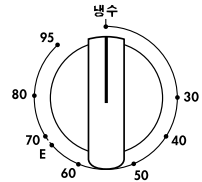

- ☞** Set the temperature selector to the required temperature.

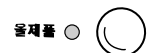
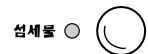
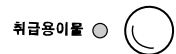

- ☞** Select type of washing.
- The display lamp of the type of washing selected lights up.
 - To deselect press another button.



Start the washing program, set delay timer and the final spin speed.

-  Check if the tap is open.
-  Switch on the washing machine: press the **켜짐** (ON/OFF) button.
 - The washing program starts automatically after six seconds.
 - During these six seconds you can set any delay timer if required to delay the start of the washing program.
 - As soon as the door is locked the On/Off display lamp lights up (max. 15 seconds after the start).

 For the programs **얼룩제거** (STAIN), **본세탁** (MAIN WASH) and **급속세탁** (QUICK WASH) immediately after the program has started the program selector moves to a position directly behind **급속세탁** (QUICK WASH). Then it displays the program progress as usual.

If applicable set the delay timer (delay of the start of the program): press the delay timer button so often until the time delay desired is displayed.

- The remaining time until the start of the programm is displayed (in steps of 12, 8, 4, 2 hours).
- While the delay timer expires you can open the door to add washing.
- Changing or cancelling the delay timer: press the delay timer button so often until the display lamp of the desired time delay lights up. If no display lamp lights up, the delay timer is cancelled, the program will start immediately.



- 12h ○
- 8h ○
- 4h ○
- 2h ○

-  If applicable change the spin speed for the final spin or select Rinse hold:

Press the final spin speed/**행궁물멈춤** (Rinse hold) button so often until the display of the spin speed required lights up (or of Rinse Hold).

With **행궁물멈춤** (Rinse hold) the washing stays in the final rinse water, it is not spun.



- 1200 ○
- 1000 ○
- 700 ○
- 400 ○
- 행궁물멈춤 ○



During the washing program

You can at any time

- change the setting of the final spin speed,
- select **헹굼물멈춤** (Rinse Hold),
- change the setting of the temperature.

Other settings cannot be changed.







To stop the washing program prematurely:

-  Press the **켜짐** (ON/OFF) button.
-  Turn the program selector clockwise to **배수** (PUMP OUT).
-  Press the **켜짐** (ON/OFF) button again. The water is pumped out.

Washing cycle finished/Removing the washing

The washing program is completed when the **켜짐** (ON/OFF) button display lamp goes out.





After a Rinse Hold the water must first be pumped out or the washing spun:

-  Either press the final spin speed/**헹굼물멈춤** (Rinse Hold) button so often until the display of the spin speed required lights up,
or
turn the program selector clockwise to **탈수** (SPIN)
(washing is spun in accordance with the program which has just run),
or
turn the program selector clockwise to **배수** (PUMP OUT).
(water is pumped out).
-  Open the door.
-  Remove the washing.
-  Switch off the washing machine by pressing the **켜짐** (ON/OFF) button.
-  Close the tap.
-  Pull the detergent compartment out a little so that it can dry. Only lean the door to so that the washing machine can get some air.

Program tables

Washing

In the following not all possibilities, but only the ones used most often and which are most useful are listed..

Washing Type, Care Symbol	Max. Load (weight dry) ¹⁾	Program Selector	Temperature Selector	Washing Type Buttons
Cottons 	5kg	본세탁 (MAIN WASH)	70 to 95	편린넨 (COTTONS/ LINEN)
		예비세탁 (PRE WASH)		
		얼룩제거 (STAIN)		
		급속세탁 (QUICK WASH)		
Energy Saving Program Cottons 	5kg	본세탁 (MAIN WASH)	E	편린넨 (COTTONS/ LINEN)
		예비세탁 (PRE WASH)		
Linen  	5kg	본세탁 (MAIN WASH)	30 to 60	편린넨 (COTTONS/ LINEN)
		예비세탁 (PRE WASH)		
		얼룩제거 (STAIN)		
		급속세탁 (QUICK WASH)		

Washing Type, Care Symbol	Max. Load (weight dry) ¹⁾	Program Selector	Temperature Selector	Washing Type Buttons
Easy-Cares 	2.5 kg	본세탁 (MAIN WASH)	30 to 60	취급용이물 (EASY-CARES)
		예비세탁 (PRE WASH)		
		얼룩제거 (STAIN)		
		금속세탁 (QUICK WASH)		
Delicates 	2.5 kg (or 15-20m ² Net Curtains)	본세탁 (MAIN WASH)	냉수 (COLD) to 40	섬세물 (DELICATES)
		예비세탁 (PRE WASH)		
		얼룩제거 (STAIN)		
		금속세탁 (QUICK WASH)		
Woollens ²⁾ 	2 kg	본세탁 (MAIN WASH)	냉수 (COLD) to 40	울재품 (WOOLLENS)
		금속세탁 (QUICK WASH)		

1) A 10-litre bucket contains about 2.5kg of dry washing (cotton).

2) Only wash woollen garments with the woolmark in the machine if they are also marked with "does not produce fluff", "non-fluffing" or "washing machine-safe".

Separate Soaking

Type of Washing	Max. Load (weight dry)	Program Selector	Temperature Selector	Washing Type Buttons
Cottons/Linen	5kg	담금질 SOAKING	냉수 (COLD) to 40	편 린넨 (COTTONS/LINEN)
Easy-Cares	2.5kg			취급용이물 (EASY-CARES)
Delicates	2.5kg			섬세물 (DELICATES)

Separate Conditioning/Starching/Treatment

Type of Washing	Max. Load (weight dry)	Program Selector	Washing Type Buttons
Cottons/Linen	5kg	린스처리 (CONDITIONER)	편 린넨 (COTTONS/LINEN)
Easy-Cares	2.5kg		취급용이물 (EASY-CARES)
Delicates	2.5kg		섬세물 (DELICATES)
Woolens	2kg		울재물 (WOOLLENS)

Separate Rinsing

Type of Washing	Max. Load (weight dry)	Program Selector	Washing Type Buttons
Cottons/Linen	5kg	헝굼 (RINSE)	편 린넨 (COTTONS/LINEN)
Easy-Cares	2.5kg		취급용이물 (EASY-CARES)
Delicates	2.5kg		섬세물 (DELICATES)
Woolens	2kg		울재물 (WOOLLENS)

Separate Spinning

Type of Washing	Max. Load (weight dry)	Program Selector	Washing Type Buttons
Cottons/Linen	5kg	탈수 (SPIN)	편 린넨 (COTTONS/LINEN)
Easy-Cares	2.5kg		취급용이물 (EASY-CARES)
Delicates	2.5kg		섬세물 (DELICATES)
Woolens	2kg		울재물 (WOOLLENS)

Cleaning and caring

In daily use

- ☞ After the program has finished pull out the detergent compartment a little so that it can dry out.
- ☞ Only lean the door to after washing so that the washing machine is aerated from the inside and can dry out.
- ☞ Close the tap.

Control panel

Attention! Do not use household furniture polish or aggressive detergents to clean the panel and operating parts

- ☞ Wipe over the operating panel with a damp cloth. Only use warm water.

Detergent compartment

Now and again the detergent compartment should be cleaned.

- ☞ Pull out the detergent compartment as far as it will go.
- ☞ Remove the detergent compartment by pulling heftily.
- ☞ Remove the suction cap.

- ☞ Clean the suction cap under running water.

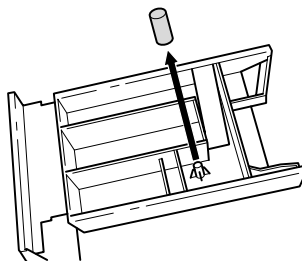

☞ Clean the separate compartments with warm water from the back. A bottle brush is a useful help here.

☞ Push on the suction cap until the stop, so that it is sitting tightly.

☞ Clean the entire detergent compartment inside area with a brush.

☞ Insert the detergent compartment into the guides and push it in.

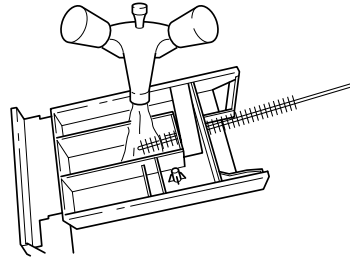

Washing machine drum

The washing machine drum is made from rust-free stainless steel. Rusty foreign bodies in the washing can cause rust deposits on the drum.

Attention! Do not clean the stainless steel drum with descaling agents containing acids, scouring agents containing chlorine or iron or steel wool. Our customer service department has suitable agents available.

☞ Remove rust deposits on the drum with a stainless steel cleansing agent.

Door

☞ Regularly check if there are deposits or foreign bodies in the rubber sleeve behind the door and remove them if applicable.

Precautionary measures in the event of a risk of frost

i Damages caused by frost are not covered by the warranty! If the washing machine is in a room with a risk of freezing, in the event of a risk of freezing, an emergency emptying has to be done (see "Executing an emergency emptying"). Additionally:

☞ Unscrew the inlet hose from the tap and place it on the floor.

Troubleshooting

i The whistling noise when spinning which is somewhat different compared with older washing machines is due to the modern drive system.



Remedy

In the event of a problem, try to eliminate it with the help of the information provided here. If you call out the customer service to eliminate one of the problems listed here or to solve an operating error, a charge is levied even during the warranty time.

Malfunction	Possible cause	Remedy
Washing machine does not work.	The mains plug is not connected.	Plug in the mains plug.
	The fuse of the household electrical system is faulty.	Replace or switch on the fuse.
No water runs in.	The door is not correctly closed.	Close the door; you must hear a click as it locks.
	The tap is closed.	Press 커짐 (ON/OFF) button; Open tap; Reselect program; Press 커짐 (ON/OFF) button again.
	The sieve in the clamp of the inlet hose is blocked.	Unscrew the hose from the tap, remove the sieve and clean it under flowing water.

Malfunction	Possible cause	Remedy
Washing machine vibrates during operation or is unsteady.	The height-adjustable screw feet are not correctly set.	Adjust the feet according to the installation and connection instruction.
	There is only very little washing in the machine (e.g. only a bath robe).	This does not hinder the machine from functioning correctly.
	Water could not be completely pumped out before the spin because there is a kink in the outlet hose or the suds pump is blocked.	Check that the outlet hose is correctly laid and if applicable eliminate the kink or clean the suds pump and if necessary remove any foreign bodies from the pump housing.
The suds in the main wash cycle create too much foam.	Probably too much washing powder was used.	Only use as much as the washing powder manufacturer recommends.
Water is leaking out from under the washing machine.	The clamp on the inlet hose is not tight.	Tighten the inlet hose.
	The inlet hose has a leak.	Check the inlet hose and if necessary replace it.
	The lid of the suds pump is not correctly closed.	Close the lid correctly.
	Washing is caught in the door.	Abort the program, remove the washing caught in the door, start a new program.
Fabric softener is not added,  compartment for fabric softener is filled with water.	Suction cap in the compartment for fabric softener is not correctly fitted or is blocked.	Clean the detergent compartment, fit the suction cap on firmly.
Washing has not been spun, there is water left in the drum.	Rinse hold is selected.	Deselect Rinse hold.
	The soaking program has been completed.	Pump out the water and set the main wash cycle required.

Malfunction	Possible cause	Remedy
Washing has not been spun well, there is water left in the drum.	Drain hose is kinked.	Eliminate the kink.
	Maximum pumping height (drain height 1 m from the position of the machine) is exceeded.	Please contact the customer service, it has a retro-kit available for pump heights above 1 m.
	Suds pump is blocked.	Switch off the machine and pull the plug out of the socket, clean the suds pump.
	If a siphon is connected: the siphon is blocked.	Clean the siphon.
The door cannot be opened.	Program is not yet finished, 커짐 꺼짐 (ON/OFF) display lamp lights up.	Wait until the 커짐 꺼짐 (ON/OFF) lamp goes out.
The rinse water is cloudy.	Probably caused by a washing powder with a high silicate content.	This does not negatively affect the rinse results. If necessary use liquid detergent.
Remnants of detergent are building up in the detergent drawer.	Tap is not fully open.	Open tap fully.
	The sieve in the threaded fitting on the water inlet hose at the tap is blocked.	Clean sieve.
	Sieve on threaded fitting for the water inlet hose on the machine is blocked.	Clean sieve.
Program selector skips 예비세탁 (PRE WASH).	예비세탁 (PRE WASH) combined with 울재폴 (WOOLLENS).	예비세탁 (PRE WASH) cannot be combined with 울재폴 (WOOLLENS).
Program selector stops at 담금질 (SOAKING).	담금질 (SOAKING) combined with 울재폴 (WOOLLENS).	담금질 (SOAKING) cannot be combined with 울재폴 (WOOLLENS).
Stain remover is not washed in.	얼룩제거 (STAIN) combined with 울재폴 (WOOLLENS).	얼룩제거 (STAIN) cannot be combined with 울재폴 (WOOLLENS).

If the washing results are not satisfactory

If the washing turns greyish and limescale deposits are present in the drum

- Insufficient washing powder has been added.
- Incorrect washing powder was used.
- Special stains were not pretreated.
- Program or temperature was not set correctly.
- When using modular washing powders the individual components were not used in the correct ratio.

If there are still grey stains on the washing

- Washing soiled with ointments, grease or oils was washed with insufficient washing powder.
- The temperature selected for the wash was too low.
- A frequent cause is that fabric softener especially a concentrated one has come into contact with the washing. Wash out these types of stains as fast as possible and use the fabric softener carefully.

If after the final rinse foam is still visible

- Modern washing powders can still cause foam in the final rinse cycle. The washing is nevertheless sufficiently rinsed.

If there are white residues on the washing

- These are insoluble contents of modern washing powders. They are not the result of an insufficient rinse. Shake out the washing or brush it off. Perhaps you should turn the washing inside out in future before washing it. Review your choice of powder, possibly use liquid detergents in future.

Executing an emergency emptying

! **Warning!** Switch off the washing machine and pull the mains plug before an emergency emptying!

If the washing machine no longer pumps out the washing suds an emergency emptying must be carried out.

Caution! The washing suds, which flow out of the emergency emptying hose can be hot. Risk of scalding! First allow the suds to cool down before an emergency emptying!

☞ Put down a flat container to catch the suds draining out.

☞ Pull down the flap in the left corner of the base strip and remove it.

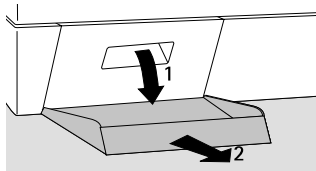

☞ Release the emergency emptying hose from its holder.

☞ Pull the emergency emptying hose out a little.

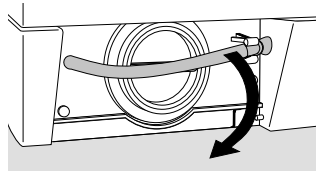



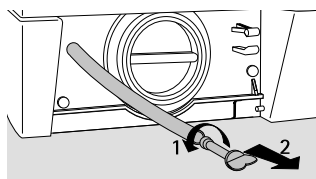

☞ Place the container underneath to catch the water.

☞ Release the plugs of the emergency emptying hose by turning them anti-clockwise and pull them out.

The suds drain out. Depending on the amount of suds, it may be necessary to empty the container to catch the water several times. To do this, temporarily close the emergency emptying hose again with the plugs.







When the suds have drained out completely:

-  Push the plug firmly back into the emergency emptying hose.
-  Push the emergency emptying hose back in a little and let it catch onto the holder.
-  Replace the flap in the base plate and close it.
-  When the washing machine is completely empty, the ÖKO gate can no longer function correctly. Therefore before the next wash fill in approx 1l water (pour it in through the washing powder compartment).

Cleaning the suds pump

 **Warning!** Switch off the washing machine and pull the mains plug before cleaning the suds pump!

-  First execute an emergency emptying (see previous section "Executing an emergency emptying").
-  Place a floor cloth on the floor in front of the lid of the suds pump. Left over water could flow out.
-  Unscrew the lid of the suds pump by twisting it anti-clockwise and pull it off.
-  Remove any foreign bodies which may be in the pump housing.

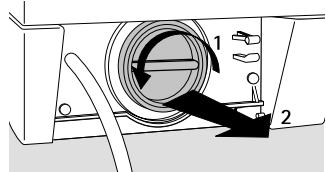

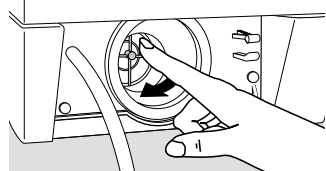

-  Check whether the impeller of the pump can be turned. (It is normal for the pump to jerk when running.) If the impeller cannot be turned at all please contact your customer service department.

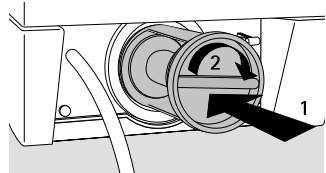

-  Replace the lid (insert the ridges on the lid into the guiding slots) and screw on tightly in a clockwise direction.



-  Close the emergency emptying hose, push it in and fasten it.
-  Close the flap.

Additional Rinse/Water Cooling

The washing machine is set up for extremely low water consumption.

- However, for people who suffer from an allergy to detergents, it can be useful to rinse with more water (additional rinse).
- It may be necessary to cool the water before it is pumped out in order to prevent damage to plastic waste pipes (water cooling).

You can activate these functions using the More Water Switch.



The program duration and water consumption are increased by water cooling and/or the additional rinse.

Position "1": Water Cooling

The water is cooled prior to pumping out at the end of the main wash (by adding cold water). This setting is only effective for **면/린넨** (COTTONS/LINEN) at a temperature of over 40 °C.

Position "2": Water Cooling and Additional Rinse

The water is cooled as in position 1, and an additional rinse is also performed during the **면/린넨** (COTTONS/LINEN), **취급용이물** (EASY-CARES) and **섬세물** (DELICATES) programs.



As supplied the More Water Switch is set to position 0.

Making the Adjustment:



1. Pull out the detergent drawer until the More Water Switch is accessible in the frame on the left.
2. Set the More Water Switch to "1" (water cooling) or "2" (water cooling and additional rinse).

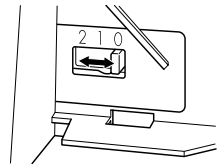

Technical data

Height x width x depth	85x60x60cm
Depth with the door opened	95cm
Height adjustability	approx. +10/-5 mm
Empty weight	approx. 85kg
Full load (depending on the program)	max. 5kg
Area of application	household
Drum speed when washing	max. 53rpm ⁻¹
Drum speed when spinning	see type plate
Water pressure	1-10bar (=10-100N/cm ² = 0.1-1,0MPa)

CE This appliance complies with the following EC directives:

- 73/23/EEC of 19/2/1973 'Low voltage directive'
- 89/336/EEC of 3/5/1989 'EMC directive' including the Modification directive 92/31/EEC

Power supply

Please refer to the type plate for specifications about the power supply. The nominal voltage stated on the type plate and type of current must be identical with the nominal voltage and type of current at the point of installation. Also refer to the type plate for the fuse required.

Information for the electrician

When connecting the appliance without a plug, care must be taken that this is done correctly. Please follow the relevant information in the "Installation and connection instructions" section.

For appliances with variable voltage settings, the switch-over diagram can be found on the cover of the connection box at the back of the appliance.

Index

A

Abort the program 23

C

Conditioners

liquid 13, 20

Conditioning 11, 26

Cotton Mixtures 16

Cottons 12, 16, 24, 26, 27

Curtains 15

Customer service 29, 39

D

Delay Timer 8, 10, 12, 22

Delicates 12, 16, 25, 26, 27

E

Easy-Cares 12, 16, 25, 26, 27

Energy saving program 8, 11, 24

Executing an emergency emptying ... 34, 35

F

Fabric softener 7, 9, 13, 20

L

Linen 12, 16, 24, 26, 27

Liquid detergent 17

M

Main detergent 13, 20

Main Wash 10, 24, 25

N

Net Curtains 16, 25

O

ÖKO gate 8, 14, 35

P

Pre Wash 10, 20, 24, 25

Prewash agent 13, 20

Program progress 11

Pump Out 11, 23

Q

Quick Wash 10, 24, 25

R

Rinse 11

Rinse hold 8, 10, 12, 22

S

Silk 16

Soaking 11, 26

Soaking agent 13, 20

Spin 8, 10, 11, 12, 22, 23, 27

Stain 7, 10, 20, 24, 25

remover 13, 20

Starching 26

Suds pump 9, 35

T

Type plate 9, 39

W

Warranty 29

Washing

coloured 15

delicate 15, 16

double layers 15

easy-care 16

normally soiled 7

slightly soiled 7, 17

soaking 20

starching 20

Washing powders 9, 13, 20

Water

hardness 7, 17

pumping out 11, 23

softener 7, 13, 17, 20

Woollens 12, 16, 25, 26, 27

Service

In the chapter "Troubleshooting" some disturbances have been summarised, which you can solve yourself. If you do not find any helpful information there, please contact your local Customer Service Centre. Addresses and phone numbers can be found in the separate "Guarantee Conditions/Service Departments" (supplied with the appliance).

Be well prepared before you phone. This facilitates the diagnosis and the decision as to whether a customer service visit is necessary. With our checklist you can gather important information before making your call:

Make a note of the PNC number and the Serial number (S-No.). They are both on the type plate behind the door of your washing machine.

PNC

S-No.

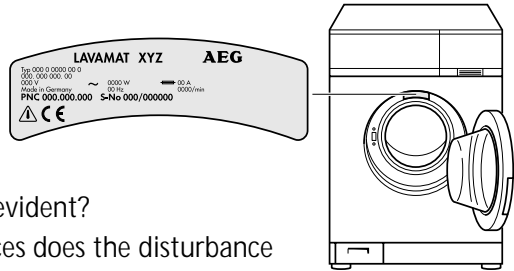

If possible establish:

- How is the disturbance evident?
- Under what circumstances does the disturbance occur?

When do you incur costs even during the warranty period?

- if you could have solved the disturbance yourself with the help of the Troubleshooting table (see section "Troubleshooting"),
- if the customer service engineer has to make several journeys because he did not receive all the necessary important information before his visit and now e.g. has to fetch spares. You can avoid these extra trips by preparing your telephone call properly in the way described above

AEG Hausgeräte GmbH
Postfach 1036
D-90327 Nürnberg

<http://www.aeg.hausgeraete.de>

© Copyright by AEG

H 243 273 194 - 01- 0999