



Radeon[®] X1650 PRO

User's Guide

P/N 137-41146-10

The image shows the top portion of a document page. It features a decorative horizontal band with a fiery, orange and yellow gradient background. Overlaid on this band are several elements: the text 'ATI Technologies' in white on the left; the words 'MULTI-GPU' in a stylized, glowing font in the center; and 'x2' and 'crossfire' in a smaller, glowing font on the right. A central graphic of a pixelated, white and grey arrow points to the right. The page number 'iii' is located in the top right corner, above the decorative band.

ATI Technologies

x2 crossfire

MULTI-GPU

Copyright © 2006, ATI Technologies Inc. All rights reserved.

ATI, the ATI logo, and ATI product and product-feature names are trademarks and/or registered trademarks of ATI Technologies Inc. All other company and/or product names are trademarks and/or registered trademarks of their respective owners. Features, performance and specifications are subject to change without notice. Product may not be exactly as shown in diagrams.

Reproduction of this manual, or parts thereof, in any form, without the express written permission of ATI Technologies Inc. is strictly prohibited.

Disclaimer

While every precaution has been taken in the preparation of this document, ATI Technologies Inc. assumes no liability with respect to the operation or use of ATI hardware, software or other products and documentation described herein, for any act or omission of ATI concerning such products or this documentation, for any interruption of service, loss or interruption of business, loss of anticipatory profits, or for punitive, incidental or consequential damages in connection with the furnishing, performance, or use of the ATI hardware, software, or other products and documentation provided herein.

ATI Technologies Inc. reserves the right to make changes without further notice to a product or system described herein to improve reliability, function or design. With respect to ATI products which this document relates, ATI disclaims all express or implied warranties regarding such products, including but not limited to, the implied warranties of merchantability, fitness for a particular purpose, and non-infringement.

Macrovision

Apparatus Claims of U.S. Patent Nos. 4,631,603; 4,819,098; 4,907,093; and 6,516,132 licensed for limited viewing uses only.

This product incorporates copyright protection technology that is protected by US patents and other intellectual property rights. Use of this copyright protection technology must be authorized by Macrovision, and is intended for home and other limited viewing uses only unless otherwise authorized by Macrovision. Reverse engineering or disassembly is prohibited.

Documentation Updates

ATI is constantly improving its product and associated documentation. To maximize the value of your ATI product, you should ensure that you have the latest documentation. ATI's documentation contains helpful installation/configuration tips and other valuable feature information.



IMPORTANT SAFETY INSTRUCTIONS

- **Read Instructions** - All the safety and operating instructions should be read before the product is operated.
- **Retain Instructions** - The safety and operating instructions should be retained for future reference.
- **Heed Warnings** - All warnings on the product and the operating instructions should be adhered to.
- **Compatibility** - This option card is for use only with IBM AT or compatible UL Listed personal computers that have Installation Instructions detailing user installation of card cage accessories.
- **Grounding** - For continued protection against risk of electric shock and fire, this accessory should be installed only in products equipped with a three-wire grounding plug, a plug having a third (grounding) pin. This plug will only fit into a grounding-type power outlet. This is a safety feature. If you are unable to insert the plug into the outlet, contact your electrician to replace the obsolete outlet. Do not defeat the safety purpose of the grounding-type plug.
- **Secure Attachment** - All card securement pins shall be completely tightened as to provide continuous bonding between the option card and the PC chassis.
- **Lightning** - For added protection for this product during a lightning storm, or when it is left unattended and unused for long periods of time, unplug it from the wall outlet, and disconnect the antenna or cable system. This will prevent damage to the product due to lightning and power-line surges.
- **Power Lines** - An outside antenna system should not be located in the vicinity of overhead power lines or other light or power circuits, or where it can fall into such power lines or circuits.
- **Antenna Installation** - When installing an outside antenna system, extreme care should be taken to keep from touching such power lines or circuits, as contact with them may be fatal.

Note: This graphics card is for use only with compatible UL Listed personal computers that have Installation Instructions detailing user installation of card cage accessories.

Table of Contents

Introduction	1
Radeon® X1650 PRO Features	1
System Requirements	4
Using Multiple Displays	7
Display Configurations	9
Using TV Display and Capture Features	11
Using TV Out	11
Connecting to a TV or VCR	12
Connecting to HDTV	14
Installing Software and Drivers	17
Installing Drivers and Software in Windows®	17
Monitor Configuration	18
To set up a multi-monitor display	19
Reinstalling Drivers	19
Installing the Catalyst™ Software Suite	20
Catalyst™ Control Center	23
Launching Catalyst™ Control Center	23
CrossFire™ FAQ	95
Welcome to CrossFire™	101
CrossFire™ Overview	101
Reference	109
Troubleshooting	109
Product Registration	113
Customer Care	113
Additional Accessories	115
Compliance Information	115

Glossary 119
Index 139

CHAPTER 1:

Introduction

Congratulations on the purchase of your ATI Radeon® X1650 PRO graphics card. We hope that you will enjoy countless hours of trouble-free computing.

Radeon® X1650 PRO Features

Features

- 157 million transistors on 90nm fabrication process.
- Dual-link DVI.
- Twelve pixel shader processors.
- Five vertex shader processors.
- 128-bit 4-channel DDR/DDR2/GDDR3 memory interface.
- Native PCI Express x16 bus interface.
- AGP 8x configurations also supported with AGP-PCI-E external bridge chip.
- Dynamic Voltage Control.

Ring Bus Memory Controller

- 256-bit internal ring bus for memory reads.
- Programmable intelligent arbitration logic.
- Fully associative texture, color, and Z/stencil cache designs.
- Hierarchical Z-buffer with Early Z test.
- Lossless Z Compression (up to 48:1).
- Fast Z-Buffer Clear.
- Z/stencil cache optimized for real-time shadow rendering.

Ultra-Threaded Shader Engine

- Support for Microsoft® DirectX® 9.0 Shader Model 3.0 programmable vertex and pixel shaders in hardware.

- Full speed 128-bit floating point processing.
- Dedicated branch execution units for high performance dynamic branching and flow control.
- Dedicated texture address units for improved efficiency.
- 3Dc+ texture compression
 - High quality 4:1 compression for normal maps and two-channel data formats.
 - High quality 2:1 compression for luminance maps and single-channel data formats.
- Multiple Render Target (MRT) support.
- Render-to-vertex buffer support.
- Complete feature set also supported in OpenGL® 2.0

Advanced Image Quality Features

- 64-bit floating point HDR rendering supported throughout the pipeline.
 - Includes support for blending and multi-sample anti-aliasing.
- 32-bit integer HDR (10:10:10:2) format supported throughout the pipeline.
 - Includes support for blending and multi-sample anti-aliasing.
- 2x/4x/6x Anti-Aliasing modes.
 - Multi-sample algorithm with gamma correction, programmable sparse sample patterns, and centroid sampling.
 - New Adaptive Anti-Aliasing feature with Performance and Quality modes.
 - Temporal Anti-Aliasing mode.
 - Lossless Color Compression (up to 6:1) at all resolutions, including widescreen HDTV resolutions.
- 2x/4x/8x/16x Anisotropic Filtering modes.
 - Up to 128-tap texture filtering.
 - Adaptive algorithm with Performance and Quality options.
- High resolution texture support (up to 4k x 4k).

Avivo™ Video and Display Platform

- High performance programmable video processor.
- Accelerated MPEG-2, MPEG-4, DivX, WMV9, VC-1, and H.264 decoding and transcoding.

- DXVA support.
- De-blocking and noise reduction filtering.
- Motion compensation, IDCT, DCT and color space conversion.
- Vector adaptive per-pixel de-interlacing.
- 3:2 pulldown (frame rate conversion).
- Seamless integration of pixel shaders with video in real time.
- HDR tone mapping acceleration.
 - Maps any input format to 10 bit per channel output.
- Flexible display support.
 - Dual integrated 10 bit per channel 400 MHz DACs.
 - 16 bit per channel floating point HDR and 10 bit per channel DVI output.
 - Programmable piecewise linear gamma correction, color correction, and color space conversion (10 bits per color).
 - Complete, independent color controls and video overlays for each display.
 - High quality pre- and post-scaling engines, with underscan support for all outputs.
 - Content-adaptive de-flicker filtering for interlaced displays.
 - Xilleon™ TV encoder for high quality analog output.
 - YPrPb component output for direct drive of HDTV displays*.
 - Spatial/temporal dithering enables 10-bit color quality on 8-bit and 6-bit displays.
 - Fast, glitch-free mode switching.
 - VGA mode support on all outputs.
 - Drive two displays simultaneously with independent resolutions and refresh rates.
- Compatible with ATI TV/Video encoder products, including Theater 550.

CrossFire™

- Multi-GPU technology.
- Four modes of operation:
 - Alternate Frame Rendering (maximum performance).
 - Supertiling (optimal load-balancing).
 - Scissor (compatibility).
 - Super AA 8x/10x/12x/14x (maximum image quality).

Note: Not all features apply to all Radeon® X1650 PRO graphics cards.

Note: CrossFire™ is supported in Catalyst™ version 5.13

*with optional HDTV adapter available from ATI Online Store.

System Requirements

Hardware	<ul style="list-style-type: none"> • Intel® Pentium® 4 or AMD Athlon®. • 512MB of system memory; 1GB or more for best performance. • Optical drive for installation software (CD-ROM or DVD-ROM drive). • Specialized PCI Express® 350 watt or greater power supply recommended. Consult your computer system manual to ensure the power supply is designed to accommodate a high-end graphics card with a peak dissipation above 75 watts.
Operating System	<ul style="list-style-type: none"> • Windows® XP with Service Pack 2 (SP2). • Windows® XP Professional x64 Edition. • Windows® XP Media Center Edition. • Windows® Vista Ready.
Monitor	<ul style="list-style-type: none"> • High-resolution MultiSync or multi-frequency monitors or any other type of VGA monitor. • Digital flat-panel (DFP) displays or digital CRT display.
CrossFire™ Compatibility	<p>If you are planning on using this graphics card as part of a CrossFire™ system, the following is required:</p> <ul style="list-style-type: none"> • A CrossFire™ certified motherboard with two (2) PCI Express® X16 slots and correct PCIe™ chipset driver. (See ati.com/crossfire for a list of CrossFire™ certified motherboards.) • Another standard Radeon® X1650 PRO graphics card. The Radeon® X1650 PRO does not require a CrossFire™ Edition card for CrossFire™ support. <p>More information on the requirements for each of these components can be found within the CrossFire™ FAQ.</p>

Uninstall Previous Graphics Card Drivers

To ensure the successful installation of your new Radeon® X1650 PRO card, you must uninstall the drivers for the existing graphics card before removing it from your computer.

To uninstall previous drivers

With your current graphics card still in your computer:

- 1 Close all applications that are currently running.
- 2 Navigate to the **Control Panel** and select **Add/Remove Programs**.
- 3 Select your current graphics card drivers and select **Add/Remove**. The wizard will help you remove your current display drivers.

Note: If the previously installed graphics card has any additional software installed, it should also be removed at this point.

- 4 Turn off your system and remove the old graphics card.

CHAPTER 2:

Using Multiple Displays

Connecting Your Monitors

Your Radeon® X1650 PRO graphics card provides hardware support for two DVI-I monitors and a VGA monitor using the supplied DVI-I-to-VGA adapter. It also provides TV output via an S-Video Out connector.

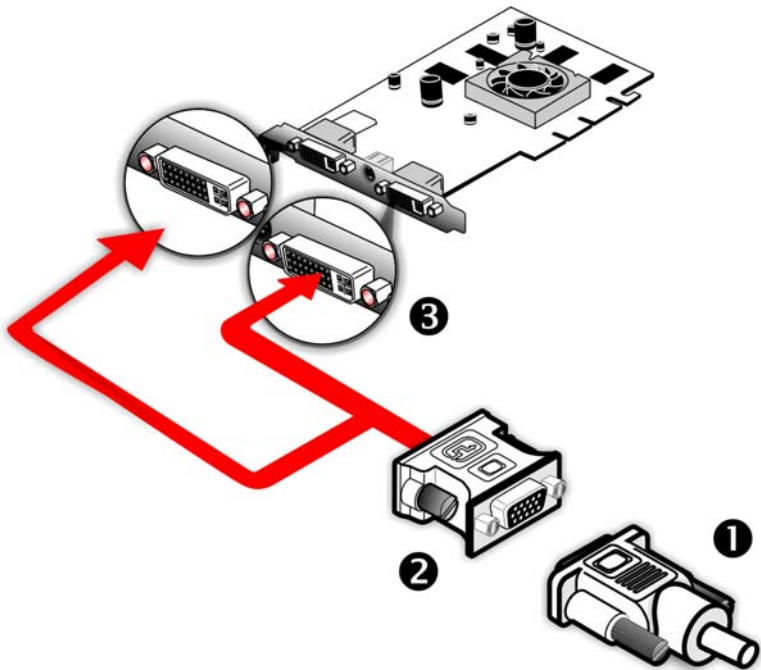

Connections and Adapters for the Radeon® X1650 PRO Card

- 1 Standard VGA Monitor Connector.** To connect a VGA monitor to the DVI-I connector, plug the supplied DVI-I-to-VGA adapter into the DVI-I connector, then plug your monitor cable into the adapter.

 - 2 DVI-I-to-VGA Adapter.**

 - 3 DVI-I Connection.** To connect a digital display.
-

Note: If you use multiple monitors, the Radeon® X1650 PRO card must be the primary graphics card. Normally, the system BIOS determines which graphics card will be the primary.

Note: The top DVI-I connector is single-link and the bottom connector is dual-link.

Note: Some Radeon® X1650 PRO graphic cards have one DVI-I connector and one VGA connector.

To connect your monitors

- 1 Power off your computer and monitors.
- 2 Plug the monitor cables into their appropriate connectors.
- 3 Power on your monitors first, and then restart your computer so that Windows® can detect the new hardware settings.
- 4 When the **New Hardware Found** Wizard appears, at the appropriate prompt insert the ATI Installation CD to load the drivers for your Radeon® X1650 PRO card.

To set up a multi-monitor display

- 1 From the **Start button** click **Control Panel**, then **Display**. Click the **Settings** tab to access the basic multi-monitor configuration settings.

Note: ATI provides Catalyst™ Control Center software that provides many additional configuration features. It can be accessed by clicking the **Advanced** button from the **Display Properties > Settings** tab.

- 2 Select the **Monitor** icon identified by the number **2**.
- 3 Click **Extend my Windows desktop onto this monitor**.
- 4 Set the **Screen Resolution** and **Color Quality** as appropriate for the second monitor. Click **Apply** or **OK** to apply these new values.
 - Refer to your Windows® online help and documentation for further information on using the **Settings** tab.

Note: When you use multiple monitors with your card, one monitor will always be **Primary**. Any additional monitors will be designated as **Secondary**.

Display Configurations

Your Radeon[®] X1650 PRO graphics card provides dual display functionality. The following table lists the different ways you can connect displays to your card.

Display Configuration	Connector(s) Used	Comments
Single DFP display	DVI-I connector	DFP - digital flat panel display.
Single CRT display	DVI-I connector with DVI-I-to-VGA adapter	CRT - cathode ray tube analog display.
CRT display + HDTV	DVI-I-to-VGA adapter + Component Adapter to HDTV (YPbPr) cable	
DFP display + HDTV	DVI-I connector + HDTV cable (YPbPr)	HDTV (YPrPb) adapter available from shopati.com .
CRT display + DFP display	DVI-I-to-VGA adapter + DVI-I connector	
CRT display + CRT display	DVI-I-to-VGA adapter + DVI-I-to-VGA adapter	The DVI-I connector can support a CRT display using the DVI-I-to-VGA adapter

CHAPTER 3:

Using TV Display and Capture Features

This chapter describes how to use the TV display and video capture features of your Radeon® X1650 PRO card.

Using TV Out

Your Radeon® X1650 PRO has TV Out capability.

Viewing Your PC Display on a TV

You can attach your Radeon® X1650 PRO to a TV and a monitor at the same time. You can also connect it to your VCR and record your monitor's display.

Note: A TV can only be connected to one DVI connector.



IMPORTANT INFORMATION for European Customers

Some PC monitors in Europe **cannot** be used simultaneously with TV display. When you enable TV display in Europe, the refresh rate for the monitor and TV is set to 50 Hz. Some monitors may not support this refresh rate **and could be damaged**.

- Please check the documentation supplied with your monitor to see if your monitor supports a refresh rate of 50 Hz.
- If your monitor does not support 50 Hz (or if you are not sure), turn off your monitor before turning on your PC when using your TV as a display.

TV display is ideal for giving presentations and watching movies, or playing games on a screen larger than a typical monitor. The following tips will help you get the most out of your TV Out feature.

Connecting to a TV or VCR

To connect your Radeon® X1650 PRO card to a TV or VCR, use an S-Video cable. Many TVs (and VCRs) have a Composite video input, in which case you can use the supplied S-Video-to-Composite video adapter. If your TV has cable input only, you can connect your graphics card to your TV through your VCR or an RF modulator that is available from most electronics stores.

To connect S-Video Out

- 1** Power off your computer and your TV (or VCR).
- 2** Determine if your TV (or VCR) supports either a S-Video or Composite video connection.
- 3** Looking at the back of your PC, locate your S-Video Out. Using an S-Video cable or the supplied adapter cable, attach one end of the cable to your graphics card and the other to your TV (or VCR). Refer to the illustration.
- 4** Power on your TV (or VCR) first, then your computer.

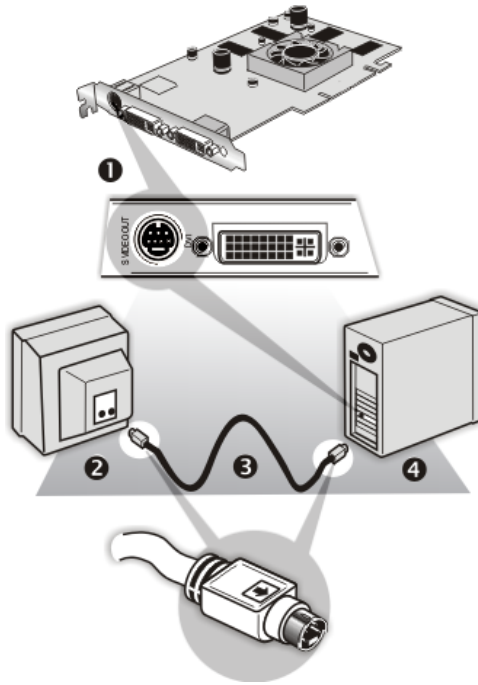

Connecting Your S-Video Out to a TV or VCR

- | | |
|---|--|
| 1 | S-Video Connection on graphics card |
| 2 | TV or VCR |
| 3 | S-Video Cable (with or without S-Video-to-Composite Adapter) |
| 4 | Computer |
-

Using a Monitor vs. Using TV Display

Using your TV for your computer's display can be useful; however, the display on your monitor may change or look squashed. This distortion occurs because the display adjusts to fit the dimensions of your TV. To correct the monitor's display, use the monitor's control buttons to adjust its display size and position.

Some single-frequency monitors may not work with TV display enabled. If you experience problems when TV display is enabled, disable TV display to restore your monitor's display.

Viewing Text on a TV

A TV is designed primarily to show moving images. The large dot pitch of a TV will yield poor quality static images. The small text sizes commonly used for PC desktops can appear blurred or unclear on a TV. You can compensate for this degradation by using larger fonts.

Using a TV as the Only Display

If you plan to move your computer to a place where you are using TV display only, make sure that you have the TV display feature enabled prior to removing the monitor.

The maximum display resolution for TV is 1024 x 768. Choosing a resolution higher than this will cause the TV display to disappear if it is the only display device.

Using Games and Applications

Some older games and applications may program your Radeon[®] X1650 PRO directly to run under a specific display mode. This may cause your TV display to turn off automatically or become scrambled (your PC monitor or portable LCD display will not be affected). Your TV display will be restored once you exit the game or if you restart your computer.

Connecting to HDTV

View computer output directly on your High Definition Television (HDTV) or other component input device. Provide a big-screen experience for your computer that is ideal for playing games, giving presentations, watching movies, and browsing the Internet.

HDTV uses YPbPr connectors to receive input. YPbPr stands for the following:

- Y = Green
- Pb = Blue
- Pr = Red

The HDTV Component Video Adapter can be used in place of the standard A/V Output cable to connect to an HDTV or other component input device, using component video cables.

- i** You must have a monitor attached to your computer before installing the ATI HDTV. For proper operation of your ATI Component Video Adapter, ATI display drivers must be correctly installed.

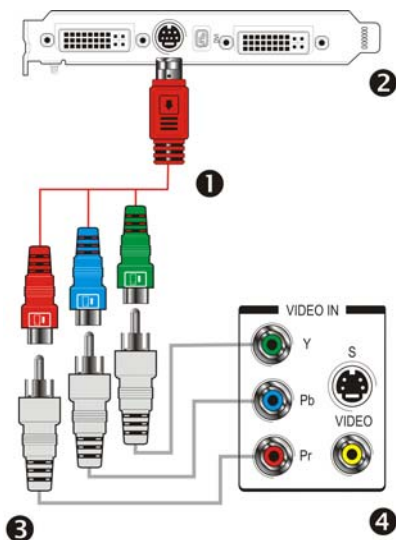

ATI HDTV Cable

- | | |
|---|--|
| 1 | ATI HDTV Video Output Cable |
| 2 | Backplate of the ATI Graphics Card |
| 3 | Male RCA Patch Cables – available from consumer electronics dealer |
| 4 | Typical HDTV Video Input Connections |

Note: Input and output cables lengths should not exceed 50 feet (15m).

Installing your ATI HDTV video cable

- 1 Turn on your component input device, and set it to YPbPr input.

Note: See your HDTV or component input device manual for configuration information specific to your device.

- 2 Turn on your computer.

Note: Your TV will not display anything until Windows starts. This can take several minutes.

Using Your ATI HDTV Video Cable

Use the HDTV Video Cable to watch DVD movies and play video games on your High Definition Television.



Copy-protected DVDs restrict playback to 480i and 480p modes.

For maximum performance when you watch DVD movies or play computer games on your HDTV, you should find the mode and screen resolution that provide the best result on your TV, and use those settings exclusively.

CHAPTER 4:

Installing Software and Drivers

This chapter will guide you through the installation of the drivers and software associated with your Radeon® X1650 PRO graphics card.

Installing Drivers and Software in Windows®

You will need to install the Radeon® X1650 PRO drivers and software in the following cases:

- After you have installed the card in your system.
- After you have reinstalled or upgraded your operating system.

This procedure applies to Windows® XP.

Software Installation Prerequisites

To install or remove the drivers, you must have administrator rights or be logged on as a user with administrator rights.

Your operating system must be installed and running before you can install the Radeon® X1650 PRO drivers. Also, make sure that you have installed Service Pack 2 for Windows® XP.

Make sure your monitor cable is properly attached before you begin.

Note: The installation dialog will display in English if your operating system's language is not supported.

To install ATI drivers and software

Note: Optical drive refers to CD-ROM or DVD-ROM drive.

- 1 Start your system. When the **Found New Hardware Wizard** appears, click **Cancel**. When the **System Settings Change** window asks you to restart your computer, click **No**.

- 2 Run the **ATISSETUP** utility. The **ATISSETUP** utility will start automatically when you insert the ATI Installation CD-ROM into your optical drive after the operating system has started. If your CD-ROM auto-run is not enabled or the **ATISSETUP** utility does not start automatically:
 - a) Click the **Start** button in the task bar.
 - b) Click **Run**.
 - c) Select **ATISSETUP.EXE** from the root directory of the ATI Installation CD-ROM.
 - d) Click **OK**.
- 3 Click **Install** under Software Install.
- 4 Click **Next**.
- 5 Click **Yes** to the license agreement. **ATI Easy Install** will start the **Installation Wizard**.
- 6 Follow the wizard's on-screen instructions to complete the installation.



The Express installation option is recommended. By selecting this option, the HydraVision™ multi-monitor and desktop management software will automatically be installed, along with the ATI driver. Not all software components are installed using the Express installation. Custom installation allows you to select individual software components for installation.

- 7 When the Setup Complete message appears, select **Yes, I want to restart my computer now** and click **Finish**.
- 8 After the system reboots, the **Found New Hardware** message displays **Digital Signature Not Found**. Click **Yes** or **Continue** to complete the driver installation.

Monitor Configuration

Once the drivers and software have been installed, you can configure your monitor.



Warning - Choosing a refresh rate unsupported by your monitor may damage your monitor. Consult your monitor's documentation if necessary.

To configure your primary display

- 1 Navigate to the **Control Panel** and choose **Display**, or right-click on the desktop and choose **Properties**.
- 2 Choose the **Settings** tab and select the screen resolution and color depth that best suit your requirements and your monitor's performance.
- 3 Click **Advanced** and select the **Monitor** tab.
- 4 Choose a refresh rate from the drop-down list.
- 5 Click **OK** to return to the desktop.

To set up a multi-monitor display

- 1 From the **Start** menu click **Control Panel**, then **Display**. Click the **Settings** tab to access the basic multi-monitor configuration settings.
- 2 Select the **Monitor** icon identified by the number 2.
- 3 Click **Extend my Windows desktop onto this monitor**.
- 4 Set the **Screen Resolution** and **Color Quality** as appropriate for the second monitor. Click **Apply** or **OK** to apply these new values.
 - Refer to your Windows® online help and documentation for further information on using the **Settings** tab.

Note: When you use multiple monitors with your Radeon® X1650 PRO card, one monitor will always be **Primary**. Any additional monitors will be designated as **Secondary**.

Note: You can also enable multiple monitors using ATI's Catalyst™ Control Center.

Reinstalling Drivers

You can install new drivers or reinstall existing drivers if there was a Windows® conflict.

Reinstall the drivers at any time using the **ATISSETUP** utility located on the ATI Installation CD-ROM. The **ATISSETUP** utility will start automatically if you insert the ATI Installation CD-ROM into your optical drive after the operating system has started.

To manually reinstall drivers

If your CD-ROM auto-run is not enabled and the **ATIS SETUP** utility does not start automatically, follow these steps.

- 1 In the Windows® task bar, click **Start**.
- 2 From the **Start** menu, select **Run**.
- 3 Browse to **SETUP.EXE** on the root directory of the ATI Installation CD-ROM.
- 4 Click **OK**.

Installing the Catalyst™ Software Suite

ATI's Catalyst™ Software Suite provides software required to enjoy all the features of your ATI graphics card. The Catalyst™ Software Suite has several distinct software elements, including:

- Driver
- Catalyst™ Control Center
- HydraVision™ (not included in the *Express Install*)
- Remote Wonder™ Software
- SurroundView™

To install the Catalyst™ software suite

Note: Optical drive refers to any drive capable of reading CD-ROM media.

- 1 Insert the ATI Installation CD-ROM into your optical drive.
If Windows® runs the CD-ROM automatically, proceed to step 5.
- 2 Click **Start > Run**.
- 3 Type the following: `D:\ATIS SETUP`
(If D is not your optical drive, substitute the correct drive letter.)
- 4 Click **OK**.
- 5 Click **Install** under Software Install.
- 6 Click **Next** and click **Yes** to the license agreement.
- 7 Click **ATI Easy Install** to begin the Installation Wizard.

- 8 Follow the Wizard's on-screen instructions, then choose either **Express** or **Custom Install**.

Not all software components are installed using the Express installation. Custom installation allows you to select individual software components for installation.

CHAPTER 5:

Catalyst™ Control Center

The Catalyst™ Control Center is a graphical user application providing access to the display features contained within the installed ATI hardware and software. Use the Catalyst™ Control Center to fine-tune your graphics settings, enable or disable connected display devices, and change the orientation of your desktop. Many of the features show you a preview of the changes before they are applied.

The Catalyst™ Control Center offers you two views of the software:

- Basic View is a simplified view that includes wizards to get the inexperienced user up and running.
- Advance View allows the advanced user to access and configure the complete feature set of the software.

The Catalyst™ Control Center can be customized for easy access to the features you use most.

Use the Catalyst™ Control Center to access a comprehensive online help system, or connect to the ATI Web site.

Launching Catalyst™ Control Center

Launch Catalyst™ Control Center from one of the following access points:

- Windows® Start Menu
- Windows® System Tray
- Desktop shortcuts
- Predefined hot keys

Launching Catalyst™ Control Center Using the Start Menu

From the Windows® task bar, click **Start**:

- Click to **Programs > Catalyst™ Control Center > ATI Catalyst™ Control Center**.

Other Quick Launch Access Points

Launching Catalyst™ Control Center Using the System Tray

- 1 Right-click the ATI icon in the Windows® System Tray.
- 2 Select Catalyst™ Control Center from the popup menu.

Launching Catalyst™ Control Center Using the Desktop Shortcut

When you first installed Catalyst™ Control Center the setup wizard provided you with the option of placing a shortcut on the desktop.

- Double-click the Catalyst™ Control Center desktop shortcut.

Launching Catalyst™ Control Center Using Hot Keys

- You can press the predefined combination of keys **Ctrl+Alt+C** to launch Catalyst™ Control Center, or you can define your own hot key sequence by using the Catalyst™ Control Center's Hotkey Manager.

CHAPTER 6:

CrossFire™ FAQ

The following are frequently-asked questions about CrossFire™.

For the latest information, please consult the CrossFire™ Web site at:

ati.com/crossfire

1 What combination of products are required to build a working CrossFire™ system?

Three components are required:

- a CrossFire™ Edition graphics card that works as the Master graphics card.
- a CrossFire™ Ready graphics card from the same brand-family that works as the Slave graphics card.
- a CrossFire™ Ready motherboard (with two PCIe™ X16 slots).

Additional detailed information on the requirements for each of these components can be found within this FAQ.

2 What graphics cards work with CrossFire™?

A CrossFire™ graphics card works with all members of the same brand-family. For example: A Radeon® X1800 CrossFire™ Edition will work with a Radeon® X1800 CrossFire™ Ready graphics card.

3 What motherboards support CrossFire™?

The optimal configuration for a CrossFire™ system is one based on a Radeon® Xpress 200 CrossFire™ Edition motherboard. Motherboards from other manufactures will be certified as CrossFire™ Ready when they become available.

4 Are there specific BIOS motherboard settings for CrossFire™?

On some motherboards, the BIOS may be set by default to support only a single PCI Express® X16 slot. Ensure that both PCIe™ X16 slots are enabled in the BIOS.

For information on configuring your BIOS settings consult the manual that came with your motherboard.

5 Which slot does the CrossFire™ Master card go into on the motherboard?

The CrossFire™ Master card must go into the primary PCI Express® slot (slot zero) on the motherboard.

Note: To determine which PCIe™ slot is the primary slot, consult your motherboard manual.

Alternately, to determine whether or not a CrossFire™ Edition card is in the correct slot, connect your display directly to the DVI-I connection on the Master graphics card instead of using the CrossFire™ DMS-59™/VHDCI connector, with both graphics cards seated in their respective slots on the motherboard. If an image appears on the screen upon boot-up, the card has been placed in the primary slot on the motherboard.

6 Are there any software settings required for CrossFire™ to work?

Yes, there is a setting in the Catalyst™ Control Center that needs to be enabled for CrossFire™ to operate. When all of the hardware and software has been properly set up and installed, the CrossFire™ aspect appears in Catalyst™ Control Center:

To access and enable CrossFire™ in Catalyst™ Control Center, do the following:

- Click **CrossFire™** in Advanced View. Then, select **Enable CrossFire™**.

When CrossFire™ is successfully enabled, all display devices except the one used by CrossFire™ will be disabled. Multiple monitors/displays that are disabled when CrossFire™ is enabled reappear after CrossFire™ is disabled.

To change to Advanced View:

- Click the Dashboard View button and select Advanced View.
- Select Displays Manager in the tree view.

7 What is the difference between a CrossFire™ Edition graphics card and a standard graphics card from the same family?

CrossFire™ Edition graphics cards include a “compositing engine”, a chip that takes the partially rendered image from the Slave graphics card and merges it with the partially rendered image from the Master

graphics card. The result is a complete frame rendered at up to twice the performance of a single graphics card.

8 How are the graphics cards connected on a CrossFire™ system?

The two cards are connected by an external DVI cable. The cable is attached from the Slave graphics card's DVI-I connection to the CrossFire™ Edition's DMS-59™/VHDCI connection, which is used to convey information from the Slave graphics card to the Master graphics card and transmit the combined signal to a display device.

9 Which games/applications work with CrossFire™?

CrossFire™ works with all full-screen 3D games and applications. If Catalyst™ A.I. is enabled in the Catalyst™ Control Center software, the optimal rendering mode available for the application is automatically selected.

10 Is a driver profile required to make CrossFire™ work?

No. CrossFire™ is enabled by default for all full-screen 3D games and applications.

11 What happens if you pair a 16-pipeline CrossFire™ Edition graphics card with a CrossFire™ Ready 12-pipeline graphics card?

In this scenario both graphics cards will operate as 12-pipeline graphics cards while in CrossFire™ mode.

12 What happens if the CrossFire™ Edition graphics card and the CrossFire™ Ready graphics card have different clock speeds?

Both cards will continue to operate at their individual clock speeds; neither card is "stepped down." The compositing engine on the CrossFire™ Edition card merges the resulting images independent of the clock speed on either graphics card.

13 What are the rendering modes, and what are their specific advantages?

The following dynamic rendering modes are available:

- SuperTiling - CrossFire™ renders alternate 32x32 pixel squares in a fine-grained checkerboard pattern. This configuration increases the performance, as each card processes half of the complex 3D objects in the pixel squares.

- Scissor Mode - each graphics card renders up to half of the display, either vertically or horizontally depending on the game or application.
- Alternate Frame Rendering - the two graphics cards are used to render alternate frames of the display. This configuration increases the performance of the 3D objects, as each card handles half of the total number of frames.
- Super Anti-aliasing - improves image quality by combining the results of full-screen anti-aliasing across two graphics cards in a CrossFire™ configuration. The two graphics cards work on different anti-aliasing patterns within each frame.

The first three features are performance features settings automatically selected by ATI's Catalyst™ Control Center. Super Anti-aliasing is a display quality mode selectable using Catalyst™ Control Center.

14 On what basis are different rendering modes chosen?

When Catalyst™ A.I. is enabled in Catalyst™ Control Center, it determines the optimal rendering mode to use, based on the application or game being used. The default rendering mode is dependant on both the hardware configuration and the application being run; typically it will be either Scissor or SuperTiling mode. If Catalyst™ A.I. is not enabled, any Direct 3D® applications that are running on a system based on graphics cards with 16-pipeline graphics processors will use SuperTiling Mode.

15 What type of performance improvement is expected?

Performance enhancements experienced on a CrossFire™ system depend on the application or game being used. Performance improvements can be increased up to 100%, and the latest graphics-intensive programs will generally see over 80% performance improvement at high resolutions and image-quality modes.

16 How many independent displays can be connected to a CrossFire™ system?

While CrossFire™ is designed for optimal use on a single display, it is possible to drive multiple monitors using a CrossFire™ system when CrossFire™ is not enabled. If the motherboard contains an integrated video connection and SurroundView™ is enabled, more displays can be added.

Additional troubleshooting tip are covered in the “Reference” chapter.

CHAPTER 7:

Welcome to CrossFire™

ATI CrossFire™ is the ultimate multi-GPU performance gaming platform, using ATI CrossFire™ ready motherboards and ATI graphics cards.

CrossFire™ Overview

This section provides an overview of the main features and configurations for CrossFire™. These topics will be covered in more detail in other chapters of this manual.

Allowable CrossFire™ System Components

The basic requirements of a CrossFire™ system are a CrossFire™ certified motherboard with two PCI Express® x16 slots, a CrossFire™ Edition graphics card, and a compatible CrossFire™ Compatible graphics card.

A CrossFire™ Edition graphics card works with all members of the same brand-family. Thus a Radeon® X1650 PRO CrossFire™ Edition graphics card can be used with any Radeon X1650 product.

For an up-to-date listing of CrossFire™ certified motherboards, see:

ati.com/crossfire

CrossFire™ Rendering Modes

A CrossFire™ system has four possible display modes:

- SuperTiling
- Scissor Mode
- Alternate Frame Rendering
- Super Anti-aliasing.

The first three are performance-oriented modes, while Super Anti-aliasing is a quality-oriented mode. Each mode uses a different method for dividing the workload required to render a 3D image across multiple GPUs. Only one mode can be in operation at any given time.

The ATI Catalyst™ display driver will automatically select the best of the three performance modes when a 3D application is started, without requiring user intervention. The user can also choose to improve image quality by selecting the new Super Anti-aliasing modes in the Catalyst™ Control Center.

SuperTiling

In this mode, each frame to be rendered is divided into a number of tiles in an alternating checkerboard pattern, so that half of the tiles are assigned to each of the two GPUs. Each tile is kept to a relatively small 32x32 pixel square, so this method does a good job of balancing the workload across each GPU regardless of what is being rendered on the display, doing so without any software overhead.

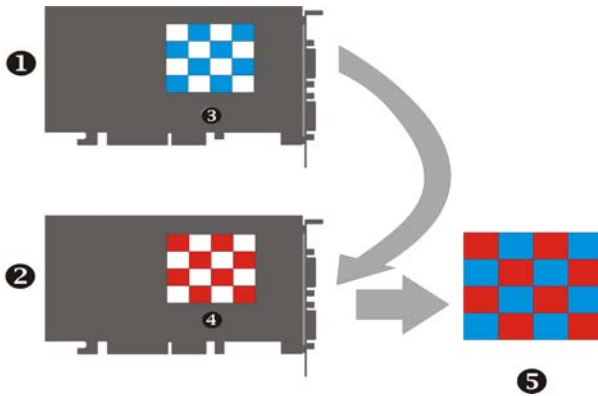

1	PCI Express® CrossFire™ Compatible Graphics Card
2	Radeon® X1650 PRO CrossFire™ Edition Graphics Card
3	Partial Frame Rendered on PCI Express® CrossFire™ Compatible Graphics Card
4	Partial Frame Rendered on PCI Express® CrossFire™ Edition Graphics Card
5	Final Rendered Frame on Display

SuperTiling has the advantage of being able to work with practically any 3D application. However, there are a small number of applications where the SuperTiling workload distribution does not provide optimal performance. For these special cases, Scissor Mode can be used.

Scissor Mode

In this mode, each frame is split into two sections, with each section being processed by one GPU. The ideal configuration is determined automatically for each application.

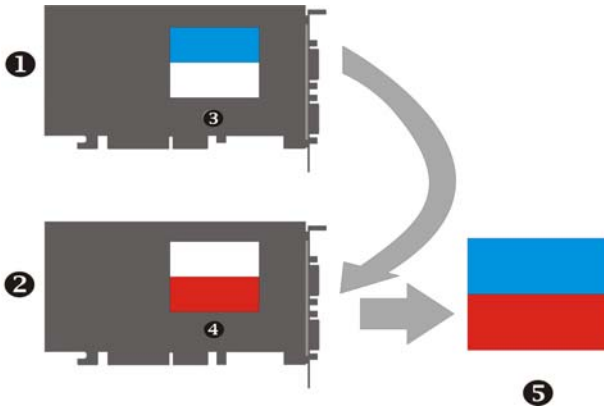

1	PCI Express® CrossFire™ Compatible Graphics Card
2	Radeon® X1650 PRO CrossFire™ Edition Graphics Card
3	Partial Frame Rendered on PCI Express® CrossFire™ Compatible Graphics Card
4	Partial Frame Rendered on PCI Express® CrossFire™ Edition Graphics Card
5	Final Rendered Frame on Display

Although Scissor Mode is generally a less efficient means of splitting the workload than using SuperTiling, there are a few cases where it can be more efficient. It is supported by CrossFire™ in order to maximize compatibility and performance.

Alternate Frame Rendering (AFR) Mode

In this mode, all even frames are rendered on one GPU, while all odd frames are rendered on the other. The completed frames from both GPUs are sent to the Compositing Engine on the CrossFire™ Edition card, which then sends them on to the display. By allowing both GPUs to work independently, AFR provides the greatest potential performance improvements of all the available modes. It is also the only mode that allows the full vertex processing performance of both GPUs to be combined.

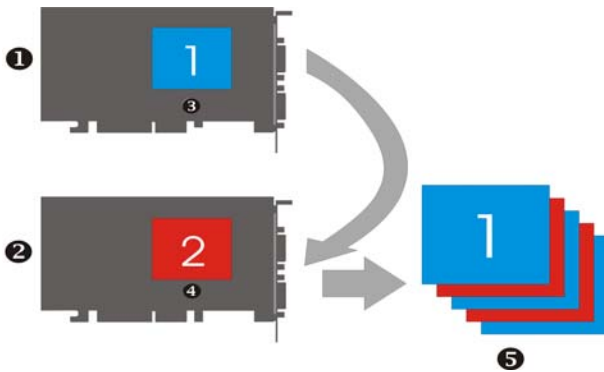

1	PCI Express® CrossFire™ Compatible Graphics Card
2	Radeon® X1650 PRO CrossFire™ Edition Graphics Card
3	Partial Frame Rendered on PCI Express® CrossFire™ Compatible Graphics Card
4	Partial Frame Rendered on PCI Express® CrossFire™ Edition Graphics Card
5	Final Rendered Frame on Display

The main limitation of this mode is that it cannot be used in applications where the appearance of the current frame is dependent upon data generated in previous frames, since AFR generates successive frames simultaneously on different GPUs. In these cases, the SuperTiling or Scissor Mode is used instead.

Super Anti-aliasing Mode

Anti-aliasing (AA) is a rendering technique designed to remove jagged edges, shimmering, and pixelation problems that are common in rendered 3D images. Rather than simply determining the color of each pixel on the screen by sampling a single location at the pixel's center, anti-aliasing works by sampling multiple locations within each pixel and blending the results together to determine the final color.

The latest generation of ATI's Radeon® GPUs with SmoothVision™ HD technology uses a method known as Multi-sample Anti-aliasing (MSAA). This method takes samples from 2, 4, or 6 programmable locations within each pixel, and uses gamma correct sample blending for high-quality smoothing of polygon edges. The new CrossFire Super Anti-aliasing mode takes advantage of the programmable sample capability of SmoothVision™ HD to provide higher quality anti-aliasing on CrossFire™ systems.

It works by having each GPU render the same frame with anti-aliasing enabled, but uses different sample locations for each. When both versions of the frame are completed, they are blended in the CrossFire Compositing engine. The resulting image has effectively twice the number of samples, so 4x and 6x Anti-aliasing becomes 8x and 12x Super Anti-aliasing, respectively.

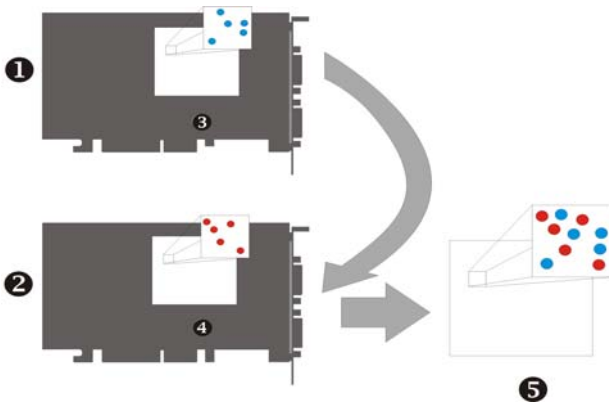

1	PCI Express® CrossFire™ Compatible Graphics Card
2	Radeon® X1650 PRO CrossFire™ Edition Graphics Card
3	Partial Frame Rendered on PCI Express® CrossFire™ Compatible Graphics Card
4	Partial Frame Rendered on PCI Express® CrossFire™ Edition Graphics Card
5	Final Rendered Frame on Display

Some types of textures, especially those with transparent portions, can exhibit aliasing that is not removed by MSAA techniques. Another form of anti-aliasing, known as Super-sample Anti-aliasing (SSAA), can be useful in these cases, because it affects every pixel in an image. Although it normally operates more slowly than MSAA, the power of multiple GPUs can make SSAA practical to use.

SSAA first renders a scene at a higher resolution than that which is output to the display, which is then downsampled to the display's resolution. This approach normally has two main disadvantages: it requires rendering many more pixels than normal, which can have a drastic impact on performance, and that it results in an ordered grid sample pattern, which does a poor job of anti-aliasing some types of jagged edges. CrossFire™'s Super Anti-aliasing overcomes both of these problems. It takes advantage of the second GPU to render the additional pixels required for each frame, so there is little or no performance impact. It can also make use of a more effective sample

pattern that does a better job of anti-aliasing near-horizontal and near-vertical edges, resulting in better overall image quality.

Two of the new Super Anti-aliasing modes use a combination of MSAA and SSAA to achieve the ultimate in image quality. They work by not only using different multi-sample locations on each GPU, but also by offsetting the pixel centers slightly. In effect, each GPU renders the image from a different viewpoint, about half a pixel width apart. The new 10x and 14x Super Anti-aliasing modes operate in this manner, combining 2x SSAA with 4x and 6x MSAA, respectively.

Both of these modes work together with SmoothVision™ HD Anisotropic Filtering (AF).

The new Super Anti-aliasing modes can be enabled by users through the ATI Catalyst™ Control Center interface.

Note: Enabling the Super Anti-aliasing modes (x8, x10, x12 x14), disables performance enhancing multi-GPU rendering to provide better image quality.

CHAPTER 8:

Reference

This chapter provides information on troubleshooting, where to get additional accessories, and how to register your product, plus warranty and compliance information.

Troubleshooting

The following troubleshooting tips may help if you experience problems. ATI's documentation contains helpful installation/configuration tips and other valuable feature information. Please contact your dealer for more advanced troubleshooting information.

General Troubleshooting	
Problem	Possible Solution
Computer Does Not Boot-Up Properly	<ul style="list-style-type: none">• Verify that the installation instructions were properly followed.• Check that the card is properly installed in your system and connected to your monitor.• If you have problems during start-up, restart your computer in Safe Mode. While starting Windows® XP, press and hold F8 until you see the Windows® Advanced Options Menu. Use the arrow keys to select Safe Mode, and press Enter.• Check the system configuration utility of your operating system for the interrupt assignments.• Contact ATI's Customer Care or your local technical support.

General Troubleshooting	
Problem	Possible Solution
No Display	<ul style="list-style-type: none"> Check that the card is seated properly in its expansion slot. Ensure that the monitor cable is securely fastened to the card. Make sure that the monitor and computer are plugged in and receiving power. If necessary, disable any built-in graphics capabilities on your mother board. For more information, consult your computer's manual or manufacturer. (Note: some manufacturers do not allow the built-in graphics to be disabled or to become the secondary display.) Make sure that you selected the appropriate monitor when you installed your enhanced driver.
Screen Defects Appear	<ul style="list-style-type: none"> Check if your monitor supports the resolution, horizontal (kHz) and vertical (Hz) refresh rates as required by the graphics card. Check your current resolution, refresh rate, and color depth settings in the Settings and Monitor tabs in your Display Properties dialog. <p>Warning! Ensure that both video card and monitor support resolution and refresh rates you select. Incompatible resolution/refresh rate selection may result in monitor damage. Refer to your monitor's documentation for recommended resolutions and refresh rates.</p>
Off-Center Screen Image, Odd Colors or No Picture	<ul style="list-style-type: none"> Try adjusting the brightness, sharpness, contrast, and color balance controls of your monitor. Try adjusting the centering and positioning controls of your monitor to position the picture on the screen Set the monitor's RGB inputs (and sync switches, if this option is available) to 75 Ohms, with the sync set to external. Digital Flat Panel (DFP) monitor users: refer to your monitor's documentation for the appropriate cable and connector to plug into the DVI-I connector on the graphics card.
Operating System Warns that Video Card Isn't Properly Configured	<ul style="list-style-type: none"> Check the driver installation and make sure that all software is correctly loaded corresponding to your operating system and applications. Re-install the ATI drivers for your Radeon® X1650 PRO card.

CrossFire™-Specific Troubleshooting

Problem	Possible Solution
CrossFire™ is Not Functioning	<p>In order for CrossFire™ to function the interconnect cable must be correctly connected to both the Master and Slave graphics cards.</p> <ol style="list-style-type: none"> 1. Connect the DMS-59™ connector of the interconnect cable to the DMS-59™ connection on the Master card. 2. Connect the DVI-I connector of the interconnect cable to the DVI-I connection on the Slave card. 3. Connect the remaining DVI-I connector of the interconnect cable to your monitor. <p>On graphics cards with two DVI-I connectors, only one DVI-I connector on the Slave card supports Transition Minimized Differential Signaling (TMDS) required by CrossFire™. If CrossFire™ does not appear in the Catalyst™ Control Center or is not available, try connecting to the second DVI-I connector on the Slave card.</p>
“Before CrossFire™ can be enabled, you need to close the 3D application or video playback that is currently running.”	<p>You will not be able to start CrossFire™ if a 3D application, game, or video playback, such as a DVD movie, is running.</p> <p>Close all open 3D applications, games, and movie player applications then enable CrossFire™.</p>
“The CrossFire™ Edition card must be installed on the 1st boot-up slot on your motherboard.”	<p>A message recommending the reversal of graphics card positions appears if the Master graphics card is not installed in the correct PCI Express® slot. Typically, the Master graphics card should be placed in Slot 0 (Slot zero).</p> <p>See your motherboard's manual to determine the correct CrossFire™ placement of Master and Slave graphics cards for your system.</p>
CrossFire™ Aspect in Catalyst™ Control Center is Not Displayed	<p>CrossFire™ aspect is only available for the Master graphics adapter. Make certain that the motherboard's system BIOS has Dual PCIe™ slots enabled. Also make certain that the master and slave graphics cards are in the correct PCIe™ slot. For more information see your motherboard's manual.</p>

CrossFire™ -Specific Troubleshooting

Problem	Possible Solution
<p>“CrossFire™ Is Currently Unavailable.”</p>	<p>This error is occurred because CrossFire™ did not correctly detect your graphics hardware or their is a problem with the software.</p> <ul style="list-style-type: none"> • Check the graphics card are installed correctly. • Check the interconnect cable is installed correctly. • Close all running 3D applications. • Re-install the Catalyst™ Control Center. <p>For information on installing the software see the Getting Started Guide that came with your graphics card.</p>
<p>“The hardware capabilities (such as memory size) of the CrossFire™ Edition and regular card are mismatched.”</p>	<p>Graphics card with different amounts of memory can by used with CrossFire™. However, restarting your computer is required prior to using your system in CrossFire™ mode. This will cause CrossFire™ to reduce the amount of memory being used on the larger card to match the memory size of the smaller card.</p> <p>Clicking OK to the memory mismatch error message will restart your computer.</p> <p>When disabling CrossFire™ you will be given the option to restart your computer to restore the original graphics memory size or continue with the reduced memory size.</p>
<p>Cannot Use ATI Overdrive</p>	<p>ATI Overdrive is not an available feature on CrossFire™ systems.</p>
<p>Screen Rotation Function Does Not Work or is Unavailable</p>	<p>Screen rotation is not an available feature on CrossFire™ systems.</p>
<p>Unable to get CrossFire™ to work on a Windows® XP Professional x64 Edition system.</p>	<p>Ensure that the proper drivers for both graphics cards has been properly installed.</p> <p>If both graphics cards have already inserted onto the motherboard, connect a display to the DVI connection of the CrossFire™ Master graphics card and then install the drivers for both graphics cards.</p>
<p>VIVO on Slave Card Does Not Work</p>	<p>If a VIVO (Video In, Video Out) connection is available on the Slave card, its functionality is not supported in this configuration. If the graphics card is moved into the primary PCI Express® slot, VIVO functionality will return.</p>

- ATI Customer Care is unable to assist with refunds, returns, or exchange specific inquiries. If resolving the problem being experienced is critical to your decision to keep the product, it is your responsibility to ensure that you know and are within the period of time your reseller will allow for refunds, returns or exchange.
- ATI is not responsible for any expense incurred accessing Customer Care. It is expected that customers will review the expense associated with the available support options and will choose the method that best meets their needs and budget.
- ATI Customer Care reserves the right to limit support options for products that are not registered or are at End of Life.

Additional Accessories

Additional and replacement cables, installation CD-ROMs, manuals, and other accessories for ATI products can be purchased from the online ATI store at:

ati.com/online/accessories

Compliance Information

This section details the compliance information for this product.

FCC Compliance Information

This Radeon X1650 product complies with FCC Rules part 15. Operation is subject to the following two conditions

- This device may not cause harmful interference.
- This device must accept any interference received, including interference that may cause undesired operation.

This equipment has been tested and found to comply with the limits for a Class B digital device, pursuant to Part 15 of the FCC Rules. These limits are designed to provide reasonable protection against harmful interference in a residential installation. This equipment generates, uses and can radiate radio frequency energy and, if not installed and used in accordance with manufacturer's instructions, may cause harmful interference to radio communications. However, there is no guarantee that interference will not occur in a particular installation. If this equipment does cause harmful interference to radio or television reception, which can be determined by turning the equipment off and on, the user is encouraged to try to correct the interference by one or more of the following measures:

- Re-orient or relocate the receiving antenna.
- Increase the separation between the equipment and receiver.

- Connect the equipment to an outlet on a circuit different from that to which the receiver is connected.
- Consult the dealer or an experienced radio/TV technician for help.

The use of shielded cables for connection of the monitor to the graphics card is required to ensure compliance with FCC regulations. Changes or modifications to this unit not expressly approved by the party responsible for compliance could void the user's authority to operate this equipment.

Industry Canada Compliance Statement

ICES-003 This Class B digital apparatus complies with Canadian ICES-003.

Cet appareil numérique de la Classe B est conforme à la norme NMB-003 du Canada.

For further compliance information:

ATI Research Inc.
62 Forest Street.
Marlborough, MA
01752
USA
508-303-3900

CE Compliance Information

EMC Directive 89/336/EEC and amendments 91/263/EEC, 92/31/EEC and 93/68/EEC, Class B Digital Device EN 55022:2003/CISPR 22 Class B, Limits and Methods of Measurement of Radio Interference Characteristics Information Technology Equipment.

EN 55024:1998/CISPR 24:1997 +A1:2001 +A2:2003, Immunity of Information Technology Equipment (ITE), including EN 61000-4-2, EN 61000-4-3, EN 61000-4-4, EN 61000-4-5, EN 61000-4-6

Informations de conformité de la CE

Directive EMC 89/336/CEE et amendements 92/31/CEE et 93/68/CEE, pour dispositif numérique de Classe B.

EN 55022:2003/CISPR 22:1997, - Classe B - Limites et méthodes de mesure des caractéristiques d'interférences radiophoniques, Matériel des technologies de l'information.

EN 55024:1998/CISPR 24:1997 +A1:2001 +A2:2003, Norme sur l'immunité de matériel des technologies de l'information, et comprenant EN 61000-4-2, EN 61000-4-3, EN 61000-4-4, EN 61000-4-5, EN 61000-4-6

Electrical Safety

73/23/EEC - The Low Voltage Directive

IEC 60950-1:2001, IEC 60950:1999, 3rd Edition - Safety of Information Technology Equipment

BS EN60950-1:2002, BS EN60950:2000, 3rd Edition UL 60950-1:2003, UL 60950:2000, 3rd Edition CAN/CSA C22.2 No. 60950-1:2002, CAN/CSA C22.2 No. 60950-00, 3rd Edition (2000)

To meet UL safety requirements, the computer's maximum room temperature should not exceed 40° C.



Waste Electrical and Electronic Equipment (WEEE) Directive Compliance

This product was manufactured by ATI Technologies Inc.



CHAPTER 9:

Glossary

2D

Acronym for “two dimensional,” a term applied to computer graphics that are “flat.” Typical desktop applications such as word processors, spreadsheet programs, or other programs that manipulate print or simple graphics (such as pictures or line art) are generally considered to be operating within a 2D environment, even when they include simple three dimensional elements, such as buttons.

3D

Acronym for “three dimensional,” referring to computer graphics that appear to have volume and depth. Various modeling processes take the representation of a three dimensional object provided by the computer program and render it by using various lighting components, applying textures, and setting layers of transparency or opacity as required in order to produce a realistic representation of a three-dimensional object on a two-dimensional display.

3Dc™

An ATI hardware-based compression technology that reduces the size of 3D texture data, rendering more finely-grained texture surfaces with greater efficiency. It significantly minimizes the memory footprint of normal maps containing information on how light reflects off textured surfaces, allowing game programmers to include more texture and lighting details without affecting performance.

Adaptive Anti-aliasing

Adaptive anti-aliasing is a technique that applies a combination of multi-sampling (MSAA) and super-sampling (SSAA) on 3D objects to improve edge smoothness and fine detail. Multi-sampling works best on smoothing the edges of solid polygons, but cannot effectively smooth edges within polygons which are partially transparent. Super-sampling is able to more accurately calculate color values adjacent to transparent pixel shader values within polygons with partially transparent textures, but is not applied universally since it is more processor-intensive. Adaptive anti-aliasing works by using super-sampled anti-aliasing on transparent textures, and multi-sampled anti-aliasing on all other textures. This delivers exceptional levels of image quality, while maintaining performance.

AGP

The Accelerated Graphics Port (AGP) is a slot on the computer motherboard designed specifically for 3D graphics cards. AGP runs 3D images much more smoothly and quickly than was previously possible with PCI video cards; AGP runs at several times the bus speed of PCI and employs sideband addressing, so multiple data transfers between the graphics processor and the computer can take place concurrently. AGP is currently being phased out in favor of PCI Express[®] (PCIe[™]).

Alpha Blending

Alpha blending is used in 3D graphics to create transparent or opaque effects for surfaces such as glass and water. Alpha is a transparency value, so the lower the value, the more transparent the image looks. It is also used in animations to produce such things as fading effects, where one image gradually fades into another.

Alternate Frame Rendering

A graphical load-balancing scheme where two graphics cards are used to render alternate frames of the display. This configuration increases the detail of the 3D objects each card can render, as each card handles half of the total number of frames. Essentially, each card has more time to render a scene, delivering a noticeable increase in 3D detail. This type of graphical operation is only available in Radeon[®] CrossFire[™] graphics cards running Microsoft[®] Direct 3D[®] and OpenGL[®] games or applications.

Anisotropic Filtering

A technique that preserves the surface details of an object as it recedes into the distance by utilizing and blending together the object's texture maps. This makes 3D objects appear more realistic as the detail of their surface texture is retained in a smooth, seamless fashion on the sections that move or fade away into the background.

Anti-aliasing

A method that smoothes out the jagged edges of a curved object. A black curved line on a white background displayed on a computer screen will have some jaggedness along its edges due to the inherent limitations of using discrete pixels to display the image. Anti-aliasing smoothes out this jaggedness by filling in the white spaces between the jagged edges with varying shades of grey.

Aspect

A group of related features in ATI's Catalyst™ Control Center software. For example, the Color aspect clusters together controls that handles gamma, brightness, contrast, and other features relating directly to the display of color. Similarly, the 3D aspect provides a set of related controls dealing with such features as anti-aliasing, anisotropic filtering, mipmap details levels, and more.

Aspect Ratio

The proportions of a display are expressed as a ratio of its width and height. Common ratios include 4:3 for TVs and CRTs, 5:4 for LCDs, and 16:9 for widescreen displays.

Avivo™ Color

Avivo™ Color is an advanced feature within Catalyst™ Control Center, providing the user with precise control over how color is displayed on a monitor. Avivo™ Color provides tools to adjust the Hue and Saturation values on a per-monitor basis, making it possible to optimize the use of a single display within its existing ambient lighting environment, or to better color match two or more adjacent monitors.

Back Buffer

A type of offscreen memory used to provide smooth video and 2D graphics acceleration. This technique uses two frame buffers, so the process is often referred to as “double-buffering.” While the contents of one buffer are displayed, a second buffer, called the “back” buffer, holds the frame being worked on. In this way, users will only see complete, smooth frames displayed onscreen.

Bilinear Filtering

This filtering method reduces the blockiness caused when zooming into a 3D surface that is at a right angle to the viewer. A newspaper photo examined closely enough will show that the picture is made up of tiny dots. If the photo was enlarged it would start to look “blocky” and less distinct. This is also a problem for computer-generated images, especially for surface details.

Bit Depth

Refers to the number of data bits required to store color information about a pixel. Larger bit depth means a greater range of color information is capable of being encoded into each pixel. For example, 1 binary bit of memory can only encode to either “0” or “1.” So a graphical bit depth of 1 means that the display can only show two colors, the black and white of a monochrome display. Four-bit color depth is capable of displaying 16 colors because there are only 16 different combinations of 4 bits (“0000”, “0001”, “0010”... to “1111”). Sixteen-bit color is capable of reproducing 65,536 colors, 24-bit color can display up to 16,777,216 individual colors, and 30-bit color can display up to one billion individual colors.

Bitmap

A bitmap is a graphic or character representation composed of individual pixels, arranged horizontally in rows. A monochrome bitmap uses one bit per pixel (bpp). Color bitmaps may use up to 32bpp, depending on the color depth selected.

Brightness

The amount of white or black that is applied to all colors onscreen. By making the screen “brighter” you are adding more white to it. This should

not be confused with luminosity, which measures the actual light level emitted from the computer display.

Buffer

A name referring to portions of on-board video memory. One large buffer is always used to display images to the screen; this is the “display buffer.” The rest of offscreen memory is typically used by applications as back buffers, z-buffers, and texture buffers.

Catalyst™ Control Center

Catalyst™ Control Center is the successor technology to the Catalyst™ software formerly available only through the Windows® Control Panel. It has a new user interface, providing a more interactive means of controlling such things as 2D and 3D performance while providing immediate feedback using a more intuitive graphical user interface.

Color Component

Three color components—Red, Green, and Blue—combine in various intensities to determine the color of each pixel on the screen. The values of each color component are graphically represented by a corresponding color curve.

Color Correction

Correct discrepancies between the real color value and the way a screen displays it. Color discrepancies can be caused by a variety of sources, including the lighting conditions in the work area and gradual shifts in color over time on monitors or flat panel displays.

Color Depth

Color depth refers to the number of color shades available on your display and is measured in bits per pixel (bpp). Typical ranges are: 256 colors (8bpp), thousands of colors (16bpp), and millions of colors (32bpp).

Component Video

Typically used on DVD players and HDTV systems, component video is a standard Red/Green/Blue (RGB) color signal for televisions. The signal is split and compressed into separate luminance and color values—luminance (“Y”), red minus luminance (R-Y), and blue minus luminance (B-Y). The value for green is not transmitted. The display device automatically “fills in” the color values that are not red or blue. DVDs are encoded using component video, so display devices will provide enhanced playback when this type of connection is used. A common variant of this format used in North America is YPbPr.

Composite Video

Composite video is a type of analog video signal that combines both brightness and color information into a single signal. It typically uses a single RCA connection for the video channel, and separate RCA connections for the left and right audio channels. The quality of the video signal is reduced by the process of mixing the brightness and multiple color channels together into a single channel. For this reason it is inferior in signal quality than either S-Video or component video. Composite video is the broadcast format for analog television signals worldwide, and connections are typically available on VCRs, DVD players and video games.

Compositing Engine

A chip that is available only on CrossFire™ Edition graphics cards. This chip takes the signals from the GPUs on both the Master graphics card and the Slave graphics card and combines the results according to the selected operating mode. It then sends the final frames out to the display device. It is capable of advanced blending operations without burdening either of the GPUs.

Control Point

A control point is a user-created point on the color curve. Users can change the color of the screen by moving the control points with a mouse.

CRT

Acronym for “cathode ray tube”, which is the main component of computer monitors and TVs. Color CRTs use three separate electron beams fired through a shadow mask and onto the back of the glass screen. The electron beams activate separate red, green, and blue values in various strengths in order to produce a colored image.

Dashboard

The dashboard is the part of the Catalyst™ Control Center used to display a graphical representation of the features available in installed ATI hardware and software. The dashboard can be used to access all of the aspects (sets of related graphical features) available on a graphics card. The dashboard is only available in Advanced view and Custom view which is aimed at more experienced users.

Direct 3D®

Part of Microsoft®’s DirectX API designed for rendering 3D graphics on Windows® systems. It provides software developers with low-level access to functions on graphics cards, providing the type of performance necessary for intensive 3D applications such as games.

DirectX

A Microsoft® technology, DirectX is an API that provides programmers with direct access to low-level hardware functions for games and other high-performance 3D applications.

Dithering

A computer graphics technique that takes advantage of the human eye’s tendency to mix two colors that are adjacent to each other to produce smooth boundary transitions. Dithering adds intermediate color values between two or more boundaries, producing smoother, more natural look to 2D images or 3D objects.

Dot pitch

Dot pitch specifies the sharpness of a monitor’s display. It is measured in millimeters (mm) and is the distance between the individual phosphor sub-pixels in a CRT display or cells of the same color within an LCD display;

the smaller the number, the sharper the image. The most common dot pitches for monitors range from .24 mm to .31 mm. Also, if a monitor with a .24 mm dot pitch is set to its highest possible resolution, the pixel size will equal the dot pitch. If the monitor is set to lower resolutions, the pixels will be comprised of multiple dots.

DVI

Acronym for “Digital Video Interface,” a standard video connection used on many current computer displays. There are three types of DVI connections: DVI-A (analog), DVI-D (digital), and DVI-I (integrated, capable of either analog or digital). It supports high-bandwidth video signals over 160 Hz, so it is most often used for high-resolution displays.

EDTV

Acronym for “Enhanced Definition Television”, a format that produces better television image quality than Standard Definition Television (SDTV). Applicable to the NTSC broadcast format, EDTV displays are capable of depicting the standard 480 horizontal scan lines in a non-interlaced format. Instead it paints all of the scan lines in one pass, which is called progressive scanning, a process which also removes the “jaggies” inherent in the interlaced television signals.

Flat Shading

A lighting technique that shades each polygon of a 3D object based on where the source of the light is and the angle of the polygon in relation to it. It enables relatively fast rendering of 3D objects, although it can make those objects appear “faceted” as each visible polygon is set to a particular color value, and consequently does not produce as realistic an effect as obtained when using Gouraud shading.

Fog

Term used to describe the blending of an object using a fixed color as objects are made to appear more distant from the viewer.

Frame Buffer

The portion of the memory buffer on the graphics card used to store the image being displayed. All rendering processes have been accomplished by

this stage and this buffer contains only a one-to-one relationship of the data to be relayed to the display.

Frames Per Second

In terms of 3D graphics, refers to the rate at which the graphic processor can render new screens per second. Higher rates equals better, more naturalistic performance for such things as games set in a 3D environment. Sometimes abbreviated to “fps.”

Gamma

Sometimes confused with brightness, gamma actually refers to the correction that is applied to any display device in order to produce more gradual increases or decreases in the perceived brightness for that device. A change in gamma produces a non-linear change in the color curve, ensuring that perceived changes in color and intensity are consistently applied.

Gouraud Shading

A shading method used to produce a smooth lighting effect across a 3D object. A specific color is used at each vertex of a triangle or polygon and interpolated across the entire face.

HDCP

HDCP is an acronym for “High-Bandwidth Digital Copy Protection.” It is a form of digital rights management designed to protect copyright of signals being transported across DVI or HDMI™ connections. Several international regulatory bodies have recommended its incorporation into high-definition display and playback devices.

HDMI™

HDMI™ is an acronym for “High Definition Multimedia Interface.” It is a 19-pin connector used for transferring combined digital audio and video. HDMI™ supports standard, enhanced, and high-definition digital video signals, and is designed for use with VCRs, DVD players, personal

computers, and set-top boxes. A DVI adapter can be used to transfer the video signal to an HDMI™-capable display, although audio must be transferred from a different route, as DVI output does not support audio.

HDTV

Acronym for “High Definition Television,” a format that produces much greater picture quality than a standard television, and in a wide-screen format that matches that of a movie theater screen. The two most popular formats are 1080i and 720p, where the number represents how many horizontal scan lines they have, and the following letter represents whether the picture is interlaced, or the product of progressive scanning technology. Interlaced displays paint the odd-numbered scan lines and then the even-numbered lines to produce a picture, whereas progressive scan paints all of the scan lines at once. Both formats use an aspect ratio of 16:9. In contrast, standard North American television signals are displayed using 480 interlaced (480i) scan lines with a more square aspect ratio of 4:3.

Hue

Refers to a specific color within the visible spectrum of light, defined by its dominant wavelength. A light wave with a central tendency within the range of 565-590 nm is visible as yellow. In the standard RGB color space used by most computer displays, hue refers to a coordinate of the color as described by its red, green, and blue values, minus any additional brightness or saturation values for that color.

HydraVision™

HydraVision™ is ATI’s multi-monitor management software, enabling users to manage the display of multiple windows and applications across two or more adjacent monitors. It also includes a range of productivity features designed to effectively manage applications in this environment.

HyperZ™ HD

HyperZ™ HD includes a number of different technologies aimed at optimizing memory-bandwidth efficiency, particularly with respect to Z-buffer operations. The Z-Buffer, sometimes also called the Depth Buffer, stores information used to determine the placement of objects in a 3D environment with respect to the viewpoint of the observer. Reading and updating this buffer typically consumes more memory than any other part

of the 3D rendering process, making it a major performance bottleneck. HyperZ™ HD technology reduces the memory bandwidth consumed by the Z-Buffer, thereby increasing performance while also making the 3D environment more realistic.

Keyframe Interpolation

This feature is also known as “morphing.” In an animation, a start and end point are picked as the key frames. In a 3D rendering, the start point could have a character with a neutral expression, and the end point could have that same character smiling. Additional frames are interpolated (inserted) between the two keyframes in order that “morphs” (transforms) the image so that there is a smooth transition between the key frames.

KTX Buffer Region Extension

This OpenGL® programming term refers to a feature that rapidly updates portions of the display of 3D modeling applications that change very quickly, or have been moved or occluded. It does this by optimizing the storage of buffer regions in the graphics card’s memory buffer. Other applications are typically not adversely affected when this is enabled.

Lighting

In 3D computer graphics, refers to aspects and quality of the virtual light source being used to make an object visible. Lighting can strongly affect the “mood” of a scene. For example, a “harsh” light could be a bare lightbulb that is glaringly bright on the objects closest to it while casting strong shadows in the background. A “softer” light would be more diffuse and not cast shadows, such as you would get outdoors on a typical overcast day.

Mipmapping

The most memory-intensive aspect of 3D graphics are the textures that give an object its realism (like wood, marble, leather, and cloth). Because objects in real life become less detailed as they move farther away from the viewer, 3D programmers simulate this by using less detailed, lower resolution texture maps on distant objects. These texture maps are merely scaled down versions of the main texture map used when the object is up close, and they use less memory.

NTSC

The name for the type of analog television signal used throughout the Americas (except Brazil) and in Japan. It draws a total of 525 vertical interlaced frames of video at a refresh rate of 60 Hz, making it relatively flicker-free. The acronym refers to the National Television Systems Committee, which devised this color video standard in 1953.

Offscreen Memory

An area of memory used to preload images so that they can be quickly drawn to the screen. Offscreen memory refers to all of the remaining video memory not taken up by the front buffer, which holds the contents of the display screen currently visible.

OpenGL®

Short for “Open Graphics Library,” this is an industry standard for cross-platform 3D graphics development. It consists of a large number of functions that can be called upon in various programs, such as games, CAD, and virtual-reality systems, to produce complex 3D objects from simpler, more “primitive” building blocks. Implementations currently exist under Windows®, Mac OS® X, and various forms of Unix, including Linux®.

ATI Overdrive

ATI Overdrive maximizes the performance of the GPU by dynamically altering its speed to an optimal level depending on usage. An on-chip thermal sensor constantly monitors the temperature of the GPU, allowing for maximum clock speed to be maintained while avoiding overheating.

PAL

An acronym for “Phase Alternating Line”, the name for a video broadcast standard used in much of Europe (except France), most of Asia, the Middle-East, Africa and Australia. It draws a total of 625 vertical interlaced frames of video at a refresh rate of 25 Hz.

PCI

Acronym for “Peripheral Component Interconnect”, which is the specification for a type of computer bus used for attaching computer

peripherals to a computer's motherboard. PCI encompasses both integrated motherboard components (such as built-in graphical processors) and peripherals that fit into an expansion card slot, such as a separate graphics card. PCI replaced the older ISA and VESA bus standards, and was itself superseded by the AGP standard for the main graphics card bus.

PCI Express® (PCIe™)

The successor standard to the PCI and AGP bus standards, with a significantly faster serial communications system, further opening up bandwidth for more communications between such peripherals as graphics cards and the computer's CPU. PCIe cards can come in several physical configurations, the fastest currently being X16, which is typically used for graphic cards, and X1, typically used for other peripherals, such as separate multimedia cards.

Pipeline

In relation to computer graphic processors, refers to the number of separate arithmetic units available for rendering the output on a display. In general, more pipelines available on a graphical processor means there are more 3D rendering capabilities available, increasing overall 3D performance.

Pixel

All computer images are made up of tiny dots. Each individual dot is called a pixel, a word created from the term "picture element." A pixel is the smallest indivisible unit of a digital image and can be only a single color. The size of the pixel depends on how the display resolution has been set. The smallest size a pixel can be is determined by the display's dot pitch, which is measured in millimeters (mm).

Pulldown

Pulldown is a telecine technique used to transfer motion picture film shot at one frame rate to a video format at a different frame rate. Typical NTSC video contains more frames per second than motion picture film for even division between frames, so that every 4 frames of film can be reproduced as 5 separate NTSC frames, the "extra frame" created by interlacing interpolated frames. This feature produces a smoother NTSC video image from a motion picture film source, and can be used for better edge image

processing in the Vector Adaptive Deinterlacing feature within Catalyst™ Control Center.

Refresh Rate

Also referred to as “vertical refresh rate.” This is the rate at which a monitor or television can redraw the screen from top to bottom. NTSC television systems have a refresh rate of approximately 60 Hz whereas computer displays typically have refresh rates of 75 Hz or more. At refresh rates of 70 Hz and lower, screen flicker is often noticeable.

Rendering

Rendering refers to the final drawing stages where the 2D image that appears on a display is derived from its 3D descriptions. What appears on the display may look three dimensional, but it is really just a 2D grid of pixels designed to appear that way.

Resolution

The resolution of any display is the number of pixels that can be depicted on screen as specified by the number of horizontal rows against the number of vertical columns. The default VGA resolution of many video cards is capable of displaying 640 rows of pixels by 480 columns. The typical resolution of current displays is set to higher values, such as 1024x768 (XGA), 1280x1024 (SXGA), or 1600x1200 (UXGA).

Saturation

Refers to the intensity of a specific hue (color). A highly saturated hue is vivid and intense, whereas a less saturated hue appears more grey. A completely unsaturated color is grey. In terms of the RGB color model, a fully saturated color exists when you have 100% brightness in one of the three channels (say, red) and 0% in the two others (green and blue). Conversely, a fully desaturated color is one where all of the color values are the same. Saturation can therefore be thought of as the relative difference between the values of the channels.

SCART

SCART is an acronym for “Syndicat des Constructeurs d'Appareils Radiorécepteurs et Téléviseurs”. SCART is a 21-pin connector used

mainly in Europe for transferring analog audio and video signals between VCRs, DVD players, personal computers, and set-top boxes. It is sometimes referred to as Péritel or the Euroconnector.

Scissor Mode

A graphical load-balancing scheme where two graphics cards are used to render two halves of an image display. One graphics card renders the top half of the screen while the second graphics card renders the bottom half. This configuration offers a form of dynamic load balancing between the two cards as each only needs to render 3D object details on only half of the screen instead of the full screen at any one time. This type of graphical operation is only available in Radeon® CrossFire™ graphics cards running Microsoft® Direct 3D® and OpenGL® games or applications.

SDTV

SDTV is an acronym for “Standard Definition Television” that identifies lower resolution systems when compared to High Definition Television (HDTV) systems. SDTV systems use the same 4:3 aspect ratio and 480 scan lines to produce a picture as regular analog television sets, but digital decoding enhanced of the signal, displaying a sharper and crisper picture. SDTV broadcasts are either interlaced (480i) or use progressive scan (480p), the latter method providing the best overall image quality.

SECAM

An analog color video signal that originated in France, and is used in many other countries, including (but not limited to) much of Eastern Europe, parts of the Middle East and Asia. Like the PAL video standard, SECAM also draws a total of 625 vertical interlaced frames of video at a refresh rate of 25Hz, but uses a fundamentally different way of encoding its colors. The name is an acronym for “Séquential Couleur avec Mémoire,” which is French for “sequential color with memory.”

Shadow Mask

In CRT monitors, the shadow mask is a metal plate full of tiny holes that is attached to the inside of the glass screen. It focuses the beams from the electron guns at the back of the CRT. The distance between these holes is called the dot pitch.

SmartShader™ HD

SmartShader™ HD contains advanced vertex and pixel-shading capabilities. A shader is a small program that runs on the GPU and describes how an image should be rendered. Vertex shaders manipulate the individual polygons that make up 3D objects, and pixel shaders operate on the individual pixels that fill in these polygons to create a visible image.

SmartShader™ HD is designed to alleviate the resource constraints of earlier shader hardware, paving the way for more complex, detailed, and realistic shader effects in applications requiring high-performance 3D rendering.

SmoothVision™ HD

SmoothVision™ HD incorporates improved anti-aliasing, anisotropic filtering and 3Dc™ compression features designed to further enhance image quality. Anti-aliasing performance is improved, providing better overall detail and image quality. The enhanced anisotropic filtering ensures sharper and clearer pictures at higher frame rates, and the new 3Dc™ compression technology makes it possible to display higher polygon counts for 3D rendered objects.

Specular Highlight

The bright, usually small, intense light reflected from a 3D surface with a high refraction value. From the intensity and spread of this highlight users can differentiate between a “hard,” smooth surface, such as metal or porcelain, or a “soft,” textured surface, such as fabric or skin.

Super Anti-aliasing

A feature that improves image quality by combining the results of full-screen anti-aliasing across two graphics cards in a CrossFire™ configuration. The two graphics cards work on different anti-aliasing patterns within each frame. The results of which are combined by the compositing engine on the CrossFire™ Master graphics card to produce 3D images featuring smoother contours, lines, and shading effects.

SuperTiling

A graphical load-balancing scheme where two graphics cards are used to render alternate small 32x32 pixel squares in a fine-grained checkerboard pattern. This configuration increases image rendering quality, as each card processes half of the complex 3D objects in the pixel squares. SuperTiling is better optimized for most applications than Scissor Mode (where two graphics cards are used to render the top and bottom halves of the screen), since the checkerboard pattern better ensures a more even distribution of what needs to be rendered. This type of graphical operation is only available in Radeon® CrossFire™ graphics cards running Microsoft® Direct 3D® games or applications.

S-Video

Short for “Separate Video,” S-Video is a type of analog video interface that produces a higher-quality signal compared to composite video. The signal is split into two separate channels— luminance (Y) and chrominance (C). Sometimes referred to as “Y/C video” or “Y/C”, the connectors typically contain 4-pins within a single connection housing and are commonly found on consumer DVD players, VCRs, game consoles, and related devices.

Texel

Short for “texture element,” the 3D equivalent of a pixel, describing the base unit of the surface of a 3D object, such as a sphere; for a 2D object, such as a circle, the base unit is a pixel.

Texture Mapping

In computer graphics, two-dimensional textured surfaces are referred to as texture maps. Texture mapping is the process by which a two-dimensional surface gets wrapped around a three-dimensional object so that the 3D object takes on the same texture qualities. For example, if you take a 2D textured surface that looks like cloth and wrap it around a 3D sphere, the sphere will now appear to have a cloth-like surface.

Texture Preference

Texture Preference is a feature enabling the user to select the texture quality level for the surface of a 3D object. Selecting the highest quality possible will provide the most realism, although it may also have some impact on the performance of any 3D intensive application.

Transition Minimized Differential Signaling (TMDS)

A technology designed to reduce electromagnetic interference (EMI) and improve the digital signal delivered to flat panel displays. Its encoding algorithm converts the original 8-bit graphic data into a more fault-tolerant 10-bit signal, which is then converted back to its original 8-bit form at the display device. The signal is also DC-balanced, allowing for the option of transmitting the signal over fiber-optic cable. DVI connectors can incorporate up to two TMDS links, with each “link” comprised of the number of signals required for standard RGB output. Higher resolutions and refresh rates than standard are possible if multiple TMDS links are available by using multiple DVI connectors.

Trilinear Filtering

A sampling method used to produce realistic-looking 3D objects. Trilinear filtering averages one of the bilinear filter mipmap levels along with the standard mipmap samples.

Vector Adaptive Deinterlacing

A technique that provides smoother, less jagged edges for interlaced video playback. Interlaced video consists of alternating odd and even numbered scan lines, which are then mapped to an equivalent pixel-by-pixel display on a CRT or Flat Panel Display. Without correction, jagged lines appear in a video image either as doubled scan lines or lines that are improperly interpolated. With vector adaptive deinterlacing, the difference in pixel values is considered across multiple lines and alternating frames (using Pulldown detection on the interlaced video source), and then intelligently re-interpreted to produce smoother edges in interlaced video images.

VersaVision™

An ATI technology enabling accelerated display rotation and scaling. Any desktop can now be rotated 90 degrees left or right, or even 180 degrees, while maintaining the full feature set of other ATI 2D and 3D technologies, such as SmoothVision™. VersaVision™ works with single or multiple displays.

Vertex Shader

Three-dimensional objects displayed on a screen are rendered using polygons, each of which is made up of intersecting triangles. A vertex is a corner of a triangle where it connects to another triangle, and each vertex

carries a considerable amount of information describing its coordinates in 3D space, as well as its weight, color, texture coordinates, fog, and point size data. A vertex shader is a graphics processing function that manipulates these values, producing such things as more realistic lighting effects, improved complex textures such as hair and fur, and more accurate surface deformations such as waves rippling in a pool or the stretching and wrinkling of a character's clothes as he or she moves.

Vertex shader units

A feature built into the graphical processor which renders the texture, magnitude and direction of the individual triangles that comprise each polygon of a given 3D object. The more vertex shader units available within the graphical processor, the more complex polygons that can be generated per clock cycle, and hence finer, more naturalistic detail and movement is possible.

VGA Connector

A type of graphics connector, sometimes also called an analog connector. It is the most common type of video connector available, consisting of 15-pins set in three rows. The "VGA" is an acronym for "Video Graphics Array," which is also the name for the video resolution mode of 640x480 pixels, the lowest standard resolution supported by virtually all video cards.

Video Immersion™ II

A technology that integrates digital video features such as advanced adaptive de-interlacing, temporal filtering, and video gamma enhancement to produce high-quality video along with an integrated digital TV decode capability. It also supports component output support for EDTV displays at 480i (interlaced scanning), 480p (progressive scanning), and for HDTV displays at 720p, and 1080i.

VideoShader™ HD

A feature that integrates pixel-shading technology with video filtering and processing functions. It accelerates noise removal, de-blocking, adaptive

de-interlacing, frame-rate conversion, color-space conversion, and more. It also enables better MPEG-2 decoding with motion compensation.

VPU Recover

A feature designed to significantly reduce the number of system crashes caused by problems occurring with the graphics hardware. If the display driver detects that the graphics processor has hung, VPU Recover will attempt to reset the graphics processor, eliminating the need for a system reboot and allowing users to continue using the computer without interrupting or losing their work.

YPbPr

A type of analog composite video signal that splits and compresses the standard Red/Green/Blue (RGB) colors of a television signal into separate luminance and color values. The “Y” stands for the luminance channel, while “Pb” and “Pr” represent the blue and red channels respectively, both of which have the luminance value subtracted from them. It is an equivalent color space to the chrominance-based YCbCr, which is used for digital video.

Z-buffer

The portion of video memory that keeps track of which onscreen elements can be viewed and which are hidden behind other objects. In the case of a 3D image, it keeps track of which elements are occluded by the foreground in relation to the user’s perspective, or by another 3D object.