



P4S800-MX SE

User Guide

Motherboard

E1918

**First Edition
January 2005**

Copyright © 2005 ASUSTeK COMPUTER INC. All Rights Reserved.

No part of this manual, including the products and software described in it, may be reproduced, transmitted, transcribed, stored in a retrieval system, or translated into any language in any form or by any means, except documentation kept by the purchaser for backup purposes, without the express written permission of ASUSTeK COMPUTER INC. ("ASUS").

Product warranty or service will not be extended if: (1) the product is repaired, modified or altered, unless such repair, modification or alteration is authorized in writing by ASUS; or (2) the serial number of the product is defaced or missing.

ASUS PROVIDES THIS MANUAL "AS IS" WITHOUT WARRANTY OF ANY KIND, EITHER EXPRESS OR IMPLIED, INCLUDING BUT NOT LIMITED TO THE IMPLIED WARRANTIES OR CONDITIONS OF MERCHANTABILITY OR FITNESS FOR A PARTICULAR PURPOSE. IN NO EVENT SHALL ASUS, ITS DIRECTORS, OFFICERS, EMPLOYEES OR AGENTS BE LIABLE FOR ANY INDIRECT, SPECIAL, INCIDENTAL, OR CONSEQUENTIAL DAMAGES (INCLUDING DAMAGES FOR LOSS OF PROFITS, LOSS OF BUSINESS, LOSS OF USE OR DATA, INTERRUPTION OF BUSINESS AND THE LIKE), EVEN IF ASUS HAS BEEN ADVISED OF THE POSSIBILITY OF SUCH DAMAGES ARISING FROM ANY DEFECT OR ERROR IN THIS MANUAL OR PRODUCT.

SPECIFICATIONS AND INFORMATION CONTAINED IN THIS MANUAL ARE FURNISHED FOR INFORMATIONAL USE ONLY, AND ARE SUBJECT TO CHANGE AT ANY TIME WITHOUT NOTICE, AND SHOULD NOT BE CONSTRUED AS A COMMITMENT BY ASUS. ASUS ASSUMES NO RESPONSIBILITY OR LIABILITY FOR ANY ERRORS OR INACCURACIES THAT MAY APPEAR IN THIS MANUAL, INCLUDING THE PRODUCTS AND SOFTWARE DESCRIBED IN IT.

Products and corporate names appearing in this manual may or may not be registered trademarks or copyrights of their respective companies, and are used only for identification or explanation and to the owners' benefit, without intent to infringe.

Contents

Notices	v
Safety information	vi
P4S800-MX SE specification summary	viii
About this guide	ix

Chapter 1: Product introduction

1.1 Welcome!	1-2
1.2 Package contents	1-2
1.3 Special features	1-2
1.4 Before you proceed	1-5
1.5 Motherboard overview	1-6
1.5.1 Motherboard layout	1-6
1.5.2 Placement direction	1-7
1.5.3 Screw holes	1-7
1.6 Central Processing Unit (CPU)	1-8
1.6.1 Overview	1-8
1.6.2 Installing the CPU	1-9
1.7 System memory	1-10
1.7.1 DIMM sockets location	1-10
1.7.2 Memory configurations	1-10
1.7.3 Installing a DIMM	1-11
1.8 Expansion slots	1-12
1.8.1 Installing an expansion card	1-12
1.8.2 Configuring an expansion card	1-12
1.8.3 PCI slots	1-14
1.8.4 AGP slot	1-14
1.9 Jumpers	1-15
1.10 Connectors	1-17
1.10.1 Rear panel connectors	1-17
1.10.2 Internal connectors	1-18

Contents

Chapter 2: BIOS Information

2.1	Managing and updating your BIOS	2-2
2.1.1	Creating a bootable floppy disk	2-2
2.1.2	Using AFUDOS to copy the current BIOS	2-3
2.1.3	Using AFUDOS to update the BIOS	2-4
2.1.4	Using ASUS EZ Flash to update the BIOS	2-5
2.1.5	ASUS CrashFree BIOS 2 utility	2-6
2.1.6	ASUS Update utility	2-8
2.2	BIOS Setup program	2-11
2.2.1	BIOS menu screen	2-12
2.2.2	Menu bar	2-12
2.2.3	Navigation keys	2-12
2.2.4	Menu items	2-13
2.2.5	Sub-menu items	2-13
2.2.6	Configuration fields	2-13
2.2.7	Pop-up window	2-13
2.2.8	Scroll bar	2-13
2.2.9	General help	2-13
2.3	Main menu	2-14
2.3.1	System Time	2-14
2.3.2	System Date	2-14
2.3.3	Legacy Diskette A	2-14
2.3.4	Primary and Secondary IDE Master/Slave	2-15
2.3.5	OnChip SATA Controller	2-16
2.3.6	System Information	2-16
2.4	Advanced menu	2-17
2.4.1	JumperFree Configuration	2-17
2.4.2	CPU Configuration	2-18
2.4.3	Chipset	2-19
2.4.4	Onboard Devices Configuration	2-21
2.4.5	PCI PnP	2-22
2.4.6	USB Configuration	2-23
2.5	Power menu	2-24
2.5.1	Suspend Mode	2-24
2.5.2	ACPI 2.0 Support	2-24
2.5.3	ACPI APIC Support	2-24
2.5.4	APM Configuration	2-25
2.5.5	Hardware Monitor	2-26

2.6	Boot menu	2-27
2.6.1	Boot Device Priority	2-27
2.6.2	Removable Drives	2-27
2.6.3	Boot Settings Configuration	2-28
2.6.4	Security	2-29
2.7	Exit menu	2-31

Chapter 3: Software support

3.1	Install an operating system	3-2
3.2	Support CD information	3-2
3.2.1	Running the support CD	3-2
3.2.2	Drivers menu	3-3
3.2.3	Utilities menu	3-3
3.2.4	ASUS contact information	3-4
3.3	RAID configurations	3-5
3.3.1	Installing hard disks	3-5
3.3.2	SIS RAID configurations	3-6
3.4	Creating a RAID driver disk	3-15

Notices

Federal Communications Commission Statement

This device complies with Part 15 of the FCC Rules. Operation is subject to the following two conditions:

- This device may not cause harmful interference, and
- This device must accept any interference received including interference that may cause undesired operation.

This equipment has been tested and found to comply with the limits for a Class B digital device, pursuant to Part 15 of the FCC Rules. These limits are designed to provide reasonable protection against harmful interference in a residential installation. This equipment generates, uses and can radiate radio frequency energy and, if not installed and used in accordance with manufacturer's instructions, may cause harmful interference to radio communications. However, there is no guarantee that interference will not occur in a particular installation. If this equipment does cause harmful interference to radio or television reception, which can be determined by turning the equipment off and on, the user is encouraged to try to correct the interference by one or more of the following measures:

- Reorient or relocate the receiving antenna.
- Increase the separation between the equipment and receiver.
- Connect the equipment to an outlet on a circuit different from that to which the receiver is connected.
- Consult the dealer or an experienced radio/TV technician for help.



The use of shielded cables for connection of the monitor to the graphics card is required to assure compliance with FCC regulations. Changes or modifications to this unit not expressly approved by the party responsible for compliance could void the user's authority to operate this equipment.

Canadian Department of Communications Statement

This digital apparatus does not exceed the Class B limits for radio noise emissions from digital apparatus set out in the Radio Interference Regulations of the Canadian Department of Communications.

This class B digital apparatus complies with Canadian ICES-003.

Safety information

Electrical safety

- To prevent electrical shock hazard, disconnect the power cable from the electrical outlet before relocating the system.
- When adding or removing devices to or from the system, ensure that the power cables for the devices are unplugged before the signal cables are connected. If possible, disconnect all power cables from the existing system before you add a device.
- Before connecting or removing signal cables from the motherboard, ensure that all power cables are unplugged.
- Seek professional assistance before using an adapter or extension cord. These devices could interrupt the grounding circuit.
- Make sure that your power supply is set to the correct voltage in your area. If you are not sure about the voltage of the electrical outlet you are using, contact your local power company.
- If the power supply is broken, do not try to fix it by yourself. Contact a qualified service technician or your retailer.

Operation safety

- Before installing the motherboard and adding devices on it, carefully read all the manuals that came with the package.
- Before using the product, make sure all cables are correctly connected and the power cables are not damaged. If you detect any damage, contact your dealer immediately.
- To avoid short circuits, keep paper clips, screws, and staples away from connectors, slots, sockets and circuitry.
- Avoid dust, humidity, and temperature extremes. Do not place the product in any area where it may become wet.
- Place the product on a stable surface.
- If you encounter technical problems with the product, contact a qualified service technician or your retailer.

P4S800-MX SE specification summary

CPU	Socket 478 for Intel® Pentium® 4/Celeron processors Intel® Hyper-Threading technology ready Supports Intel® Prescott CPU
Chipset	SiS661 FX SiS964
Front Side Bus (FSB)	800/533 MHz
Memory	2 x 184-pin DDR DIMM sockets for up to 2GB memory Supports DDR400/333/266 unbuffered non-ECC DDR DIMMs
Expansion slots	1 x AGP 8X/4X (1.5V only) 3 x PCI
VGA	SiS Real256E integrated graphics
Storage	2 x UltraATA133/100/66/33 2 x Serial ATA with RAID 0, RAID 1 and JBOD support
Audio	Realtek® ALC655 6-channel audio CODEC
LAN	Integrated 10/100 Mbps LAN controller + Realtek® LAN PHY
Special features	ASUS CrashFree BIOS 2 ASUS EZ Flash ASUS MyLogo2 Digital audio via S/PDIF out interface
Overclock Features	FSB frequency adjustable with 1MHz step (SFS) AGP/PCI Asynchronous mode with FSB ASUS C.P.R. (CPU Parameter Recall)
Rear panel I/O	1 x Parallel port 1 x Serial port 1 x Video port 1 x PS/2 keyboard port 1 x PS/2 mouse port 1 x RJ-45 port 4 x USB 2.0/USB 1.1 ports Line In/Line Out/Microphone ports
Internal I/O	2 x USB 2.0 connector for additional four USB ports CPU and chassis fan connectors 20-pin/4-pin ATX 12V power connectors CD/AUX audio connectors S/PDIF out connector Front panel audio connector System panel connector GAME/MIDI connector Floppy disk drive connector 2 x IDE connectors

(Continued on the next page.)

P4S800-MX SE specification summary

BIOS features	4Mb Flash ROM, AMI BIOS, PnP features, DMI2.0, WfM2.0, SM BIOS 2.3, ACPI 2.0, ASUS CrashFree BIOS 2, ASUS MyLogo2, ASUS C.P.R. (CPU Parameter Recall), ASUS EZ Flash
Industry standard	PCI 2.2, USB 2.0/1.1
Manageability	WOL/WOR by PME, WfM 2.0, DMI 2.0
Form Factor	Micro-ATX form factor: 9.6 in x 9.6 in (24.5 cm x 24.5 cm)
Support CD contents	Device drivers ASUS PC Probe ASUS LiveUpdate ASUS Screensaver Adobe Acrobat Reader Anti-virus utility

Specifications are subject to change without notice.

About this guide

Conventions used in this guide

To make sure that you perform certain tasks properly, take note of the following symbols used throughout this guide.



WARNING: Information to prevent injury to yourself when trying to complete a task.



CAUTION: Information to prevent damage to the components when trying to complete a task.



IMPORTANT: Information that you **MUST** follow to complete a task.



NOTE: Tips and additional information to aid in completing a task.

Chapter 1

This chapter describes the features of the motherboard. It includes brief descriptions of the motherboard components, and illustrations of the layout, jumper settings, and connectors.

Product introduction

1.1 Welcome!

Thank you for buying the ASUS® P4S800-MX SE motherboard!

The ASUS P4S800-MX SE motherboard delivers a host of new features and latest technologies making it another standout in the long line of ASUS quality motherboards!

Before you start installing the motherboard, and hardware devices on it, check the items in your package with the list below.

1.2 Package contents

Check your P4S800-MX SE package for the following items.

- ✓ ASUS P4S800-MX SE motherboard
- ✓ ASUS P4S800-MX SE series support CD
- ✓ Serial ATA cable
- ✓ Serial ATA power cable
- ✓ 80-conductor UltraATA IDE cable
- ✓ Ribbon cable for a 3.5-inch floppy drive
- ✓ I/O shield
- ✓ Bag of extra jumper caps
- ✓ User Guide



If any of the above items is damaged or missing, contact your retailer.

1.3 Special features

Intel® 800MHz FSB CPU support 

The motherboard comes with a 478-pin surface mount, Zero Insertion Force (ZIF) socket for the Intel® Pentium® 4 processor. This motherboard supports 800/533/400 MHz system front side bus that allows 6.4GB/s, 4.3GB/s and 3.2GB/s data transfer rates, respectively. The P4S800-MX SE also supports the Intel® Hyper-Threading Technology and Intel® Prescott CPU. See page 1-8 for details.

SiS661FX/964 chipset 

Embedded in this motherboard is the SiS661FX/964 chipset that integrates various SiS-developed technologies to ensure an efficient and reliable computing performance.

The SiS661FX chipset provides a high performance host interface for the Intel® Pentium® 4 processor, and supports AGP 8X, 800MHz front side bus, and DDR400. The SiS661FX features the SiS HyperStreaming™ Engine that smartly manages data streams between peripherals, core logic chipsets, front side bus, memory and graphic interfaces. This technology dramatically optimizes and improves the entire computer system performance.

Providing I/O and peripheral support is the SiS964 southbridge. The southbridge is a subsystem that integrates various I/O functions including dual-channel ATA133 bus master IDE, USB 2.0/1.1, Ethernet, and audio controllers. The SiS964 provides LPC and AC'97 interfaces, and complies with the Advanced Power Management (APM) 1.2 specification. The SiS964 interconnects with the northbridge at up to 1GB/s using the SiS proprietary MuTIOL® bus interface.

DDR400 support

The motherboard supports up to 2GB of system memory using DDR400/333/266 non-ECC DDR DIMMs to deliver up to 3.2GB/s data transfer rate for the latest 3D graphics, multimedia, and Internet applications. See page 1-10.

Real256E integrated graphics

Embedded in the northbridge is the SiS Real256E integrated graphics with a 256-bit 3D engine and 2D graphics accelerator with a maximum 64MB shared display memory. The Real256E integrated graphics engine incorporates the UltraAGPII™ technology to provide a faster link between the built-in graphic engine and the northbridge memory controller. This technology boosts VGA throughput to up to 3.2GB/s to bring clearer and sharper images for your multimedia and graphic-intensive applications. The Real256E integrated graphics achieves a maximum resolution of 2048x1536 at 32bpp. See page 1-17.

Integrated 10/100 Mbps LAN controller

Onboard is the Realtek® LAN PHY that interconnects with the SiS964 southbridge LAN controller to fully support 10BASE-T/ 100BASE-TX Ethernet networking. See page 1-17.

6-Channel Audio solution

The motherboard uses an onboard audio CODEC that lets you enjoy high-quality 6-channel audio without having to buy advanced sound cards. See page 1-17.

Serial ATA technology

The motherboard supports the Serial ATA technology through the Serial ATA interfaces and the SIS 964 chipset. The SATA specification allows for thinner, more flexible cables with lower pin count, reduced voltage requirement, and up to 150 MB/s data transfer rate. See page 1-19 for details.

USB 2.0 technology



The motherboard implements the Universal Serial Bus (USB) 2.0 specification, dramatically increasing the connection speed from the 12 Mbps bandwidth on USB 1.1 to a fast 480 Mbps on USB 2.0. USB 2.0 is backward compatible with USB 1.1. See page 1-17 and 1-22 for details.

ASUS CrashFree BIOS 2



This feature allows you to restore the original BIOS data from the support CD in case when the BIOS codes and data are corrupted. This protection eliminates the need to buy a replacement ROM chip. See details on page 2-6.

ASUS EZ Flash BIOS



With the ASUS EZ Flash, you can easily update the system BIOS even before loading the operating system. No need to use a DOS-based utility or boot from a floppy disk. See page 2-5.

ASUS MyLogo2™



This new feature present in the motherboard allows you to personalize and add style to your system with customizable boot logos.

C.P.R. (CPU Parameter Recall)



The C.P.R. feature of the motherboard BIOS allows automatic re-setting to the BIOS default settings in case the system hangs due to overclocking. When the system hangs due to overclocking, C.P.R. eliminates the need to open the system chassis and clear the RTC data. Simply shut down and reboot the system, and the BIOS automatically restores the CPU default setting for each parameter.

1.4 Before you proceed

Take note of the following precautions before you install motherboard components or change any motherboard settings.



1. Unplug the power cord from the wall socket before touching any component.
2. Use a grounded wrist strap or touch a safely grounded object or to a metal object, such as the power supply case, before handling components to avoid damaging them due to static electricity.
3. Hold components by the edges to avoid touching the ICs on them.
4. Whenever you uninstall any component, place it on a grounded antistatic pad or in the bag that came with the component.
5. **Before you install or remove any component, ensure that the ATX power supply is switched off or the power cord is detached from the power supply.** Failure to do so may cause severe damage to the motherboard, peripherals, and/or components.

Onboard LED

The P4S800-MX SE comes with a stand-by power LED. When lit, the green LED indicates that the system is ON, in sleep mode, or in soft-off mode, a reminder that you should shut down the system and unplug the power cable before removing or plugging in any motherboard component. The illustration below shows the location of the onboard LED.

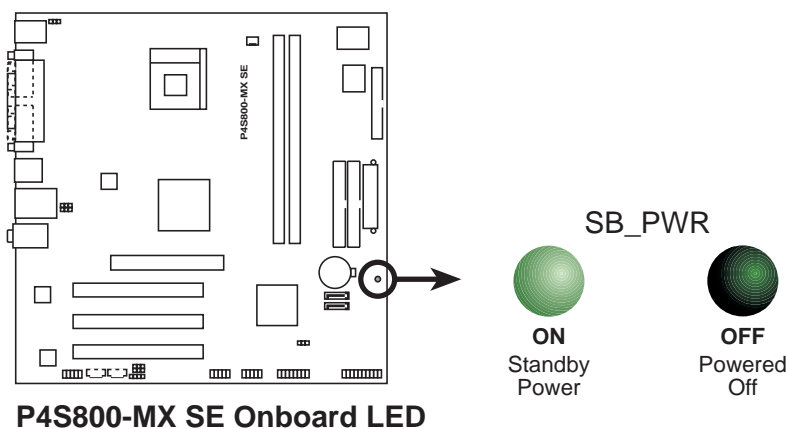

1.5 Motherboard overview

1.5.1 Motherboard layout

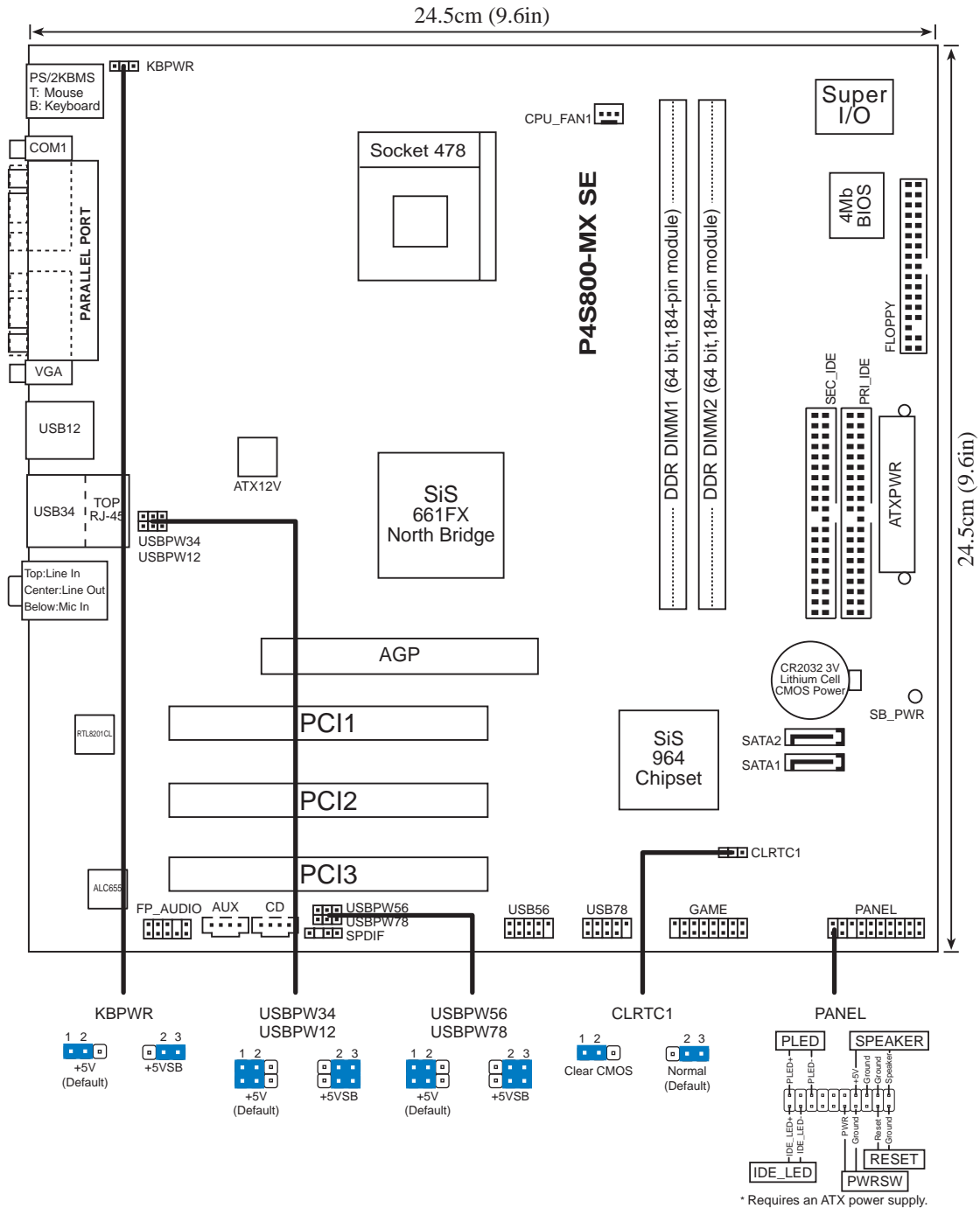

1.5.2 Placement direction

When installing the motherboard, make sure that you place it into the chassis in the correct orientation. The edge with external ports goes to the rear part of the chassis as indicated in the image below.

1.5.3 Screw holes

Place eight (8) screws into the holes indicated by circles to secure the motherboard to the chassis.



Do not overtighten the screws! Doing so may damage the motherboard.

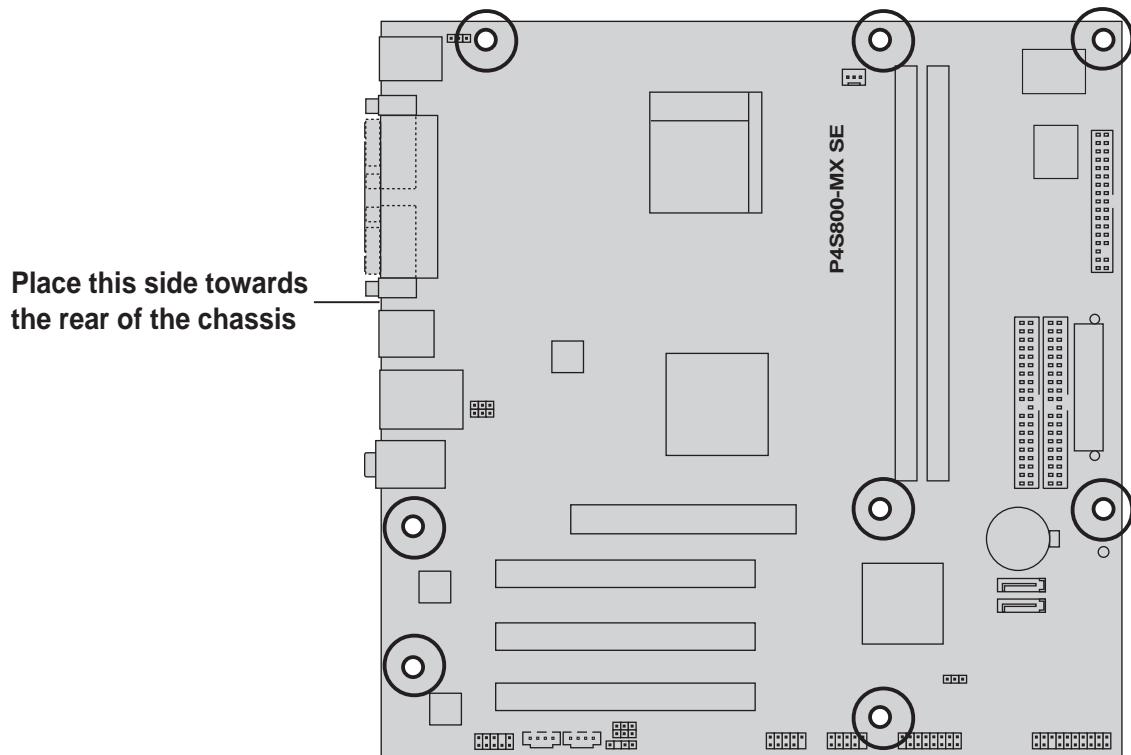

1.6 Central Processing Unit (CPU)

1.6.1 Overview

The Intel® Pentium® 4 processor has a gold triangular mark on one corner. This mark indicates the processor Pin 1 that should match a specific corner of the CPU socket.

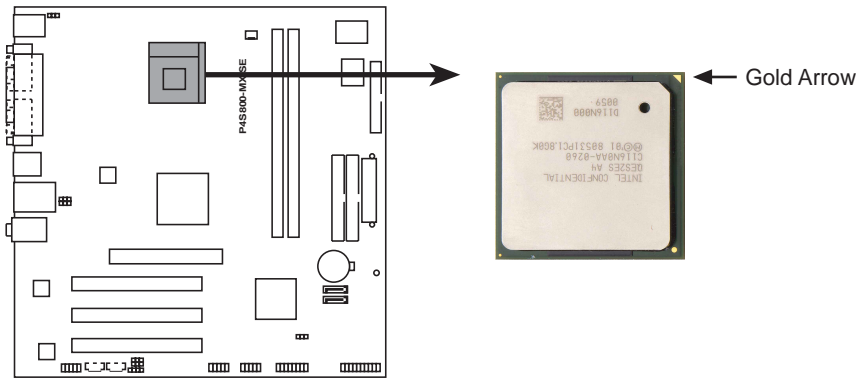

P4S800-MX SE CPU Socket 478



Incorrect installation of the CPU into the socket may bend the pins and severely damage the CPU!

Notes on Intel® Hyper-Threading Technology



1. Hyper-Threading Technology is supported under **Windows XP, Windows 2003 Server** and **Linux 2.4.x (kernel)** and later versions only. Under Linux, use the Hyper-Threading compiler to compile the code. If you are using any other operating systems, disable the Hyper-Threading Technology item in BIOS to ensure system stability and performance.
 2. We recommended that you install Windows XP Service Pack 1 and later versions.
 3. Make sure to enable the Hyper-Threading Technology item in BIOS before installing a supported operating system. See section "2.4.2 CPU Configuration" for details.
 4. For more information on Hyper-Threading Technology, visit www.intel.com/info/hyperthreading.
-

1.6.2 Installing the CPU

Follow these steps to install a CPU.

1. Locate the 478-pin ZIF socket on the motherboard.
2. Unlock the socket by pressing the lever sideways, then lift it up to a 90°-100° angle.



Make sure that the socket lever is lifted up to 90°-100° angle, otherwise the CPU does not fit in completely.

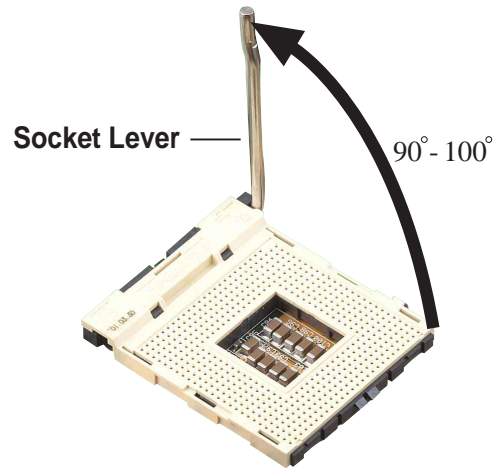

3. Position the CPU above the socket such that its marked corner matches the base of the socket lever.
4. Carefully insert the CPU into the socket until it fits in place.



The CPU fits only in one correct orientation. DO NOT force the CPU into the socket to prevent bending the pins and damaging the CPU!

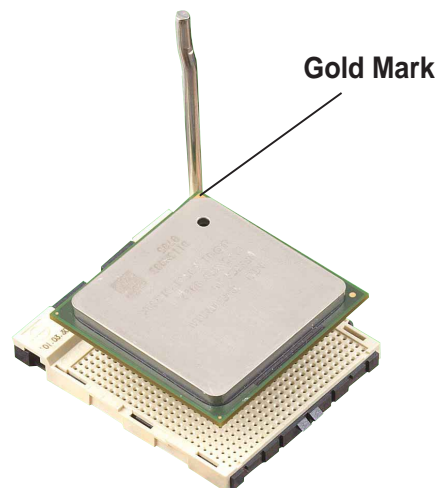

5. When the CPU is in place, push down the socket lever to secure the CPU. The lever clicks on the side tab to indicate that it is locked.
6. Install a CPU heatsink and fan following the instructions that came with the heatsink package.
7. Connect the CPU fan cable to the CPU_FAN1 connector on the motherboard.



1.7 System memory

1.7.1 DIMM sockets location

The following figure illustrates the location of the DDR DIMM sockets.

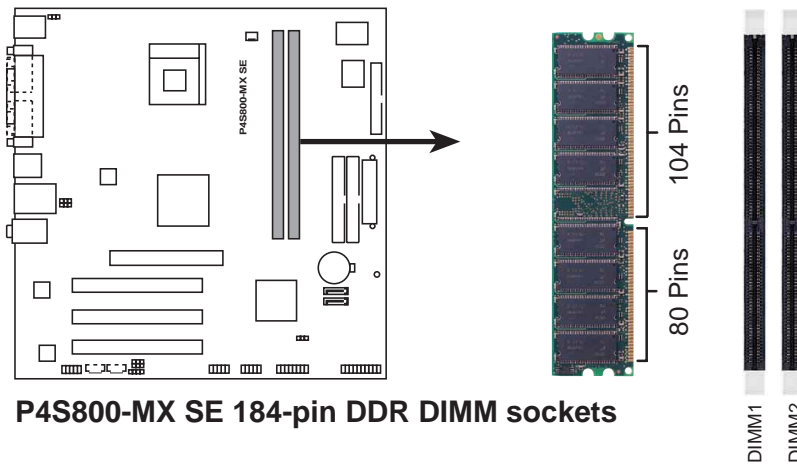

Make sure to unplug the power supply before adding or removing DIMMs or other system components. Failure to do so may cause severe damage to both the motherboard and the components.

When installing long AGP cards, it is recommended to install the memory modules first. Long AGP cards, when installed, may interfere with the memory sockets.

1.7.2 Memory configurations

You may install 64MB, 128MB, 256MB, 512MB, and 1GB DDR DIMMs into the DIMM sockets.



Obtain DDR DIMMs only from ASUS qualified vendors. Refer to the Qualified DDR400 vendors list next page. Visit the ASUS website (www.asus.com) for the latest DDR Qualified Vendors List.

Table 1 Qualified DDR400 vendors list

This table lists the memory modules that have been tested and qualified for use with this motherboard.

Size	Vendor	Model	Brand	Side(s)	Component	A	B
256	CORSAIR	CMX256A-3200LL DDR400	N/A	DS	N/A	V	V
256	CORSAIR	VS256MB400	N/A	SS	VS32M8-5 2B0409	V	V
512	CORSAIR	VS512MB400	N/A	DS	VS32M8-5 2B0412	V	V
512	CORSAIR	CMX512-3200LL DDR400	N/A	DS	N/A	V	V
256	HYNIX	HYMD232646B8J-D43	HYNIX	SS	HY5DU56822BT-D43	V	V
256	HYNIX	HYMD232646D8J-D43 AA	HYNIX	SS	HY5DU56822DT-D43	V	V
256	INFINEON	HYS64D32300GU-5-C	INFINEON	SS	HYB25D256800CE-5-C	V	V
256	INFINEON	HYS64D32300HU-5-C	INFINEON	SS	HYB25D256800CE-5C	V	V
512	INFINEON	HYS64D64320GU-5-B	N/A	DS	HYB25D256800BT-5B	V	V
256	KINGSTON	VALUERAM KVR400X64C3A/256	N/A	SS	D32080HIT-5	V	V
256	KINGSTON	VALUERAM KVR400X64C3A/256	WINBOND	SS	W942508BH-5	V	V
512	KINGSTON	KVR400X64C3A/512	N/A	DS	D32080HIT-5	V	
512	KINGSTON	VALUE RAM KVR400X64C3A/512DDR	HYNIX	DS	HY5DU56822BT-D43	V	V
512	KINGSTON	VALUERAM KVR400X72C3A/512	N/A	DS	V58C2256804SAT5	V	
1G	KINGSTON	VALUERAM KVR400X64C3A/1G	INFINEON	DS	HYB25D512800BE-5B	V	
256	MICRON	MT8VDDT3264AG-40BGB	N/A	SS	MT46V32M8TG-5BG	V	V
512	MICRON	MT16VDDT6464AG-40BC4	N/A	DS	MT46V32M8TG-5BC	V	V
512	MICRON	MT16VDDT6464AG-40BGB	N/A	DS	MT46V32M8TG-5BG	V	
512	MICRON	MT16VDDT6464AG-40BCB	N/A	DS	MT46V32M8TG-5BC	V	V
256	SAMSUNG	M368L3223FTN-CCC	SAMSUNG	SS	K4H560838F-TCCC	V	V
512	SAMSUNG	M368L6423FTN-CCC	SAMSUNG	DS	K4H560838F-TCCC	V	V
256	TRANSCEND	TS32MLD64V4F3	N/A	SS	N/A	V	
512	WINBOND	U24512ADWBG6H20	N/A	DS	N/A	V	V
256	APACER	77.10636.11G	INFINEON	SS	HYB25D256800BT-5B	V	V
512	APACER	77.10736.11G	INFINEON	DS	HYB25D256800BT-5B	V	V
256	BRAIN POWER	N/A	N/A	SS	K4H560838D-TCC4	V	
256	KINGMAX	N/A	N/A	SS	V58C2256804SCT5B	V	
512	KINGMAX	MPXC22D-38KT3R	N/A	DS	KDL388P4LA-50	V	V
512	NANYA	NT512D64S8HB1G-5T	NANYA	DS	NT5DS3232M8BT-5T	V	V
256	PROMOS	V826632K24SCTG-D0	N/A	SS	V58C2256804SCT5B	V	V

* Side/s:

DS - Double-sided

SS - Single-sided

1.7.3 Installing a DIMM

Follow these steps to install a DIMM.

1. Unlock a DIMM socket by pressing the retaining clips outward.
2. Align a DIMM on the socket such that the notch on the DIMM matches the break on the socket.
3. Firmly insert the DIMM into the socket until the retaining clips snap back in place and the DIMM is properly seated.

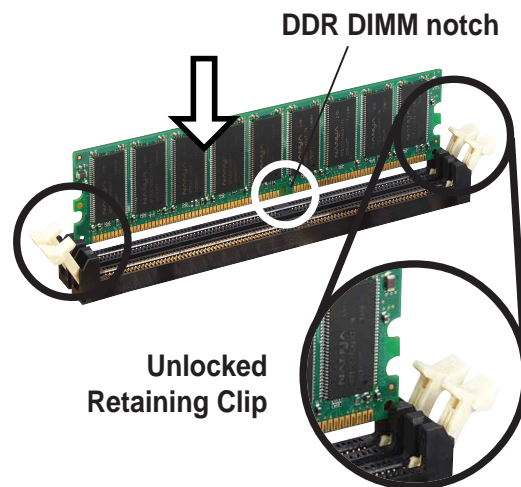

A DDR DIMM is keyed with a notch so that it fits in only one direction. **DO NOT** force a DIMM into a socket to avoid damaging the DIMM.

1.8 Expansion slots

In the future, you may need to install expansion cards. The following sub-sections describe the slots and the expansion cards that they support.



Make sure to unplug the power cord before adding or removing expansion cards. Failure to do so may cause you physical injury and damage motherboard components.

1.8.1 Installing an expansion card

Follow these steps to install an expansion card.

1. Before installing the expansion card, read the documentation that came with it and make the necessary hardware settings for the card.
2. Remove the system unit cover (if your motherboard is already installed in a chassis).
3. Remove the bracket opposite the slot that you intend to use. Keep the screw for later use.
4. Align the card connector with the slot and press firmly until the card is completely seated on the slot.
5. Secure the card to the chassis with the screw you removed earlier.
6. Replace the system cover.

1.8.2 Configuring an expansion card

After installing the expansion card, configure it by adjusting the software settings.

1. Turn on the system and change the necessary BIOS settings, if any. See Chapter 2 for information on BIOS setup.
2. Assign an IRQ to the card. Refer to the tables on the next page.
3. Install the software drivers for the expansion card.

Standard interrupt assignments

IRQ	Priority	Standard Function
0	1	System Timer
1	2	Keyboard Controller
2	N/A	Programmable Interrupt
4*	12	Communications Port (COM1)
5*	13	IRQ holder for PCI steering
6	14	Floppy Disk Controller
7*	15	Printer Port (LPT1)
8	3	System CMOS/Real Time Clock
9*	4	IRQ holder for PCI steering
10*	5	Advance AC'97 CODEC
11*	6	Standard PCI Graphics Adapter (VGA)
12*	7	PS/2 Compatible Mouse Port
13	8	Numeric Data Processor
14*	9	Primary IDE Channel
15*	10	Secondary IDE Channel

* These IRQs are usually available for ISA or PCI devices.

IRQ assignments for this motherboard

	A	B	C	D	E	F	G	H
PCI slot 1	—	—	shared	—	—	—	—	—
PCI slot 2	—	—	—	shared	—	—	—	—
PCI slot 3	—	used	—	—	—	—	—	—
AGP slot	shared	—	—	—	—	—	—	—
Onboard USB controller 1	—	—	—	—	used	—	—	—
Onboard USB controller 2	—	—	—	—	—	used	—	—
Onboard USB controller 3	—	—	—	—	—	—	used	—
Onboard USB 2.0 controller	—	—	—	—	—	—	—	used
Onboard LAN	—	—	—	shared	—	—	—	—
Onboard Audio	—	—	shared	—	—	—	—	—
Onboard VGA	shared	—	—	—	—	—	—	—



When using PCI cards on shared slots, ensure that the drivers support “Share IRQ” or that the cards do not need IRQ assignments. Otherwise, conflicts will arise between the two PCI groups, making the system unstable and the card inoperable.

1.8.3 PCI slots

The PCI slots support PCI cards such as a LAN card, SCSI card, USB card, and other cards that comply with PCI specifications.

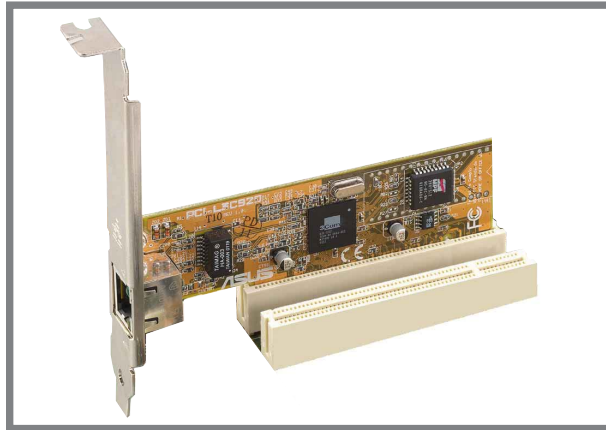

1.8.4 AGP slot

The Accelerated Graphics Port (AGP) slot that supports AGP 8X/4X (+1.5V) cards. When you buy an AGP card, make sure that you ask for one with +1.5V specification.

Note the notches on the card golden fingers to ensure that they fit the AGP slot on the motherboard.



This motherboard does not support 3.3V AGP cards. Install only +1.5V AGP cards.

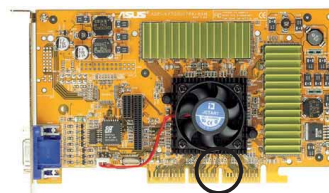
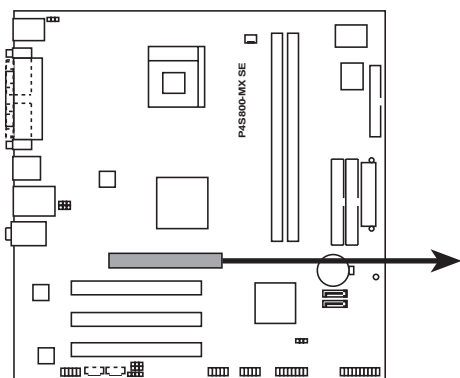

P4S800-MX SE Accelerated Graphics Port (AGP)

1.9 Jumpers

1. Clear RTC RAM (CLRRTC1)

This jumper allows you to clear the Real Time Clock (RTC) RAM in CMOS. You can clear the CMOS memory of date, time, and system setup parameters by erasing the CMOS RTC RAM data. The RAM data in CMOS, that include system setup information such as system passwords, is powered by the onboard button cell battery.

To erase the RTC RAM:

1. Turn OFF the computer and unplug the power cord.
2. Move the jumper cap from pins 2-3 (default) to pins 1-2. Keep the cap on pins 1-2 for about 5~10 seconds, then move the cap back to pins 2-3.
3. Plug the power cord and turn ON the computer.
4. Hold down the key during the boot process and enter BIOS setup to re-enter data.



Except when clearing the RTC RAM, never remove the cap on CLRRTC1 jumper default position. Removing the cap will cause system boot failure!

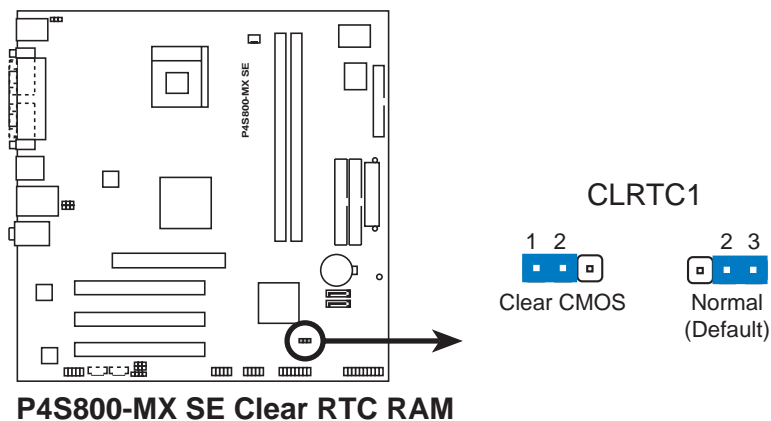

2. USB device wake-up (3-pin USBPW12, USBPW34, USBPW56, USBPW78)

Set these jumpers to +5V to wake up the computer from S1 sleep mode (CPU stopped, DRAM refreshed, system running in low power mode) using the connected USB devices. Set to +5VSB to wake up from S3 sleep mode (no power to CPU, DRAM in slow refresh, power supply in reduced power mode). Both jumpers are set to pins 1-2 (+5V) by default because not all computers have the appropriate power supply to support this feature.

The USBPW12 and USBPW34 jumpers are for the rear USB ports. The USBPW56 and USBPW78 jumpers are for the internal USB header that you can connect to the front USB ports.



1. This feature requires a power supply that can provide at least 500mA on the +5VSB lead on each USB port when these jumpers are set to +5VSB. Otherwise, the system would not power up.
2. The total current consumed must NOT exceed the power supply capability (+5VSB) whether under normal condition or in sleep mode.

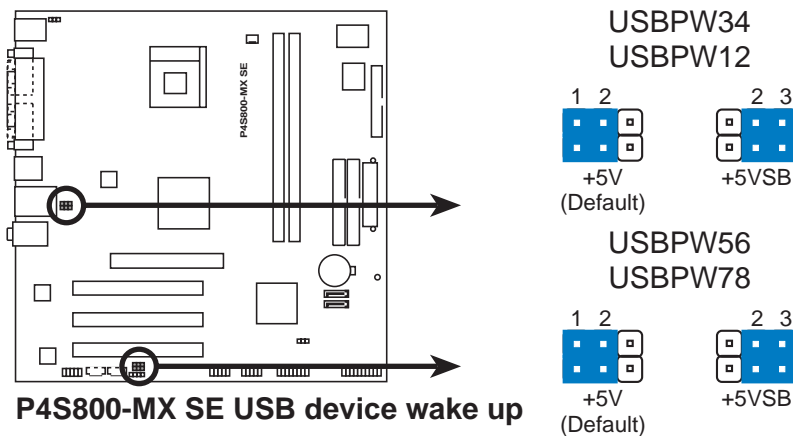

3. Keyboard power (3-pin KBPWR1)

This jumper allows you to enable or disable the keyboard wake-up feature. Set this jumper to pins 2-3 (+5VSB) if you wish to wake up the computer when you press a key on the keyboard (the default is the Space Bar). This feature requires an ATX power supply that can supply at least 500mA on the +5VSB lead, and a corresponding setting in the BIOS.

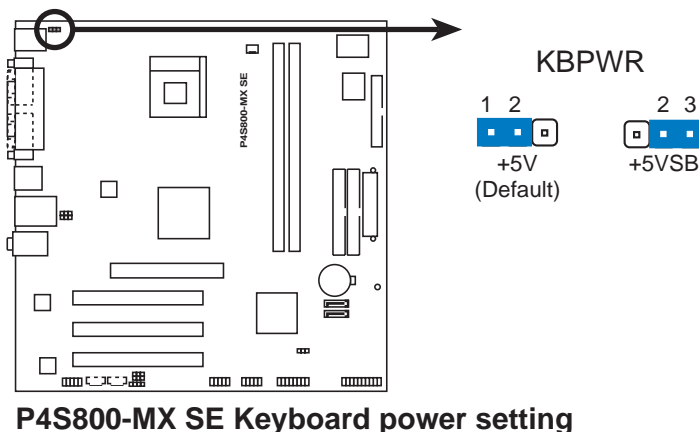

1.10 Connectors

This section describes and illustrates the motherboard rear panel and internal connectors.

1.10.1 Rear panel connectors

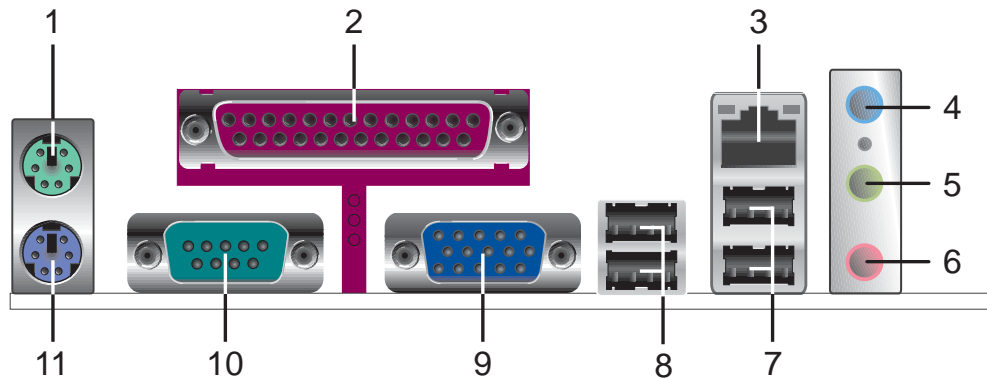

1. **PS/2 mouse port.** This green 6-pin connector is for a PS/2 mouse.
2. **Parallel port.** This 25-pin port connects a parallel printer, scanner, or other devices.
3. **RJ-45 port.** This port allows connection to a Local Area Network (LAN) through a network hub.
4. **Line In jack.** This Line In (light blue) jack connects a tape player or other audio sources. In 6-channel mode, the function of this jack becomes rear speaker.
5. **Line Out jack.** This Line Out (lime) jack connects a headphone or a speaker. In 6-channel mode, the function of this jack becomes front speaker out.
6. **Microphone jack.** This Mic (pink) jack connects a microphone. In 6-channel mode, the function of this jack becomes bass/center speaker.



The functions of the Line Out, Line In, and Microphone jacks change when you select the 6-channel audio configuration as shown in the following table.

Audio 2, 4 or 6-channel configuration

	Headphone /2-Speaker	4-Speaker	6-Speaker
Light Blue	Line In	Rear Speaker Out	Rear Speaker Out
Lime	Line Out	Front Speaker Out	Front Speaker Out
Pink	Mic In	Mic In	Bass/Center Speaker



Windows® 98SE only supports 2-channel speaker configuration.

7. **USB 2.0 ports 1 and 2.** These two 4-pin Universal Serial Bus (USB) ports are available for connecting USB 2.0 devices.
8. **USB 2.0 ports 3 and 4.** These two 4-pin Universal Serial Bus (USB) ports are available for connecting USB 2.0 devices.
9. **VGA port.** This port connects a VGA compatible monitor.
10. **Serial port.** This 9-pin COM port is for pointing devices or other serial devices.
11. **PS/2 keyboard port.** This purple connector is for a PS/2 keyboard.

1.10.2 Internal connectors

1. IDE connectors (40-1 pin PRI_IDE, SEC_IDE)

This connector supports the provided UltraATA133 IDE hard disk ribbon cable. Connect the cable's blue connector to the primary (recommended) or secondary IDE connector, then connect the gray connector to the UltraATA133/100/66 slave device (hard disk drive) and the black connector to the UltraATA133/100/66 master device.



1. Follow the hard disk drive documentation when setting the device in master or slave mode.
2. Pin 20 on each IDE connector is removed to match the covered hole on the UltraATA cable connector. This prevents incorrect orientation when you connect the cables.
3. Support for UltraATA133 is available only when using Windows XP with Service Pack 2.

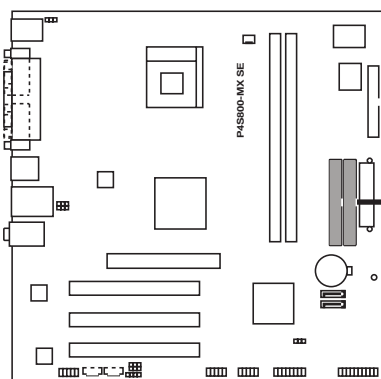

P4S800-MX SE IDE connectors

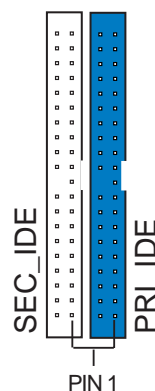

NOTE: Orient the red markings (usually zigzag) on the IDE ribbon cable to PIN 1.

2. Floppy disk drive connector (34-1 pin FLOPPY)

This connector supports the provided floppy drive ribbon cable. After connecting one end to the motherboard, connect the other end to the floppy drive. (Pin 5 is removed to prevent incorrect insertion when using ribbon cables with pin 5 plug).

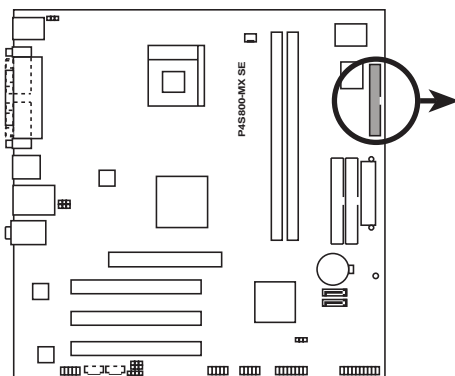

P4S800-MX SE Floppy disk drive connector



FLOPPY

NOTE: Orient the red markings on the floppy ribbon cable to PIN 1.

3. Serial ATA connectors (7-pin SATA1, SATA2)

These next generation connectors support the thin Serial ATA cables for primary internal storage devices. The current Serial ATA interface allows up to 150 MB/s data transfer rate, faster than the standard parallel ATA with 133MB/s (Ultra ATA/133).

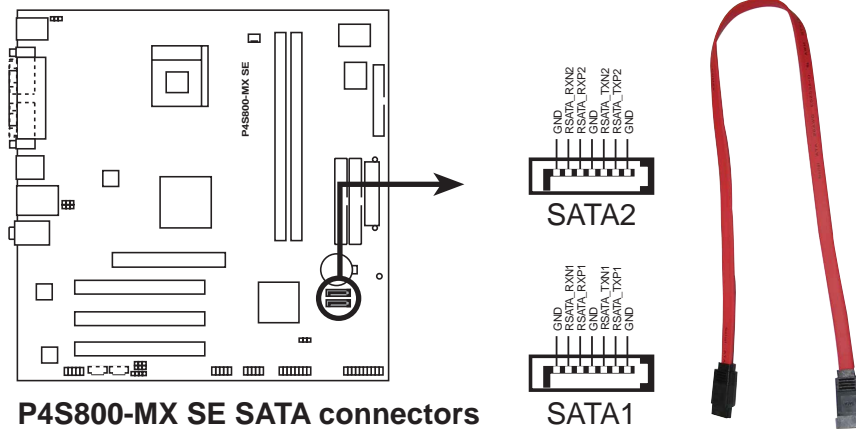

If you install SATA hard disk drives, you can create a RAID 0, RAID 1, or JBOD configuration with the SIS964 RAID controller. Refer to page 2-16 for the BIOS setting and page 3-15 for creating a RAID driver disk.



1. Install Windows® 2000 Service Pack 4, Windows® XP Service Pack 1 or later versions before using the Serial ATA feature.
 2. The Serial ATA RAID feature (RAID 0, RAID 1, JBOD) is available only if you're using Windows® 2000/XP or Windows® 2003 Server operating systems.
 3. Hot plug support for the Serial ATA drive and connectors are not available in this motherboard.
 4. Make sure to install the SIS RAID drivers before using the Serial ATA connectors.
-

4. ATX power connectors (20-pin ATXPWR, 4-pin ATX12V)

These connectors connect to an ATX 12V power supply. The plugs from the power supply are designed to fit these connectors in only one orientation. Find the proper orientation and push down firmly until the connectors completely fit.

In addition to the 20-pin ATXPWR connector, this motherboard requires that you connect the 4-pin ATX +12V power plug to provide sufficient power to the CPU.



Make sure that your ATX 12V power supply can provide 8A on the +12V lead and at least 1A on the +5-volt standby lead (+5VSB). The minimum recommended wattage is 230W, or 300W for a fully configured system. The system may become unstable and may experience difficulty powering up if the power supply is inadequate.

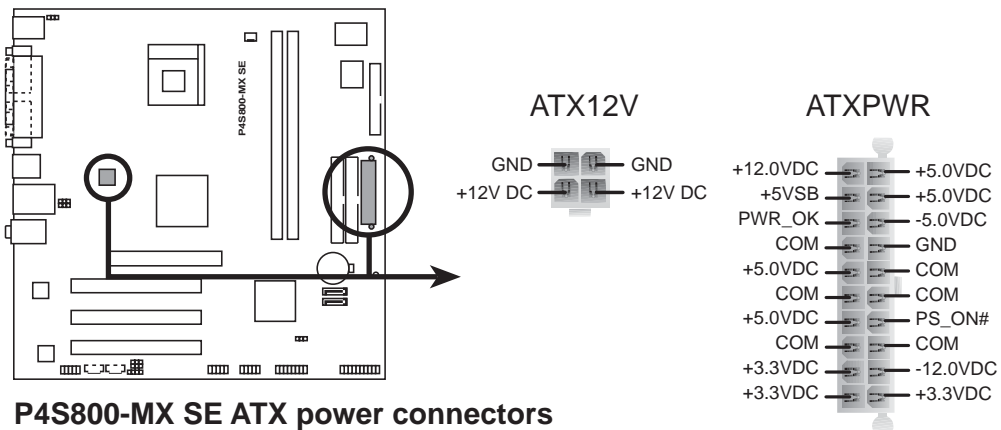

5. Front panel audio connector (10-1 pin FP_AUDIO1)

This is an interface for the front panel cable that allows convenient connection and control of audio devices.

By default, the pins labeled LINE OUT_R/BLINE_OUT_R and the pins LINE OUT_L/BLINE_OUT_L are shorted with jumper caps. Remove the caps only when you are connecting the front panel audio cable.

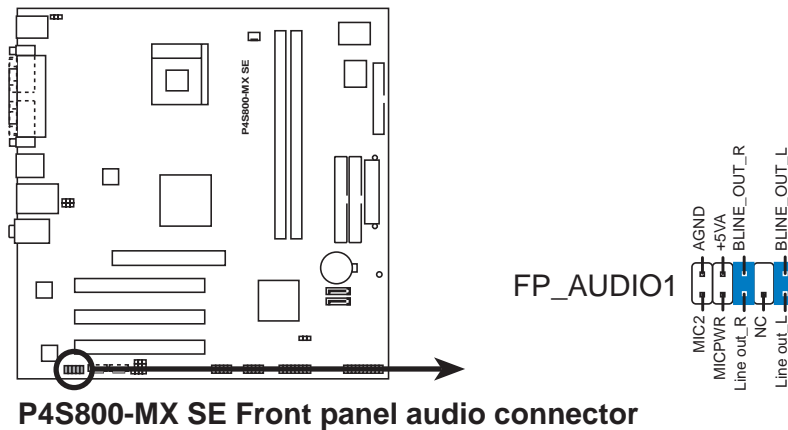

6. CPU fan connector (3-pin CPU_FAN1)

The CPU fan connector supports cooling fans of 350mA~740mA (8.88W max.) or a total of 1A~2.22A (26.64W max.) at +12V. Connect the fan cable to the fan connector on the motherboard, making sure that the black wire of each cable matches the ground pin of the connector.



Do not forget to connect the fan cables to the fan connectors. Lack of sufficient air flow within the system may damage the motherboard components. These are not jumpers! DO NOT place jumper caps on the fan connectors!

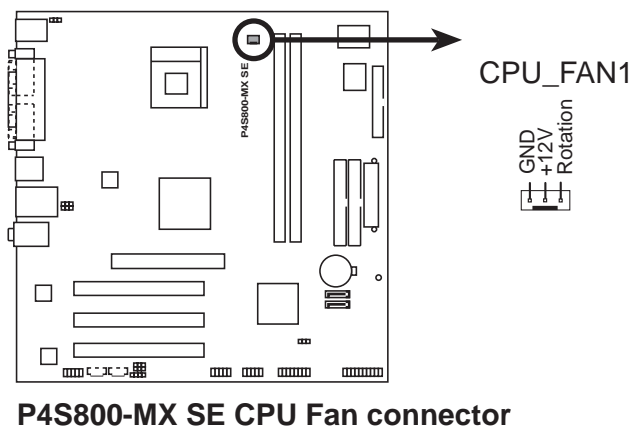

7. USB headers (10-1 pin USB56, USB78)

If the USB ports on the rear panel are inadequate, a USB header is available for additional USB ports. Connect the USB cable of an optional USB 2.0 module to this header. You may install the USB module in the chassis front panel. The module has two USB 2.0 ports for connecting next generation USB peripherals such as high resolution cameras, scanners, and printers.

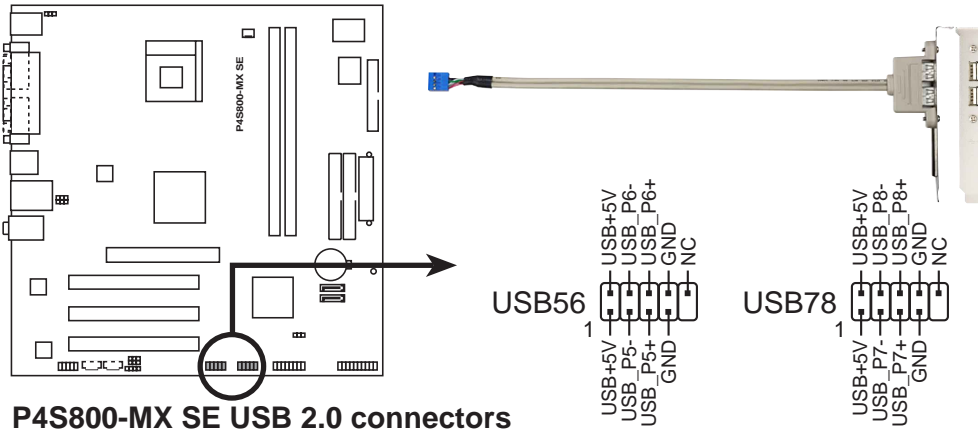

The USB module is purchased separately.

8. Digital audio connector (4-1 pin SPDIF)

An onboard S/PDIF Out connector is available for an optional S/PDIF audio module. Connect one end of the S/PDIF audio cable this connector and the other end to the S/PDIF module.

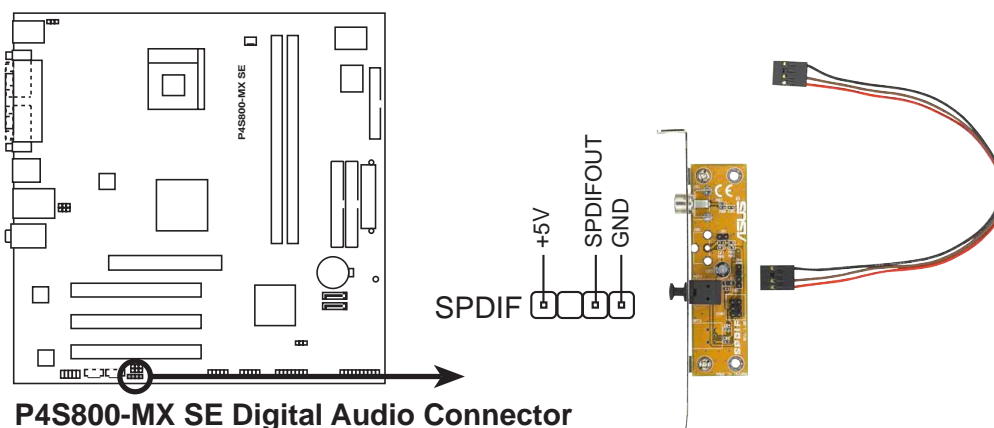

The S/PDIF module is purchased separately.

9. Internal audio connectors (4-pin AUX, CD)

These connectors allow you to receive stereo audio input from sound sources such as a CD-ROM, TV tuner, or MPEG card.

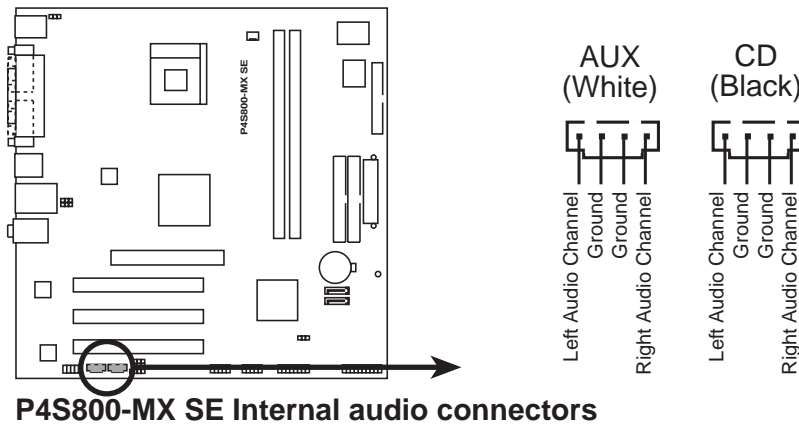

10. GAME/MIDI connector (16-1 pin GAME1)

This connector supports a GAME/MIDI module. Connect the GAME/MIDI cable with yellow connector to the yellow header on onboard. The GAME/MIDI port on the module connects a joystick or a game pad for playing games, and MIDI devices for playing or editing audio files.

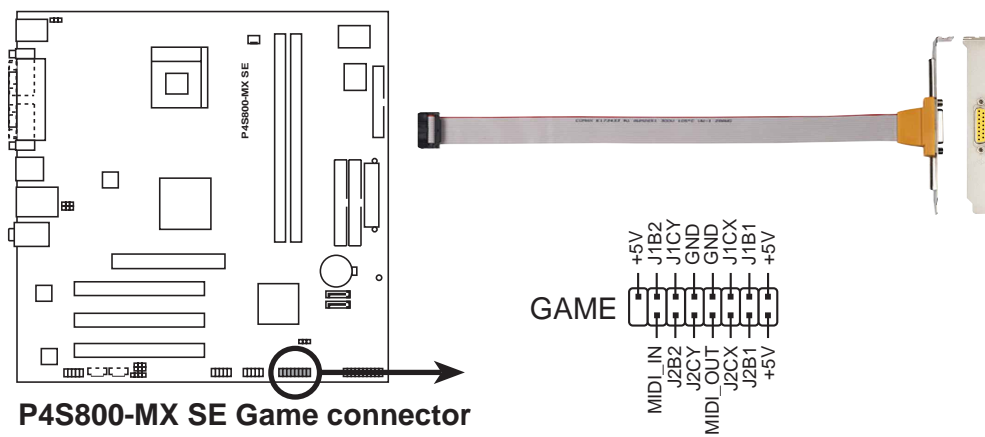

The GAME module is purchased separately.

11. System panel connector (20-pin PANEL)

This connector accommodates several system front panel functions.

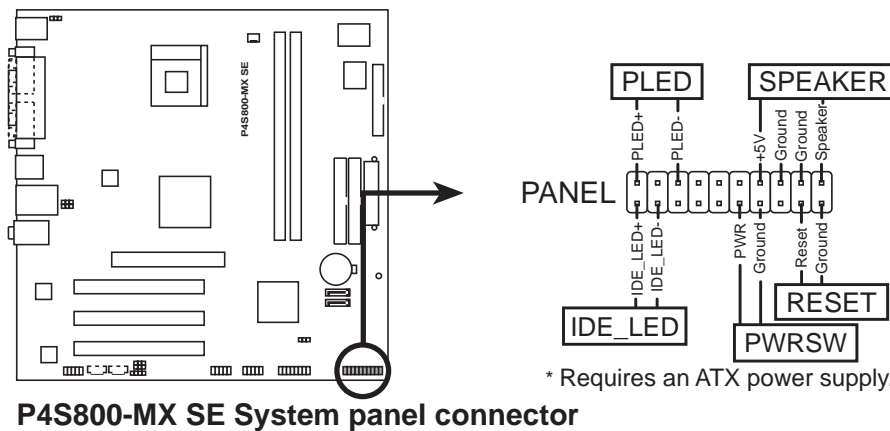

The system panel connector is color-coded for easy connection. Refer to the connector description below for details.

- **System power LED (Green 3-pin PLED)**

This 3-pin connector is for the system power LED. Connect the chassis power LED cable to this connector. The system power LED lights up when you turn on the system power, and blinks when the system is in sleep mode.

- **Hard disk drive activity LED (Red 2-pin IDE_LED)**

This 2-pin connector is for the HDD Activity LED. Connect the HDD Activity LED cable to this connector. The IDE LED lights up or flashes when data is read from or written to the HDD.

- **System warning speaker (Orange 4-pin SPEAKER)**

This 4-pin connector is for the chassis-mounted system warning speaker. The speaker allows you to hear system beeps and warnings.

- **ATX power button/soft-off button (Yellow 2-pin PWRSW)**

This connector is for the system power button. Pressing the power button turns the system on or puts the system in sleep or soft-off mode depending on the BIOS settings. Pressing the power switch for more than four seconds while the system is ON turns the system OFF.

- **Reset button (Blue 2-pin RESET)**

This 2-pin connector is for the chassis-mounted reset button for system reboot without turning off the system power.

Chapter 2

This chapter tells how to change system settings through the BIOS Setup menus. Detailed descriptions of the BIOS parameters are also provided.

BIOS information

2.1 Managing and updating your BIOS

The following utilities allow you to manage and update the motherboard Basic Input/Output System (BIOS) setup.

1. **AFUDOS** (Updates the BIOS in DOS mode using a bootable floppy disk.)
2. **ASUS EZ Flash** (Updates the BIOS using a floppy disk during POST.)
3. **CrashFree BIOS 2** (Updates the BIOS using a bootable floppy disk or the support CD when the BIOS gets corrupted.)
4. **ASUS Update** (Updates the BIOS in Windows® environment.)

Refer to the corresponding section for each utility.

Important notes



- It is recommended that you save a copy of the **original motherboard BIOS file** to a **bootable floppy disk** in case you need to restore the BIOS in the future. Copy the original motherboard BIOS using the AFUDOS or the ASUS Update utilities.
- A **working BIOS file** for this motherboard is in the support CD. Use this file only when you do not have a copy of the original motherboard BIOS file in a floppy disk.
- Visit the ASUS website and download the latest BIOS file for this motherboard using the ASUS Update utility.

2.1.1 Creating a bootable floppy disk

1. Do either one of the following to create a bootable floppy disk.

DOS environment

Insert a 1.44 MB floppy disk into the drive. At the DOS prompt, type:

format A:/S then press <Enter>.

Windows® XP environment

- a. Insert a 1.44 MB floppy disk to the floppy disk drive.
- b. Click **Start** from the Windows® desktop, then select **My Computer**.
- c. Select the 3 1/2 Floppy Drive icon.
- d. Click **File** from the menu, then select **Format**. A **Format 3 1/2 Floppy Disk** window appears.
- e. Select **Create an MS-DOS startup disk** from the format options field, then click **Start**.

Windows® 2000 environment

To create a set of boot disks for Windows® 2000:

- a. Insert a formatted, high density 1.44 MB floppy disk into the drive.
- b. Insert the Windows® 2000 CD to the optical drive.

- c. Click **Start**, then select **Run**.
 - d. From the Open field, type
D:\bootdisk\makeboot a:
assuming that D: is your optical drive.
 - e. Press <Enter>, then follow screen instructions to continue.
2. Copy the original or the latest motherboard BIOS file to the bootable floppy disk.

2.1.2 Using AFUDOS to copy the current BIOS

The AFUDOS.EXE utility can also be used to copy the current system BIOS settings to a floppy or hard disk. The copy can be used as a backup in case the system BIOS fails or gets corrupted.

1. At the DOS prompt, type the command line:

afudos /o<filename>

where “filename” can be any user provided filename of not more than eight (8) alpha-numeric characters for the main filename and three (3) alpha-numeric characters for the extension name.

Press the **Enter** key.



The BIOS information on the screen is for reference only. What you see on your screen may not be exactly the same as shown.

Main filename Extension name

```
A:\>afudos /oMYBIOS03.rom
AMI Firmware Update Utility - Version 1.10
Copyright (C) 2002 American Megatrends, Inc. All rights reserved.
Reading flash ..... 0x0008CC00 (9%)
```

2. The utility will copy the current system BIOS by default to the floppy disk. Make sure that the floppy disk is not write-protected and have enough space (at least 600KB) to store the file.

```
A:\>afudos /oMYBIOS03.rom
AMI Firmware Update Utility - Version 1.10
Copyright (C) 2002 American Megatrends, Inc. All rights reserved.
Reading flash ..... done
A:\>
```

When the BIOS copy process is complete, the utility returns to the DOS prompt.

2.1.3 Using AFUDOS to update the BIOS

The AFUDOS is a DOS-based application that lets you update the BIOS file using a bootable floppy diskette. AFUDOS also allows you to copy the original BIOS file to a floppy diskette.

To update the BIOS using the AFUDOS.EXE:

1. Visit the ASUS website (www.asus.com) to download the latest BIOS file for your motherboard. Save the BIOS file to a bootable floppy disk.



Write down the BIOS file name to a piece of paper. You need to type the **exact BIOS file name** at the prompt.

2. Copy the AFUDOS.EXE utility from the support CD to the bootable floppy disk that contains the BIOS file.
3. Boot the system from the floppy disk.
4. At the DOS prompt, type the command line: **afudos /i<filename.rom>** where “filename.rom” means the latest (or original) BIOS file that you copied to the bootable floppy disk.

The screen displays the status of the update process.



The BIOS information on the screen is for reference only. What you see on your screen may not be exactly the same as shown.

```
A:\>afudos /iP4S800SE.ROM
AMI Firmware Update Utility - Version 1.10
Copyright (C) 2002 American Megatrends, Inc. All rights reserved.
Reading file ..... done
Erasing flash .... done
Writing flash .... 0x0008CC00 (9%)
```



DO NOT shutdown or reset the system while updating the BIOS! Doing so may cause system boot failure!

When the BIOS update process is complete, the utility returns to the DOS prompt.

```
A:\>afudos /iP4S800SE.ROM
AMI Firmware Update Utility - Version 1.10
Copyright (C) 2002 American Megatrends, Inc. All rights reserved.
Reading file ..... done
Erasing flash .... done
Writing flash .... 0x0008CC00 (9%)
Verifying flash .. done

A:\>
```

5. Reboot the system from the hard disk.

2.1.4 Using ASUS EZ Flash to update the BIOS

The ASUS EZ Flash feature allows you to easily update the BIOS without having to go through the long process of booting from a floppy disk and using a DOS-based utility. The EZ Flash is built-in the BIOS LPC chip so it is accessible by simply pressing <Alt> + <F2> during the Power-On Self Tests (POST).

To update the BIOS using ASUS EZ Flash:

1. Visit the ASUS website (www.asus.com) to download the latest BIOS file for your motherboard and rename it to **P4S800SE.ROM**. Save the BIOS file to a floppy disk.
2. Reboot the system.
3. To launch EZ Flash, press <Alt> + <F2> during POST to display the following.

```
User recovery requested. Starting BIOS recovery...
Checking for floppy...
```



If there is no floppy disk found in the drive, the error message “**Floppy not found!**” appears.

If the correct BIOS file is not found in the floppy disk, the error message “**P4S800SE.ROM not found!**”

4. Insert the floppy disk that contains the BIOS file. If the **P4S800SE.ROM** file is found in the floppy disk, EZ Flash performs the BIOS update process and automatically reboots the system when done.



DO NOT shutdown or reset the system while updating the BIOS! Doing so may cause system boot failure!

```
User recovery requested. Starting BIOS recovery...
Checking for floppy...
Floppy found!
Reading file "P4S800SE.ROM". Completed.
Start flashing...
Flashed successfully. Rebooting.
```

2.1.5 ASUS CrashFree BIOS 2 utility

The ASUS CrashFree BIOS 2 is an auto recovery tool that allows you to restore the BIOS file when it fails or gets corrupted during the updating process. You can update a corrupted BIOS file using the motherboard support CD or the floppy disk that contains the updated BIOS file.



- Prepare the motherboard support CD or the floppy disk containing the updated motherboard BIOS before using this utility.
- Make sure that you rename the original or updated BIOS file in the floppy disk to **P4S800SE.ROM**.

Recovering the BIOS from a floppy disk

To recover the BIOS from a floppy disk:

1. Turn on the system.
2. Insert the floppy disk with the original or updated BIOS file to the floppy disk drive.
3. The utility displays the following message and automatically checks the floppy disk for the original or updated BIOS file.

```
Bad BIOS checksum. Starting BIOS recovery...
Checking for floppy...
```

When found, the utility reads the BIOS file and starts flashing the corrupted BIOS file.

```
Bad BIOS checksum. Starting BIOS recovery...
Checking for floppy...
Floppy found!
Reading file "P4S800SE.ROM". Completed.
Start flashing...
```



DO NOT shut down or reset the system while updating the BIOS! Doing so can cause system boot failure!

4. Restart the system after the utility completes the updating process.

Recovering the BIOS from the support CD

To recover the BIOS from the support CD:

1. Remove any floppy disk from the floppy disk drive, then turn on the system.
2. Insert the support CD to the optical drive.
3. The utility displays the following message and automatically checks the floppy disk for the original or updated BIOS file.

```
Bad BIOS checksum. Starting BIOS recovery...
Checking for floppy...
```

When no floppy disk is found, the utility automatically checks the optical drive for the original or updated BIOS file. The utility then updates the corrupted BIOS file.

```
Bad BIOS checksum. Starting BIOS recovery...
Checking for floppy...
Floppy not found!
Checking for CD-ROM...
CD-ROM found!
Reading file "P4S800SE.ROM". Completed.
Start flashing...
```



DO NOT shut down or reset the system while updating the BIOS! Doing so can cause system boot failure!

4. Restart the system after the utility completes the updating process.



The recovered BIOS may not be the latest BIOS version for this motherboard. Visit the ASUS website (www.asus.com) to download the latest BIOS file.

2.1.6 ASUS Update utility

The ASUS Update is a utility that allows you to manage, save, and update the motherboard BIOS in Windows® environment. The ASUS Update utility allows you to:

- Save the current BIOS file
- Download the latest BIOS file from the Internet
- Update the BIOS from an updated BIOS file
- Update the BIOS directly from the Internet, and
- View the BIOS version information.

This utility is available in the support CD that comes with the motherboard package.



ASUS Update requires an Internet connection either through a network or an Internet Service Provider (ISP).

Installing ASUS Update

To install ASUS Update:

1. Place the support CD in the optical drive. The **Drivers** menu appears.
2. Click the **Utilities** tab, then click **Install ASUS Update VX.XX.XX**. See page 5-3 for the **Utilities** screen menu.
3. The ASUS Update utility is copied to your system.



Quit all Windows® applications before you update the BIOS using this utility.

Updating the BIOS through the Internet

To update the BIOS through the Internet:

1. Launch the ASUS Update utility from the Windows® desktop by clicking **Start > Programs > ASUS > ASUSUpdate > ASUSUpdate**. The ASUS Update main window appears.

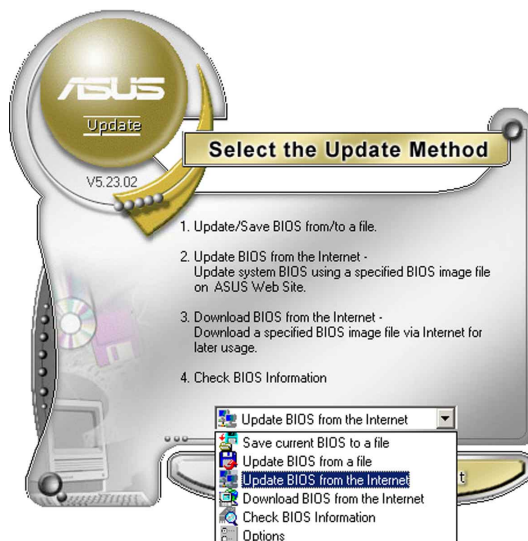
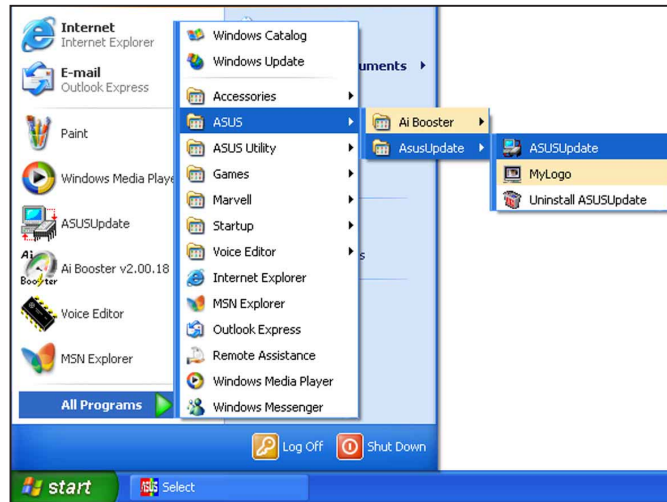

2. Select **Update BIOS from the Internet** option from the drop-down menu, then click **Next**.



3. Select the ASUS FTP site nearest you to avoid network traffic, or click **Auto Select**. Click **Next**.

- From the FTP site, select the BIOS version that you wish to download. Click Next.
- Follow the screen instructions to complete the update process.



The ASUS Update utility is capable of updating itself through the Internet. Always update the utility to avail all its features.

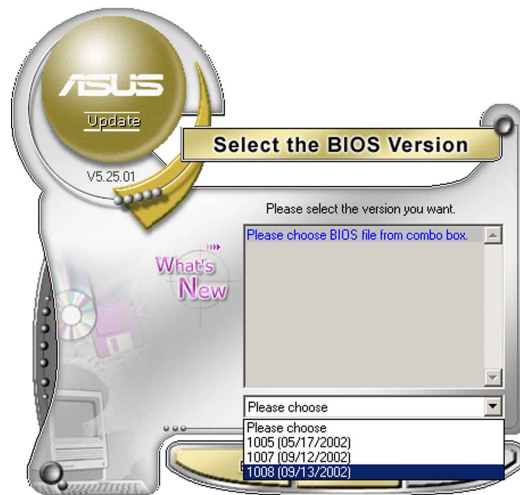

Updating the BIOS through a BIOS file

To update the BIOS through a BIOS file:

- Launch the ASUS Update utility from the Windows® desktop by clicking **Start > Programs > ASUS > ASUSUpdate > ASUSUpdate**. The ASUS Update main window appears.
- Select **Update BIOS from a file** option from the drop-down menu, then click **Next**.

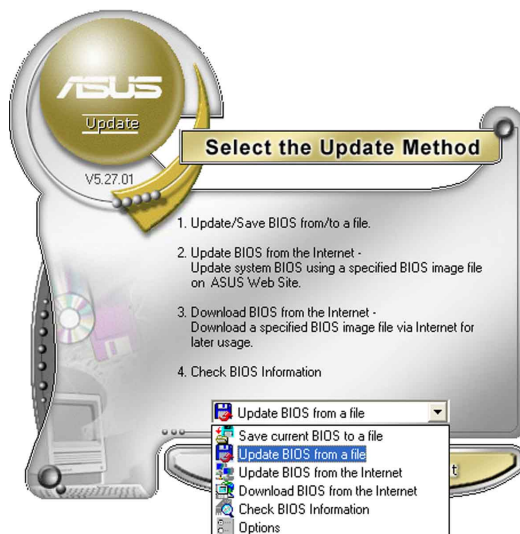

- Locate the BIOS file from the **Open** window, then click **Save**.
- Follow the screen instructions to complete the update process.

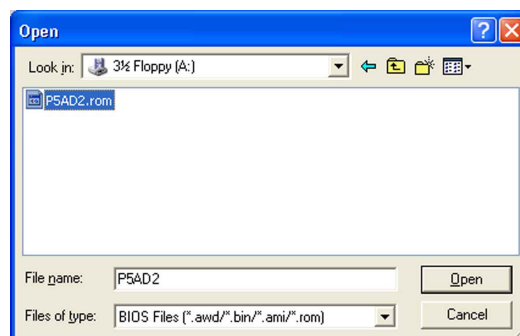

2.2 BIOS Setup program

This motherboard supports a programmable Low Pin Count (LPC) chip that you can update using the provided utility described in section “2.1 Managing and updating your BIOS.”

Use the BIOS Setup program when you are installing a motherboard, reconfiguring your system, or prompted to “Run Setup”. This section explains how to configure your system using this utility.

Even if you are not prompted to use the Setup program, you may want to change the configuration of your computer in the future. For example, you may want to enable the security password feature or make changes to the power management settings. This requires you to reconfigure your system using the BIOS Setup program so that the computer can recognize these changes and record them in the CMOS RAM of the LPC chip.

The LPC chip on the motherboard stores the Setup utility. When you start up the computer, the system provides you with the opportunity to run this program. Press during the Power-On Self Test (POST) to enter the Setup utility, otherwise, POST continues with its test routines.

If you wish to enter Setup after POST, restart the system by pressing <Ctrl>+<Alt>+<Delete>, or by pressing the reset button on the system chassis. You can also restart by turning the system off and then back on. Do this last option only if the first two failed.

The Setup program is designed to make it as easy to use as possible. It is a menu-driven program, which means you can scroll through the various sub-menus and make your selections among the predetermined choices.



Because the BIOS software is constantly being updated, the following BIOS setup screens and descriptions are for reference purposes only, and may not exactly match what you see on your screen.

2.2.1 BIOS menu screen

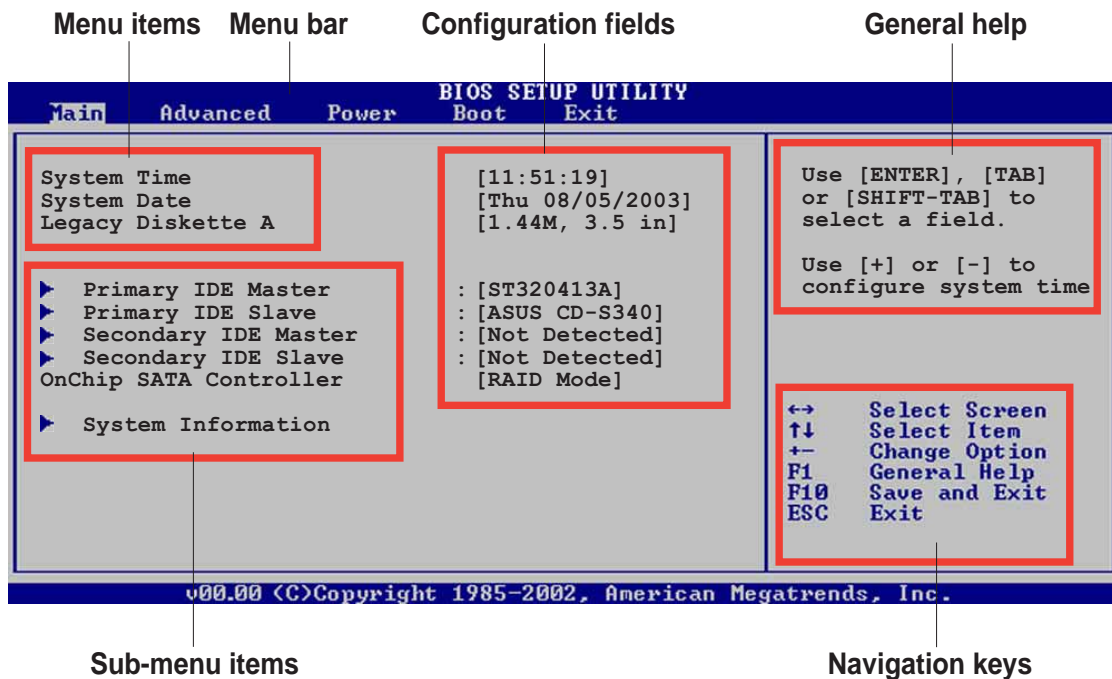

2.2.2 Menu bar

The menu bar on top of the screen has the following main items:

- | | |
|-----------------|----------------------------------------------------------------|
| Main | For changing the basic system configuration |
| Advanced | For changing the advanced system settings |
| Power | For changing the Advanced Power Management (APM) configuration |
| Boot | For changing the system boot configuration |
| Exit | For selecting the exit options and loading default settings |

To select an item on the menu bar, press the right or left arrow key on the keyboard until the desired item is highlighted.

2.2.3 Navigation keys

At the **bottom right corner** of a menu screen are the navigation keys for that particular menu. Use the navigation keys to select items in the menu and change the settings.



Some of the navigation keys differ from one screen to another.

2.2.4 Menu items

The highlighted item on the menu bar displays the specific items for that menu. For example, selecting **Main** shows the Main menu items.

The other items (Advanced, Power, Boot, and Exit) on the menu bar have their respective menu items.

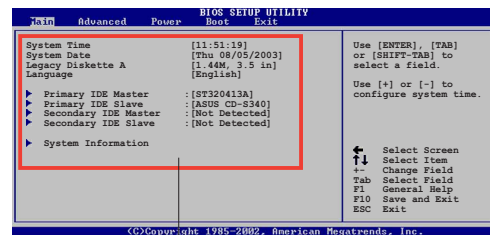

Main menu items

2.2.5 Sub-menu items

An item with a sub-menu on any menu screen is distinguished by a solid triangle before the item. To display the sub-menu, select the item and press <Enter>.

2.2.6 Configuration fields

These fields show the values for the menu items. If an item is user-configurable, you may change the value of the field opposite the item. You can not select an item that is not user-configurable.

A configurable field is enclosed in brackets, and is highlighted when selected. To change the value of a field, select it then press Enter to display a list of options. Refer to “2.2.7 Pop-up window.”

2.2.7 Pop-up window

Select a menu item then press Enter to display a pop-up window with the configuration options for that item.

2.2.8 Scroll bar

A scroll bar appears on the right side of a menu screen when there are items that do not fit on the screen. Press **Up/Down arrow keys** or **PageUp/PageDown keys** to display the other items on the screen.

2.2.9 General help

At the top right corner of the menu screen is a brief description of the selected item.

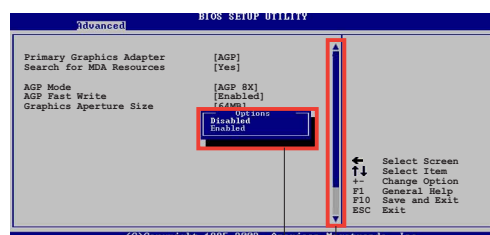

Pop-up window

Scroll bar

2.3 Main menu

When you enter the BIOS Setup program, the Main menu screen appears giving you an overview of the basic system information.



Refer to section “2.2.1 BIOS menu screen” for information on the menu screen items and how to navigate through them.

```

BIOS SETUP UTILITY
Main  Advanced  Power  Boot  Exit

System Time                [11:51:19]
System Date                [Thu 08/05/2003]
Legacy Diskette A         [1.44M, 3.5 in]

▶ Primary IDE Master       : [ST320413A]
▶ Primary IDE Slave       : [ASUS CD-S340]
▶ Secondary IDE Master     : [Not Detected]
▶ Secondary IDE Slave     : [Not Detected]
OnChip SATA Controller    [RAID Mode]

▶ System Information

Use [ENTER], [TAB]
or [SHIFT-TAB] to
select a field.

Use [+] or [-] to
configure system time.

←→ Select Screen
↑↓ Select Item
+- Change Option
F1  General Help
F10 Save and Exit
ESC Exit

v00.00 (C)Copyright 1985-2002, American Megatrends, Inc.
```

2.3.1 System Time [xx:xx:xxxx]

This item allows you to set the system time.

2.3.2 System Date [Day xx/xx/xxxx]

This item allows you to set the system date.

2.3.3 Legacy Diskette A [1.44M, 3.5 in.]

Sets the type of floppy drive installed. Configuration options: [Disabled]
[360K, 5.25 in.] [1.2M , 5.25 in.] [720K , 3.5 in.] [1.44M, 3.5 in.] [2.88M, 3.5 in.]

2.3.4 Primary and Secondary IDE Master/Slave

While entering Setup, BIOS auto-detects the presence of IDE devices. There is a separate sub-menu for each IDE device. Select a device item then press Enter to display the IDE device information.

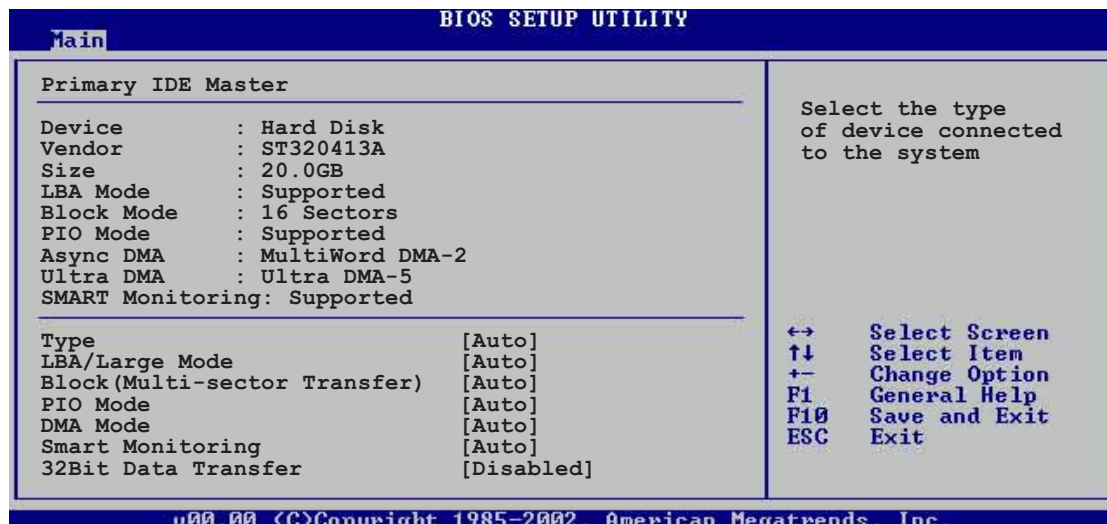

The values opposite the dimmed items (Device, Vendor, Size, LBA Mode, Block Mode, PIO Mode, Async DMA, Ultra DMA, and SMART monitoring) are auto-detected by BIOS and are not user-configurable. These items show N/A if no IDE device is installed in the system.

Type [Auto]

Selects the type of IDE drive. Setting to Auto allows automatic selection of the appropriate IDE device type. Select CDROM if you are specifically configuring a CD-ROM drive. Select ARMD (ATAPI Removable Media Device) if your device is either a ZIP, LS-120, or MO drive.

Configuration options: [Not Installed] [Auto] [CDROM] [ARMD]

LBA/Large Mode [Auto]

Enables or disables the LBA mode. Setting to Auto enables the LBA mode if the device supports this mode, and if the device was not previously formatted with LBA mode disabled. Configuration options: [Disabled] [Auto]

Block (Multi-sector Transfer) [Auto]

Enables or disables data multi-sectors transfers. When set to Auto, the data transfer from and to the device occurs multiple sectors at a time if the device supports multi-sector transfer feature. When set to Disabled, the data transfer from and to the device occurs one sector at a time.

Configuration options: [Disabled] [Auto]

PIO Mode [Auto]

Selects the PIO mode. Configuration options: [Auto] [0] [1] [2] [3] [4]

DMA Mode [Auto]

Selects the DMA mode. Configuration options: [Auto] [SWDMA0] [SWDMA1] [SWDMA2] [MWDMA0] [MWDMA1] [MWDMA2] [UDMA0] [UDMA1] [UDMA2] [UDMA3] [UDMA4] [UDMA5] [UDMA6]

SMART Monitoring [Auto]

Sets the Smart Monitoring, Analysis, and Reporting Technology. Configuration options: [Auto] [Disabled] [Enabled]

32Bit Data Transfer [Disabled]

Enables or disables 32-bit data transfer. Configuration options: [Disabled] [Enabled]

2.3.5 OnChip SATA Controller [Raid Mode]

Allows you to disable or set the onchip Serial ATA controller mode. Set to [Native Mode] when using generic IDE devices or [Raid Mode] to enable the RAID function. Configuration options: [Disabled] [Native Mode] [Raid Mode]

2.3.6 System Information

This menu gives you an overview of the general system specifications. The items in this menu are auto-detected by BIOS.

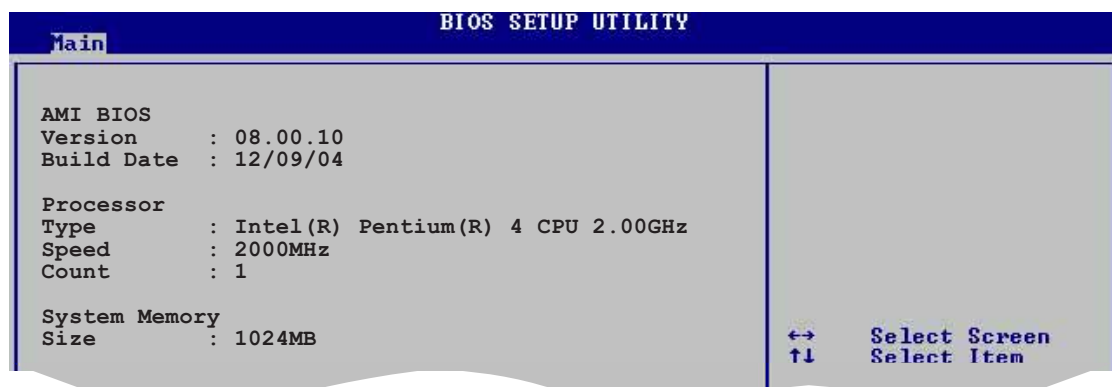

AMI BIOS

This item displays the auto-detected BIOS information.

Processor

This item displays the auto-detected CPU specification.

System Memory

This item displays the auto-detected system memory.

2.4 Advanced menu

The Advanced menu items allow you to change the settings for the CPU and other system devices.



Take caution when changing the settings of the Advanced menu items. Incorrect field values may cause the system to malfunction.

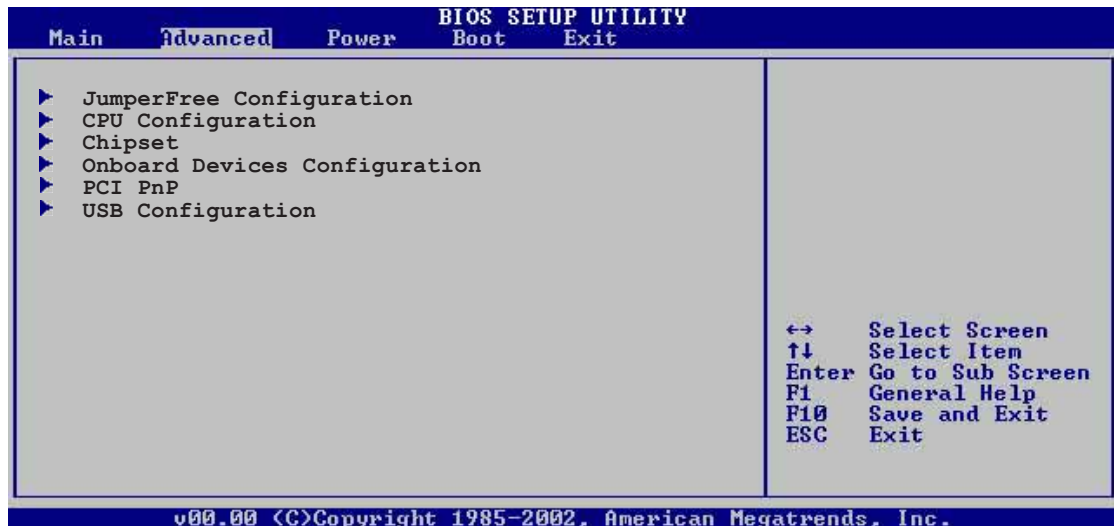

2.4.1 JumperFree Configuration

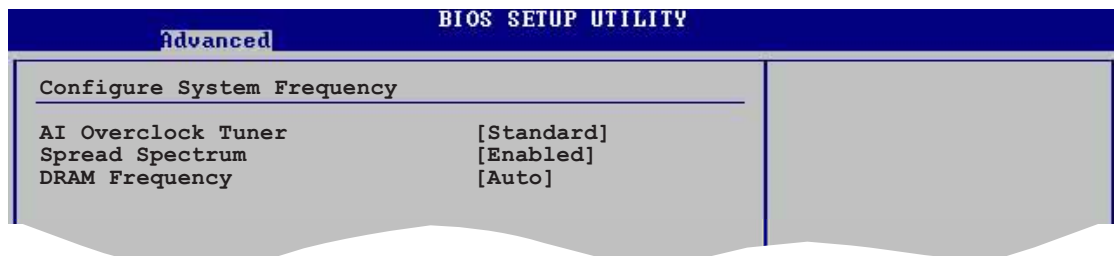

AI Overclock Tuner [Standard]

Allows selection of CPU overclocking options to achieve desired CPU internal frequency. Select either one of the preset overclocking options.

Configuration options: [Manual] [Standard]



Selecting a very high CPU frequency may cause the system to become unstable! If this happens, revert to the default setting.



If you are using an unlocked CPU, the item **CPU Ratio** appears under the AI Overclock Tuner item. You may select your desired ratio from the available options.

CPU Frequency (Value auto-detected)

Indicates the frequency sent by the clock generator to the system bus and PCI bus. The bus frequency (external frequency) multiplied by the bus multiple equals the CPU speed. The value of this item is auto-detected by BIOS and ranges from 100 to 400.

FSB/CPU External Frequency Synchronization

Front Side Bus	CPU External Frequency
FSB800	200 MHz
FSB533	133 MHz



The **CPU Frequency** item appears only when you set the **AI Overclocking Tuner** item to [Manual].

AGP/PCI Frequency [Auto]

Allows you to set the AGP/PCI operating frequency.

Configuration options: [Auto][66.6/33.3] [75.0/37.5] [85.7/42.8]

Spread Spectrum [Enabled]

Enables or disables the spread spectrum.

Configuration options: [Disabled] [Enabled]

DRAM Frequency [Auto]

Allows you to set the DDR operating frequency.

Configuration options: [266 MHz] [333 MHz] [400 MHz] [Auto]

2.4.2 CPU Configuration

The items in this menu show the CPU-related information auto-detected by BIOS.

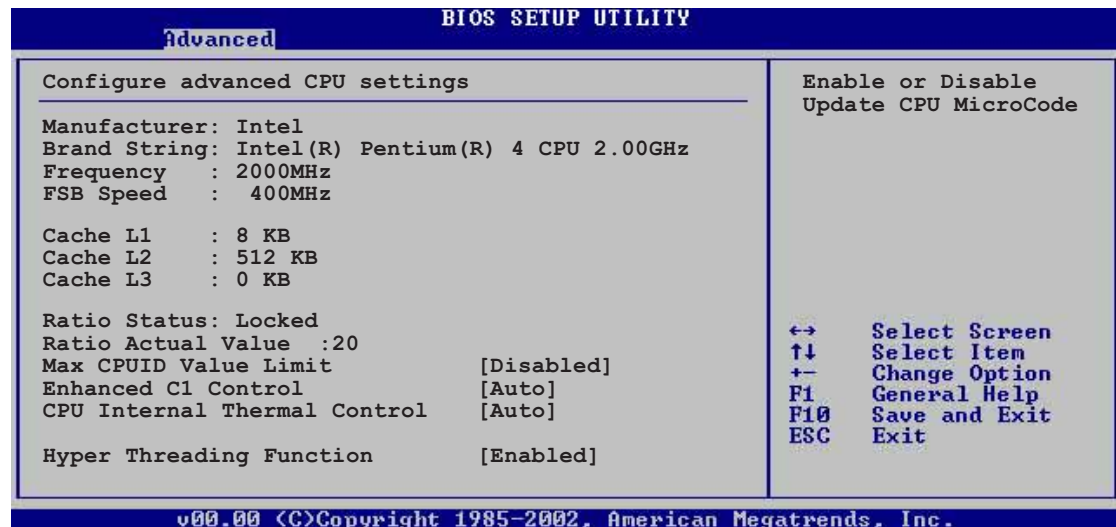

Max CPUID Value Limit [Disabled]

This item allows you to enable or disable the maximum CPUID value limit.

Configuration options: [Disabled] [Enabled]

Enhanced C1 Control [Auto]

When set to [Auto], the BIOS automatically checks the CPU's capability to enable the C1E support. In C1E mode, the CPU power consumption is lower when idle.

Configuration options: [Auto] [Disabled]

CPU Internal Thermal Control [Auto]

This item allows you to disable or set to auto the CPU internal thermal control feature. Configuration options: [Auto] [Disabled]

Hyper-Threading Technology [Enabled]

Allows you to enable or disable the processor Hyper-Threading Technology. This item appears only when you installed a CPU with Hyper-Threading Technology feature.

Configuration options: [Disabled] [Enabled]

2.4.3 Chipset

The Chipset menu items allow you to change the advanced chipset settings. Select an item then press Enter to display the sub-menu.

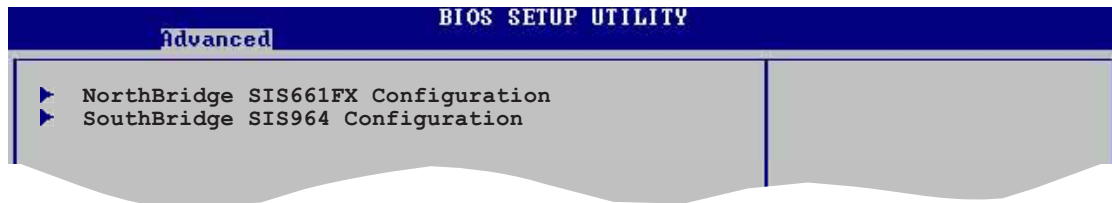

NorthBridge SiS661FX Configuration

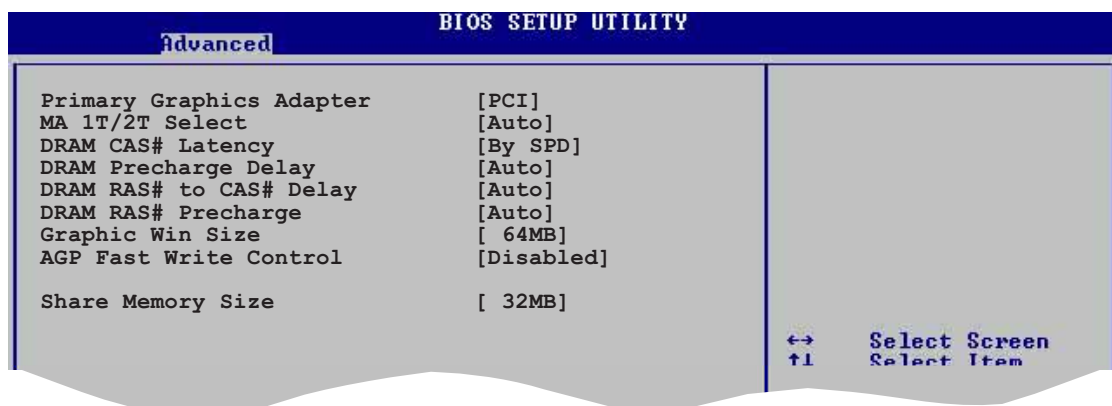

Primary Graphics Adapter [PCI]

Allows selection of the graphics controller to use as primary boot device.
Configuration options: [PCI] [AGP] [Onboard AGP]

MA 1T/2T Select [Auto]

Allows you to set the Channel MA 1T or 2T setting.
Configuration options: [Auto] [MA 2T] [MA 1T]

DRAM CAS# Latency [By SPD]

Controls the latency between the SDRAM read command and the time the data actually becomes available. Configuration options: [By SPD] [2T] [2.5T] [3T]

DRAM Precharge Delay [Auto]

Sets the DRAM Precharge Delay. Configuration options: [Auto] [6T] [7T] [5T] [4T] [8T] [9T]

DRAM RAS# to CAS# Delay [Auto]

Controls the latency between the DDR SDRAM active command and the read/write command. Configuration options: [Auto] [3T] [2T] [4T] [5T]

DRAM RAS# Precharge [Auto]

Controls the idle clocks after issuing a precharge command to the DDR SDRAM. Configuration options: [Auto] [3T] [2T] [4T] [5T]

Graphics Win Size [64MB]

Allows you to select the size of mapped memory for AGP graphic data. Configuration options: [32MB] [64MB] [128MB]

AGP Fast Write Control [Disabled]

Enables or disables the AGP Fast Write Control feature. Configuration options: [Disabled] [Enabled]

Share Memory Size [32MB]

Sets the share memory size. Configuration options: [16MB] [32MB] [64MB] [128MB] [Disabled]

SouthBridge SiS964 Configuration

BIOS SETUP UTILITY	
Advanced	
Onboard AC97 Audio Device	[Enabled]
Onboard SiS900 LAN Device	[Enabled]
Onboard LAN Boot ROM	[Disabled]

Onboard AC97 Audio Device [Enabled]

This item enables or disables the onboard AC'97 audio CODEC device. Configuration options: [Disabled] [Enabled]

OnBoard SiS900 LAN Device [Enabled]

Allows you to enable or disable the onboard LAN controller. Configuration options: [Disabled] [Enabled]

OnBoard LAN Boot ROM [Disabled]

Allows you to enable or disable the option ROM in the onboard LAN controller. This item appears only when the Onboard LAN item is set to Enabled. Configuration options: [Disabled] [Enabled]

2.4.4 Onboard Devices Configuration

Advanced		BIOS SETUP UTILITY
Configure onboard device		Enable or Disable Update CPU MicroCode
Serial Port1 Address	[3F8/IRQ4]	
Parallel Port Address	[378]	
Parallel Port Mode	[ECP]	
ECP Mode DMA Channel	[DMA3]	
Parallel Port IRQ	[IRQ7]	
Onboard Game/MIDI Port	[Disabled]	

Serial Port1 Address [3F8/IRQ4]

Allows you to select the Serial Port1 base address.

Configuration options: [Disabled] [3F8/IRQ4] [2F8/IRQ3] [3E8/IRQ4] [2E8/IRQ3]

Parallel Port Address [378]

Allows you to select the Parallel Port base addresses.

Configuration options: [Disabled] [378] [278] [3BC]

Parallel Port Mode [ECP]

Allows you to select the Parallel Port mode. When the item **Parallel Port Address** is set to **3BC**, the Parallel Port Mode options are only Normal, Bi-directional, and ECP. Configuration options: [Normal] [Bi-directional] [EPP] [ECP]

EPP Version [1.9]

Allows selection of the Parallel Port EPP version. This item appears only when the **Parallel Port Mode** is set to **EPP**. Configuration options: [1.9] [1.7]

ECP Mode DMA Channel [DMA3]

Allows selection of the Parallel Port ECP DMA channel.

Configuration options: [DMA0] [DMA1] [DMA3]

Parallel Port IRQ [IRQ7]

Allows you to select the Parallel Port IRQ. Configuration options: [IRQ5] [IRQ7]

Onboard Game/MIDI Port [Disabled]

Allows you to select the Game Port address or to disable the port.

Configuration options: [Disabled] [200/300] [200/330] [208/300] [208/330]

2.4.5 PCI PnP

The PCI PnP menu items allow you to change the advanced settings for PCI/PnP devices. The menu includes setting IRQ and DMA channel resources for either PCI/PnP or legacy ISA devices, and setting the memory size block for legacy ISA devices.



Take caution when changing the settings of the PCI PnP menu items. Incorrect field values may cause the system to malfunction.



Plug and Play O/S [No]

When set to [No], BIOS configures all the devices in the system. When set to [Yes] and if you installed a Plug & Play operating system, the operating system configures the Plug & Play devices not required for boot.

Configuration options: [No] [Yes]

PCI Latency Timer [64]

Allows you to select the value in units of PCI clocks for the PCI device latency timer register. Configuration options: [32] [64] [96] [128] [160] [192] [224] [248]

Allocate IRQ to PCI VGA [Yes]

When set to [Yes], BIOS assigns an IRQ to PCI VGA card if the card requests for an IRQ. When set to [No], BIOS does not assign an IRQ to the PCI VGA card even if requested. Configuration options: [No] [Yes]

Palette Snooping [Disabled]

When set to [Enabled], the palette snooping feature informs the PCI devices that an ISA graphics device is installed in the system so that the latter can function correctly. Setting to [Disabled] deactivates this feature.

Configuration options: [Disabled] [Enabled]

2.4.6 USB Configuration

The items in this menu allows you to change the USB-related features. Select an item then press Enter to display the configuration options.

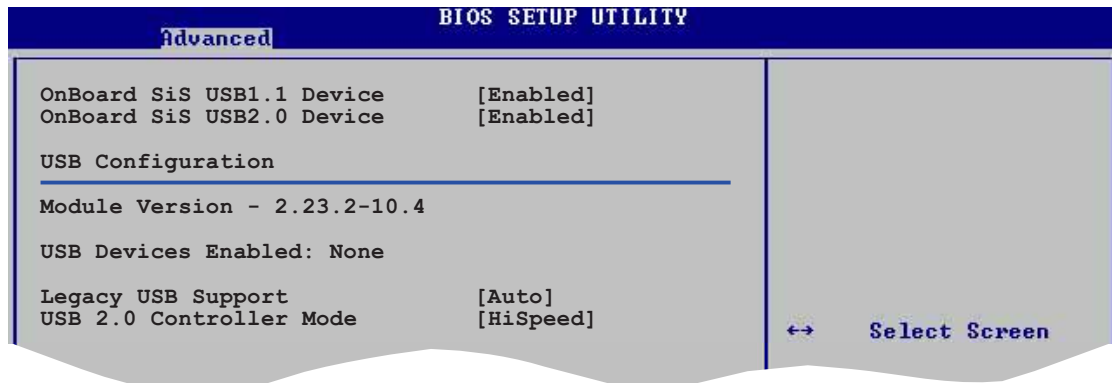

OnBoard SiS USB 1.1 Device [Enabled]

Allows you to enable or disable the onboard SiS USB 1.1 device.
Configuration options: [Disabled] [Enabled]

OnBoard SiS USB 2.0 Device [Enabled]

Allows you to enable or disable the onboard SiS USB 2.0 device.
Configuration options: [Disabled] [Enabled]



- The Module Version and USB Devices Enabled items show the auto-detected values. If no USB device is detected, the item shows None.
- Set this item to Disable when using Windows® 98SE or Windows® ME OS.

Legacy USB Support [Auto]

Allows you to enable or disable support for legacy USB devices. Setting to Auto allows the system to detect the presence of USB devices at startup. If detected, the USB controller legacy mode is enabled. If no USB device is detected, the legacy USB support is disabled. Configuration options: [Disabled] [Enabled] [Auto]

USB 2.0 Controller Mode [HiSpeed]

Allows you to configure the USB 2.0 controller in HiSpeed (480 Mbps) or Full Speed (12 Mbps). Configuration options: [HiSpeed] [Full Speed]

2.5 Power menu

The Power menu items allow you to change the settings for the Advanced Power Management (APM). Select an item then press Enter to display the configuration options.



2.5.1 Suspend Mode [Auto]

Allows you to select the ACPI state to be used for system suspend.

Configuration options: [S1 (POS) Only] [S3 Only] [Auto]

2.5.2 ACPI 2.0 Support [No]

Allows you to add more tables for ACPI 2.0 specifications.

Configuration options: [No] [Yes]

2.5.3 ACPI APIC Support [Enabled]

Allows you to enable or disable the ACPI (Advanced Configuration and Power Interface) support in the ASIC (Application Specific Integrated Circuit). When set to Enabled, the ACPI APIC table pointer is included in the RSDT pointer list.

Configuration options: [Disabled] [Enabled]

2.5.4 APM Configuration

BIOS SETUP UTILITY	
Power	
Power Button Mode	[On/Off]
Restore on AC Power Loss	[Always OFF]
Power On By PS2 Keyboard	[Disabled]
Power On By PS2 Mouse	[Disabled]
Power On By Internal MAC LAN	[Disabled]
Power On By PCI Devices	[Disabled]
Power On By External Modems	[Disabled]
Power On By RTC Alarm	[Disabled]

Power Button Mode [On/Off]

Allows the system to go into On/Off mode or suspend mode when the power button is pressed. Configuration options: [On/Off] [Suspend]

Restore on AC Power Loss [Always OFF]

When set to Power Off, the system goes into off state after an AC power loss. When set to Power On, the system goes on after an AC power loss. When set to Last State, the system goes into either off or on state whatever was the system state before the AC power loss. Configuration options: [Always Off] [Always On] [Keep Previous State]

Power On By PS/2 Keyboard [Disabled]

This parameter allows you to use specific keys on the keyboard to turn on the system. This feature requires an ATX power supply that provides at least 1A on the +5VSB lead. Configuration options: [Disabled] [Space Bar] [Ctrl-Esc] [Power key]

Power On By PS/2 Mouse [Disabled]

When set to [Enabled], this parameter allows you to use the PS/2 mouse to turn on the system. This feature requires an ATX power supply that provides at least 1A on the +5VSB lead. Configuration options: [Disabled] [Enabled]



If the **Power On By PS/2 Keyboard** is enabled, the **Power On by PS/2 Mouse** function is disabled.

Power On By Internal MAC LAN [Disabled]

When set to [Enabled], this parameter allows you to turn on the system through the internal MAC LAN. This feature requires an ATX power supply that provides at least 1A on the +5VSB lead. Configuration options: [Disabled] [Enabled]

Power On By PCI Devices [Disabled]

When set to [Enabled], this parameter allows you to turn on the system through a PCI LAN or modem card. This feature requires an ATX power supply that provides at least 1A on the +5VSB lead. Configuration options: [Disabled] [Enabled]

Power On By External Modem [Disabled]

This allows either settings of [Enabled] or [Disabled] for powering up the computer when the external modem receives a call while the computer is in Soft-off mode.

Configuration options: [Disabled] [Enabled]



The computer cannot receive or transmit data until the computer and applications are fully running. Thus, connection cannot be made on the first try. Turning an external modem off and then back on while the computer is off causes an initialization string that turns the system power on.

Power On By RTC Alarm [Disabled]

Allows you to enable or disable RTC to generate a wake event. When this item is set to Enabled, the items RTC Alarm Date, RTC Alarm Hour, RTC Alarm Minute, and RTC Alarm Second appear with set values.

Configuration options: [Disabled] [Enabled]

2.5.5 Hardware Monitor

BIOS SETUP UTILITY	
Power	
Hardware Monitor	CPU Temperature
CPU Temperature	[65.5°C/148°F]
MB Temperature	[36°C/96.5°F]
CPU Fan Speed	[3260RPM]
Chassis Fan Speed	[N/A]
VCORE Voltage	[1.504V]
3.3V Voltage	[3.360V]
5V Voltage	[5.160V]
12V Voltage	[11.328V]
	↔ Select Screen
	↑↓ Select Item

CPU Temperature [xxx°C/xxx°F]

MB Temperature [xxx°C/xxx°F]

The onboard hardware monitor automatically detects and displays the motherboard and CPU temperatures. Select [Ignored] if you do not wish to display the detected temperatures.

CPU Fan Speed [xxxxRPM] or [N/A]

Chassis Fan Speed [xxxxRPM] or [N/A]

The onboard hardware monitor automatically detects and displays the CPU and chassis fan speeds in rotations per minute (RPM). If any of the fans is not connected to the motherboard, the specific field shows N/A.

VCORE Voltage, +3.3V Voltage, +5V Voltage, +12V Voltage

The onboard hardware monitor automatically detects the voltage output through the onboard voltage regulators.

2.6 Boot menu

The Boot menu items allow you to change the system boot options. Select an item then press <Enter> to display the sub-menu.

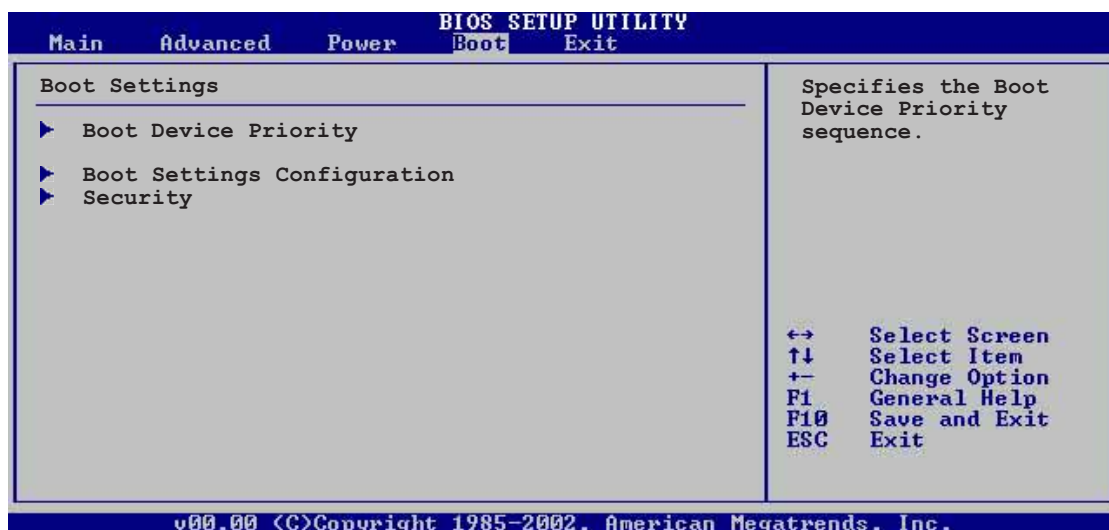

2.6.1 Boot Device Priority

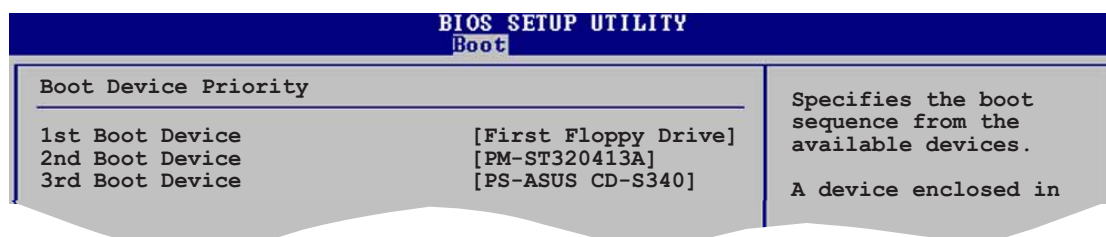

1st ~ xxth Boot Device [1st Floppy Drive]

These items specify the boot device priority sequence from the available devices. The number of device items that appear on the screen depends on the the number of devices installed in the system. Configuration options: [xxxxx Drive] [Disabled]

2.6.2 Removable Drives



This item appears only when there are removable drives (like a USB flash disk) plugged in the system.

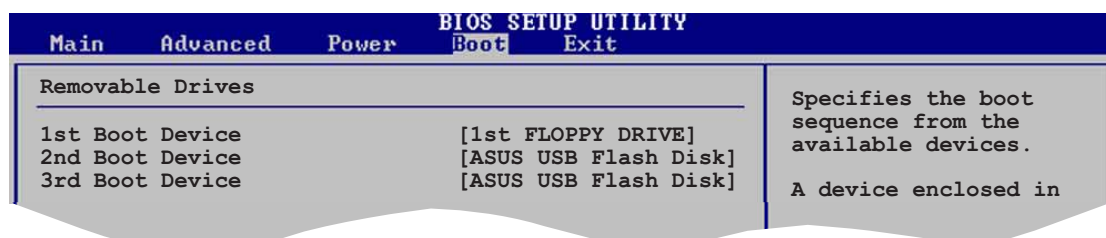

1st ~ xxth Boot Device [1st Floppy Drive]

These items specify the removable boot device priority sequence from the available removable boot devices. Configuration options: [xxxxx Drive] [Disabled]

2.6.3 Boot Settings Configuration

BIOS SETUP UTILITY	
Boot	
Boot Settings Configuration	
Quick Boot	[Enabled]
Full Screen Logo	[Enabled]
Add On ROM Display Mode	[Force BIOS]
Bootup Num-Lock	[On]
PS/2 Mouse Support	[Auto]
Wait for 'F1' If Error	[Enabled]
Hit 'DEL' Message Display	[Enabled]
Interrupt 19 Capture	[Disabled]

Allows BIOS to skip certain tests while booting. This will decrease the time needed to boot the system.

Quick Boot [Enabled]

Enabling this item allows BIOS to skip some power on self tests (POST) while booting to decrease the time needed to boot the system. When set to [Disabled], BIOS performs all the POST items. Configuration options: [Disabled] [Enabled]

Full Screen Logo [Enabled]

This allows you to enable or disable the full screen logo display feature. Configuration options: [Disabled] [Enabled]



Make sure that the **Full Screen Logo** item is set to [Enabled] if you wish to use the ASUS MyLogo2™ feature.

Add On ROM Display Mode [Force BIOS]

Sets the display mode for option ROM. Configuration options: [Force BIOS] [Keep Current]

Bootup Num-Lock [On]

Allows you to select the power-on state for the NumLock. Configuration options: [Off] [On]

PS/2 Mouse Support [Auto]

Allows you to enable or disable support for PS/2 mouse. Configuration options: [Disabled] [Enabled] [Auto]

Wait for 'F1' If Error [Enabled]

When set to Enabled, the system waits for F1 key to be pressed when error occurs. Configuration options: [Disabled] [Enabled]

Hit 'DEL' Message Display [Enabled]

When set to Enabled, the system displays the message "Press DEL to run Setup" during POST. Configuration options: [Disabled] [Enabled]

Interrupt 19 Capture [Disabled]

When set to [Enabled], this function allows the option ROMs to trap Interrupt 19. Configuration options: [Disabled] [Enabled]

2.6.4 Security

The Security menu items allow you to change the system security settings. Select an item then press Enter to display the configuration options.

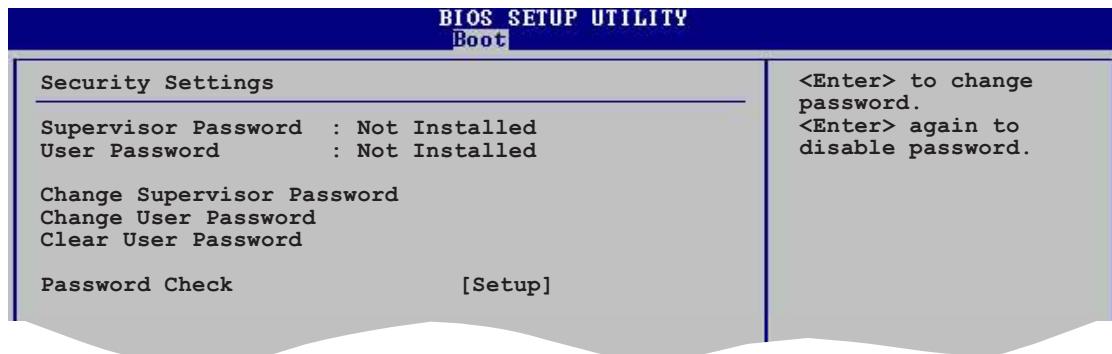

Change Supervisor Password

Select this item to set or change the supervisor password. The Supervisor Password item on top of the screen shows the default **Not Installed**. After you have set a password, this item shows **Installed**.

To set a Supervisor Password:

1. Select the Change Supervisor Password item and press <Enter>.
2. On the password box that appears, type a password composed of letters and/or numbers, then press <Enter>. The password supports only a maximum of 6 characters.
3. Confirm the password when prompted.
The message "Password Installed" appears after you have successfully set your password.

The Supervisor Password item now shows **Installed**.

To change the supervisor password, follow the same steps as in setting a user password.

To clear the supervisor password, select the Change Supervisor Password then press <Enter>. The message "Password Uninstalled" appears.

After you have set a supervisor password, the other items appear to allow you to change other security settings.

User Access Level (Full Access]

This item allows you to select the access restriction to the Setup items. Configuration options: [No Access] [View Only] [Limited] [Full Access]

No Access prevents user access to the Setup utility.

View Only allows access but does not allow change to any field.

Limited allows change to only selected fields, such as Date and Time.

Full Access allows viewing and changing all the fields in the Setup utility.

Change User Password

Select this item to set or change the user password. The User Password item on top of the screen shows the default **Not Installed**. After you have set a password, this item shows **Installed**.

To set a User Password:

1. Select the Change User Password item and press <Enter>.
2. On the password box that appears, type a password composed of letters and/or numbers, then press <Enter>. Your password should have at least six characters.
3. Confirm the password when prompted.
The message "Password Installed" appears after you have successfully set your password.

The User Password item now shows **Installed**.

To change the user password, follow the same steps as in setting a user password.

Clear User Password

Select this item if you wish to clear the user password.

Password Check [Setup]

When set to [Setup], BIOS checks for user password when accessing the Setup utility. When set to [Always], BIOS checks for user password both when accessing Setup and booting the system. Configuration options: [Setup] [Always]

2.7 Exit menu

The Exit menu items allow you to load the optimal or failsafe default values for the BIOS items, and save or discard your changes to the BIOS items.

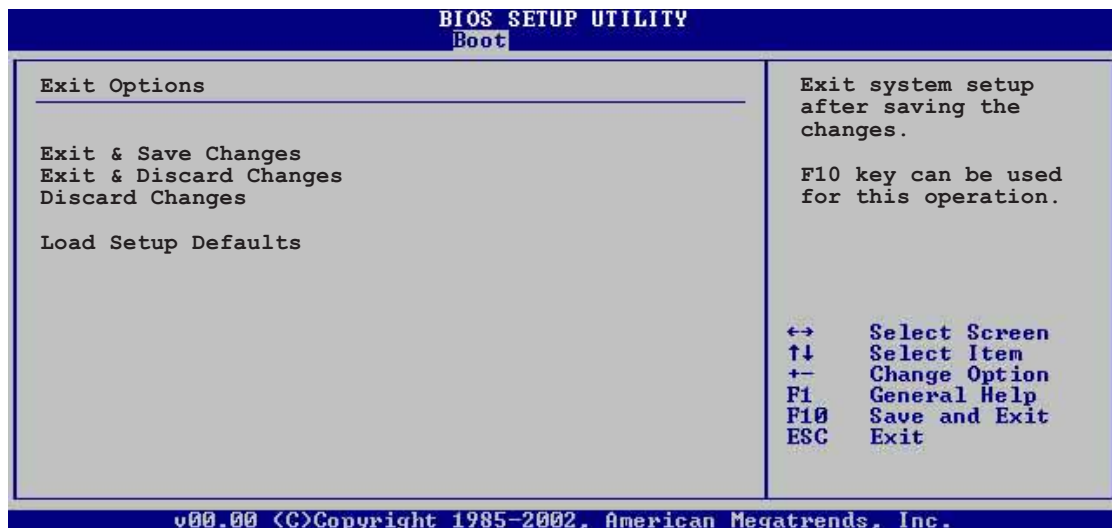

Pressing <Esc> does not immediately exit this menu. Select one of the options from this menu or <F10> from the legend bar to exit.

Exit & Save Changes

Once you are finished making your selections, choose this option from the Exit menu to ensure the values you selected are saved to the CMOS RAM. The CMOS RAM is sustained by an onboard backup battery and stays on even when the PC is turned off. When you select this option, a confirmation window appears. Select [Ok] to save changes and exit.



If you attempt to exit the Setup program without saving your changes, the program prompts you with a message asking if you want to save your changes before exiting. Pressing <Enter> saves the changes while exiting.

Exit & Discard Changes

Select this option only if you do not want to save the changes that you made to the Setup program. If you made changes to fields other than system date, system time, and password, the BIOS asks for a confirmation before exiting.

Discard Changes

This option allows you to discard the selections you made and restore the previously saved values. After selecting this option, a confirmation appears. Select [Ok] to discard any changes and load the previously saved values.

Load Setup Defaults

This option allows you to load the default values for each of the parameters on the Setup menus. When you select this option or if you press <F5>, a confirmation window appears. Select [Ok] to load default values. Select **Exit & Save Changes** or make other changes before saving the values to the non-volatile RAM.

Chapter 3

This chapter describes the contents of the support CD that comes with the motherboard package.

Software support

3.1 Install an operating system®

This motherboard supports Windows® 98SE/ME/2000/XP operating system (OS). Always install the latest OS version and corresponding updates so you can maximize the features of your hardware.



Because motherboard settings and hardware options vary, use the setup procedures presented in this chapter for general reference only. Refer to your OS documentation for more information.

3.2 Support CD information

The support CD that came with the motherboard contains useful software and several utility drivers that enhance the motherboard features.



The contents of the support CD are subject to change at any time without notice. Visit the ASUS website for updates.

3.2.1 Running the support CD

To begin using the support CD, simply insert the CD into your CD-ROM drive. The CD automatically displays the **Drivers** menu if Autorun is enabled in your computer. Click on an item to install.

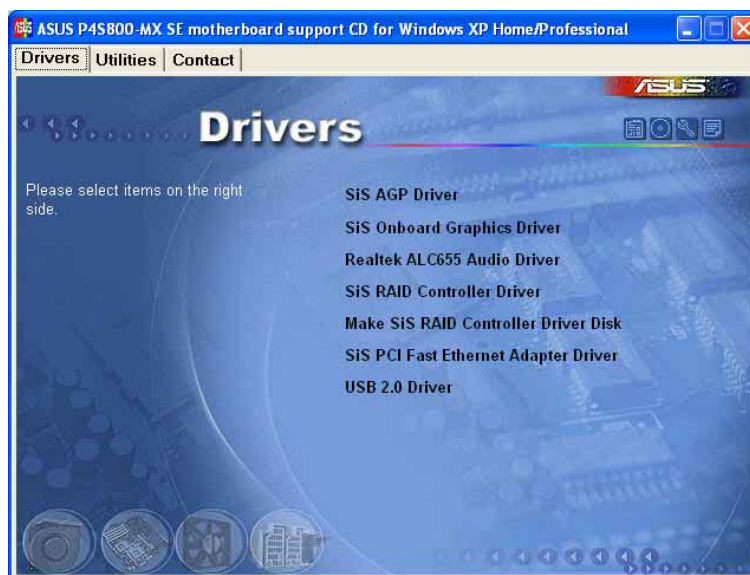

If **Autorun** is NOT enabled in your computer, browse the contents of the support CD to locate the file **ASSETUP.EXE** from the **BIN** folder. Double-click the **ASSETUP.EXE** to run the CD.

3.2.2 Drivers menu

The drivers menu shows the available device drivers if the system detects installed devices. Install the necessary drivers to activate the devices.

SiS AGP driver

Installs SiS AGP display driver.

Onboard graphics driver

Installs SiS graphics driver for the onboard graphics controller.



Uninstall the SIS onboard VGA driver when installing a PCI VGA card.

Realtek ALC655 Audio Driver

Installs the Realtek® ALC655 audio driver and application.

SIS RAID Controller Driver

Installs the SIS RAID driver.

Make SIS RAID Controller Driver Disk

Creates a SIS RAID driver disk.

SiS PCI Fast Ethernet Adapter Driver

Installs the driver for the onboard SiS PCI LAN controller.

USB 2.0 Driver

Installs the Universal Serial Bus 2.0 (USB 2.0) driver.

3.2.3 Utilities menu

The Utilities menu shows the applications and other software that the motherboard supports.

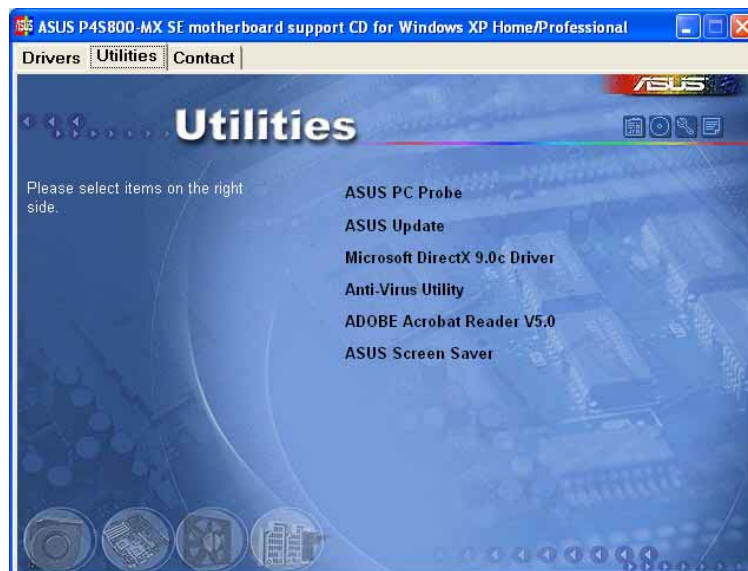

ASUS PC Probe

This smart utility monitors the fan speed, CPU temperature, and system voltages, and alerts you on any detected problems. This utility helps you keep your computer at a healthy operating condition.

ASUS Update

This program allows you to download the latest version of the BIOS from the ASUS website. Before using the ASUS Update, make sure that you have an Internet connection so you can connect to the ASUS website.

Microsoft® DirectX

Installs the Microsoft® DirectX driver.

Anti-virus utility

The anti-virus application detects and protects your computer from viruses that destroys data.

Adobe Acrobat Reader

Installs the Adobe Acrobat Reader V5.0. The Acrobat Reader software is for viewing files saved in Portable Document Format (PDF).

ASUS Screen Saver

Bring life to your computer screen by installing the ASUS screen saver.

3.2.4 ASUS contact information

Click the Contact tab to display the ASUS contact information.



Screen display and utilities option may not be the same for other operating system version.

3.3 RAID configurations

The SIS 964 southbridge comes with a RAID controller that allows you to configure Serial ATA hard disk drives as RAID sets. The motherboard supports the following RAID configurations.

RAID 0 (*Data striping*) optimizes two identical hard disk drives to read and write data in parallel, interleaved stacks. Two hard disks perform the same work as a single drive but at a sustained data transfer rate, double that of a single disk alone, thus improving data access and storage. Use of two new identical hard disk drives is required for this setup.

RAID 1 (*Data mirroring*) copies and maintains an identical image of data from one drive to a second drive. If one drive fails, the disk array management software directs all applications to the surviving drive as it contains a complete copy of the data in the other drive. This RAID configuration provides data protection and increases fault tolerance to the entire system. Use two new drives or use an existing drive and a new drive for this setup. The new drive must be of the same size or larger than the existing drive.

JBOD (*Spanning*) stands for **Just a Bunch of Disks** and refers to hard disk drives that are not yet configured as a RAID set. This configuration stores the same data redundantly on multiple disks that appear as a single disk on the operating system. Spanning does not deliver any advantage over using separate disks independently and does not provide fault tolerance or other RAID performance benefits.



If you want to boot the system from a hard disk drive included in a RAID set, copy first the RAID driver from the support CD to a floppy disk before you install an operating system to a selected hard disk drive. Refer to section “3.4 Creating a RAID driver disk” for details.

3.3.1 Installing hard disks

The motherboard supports Serial ATA hard disk drives. For optimal performance, install identical drives of the same model and capacity when creating a disk array.

Installing Serial ATA (SATA) hard disks

To install the SATA hard disks for a RAID configuration:

1. Install the SATA hard disks into the drive bays.
2. Connect the SATA signal cables.
3. Connect a SATA power cable to the power connector on each drive.

3.3.2 SIS RAID configurations

The motherboard includes a high performance Serial ATA RAID controller integrated in the SIS 964 southbridge chipset. It supports RAID 0 and RAID 1 with two independent Serial ATA channels.

Entering the SIS RAID BIOS utility

1. Boot your computer.
2. During POST, press <Ctrl> + <S> to enter the SIS RAID configuration utility. The following menu options appear.

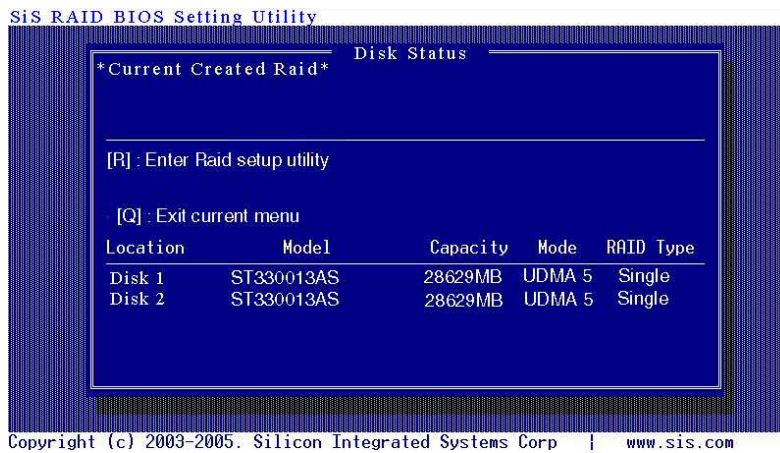

3. Press <R> to display the RAID setup menu.

Create an Array

1. From the SIS RAID BIOS utility main menu, press <A> to create an array.

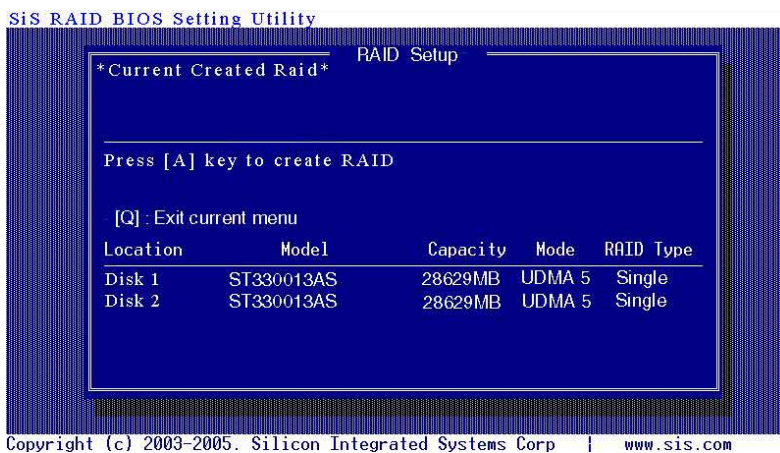

Creating JBOD

1. From the RAID Setup, press <1> then <Enter> to select JBOD (Spanning)

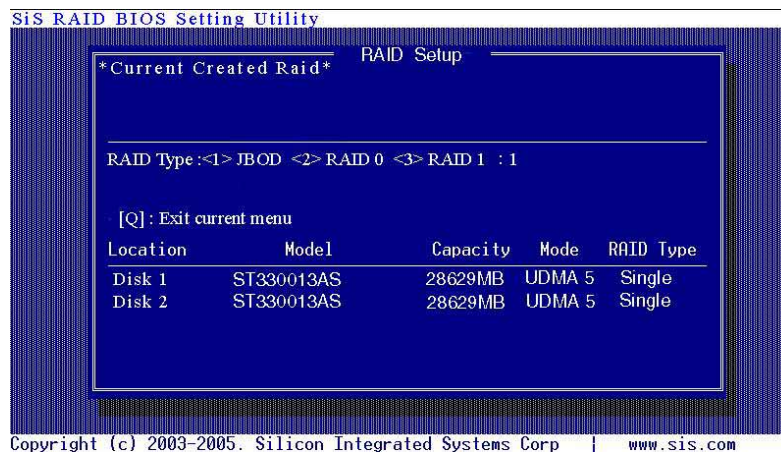

2. Select <1> to auto-create a RAID array or press <2> to manually configure array then press <Enter>.

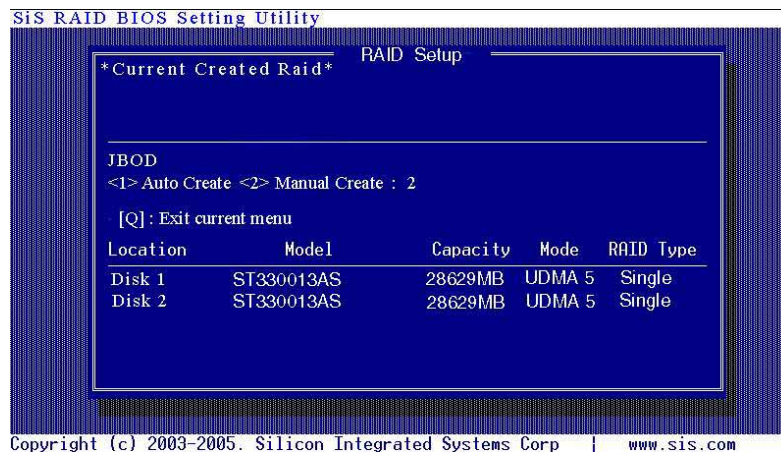

3. If you selected 1 proceed to step 5.
4. Use the **up/down** arrow keys to move the selection bar, then press <Enter> to select a disk drive.

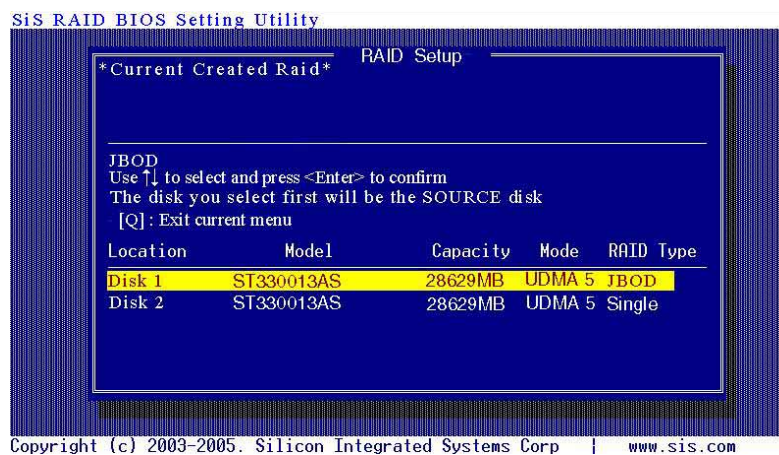

5. The current RAID set is displayed on the upper side of the screen.

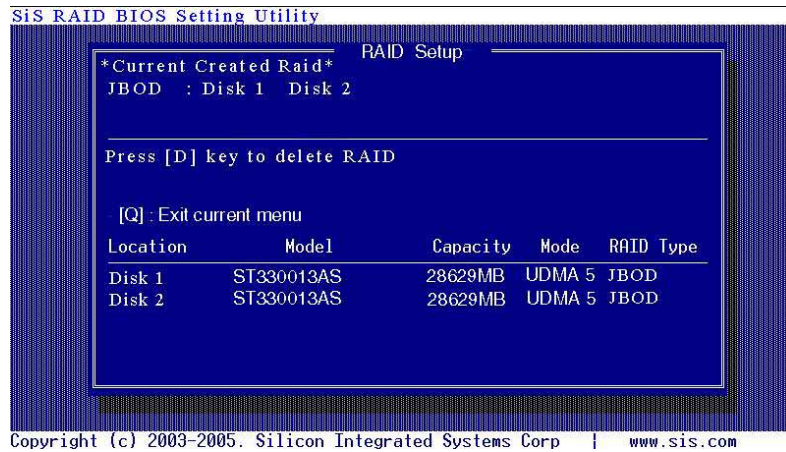

6. Press <Q> to exit the RAID setup.
7. Press <Y> then <Enter> to save changes.

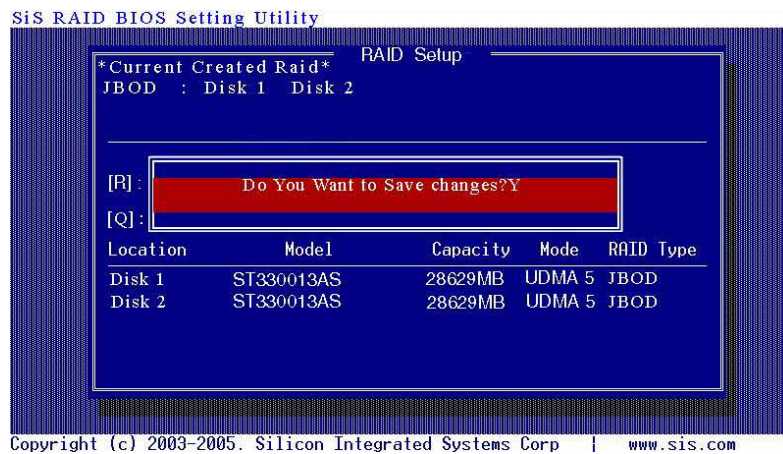

8. After the setup is complete, you can partition and format your hard disk as a single hard drive.

Creating RAID 0 for performance

1. From the RAID Setup, press **<2>** then **<Enter>** to select RAID 0 (Striping).

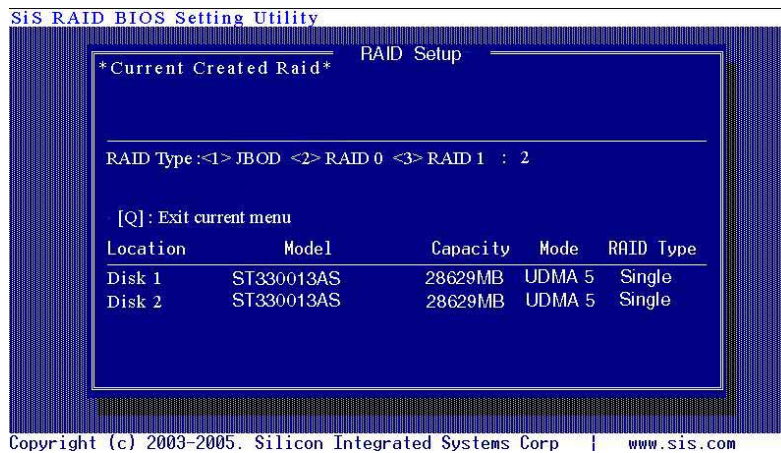

2. Select **<1>** to auto-create a RAID array or press **<2>** to manually configure array then press **<Enter>**.

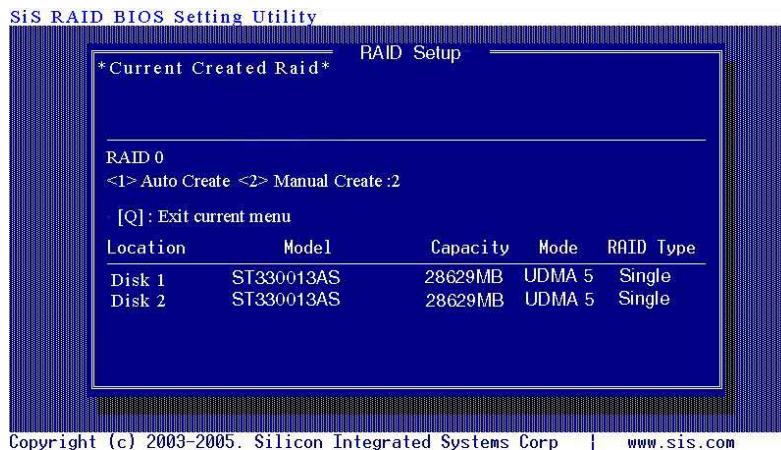

3. If you selected **1** proceed to step 7.
4. If you selected **2**, select the array block size by pressing the corresponding number beside the available block sizes then press **<Enter>**.

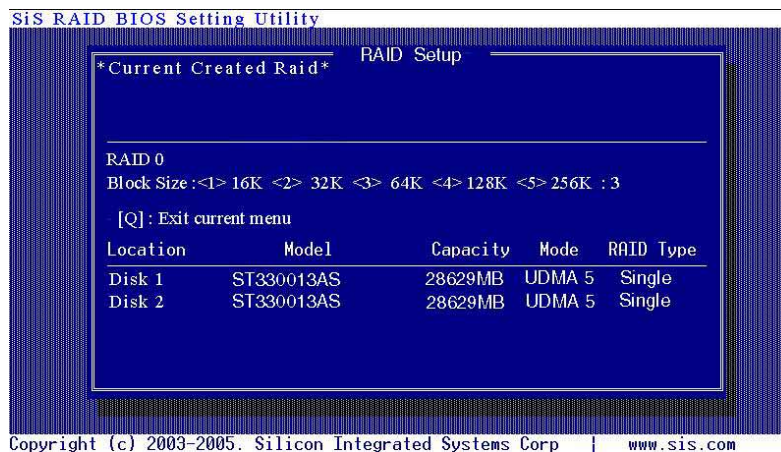

- Use the **up/down** arrow keys to move the selection bar, then press **<Enter>** to select a disk drive.

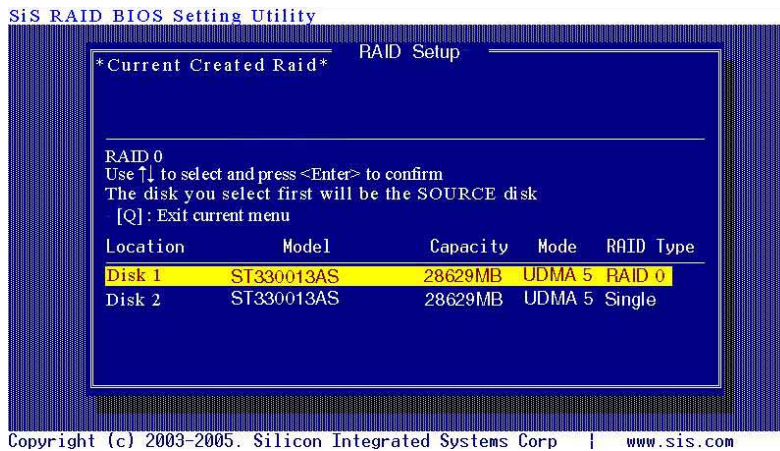

- After selecting the drives, press **<Q>** to return to previous menu.
- Press **<N>** then **<Enter>** to create a Stripe only configuration. Press **<Y>** if you wish to split the data on the source disk to other disks.

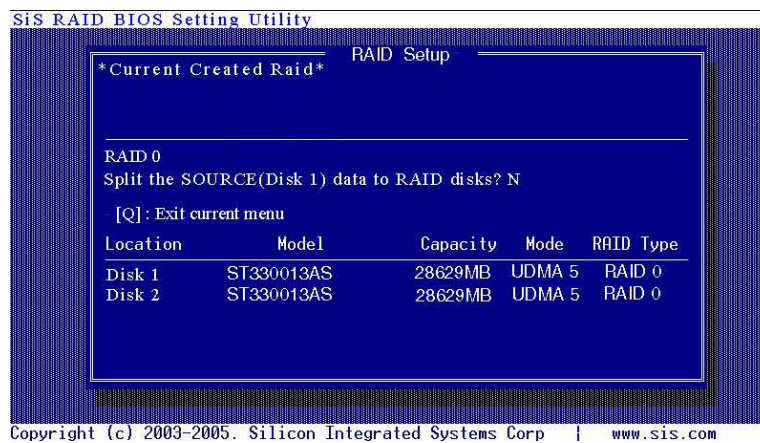

- If you selected Y, the following screen appears.

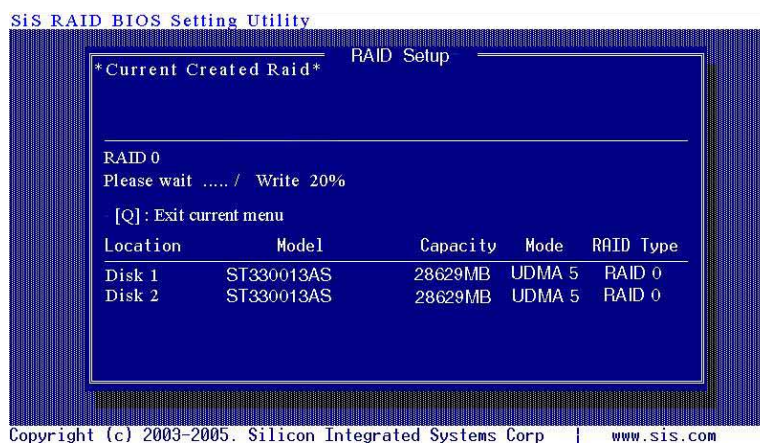

- When finished, press **<Q>** to return to previous menu.

10. The current RAID setup is displayed on the upper side of the screen. Press **<Q>** to exit the RAID setup menu.

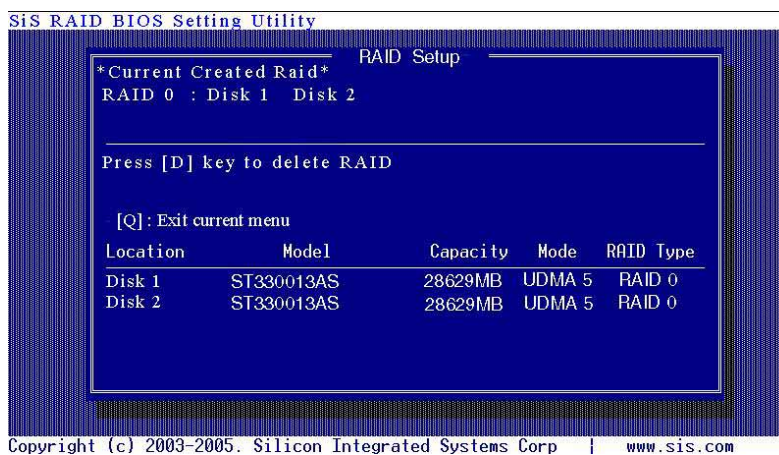

11. Press **<Y>** then **<Enter>** to save changes.

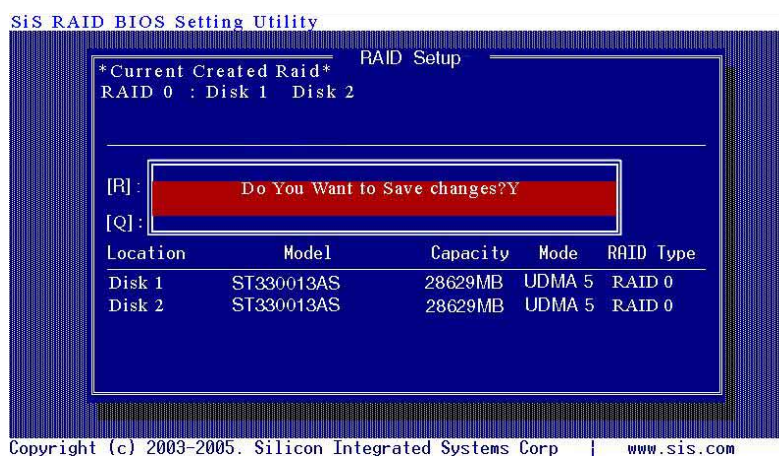

12. When finished, you can partition and format the array as a single hard drive.

Creating RAID 1 for capacity

1. From the RAID Setup, press <3> then <Enter> to select RAID 1 (Mirroring).

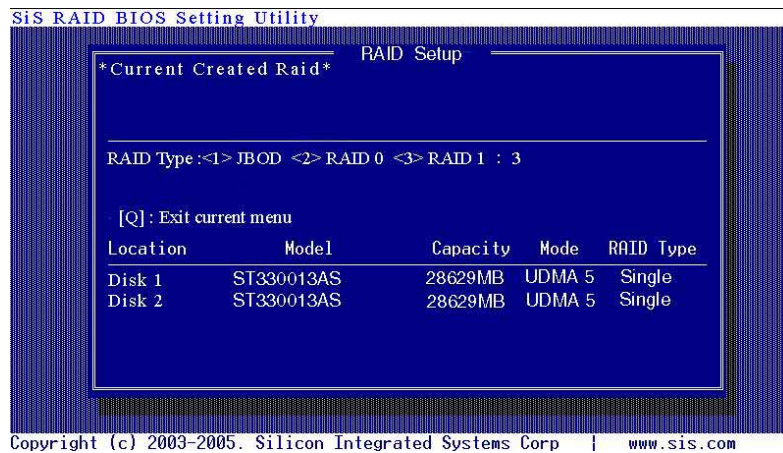

2. Select <1> to auto-create a RAID array or press <2> to manually configure array then press <Enter>.

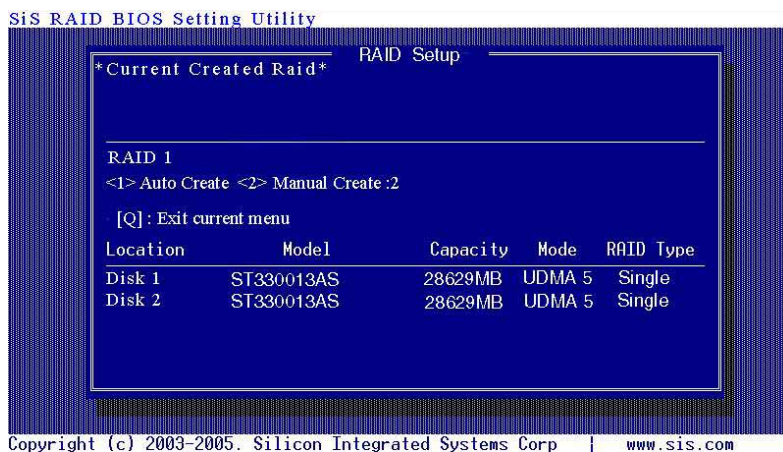

3. If you selected 1 proceed to step 5.
4. Use the **up/down** arrow keys to move the selection bar, then press <Enter> to select a disk drive.

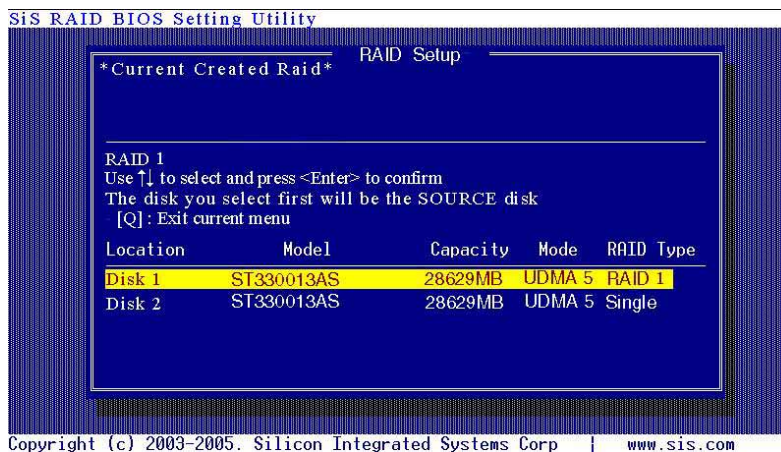

5. Press **<N>** then **<Enter>** to create a mirrored set. Press **<Y>** if you wish to duplicate the source disk (DISK 1) data to the RAID disks.

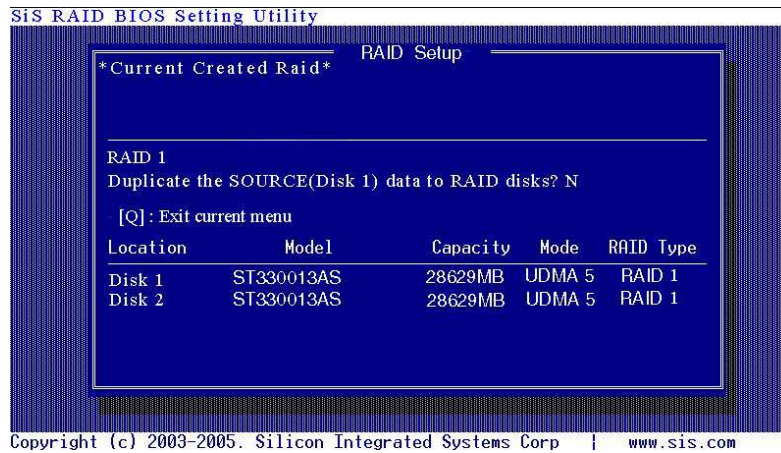

6. If you selected Y, the following screen appears.

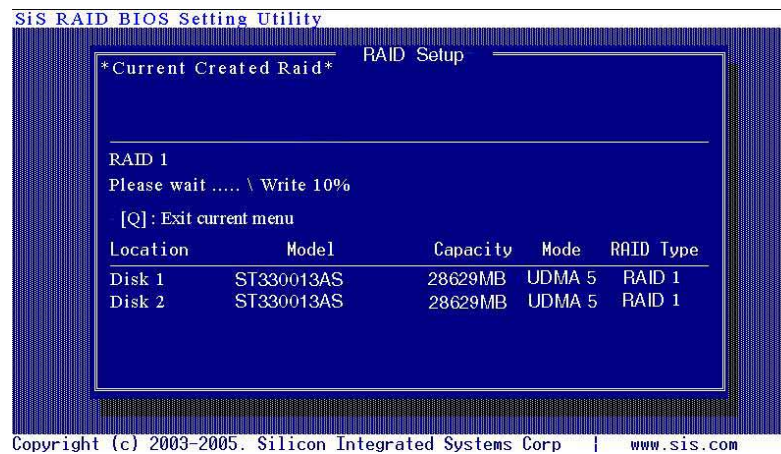

7. When finished, press **<Q>** to return to previous menu. The current RAID set is displayed on the upper side of the screen.

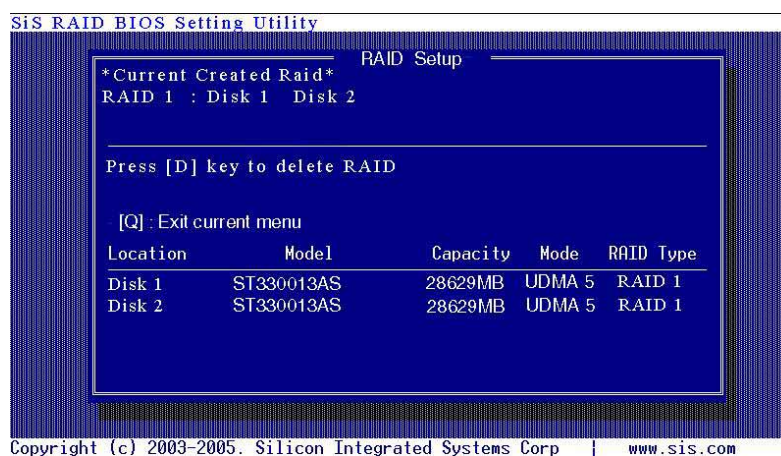

8. Press **<Q>** to exit the RAID setup.
9. Press **<Y>** then **<Enter>** to save changes.

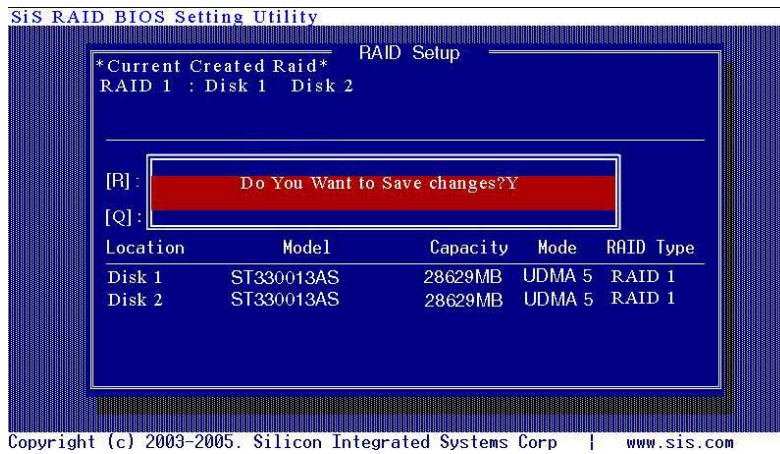

10. After the setup is complete, you can partition and format the array as a single hard drive.

3.4 Creating a RAID driver disk

A floppy disk with the RAID driver is required when installing Windows® 2000/XP operating system on a hard disk drive that is included in a RAID set. Use the support CD that came with the motherboard package to create a RAID driver disk.

To use the support CD:

1. Boot your computer and insert the support CD into the optical drive.
2. Make sure that the optical drive is the primary boot device. If not, set the optical drive as the primary boot device in the BIOS.
3. Press the any key when the prompts “Press any key to boot from the optical drive.”. The following menu appears:

```
1) Make SIS RAID Driver Disk
2) Format Floppy Disk
3) FreeDOS command prompt
Please choose 1 ~ 3: _
```

4. Press <1> to create a RAID driver disk.
5. Insert a formatted floppy disk into the floppy drive then press <Enter>.
6. Follow the succeeding screen instructions to complete the process.
7. Write-protect the floppy disk to avoid computer virus infection.

To install the RAID driver:

1. During the OS installation, the system prompts you to press the <F6> key to install third-party SCSI or RAID driver.
2. Press <F6> then insert the floppy disk with RAID driver into the floppy disk drive.
3. Follow the succeeding screen instructions to complete the installation.

