

# **SATA RAID Cards**

## **ARC-1110/1120/1130/1160/1170**

( 4/8/12/16/24-port PCI-X SATA RAID Controllers )

## **ARC-1110ML/1120ML/1130ML/1160ML**

( 4/8-port Infiniband connector and 12/16-port Multi-lane connector PCI-X SATA RAID Controllers )

## **ARC-1210/1220/1230/1260/1280**

( 4/8/12/16/24-port PCI-Express SATA RAID Controllers )

## **ARC-1231ML/1261ML/1280ML**

(12/16/24-port PCI-Express SATA RAID Controllers)

## **USER Manual**

Version: 3.3

Issue Date: November, 2006

## **Microsoft WHQL Windows Hardware Compatibility Test**

ARECA is committed to submitting products to the Microsoft Windows Hardware Quality Labs (WHQL), which is required for participation in the Windows Logo Program. Successful passage of the WHQL tests results in both the “Designed for Windows” logo for qualifying ARECA PCI-X and PCI-Express SATA RAID controllers and a listing on the Microsoft Hardware Compatibility List (HCL).

## **Copyright and Trademarks**

The information of the products in this manual is subject to change without prior notice and does not represent a commitment on the part of the vendor, who assumes no liability or responsibility for any errors that may appear in this manual. All brands and trademarks are the properties of their respective owners. This manual contains materials protected under International Copyright Conventions. All rights reserved. No part of this manual may be reproduced in any form or by any means, electronic or mechanical, including photocopying, without the written permission of the manufacturer and the author. All inquiries should be addressed to ARECA Technology Corp.

## **FCC STATEMENT**

This equipment has been tested and found to comply with the limits for a Class B digital device, pursuant to part 15 of the FCC Rules. These limits are designed to provide reasonable protection against interference in a residential installation. This equipment generates, uses, and can radiate radio frequency energy and, if not installed and used in accordance with the instructions, may cause harmful interference to radio communications. However, there is no guarantee that interference will not occur in a particular installation.

# Contents

<b>1. Introduction .....</b>	<b>10</b>
1.1 Overview .....	10
1.2 Features .....	12
1.3 RAID Concept.....	15
1.3.1 RAID Set.....	15
1.3.2 Volume Set.....	15
1.3.3 Ease of Use Features .....	16
1.3.3.1 Foreground Availability/Background Initialization.....	16
1.3.3.2 Array Roaming .....	16
1.3.3.3 Online Capacity Expansion .....	17
1.3.3.4 Online RAID Level and Stripe Size Migration .....	19
1.3.3.5 Online Volume Expansion.....	19
1.4 High availability .....	20
1.4.1 Global Hot Spares .....	20
1.4.2 Hot-Swap Disk Drive Support.....	21
1.4.3 Auto Declare Hot-Spare .....	21
1.4.4 Auto Rebuilding .....	21
1.4.5 Adjustable Rebuild Priority.....	22
1.5.1 Hard Drive Failure Prediction.....	23
1.5.2 Auto Reassign Sector.....	23
1.5.3 Consistency Check.....	24
1.6 Data Protection.....	24
1.6.1 BATTERY BACKUP .....	24
1.6.2 RECOVERY ROM .....	25
1.7 Understanding RAID .....	25
1.7.1 RAID 0.....	25
1.7.2 RAID 1.....	26
1.7.3 RAID 1E.....	27
1.7.4 RAID 3.....	27
1.7.5 RAID 5.....	28
1.7.6 RAID 6.....	29
<b>2. Hardware Installation .....</b>	<b>32</b>
2.1 Before Your begin Installation .....	32
2.2 Board Layout.....	33
2.3 Installation.....	39
<b>3. McBIOS RAID Manager .....</b>	<b>56</b>
3.1 Starting the McBIOS RAID Manager.....	56

3.2 McBIOS Configuration manager.....	57
3.3 Configuring Raid Sets and Volume Sets .....	58
3.4 Designating Drives as Hot Spares.....	58
3.5 Using Quick Volume /Raid Setup Configuration .....	59
3.6 Using RAID Set/Volume Set Function Method .....	60
3.7 Main Menu .....	62
3.7.1 Quick Volume/RAID Setup .....	63
3.7.2 Raid Set Function .....	66
3.7.2.1 Create Raid Set .....	67
3.7.2.2 Delete Raid Set .....	68
3.7.2.3 Expand Raid Set.....	68
• Migrating .....	69
3.7.2.4 Activate Incomplete Raid Set.....	70
3.7.2.5 Create Hot Spare.....	71
3.7.2.6 Delete Hot Spare .....	71
3.7.2.7 Raid Set Information .....	72
3.7.3 Volume Set Function .....	72
3.7.3.1 Create Volume Set.....	73
• Volume Name .....	75
• Raid Level .....	75
• Capacity .....	76
• Strip Size.....	77
• SCSI Channel .....	78
• SCSI ID .....	78
• SCSI LUN.....	79
• Cache Mode .....	79
3.7.3.2 Delete Volume Set .....	80
• Tag Queuing .....	80
3.7.3.3 Modify Volume Set.....	81
• Volume Growth .....	82
• Volume Set Migration.....	83
3.7.3.4 Check Volume Set.....	83
3.7.3.5 Stop Volume Set Check .....	83
3.7.3.6 Display Volume Set Info. ....	84
3.7.4 Physical Drives.....	85
3.7.4.1 View Drive Information .....	85
3.7.4.2 Create Pass-Through Disk .....	86
3.7.4.3 Modify a Pass-Through Disk.....	86
3.7.4.4 Delete Pass-Through Disk .....	87
3.7.4.5 Identify Selected Drive .....	87
3.7.5 Raid System Function .....	88
3.7.5.1 Mute The Alert Beeper .....	88

3.7.5.2 Alert Beeper Setting.....	89
3.7.5.3 Change Password .....	89
3.7.5.4 JBOD/RAID Function .....	90
3.7.5.5 Background Task Priority .....	91
3.7.5.6 Maximum SATA Mode .....	91
3.7.5.7 HDD Read Ahead Cache.....	92
3.7.5.8 Stagger Power On.....	92
3.7.5.9 Empty HDD slot HDD .....	93
3.7.5.10 HDD SMART Status Polling .....	94
3.7.5.11 Controller Fan Detection .....	94
3.7.5.12 Disk Write Cache Mode .....	95
3.7.5.13 Capacity Truncation.....	95
3.7.6 Ethernet Configuration (12/16/24-port).....	96
3.7.6.1 DHCP Function .....	97
3.7.6.2 Local IP address .....	98
3.7.6.3 Ethernet Address.....	99
3.7.7 View System Events .....	99
3.7.8 Clear Events Buffer.....	100
3.7.9 Hardware Monitor.....	100
3.7.10 System Information .....	100
<b>4. Driver Installation .....</b>	<b>102</b>
4.1 Creating the Driver Diskettes .....	102
4.2 Driver Installation for Windows .....	103
4.2.1 New Storage Device Drivers in Windows Server 2003....	103
4.2.2 Install Windows 2000/XP/2003 on a SATA RAID Volume	104
4.2.2.1 Installation procedures.....	104
4.2.2.2 Making Volume Sets Available to Windows System ...	105
4.2.3 Installing controller into an existing Windows 2000/XP/2003	106
Installation .....	106
4.2.3.1 Making Volume Sets Available to Windows System ...	107
4.2.4 Uninstall controller from Windows 2000/XP/2003.....	108
4.3 Driver Installation for Linux .....	109
4.4 Driver Installation for FreeBSD.....	109
4.5 Driver Installation for Solaris 10.....	110
4.6 Driver Installation for Mac 10.x .....	110
4.7 Driver Installation for UnixWare 7.1.4 .....	111
4.8 Driver Installation for NetWare 6.5 .....	111
<b>5. ArcHttp Proxy Server Installation.....</b>	<b>112</b>
5.1 For Windows.....	113
5.2 For Linux .....	114
5.3 For FreeBSD.....	115

5.4 For Solaris 10 x86 .....	116
5.5 For Mac OS 10.x .....	116
5.6 ArchHttp Configuration .....	117
<b>6. Web Browser-based Configuration .....</b>	<b>121</b>
6.1 Start-up McRAID Storage Manager .....	121
• Another method to start-up McRAID Storage Manager from Windows Local Administration .....	122
6.1.1 Through Ethernet port (Out-of-Band) .....	123
6.2 SATA RAID controller McRAID Storage Manager.....	124
6.3 Main Menu .....	125
6.4 Quick Function.....	125
6.5 RaidSet Functions .....	126
6.5.1 Create Raid Set .....	126
6.5.2 Delete Raid Set .....	127
6.5.3 Expand Raid Set.....	128
6.5.4 Activate Incomplete Raid Set .....	128
6.5.5 Create Hot Spare .....	129
6.5.6 Delete Hot Spare.....	129
6.5.7 Rescue Raid Set .....	129
6.6 Volume Set Functions .....	130
6.6.1 Create Volume Set .....	130
• Volume Name .....	131
• Raid Level .....	131
• Capacity .....	131
• Greater Two TB Volume Support.....	131
• Initialization Mode .....	132
• Strip Size .....	132
• Cache Mode .....	132
• SCSI Channel/SCSI ID/SCSI Lun.....	132
• Tag Queuing .....	132
6.6.2 Delete Volume Set.....	133
6.6.3 Modify Volume Set.....	133
6.6.3.1 Volume Set Migration .....	134
6.6.4 Check Volume Set .....	135
6.6.5 Stop VolumeSet Check .....	135
6.7 Physical Drive .....	135
6.7.1 Create Pass-Through Disk.....	136
6.7.2 Modify Pass-Through Disk.....	136
6.7.3 Delete Pass-Through Disk .....	137
6.8 System Controls .....	138
6.8.1 System Config .....	138

• System Beeper Setting .....	138
• Background Task Priority .....	138
• JBOD/RAID Configuration .....	138
• Maximun SATA Supported .....	138
• HDD Read Ahead Cache .....	138
• Stagger Power on .....	139
• Empty HDD Slot LED .....	140
• HDD SMART Status Polling.....	140
• Disk Write Cache Mode .....	141
• Disk Capacity Truncation Mode.....	141
6.8.2 Ethernet Configuration (12/16/24-port).....	142
6.8.3 Alert by Mail Configuration (12/16/24-port) .....	143
6.8.4 SNMP Configuration (12/16/24-port).....	144
• SNMP Trap Configurations .....	145
• SNMP System Configurations .....	145
• SNMP Trap Notification Configurations .....	145
6.8.5 NTP Configuration (12/16/24-port) .....	145
• NTP Sever Address.....	145
• Time Zone.....	146
• Automatic Daylight Saving.....	146
6.8.6 View Events/Mute Beeper .....	146
6.8.7 Generate Test Event .....	146
6.8.8 Clear Events Buffer.....	147
6.8.9 Modify Password .....	147
6.8.10 Update Firmware .....	148
6.9 Information .....	148
6.9.1 RaidSet Hierarchy.....	148
6.9.2 System Information.....	148

## **Appendix A ..... 151**

Upgrading Flash ROM Update Process.....	151
Upgrading Firmware Through McRAID Storage Manager.....	151
Upgrading Entire Flash ROM ImageThrough Arcflash DOS Utility	153

## **Appendix B ..... 156**

Battery Backup Module (ARC-6120-BAT).....	156
BBM Components .....	156
BBM Specifications.....	156
Installation .....	157
Battery Backup Capacity.....	157
Operation .....	158
Changing the Battery Backup Module .....	158
Status of BBM .....	158

<b>Appendix C .....</b>	<b>159</b>
SNMP Operation & Definition .....	159
<b>Appendix D .....</b>	<b>166</b>
Event Notification Configurations .....	166
A. Device Event.....	166
B. Volume Event.....	167
C. RAID Set Event .....	167
D. Hardware Event.....	168
<b>Appendix E .....</b>	<b>169</b>
General Troubleshooting Tips .....	169
<b>Appendix F .....</b>	<b>173</b>
Technical Support .....	173
<b>Glossary .....</b>	<b>174</b>
2TB .....	174
Array .....	174
ATA .....	174
Auto Reassign Sector .....	174
Battery Backup Module.....	175
BIOS .....	175
Cache .....	175
Consistency Check.....	175
Driver .....	175
Hot Spare.....	176
Hardware RAID versus Software RAID .....	176
Hot Swap .....	176
NVRAM.....	176
Parity.....	176
PCI Express .....	176
PCI-X .....	177
RAID .....	177
Rebuild .....	177
SATA (Serial ATA) .....	177
SMART .....	178
SNMP.....	178
Volume Set.....	178
Write-back.....	178
Write-through .....	178
XOR-Engine .....	179





# INTRODUCTION

---

## 1. Introduction

This section presents a brief overview of the SATA RAID Series controller, ARC-1110/1110ML/1120/1120ML/1130/1130ML/1160/1160ML/1170 (4/8/12/16/24-port PCI-X SATA RAID Controllers) and ARC-1210/1220/1230/1230/1231ML/1260/1261ML/1280/1280ML (4/8/12/16/24-port PCI-Express SATA RAID Controllers).

### 1.1 Overview

The ARC-11xx and ARC-12xx Series of high-performance Serial ATA RAID controllers support a maximum of 4, 8, 12, 16, or 24 SATA II peripheral devices (depending on model) on a single controller. The ARC-11xx series for the PCI-X bus and the ARC-12xx Series for the PCI-Express bus. When properly configured, these SATA controllers provide non-stop service with a high degree of fault tolerance through the use of RAID technology and can also provide advanced array management features.

The 4 and 8 port SATA RAID controllers are low-profile PCI cards, ideal for 1U and 2U rack-mount systems. These controllers utilize the same RAID kernel that has been field-proven in Areca existing external RAID controllers, allowing Areca to quickly bring stable and reliable RAID controllers to the market.

### Unparalleled Performance

The SATA RAID controllers provide reliable data protection for desktops, workstations, and servers. These cards set the standard with enhancements that include a high-performance Intel I/O Processor, a new memory architecture, and a high performance PCI bus interconnection. The 8/12/16/24-port controllers with the RAID 6 engine built-in can offer extreme-availability RAID 6 functionality. This engine can concurrently compute two parity blocks with performance very similar to RAID 5. The controllers by default support 256MB of ECC SDRAM memory. The 12/16/24 port controllers support one DDR333 SODIMM socket that allows for upgrading up to 1GB of memory. The 12/16/24 port controllers support one DDR2-533 DIMM socket that allows for upgrading up to 2GB of memory. The controllers use Marvell 4/8 channel SATA PCI-X controller

chips, which can simultaneously communicate with the I/O processor and read or write data on multiple drives.

## **Unsurpassed Data Availability**

As storage capacity requirements continue to rapidly increase, users require greater levels of disk drive fault tolerance, which can be implemented without doubling the investment in disk drives. RAID 1 (mirroring) provides high fault tolerance. However, half of the drive capacity of the array is lost to mirroring, making it too costly for most users to implement on large volume sets due to doubling the number of drives required. Users want the protection of RAID 1 or better with an implementation cost comparable to RAID 5. RAID 6 can offer fault tolerance greater than RAID 1 or RAID 5 but only consumes the capacity of 2 disk drives for distributed parity data. The 8/12/16/24-port RAID controllers provide RAID 6 functionality to meet these demanding requirements.

The SATA RAID controllers also provide RAID levels 0, 1, 1E, 3, 5 or JBOD configurations. Its high data availability and protection is derived from the following capabilities: Online RAID Capacity Expansion, Array Roaming, Online RAID Level / Stripe Size Migration, Dynamic Volume Set Expansion, Global Online Spare, Automatic Drive Failure Detection, Automatic Failed Drive Rebuilding, Disk Hot-Swap, Online Background Rebuilding and Instant Availability/Background Initialization. During the controller firmware flash upgrade process, it is possible that an error results in corruption of the controller firmware. This could result in the device becoming non-functional. However, with our Redundant Flash image feature, the controller will revert back to the last known version of firmware and continue operating. This reduces the risk of system failure due to firmware crashes.

## **Easy RAID Management**

The SATA RAID controller utilizes built-in firmware with an embedded terminal emulation that can access via hot key at BIOS boot-up screen. This pre-boot manager utility can be used to simplify the setup and management of the RAID controller. The controller firmware also contains a ArcHttp browser-based program that can be accessed through the ArcHttp proxy server function in Windows,

# INTRODUCTION

---

Linux, FreeBSD and more environments. This Web browser-based RAID management utility allows both local and remote creation and modification RAID sets, volume sets, and monitoring of RAID status from standard web browsers.

## 1.2 Features

### **Adapter Architecture**

- Intel IOP 331 I/O processor (ARC-11xx series)
- Intel IOP 332/IOP 333 I/O processor (ARC-12xx series)
- Intel IOP341 I/O processor (ARC-12x1ML/ARC-1280ML/1280)
- 64-bit/133MHz PCI-X Bus compatible
- PCI Express X8 compatible
- 256MB on-board DDR333 SDRAM with ECC protection (4/8-port)
- One SODIMM Socket with default 256 MB of DDR333 SDRAM with ECC protection, upgrade to 1GB (12, 16 and 24-port cards only)
- One DIMM Socket with default 256 MB of DDR2-533 SDRAM with ECC protection, upgrade to 2GB(ARC-12xxML, ARC-1280)
- An ECC or non-ECC SDRAM module using X8 or X16 devices
- Support up to 4/8/12/16/24 SATA II drives
- Write-through or write-back cache support
- Multi-adapter support for large storage requirements
- BIOS boot support for greater fault tolerance
- BIOS PnP (plug and play) and BBS (BIOS boot specification) support
- Supports extreme performance Intel RAID 6 functionality
- NVRAM for RAID event & transaction log
- Battery backup module (BBM) ready (Depend on mother board)

### **RAID Features**

- RAID level 0, 1, 1E, 3, 5, 6 (R6 engine inside) and JBOD
- Multiple RAID selection
- Array roaming
- Online RAID level/stripe size migration
- Online capacity expansion & RAID level migration simultaneously
- Online volume set growth
- Instant availability and background initialization
- Automatic drive insertion / removal detection and rebuilding
- Greater than 2TB per volume set for 64-bit LBA

# INTRODUCTION

---

- Redundant flash image for adapter availability
- Support S.M.A.R.T, NCQ and OOB staggered spin-up capable drives

## **Monitors/Notification**

- System status indication through LED/LCD connector, HDD activity/fault connector, and alarm buzzer
- SMTP support for email notification
- SNMP agent supports for remote SNMP Manager
- I2C Enclosure Management Ready (IOP331/332/333)
- I2C & SGPIO Enclosure Management Ready (IOP341)

## **RAID Management**

- Field-upgradeable firmware in flash ROM
- Ethernet port support on 12/16/24-port

## **In-Band Manager**

- Hot key boot-up McBIOS RAID manager via BIOS
- Support controller's API library, allowing customer to write its own AP
- Support Command Line Interface (CLI)
- Browser-based management utility via ArchHttp proxy server
- Single Admin Portal (SAP) monitor utility
- Disk Stress Test (DST) utility for production in Windows

## **Out-of-Band Manager**

- Firmware-embedded browser-based RAID manager, SMTP manager, SNMP agent and Telnet function via Ethernet port (for 12/16/24-port Adapter)
- Support controller's API library for customer to write its own AP (for 12/16/24-port Adapter)
- Push Button and LCD display panel (option)

## **Operating System**

- Windows 2000/XP/Server 2003
  - Red Hat Linux
  - SuSE Linux
  - FreeBSD
  - Novell Netware 6.5
  - Solaris 10 X86/X86\_64
  - SCO Unixware 7.1.4
  - Mac OS 10.X (no\_bootable)
- (For latest supported OS listing visit <http://www.areca.com.tw>)

# INTRODUCTION

<b>Internal PCI-X RAID Card Comparison (ARC-11XX)</b>					
	1110	1120	1130	1160	1170
RAID processor	IOP331				
Host Bus Type	PCI-X 133MHz				
RAID 6 support	N/A	YES	YES	YES	YES
Cache Memory	256MB	256MB	One SO-DIMM	One SO-DIMM	One SO-DIMM
Drive Support	4 * SATA II	8 * SATA II	12 * SATA II	16 * SATA II	24 * SATA II
Disk Connector	SATA	SATA	SATA	SATA	SATA

<b>PCI-X RAID Card Comparison (ARC-11XXML)</b>				
	1110ML	1120ML	1130ML	1160ML
RAID processor	IOP331			
Host Bus Type	PCI-X 133MHz			
RAID 6 support	N/A	YES	YES	YES
Cache Memory	256MB	256MB	One SODIMM	One SODIMM
Drive Support	4 * SATA II	8 * SATA II	12 * SATA II	16 * SATA II
Disk Connector	Infinband	Infinband	Multi-lane	Multi-lane

<b>Internal PCI-Express RAID Card Comparison (ARC-12XX)</b>				
	1210	1220	1230	1260
RAID processor	IOP332	IOP333		
Host Bus Type	PCI-Express X8			
RAID 6 support	N/A	YES	YES	YES
Cache Memory	256MB	256MB	One SODIMM	One SODIMM
Drive Support	4 * SATA II	8 * SATA II	12 * SATA II	16 * SATA II
Disk Connector	SATA	SATA	SATA	SATA

# INTRODUCTION

<b>Internal PCI-Express RAID Card Comparison (ARC-12XX)</b>				
	1231ML	1261ML	1280ML	1280
RAID processor	IOP341			
Host Bus Type	PCI-Express X8			
RAID 6 support	YES	YES	YES	YES
Cache Memory	One DDR2 DIMM (Default 256MB, Upgrade to 2GB)			
Drive Support	12 * SATA II	16 * SATA II	24 * SATA II	24 * SATA II
Disk Connector	3*Min SAS 4i	4*Min SAS 4i	6*Min SAS 4i	24*SATA

## 1.3 RAID Concept

### 1.3.1 RAID Set

A RAID set is a group of disks connected to a RAID controller. A RAID set contains one or more volume sets. The RAID set itself does not define the RAID level (0, 1, 1E, 3, 5, 6, etc); the RAID level is defined within each volume set. Therefore, volume sets are contained within RAID sets and RAID Level is defined within the volume set. If physical disks of different capacities are grouped together in a RAID set, then the capacity of the smallest disk will become the effective capacity of all the disks in the RAID set.

### 1.3.2 Volume Set

Each volume set is seen by the host system as a single logical device (in other words, a single large virtual hard disk). A volume set will use a specific RAID level, which will require one or more physical disks (depending on the RAID level used). RAID level refers to the level of performance and data protection of a volume set. The capacity of a volume set can consume all or a portion of the available disk capacity in a RAID set. Multiple volume sets can exist in a RAID set.

For the SATA RAID controller, a volume set must be created either on an existing RAID set or on a group of available individual disks (disks that are about to become part of a RAID set). If there are pre-existing RAID sets with available capacity and enough disks for the desired RAID level, then the volume set can be created in the existing RAID set of the user's choice.

# INTRODUCTION

---

In the illustration, volume 1 can be assigned a RAID level 5 of operation while volume 0 might be assigned a RAID level 1E of operation. Alternatively, the free space can be used to create volume 2, which could then be set to use RAID level 5.

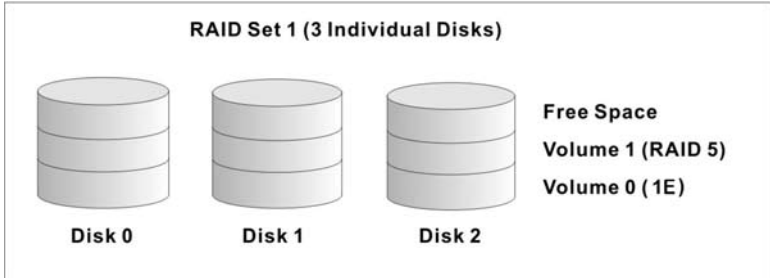

## 1.3.3 Ease of Use Features

### 1.3.3.1 Foreground Availability/Background Initialization

RAID 0 and RAID 1 volume sets can be used immediately after creation because they do not create parity data. However, RAID 3, 5 and 6 volume sets must be initialized to generate parity information. In Background Initialization, the initialization proceeds as a background task, and the volume set is fully accessible for system reads and writes. The operating system can instantly access the newly created arrays without requiring a reboot and without waiting for initialization to complete. Furthermore, the volume set is protected against disk failures while initialing. If using Foreground Initialization, the initialization process must be completed before the volume set is ready for system accesses.

### 1.3.3.2 Array Roaming

The SATA RAID controllers store RAID configuration information on the disk drives. The controller therefore protect the configuration settings in the event of controller failure. Array roaming allows the administrators the ability to move a complete RAID set to another system without losing RAID configuration infor-



mation or data on that RAID set. Therefore, if a server fails, the RAID set disk drives can be moved to another server with an Areca RAID controller and the disks can be inserted in any order.

### **1.3.3.3 Online Capacity Expansion**

Online Capacity Expansion makes it possible to add one or more physical drives to a volume set without interrupting server operation, eliminating the need to backup and restore after reconfiguration of the RAID set. When disks are added to a RAID set, unused capacity is added to the end of the RAID set. Then, data on the existing volume sets (residing on the newly expanded RAID set) is redistributed evenly across all the disks. A contiguous block of unused capacity is made available on the RAID set. The unused capacity can be used to create additional volume sets.

A disk, to be added to a RAID set, must be in normal mode (not failed), free (not spare, in a RAID set, or passed through to host) and must have at least the same capacity as the smallest disk capacity already in the RAID set.

Capacity expansion is only permitted to proceed if all volumes on the RAID set are in the normal status. During the expansion process, the volume sets being expanded can be accessed by the host system. In addition, the volume sets with RAID level 1, 1E, 3, 5 or 6 are protected against data loss in the event of disk failure(s). In the case of disk failure, the volume set transitions from "migrating" state to "migrating+degraded" state. When the expansion is completed, the volume set would then transition to "degraded" mode. If a global hot spare is present, then it further transitions to the "rebuilding" state.

# INTRODUCTION

---

The expansion process is illustrated as following figure.

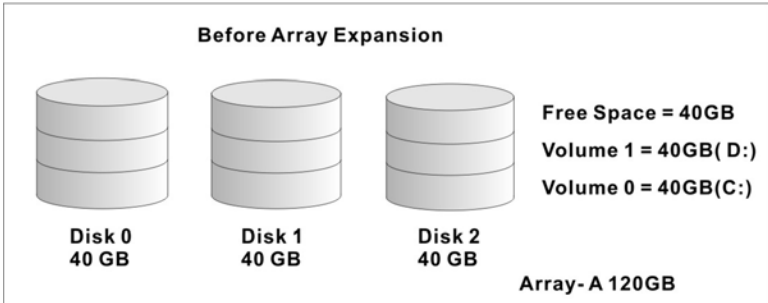

The SATA RAID controller redistributes the original volume set over the original and newly added disks, using the same fault-tolerance configuration. The unused capacity on the expand RAID set can then be used to create an additional volume set, with a different fault tolerance setting (if required by the user.)

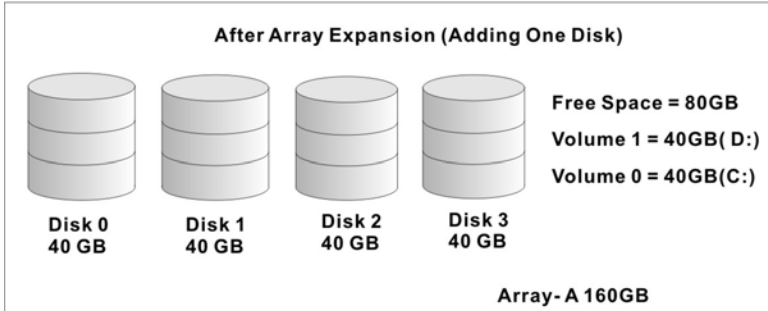

The SATA RAID controller redistributes the original volume set over the original and newly added disks, using the same fault-tolerance configuration. The unused capacity on the expand raid set can then be used to create an additional volume sets, with a different fault tolerance setting if user need to change.

## **1.3.3.4 Online RAID Level and Stripe Size Migration**

For those who wish to later upgrade to any RAID capabilities, a system with Areca online RAID level/stripe size migration allows a simplified upgrade to any supported RAID level without having to reinstall the operating system.

The SATA RAID controllers can migrate both the RAID level and stripe size of an existing volume set, while the server is on-line and the volume set is in use. Online RAID level/stripe size migration can prove helpful during performance tuning activities as well as when additional physical disks are added to the SATA RAID controller. For example, in a system using two drives in RAID level 1, it is possible to add a single drive and add capacity and retain fault tolerance. (Normally, expanding a RAID level 1 array would require the addition of two disks). A third disk can be added to the existing RAID logical drive and the volume set can then be migrated from RAID level 1 to 5. The result would be parity fault tolerance and double the available capacity without taking the system down. A fourth disk could be added to migrate to RAID level 6. It is only possible to migrate to a higher RAID level by adding a disk; disks in an existing array can't be reconfigured for a higher RAID level without adding a disk.

Online migration is only permitted to begin, if all volumes to be migrated are in the normal mode. During the migration process, the volume sets being migrated are accessed by the host system. In addition, the volume sets with RAID level 1, 1E, 3, 5 or 6 are protected against data loss in the event of disk failure(s). In the case of disk failure, the volume set transitions from migrating state to (migrating+degraded) state. When the migration is completed, the volume set transitions to degraded mode. If a global hot spare is present, then it further transitions to rebuilding state.

## **1.3.3.5 Online Volume Expansion**

Performing a volume expansion on the controller is the process of growing only the size of the latest volume. A more flexible option is for the array to concatenate an additional drive into the RAID set and then expand the volumes on the fly. This happens

# INTRODUCTION

---

transparently while the volumes are online, but, at the end of the process, the operating system will detect free space at after the existing volume.

Windows, NetWare and other advanced operating systems support volume expansion, which enables you to incorporate the additional free space within the volume into the operating system partition. The operating system partition is extended to incorporate the free space so it can be used by the operating system without creating a new operating system partition.

You can use the Diskpart.exe command line utility, included with Windows Server 2003 or the Windows 2000 Resource Kit, to extend an existing partition into free space in the dynamic disk.

Third-party software vendors have created utilities that can be used to repartition disks without data loss. Most of these utilities work offline. Partition Magic is one such utility.

## 1.4 High availability

### 1.4.1 Global Hot Spares

A Global Hot Spare is an unused online available drive, which is ready for replacing the failure disk. The Global Hot Spare is one of the most important features that SATA RAID controllers provide to deliver a high degree of fault-tolerance. A Global Hot Spare is a spare physical drive that has been marked as a global hot spare and therefore is not a member of any RAID set. If a disk drive used in a volume set fails, then the Global Hot Spare will automatically take its place and the data previously located on the failed drive is reconstructed on the Global Hot Spare.

For this feature to work properly, the global hot spare must have at least the same capacity as the drive it replaces. Global Hot Spares only work with RAID level 1, 1E, 3, 5, or 6 volume set. You can configure up to three global hot spares with ARC-11xx/12xx.

The Create Hot Spare option gives you the ability to define a

global hot spare disk drive. To effectively use the global hot spare feature, you must always maintain at least one drive that is marked as a global spare.

**Important:**

The hot spare must have at least the same capacity as the drive it replaces.

## 1.4.2 Hot-Swap Disk Drive Support

The SATA controller chip includes a protection circuit that supports the replacement of SATA hard disk drives without having to shut down or reboot the system. A removable hard drive tray can deliver “hot swappable” fault-tolerant RAID solutions at prices much less than the cost of conventional SCSI hard disk RAID controllers. This feature provides advanced fault tolerant RAID protection and “online” drive replacement.

## 1.4.3 Auto Declare Hot-Spare

If a disk drive is brought online into a system operating in degraded mode, The SATA RAID controllers will automatically declare the new disk as a spare and begin rebuilding the degraded volume. The Auto Declare Hot-Spare function requires that the smallest drive contained within the volume set in which the failure occurred.

In the normal status, the newly installed drive will be reconfigured an online free disk. But, the newly-installed drive is automatically assigned as a hot spare if any hot spare disk was used to rebuild and without new installed drive replaced it. In this condition, the Auto Declare Hot-Spare status will disappeared if the RAID sub-system has since powered off/on.

The Hot-Swap function can be used to rebuild disk drives in arrays with data redundancy such as RAID level 1, 1E, 3, 5, and 6.

# INTRODUCTION

---

## 1.4.4 Auto Rebuilding

If a hot spare is available, the rebuild starts automatically when a drive fails. The SATA RAID controllers automatically and transparently rebuild failed drives in the background at user-definable rebuild rates.

If a hot spare is not available, the failed disk drive must be replaced with a new disk drive so that the data on the failed drive can be automatically rebuilt and so that fault tolerance can be maintained.

The SATA RAID controllers will automatically restart the system and the rebuild process if the system is shut down or powered off abnormally during a reconstruction procedure condition.

When a disk is hot swapped, although the system is functionally operational, the system may no longer be fault tolerant. Fault tolerance will be lost until the removed drive is replaced and the rebuild operation is completed.

During the automatic rebuild process, system activity will continue as normal, however, the system performance and fault tolerance will be affected.

## 1.4.5 Adjustable Rebuild Priority

Rebuilding a degraded volume incurs a load on the RAID subsystem. The SATA RAID controllers allow the user to select the rebuild priority to balance volume access and rebuild tasks appropriately. The Background Task Priority is a relative indication of how much time the controller devotes to a background operation, such as rebuilding or migrating.

The SATA RAID controller allows user to choose the task priority (Ultra Low (5%), Low (20%), Medium (50%), High (80%)) to balance volume set access and background tasks appropriately. For high array performance, specify an Ultra Low value. Like volume initialization, after a volume rebuilds, it does not require a system reboot.

## 1.5 High Reliability

### 1.5.1 Hard Drive Failure Prediction

In an effort to help users avoid data loss, disk manufacturers are now incorporating logic into their drives that acts as an "early warning system" for pending drive problems. This system is called S.M.A.R.T. The disk integrated controller works with multiple sensors to monitor various aspects of the drive's performance, determines from this information if the drive is behaving normally or not, and makes available status information to RAID controller firmware that probes the drive and look at it.

The SMART can often predict a problem before failure occurs. The controllers will recognize a SMART error code and notify the administer of an impending hard drive failure.

### 1.5.2 Auto Reassign Sector

Under normal operation, even initially defect-free drive media can develop defects. This is a common phenomenon. The bit density and rotational speed of disks is increasing every year, and so is the potential of problems. Usually a drive can internally remap bad sectors without external help using cyclic redundancy check (CRC) checksums stored at the end of each sector.

SATA drives perform automatic defect re-assignment for both read and write errors. Writes are always completed - if a location to be written is found to be defective, the drive will automatically relocate that write command to a new location and map out the defective location. If there is a recoverable read error, the correct data will be transferred to the host and that location will be tested by the drive to be certain the location is not defective. If it is found to have a defect, data will be automatically relocated, and the defective location is mapped out to prevent future write attempts.

In the event of an unrecoverable read error, the error will be reported to the host and the location flagged as potentially defective. A subsequent write to that location will initiate a sector test and relocation should that location have a defect. Auto Reassign Sector does not affect disk subsystem performance because it

# INTRODUCTION

---

runs as a background task. Auto Reassign Sector discontinues when the operating system makes a request.

## 1.5.3 Consistency Check

A consistency check is a process that verifies the integrity of redundant data. For example, performing a consistency check of a mirrored drive assures that the data on both drives of the mirrored pair is exactly the same. To verify RAID 3, 5 or 6 redundancy, a consistency check reads all associated data blocks, computes parity, reads parity, and verifies that the computed parity matches the read parity.

Consistency checks are very important because they detect and correct parity errors or bad disk blocks in the drive. A consistency check forces every block on a volume to be read, and any bad blocks are marked; those blocks are not used again. This is critical and important because a bad disk block can prevent a disk rebuild from completing. We strongly recommend that you run consistency checks on a regular basis—at least once per week. Note that consistency checks degrade performance, so you should run them when the system load can tolerate it.

## 1.6 Data Protection

### 1.6.1 BATTERY BACKUP

The SATA RAID controllers are armed with a Battery Backup Module (BBM). While a Uninterruptible Power Supply (UPS) protects most servers from power fluctuations or failures, a BBM provides an additional level of protection. In the event of a power failure, a BBM supplies power to retain data in the RAID controller's cache, thereby permitting any potentially dirty data in the cache to be flushed out to secondary storage when power is restored.

The batteries in the BBM are recharged continuously through a trickle-charging process whenever the system power is on. The batteries protect data in a failed server for up to three or four days, depending on the size of the memory module. Under normal operating conditions, the batteries last for three years before replacement is necessary.



## 1.6.2 RECOVERY ROM

The SATA RAID controller firmware is stored on the flash ROM and is executed by the I/O processor. The firmware can also be updated through the PCI-X/PCIe bus port or Ethernet port (if equipped) without the need to replace any hardware chips. During the controller firmware upgrade flash process, it is possible for a problem to occur resulting in corruption of the controller firmware. With our Redundant Flash Image feature, the controller will revert back to the last known version of firmware and continue operating. This reduces the risk of system failure due to firmware crash.

## 1.7 Understanding RAID

RAID is an acronym for Redundant Array of Independent Disks. It is an array of multiple independent hard disk drives that provides high performance and fault tolerance. The SATA RAID controller implements several levels of the Berkeley RAID technology. An appropriate RAID level is selected when the volume sets are defined or created. This decision should be based on the desired disk capacity, data availability (fault tolerance or redundancy), and disk performance. The following section discusses the RAID levels supported by the SATA RAID controller.

The SATA RAID controller makes the RAID implementation and the disks' physical configuration transparent to the host operating system. This means that the host operating system drivers and software utilities are not affected, regardless of the RAID level selected. Correct installation of the disk array and the controller requires a proper understanding of RAID technology and the concepts.

### 1.7.1 RAID 0

RAID 0, also referred to as striping, writes stripes of data across multiple disk drives instead of just one disk drive. RAID 0 does not provide any data redundancy, but does offer the best high-speed data throughput. RAID 0 breaks up data into smaller blocks and then writes a block to each drive in the array. Disk striping enhances performance because multiple drives are accessed

# INTRODUCTION

simultaneously; the reliability of RAID Level 0 is less because the entire array will fail if any one disk drive fails, due to a lack of redundancy.

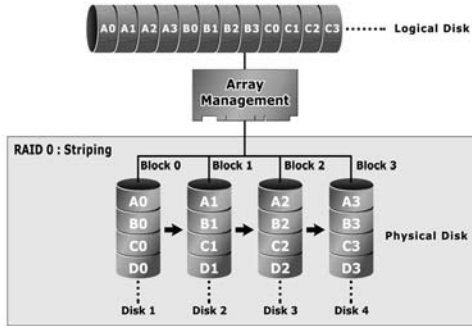

## 1.7.2 RAID 1

RAID 1 is also known as “disk mirroring”; data written to one disk drive is simultaneously written to another disk drive. Read performance may be enhanced if the array controller can, in parallel, accesses both members of a mirrored pair. During writes, there will be a minor performance penalty when compared to writing to a single disk. If one drive fails, all data (and software applications) are preserved on the other drive. RAID 1 offers extremely high data reliability, but at the cost of doubling the required data storage capacity.

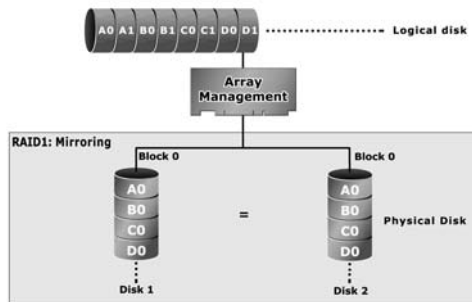

# INTRODUCTION

## 1.7.3 RAID 1E

RAID 1E is a combination of RAID 0 and RAID 1, combining striping with disk mirroring. RAID Level 1E combines the fast performance of Level 0 with the data redundancy of Level 1. In this configuration, data is distributed across several disk drives, similar to Level 0, which are then duplicated to another set of drive for data protection. RAID 1E has been traditionally implemented using an even number of disks, some hybrids can use an odd number of disks as well. Illustration is an example of a hybrid RAID 1E array comprised of five disks; A, B, C, D and E. In this configuration, each strip is mirrored on an adjacent disk with wrap-around. In fact this scheme - or a slightly modified version of it - is often referred to as RAID 1E and was originally proposed by IBM. When the number of disks comprising a RAID 1E is even, the striping pattern is identical to that of a traditional RAID 1E, with each disk being mirrored by exactly one other unique disk. Therefore, all the characteristics for a traditional RAID 1E apply to a RAID 1E when the latter has an even number of disks. Areca RAID 1E offers a little more flexibility in choosing the number of disks that can be used to constitute an array. The number can be even or odd.

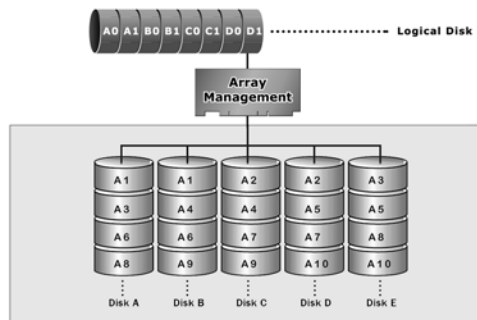

## 1.7.4 RAID 3

RAID 3 provides disk striping and complete data redundancy through a dedicated parity drive. RAID 3 breaks up data into smaller blocks, calculates parity by performing an exclusive-or on the blocks, and then writes the blocks to all but one drive in

# INTRODUCTION

the array. The parity data created during the exclusive-or is then written to the last drive in the array. If a single drive fails, data is still available by computing the exclusive-or of the contents corresponding strips of the surviving member disk. RAID 3 is best for applications that require very fast data- transfer rates or long data blocks.

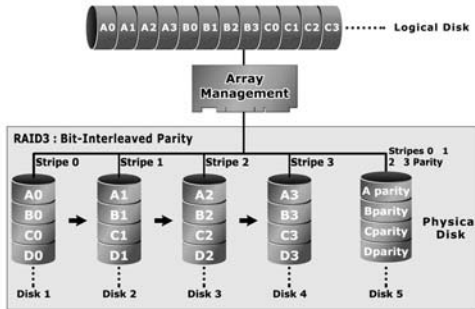

## 1.7.5 RAID 5

RAID 5 is sometimes called striping with parity at byte level. In RAID 5, the parity information is written to all of the drives in the controllers rather than being concentrated on a dedicated parity disk. If one drive in the system fails, the parity information can be used to reconstruct the data from that drive. All drives in the array system can be used for seek operations at the same time, greatly increasing the performance of the RAID system. This relieves the write bottleneck that characterizes RAID 4, and is the primary reason that RAID 5 is more often implemented in RAID arrays.

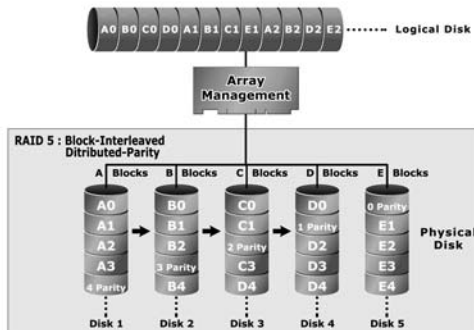

# INTRODUCTION

## 1.7.6 RAID 6

RAID 6 provides the highest reliability, but is not yet widely used. It is similar to RAID 5, but it performs two different parity computations or the same computation on overlapping subsets of the data. RAID 6 can offer fault tolerance greater than RAID 1 or RAID 5 but only consumes the capacity of 2 disk drives for distributed parity data. RAID 6 is an extension of RAID 5 but uses a second, independent distributed parity scheme. Data is striped on a block level across a set of drives, and then a second set of parity is calculated and written across all of the drives.

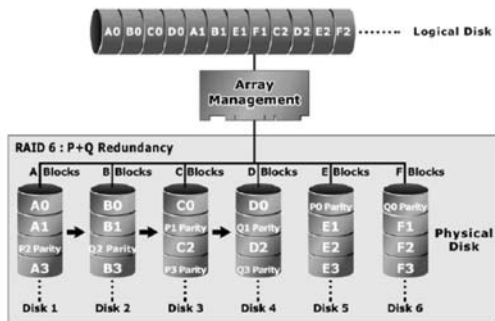

## Summary of RAID Levels

The SATA RAID controller supports RAID Level 0, 1, 1E, 3, 5 and 6. The table below provides a summary of RAID levels.

Features and Performance					
RAID Level	Description	Min. Drives	Data Reliability	Data Transfer Rate	I/O Request Rates
0	Also known as striping Data distributed across multiple drives in the array. There is no data protection.	1	No data Protection	Very High	Very High for Both Reads and Writes

# INTRODUCTION

1	Also known as mirroring All data replicated on N separated disks. N is almost always 2. This is a high availability solution, but due to the 100% duplication, it is also a costly solution. Half of drive capacity in array devoted to mirroring.	2	Lower than RAID 6; Higher than RAID 3, 5	Reads are higher than a single disk;  Writes similar to a single disk	Reads are twice as fast as a single disk;  Write are similar to a single disk.
1E	Also known Block-Interleaved Parity. Data and parity information is subdivided and distributed across all disks. Parity must be the equal to the smallest disk capacity in the array. Parity information normally stored on a dedicated parity disk.	3	Lower than RAID 6; Higher than RAID 3, 5	Transfer rates more similar to RAID 1 than RAID 0	Reads are twice as fast as a single disk;  Writes are similar to a single disk.
3	Also known Bit-Interleaved Parity. Data and parity information is subdivided and distributed across all disks. Parity data consumes the capacity of 1 disk drive. Parity information normally stored on a dedicated parity disk.	3	Lower than RAID 1, 1E, 6;  Higher than a single drive	Reads are similar to RAID 0;  Writes are slower than a single disk	Reads are close to being twice as fast as a single disk;  Writes are similar to a single disk.
5	Also known Block-Interleaved Distributed Parity. Data and parity information is subdivided and distributed across all disk. Parity data consumes the capacity of 2 disk drive.	3	Lower than RAID 1, 1E, 6;  Higher than a single drive	Reads are similar to RAID 0;  Writes are slower than a single disk	Reads are similar to RAID 0;  Writes are slower than a single disk.

# INTRODUCTION

---

6	RAID 6 provides the highest reliability. Similar to RAID 5, but does two different parity computations. RAID 6 offers fault tolerance greater than RAID 1 or RAID 5. Parity data consumes the capacity of 2 disk drives.	4	highest reliability	Reads are similar to RAID 0;  Writes are slower than a single disk	Reads are similar to RAID 0;  Writes are slower than a single disk.
---	--	---	---------------------	--	---

# HARDWARE INSTALLATION

---

## 2. Hardware Installation

This section describes the procedures for installing the SATA RAID controllers.

### 2.1 Before Your begin Installation

Thanks for purchasing the SATA RAID Controller as your RAID data storage and management system. This user guide gives simple step-by-step instructions for installing and configuring the SATA RAID Controller. To ensure personal safety and to protect your equipment and data, carefully read the information following the package content list before you begin installing.

#### Package Contents

If your package is missing any of the items listed below, contact your local dealer before proceeding with installation **(disk drives and disk mounting brackets are not included)**:

ARC-11xx Series SATA RAID Controller

- 1 x PCI-X SATA RAID Controller in an ESD-protective bag
- 4/8/12/16/24 x SATA interface cables (one per port)
- 1 x Installation CD
- 1 x User Manual

ARC-11xxML/12xxML Series SATA RAID Controller

- 1 x PCI-X SATA RAID Controller in an ESD-protective bag
- 1 x Installation CD
- 1 x User Manual

ARC-12xx Series SATA RAID Controller

- 1 x PCI-Express SATA RAID Controller in an ESD-protective bag
- 4/8/12/16/24 x SATA interface cables (one per port)
- 1 x Installation CD
- 1 x User Manual



# HARDWARE INSTALLATION

## 2.2 Board Layout

Follow the instructions below to install a PCI RAID Card into your PC / Server.

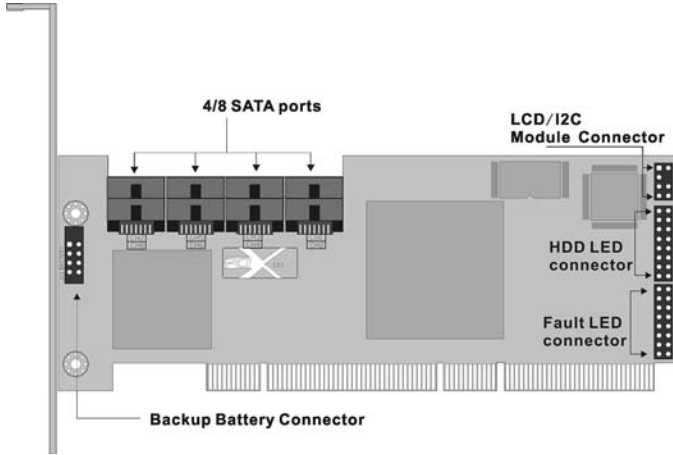

Figure 2-1, ARC-1110/1120 (4/8-port PCI-X SATA RAID Controller)

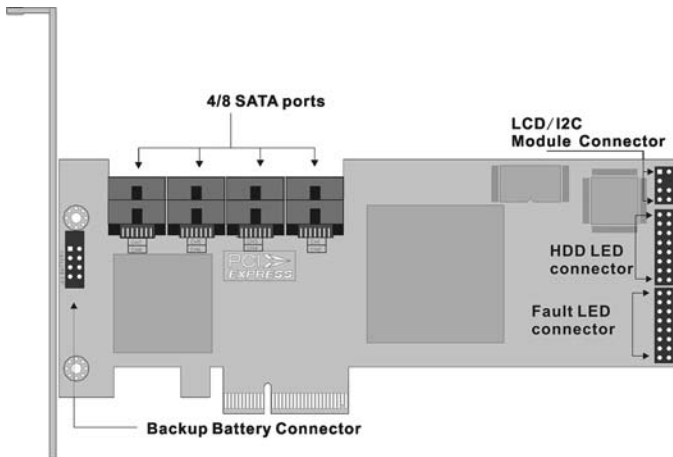

Figure 2-2, ARC-1210/1220 (4/8-port PCI-Express SATA RAID Controller)

# HARDWARE INSTALLATION

---

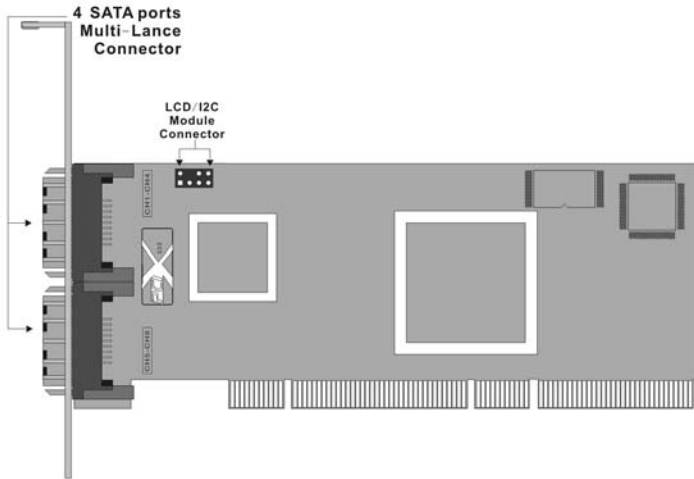

Figure 2-3, ARC-1110ML/1120ML (4/8-port PCI-X SATA RAID Controller)

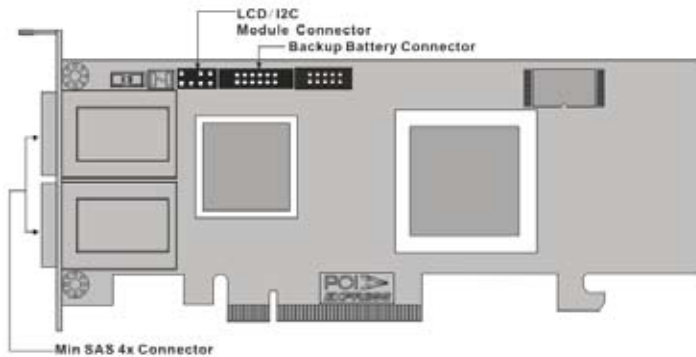

Figure 2-4, ARC-1210ML/1220ML (4-port PCI Express SAS RAID Controller)

# HARDWARE INSTALLATION

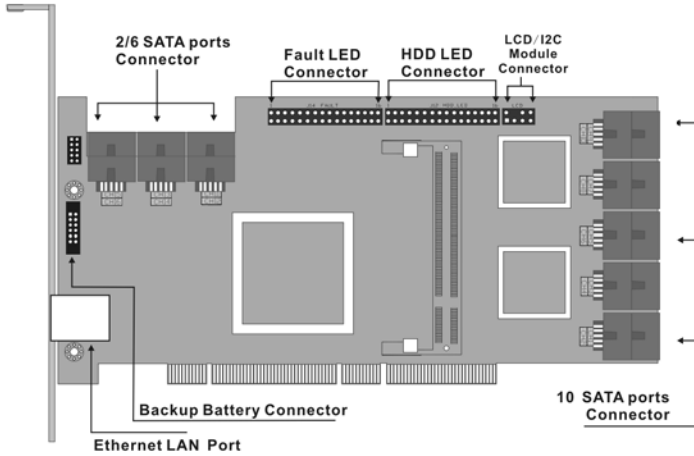

Figure 2-5, ARC-1130/1160 (12/16-port PCI-X SATA RAID Controller)

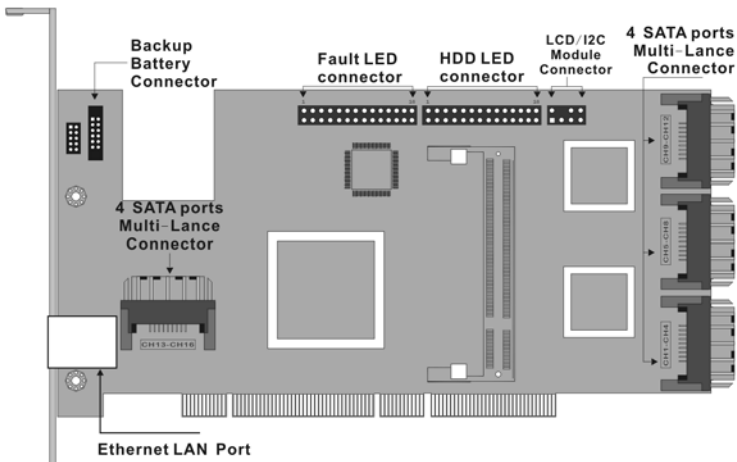

Figure 2-6, ARC-1130ML/1160ML (12/16-port PCI-X SATA RAID Controller)

# HARDWARE INSTALLATION

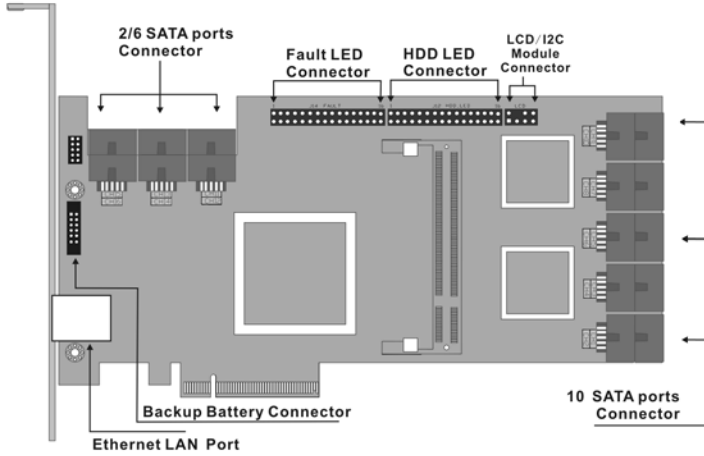

Figure 2-7, ARC-1230/1260 (12/16-port PCI-Express SATA RAID Controller)

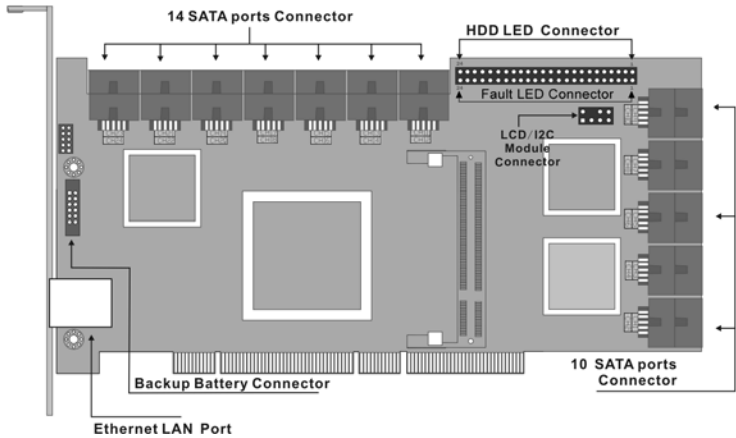

Figure 2-8, ARC-1170 (24-port PCI-X SATA RAID Controller)

# HARDWARE INSTALLATION

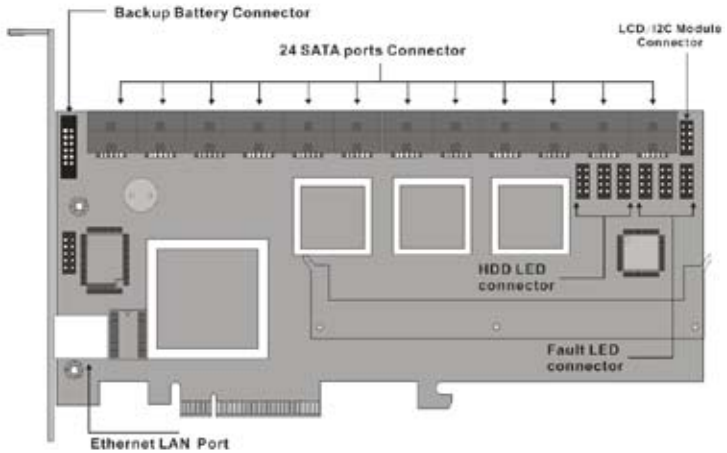

Figure 2-9, ARC-1280 (24-port PCI-Express SATA RAID Controller)

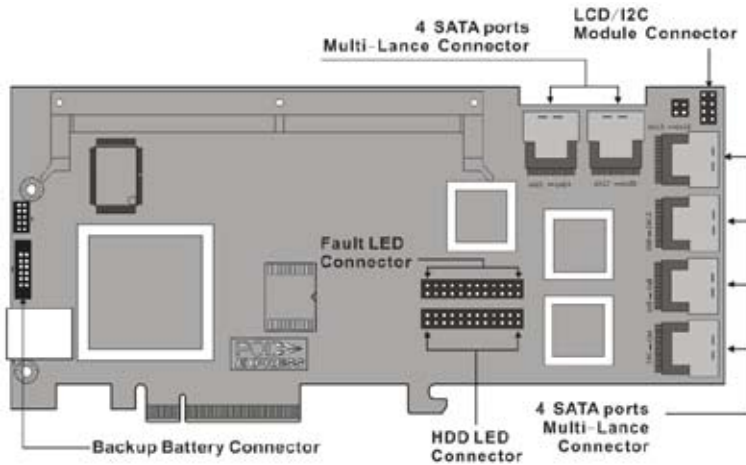

Figure 2-10, ARC-1231ML/1261ML/1280ML (12/16/24-port PCI-Express SATA RAID Controller)

# HARDWARE INSTALLATION

---

## Tools Required

An ESD grounding strap or mat is required. Also required are standard hand tools to open your system's case.

## System Requirement

The controller can be installed in a universal PCI slot and requires a motherboard that:

ARC-11xx series required one of the following:

- Complies with the PCI Revision 2.3 32/64-bit 33/66MHz, 3.3V.
- Complies with the PCI-X 32/64-bit 66/100/133 MHz, 3.3V.

ARC-12xx series requires:

- Complies with the PCI-Express X8

The SATA RAID controller may be connected to up to 4, 8, 12, 16, or 24 SATA II hard drives using the supplied cables.

Optional cables are required to connect any drive activity LEDs and fault LEDs on the enclosure to the SATA RAID controller.

## Installation Tools

The following items may be needed to assist with installing the SATA RAID controller into an available PCI expansion slot.

- Small screwdriver
- Host system hardware manuals and manuals for the disk or enclosure being installed.

## Personal Safety Information

To ensure personal safety as well as the safety of the equipment:

- Always wear a grounding strap or work on an ESD-protective mat.
- Before opening the system cabinet, turn off power switches and unplug the power cords. Do not reconnect the power cords until you have replaced the covers.

# HARDWARE INSTALLATION

---

## **Warning:**

High voltages may be found inside computer equipment. Before installing any of the hardware in this package or removing the protective covers of any computer equipment, turn off power switches and disconnect power cords. Do not reconnect the power cords until you have replaced the covers.

## **Electrostatic Discharge**

Static electricity can cause serious damage to the electronic components on this SATA RAID controller. To avoid damage caused by electrostatic discharge, observe the following precautions:

- Don't remove the SATA RAID controller from its anti-static packaging until you are ready to install it into a computer case.
- Handle the SATA RAID Controller by its edges or by the metal mounting brackets at its each end.
- Before you handle the SATA RAID controller in any way, touch a grounded, anti-static surface, such as an unpainted portion of the system chassis, for a few seconds to discharge any built-up static electricity.

## **2.3 Installation**

Follow the instructions below to install a SATA RAID controller into your PC / Server.

### **Step 1. Unpack**

Unpack and remove the SATA RAID controller from the package. Inspect it carefully, if anything is missing or damaged, contact your local dealer.

### **Step 2. Power PC/Server Off**

Turn off computer and remove the AC power cord. Remove the system's cover. See the computer system documentation for instruction.

# HARDWARE INSTALLATION

---

## Step 3. Install the PCI RAID Cards

To install the SATA RAID controller remove the mounting screw and existing bracket from the rear panel behind the selected PCI slot. Align the gold-fingered edge on the card with the selected PCI expansion slot. Press down gently but firmly to ensure that the card is properly seated in the slot, as shown in Figure 2-11. Next, screw the bracket into the computer chassis. ARC-11xx controllers can fit in both PCI (32-bit/3.3V) and PCI-X slots. It can get the best performance installed in a 64-bit/133MHz PCI-X slot. ARC-12xx controllers require a PCI-Express 8X slot.

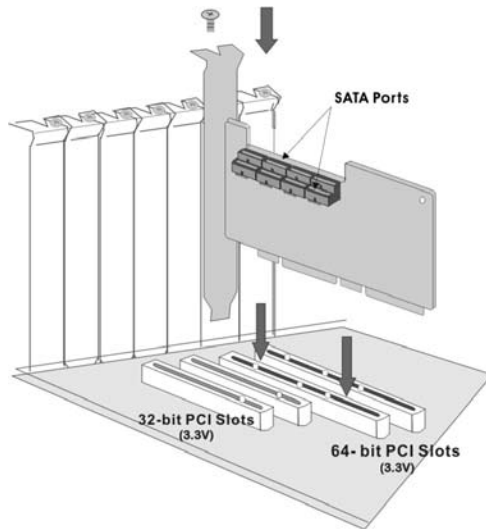

Figure 2-11, Insert SATA RAID controller into a PCI-X slot

## Step 4. Mount the Cages or Drives

Remove the front bezel from the computer chassis and install the Cages or SATA Drives in the computer chassis. Loading drives to the drive tray if cages are installed. Be sure that the power is connected to either the Cage backplane or the individual drives.



# HARDWARE INSTALLATION

Figure 2-12, Mount Cages & Drives

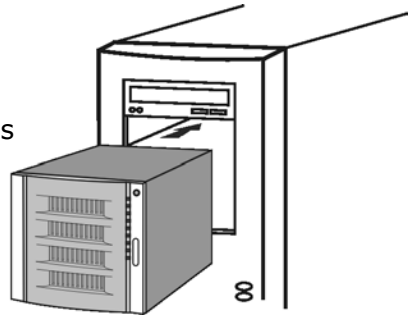

## Step 5 Connect the SATA cable

Model ARC-11XX and ARC-12XX controllers have dual-layer SATA internal connectors. If you have not already connected your SATA cables, use the cables included with your kit to connect the controller to the SATA hard drives.

The cable connectors are all identical, so it does not matter which end you connect to your controller, SATA hard drive, or cage back-plane SATA connector.

Figure 2-13, SATA Cable



### **Note:**

The SATA cable connectors must match your HDD cage. For example: Channel 1 of RAID Card connects to channel 1 of HDD cage, channel 2 of RAID Card connects to channel 2 of HDD cage, and follow this rule.

# HARDWARE INSTALLATION

---

## Step 5-2. Connect the Multi-lance cable

Model ARC-11XXML has multi-lance internal connectors, each of them can support up to four SATA drives. These adapters can be installed in a server RAID enclosure with a Multi-lance connector (SFF-8470) backplane. Multi-lance cables are not included in the ARC-11XXML package.

If you have not already connected your Multi-lance cables, use the cables included with your enclosure to connect your controller to the Multi-lance connector backplane. The type of cable will depend on what enclosure you have. The following diagram shows one example picture of Multi-lance cable.

Unpack and remove the PCI RAID cards. Inspect it carefully. If anything is missing or damaged, contact your local dealer.

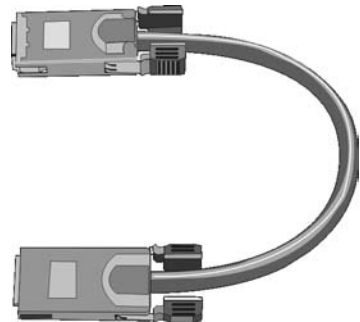

Figure 2-14, Multi-Lance Cable

## Step 5-3. Connect the Min SAS 4i to 4\*SATA cable

Model ARC-1231ML/1261ML/1280ML have Min SAS 4i (SFF-8087) internal connectors, each of them can support up to four SATA drives. These adapters can be installed in a server RAID enclosure with a standard SATA connector backplane. Min SAS 4i to SATA cables are included in the ARC-1231ML/1261ML/1280ML package. The following diagram shows the picture of MinSAS 4i to 4\*SATA cables.

Unpack and remove the PCI RAID cards. Inspect it carefully. If anything is missing or damaged, contact your local dealer.

# HARDWARE INSTALLATION

---

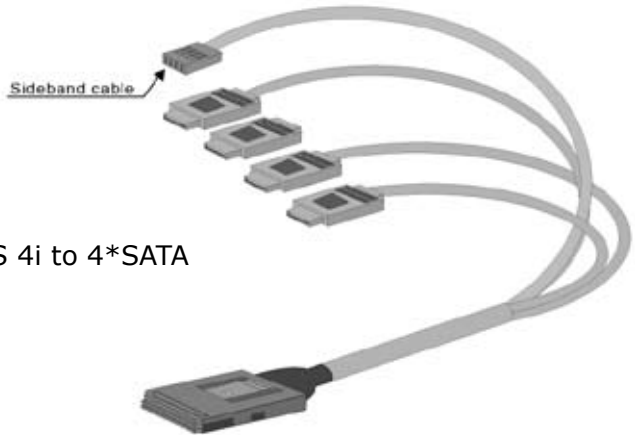

Figure 2-15, Min SAS 4i to 4\*SATA

For Sideband cable signal Please refer to page 51 for SGPIO bus.

## **Step 5-4. Connect the Min SAS 4i to Multi-lance cable**

Model ARC-1231ML/1261ML/1280ML have Min SAS 4i internal connectors, each of them can support up to four SATA drives. These controllers can be installed in a server RAID enclosure with a Multi-lance connector (SFF-8470) backplane. Multi-lance cables are not included in the ARC-12XXML package.

If you have not already connected your Min SAS 4i to Multi-lance cables, buy the Min SAS 4i to Multi-lance cables to fit your enclosure. And connect your controller to the Multi-lance connector backplane. The type of cable will depend on what enclosure you have. The following diagram shows one example picture of Min SAS 4i to Multi-lance cable.

Unpack and remove the PCI RAID cards. Inspect it carefully. If anything is missing or damaged, contact your local dealer.



Figure 2-16, Min SAS 4i to Multi-lance

# HARDWARE INSTALLATION

## Step 5-5. Connect the Min SAS 4i to Min SAS 4i cable

Model ARC-1230ML/1260ML/1280ML have Min SAS 4i internal connectors, each of them can support up to four SATA drives. These adapters can be installed in a server RAID enclosure with a Min SAS 4i internal connector backplane. Min SAS 4i cables are not included in the ARC-12XXML package.

This Min SAS 4i cable has eight signal pins to support four SATA drives and six pins for the SGPIO (Serial General Purpose Input/Output) side-band signals. The SGPIO bus is used for efficient LED management and for sensing drive Locate status. Please see page 51 for the details of the SGPIO bus.

Unpack and remove the PCI RAID cards. Inspect it carefully. If anything is missing or damaged, contact your local dealer.



Figure 2-17, Min SAS 4i to Min SAS 4i

## Step 6 Install the LED cable (optional)

ARC-1XXX Series Fault/Activity Header Intelligent Electronics Schematic.

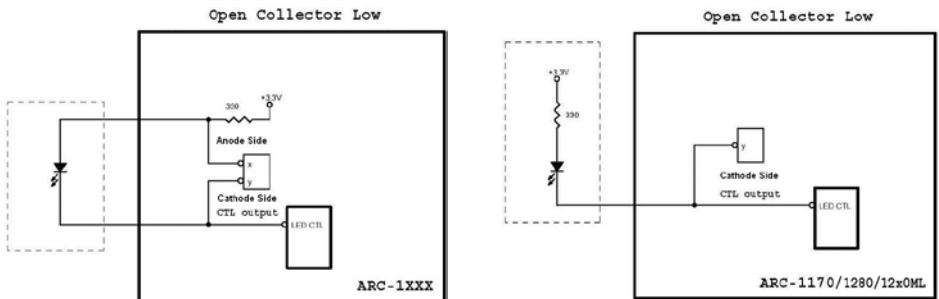

# HARDWARE INSTALLATION

The intelligent LED controller outputs a low-level pulse to determine if status LEDs are attached to pin sets 1 and 2. This allows automatic controller configuration of the LED output. If the logical level is different between the first 2 sets of the HDD LED header (LED attached to Set 1 but not Set 2), the controller will assign the first HDD LED header as the global indicator connector. Otherwise, each LED output will show only individual drive status.

The SATA RAID controller provides four kinds of LED status connectors.

- A: Global indicator connector, which lights when any drive is active.
- B: Individual LED indicator connector, for each drive channel.
- C: I<sup>2</sup>C connector, for SATA proprietary backplane enclosure.
- D: SGPIO connector for SAS Backplane enclosure

The following diagrams and description describes each type of connector.

## **Note:**

A cable for the global indicator comes with your computer system. Cables for the individual drive LEDs may come with a drive cage, or you may need to purchase them.

## A: Global Indicator Connector

If the system will use only a single global indicator, attach the global indicator cable to the two pins HDD LED connector. The following diagrams show the connector and pin locations.

Figure 2-18, ARC-1110/1120/1210/1220 global LED connection for Computer Case.

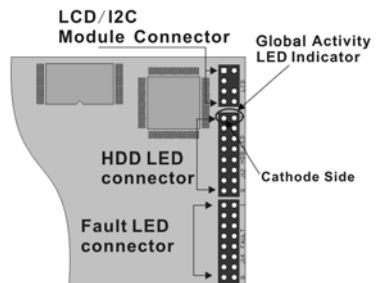

# HARDWARE INSTALLATION

Figure 2-19, ARC-1130/1160/1230/1260 global LED connection for Computer Case.

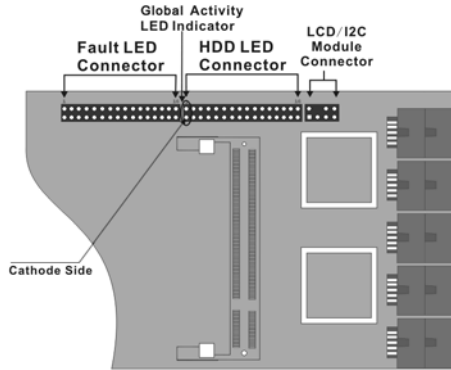

Figure 2-20, ARC-1170 global LED connection for Computer Case.

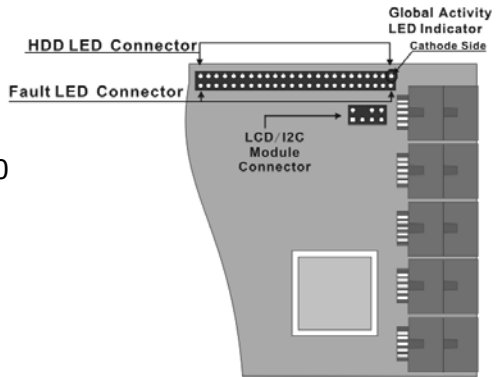
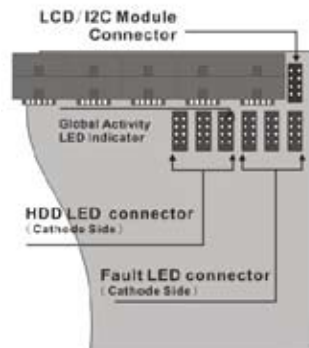
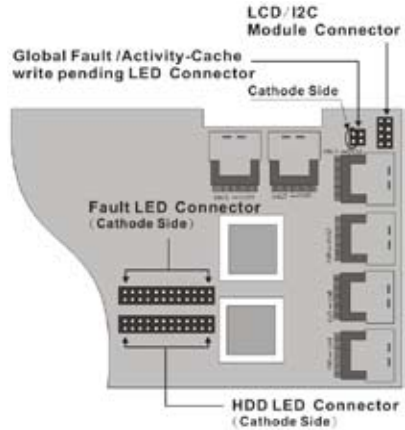

Figure 2-21, ARC-1280 global LED connection for Computer Case.



# HARDWARE INSTALLATION

Figure 2-22, ARC-1231ML/1261ML/1280ML global LED connection for Computer Case.



## B: Individual LED indicator connector

Connect the cables for the drive activity LEDs and fault LEDs between the backplane of the cage and the respective connector on the SATA RAID controller. The following describes the fault/activity LED.

LED	Normal Status	Problem Indication
Activity LED	When the activity LED is illuminated, there is I/O activity on that disk drive. When the LED is dark, there is no activity on that disk drive.	N/A
Fault LED	When the fault LED is solid illuminated, there is no disk present. When the fault LED is off, that disk is present and status is normal.	When the Red LED is slow blinking (2 times/sec), that disk drive has failed and should be hot-swapped immediately. When the activity LED is illuminated and Red LED is fast blinking (10 times/sec) there is rebuilding activity on that disk drive.

# HARDWARE INSTALLATION

Figure 2-23, ARC-1110/1120/1210/1220 Individual LED indicators connector, for each channel drive.

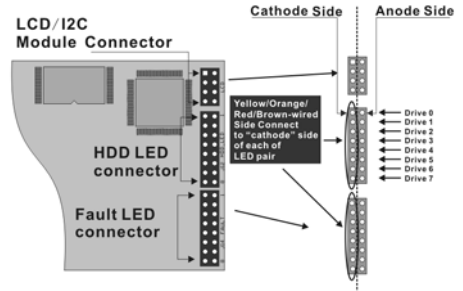

Figure 2-24, ARC-1130/1160/1230/1260 Individual LED indicators connector, for each channel drive.

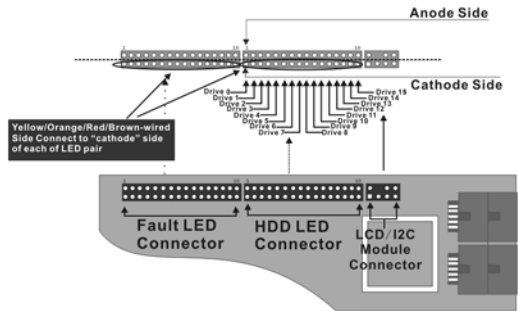
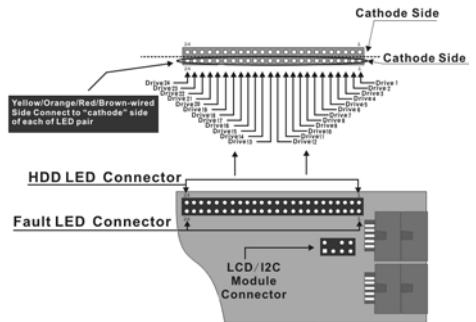

Figure 2-25, ARC-1170 Individual LED indicators connector, for each channel drive.





# HARDWARE INSTALLATION

Figure 2-26, ARC-1280 Individual LED indicators connector, for each channel drive.

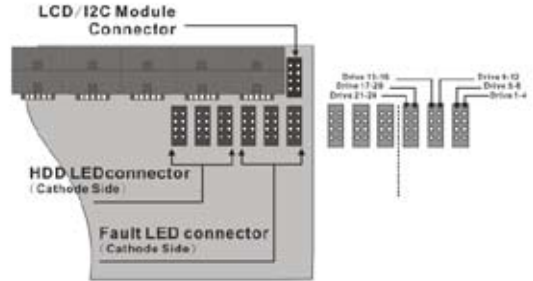
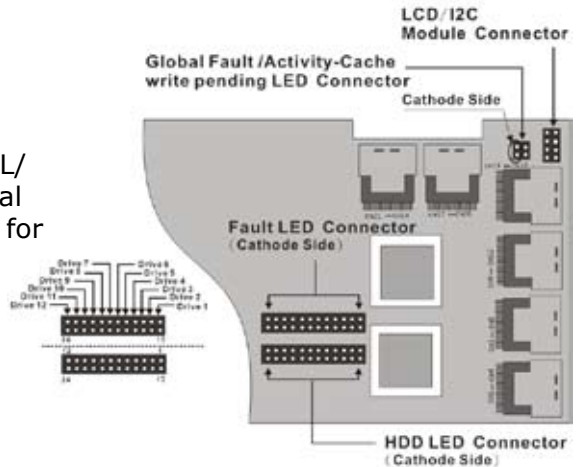

Figure 2-27, ARC-1231ML/1261ML/1280ML Individual LED indicators connector, for each channel drive.



## C: I<sup>2</sup>C Connector

You can also connect the I<sup>2</sup>C interface to a proprietary SATA backplane enclosure. This can reduce the number of activity LED and/or fault LED cables. The I<sup>2</sup>C interface can also cascade to another SATA backplane enclosure for the additional channel status display.

# HARDWARE INSTALLATION

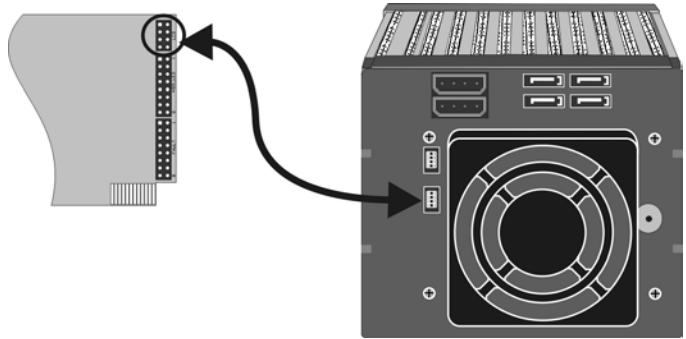

Figure 2-28, Activity/Fault LED I<sup>2</sup>C connector connected between SATA RAID Controller & SATA HDD Cage backplane.

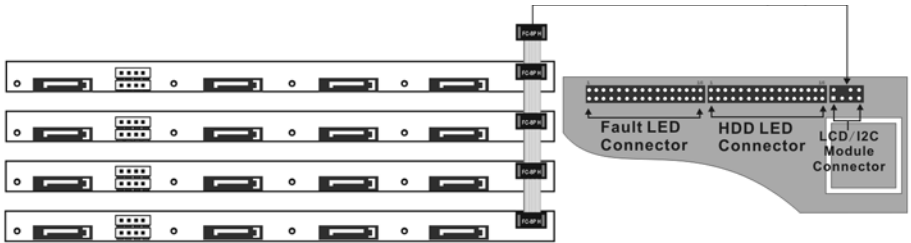
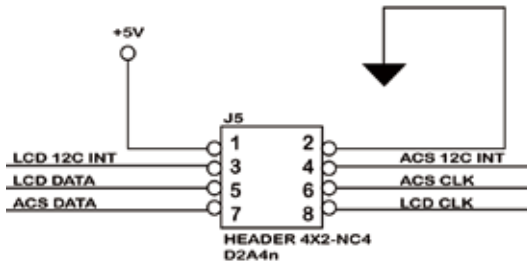

Figure 2-29, Activity/Fault LED I<sup>2</sup>C connector connected between SATA RAID Controller & 4 SATA HDD backplane.

**Note:**  
 Ci-Design has supported this feature in its 4-port 12-6336-05A SATA II backplane.

The following is the I<sup>2</sup>C signal name description for LCD & Fault/Activity LED.



# HARDWARE INSTALLATION

<b>PIN</b>	<b>Description</b>	<b>PIN</b>	<b>Description</b>
1	power (+5V)	2	GND
3	LCD Module Interrupt	4	Fault/Activity Interrupt
5	LCD Module Serial Data	6	Fault/Activity clock
7	Fault/Activity Serial Data	8	LCD Module clock

## D: SGPIO bus

The preferred I/O connector for server backplanes is the Min SAS 4i internal serial-attachment connector. This connector has eight signal pins to support four SATA drives and six pins for the SGPIO (Serial General Purpose Input/Output) side-band signals. The SGPIO bus is used for efficient LED management and for sensing drive Locate status. See SFF 8485 for the specification of the SGPIO bus.

The number of drives supported can be increased, by a factor of four, by adding similar backplane to maximum of 24 drives (6 backplanes)

**LED Management:** The backplane may contain LEDs to indicate drive status. Light from the LEDs could be transmitted to the outside of the server by using light pipes mounted on the SAS drive tray. A small EPLP microcontroller on the backplane, connected via the SGPIO bus to a ARC-1231ML/1261ML/1280ML SATA RAID controller, could control the LEDs. Activity: blinking 5 Times/Second  
Fault: solid illuminated

**Drive Locate Circuitry:** The locate of a drive may be detected by sensing the voltage level of one of the pre-charge pins before and after a drive is installed. Fault (red) blinking 2 Times/Second.

The following signal defines the SGPIO assignments for the Min SAS 4i connector in ARC-1231ML/1261ML/1280ML.

<b>PIN</b>	<b>Description</b>	<b>PIN</b>	<b>Description</b>
SideBand0	SClock (Clock Signal)	SideBand1	SLoad (Last clock of a bit stream)
SideBand2	Ground	SideBand3	Ground
SideBand4	SDataOut (Serial data output bit stream)	SideBand5	SDataIn (Serial data input bit stream)

# HARDWARE INSTALLATION

---

The following signal defines the sideband connector which can work with Areca sideband cable.

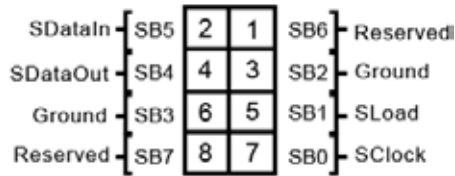

Sideband Pin Definitions

The sideband header is located at backplane. For SGPIO to work properly, please connect Areca 8-pin sideband cable to the sideband header as shown above. See the table for pin definitions.

## Step 7. Re-check the SATA HDD LED and Fault LED Cable connections

Be sure that the proper failed drive channel information is displayed by the Fault and HDD Activity LEDs. An improper connection will tell the user to “Hot Swap” the wrong drive. This will remove the wrong disk (one that is functioning properly) from the controller. This can result in failure and loss of system data.

## Step 8. Power up the System

Thoroughly check the installation, reinstall the computer cover, and reconnect the power cord cables. Turn on the power switch at the rear of the computer (if equipped) and then press the power button at the front of the host computer.

## Step 9. Configure volume set

The SATA RAID controller configures RAID functionality through the McBIOS RAID manager. Please refer to Chapter 3, McBIOS RAID manager, for the detail regarding configuration. The RAID controller can also be configured through the McRAID storage manager software utility with ArchHttp proxy server installed through on-board Lan port or LCD module. For this option, please reference Chapter 6, **Web Browser-Based** Configuration or LCD configuration menu.

# HARDWARE INSTALLATION

---

## Step 10. Install the controller driver

For a new system:

- Driver installation usually takes places as part of operating system installation. Please reference the Chapter 4 Diver Installation for the detail installation procedure.

In an existing system:

- Install the controller driver into the existing operating system. Please reference the Chapter 4, Driver Installation, for the detailed installation procedure.

### **Note:**

Look for newest release versions of drivers please download from <http://www.areca.com.tw>

## Step 11. Install ArchHttp proxy Server

The SATA RAID controller firmware has embedded the web-browser RAID manager. ArchHttp proxy driver will enable it. The browser-based RAID manager provides all of the creation, management, and monitor SATA RAID controller status. Please refer to the Chapter 5 for the detail ArchHttp proxy server installation. For SNMP agent function, please refer to Appendix C.

## Step 12. Determining the Boot sequences

The SATA RAID controller is a bootable controller. If your system already contains a bootable device with an installed operating system, you can set up your system to boot a second operating system from the new controller. To add a second bootable controller, you may need to enter setup and change the device boot sequence so that the SATA RAID controller heads the list. If the system BIOS setup does not allow this change, your system may not be configurable to allow the SATA RAID controller to act as a second boot device.

# HARDWARE INSTALLATION

## Summary of the installation

The flow chart below describes the installation procedures for SATA RAID controller. These procedures include hardware installation, the creation and configuration of a RAID volume through the McBIOS, OS installation and installation of SATA RAID controller software.

The software components configure and monitor the SATA RAID controller via ArchHttp Proxy Server.

Configuration Utility	Operating System supported
McBIOS RAID Manager	OS-Independent
McRAID Storage Manager (Via Archhttp proxy server)	Windows 2000/XP/2003, Linux, Free-BSD, NetWare, UnixWare, Solaris and Mac
SAP Monitor (Single Admin portal to scan for multiple RAID units in the network, Via ArchHttp proxy server)	Windows 2000/XP/2003
SNMP Manager Console Integration	Windows 2000/XP/2003, Linux and FreeBSD

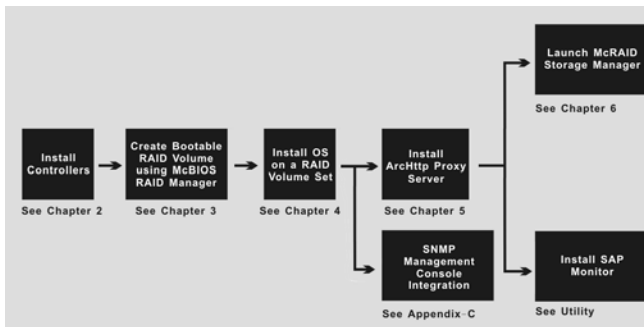

## McRAID Storage Manager

Before launching the firmware-embedded web server, McRAID storage manager, you can to install the ArchHttp proxy server on your server system or through on-board Lan-port (if equipped). If you need additional information about installation and start-up of this function, see the McRAID Storage Manager section in Chapter 6.

# HARDWARE INSTALLATION

---

## SNMP Manager Console Integration

- **Out of Band-Using Ethernet port (12/16/24-port Controller)**

Before launching the firmware-embedded SNMP agent in the sever, you need first to enable the fireware-embedded SNMP agent function on your SATA RAID controller. If you need additional information about installation and start-up this function, see the section 6.8.4 SNMP Configuration (12/16/24-port)

- **In-Band-Using PCI-X/PCIe Bus (4/8/12/16/24-port Controller)**

Before launching the SNMP agent in the sever, you need first to enable the fireware-embedded SNMP community configuration and install Areca SNMP extension agent in your server system. If you need additional information about installation and start-up the function, see the SNMP Operation & Installation section in the Appendix C

## Single Admin Portal (SAP) Monitor

This utility can scan for multiple RAID units on the network and monitor the controller set status. It also includes a disk stress test utility to identify marginal spec disks before the RAID unit is put into a production environment.

For additional information, see the utility manual in the packaged CD-ROM or download it from the web site <http://www.arec.com.tw>

# BIOS CONFIGURATION

---

## 3. McBIOS RAID Manager

The system mainboard BIOS automatically configures the following SATA RAID controller parameters at power-up:

- I/O Port Address
- Interrupt channel (IRQ)
- Adapter ROM Base Address

Use McBIOS to further configure the SATA RAID controller to suit your server hardware and operating system.

### 3.1 Starting the McBIOS RAID Manager

This section explains how to use the McBIOS Setup Utility to configure your RAID system. The BIOS Setup Utility is designed to be user-friendly. It is a menu-driven program, residing in the firmware, which allows you to scroll through various menus and sub-menus and select among the predetermined configuration options.

When starting a system with an SATA RAID controller installed, it will display the following message on the monitor during the start-up sequence (after the system bios startup screen but before the operating system boots):

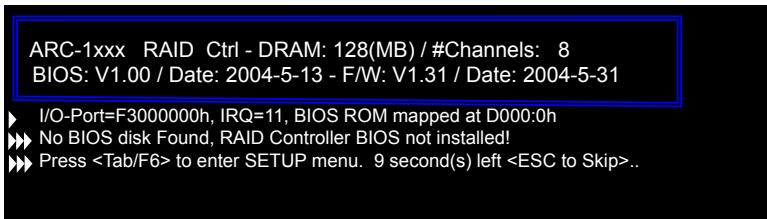

```
ARC-1xxx RAID Ctrl - DRAM: 128(MB) / #Channels: 8
BIOS: V1.00 / Date: 2004-5-13 - F/W: V1.31 / Date: 2004-5-31
▶ I/O-Port=F3000000h, IRQ=11, BIOS ROM mapped at D000:0h
▶▶ No BIOS disk Found, RAID Controller BIOS not installed!
▶▶▶ Press <Tab/F6> to enter SETUP menu. 9 second(s) left <ESC to Skip>..
```

The McBIOS configuration manager message remains on your screen for about nine seconds, giving you time to start the configure menu by pressing **Tab** or **F6**. If you do not wish to enter configuration menu, press **<ESC>** to skip configuration immediately. When activated, the McBIOS window appears showing a selection dialog box listing the SATA RAID controllers that are installed in the system.

The legend at the bottom of the screen shows you what keys are enabled for the windows.



# BIOS CONFIGURATION

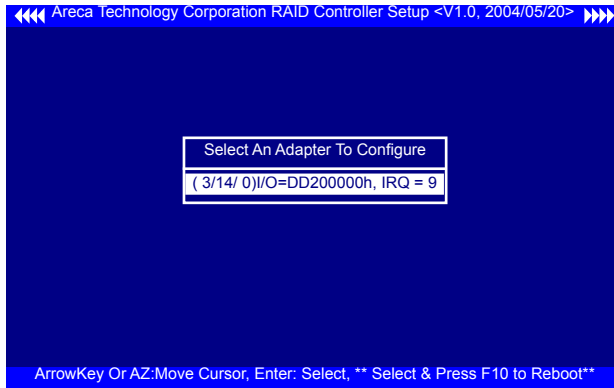

Use the Up and Down arrow keys to select the adapter you want to configure. While the desired adapter is highlighted, press the <Enter> key to enter the Main Menu of the McBIOS Configuration Utility.

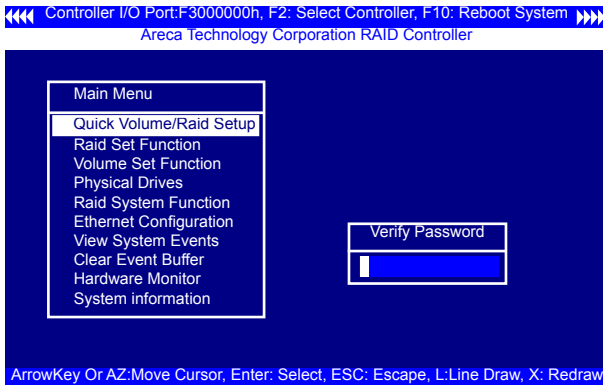

**Note:**  
The manufacture default password is set to **0000**; this password can be modified by selecting **Change Password** in the **Raid System Function** section.

## 3.2 McBIOS Configuration manager

The McBIOS configuration utility is firmware-based and is used to configure raid sets and volume sets. Because the utility resides in the SATA RAID controller firmware, operation is independent of any operating systems on your computer. This utility can be used to:

- Create RAID sets,
- Expand RAID sets,

# BIOS CONFIGURATION

---

- Add physical drives,
- Define volume sets,
- Modify volume sets,
- Modify RAID level/stripe size,
- Define pass-through disk drives,
- Modify system functions, and
- Designate drives as hot spares.

## 3.3 Configuring Raid Sets and Volume Sets

You can configure RAID sets and volume sets with McBIOS RAID manager automatically using Quick Volume/Raid Setup or manually using Raid Set/Volume Set Function. Each configuration method requires a different level of user input. The general flow of operations for RAID set and volume set configuration is:

Step	Action
1	Designate hot spares/pass-through drives (optional).
2	Choose a configuration method.
3	Create RAID sets using the available physical drives.
4	Define volume sets using the space available in the RAID Set.
5	Initialize the volume sets and use volume sets (as logical drives) in the host OS.

## 3.4 Designating Drives as Hot Spares

Any unused disk drive that is not part of a RAID set can be designated as a Hot Spare. The "Quick Volume/Raid Setup" configuration will add the spare disk drive and automatically display the appropriate raid level from which the user can select. For the "Raid Set Function configuration" option, the user can use the "Create Hot Spare" option to define the hot spare disk drive.

When a Hot Spare disk drive is being created using the "Create Hot Spare" option (in the Raid Set Function), all unused physical devices connected to the current controller appear:

Choose the target disk by selecting the appropriate check box. Press the **Enter** key to select a disk drive, and press **Yes** in the Create Hot Spare to designate it as a hot spare.

# BIOS CONFIGURATION

## 3.5 Using Quick Volume /Raid Setup Configuration

Quick Volume / Raid Setup Configuration collects all available drives and includes them in a RAID set. The RAID set you create is associated with exactly one volume set. You will only be able to modify the default RAID level, the stripe size, and the capacity of the new volume set. Designating drives as Hot Spares is also possible in the raid level selection option. The volume set default settings will be:

Parameter	Setting
Volume Name	Volume Set # 00
SCSI Channel/SCSI ID/SCSI LUN	0/0/0
Cache Mode	Write Back
Tag Queuing	Yes

The default setting values can be changed after configuration is complete. Follow the steps below to create arrays using the RAID Set / Volume Set method:

Step	Action
1	Choose <b>Quick Volume /Raid Setup</b> from the main menu. The available RAID levels with hot spare for the current volume set drive are displayed.
2	It is recommend that you drives of the same capacity in a specific array. If you use drives with different capacities in an array, all drives in the raid set will be set to the capacity of the smallest drive in the raid set. The numbers of physical drives in a specific array determines which RAID levels that can be implemented in the array. RAID 0 requires 1 or more physical drives. RAID 1 requires at least 2 physical drives. RAID 1+Spare requires at least 3 physical drives. RAID 1E requires at least 4 physical drives. RAID 3 requires at least 3 physical drives. RAID 5 requires at least 3 physical drives. RAID 3 +Spare requires at least 4 physical drives. RAID 5 + Spare requires at least 4 physical drives. RAID 6 requires at least 4 physical drives. RAID 6 + Spare requires at least 5 physical drives. Highlight the desired <b>RAID level</b> for the volume set and press the <b>Enter</b> key to confirm.

# BIOS CONFIGURATION

3	The capacity for the current volume set is entered after highlighting the desired RAID level and pressing the <b>Enter</b> key. The capacity for the current volume set is displayed. Use the <b>UP</b> and <b>DOWN</b> arrow keys to set the capacity of the volume set and press the <b>Enter</b> key to confirm. The available stripe sizes for the current volume set are then displayed.
4	Use the <b>UP</b> and <b>DOWN</b> arrow keys to select the current volume set stripe size and press the <b>Enter</b> key to confirm. This parameter specifies the size of the stripes written to each disk in a RAID 0, 1, 5 or 6 Volume Set. You can set the stripe size to 4 KB, 8 KB, 16 KB, 32 KB, 64 KB, or 128 KB. A larger stripe size provides better read performance, especially when the computer performs mostly sequential reads. However, if the computer performs random read requests more often, choose a smaller stripe size.
5	When you are finished defining the volume set, press the <b>Enter</b> key to confirm the Quick Volume And Raid Set Setup function.
6	Foreground (Fast Completion) Press <b>Enter</b> key to define fast initialization or Selected the Background (Instant Available). In the background Initialization, the initialization proceeds as a background task, the volume set is fully accessible for system reads and writes. The operating system can instantly access to the newly created arrays without requiring a reboot and waiting the initialization complete. In Fast Initialization, the initialization proceeds must be completed before the volume set ready for system accesses.
7	Initialize the volume set you have just configured.
8	If you need to add additional volume set, using main menu Create Volume Set function.

## 3.6 Using RAID Set/Volume Set Function Method

In "Raid Set Function", you can use the "Create Raid Set Function" to generate a new RAID set. In "Volume Set Function", you can use the "Create Volume Set function" to generate an associated volume set and configuration parameters.

If the current controller has unused physical devices connected, you can choose the "Create Hot Spare" option in the "Raid Set Function" to define a global hot spare. Select this method to configure new raid sets and volume sets. The "Raid Set/Volume Set Function" configuration option allows you to associate volume sets with partial and full RAID sets.

# BIOS CONFIGURATION

Step	Action
1	To setup the Hot Spare (option), choose <b>RAID Set Function</b> from the main menu. Select the <b>Create Hot Spare</b> and press the <b>Enter</b> key to define the Hot Spare.
2	Choose RAID Set Function from the main menu. Select Create RAID Set and press the Enter key.
3	The "Select a Drive For Raid Set" window is displayed showing the SATA drives connected to the SATA RAID controller.
4	Press the <b>UP</b> and <b>DOWN</b> arrow keys to select specific physical drives. Press the <b>Enter</b> key to associate the selected physical drive with the current RAID set. It is recommend that you drives of the same capacity in a specific array. If you use drives with different capacities in an array, all drives in the raid set will be set to the capacity of the smallest drive in the raid set. The numbers of physical drives in a specific array determines which RAID levels that can be implemented in the array. RAID 0 requires 1 or more physical drives. RAID 1 requires at least 2 physical drives. RAID (1+0) requires at least 4 physical drives. RAID 3 requires at least 3 physical drives. RAID 5 requires at least 3 physical drives. RAID 6 requires at least 4 physical drives.
5	After adding the desired physical drives to the current RAID set, press Yes to confirm the "Create Raid Set" function.
6	An "Edit The Raid Set Name" dialog box appears. Enter 1 to 15 alphanumeric characters to define a unique identifier for this new raid set. The default raid set name will always appear as Raid Set. #. Press Enter to finish the name editing.
7	Press the <b>Enter</b> key when you are finished creating the current RAID Set. To continue defining another RAID set, repeat step 3. To begin volume set configuration, go to step 8.
8	Choose the <b>Volume Set Function</b> from the Main menu. Select <b>Create Volume Set</b> and press the <b>Enter</b> key.
9	Choose a RAID set from the "Create Volume From Raid Set" window. Press the Enter key to confirm the selection.
10	Choosing Foreground (Fast Completion) or Background (Instant Availability) initiation: during Background Initialization, the initialization proceeds as a background task and the volume set is fully accessible for system reads and writes. The operating system can instantly access the newly created arrays without requiring a reboot and waiting for initialization complete. In Fast Initialization, the initialization must be completed before the volume set is ready for system accesses. In Fast Initialization, initiation is completed more quickly but volume access by the operating system is delayed.
11	If space remains in the raid set, the next volume set can be configured. Repeat steps 8 to 10 to configure another volume set.

# BIOS CONFIGURATION

## Note:

A user can use this method to examine the existing configuration. The "modify volume set configuration" method provides the same functions as the "create volume set configuration" method. In the volume set function, you can use "modify volume set" to change all volume set parameters except for capacity (size).

## 3.7 Main Menu

The main menu shows all functions that are available for executing actions, which is accomplished by clicking on the appropriate link.

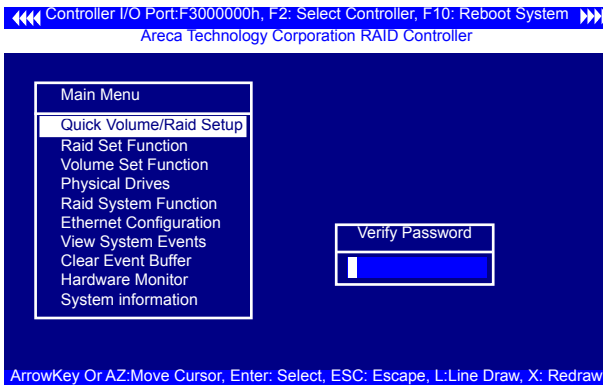

## Note:

The manufacture default password is set to **0000**; this password can be modified by selecting **Change Password** in the **Raid System Function** section.

Option	Description
Quick Volume/Raid Setup	Create a default configuration based on the number of physical disk installed
Raid Set Function	Create a customized RAID set
Volume Set Function	Create a customized volume set
Physical Drives	View individual disk information
Raid System Function	Setup the RAID system configuration
Ethernet Configuration	Ethernet LAN setting (ARC-1x30/1x60/1x70 only)
View System Events	Record all system events in the buffer
Clear Event Buffer	Clear all information in the event buffer
Hardware Monitor	Show the hardware system environment status
System Information	View the controller system information

# BIOS CONFIGURATION

This password option allows user to set or clear the raid controller's password protection feature. Once the password has been set, the user can only monitor and configure the raid controller by providing the correct password. The password is used to protect the internal RAID controller from unauthorized entry. The controller will prompt for the password only when entering the Main menu from the initial screen. The SATA RAID controller will automatically return to the initial screen when it does not receive any command in twenty seconds.

## 3.7.1 Quick Volume/RAID Setup

"Quick Volume/RAID Setup" is the fastest way to prepare a RAID set and volume set. It requires only a few keystrokes to complete. Although disk drives of different capacity may be used in the RAID set, it will use the capacity of the smallest disk drive as the capacity of all disk drives in the RAID set. The "Quick Volume/RAID Setup" option creates a RAID set with the following properties:

1. All of the physical drives are contained in one RAID set.
2. The RAID level, hot spare, capacity, and stripe size options are selected during the configuration process.
3. When a single volume set is created, it can consume all or a portion of the available disk capacity in this RAID set.
4. If you need to add an additional volume set, use the main menu "Create Volume Set" function.

The total number of physical drives in a specific RAID set determine the RAID levels that can be implemented within the RAID

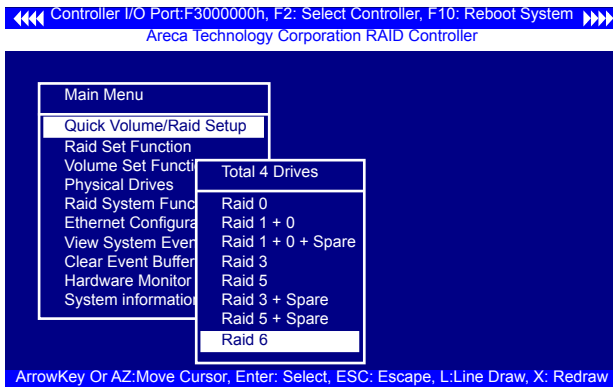

# BIOS CONFIGURATION

Set. Select "**Quick Volume/RAID Setup**" from the main menu; all possible RAID level will be displayed on the screen.

If volume capacity will exceed 2TB, controller will show the "Greater 2 TB volume Support" sub-menu.

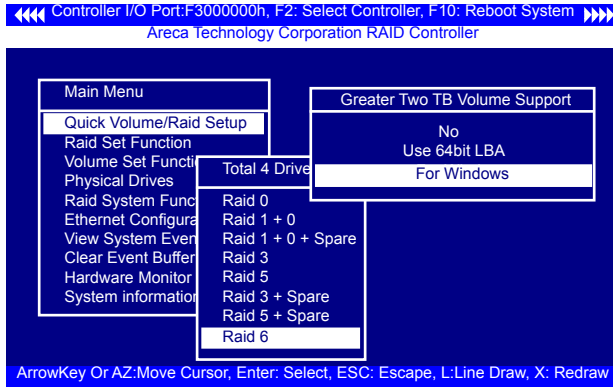

- **No**

It keeps the volume size with max. 2TB limitation.

- **LBA 64**

This option use 16 bytes CDB instead of 10 bytes. The maximum volume capacity up to 512TB.

This option works on different OS which supports 16 bytes CDB. such as :

Windows 2003 with SP1  
Linux kernel 2.6.x or latter

- **For Windows**

It change the sector size from default 512 Bytes to 4k Bytes. the maximum volume capacity up to 16TB.

This option works under Windows platform only. And it **CAN NOT** be converted to Dynamic Disk, because 4k sector size is not a standard format.

For more details please download PDF file from [ftp://ftp.areca.com.tw/RaidCards/Documents/Manual\\_Spec/Over2TB\\_050721.zip](ftp://ftp.areca.com.tw/RaidCards/Documents/Manual_Spec/Over2TB_050721.zip)



# BIOS CONFIGURATION

A single volume set is created and consumes all or a portion of the disk capacity available in this raid set. Define the capacity of volume set in the Available Capacity popup. The default value for the volume set, which is 100% of the available capacity, is displayed in the selected capacity. To enter a value less than the available capacity, type the new value and press the **Enter** key to accept this value. If the volume set uses only part of the RAID Set capacity, you can use the "**Create Volume Set**" option in the main menu to define additional volume sets.

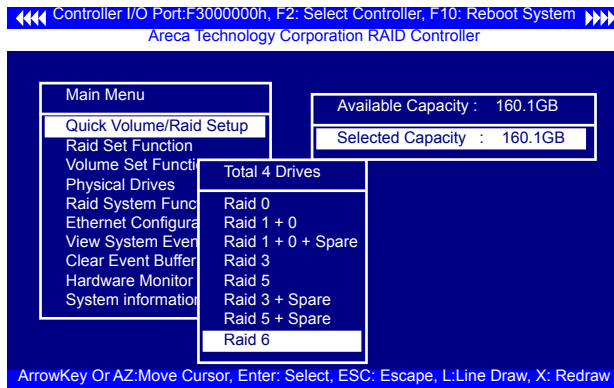

**Stripe size** This parameter sets the size of the stripe written to each disk in a RAID 0, 1, 5, or 6 logical drive. You can set the stripe size to 4 KB, 8 KB, 16 KB, 32 KB, 64 KB, or 128 KB. A larger stripe size produces better-read performance, especially if your computer does mostly sequential reads. However, if you

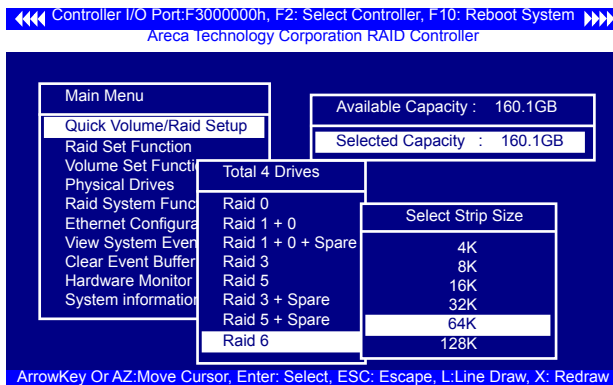

# BIOS CONFIGURATION

are sure that your computer performs random reads more often, select a smaller stripe size.

Press the **Yes** key in the "Create Vol/Raid" Set dialog box, the RAID set and volume set will start to initialize it.

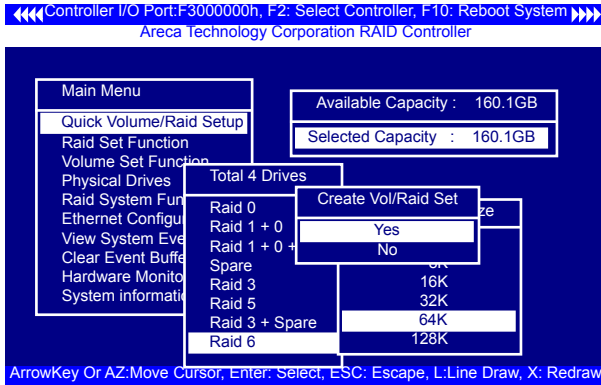

Select "Foreground (Faster Completion)" or "Background (Instant Available)" for initialization.

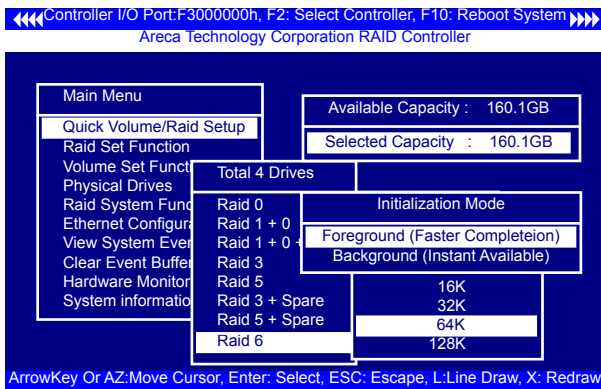

## 3.7.2 Raid Set Function

Manual Configuration gives complete control of the RAID set setting, but it will take longer to configure than "Quick Volume/Raid Setup" configuration. Select "Raid Set Function" to manually configure the raid set for the first time or delete existing RAID sets and reconfigure the RAID set.

# BIOS CONFIGURATION

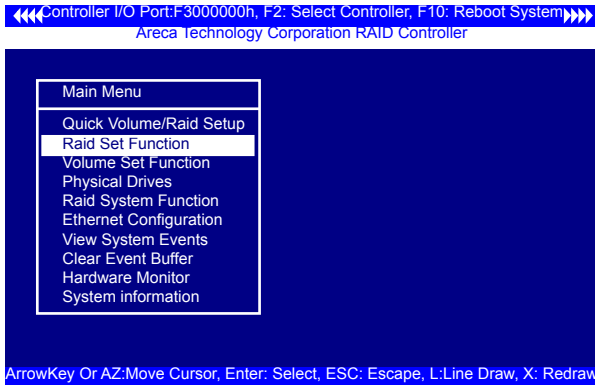

## 3.7.2.1 Create Raid Set

To define a RAID set, follow the procedure below:

1. Select "Raid Set Function" from the main menu.
2. Select "Create Raid Set " from the "Raid Set Function" dialog box.
3. A "Select SATA Drive For Raid set" window is displayed showing the SATA drives connected to the current controller. Press the **UP** and **DOWN** arrow keys to select specific physical drives. Press the Enter key to associate the selected physical drive with the current RAID Set. Repeat this step; the user can add as many disk drives as are available to a single RAID set.

When finished selecting SATA drives for RAID set, press the **Esc** key. A Create Raid Set confirmation screen appears, select the **Yes** option to confirm it.

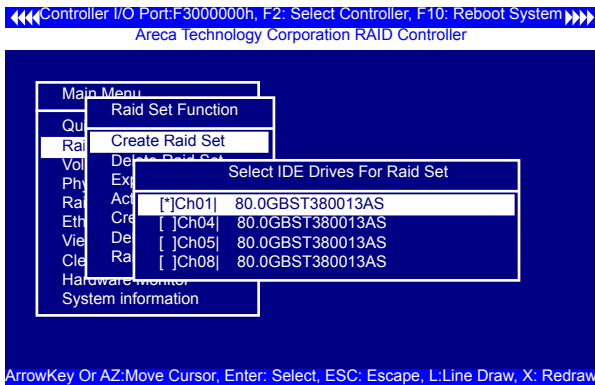

# BIOS CONFIGURATION

4. An "Edit The Raid Set Name" dialog box appears. Enter 1 to 15 alphanumeric characters to define a unique identifier for the RAID Set. The default RAID set name will always appear as Raid Set. #.

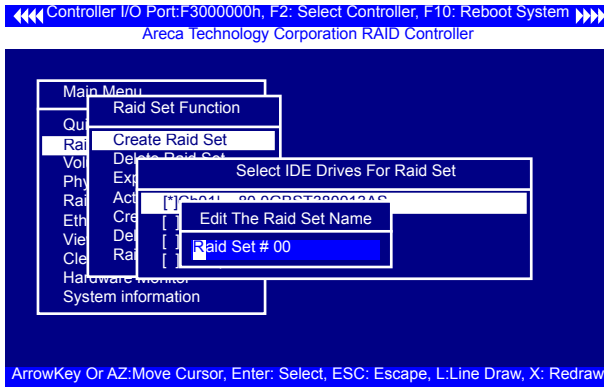

## 3.7.2.2 Delete Raid Set

To completely erase and reconfigure a RAID set, you must first delete it and re-create the raid set. To delete a raid set, select the raid set number that user want to delete in the "Select Raid Set to Delete" screen. The "Delete Raid Set" dialog box appears, then press **Yes** key to delete it. Warning, data on RAID set will be lost if this option is used.

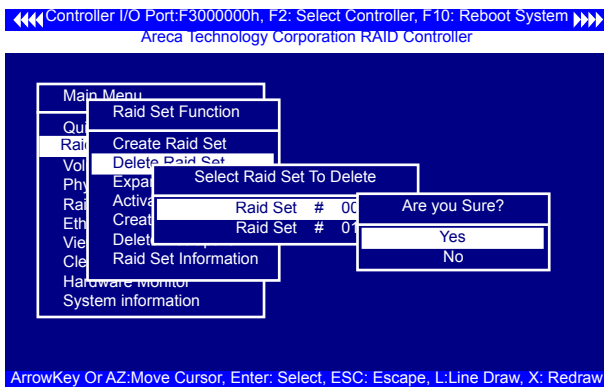

## 3.7.2.3 Expand Raid Set

Instead of deleting a RAID set and recreating it with additional

# BIOS CONFIGURATION

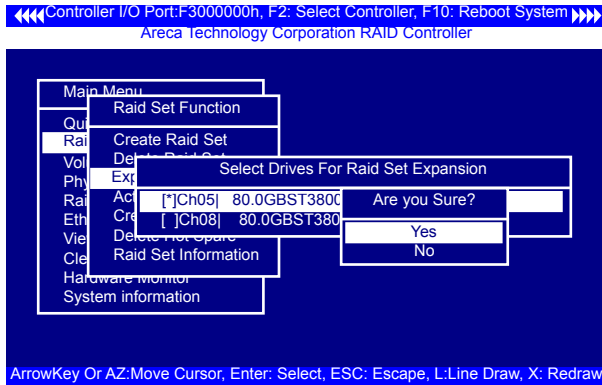

disk drives, the "Expand Raid Set" function allows the users to add disk drives to the RAID set that have already been created. To expand a raid set:

Select the "Expand Raid Set" option. If there is an available disk, then the "Select SATA Drives For Raid Set Expansion" screen appears.

Select the target RAID set by clicking on the appropriate radio button. Select the target disk by clicking on the appropriate check box.

Press the **Yes** key to start expansion of the RAID set.

The new additional capacity can be utilized by one or more volume sets. Follow the instruction presented in the volume set Function to modify the volume sets; operation system specific utilities may be required to expand operating system partitions.

## **Note:**

1. Once the Expand Raid Set process has started, user cannot stop it. The process must be completed.
2. If a disk drive fails during raid set expansion and a hot spare is available, an auto rebuild operation will occur after the RAID set expansion completes.

## ● Migrating

# BIOS CONFIGURATION

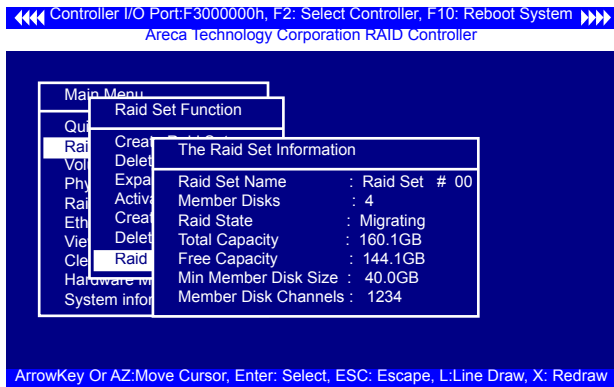

Migration occurs when a disk is added to a RAID set. Migration status is displayed in the raid status area of the Raid set information screen when a disk is being added to a Raid set. Migrating status is also displayed in the associated volume status area of the Volume Set Information when a disk is added to a RAID set.

### 3.7.2.4 Activate Incomplete Raid Set

The following screen is shows “Raid Set Information” after one of its disk drive was removed in the power off state.

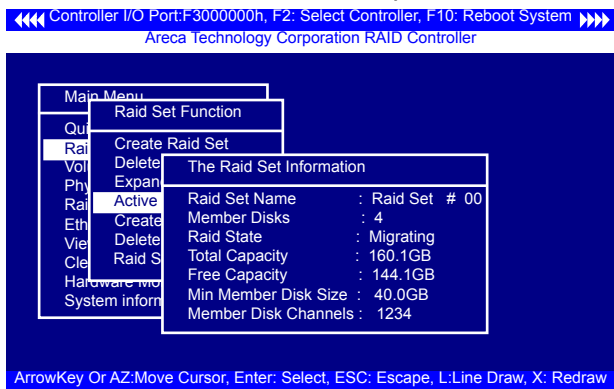

When one of the disk drives is removed in power off state, the Raid set state will change to Incomplete State. If a user wants to continue to work while the SATA RAID controller is powered on, the user can use the “Activate Raid Set” option to active the RAID set. After user selects this function, the Raid State will change to Degraded Mode.

# BIOS CONFIGURATION

## 3.7.2.5 Create Hot Spare

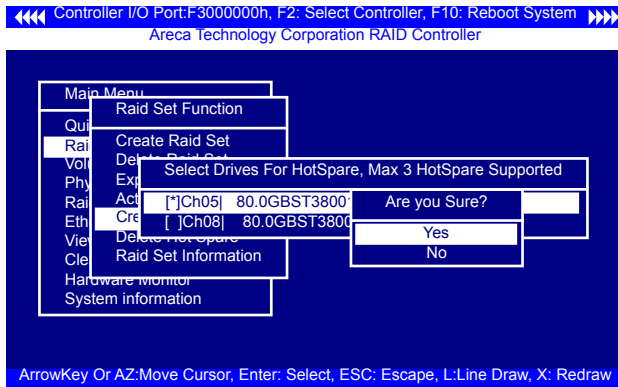

When you choose the "Create Hot Spare" option in the Raid Set Function, all unused physical devices connected to the current controller will result in the following:

Select the target disk by clicking on the appropriate check box. Press the **Enter** key to select a disk drive and press **Yes** in the "Create Hot Spare" to designate it as a hot spare.

The create Hot Spare option gives you the ability to define a global hot spare.

## 3.7.2.6 Delete Hot Spare

Select the target Hot Spare disk to delete by clicking on the appropriate check box.

Press the **Enter** keys to select a disk drive, and press **Yes** in the "Delete Hot Spare" window to delete the hot spare.

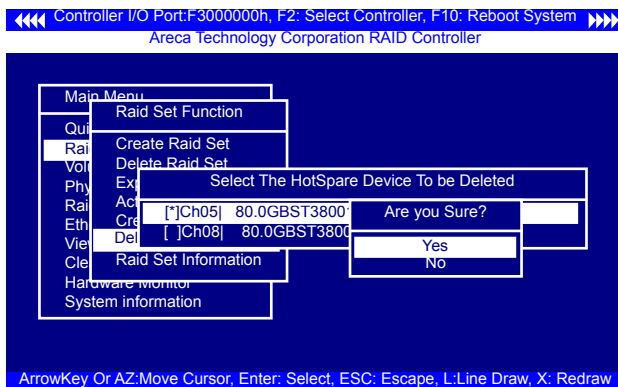

# BIOS CONFIGURATION

## 3.7.2.7 Raid Set Information

To display Raid Set information, move the cursor bar to the desired RAID set number, then press the **Enter** key. The "Raid Set Information" will display.

You can only view information for the RAID set in this screen.

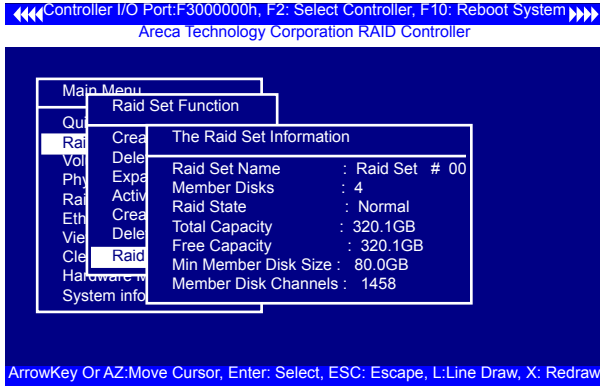

## 3.7.3 Volume Set Function

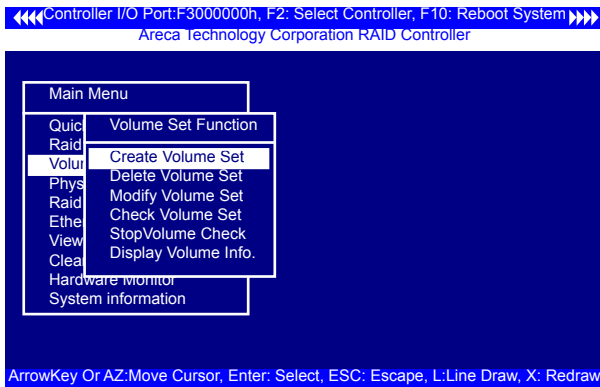

A volume set is seen by the host system as a single logical device; it is organized in a RAID level within the controller utilizing one or more physical disks. RAID level refers to the level of data performance and protection of a volume set. A volume set can consume all of the capacity or a portion of the available disk capacity of a RAID set. Multiple volume sets can exist on a RAID set. If multiple volume sets reside on a specified RAID set, all



# BIOS CONFIGURATION

volume sets will reside on all physical disks in the RAID set. Thus each volume set on the RAID set will have its data spread evenly across all the disks in the RAID set rather than one volume set using some of the available disks and another volume set using other disks.

## 3.7.3.1 Create Volume Set

1. Volume sets of different RAID levels may coexist on the same raid set.
2. Up to 16 volume sets in a RAID set can be created by the SATA RAID controller.
3. The maximum addressable size of a single volume set is not limited to 2 TB as with other cards that support only 32-bit mode.

To create a volume set, follow the following steps:

1. Select the "Volume Set Function" from the Main menu.
2. Choose the "Create Volume Set" from "Volume Set Functions" dialog box screen.

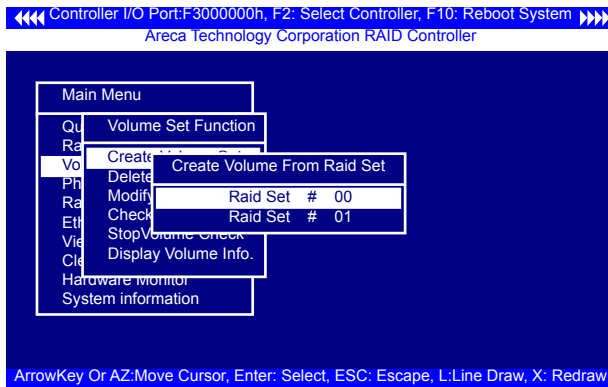

3. The "Create Volume From RAID Set" dialog box appears. This screen displays the existing arranged RAID sets. Select the RAID set number and press the **Enter** key. The "Volume Creation" dialogue is displayed in the screen.
4. A window with a summary of the current volume set's settings. The "**Volume Creation**" option allows user to select the volume name, capacity, RAID level, strip size, Disk Info, Cache mode and tag queuing. The user can modify the default values in this screen; the modification procedures are in section 3.5.3.3.

# BIOS CONFIGURATION

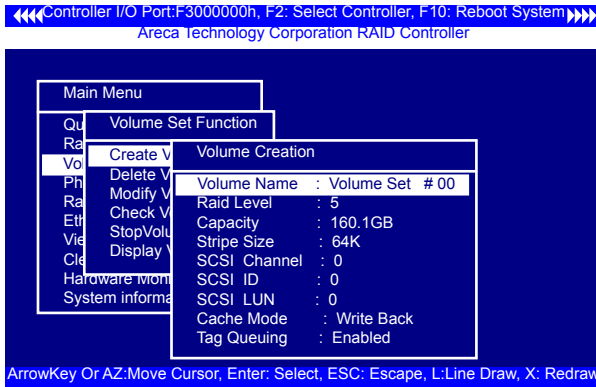

5. After completing the modification of the volume set, press the Esc key to confirm it. An "Initialization" screen is presented.
- Select Foreground (Faster Completion) for Faster Initialization of the selected volume set.
  - Select Background (Instant Available) for Normal Initialization of the selected volume set.

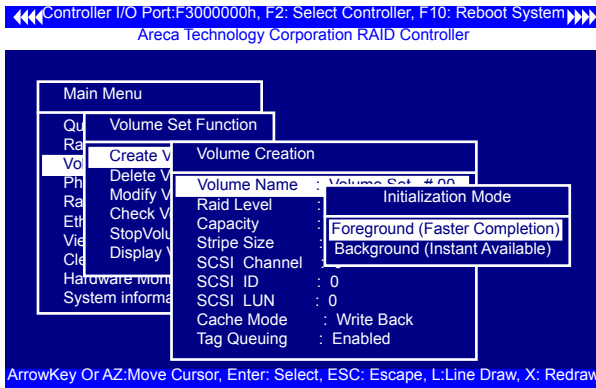

6. Repeat steps 3 to 5 to create additional volume sets.  
7. The initialization percentage of volume set will be displayed at the button line.

# BIOS CONFIGURATION

## ● Volume Name

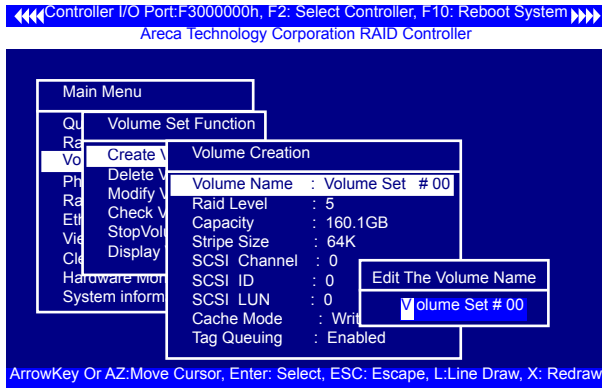

The default volume name will always appear as Volume Set #. You can rename the volume set providing it does not exceed the 15 characters limit.

## ● Raid Level

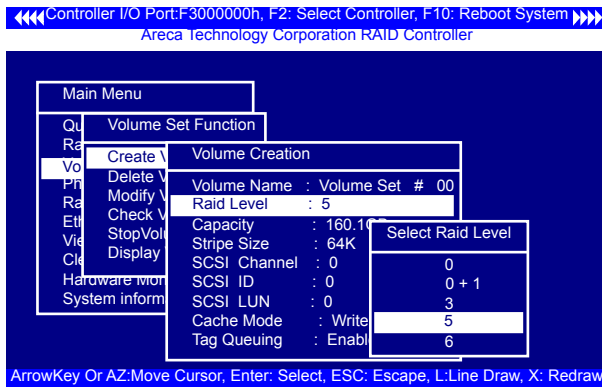

Set the RAID level for the volume set. Highlight Raid Level and press **<Enter>**. The available RAID levels for the current volume set are displayed. Select a RAID level and press the **Enter** key to confirm.

# BIOS CONFIGURATION

## • Capacity

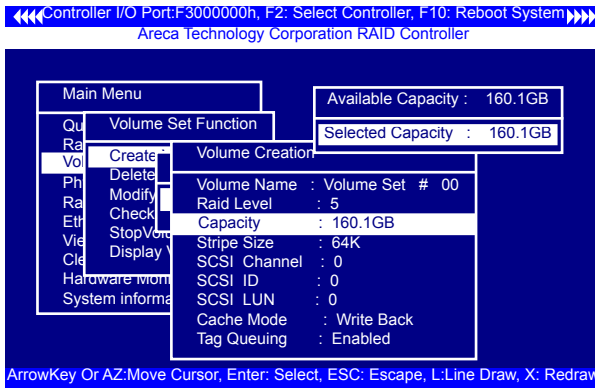

The maximum available volume size is the default value for the first setting. Enter the appropriate volume size to fit your application. The capacity value can be increased or decreased by the **UP** and **DOWN** arrow keys. The capacity of each volume set must be less than or equal to the total capacity of the RAID set on which it resides.

If volume capacity will exceed 2TB, controller will show the Greater 2 TB volume Support sub-menu.

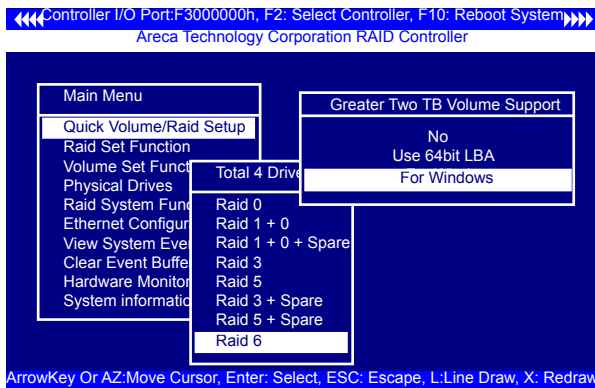

# BIOS CONFIGURATION

- **No**

It keeps the volume size with max. 2TB limitation.

- **LBA 64**

This option use 16 bytes CDB instead of 10 bytes. The maximum volume capacity up to 512TB.

This option works on different OS which supports 16 bytes CDB. such as :

Windows 2003 with SP1

Linux kernel 2.6.x or latter

- **For Windows**

It change the sector size from default 512 Bytes to 4k Bytes. the maximum volume capacity up to 16TB.

This option works under Windows platform only. And it **CAN NOT** be converted to Dynamic Disk, because 4k sector size is not a standard format.

For more details please download PDF file from [ftp://ftp.areca.com.tw/RaidCards/Documents/Manual\\_Spec/Over2TB\\_050721.zip](ftp://ftp.areca.com.tw/RaidCards/Documents/Manual_Spec/Over2TB_050721.zip)

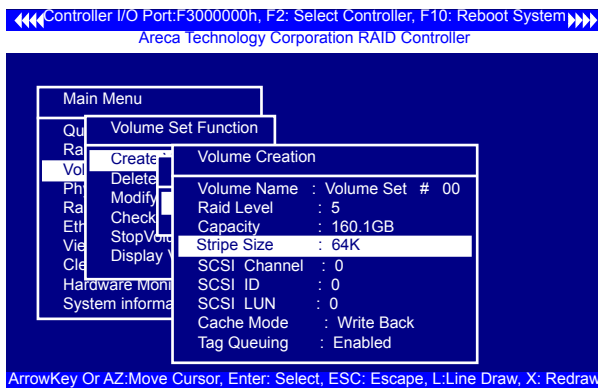

- **Strip Size**

This parameter sets the size of the segment written to each disk in a RAID 0, 1, 5, or 6 logical drive. You can set the stripe size to 4 KB, 8 KB, 16 KB, 32 KB, 64 KB, or 128 KB.

# BIOS CONFIGURATION

## • SCSI Channel

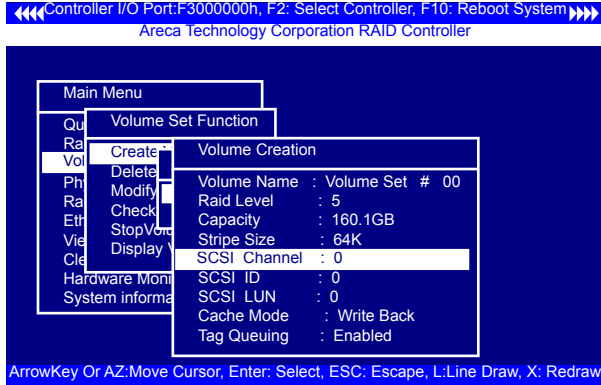

The SATA RAID controller function simulates a SCSI RAID controller. The host bus represents the SCSI channel. Choose the SCSI Channel. A "Select SCSI Channel" dialog box appears; select the channel number and press the **Enter** key to confirm it.

## • SCSI ID

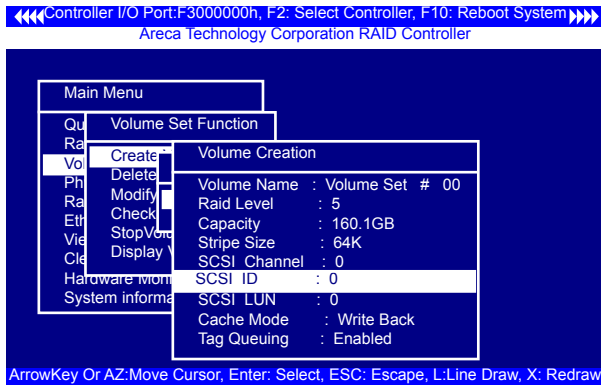

Each device attached to the SATA card, as well as the card itself, must be assigned a unique SCSI ID number. A SCSI channel can connect up to 15 devices. It is necessary to assign a SCSI ID to each device from a list of available SCSI IDs.

# BIOS CONFIGURATION

## • SCSI LUN

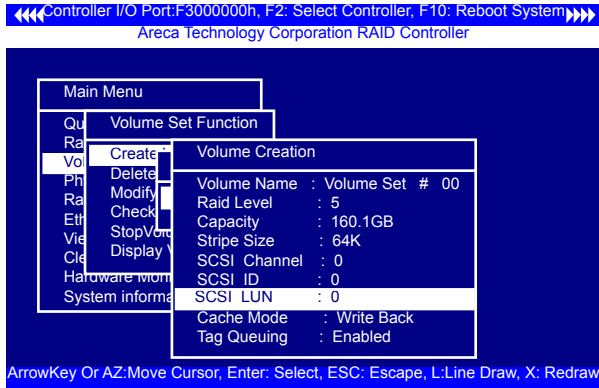

Each SCSI ID can support up to 8 LUNs. Most SCSI controllers treat each LUN as if it were a SCSI disk.

## • Cache Mode

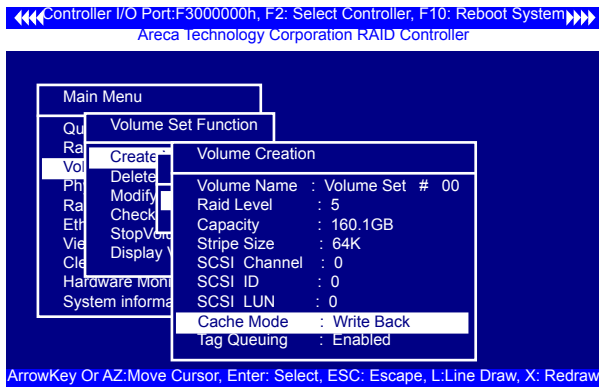

User can set the cache mode to either "Write-Through Cache" or "Write-Back Cache".

# BIOS CONFIGURATION

## • Tag Queuing

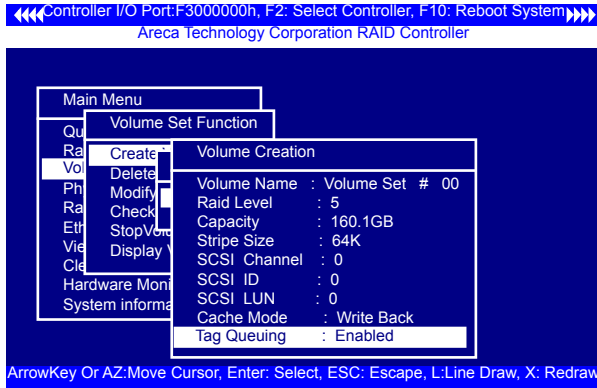

This option, when enabled, can enhance overall system performance under multi-tasking operating systems. The Command Tag (Drive Channel) function controls the SCSI command tag queuing support for each drive channel. This function should normally remain enabled. Disable this function only when using older drives that do not support command tag queuing.

### 3.7.3.2 Delete Volume Set

To delete volume set from a RAID set, move the cursor bar to the "Volume Set Functions" menu and select the "Delete Volume Set" item, then press the **Enter** key. The "Volume Set Functions" menu will show all Raid Set # items. Move the cursor bar to a RAID set number, then press the **Enter** key to show all volume sets within that Raid Set. Move the cursor to the volume set number that is to be deleted and press **Enter** to delete it.

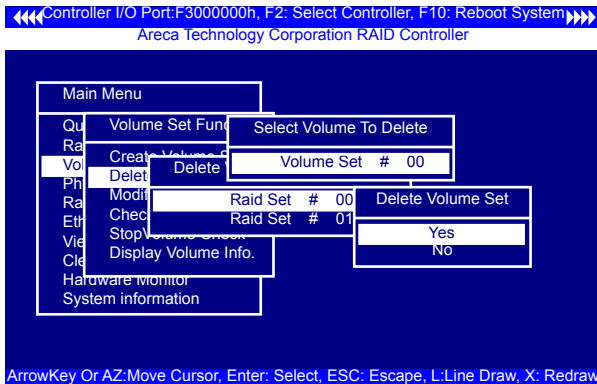



# BIOS CONFIGURATION

## 3.7.3.3 Modify Volume Set

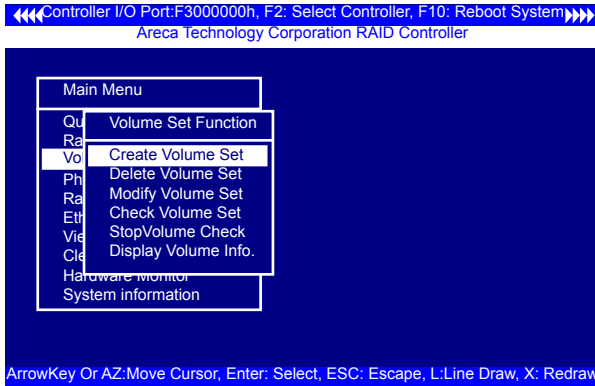

Use this option to modify volume set configuration. To modify volume set values from RAID set system function, move the cursor bar to the "Volume Set Functions" menu and select the "Modify Volume Set" item, then press the **Enter** key. The "Volume Set Functions" menu will show all RAID set items. Move the cursor bar to a RAID set number item, then press the **Enter** key to show all volume set items. Select the volume set from the list to be changed, press the **Enter** key to modify it.

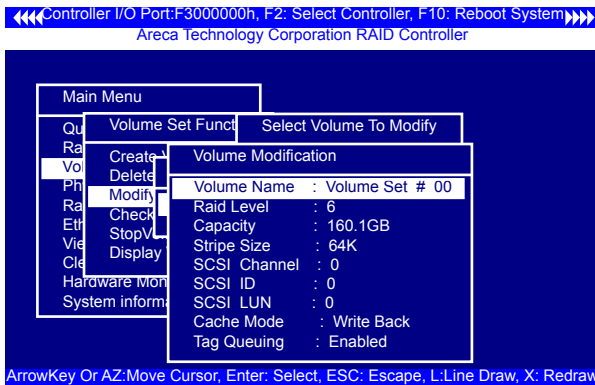

As shown, volume information can be modified at this screen. Choose this option to display the properties of the selected volume set; all values can be modified except the capacity.

# BIOS CONFIGURATION

## ● Volume Growth

Use this option to expand a raid set when a disk is added to the system. The additional capacity can be used to enlarge the volume set size or to create another volume set. The "Modify Volume Set Function" can support the "volume set expansion" function. To expand the volume set capacity from the "Raid Set System Function", move the cursor bar to the "Volume Set Volume Capacity" item and enter the capacity size. Select "Confirm The Operation" and select on the "Submit" button to complete the action. The volume set starts to expand.

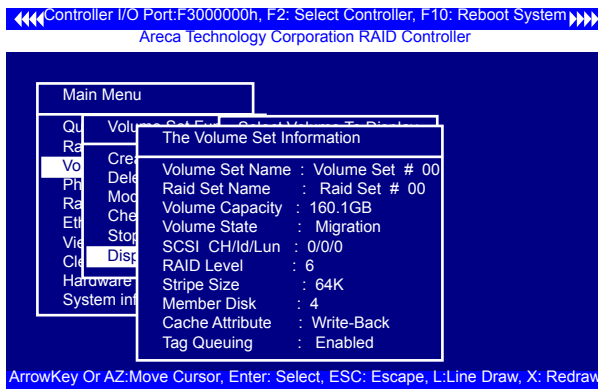

### To Expand an existing volume noticed:

- Only the last volume can expand capacity.
- When expand volume capacity, you can't modify stripe size or modify raid level simultaneously.
- You can expand volume capacity, but can't reduce volume capacity size.

### For Greater 2TB expansion:

- If your system installed in the volume, don't expanded the volume capacity greater 2TB, currently OS can't support boot up from a greater 2TB capacity device.
- Expanded over 2TB used LBA64 mode. Please make sure your OS supports LBA 64 before expand it.

# BIOS CONFIGURATION

## • Volume Set Migration

Migrating occurs when a volume set is migrating from one RAID level to another, when a volume set strip size changes, or when a disk is added to a RAID set. Migration status is displayed in the volume status area of the "Volume Set Information" screen when moving from one RAID level to another, when a volume set strip size changes, or when a disk is added to a RAID set.

### 3.7.3.4 Check Volume Set

Use this option to verify the correctness of the redundant data in a volume set. For example, in a system with a dedicated parity disk drive, a volume set check entails computing the parity of the data disk drives and comparing those results to the contents of the dedicated parity disk drive. To check volume set from "Raid Set System Function", move the cursor bar to the "Volume Set Functions" menu and select the "Check Volume Set" item, then press the **Enter** key. The "Volume Set Functions" menu will show all Raid Set number items. Move the cursor bar to an Raid Set number item and then press the **Enter** key to show all Volume Set items. Select the volume set to be checked from the list and press **Enter** to select it. After completing the selection, the confirmation screen appears, presses **Yes** to start the check.

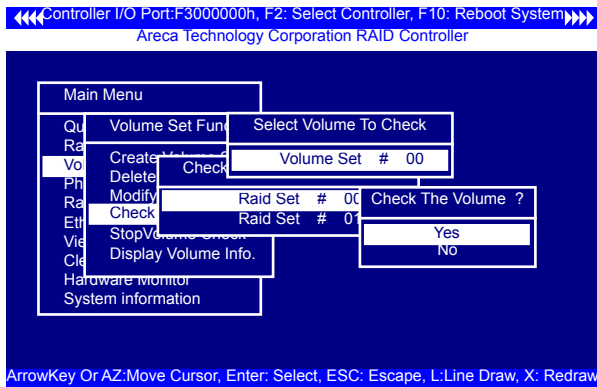

### 3.7.3.5 Stop Volume Set Check

Use this option to stop all of the "Check Volume Set" operations.

# BIOS CONFIGURATION

## 3.7.3.6 Display Volume Set Info.

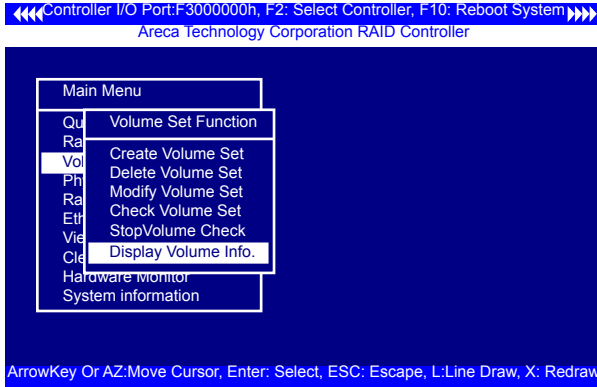

To display volume set information, move the cursor bar to the desired volume set number and then press the **Enter** key. The “Volume Set Information” will be shown. You can only view the information of this volume set in this screen, not modify it.

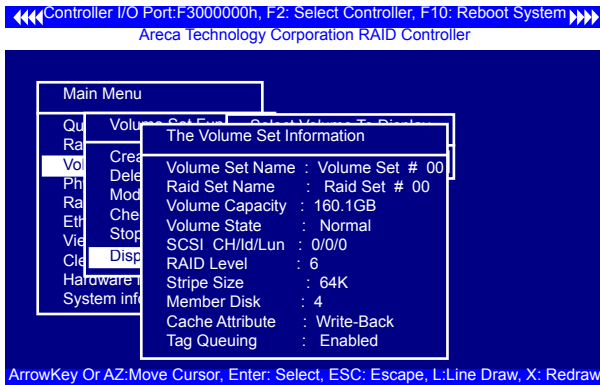

# BIOS CONFIGURATION

## 3.7.4 Physical Drives

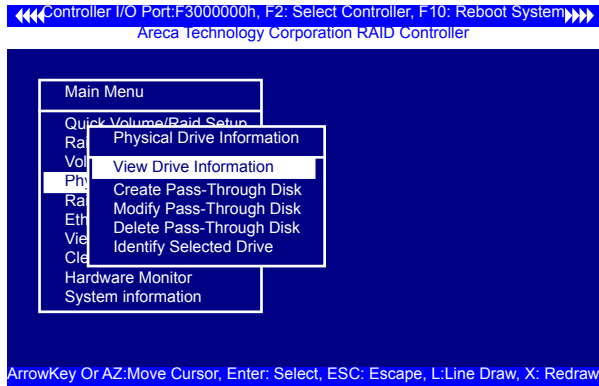

Choose this option from the Main Menu to select a physical disk and perform the operations listed above.

### 3.7.4.1 View Drive Information

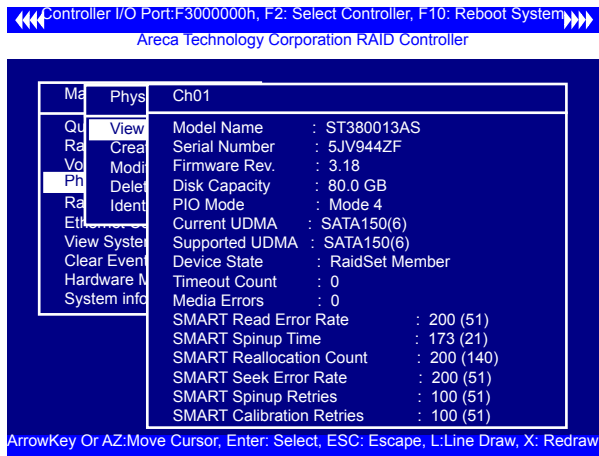

# BIOS CONFIGURATION

When you choose this option, the physical disks connected to the SATA RAID controller are listed. Move the cursor to the desired drive and press **Enter** to view drive information.

## 3.7.4.2 Create Pass-Through Disk

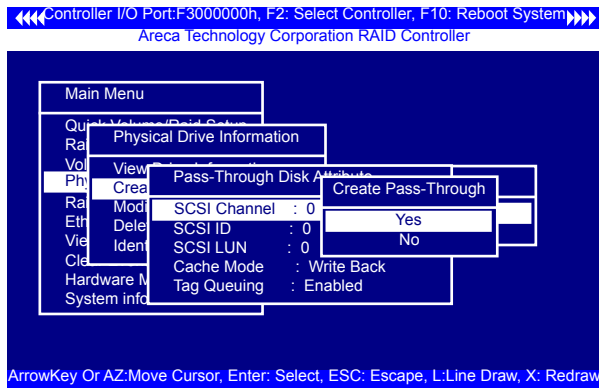

A Pass-Through Disk is not controlled by the SATA RAID controller firmware and thus cannot be a part of a volume set. The disk is available directly to the operating system as an individual disk. It is typically used on a system where the operating system is on a disk not controlled by the SATA RAID controller firmware. The SCSI Channel, SCSI ID, SCSI LUN, Cache Mode, and Tag Queuing must be specified to create a pass-through disk.

## 3.7.4.3 Modify a Pass-Through Disk

Use this option to modify Pass-Through Disk Attributes. To select and modify a Pass-Through Disk from the pool of Pass-Through Disks, move the cursor bar to the "Physical Drive Function" menu and select the "Modify Pass-Through Drive" option and then press the **Enter** key. The "Physical Drive Function" menu will show all Raid Pass-Through Drive number options. Move the cursor bar to the desired item and then press the **Enter** key to show all Pass-Through Disk Attributes. Select the parameter from the list to be changed and then press the **Enter** key to modify it.

# BIOS CONFIGURATION

## 3.7.4.4 Delete Pass-Through Disk

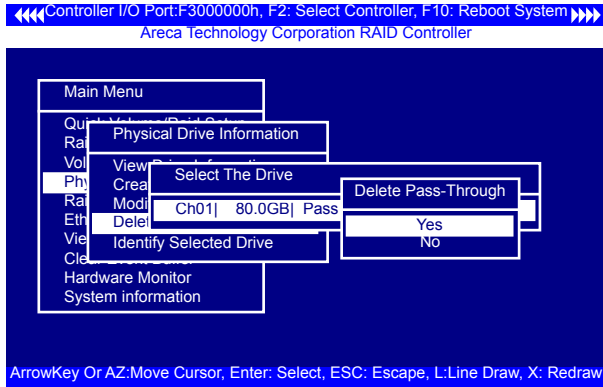

To delete a Pass-through drive from the Pass-through drive pool, move the cursor bar to the "Physical Drive Function" menu and select the "Delete Pass-Through Drive" item, then press the **Enter** key. The "Delete Pass-Through confirmation" screen will appear; select **Yes** to delete it.

## 3.7.4.5 Identify Selected Drive

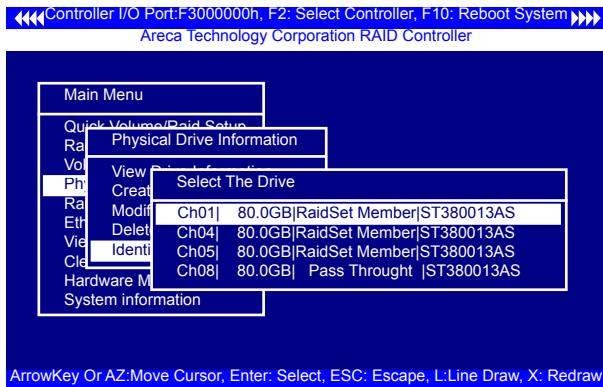

To prevent removing the wrong drive, the selected disk HDD LED Indicator will light for physically locating the selected disk when the "Identify Selected Device" is selected.

# BIOS CONFIGURATION

## 3.7.5 Raid System Function

To set the raid system function, move the cursor bar to the main menu and select the "Raid System Function" item and then press **Enter** key. The "Raid System Function" menu will show multiple items. Move the cursor bar to an item, then press **Enter** key to select the desired function.

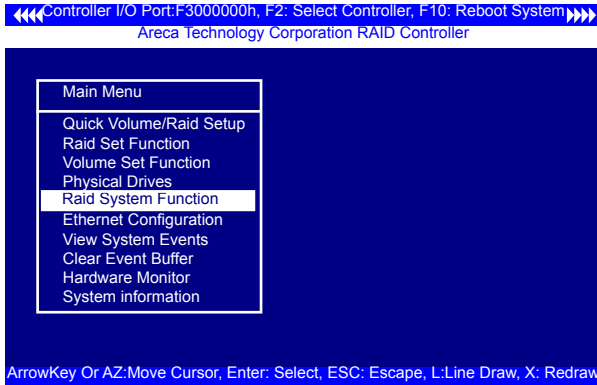

### 3.7.5.1 Mute The Alert Beeper

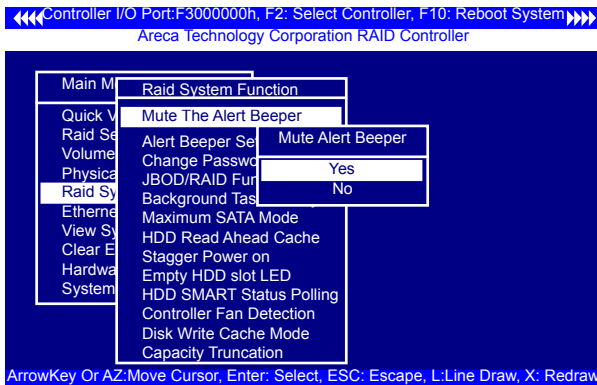

The "Mute The Alert Beeper" function item is used to control the SATA RAID controller Beeper. Select **yes** and press the **Enter** key in the dialog box to turn the beeper off temporarily. The beeper will still activate on the next event.



# BIOS CONFIGURATION

## 3.7.5.2 Alert Beeper Setting

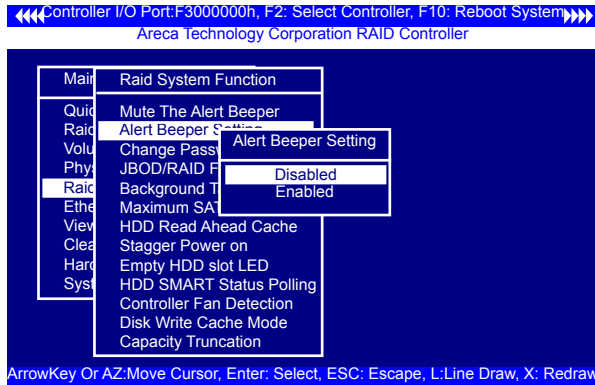

The "Alert Beeper Setting" item is used to Disabled or Enable the SATA RAID controller alarm tone generator. Select "Disabled" and press the **Enter** key in the dialog box to turn the beeper off.

## 3.7.5.3 Change Password

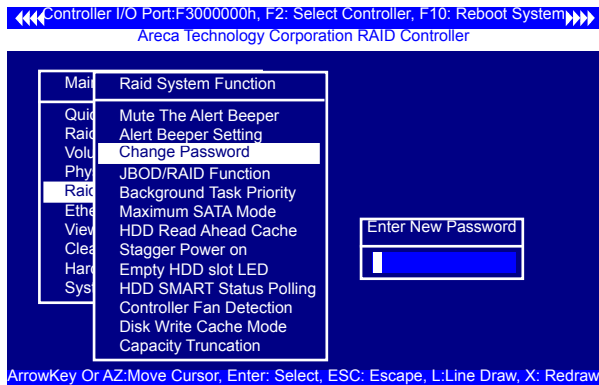

**The manufacture default password is set to 0000.** The password option allows user to set or clear the password protection feature. Once the password has been set, the user can monitor and configure the controller only by providing the cor-

# BIOS CONFIGURATION

rect password. This feature is used to protect the internal RAID system from unauthorized access. The controller will check the password only when entering the Main menu from the initial screen. The system will automatically go back to the initial screen if it does not receive any command in 20 seconds. To set or change the password, move the cursor to "Raid System Function" screen, press the "Change Password" item. The "Enter New Password" screen will appear. To disable the password, only press **Enter** in both the "Enter New Password" and "Re-Enter New Password" column. The existing password will be cleared. No password checking will occur when entering the main menu.

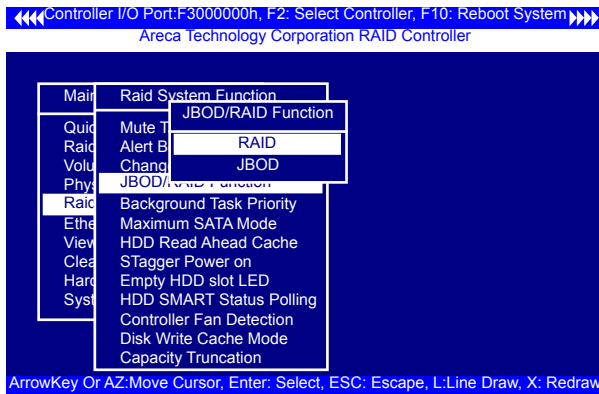

## 3.7.5.4 JBOD/RAID Function

JBOD is an acronym for "**just a Bunch Of Disks**". It represents a volume set that is created by the concatenation of partitions on the disk. The operating system can see all disks when the JBOD option is selected. It is necessary to delete any RAID set(s) on any disk(s) if switching from a **RAID** to a **JBOD** configuration.

# BIOS CONFIGURATION

## 3.7.5.5 Background Task Priority

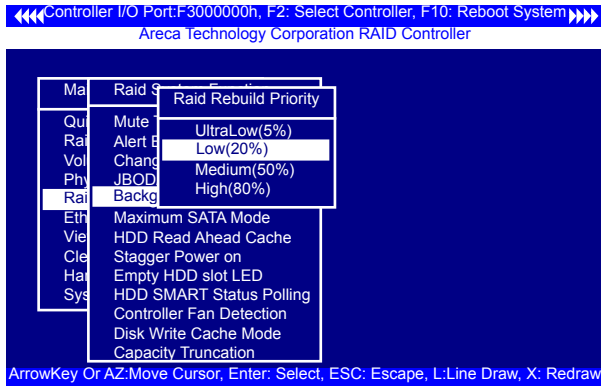

The “**Background Task Priority**” is a relative indication of how much time the controller devotes to a rebuild operation. The SATA RAID controller allows the user to choose the rebuild priority (ultralow, low, normal, high) to balance volume set access and rebuild tasks appropriately.

## 3.7.5.6 Maximum SATA Mode

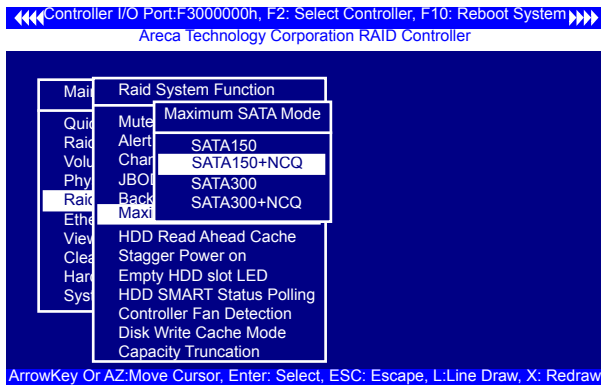

The SATA RAID controller can support up to SATA II, which runs up to 300MB/s, twice as fast as SATA150. NCQ is a command protocol in Serial ATA that can only be implemented on native Serial ATA hard drives. It allows multiple commands to be outstanding within a drive at the same time. Drives that support NCQ have an internal queue where outstanding commands can

# BIOS CONFIGURATION

be dynamically rescheduled or re-ordered, along with the necessary tracking mechanisms for outstanding and completed portions of the workload. The SATA RAID controller allows the user to choose the SATA Mode: SATA150, SATA150+NCQ, SATA300, SATA300+NCQ.

## 3.7.5.7 HDD Read Ahead Cache

Allow Read Ahead (Default: Enabled)—When Enabled, the drive's read ahead cache algorithm is used, providing maximum performance under most circumstances.

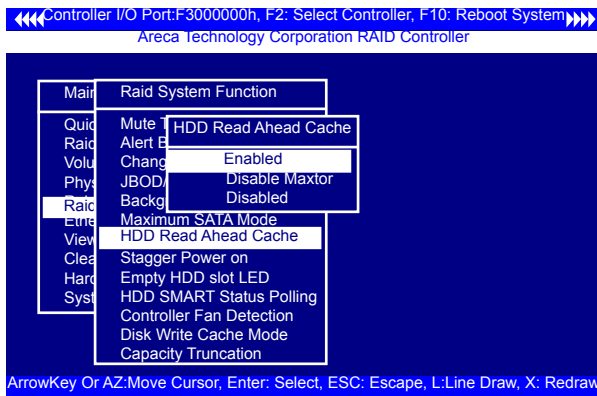

## 3.7.5.8 Stagger Power On

In a PC system with only one or two drives, the power can supply enough power to spin up both drives simultaneously. But in systems with more than two drives, the startup current from spinning up the drives all at once can overload the power supply, causing damage to the power supply, disk drives and other system components. This damage can be avoided by allowing the host to stagger the spin-up of the drives. New SATA drives have support staggered spin-up capabilities to boost reliability. Staggered spin-up is a very useful feature for managing multiple disk drives in a storage subsystem. It gives the host the ability to spin up the disk drives sequentially or in groups, allowing the drives to come ready at the optimum time without straining the system power supply. Staggering drive spin-up in a multiple drive environment also avoids the extra cost of a power supply designed to meet short-term startup power demand as well as steady state conditions.

# BIOS CONFIGURATION

Areca has supported the fixed value staggered power up function in its previous version firmware. But from firmware version 1.39 and later, SATA RAID controller has included the option for customer to select the disk drives sequentially stagger power up value. The values can be selected from 0.4ms to 6ms per step which powers up one drive.

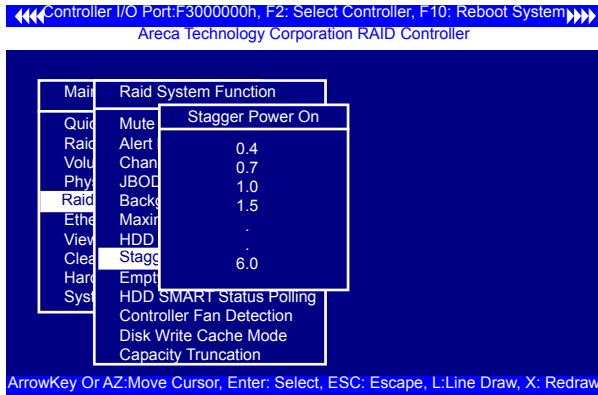

## 3.7.5.9 Empty HDD slot HDD

From firmware version 1.39 date: 04/01/2006 and later, the firmware has added the "Empty HDD Slot LED" option to setup the Failed LED light "ON" or "OFF". When each slot has a power LED for the HDD installed identify, user can set this option to "OFF". Choose this option "ON", the failed LED light will flash red light; if no HDD installed.

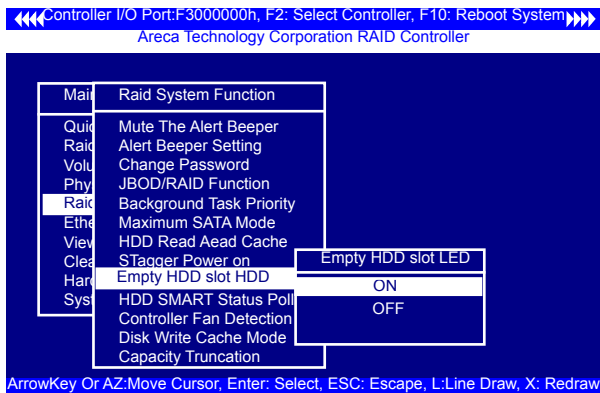

# BIOS CONFIGURATION

## 3.7.5.10 HDD SMART Status Polling

An external RAID enclosure has the hardware monitor in the dedicated backplane that can report HDD temperature status to the controller. However, PCI cards do not use backplanes if the drives are internal to the main server chassis. The type of enclosure cannot report the HDD temperature to the controller. For this reason, HDD SMART Status Polling was added to enable scanning of the HDD temperature function in the version 1.36 date: 2005-05-19 (and later). It is necessary to enable "HDD SMART Status Polling" function before SMART information is accessible. This function is disabled by default. The following screen shot shows how to change the BIOS setting to enable the Polling function.

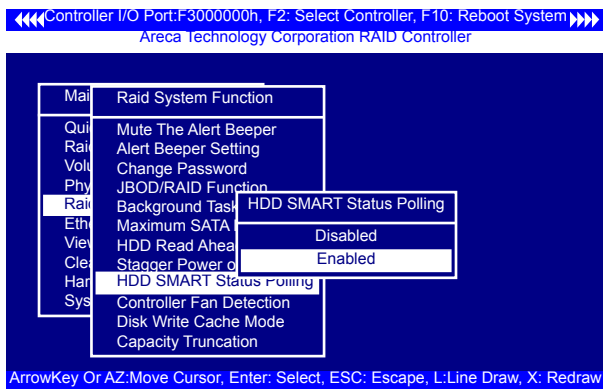

## 3.7.5.11 Controller Fan Detection

Included in the product box is a field replaceable passive heatsink to be used only if there is enough airflow to adequately cool the passive heat sink.

The "Controller Fan Detection" function is available in the version 1.36 date: 2005-05-19 and later for preventing the Buzzer warning. When using the passive heatsink, disable the "Controller Fan Detection" function through this BIOS setting.

The following screen shot shows how to change the BIOS setting to disable the beeper function. **(This function is not available in the Web Browser setting.)**

# BIOS CONFIGURATION

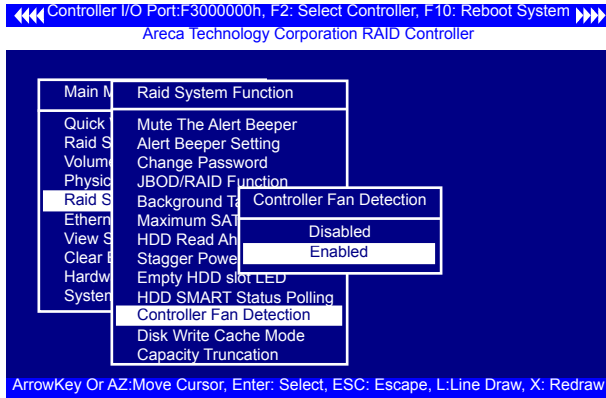

## 3.7.5.12 Disk Write Cache Mode

User can set the “Disk Write Cache Mode” to Auto, Enabled, or Disabled. Enabled increases speed, Disabled increases reliability.

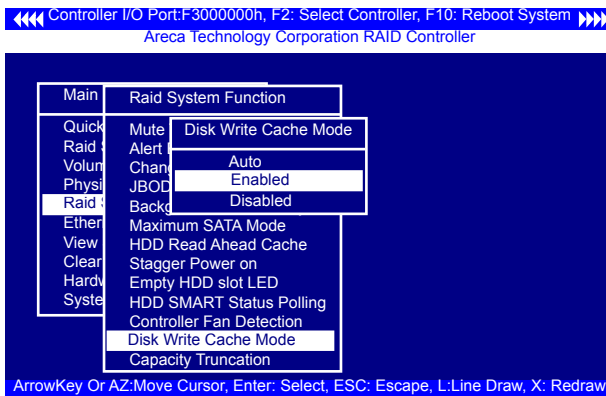

## 3.7.5.13 Capacity Truncation

SATA RAID controllers use drive truncation so that drives from different vendors are more likely to be usable as spares for one another. Drive truncation slightly decreases the usable capac-

# BIOS CONFIGURATION

ity of a drive that is used in redundant units. The controller provides three truncation modes in the system configuration: Multiples Of 10G, Multiples Of 1G, and No Truncation.

**Multiples Of 10G:** If you have 120 GB drives from different vendors; chances are that the capacity varies slightly. For example, one drive might be 123.5 GB, and the other 120 GB. Areca drive Truncation mode **Multiples Of 10G** uses the same capacity for both of these drives so that one could replace the other.

**Multiples Of 1G:** If you have 123 GB drives from different vendors; chances are that the capacity varies slightly. For example, one drive might be 123.5 GB, and the other 123.4 GB. Areca drive Truncation mode **Multiples Of 1G** uses the same capacity for both of these drives so that one could replace the other.

**No Truncation:** It does not truncate the capacity.

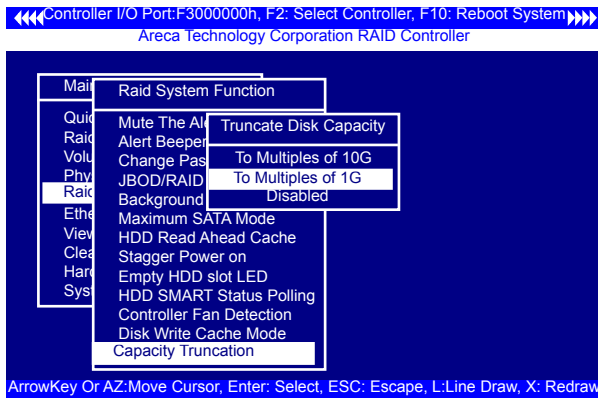

## 3.7.6 Ethernet Configuration (12/16/24-port)

Use this feature to set the controller Ethernet port configuration. It is not necessary to create reserved disk space on any hard disk for the Ethernet port and HTTP service to function; these functions are built into the controller firmware.



# BIOS CONFIGURATION

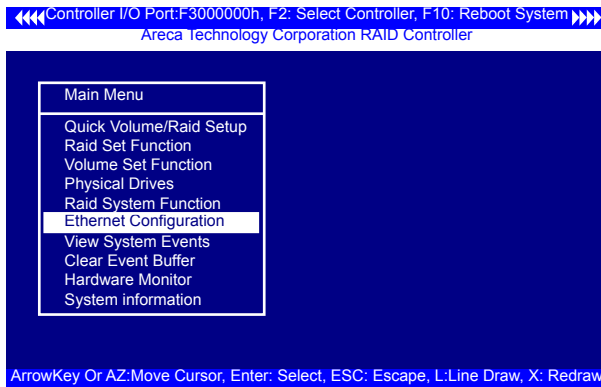

## 3.7.6.1 DHCP Function

DHCP (Dynamic Host Configuration Protocol) allows network administrators centrally manage and automate the assignment of IP (Internet Protocol) addresses on a computer network. When using the TCP/IP protocol (Internet protocol), it is necessary for a computer to have a unique IP address in order to communicate to other computer systems. Without DHCP, the IP address must be entered manually at each computer system. DHCP lets a network administrator supervise and distribute IP addresses from a central point. The purpose of DHCP is to provide the automatic (dynamic) allocation of IP client configurations for a specific time period (called a lease period) and to minimize the work necessary to administer a large IP network. To manually

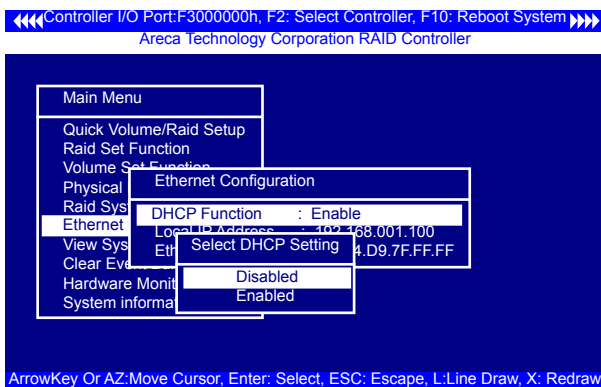

# BIOS CONFIGURATION

configure the IP address of the controller, move the cursor bar to the Main menu "Ethernet Configuration Function" item and then press the **Enter** key. The "Ethernet Configuration" menu appears on the screen. Move the cursor bar to DHCP Function item, then press **Enter** key to show the DHCP setting. Select the "Disabled" or "Enabled" option to enable or disable the DHCP function. If DHCP is disabled, it will be necessary to manually enter a static IP address that does not conflict with other devices on the network.

## 3.7.6.2 Local IP address

If you intend to set up your client computers manually (no DHCP), make sure that the assigned IP address is in the same range as the default router address and that it is unique to your private network. However, it is highly recommend to use DHCP if that option is available on your network. An IP address allocation scheme will reduce the time it takes to set-up client computers and eliminate the possibilities of administrative errors and duplicate addresses. To manually configure the IP address of the controller, move the cursor bar to the Main menu Ethernet Configuration Function item and then press the **Enter** key. The Ethernet Configuration menu appears on the screen. Move the cursor bar to Local IP Address item, then press the **Enter** key to show the default address setting in the SATA RAID controller. You can then reassign the static IP address of the controller.

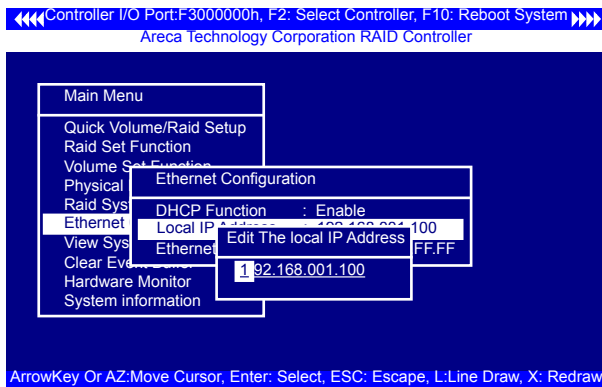

# BIOS CONFIGURATION

## 3.7.6.3 Ethernet Address

A MAC address stands for “Media Access Control” address and is unique to every single ethernet device. On an Ethernet LAN, it’s the same as your Ethernet address. When you’re connected to a local network from the SATA RAID controller Ethernet port, a correspondence table relates your IP address to the SATA RAID controller’s physical (MAC) address on the LAN.

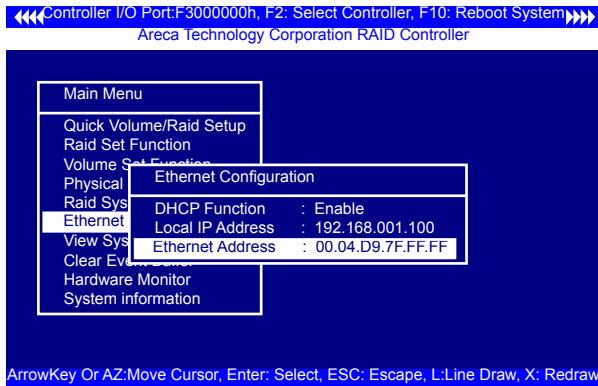

## 3.7.7 View System Events

To view the SATA RAID controller’s information, move the cursor bar to the main menu and select the “View Events” link, then press the **Enter** key. The SATA RAID controller’s events screen appear.

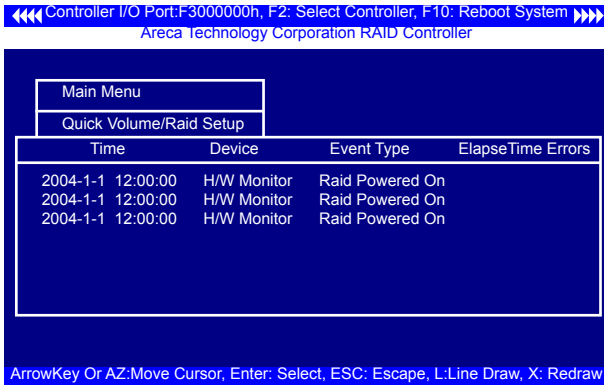

# BIOS CONFIGURATION

Choose this option to view the system events information: Timer, Device, Event type, Elapsed Time, and Errors. The RAID system does not have a real time clock. The Time information is the relative time from the SATA RAID controller powered on.

## 3.7.8 Clear Events Buffer

Use this feature to clear the entire events buffer.

## 3.7.9 Hardware Monitor

To view the RAID controller's hardware monitor information, move the mouse cursor to the main menu and click the "Hardware Monitor" link. The Hardware Information screen appears.

The Hardware Monitor Information provides the temperature and fan speed (I/O Processor fan) of the SATA RAID controller.

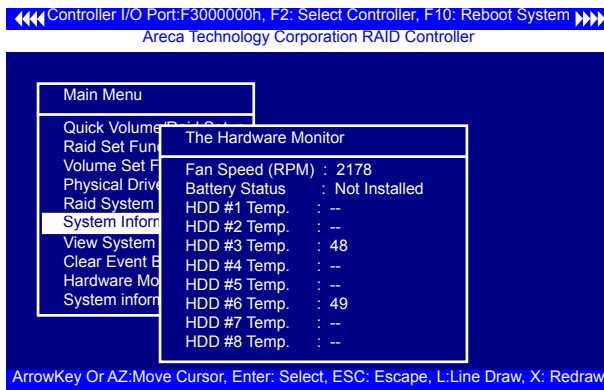

## 3.7.10 System Information

Choose this option to display Main processor, CPU Instruction cache and data cache size, firmware version, serial number, controller model name, and the cache memory size. To check the system information, move the cursor bar to "System Information"

# BIOS CONFIGURATION

item, then press **Enter** key. All relevant controller information will be displayed.

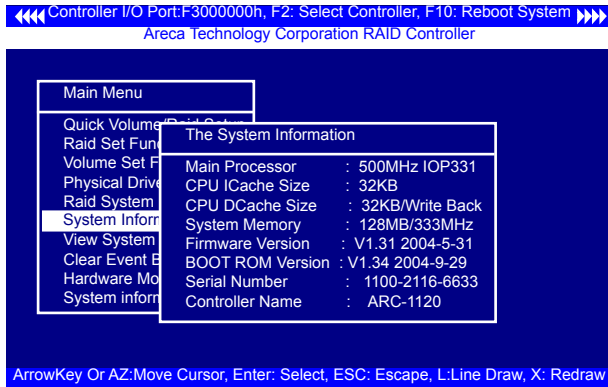

# DRIVER INSTALLATION

---

## 4. Driver Installation

This chapter describes how to install the SATA RAID controller driver to your operating system. The installation procedures use the following terminology:

### **Installing operating system on the SATA Volume**

If you have a new drive configuration without an operating system and want to install operating system on a disk drive managed by the SATA RAID Controller. The driver installation is a part of the operating system installation.

### **Installing SATA RAID controller into an existing operating system**

The computer has an existing operating system installed and the SATA RAID controller is being installed as a secondary controller.

Have all required system hardware and software components on hand before proceeding with the setup and installation.

Materials required:

- Microsoft Windows 2000/XP/2003, Linux, FreeBSD or more installation CD-ROM
- SATA RAID Controller Diver CD-ROM
- SATA RAID controller

### **4.1 Creating the Driver Diskettes**

The CD-ROM disc shipped with the SATA RAID controller is a self-booting CD. In order to created driver diskettes for Windows, Linux, FreeBSD or more installation drivers, your system is required to support booting from the CD-ROM.

If you do not have the CD-ROM disc with the package, contact your local dealer or you can also download the latest version drivers for Windows 2000/XP/2003, Linux, freeBSD and more from the ARECA web site at <http://www.areca.com.tw>

# DRIVER INSTALLATION

---

The following steps are required to create the driver diskettes:

1. The computer system BIOS must be set to boot-up from the CD-ROM.
2. Insert the SATA Controller Driver CD disc into the CD-ROM drive.
3. The system will boot-up from CD-ROM Drive; to create the driver diskettes, select the "**SATA RAID controller Driver Diskette Make Utility**", and a screen with several choices will be displayed.
4. Move the highlight bar to the "**Create Driver Disk**" entry and press **Enter**.
5. The screen queries the SATA RAID controller support driver database and displays a list of available drivers. Move the highlight bar to the correct driver entry and press **Enter** to select.
6. The next screen will show "**Please insert a formatted diskette into drive A:!! Press any key to continue**". Insert the formatted diskette in drive "**A**" and press any key to continue.
7. The window will display the driver building message: "**Now is writing to Cylinder...**" as it copies the image file from the CD-ROM to Driver Diskette.
8. The "**Write Complete !!**" message will display when the driver diskette ready.

The driver diskette is now made. Proceed to the following instruction for installation procedures.

## 4.2 Driver Installation for Windows

The SATA RAID controller can be used with Microsoft Windows 2000, Windows XP, and Windows Server 2003. Windows 2003 64-bit for AMD Opteron is also supported. The SATA RAID controllers support SCSI Miniport and StorPort Drivers for Windows Server 2003.

### 4.2.1 New Storage Device Drivers in Windows Server 2003

# DRIVER INSTALLATION

---

The Storport driver is new to Windows Server 2003. Storport implements a new architecture designed for better performance with RAID systems and in Storage Area Network (SAN) environments. Storport delivers higher I/O throughput, enhanced manageability, and an improved miniport interface. Storport better utilizes faster adapters through the use of reduced Delay Procedure Call (DPC) and improved queue management.

## 4.2.2 Install Windows 2000/XP/2003 on a SATA RAID Volume

The following instructions explain how to install the SATA RAID controller Driver. For completed details on installing Windows, see the Windows User's Manual.

### 4.2.2.1 Installation procedures

The following procedures detail installing the SATA RAID controller driver while installing Windows 2000/XP/2003. Have your bootable Microsoft Windows 2000/XP/2003 CD-ROM and follow the required procedure below to install SATA RAID controller:

1. Make sure you follow the instructions in Chapter 2 "**Hardware Installation**" to install the controller and connect the disk drives or enclosure.
2. Start the system and then press Tab+F6 to access the McBIOS RAID manager. Use the McBIOS manager to create the RAID set and volume set to which you will install Windows. For details, see Chapter 3 "**McBIOS RAID manager**". Once a volume set is created and configured, continue with next step to install the operating system.
3. Insert the Windows setup CD and reboot the system to begin the Windows installation.

#### **Note:**

The computer system BIOS must support bootable from CD-ROM.



# DRIVER INSTALLATION

---

4. Press F6 as soon as the Windows screen shows "**Setup is inspecting your Computer's hardware Configuration**". A message stating "**Press F6 to specify thrid-party RAID controller**" will display during this time. This must be done or else the Windows installer will not prompt for the driver for from the SATA RAID controller and the driver diskette will not be recognized.
5. The next screen will show: "**Setup could not determine the type of one or more mass storage device installed in your system.**" "Selected "specify additional SCSI adapter" by pressing S.
6. Window will prompt to place the "**Manufacturer-supplied hardware support disk**" into floppy drive A: Insert the SATA RAID series driver diskette in drive "A:" and press **Enter**.
7. Window will check the floppy; select the correct card and CPU type for your hardware from the listing and press **Enter** to install it.
8. After Windows scans the hardware and finds the controller, it will display:  
"**Setup will load support for the following Mass Storage devices:**"  
"**Windows 2K, XP,2K3 (ARC1XX0) SATA PCI-X (or PCI-Express) RAID Controller**". Press **Enter** to continue and copy the driver files. From this point on, simply follow the Microsoft Windows installation procedure. Follow the on-screen instructions, responding as needed, to complete the installation.
9. After the installation is completed, reboot the system to load the new drivers / operating system.
10. See Chapter 5 in this manual to customize your RAID volume sets using Storage manager.

## 4.2.2.2 Making Volume Sets Available to Windows System

When you reboot the system, log in as a system administrator.

# DRIVER INSTALLATION

---

Continue with the following steps to make any additional volume sets or pass-through disks accessible to Windows. This procedure assumes that the SATA RAID controller hardware, driver, and Windows are installed and operational in your system.

1. Partition and format the new volume set or disks using Disk Administrator:
  - a. Choose Administrative Tools from the Start menu.
  - b. Choose Computer Management from the Administrative Tools menu.
  - c. Select Storage.
  - d. Select Disk Management.
2. Follow the on-screen prompts to write a signature to the drive.
3. Right click on the disk drive and select "Create Volume" from the menu.
4. Follow the on-screen prompts to create a volume set and to give a disk drive letter.

## 4.2.3 Installing controller into an existing Windows 2000/XP/2003 Installation

In this scenario, you are installing the controller in an existing Windows system. To install the driver:

1. Follow the instructions in Chapter 2, the **Hardware Installation** Chapter, to install the controller and connect the disk drives or enclosure.
2. Start the system and then press Tab+F6 to enter the McBIOS-based configuration utility. Use the configuration utility to create the raid set and volume set. For details, see Chapter 3, **McBIOS RAID Manager**. Once a volume set is created and configured, continue with installation of the driver.
3. Re-Boot Windows and the OS will recognize the SATA RAID Controller and launch the "**Found New Hardware Wizard**",

# DRIVER INSTALLATION

---

which guides you in installing the SATA RAID driver.

4. The “**Upgrade Device Driver Wizard**” will pop-up and provide a choice of how to proceed. Choose “**Display a list of known drivers for this device, so that you can choose a specific driver.**” and click on **Next**.
5. When the next screen queries the user about utilizing the currently installed driver, click on the **Have Disk** button.
6. When the “**Install From Disk**” dialog appears, insert the SATA RAID controller driver diskette or the shipping CD-ROM and type-in or browse to the correct path for the “**Copy manufacturer’s files from:**” dialog box.
7. After specifying the driver location, the previous dialog box will appear showing the selected driver to be installed. Click the **Next** button.
8. The “**Digital Signature Not Found**” screen will appear. Click on **Yes** to continue the installation.
9. Windows automatically copies the appropriate driver files and rebuilds its driver database.
10. The “**Found New Hardware Wizard**” summary screen appears; click the **Finish** button.
11. The “**System Settings Change**” dialog box appears. Remove the diskette from the drive and click **Yes** to restart the computer to load the new drivers.
12. See Chapter 5 in this manual for information on customizing your RAID volumes using Storage manager.

## 4.2.3.1 Making Volume Sets Available to Windows System

When you reboot the system, log in as a system administrator. The following steps show how to make any new disk arrays or independent disks accessible to Windows 2000/XP/2003. This

# DRIVER INSTALLATION

---

procedure assumes that the SATA RAID controller hardware, driver, and Windows are installed and operational in your system.

1. Partition and format the new arrays or disks using Disk Administrator:
  - a. Choose Administrative Tools from the Start menu.
  - b. Choose Computer Management from the Administrative Tools menu.
  - c. Select Storage.
  - d. Select Disk Management.
2. Follow the on-screen prompts to write a signature to the drive.
3. Right click on the drive and select Create Volume from the menu.
4. Follow the on-screen prompts to create a volume set and to assign a disk drive letter.

## 4.2.4 Uninstall controller from Windows 2000/XP/2003

To remove the SATA RAID controller driver from the Windows system, follow the instructions below.

1. Ensure that you have closed all applications and are logged in with administrative rights.
2. Open **Control Panel** and start the **Add/Remove Program** icon and uninstall and software for the SATA RAID controller.
3. Go to Control Panel and select System. Select the Hardware tab and then click the Device Manager Button. In Device Manager, expand the "SCSI and RAID Controllers" section. Right click on the **ARECA SATA RAID Adapter** and select "uninstall".
4. Click **Yes** to confirm removing the SATA RAID driver. The prompt to restart the system will then be displayed.

# DRIVER INSTALLATION

---

## 4.3 Driver Installation for Linux

This chapter describes how to install the SATA RAID controller driver to Red Hat Linux, and SuSE Linux. Before installing the SATA RAID driver to the Linux, complete the following actions:

1. Install and configure the controller and hard disk drives according to the instructions in Chapter 2 **Hardware Installation**.
2. Start the system and then press Tab+F6 to enter the McBIOS RAID manager configuration utility. Use the BIOS configuration utility to create the RAID set and volume set. For details, see Chapter 3, **McBIOS RAID Manager**.

If you are using a Linux distribution for which there is not a compiled driver available from ARECA, you can copy the source from the SATA software CD or download the source from the ARECA website and compile a new driver.

Compiled and tested drivers for Red Hat and SuSE Linux are included on the shipped CD. You can download updated versions of compiled and tested drivers for Red Hat or SuSE Linux from the ARECA web site at <http://www.areca.com.tw>. Included in these downloads is the Linux driver source, which can be used to compile the updated version driver for RedHat, SuSE and other versions of Linux.

Please refer to the "**readme.txt**" file on the included ARECA CD-ROM or website to make driver diskette and to install driver to the system.

## 4.4 Driver Installation for FreeBSD

This chapter describes how to install the SATA RAID controller driver to FreeBSD. Before installing the SATA RAID driver to FreeBSD, complete following actions:

1. Install and configure the controller and hard disk drives according to the instructions in Chapter 2, **Hardware Installation**.
2. Start the system and then press Tab+F6 to enter the **McBIOS RAID Manager** configuration utility. Use the BIOS configuration

# DRIVER INSTALLATION

---

utility to create the raid set and volume set. For details, see Chapter 3, **McBIOS RAID Manager**.

The supplied CD-ROM that came with the SATA RAID controller includes compiled and tested drivers for FreeBSD 4.x (4.2 and onwards) and 5.x (5.2 and onwards). To check if a more current version driver is available, please see the ARECA web site at <http://www.areca.com.tw>.

Please refer to the “**readme.txt**” file on the SATA RAID controller software CD-ROM or website to make driver diskette and to install driver to the system.

## 4.5 Driver Installation for Solaris 10

Please refer to the “readme.txt” file on the software CD-ROM or a manual from website: <http://www.areca.com.tw>

## 4.6 Driver Installation for Mac 10.x

The Mac driver was installed by running (double-click on ArcMSR-1.3.1.pkg icon) ArcMSR-1.3.1.pkg from the Desktop. Installation successful and card recognized in system profiler.

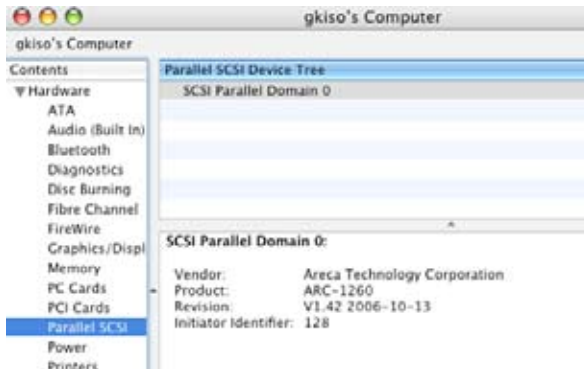

# DRIVER INSTALLATION

---

## **4.7 Driver Installation for UnixWare 7.1.4**

Please refer to the "readme.txt" file on the software CD-ROM or a manual from website: <http://www.areca.com.tw>

## **4.8 Driver Installation for NetWare 6.5**

Please refer to the "readme.txt" file on the software CD-ROM or a manual from website: <http://www.areca.com.tw>

# ARCHTTP PROXY SERVER INSTALLATION

## 5. ArcHttp Proxy Server Installation

### Overview

After hardware installation, the SATA disk drives connected to the SATA RAID controller must be configured and the volume set units initialized before they are ready to use.

The user interface for these tasks can be accessed through the built-in configuration and administration utility that resides in the controller's firmware. It provides complete control and management of the controller and disk arrays, eliminating the need for additional hardware or software.

In addition, a software utility to configure the SATA RAID is provided on the CD-ROM delivered with SATA controller. This CD-ROM contains the software utility that can monitor, test, and support the SATA RAID controller. The software utility and McRAID storage manager can configure and monitor the SATA RAID controller via ArchHttp Proxy Server. The following table outlines their functions:

Configuration Utility	Operating System supported
McBIOS RAID Manager	OS-Independent
McRAID Storage Manager (Via Archhttp proxy server)	Windows 2000/XP/2003, Linux, FreeBSD NetWare, UnixwWare, Solaris and Mac
SAP Monitor (Single Admin portal to scan for multiple RAID units in the network, Via ArchHttp Proxy Server)	Windows 2000/XP/2003

From version 1.6 and later, the HTTP management software (ArcHttp) runs as a service or daemon, and have it automatically start the proxy for all controllers found. This way the controller can be managed remotely without having to sign in the server. The HTTP management software (ArcHttp) also has integrated the General Configuration, Mail Configuration and SNMP Configuration. Those can be configured in local or remote standard web browser.

### **Note:**

If your controller have onboard LAN port, you don't need to install ArchHttp proxy Server, you can use McRAID Storage Manager directly.



# ARCHTTP PROXY SERVER INSTALLATION

## 5.1 For Windows

You must have administrative level permissions to install SATA RAID software. This procedure assumes that the SATA RAID hardware and Windows are installed and operational in your system. Screen captures in this section are taken from a Windows XP installation. If you are running another version of Windows, your installation screen may look different, but the ArchHttp proxy server installation is essentially the same.

1. Insert the RAID subsystem CD in the CD-ROM drive.
2. Run the setup.exe file that resides at: <CD-ROM>\PACKAGES\Windows\http\setup.exe on the CD-ROM.
3. The screen shows Preparing to install.



Follow the on-screen prompts to complete ArchHttp Proxy Server software installation.

A program bar appears that measures the progress of the ArchHttp setup. When this screen complete, you have completed the ArchHttp Proxy Server software setup.

4. After a successful installation, the Setup Complete dialog box is displayed.



Click the **Finish** button to complete the installation.

# ARCHTTP PROXY SERVER INSTALLATION

---

Click on the start button in the Windows 2000/XP task bar and then click Program, select the McRAID and run " ArchHttp proxy server". The ArchHttp dialog box appears.

1. When you select "**Controller#01(PCI)**" then click "**Start**" button. Then web browser appears.
2. If you select "**Cfg Assistant**" then click "**Start**" button. The ArchHttp Configuration apperas. (please refer to section 5.6 ArchHttp Configuration)

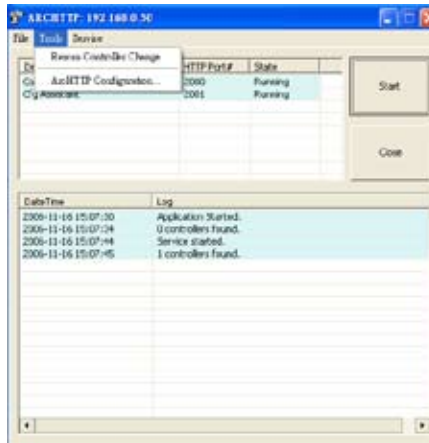

## 5.2 For Linux

You must have administrative level permissions to install SATA RAID software. This procedure assumes that the SATA RAID hardware and Linux are installed and operational in your system. The following details the Linux installation procedure of the SATA RAID controller software.

1. Insert the SATA RAID controller CD in the CD-ROM drive.
2. Copy <CD-ROM>\PACKAGES\Linux\http directory to local (Ex:/usr/local/sbin)
3. Setting up the "**archttpsrv.conf**" of ArchHttp configuration. For example: General Configuration, Mail Configuration, SNMP Configuration.

# ARCHTTP PROXY SERVER INSTALLATION

---

Usage: ./archttp32 (TCP\_PORT) or ./archttp64 (TCP\_PORT). It depends on your OS version.

Parameters: TCP\_PORT value= 1~65535 (If TCP\_PORT assigned, Archttp will start from this port. Otherwise, it will use the setting in archttpsrv.conf )

4. Running the ArchHttp file then ArchHttp screen appears.

Copyright (c) 2004 Areca, Inc. All Rights Reserved.  
Areca HTTP proxy server V1.80.240 for Areca RAID controllers.

Controller(s) list

-----  
Controller[1](PCI) : Listen to port[81].  
Cfg Assistant : Listen to port[82].  
-----

#####  
Press CTRL-C to exit program!!  
#####

3. See the next chapter detailing the McRAID Storage Manager to customize your RAID volume set.

## **For Mozilla user:**

Because our management need Java support, so user may need upgrade to version 1.6 or later.

## **5.3 For FreeBSD**

You must have administrative level permissions to install SATA RAID software. This procedure assumes that the SATA RAID hardware and FreeBSD are installed and operational in your system. The following details FreeBSD installation procedure of the SATA RAID controller software.

1. Insert the RAID subsystem CD in the CD-ROM drive.
2. Copy <CD-ROM>\PACKAGES\FreeBSD\http directory to local  
The next following step is the same with Linux. Please see section 5.2 For Linux.

# ARCHTTP PROXY SERVER INSTALLATION

---

## 5.4 For Solaris 10 x86

You must have administrative level permissions to install SATA RAID software. This procedure assumes that the SATA RAID hardware and FreeBSD are installed and operational in your system.

The following details Solaris installation procedure of the SATA RAID controller software.

1. Insert the RAID subsystem CD in the CD-ROM drive.
2. Copy <CD-ROM>\PACKAGES\Solaris\http directory to local  
The next following step is the same with Linux. Please see section 5.2 For Linux.

## 5.5 For Mac OS 10.x

The McRAID manager interface can be accessed through the built-in configuration and administration utility that resides in the controller's firmware. It provides complete control and management of the controller and disk arrays, eliminating the need for additional hardware or software.

The ArchHttp proxy server is provided on the CD-ROM delivered with SATA card or download from the [www.areca.com.tw](http://www.areca.com.tw). The firmware embedded McRAID storage manager can configure and monitor the SATA RAID controller via ArchHttp Proxy Server.

1. Login as root. Copy the ArchHttp file to a local directory.

- (1). Insert the SATA RAID controller CD in the CD-ROM drive.
- (2). Copy <CD-ROM>\PACKAGES\Mac\http directory to local.  
Or

- (1). Download from the [www.areca.com.tw](http://www.areca.com.tw) or from the email attachment.

2. You must have administrative level permissions to install SATA RAID controller ArchHttp software. This procedure assumes that the SATA RAID hardware and Mac driver are installed and operational in your system.

The following details are the installation procedure of the SATA RAID controller for Mac ArchHttp software.

# ARCHTTP PROXY SERVER INSTALLATION

---

(1).Run the archttp64 using Terminal.app by using the following command:

Usage: sudo ./archttp64 (TCP\_PORT).

Parameters: TCP\_PORT value= 1~65535 (If TCP\_PORT assigned, Archttp will start from this port. Otherwise, it will use the setting in the archttpsrv.conf or default 81). This is the port address assigning for the first adapter.

Such as: sudo ./archttp64 1553

(2). Archttp server console started, Controller card detected then ArchHttp proxy server screen appears.

Copyright (c) 2004 Areca, Inc. All Rights Reserved.  
Areca HTTP proxy server V1.80.240 for Areca RAID controllers.

Controller(s) list

```
-----  
Controller[1](PCI) : Listen to port[1553].  
Cfg Assistant : Listen to port[1554].  
Binding IP:[0.0.0.0]  
Note: IP[0.0.0.0] stands for any ip bound to this host.  
-----  
#####  
Press CTRL-C to exit program!!  
#####  
Controller [1] Http: New client [9] accepted  
Controller [1] Http: New Recv 243 bytes  
Controller [1] Http: Send [174] bytes back to the client
```

## 5.6 ArcHttp Configuration

The ArchHttp proxy server will automatically assign one additional port for setup its configuration. If you want to change the "archttpsrv.conf" setting up of ArchHttp configuration, For example: General configuration, Mail Configuration, and SNMP Configuration, please start Web Browser by entering `http://[Computer IP Address]:[cfg port number]`

# ARCHTTP PROXY SERVER INSTALLATION

---

The ArchHttp configuration starts.

- **General Configuration**

**ARCHTTP Configurations**

General Configurations

Binding IP: 0.0.0.0 (selected), 127.0.0.1, 192.166.0.44

HTTP Port#: [ ]

Display HTTP Connection Information To Console:  Yes  No

Scanning PCI Device:  Yes  No

Scanning RS-232 Device:  Yes  No

Scanning Inband Device:  Yes  No

Confirm The Operation

Submit Reset

Binding IP 0.0.0.0: You can choose either local administration or remote administration to connect web browser.

Binding IP 127.0.0.1: Using local administration to connect web browser.

Binding IP 192.166.0.44: Using remote administration to connect web browser.

HTTP Port#: Value 1~65535

Display HTTP Connection Information To Console: Select "Yes" to show Http send bytes and receive bytes information in the console.

Scanning PCI Device: Select "Yes" for ARC-1XXX series adapter

Scanning RS-232 Device: No

Scanning Inband Device: No

- **Mail Configuration**

When you open the mail configuration page, you will see following settings:

SMTP server IP Address: enter the SMTP server IP address which is not MCRAID manager IP. Ex: 192.168.0.2

Sender Name: enter the sender name that will be shown in the outgoing mail. Ex: RaidController\_1

Mail address: enter the sender email that will be shown in the outgoing mail, but don't type IP to replace domain name.

# ARCHTTP PROXY SERVER INSTALLATION

Ex: RaidController\_1@areca.com.tw

Account: enter the valid account if your SMTP mail server need authentication.

Password: enter the valid password if your SMTP mail server need authentication.

MailTo Name: enter the alert receiver name that will be shown in the outgoing mail.

Mail Address: enter the alert receiver mail address.

Ex: admin@areca.com.tw

## ARCHTTP Configurations

General Configuration  
Mail Configuration  
SNMP Trap Configuration

### ARCHTTP Configurations

SMTP Server Configuration

SMTP Server IP Address

Mail Address Configuration

Sender Name Mail Address

Account Password

MailTo Mail1 Mail Address

MailTo Mail2 Mail Address

MailTo Mail3 Mail Address

MailTo Mail4 Mail Address

Event Notification Configuration

Enable Error Notification  Enable Event Notification 90 Sec Stop

Digest Error Notification  Send Only Digest Event

Serious Error Notification  Send Digest And Serious Event

Warning Error Notification  Send Digest, Serious And Warning Event

Malfunction Notification  Send All Event

Mailbox Full Error  Notify The Error Occurs Within 24 Hours

Confirm The Operation

Submit Reset

### Note:

Please make sure you have completed mail address before you submit mail configurations.

### ● SNMP Trap Configuration

Please refer to 6.8.4 SNMP configuration(12/16/24-port) section.

# ARCHTTP PROXY SERVER INSTALLATION

**ARCHTTP Configurations**

[General Configuration](#)  
[Mail Configuration](#)  
[SMTP Trap Configuration](#)

**SMTP Trap Configurations**

SMTP Trap IP Address #1	192	168	0	173	port	NO
SMTP Trap IP Address #2	0	0	0	0	port	NO
SMTP Trap IP Address #3	0	0	0	0	port	NO

**SMTP System Configurations**

Continuity: public

**SMTP Trap Notification Configurations**

<input type="radio"/> Disable Error Notification	Do: Event Notification Will Be Done
<input checked="" type="radio"/> Digest Error Notification	Do: Only Digest Errors
<input type="radio"/> Digest Size Notification	Do: Digest Apud Server Error
<input type="radio"/> Warning Error Notification	Do: Digest, Digest Apud Warning Error
<input type="radio"/> Information Notification	Do: All Error

Confirm This Operation

Configure Configuration and submit. After ArchHttp configurations have successfully submitted, the Archhttp console restarts again.

## **Note:**

Event Notification Table refer to Appendix D. After you confirm and submit configurations, you can use Generate Test Event feature to make sure these settings are correct.



## 6. Web Browser-based Configuration

Before using the McRAID firmware-based browser utility, do the initial setup and installation of this product. If you need to boot up the operating system from a RAID volume set, you must first create a RAID volume by using **McBIOS RAID Storage Manager**. Please refer to section 3.3 **Using Quick Volume /Raid Setup Configuration** for information on creating this initial volume set.

The McRAID storage manager is firmware-based utility, which is accessible via the browser installed on your operating system. The Web Browser-based McRAID Storage Manager is a HTML-based application, which utilizes the browser (IE, Netscape and Mozilla etc) installed on your monitor station.

It can be accessed through the In-Band PCI-X/PCIe bus or Out-of-Band ethernet port. The In-Band method via archhttp proxy server to launch the Web Browser-based McRAID Storage Manager. The firmware-embedded Web Browser-based McRAID storage manager allows local or remote to access it from any standard internet browser via a LAN or WAN with no software or patches required. The firmware contains SMTP manager monitors all system events and user can select either single or multiple user notifications to be sent via LAN with "Plain English" e-mails. The firmware-embedded SNMP agent allows remote to monitor events via LAN with no SNMP agent required.

- Create RAID set,
- Expand RAID set,
- Define volume set,
- Add physical drive ,
- Modify volume set,
- Modify RAID level/stripe size,
- Define pass-through disk drives,
- Modify system function,
- Update firmware, and
- Designate drives as hot spares.

### 6.1 Start-up McRAID Storage Manager

With the McRAID Storage Manager, you can locally manage a system containing a SATA RAID controller that has Windows or Linux

# WEB BROWSER-BASED CONFIGURATION

---

and a supported browser. A locally managed system requires all of the following components:

- A supported Web browser, which should already be installed on the system.
- Install ArchHttp proxy server on the SATA RAID system. (Refer to Chapter 5, ArchHttp Proxy Server Installation)
- Remote and managed systems must have a TCP/IP connection.

## **Note:**

For windows, if there is no volume set created by the MC-BIOS manager, Archhttp program can not find raid card. It will show "0 controllers found". From the version 1.71 of the Archttp and the version 1.20.00.13 of the driver, users no longer need to have a "valid raid volume" created in order to managed controller.

To configure the internal SATA RAID controller. You need to know its IP Address.

(1). Launch your McRAID Storage Manager by entering `http://[Computer IP Address]:[port number]` in the web browser.

(2). When connection is established, the System Login screen appears. The SATA RAID controller default User Name is "**admin**" and the Password is "**0000**"

## • **Another method to start-up McRAID Storage Manager from Windows Local Administration**

Screen captures in this section are taken from a Windows XP installation. If you are running another version of Windows, your screens may look different, but the ArchHttp proxy server installation is essentially the same.

1. To start the McRAID Storage Manager for browser-based management, selecting Controller#01(PCI) and then click the **Start** Button.

# WEB BROWSER-BASED CONFIGURATION

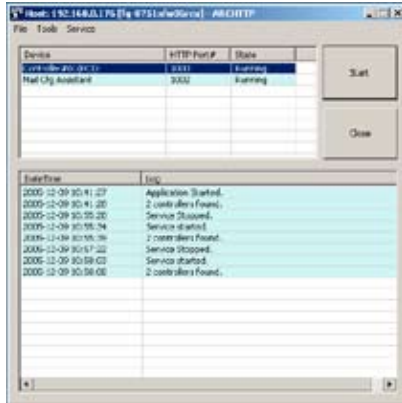

The "Enter Network Password" dialog screen appears, type the User Name and Password. The RAID subsystem controller default User Name is "**admin**" and the Password is "**0000**". After entering the user name and password, press Enter to access the McRAID Storage Manager.



## 6.1.1 Through Ethernet port (Out-of-Band)

Areca now offers an alternative means of communication for the PCI-X/PCIe RAID Adapter – McRAID Web Browser-based RAID Management program. User can access the built-in configuration without needing system starting up running the ArchHttp proxy. The Web Browser-based RAID Management program is an HTML-based application, which utilizes the browser installed on your remote system.

To ensure proper communications between the PCI-X/PCIe RAID controller and Web browser-based RAID management, Please connect the RAID controller Ethernet LAN port to any LAN switch port.

# WEB BROWSER-BASED CONFIGURATION

The controller has embedded the TCP/IP & Web Browser-based RAID manager in the firmware. User can remote manage the RAID controller without adding any user specific software (platform independent) via standard web browsers directly connected to the 10/100 Ethernet RJ45 LAN port.

To configure External RAID subsystem on a remote machine, you need to know its IP Address. The IP address will default show in BIOS configuration of Ethernet configuration option. Launch your firmware-embedded TCP/IP & Web Browser-based RAID manager by entering `http://[IP Address]` in the web browser.

## Note:

You can find controller Ethernet port IP address in **System Information**.

## 6.2 SATA RAID controller McRAID Storage Manager

The McRAID Storage Manager current configuration screen displays the current configuration of your SATA RAID controller. It displays the Raid Set List, Volume Set List, and Physical Disk List. The raid set information, volume set information, and drive information can also be viewed by clicking on the "Raid Set Hierarchy" screen. The current configuration can also be viewed by clicking on "Raid Set Hierarchy" in the menu.

The screenshot shows the McRAID Storage Manager web interface. On the left is a navigation menu with options: Quick Essentials, RAID Set Functions, Volume Set Functions, Physical Drives, System Controls, and Defragmentation. The main content area features the Areca Technology Corporation logo and the title "Raid Set Hierarchy". Below the title is a table with columns: Raid Set, IDE Channels, Volume Set (Child List), Volume State, and Capacity. The table lists three RAID sets, each with two IDE channels and a volume set in a "Normal" state, all with a capacity of 250 GB. Below this table is another table titled "IDE Channels" with columns: Channel, Usage, Capacity, and Model. This table lists eight IDE channels, with channels C001 through C003 and C005 through C008 being RAID sets (usage: Raid Set # 00, capacity: 250 GB, model: WDC WD2500ED-01HC00), and channels C004, C006, C007, and C008 being "H.A." (usage: H.A., capacity: H.A., model: H.A.).

Raid Set	IDE Channels	Volume Set (Child List)	Volume State	Capacity
Raid Set # 00	C001	ARC-110-VOL00 (000)	Normal	250 GB
	C002			
Raid Set # 00	C003	ARC-110-VOL00 (000)	Normal	250 GB
	C004			
Raid Set # 00	C005	ARC-110-VOL00 (000)	Normal	250 GB

Channel	Usage	Capacity	Model
C001	Raid Set # 00	250 GB	WDC WD2500ED-01HC00
C002	Raid Set # 00	250 GB	WDC WD2500ED-01HC00
C003	Raid Set # 00	250 GB	WDC WD2500ED-22H001
C004	H.A.	H.A.	H.A.
C005	Raid Set # 00	250 GB	WDC WD2500ED-22H001
C006	H.A.	H.A.	H.A.
C007	H.A.	H.A.	H.A.
C008	H.A.	H.A.	H.A.

# WEB BROWSER-BASED CONFIGURATION

To display raid set information, move the mouse cursor to the desired raid set number, then click it. The raid set Information will display. To display volume set information, move the mouse cursor to the desired Volume Set number, then click it. The volume set Information will display. To display drive information, move the mouse cursor to the desired physical drive number, then click it. The drive Information will display.

## 6.3 Main Menu

The Main Menu shows all available functions, accessible by clicking on the appropriate link.

Individual Category	Description
Quick Function	Create a default configuration, which is based on the number of physical disks installed; it can modify the volume set Capacity, Raid Level, and Stripe Size.
RaidSet Functions	Create a customized raid set.
VolumeSet Functions	Create customized volume sets and modify the existed volume sets parameter.
Physical Drives	Create pass through disks and modify the existing pass through drives parameters. Also provides the function to identify disk drives (blinking LED).
System Controls	Setting the raid system configuration.
Information	Viewing the controller information. The Raid Set Hierarchy can be viewed through the RaidSet Hierarchy item.

## 6.4 Quick Function

The screenshot displays the 'Quick Create Raid Volume Set' configuration page. On the left, a vertical navigation menu lists: Quick Function, RaidSet Functions, VolumeSet Functions, Physical Drives, System Controls, and Information. The main content area features the Areca Technology Corporation logo and the title 'Quick Create Raid Volume Set'. Below the title is a form with the following fields and values:

- Total Number Of Disks: 4
- Select Raid Level: RAID 5
- Maximum Capacity Allowed: 100.1 GB
- Select Capacity: 100.1 GB
- Greater Than 2B Volume Support: No
- Volume Initialization Mode: Preformatted or From Command
- Select Stripe Size: 64 K-Bytes

At the bottom of the form, there are 'Submit' and 'Reset' buttons.

# WEB BROWSER-BASED CONFIGURATION

---

## **Note:**

In Quick Create, your volume set is automatically configured based on the number of disks in your system. Use the Raid Set Function and Volume Set Function if you prefer to customize your system.

The number of physical drives in the SATA RAID controller determines the RAID levels that can be implemented with the RAID set. You can create a raid set associated with exactly one volume set. The user can change the RAID level, stripe size, and capacity. A hot spare option is also created depending upon the existing configuration.

Click the "Confirm The Operation" check box and click on the Submit button in the Quick Create screen, the RAID set and volume set will start to initialize.

## **Note:**

If volume capacity will exceed 2TB, controller will show the Greater 2 TB volume Support sub-menu. Greater Two TB Volume Support No, 64bit LBA and For Windows.

For more details please download PDF file from **ftp://ftp.areca.com.tw/RaidCards/Documents/Manual\_Spec/Over2TB\_050721.zip**

## **6.5 RaidSet Functions**

Use the "Raid Set Function" and "Volume Set Function" if you prefer to customize your system. Manual configuration can provide full control of the RAID set settings, but it will take longer to complete than the "Quick Volume/Raid Setup" configuration. Select the "Raid Set Function" to manually configure the RAID set for the first time or delete and reconfigure existing RAID sets. (A RAID set is a group of disks containing one or more volume sets.)

### **6.5.1 Create Raid Set**

To create a raid set, click on the "Delete Raid Set" link. A "Select

# WEB BROWSER-BASED CONFIGURATION

The Drive For RAID Set” screen is displayed showing the drive(s) connected to the current controller. Click on the selected physical drives within the current raid set. Enter 1 to 15 alphanumeric characters to define a unique identifier for a raid set. The default raid set name will always appear as “Raid Set. #”. Click the “Confirm The Operation” check box and click on the “Submit” button on the screen; the RAID set will start to initialize.



## 6.5.2 Delete RAID Set

To delete a RAID set, click on the “Deleted RAID Set” link. The “**Select The RAID SET To Delete**” screen is displayed showing all existing RAID sets in the current controller. Click the RAID set number you which to delete in the select column on the delete screen.

Click the “Confirm The Operation” check box and click on the “Submit” button in the screen to delete it.



# WEB BROWSER-BASED CONFIGURATION

## 6.5.3 Expand Raid Set

Use this option to expand a RAID set when a disk is added to your system. This function becomes active when at least one drive is available.



To expand a raid set, click on the "Expand Raid Set" link. Select the target RAID set to be expanded. Click the available disk and the "Confirm The Operation" check box and then click on the "Submit" button on the screen to add disks to the RAID set.

## 6.5.4 Activate Incomplete Raid Set

If one of the disk drives is removed in power off state, the raid set state will change to "Incomplete State" If the user wants to continue to power-on the SATA RAID controller, the user can use the "Activate Raid Set" option to activate the RAID set. After the user completes this function, the Raid State will change to Degraded Mode.





# WEB BROWSER-BASED CONFIGURATION

To activate the incomplete the RAID set, click on the "Activate Raid Set" link. A "Select The RAID SET To Activate" screen is displayed showing all raid sets existing on the current controller. Click the RAID set number to activate in the select column. Click on the "Submit" button on the screen to activate the raid set that had a disk removed (or failed) in the power off state. The SATA RAID controller will continue to work in degraded mode.

## 6.5.5 Create Hot Spare



When you choose the "Create Hot Spare" option in the "Raid Set Function", all unused physical devices connected to the current controller appear. Select the target disk by clicking on the appropriate check box. Click the "Confirm The Operation" check box and click the "Submit" button in the screen to create the hot spares.

The "Create Hot Spare" option gives you the ability to define a global hot spare.

## 6.5.6 Delete Hot Spare

Select the target Hot Spare disk to delete by clicking on the appropriate check box.

Click the "Confirm The Operation" check box and click the "Submit" button on the screen to delete the hot spares.

## 6.5.7 Rescue Raid Set

When the system is powered off in the RAID set update/creation period, it possibly could disappear due to this abnormal condition.

# WEB BROWSER-BASED CONFIGURATION

The “**RESCUE**” function can recover the missing RAID set information. The RAID controller uses the time as the RAID set signature. The RAID set may have different time after the RAID set is recovered. The “**SIGANT**” function can regenerate the signature for the RAID set.



## 6.6 Volume Set Functions

A volume set is seen by the host system as a single logical device. It is organized in a RAID level with one or more physical disks. RAID level refers to the level of data performance and protection of a volume set. A volume set capacity can consume all or a portion of the disk capacity available in a RAID set. Multiple volume sets can exist on a group of disks in a RAID set. Additional volume sets created in a specified RAID set will reside on all the physical disks in the raid set. Thus each volume set on the RAID set will have its data spread evenly across all the disks in the RAID set.

### 6.6.1 Create Volume Set

1. Volume sets of different RAID levels may coexist on the same raid set.
  2. Up to 16 volume sets can be created by the SATA RAID controller.
  3. The maximum addressable size of a single volume set is not limited to 2 TB because the controller is capable of 64-bit mode. However, the operating system itself may not be capable of addressing more than 2 TB. See the Areca website for details.
- To create a volume set on a raid set, move the cursor bar to the

# WEB BROWSER-BASED CONFIGURATION

main menu and click on the "Create Volume Set" link. The "Select The Raid Set To Create On It" screen will show all RAID set numbers. Click the RAID set number that to be used and then click the "Submit" button.

The "create new volume set" option allows users to select the Volume name, capacity, RAID level, strip size, SCSI ID/LUN, Cache mode, and tag queuing.

The screenshot shows the "Create Volume Set" configuration page. On the left is a navigation menu with categories: Quick Function, Edit Function, Volume Function, Physical Drive, System Control, and Information. The main content area is titled "Areca Technology Corporation" and "Enter Volume Attributes On Raid Set # 00". It contains a form with the following fields:

Volume Name	Volume Set #00
Member Drive	4
Volume Raid Level	RAID 0
Strip Capacity Allowed	1 MB
Select Volume Capacity	1024 GB
Create Two TB Volume Support	No
Volume Initialization Mode	Format and Partition Completely
Volume Strip Size	64 KB Bytes
Volume Cache Mode	Write Back
Triggered Coherent Queuing	Enabled
SCSI Channel SCSI ID/SCSI LUN	0 0 0 0

At the bottom of the form are "Submit" and "Cancel" buttons, and a "Continue The Operation" link.

- **Volume Name**

The default volume name will always appear as "Volume Set.#". You can rename the volume set providing it does not exceed the 15 characters limit.

- **Raid Level**

Set the RAID level for the volume set. Highlight the desired Raid Level and press Enter.

The available RAID levels for the current volume set are displayed. Select a RAID level and press "Enter" to confirm.

- **Capacity**

The maximum volume size is the default initial setting. Enter the appropriate volume size to fit your application.

- **Greater Two TB Volume Support**

If volume capacity will exceed 2TB, controller will show the "Greater 2 TB volume Support" sub-menu. Greater Two TB Volume Support No, 64bit LBA and For Windows options.

For more details please download PDF file from [ftp://ftp.areca.com.tw/RaidCards/Documents/Manual\\_Spec/Over2TB\\_050721.zip](ftp://ftp.areca.com.tw/RaidCards/Documents/Manual_Spec/Over2TB_050721.zip)

# WEB BROWSER-BASED CONFIGURATION

---

## ● Initialization Mode

Press "Enter" key to define fast initialization or Selected the Background (Instant Available). When background Initialization, the initialization proceeds as a background task, the volume set is fully accessible for system reads and writes. The operating system can instantly access to the newly created arrays without requiring a reboot and waiting the initialization complete. when Fast Initialization, the initialization proceeds must be completed before the volume set ready for system accesses.

## ● Strip Size

This parameter sets the size of the stripe written to each disk in a RAID level 0, 1, 1E, 5 or 6 logical drive. You can set the stripe size to 4 KB, 8 KB, 16 KB, 32 KB, 64 KB, or 128 KB.

A larger stripe size produces better read performance, especially if your computer does mostly sequential reads. However, if you are sure that your computer does random reads more often, select a smaller stripe size.

Note: RAID level 3 can't modify strip size.

## ● Cache Mode

The SATA RAID controller supports Write-Through Cache and Write-Back Cache.

## ● SCSI Channel/SCSI ID/SCSI Lun

SCSI Channel: The SATA RAID controller function is simulated as a SCSI RAID controller. The host bus is represented as a SCSI channel. Choose the SCSI Channel.

SCSI ID: Each SCSI device attached to the SCSI card, as well as the card itself, must be assigned a unique SCSI ID number. A SCSI channel can connect up to 15 devices. The SATA RAID controller is a large SCSI device. Assign an ID from a list of SCSI IDs.

SCSI LUN: Each SCSI ID can support up to 8 LUNs. Most SCSI controllers treat each LUN like a SCSI disk.

## ● Tag Queuing

The Enabled option is useful for enhancing overall system performance under multi-tasking operating systems. The Command Tag (Drive Channel) function controls the SCSI command tag queuing support for each drive channel. This func-

# WEB BROWSER-BASED CONFIGURATION

tion should normally remain enabled. Disable this function only when using older SCSI drives that do not support command tag queuing

## 6.6.2 Delete Volume Set

To delete a volume set from RAID set, move the cursor bar to the main menu and click on the "Delete Volume Set" link. The "Select The Raid Set To Delete" screen will show all RAID set numbers. Click a raid set number and the "Confirm The Operation" check box and then click the "Submit" button to show all volume set items in the selected raid set. Click a volume set number and the "Confirm The Operation" check box and then click the "Submit" button to delete the volume set.

The screenshot shows a web browser-based configuration interface. On the left is a navigation menu with categories like "Quick Function", "Raid Set Functions", "Volume Set Functions", "Physical Devices", "System Controls", and "Information". The main content area features the "Areca Technology Corporation" logo and a heading "Select The Volume Set To Delete". Below this is a table with columns: "Select", "Volume Set Name", "On Raid Set", and "Capacity". One row is visible with "Volume Set # 00", "Raid Set # 00", and "100 000". Below the table is a "Confirm The Operation" checkbox and "Submit" and "Cancel" buttons.

Select	Volume Set Name	On Raid Set	Capacity
<input type="checkbox"/>	Volume Set # 00	Raid Set # 00	100 000

## 6.6.3 Modify Volume Set

To modify a volume set from a raid set:

- (1). Click on the "Modify Volume Set" link.
- (2). Click the volume set check box from the list that you wish to modify. Click the "Submit" button. The following screen appears. Use this option to modify the volume set configuration. To modify volume set attributes from "Raid Set System" function, move the cursor bar to the volume set attribute menu and click it. The "modify value" screen appears. Move the cursor to an attribute item and then click the attribute to modify the value. After you complete the modification, click the "Confirm The Operation" check box and click the "Submit" button to complete the action. The user can modify all values except capacity.

# WEB BROWSER-BASED CONFIGURATION

## To Expand an existing volume noticed:

- Only the last volume can expand capacity.
- When expand volume capacity, you can't modify stripe size or modify raid level simultaneously.
- You can expand volume capacity, but can't reduce volume capacity size.

## For Greater 2TB expansion:

- If your system installed in the volume, don't expanded the volume capacity greater 2TB, currently OS can't support boot up from a greater 2TB capacity device.
- Expanded over 2TB used LBA64 mode. Please make sure your OS supports LBA 64 before expand it.

### 6.6.3.1 Volume Set Migration

Migrating occurs when a volume set is migrating from one RAID level to another, a volume set strip size changes, or when a disk is added to a raid set. Migration status is displayed in the volume status area of the RaidSet Hierarchy screen when one RAID level to another, a volume set strip size changes or when a disk is added to a RAID set.

**Areca Technology Corporation**

**Raid Set Hierarchy**

Raid Set	IDE Channels	Volume Set/Chk Str/Len	Volume State	Capacity
Raid Set 0 (0)	5:00	Volume Set 0 (0) (0:0)	Migrating (0:0)	100:000
	5:01			
	5:02			
	5:03			

**IDE Channels**

Channel	Usage	Capacity	Model
0:00	M.A	M.A	M.A
0:01	M.A	M.A	M.A
0:02	M.A	M.A	M.A
0:03	M.A	M.A	M.A
5:00	Raid Set 0 (0)	100:000	ST30013AS
5:01	Raid Set 0 (0)	100:000	ST30013AS
5:02	Raid Set 0 (0)	100:000	ST30013AS
5:03	Raid Set 0 (0)	100:000	ST30013AS

# WEB BROWSER-BASED CONFIGURATION

## 6.6.4 Check Volume Set

To check a volume set from a raid set:

- (1). Click on the "Check Volume Set" link.
- (2). Click on the volume set from the list that you wish to check. Tick on "Confirm The Operation" and click on the "Submit" button. Use this option to verify the correctness of the redundant data in a volume set. For example, in a system with dedicated parity, volume set check means computing the parity of the data disk drives and comparing the results to the contents of the dedicated parity disk drive. The checking percentage can also be viewed by clicking on RaidSet Hierarchy in the main menu.



## 6.6.5 Stop VolumeSet Check



Use this option to stop the "Check Volume Set function".

## 6.7 Physical Drive

Choose this option to select a physical disk from the Main Menu and then perform the operations listed below.

# WEB BROWSER-BASED CONFIGURATION

## 6.7.1 Create Pass-Through Disk

To create pass-through disk, move the mouse cursor to the main menu and click on the "Create Pass-Through" link. The "relative setting function" screen appears. A pass-through disk is not controlled by the SATA RAID controller firmware, it cannot be a part of a volume set. The disk is available to the operating system as an individual disk. It is typically used on a system where the operating system is on a disk not controlled by the RAID firmware. The user can also select the cache mode, Tagged Command Queuing, SCSI channel/SCSI\_ID/SCSI\_LUN for this volume.

The screenshot shows the web browser-based configuration interface for creating a pass-through disk. The interface is divided into a sidebar on the left and a main content area on the right. The sidebar contains navigation options: Quick Function, RAID Set Functions, Volume Set Functions, Physical Drives, System Controls, and Information. The main content area features a header for 'Areca Technology Corporation' and a form titled 'Enter Pass Through Disk Attribute'. The form includes a table for selecting the IDE drive for pass-through, with columns for Select, Channel, Capacity, and Model. Below the table, there are input fields for Volume Cache Mode, Tagged Command Queuing, and SCSI Channel/SCSI\_ID/SCSI\_LUN. A 'Confirm The Operation' button is located at the bottom of the form.

Select	Channel	Capacity	Model
<input checked="" type="checkbox"/>	IDE-Ch0	300GB	ST3000315AS
<input type="checkbox"/>	IDE-Ch1	300GB	ST3000315AS
<input type="checkbox"/>	IDE-Ch2	300GB	ST3000315AS

## 6.7.2 Modify Pass-Through Disk

Use this option to modify the "Pass-Through Disk Attribute". The user can modify the cache mode, Tagged Command Queuing, and SCSI channel/ID/LUN on an existing pass through disk. To modify the pass-through drive attribute from the pass-through drive pool, move the mouse cursor bar and click on the "Modify Pass-Through" link. The "Select The Pass Through Disk For Modification" screen appears mark the checkbox for the Pass-Through Disk from the pass-through drive pool and click on the "Submit" button to select drive.

The screenshot shows the web browser-based configuration interface for modifying a pass-through disk. The interface is divided into a sidebar on the left and a main content area on the right. The sidebar contains navigation options: Quick Function, RAID Set Functions, Volume Set Functions, Physical Drives, System Controls, and Information. The main content area features a header for 'Areca Technology Corporation' and a form titled 'Enter Pass Through Disk Attribute'. The form includes a text input field for the disk ID (C000B0CB3T3000315AS). Below the input field, there are input fields for Volume Cache Mode, Tagged Command Queuing, and SCSI Channel/SCSI\_ID/SCSI\_LUN. A 'Confirm The Operation' button is located at the bottom of the form.



# WEB BROWSER-BASED CONFIGURATION

When the “Enter Pass-Through Disk Attribute” screen appears, modify the drive attribute values, as you want. After you complete the selection, mark the checkbox for “Confirm The Operation” and click on the “Submit” button to complete the selection action.

## 6.7.3 Delete Pass-Through Disk

To delete a pass-through drive from the pass-through drive pool, move the mouse cursor bar to the main menus and click the “Delete Pass Through” link.

After you complete the selection, mark the checkbox for “Confirm The Operation” and click the “Submit” button to complete the delete action.



## 6.7.4 Identify Selected Drive

To prevent removal of the wrong drive, the selected disk LED will light so as to physically locate the intended disk when “Identify Selected Drive” is selected.

To identify the selected drive from the drives pool, click “Identify Selected Drive”. The “Select The IDE Device For Identification” screen appears mark the checkbox for the IDE device from the drive pool and select the Flash method. After completing the selection, click on the “Submit” button to identify selected drive.

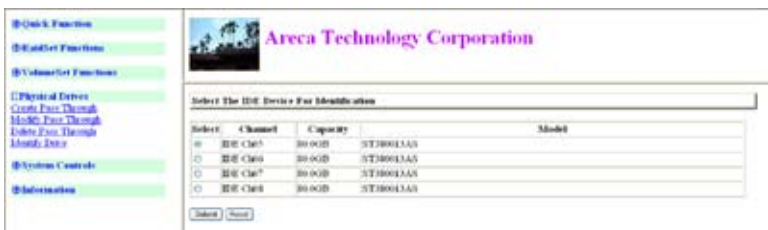

## 6.8 System Controls

### 6.8.1 System Config

To set the raid system function, move the cursor to the main menu and click the "Raid System Function" link. The "Raid System Function" menu will show all items, then select the desired function.

- **System Beeper Setting**

The Alert Beeper function item is used to Disabled or Enable the SATA RAID controller alarm tone generator.

- **Background Task Priority**

The Raid Rebuild Priority is a relative indication of how much time the controller devotes to a rebuild operation. The SATA RAID controller allows the user to choose the rebuild priority (ultraLow, Low, Normal, High) to balance volume set access and rebuild tasks appropriately. For high array performance, specify a Low value.

- **JBOD/RAID Configuration**

JBOD is an acronym for "**Just a Bunch Of Disks**". It represents a volume set that is created by the concatenation of partitions on the disk. The OS can see all disks when this option is selected. It is necessary to delete a RAID set if the disks in that set are to be converted to JBOD mode.

- **Maximun SATA Supported**

The SATA RAID controller can support up to SATA II, which runs up to 300MB/s. NCQ is a command protocol in Serial ATA that can only be implemented on native Serial ATA hard drives. It allows multiple commands to be outstanding within a drive at the same time. Drives that support NCQ have an internal queue where outstanding commands can be dynamically rescheduled or re-ordered, along with the necessary tracking mechanisms for outstanding and completed portions of the workload. The RAID subsystem allows user to choose the SATA Mode (slowest to fastest): SATA150, SATA150+NCQ, SATA300, SATA300+NCQ.

- **HDD Read Ahead Cache**

# WEB BROWSER-BASED CONFIGURATION

Allow Read Ahead (Default: Enabled)—When Enabled, the drive's read ahead cache algorithm is used, providing maximum performance under most circumstances.

## ● Stagger Power on

In a PC system with only one or two drives, the power can supply enough power to spin up both drives simultaneously. But in systems with more than two drives, the startup current from spinning up the drives all at once can overload the power supply, causing damage to the power supply, disk drives and other system components. This damage can be avoided by allowing the host to stagger the spin-up of the drives. New SATA drives have support staggered spin-up capabilities to boost reliability. Staggered spin-up is a very useful feature for managing multiple disk drives in a storage subsystem. It gives the host the ability to spin up the disk drives sequentially or in groups, allowing the drives to come ready at the optimum time without straining the system power supply. Staggering drive spin-up in a multiple drive environment also avoids the extra cost of a power supply designed to meet short-term startup power demand as well as steady state conditions.

Areca has supported the fixed value staggered power up function in its previous version firmware. But from firmware version 1.39 and later, SATA RAID controller has included the option for customer to select the disk drives sequentially stagger power up value. The values can be selected from 0.4ms to 6ms per step which powers up one drive.



# WEB BROWSER-BASED CONFIGURATION

## ● Empty HDD Slot LED

From firmware version 1.39 date: 04/01/2006 and later, the firmware has added the "Empty HDD Slot LED" option to setup the Failed LED light "ON" or "OFF". When each slot has a power LED for the HDD installed identify, user can set this option to "OFF". Choose this option "ON", the failed LED light will flash red light; if no HDD installed.



## ● HDD SMART Status Polling

An external RAID enclosure has the hardware monitor in the dedicated backplane that can report HDD temperature status to the controller. However, PCI type controllers do not use backplanes if the drives are internal to the main server chassis. The type of enclosure cannot report the HDD temperature to the controller. For this reason, HDD SMART Status Polling was added to enable scanning of the HDD temperature function in the version 1.36 date: 2005-05-19 (and later). It is necessary to enable "HDD SMART Status Polling" function before SMART information is accessible. This function is disabled by default.

The following screen shot shows how to change the BIOS setting to enable the Polling function.

# WEB BROWSER-BASED CONFIGURATION



## ● Disk Write Cache Mode

A user can set the “Disk Write Cache Mode” to: Auto, Enabled, or Disabled.



## ● Disk Capacity Truncation Mode

SATA RAID controllers use drive truncation so that drives from differing vendors are more likely to be able to be used as spares for each other. Drive truncation slightly decreases the usable capacity of a drive that is used in redundant units.

The controller provides three truncation modes in the system configuration: **Multiples Of 10G**, **Multiples Of 1G**, and **No Truncation**.

**Multiples Of 10G:** If you have 120 GB drives from different vendors; chances are that the capacity varies slightly. For exam-

# WEB BROWSER-BASED CONFIGURATION

ple, one drive might be 123.5 GB, and the other 120 GB. Areca drive Truncation mode **Multiples Of 10G** uses the same capacity for both of these drives so that one could replace the other.

**Multiples Of 1G:** If you have 123 GB drives from different vendors; chances are that the capacity varies slightly. For example, one drive might be 123.5 GB, and the other 123.4 GB. Areca drive Truncation mode **Multiples Of 1G** uses the same capacity for both of these drives so that one could replace the other.

**No Truncation:** It does not truncate the capacity.



## 6.8.2 Ethernet Configuration (12/16/24-port)

Use this feature to set the controller Ethernet port configuration. A customer doesn't need to create a reserved space on the arrays before the Ethernet port and HTTP service are working. The firm-ware-embedded Web Browser-based RAID manager can access it from any standard internet browser or from any host computer either directly connected or via a LAN or WAN with no software or patches required.

DHCP (Dynamic Host Configuration Protocol) is a protocol that lets network administrators manage centrally and automate the assignment of IP (Internet Protocol) configurations on a computer network. When using the Internet's set of protocols (TCP/IP), in order for a computer system to communicate to another computer system, it needs a unique IP address. Without DHCP, the IP address must be entered manually at each computer system.

# WEB BROWSER-BASED CONFIGURATION

DHCP lets a network administrator supervise and distribute IP addresses from a central point. The purpose of DHCP is to provide the automatic (dynamic) allocation of IP client configurations for a specific time period (called a lease period) and to eliminate the work necessary to administer a large IP network.

To configure the raid controller Ethernet port, move the cursor bar to the main menu and click on the System Controls link. The System Controls menu will show all items. Move the cursor bar to the EtherNet Config item, then press **Enter** key to select the desired function.



## 6.8.3 Alert by Mail Configuration (12/16/24-port)

To configure the SATA RAID controller e-mail function, move the cursor bar to the main menu and click on the "System Controls" link. The System Controls menu will show all items. Move the cursor bar to the "Alert By Mail Config" item, then select the desired function. This function can only be set via web-based configuration.

The firmware contains a SMTP manager monitoring all system events. Single or multiple user notifications to be sent via "Plain English" e-mails with no software required.

# WEB BROWSER-BASED CONFIGURATION

The screenshot shows the 'RAID System Configuration' page. On the left is a navigation menu with links like 'Check Function', 'RAID Function', 'Volume Function', 'Physical Drive', 'System Control', 'Storage Config', 'Alert by Mail Config', 'SNMP Configuration', 'View Event Mail Setting', 'Generate Log Item', 'Disk Drive Health', 'Health Parameter', 'System Parameter', and 'Information'. The main content area has a header with the Areca logo and 'Areca Technology Corporation'. Below the header is a 'RAID System Configuration' section with a 'RAID Drive ID Address' field. The 'Mail Address Configuration' section contains a 'Send To' field, a 'Mail Address' field, and a 'Password' field. There are four rows for 'Mail To Host' and 'Mail Address'. The 'Event Notification Configuration' section includes several checkboxes: 'Enable Event Notification', 'Disable Event Notification', 'Warning Event Notification', 'Information Notification', 'No Event Notification Will Be Sent', 'Send Only Signal Event', 'Send Signal And Device Event', 'Send Signal, Device And Warning Event', and 'Send All Event'. There are also checkboxes for 'Notification For I/O Error' and 'Send The I/O Error Occur Within 24 Hours'. A 'Confirm The Operation' checkbox is at the bottom, along with 'Save' and 'Reset' buttons.

## 6.8.4 SNMP Configuration (12/16/24-port)

To configure the raid controller SNMP function, click on the "System Controls" link. The System Controls menu will show available items. Select the "SNMP Configuration" item. This function can only set via web-based configuration.

The firmware SNMP Agent Manager monitors all system events and the SNMP function becomes functional with no Agent software required.

The screenshot shows the 'SNMP Trap Configuration' page. On the left is a navigation menu with links like 'Check Function', 'RAID Function', 'Volume Function', 'Physical Drive', 'System Control', 'Storage Config', 'Alert by Mail Config', 'SNMP Configuration', 'View Event Mail Setting', 'Generate Log Item', 'Disk Drive Health', 'Health Parameter', 'System Parameter', and 'Information'. The main content area has a header with the Areca logo and 'Areca Technology Corporation'. Below the header is a 'SNMP Trap Configuration' section with three rows for 'SNMP Trap ID Address #1', '#2', and '#3'. Each row has fields for 'IP', 'S', 'B', 'D', 'Port', and 'ID'. The 'SNMP System Configuration' section includes a 'Community' field and three rows for 'Contact ID', 'Name', and 'Location'. The 'SNMP Trap Notification Configuration' section includes several checkboxes: 'Enable SNMP Trap', 'Disable SNMP Trap', 'Signal Event Notification', 'Device Event Notification', 'Warning Event Notification', 'Information Notification', 'No SNMP Trap Will Be Sent', 'Send Only Signal Event', 'Send Signal And Device Event', 'Send Signal, Device And Warning Event', and 'Send All Event'. There is a 'Confirm The Operation' checkbox at the bottom, along with 'Save' and 'Reset' buttons.



# WEB BROWSER-BASED CONFIGURATION

- **SNMP Trap Configurations**

Enter the SNMP Trap IP Address.

- **SNMP System Configurations**

About community, please refer to page 161 of SNMP community name. The system Contact, Name and Location that will be shown in the outgoing SNMP Trap.

- **SNMP Trap Notification Configurations**

Please refer to Appendix D of Event Notification table.

## 6.8.5 NTP Configuration (12/16/24-port)

The Network Time Protocol (NTP) is used to synchronize the time of a computer client or server to another server or reference time source, such as a radio or satellite receiver or modem. It provides accuracies typically within a millisecond on LANs and up to a few tens of milliseconds on WANs relative to Coordinated Universal

The screenshot displays the 'NTP Server Configuration' page. On the left is a sidebar with a tree view containing categories like 'Check Features', 'Configure Features', 'Advanced Features', 'Physical Devices', 'Advanced Commands', 'System Config', 'Advanced Config', 'NTP Configuration', 'Time Zone Configuration', 'Advanced Features', 'System Time Setup', 'User Time Setup', 'Mail Forwarding', and 'Network Services'. The main configuration area has a header with the 'Areca Technology Corporation' logo. Below the header, there are two rows for 'NTP Server IP Address #1' and '#2', each with a dropdown menu for selecting a server. The 'Time Zone Configuration' section includes a 'Time Zone' dropdown set to 'GMT+12:00 International Date Line West', a checked 'Automatic Daylight Saving' checkbox, a 'Current Time' field showing '2005/12/14 15:54:47', and an 'NTP Server #1 or #2' dropdown. At the bottom of the configuration area are 'Cancel' and 'Save' buttons.

Time (UTC) via a Global Positioning Service (GPS) receiver, for example:

- **NTP Sever Address**

The most important factor in providing accurate, reliable time is the selection of NTP servers to be used in the configuration file. Typical NTP configurations utilize multiple redundant servers and diverse network paths in order to achieve high accuracy and reliability. Our NTP configuration supports two existing public NTP synchronization subnets.

# WEB BROWSER-BASED CONFIGURATION

- **Time Zone**

Time Zone conveniently runs in the system tray and allows you to easily view the date and time in various locations around the world. You can also quickly and easily add your own personal locations to customize Time Zone the way you want.

- **Automatic Daylight Saving**

Automatic Daylight Saving will normally attempt to automatically adjust the system clock for daylight saving changes based on the computer time zone. This tweak allows you to disable the automatic adjustment.

## 6.8.6 View Events/Mute Beeper

To view the SATA RAID controller’s information, click on the “System Information” link. The SATA Raid controller events Information screen appears.

Choose this option to view the system events information: Timer, Device, Event type, Elapse Time and Errors. The RAID system does not have a built-in real time clock. The Time information is the relative time from the SATA RAID controller power on.

The screenshot shows a web browser-based configuration interface for a SATA RAID controller. On the left is a navigation menu with options like 'Check Functions', 'Real Time Functions', 'Volume Set Functions', 'Physical Drives', 'System Control', 'System Clock', 'System Log', 'S.M.A.R.T. Configuration', 'M.B. Configuration', 'Area Information (Event)', 'Advanced Tool Kit', 'Data Backup Utility', 'Hot-Swap Function', 'Hot-Swap Function', and 'Information'. The main content area displays the 'System Events Information' page, which includes the 'Area Technology Corporation' logo and a table of system events.

Time	Device	Event Type	Elapse Time	Errors
2005-12-14 14:20:21	AAC-1240-VCEA01	Complete Set	00:14:20	
2005-12-14 14:37:23	152-142-000-136	HTTP Log In		
2005-12-14 14:37:44	AAC-1240-VCEA01	Start Indicator		
2005-12-14 14:37:51	HW Monitor	Fail Forward On		
2005-12-14 14:38:30	AAC-1240-VCEA01	Complete Set	00:04:39	
2005-12-14 14:42:42	152-142-000-136	HTTP Log In		
2005-12-14 14:43:41	AAC-1240-VCEA01	Start Indicator		
2005-12-14 14:43:50	HW Monitor	Fail Forward On		
2005-12-14 14:48:29	AAC-1240-VCEA01	Complete Set	00:00:29	
2005-12-14 14:48:35	AAC-1240-VCEA01	Start Indicator		
2005-12-14 14:48:58	AAC-1240-VCEA01	Start Volume		
2005-12-14 14:52:00	R5232 Terminal	VT100 Log In		
2005-12-14 14:53:30	HW Monitor	Fail Forward On		
2005-12-14 14:53:34	152-142-000-136	HTTP Log In		
2005-12-14 14:53:34	HW Monitor	Fail Forward On		

## 6.8.7 Generate Test Event

Use this feature is to generate events for testing purposes.

# WEB BROWSER-BASED CONFIGURATION



## 6.8.8 Clear Events Buffer



Use this feature to clear the entire events buffer information.

## 6.8.9 Modify Password

To set or change the SATA RAID controller password, select “Raid System Function” from the menu and click on the “Change Password” link. The Modify System Password screen appears.

**The manufacture default password is set to 0000.** The password option allows user to set or clear the SATA RAID controller’s password protection feature. Once the password has been set, the user can only monitor and configure the SATA RAID controller by providing the correct password.

The password is used to protect the SATA RAID controller from unauthorized entry. The controller will check the password only when entering the Main menu from the initial screen. The SATA

# WEB BROWSER-BASED CONFIGURATION

RAID controller will automatically go back to the initial screen when it does not receive any command in ten seconds. To disable the password, leave the fields blank. Once the user confirms the operation and clicks the Submit button, the existing password will be cleared. Then, no password checking will occur when entering the main menu from the starting screen.



## 6.8.10 Update Firmware

Please reference the appendix A firmware utility.



## 6.9 Information

### 6.9.1 RaidSet Hierarchy

Use this feature to view the SATA RAID controller current raid set, current volume set and physical disk configuration. Please reference the this chapter "**Configuring Raid Sets and Volume Sets**"

# WEB BROWSER-BASED CONFIGURATION

The screenshot displays the 'RAID Controller Information' screen. On the left is a navigation menu with links for 'Quick Overview', 'RAID Controller Information', 'RAID Controller Configuration', 'Physical Drives', and 'RAID Controller Details'. The main content area shows the 'RAID Controller Information' section with a table of RAID sets and a detailed 'RAID Channels' table.

RAID Set	RAID Channels	Volume Set/RAID Level	Volume State	Capacity
RAID Set # 01	Ch01	Volume Set # 01 (RAID 0)	Normal	100 GB
	Ch02	Volume Set # 01 (RAID 0)	Normal	100 GB
	Ch03	Volume Set # 01 (RAID 0)	Normal	100 GB
	Ch04			
	Ch05			
	Ch06			
	Ch07			
	Ch08			
	Ch09			
	Ch10			
	Ch11			
	Ch12			
	Ch13			
	Ch14			
	Ch15			
	Ch16			
	Ch17			
	Ch18			

Channel	Stage	Capacity	Model
Ch01	RAID Set # 01	100 GB	Marvell C710 (RAID)
Ch02	RAID Set # 01	100 GB	Marvell C710 (RAID)
Ch03	RAID Set # 01	100 GB	Marvell C710 (RAID)
Ch04	RAID Set # 01	100 GB	Marvell C710 (RAID)
Ch05	RAID Set # 01	100 GB	Marvell C710 (RAID)
Ch06	RAID Set # 01	100 GB	Marvell C710 (RAID)
Ch07	RAID Set # 01	100 GB	Marvell C710 (RAID)
Ch08	RAID Set # 01	100 GB	Marvell C710 (RAID)
Ch09	RAID Set # 01	100 GB	Marvell C710 (RAID)
Ch10	RAID Set # 01	100 GB	Marvell C710 (RAID)
Ch11	RAID Set # 01	100 GB	Marvell C710 (RAID)
Ch12	RAID Set # 01	100 GB	Marvell C710 (RAID)
Ch13	RAID Set # 01	100 GB	Marvell C710 (RAID)
Ch14	RAID Set # 01	100 GB	Marvell C710 (RAID)
Ch15	RAID Set # 01	100 GB	Marvell C710 (RAID)
Ch16	RAID Set # 01	100 GB	Marvell C710 (RAID)
Ch17	RAID Set # 01	100 GB	Marvell C710 (RAID)
Ch18	RAID Set # 01	100 GB	Marvell C710 (RAID)

## 6.9.2 System Information

To view the SATA RAID controller's information, move the mouse cursor to the main menu and click on the "System Information" link. The "SATA RAID controller Information" screen appears.

Use this feature to view the SATA RAID controller's information. The controller name, firmware version, serial number, main processor, CPU data/Instruction cache size and system memory size/speed appear in this screen.

The screenshot displays the 'System Information' screen. On the left is a navigation menu with links for 'Quick Overview', 'RAID Controller Information', 'RAID Controller Configuration', 'Physical Drives', and 'RAID Controller Details'. The main content area shows the 'System Information' section with a table of system details.

System Information	Value
Controller Name	JABIC 1200
Firmware Version	V1.10 2004.01.01
BOOT ROM Version	V1.10 2004.01.01
Serial Number	EM112ABIC10000000
Main Processor	INTEL Celeron
CPU Cache Size	1024 bytes
CPU Cache Speed	1000 MHz / 1000 MHz
System Memory	2048 MB / 1000 MHz
Channel ID Address	0x1000.0114

# WEB BROWSER-BASED CONFIGURATION

## 6.9.3 Hardware Monitor

To view the RAID controller's hardware monitor information, move the mouse cursor to the main menu and click the "Hardware Monitor" link. The "Hardware Information" screen appears.

The "Hardware Monitor Information" provides the temperature, and fan speed (I/O Processor fan) of the SATA RAID controller.



The screenshot displays the "Hardware Information" page from the Areca Technology Corporation web interface. The page features a navigation menu on the left with options like "Check Firmware", "Update Firmware", "Advanced Features", "Physical Drive", "System Control", "Diagnostics", "RAID Settings", "System Information", and "Hardware Monitor". The main content area shows a table of hardware information.

Hardware Information	
Firmware Version	1010A.B010
Subsystem Status	OK
RAID0 Temperature	30.9°C
RAID1 Temperature	30.9°C
RAID2 Temperature	30.9°C
RAID3 Temperature	30.9°C
RAID4 Temperature	30.9°C
RAID5 Temperature	30.9°C
RAID6 Temperature	30.9°C
RAID7 Temperature	30.9°C
RAID8 Temperature	30.9°C
RAID9 Temperature	30.9°C
RAID10 Temperature	30.9°C
RAID11 Temperature	30.9°C
RAID12 Temperature	30.9°C
RAID13 Temperature	30.9°C
RAID14 Temperature	30.9°C
RAID15 Temperature	30.9°C
RAID16 Temperature	30.9°C

## Appendix A

### Upgrading Flash ROM Update Process

Since the SATA RAID controller features flash firmware, it is not necessary to change the hardware flash chip in order to upgrade the RAID firmware. The user can simply re-program the old firmware through the In-Band PCI-X/PCIe bus or Out-of-Band Ethernet port McRAID Storage manager. New releases of the firmware are available in the form of a DOS file on the shipped CD or Areca's web site. The files available at the FTP site for each model contain the following files in each version:

ARCXXXNNN.BIN Software Binary Code (where "XXXX" refers to the model name and "NNNN" refers to the software code type)

ARCXXXBIOS.BIN :→ PCI card BIOS for system board using

ARCXXXBOOT.BIN :→ RAID controller hardware initialization

ARCXXXFIRM.BIN :→ RAID kernel program

ARCXXXMBRO.BIN:→ Master Boot Record for supporting Dual Flash Image in the SATA II RAID controller

README.TXT contains the history information of the software code change in the main directory. Read this file first to make sure you are upgrading to the proper binary file. Select the right file for the upgrade. Normally, user upgrades the ARCXXXBIOS.BIN for system M/B compatibility and ARCXXXFIRM.BIN for RAID function upgrades.

#### **Note:**

Please update all Binary Code (BIOS, BOOT and FIRM) before you reboot system. Otherwise, a mixed firmware package may hang the controller.

### Upgrading Firmware Through McRAID Storage Manager

Get the new version firmware for your SAS RAID controller. For example, download the bin file from your OEM's web site onto the C: drive

# APPENDIX

---



1. To upgrade the SAS RAID controller firmware, move the mouse cursor to "Upgrade Firmware" link. The "Upgrade The Raid System Firmware" screen appears.
2. Click Browse. Look in the location to which the Firmware upgrade software was downloaded. Select the File name and click "Open".
3. Click "Confirm The Operation" and press the "Submit" button.
4. The Web Browser begins to download the firmware binary to the controller and start to update the flash ROM.
5. After the firmware upgrade is complete, a bar indicator will show "Firmware Has Been Updated Successfully"
6. After the new firmware completes downloading, find a chance to restart the controller/computer for the new firmware to take effect.

The Web Browser-based McRAID Storage Manager can be accessed through the In-Band PCI-X/PCIe bus or Out-of-Band Lan port. The In-Band method uses the ArchHttp proxy server to launch the McRAID Storage Manager. The Out-of-Band method allows local or remote to access the McRAID Storage Manager from any standard internet browser via a LAN or WAN with no software or patches required.

Controller with onboard Lan port, you can directly plug an Ethernet cable to the controller Lan port, then enter the McBIOS management to configure the network setting. After network setting configured and saved, you can find the current IP address in the System Information page.



From a remote pc, you can directly open a web browser and enter the IP address. Then enter user name and password to login and start your management. You can find the firmware update feature in the browser console, System Controls.

## **Upgrading Entire Flash ROM Image Through Arcflash DOS Utility**

Areca now offers an alternative means of communication for the PCI-X/PCIe SATA RAID controller – Upgrade the entire Flash ROM image. User can upgrade the entire Flash ROM image without needing system starting up running the ArcHttp proxy. The Arcflash utility program is a DOS application, which runs in the DOS operating system. To ensure proper communications between the PCI-X/PCIe SATA RAID controller and upgrade DOS utility, Please make a bootable DOS floppy diskette from other Windows operating system and boot up the system from this bootable DOS floppy diskette.

New releases Flash ROM image is available in the form of a DOS file. The file available for each model contains the following format in each version:

ARCXXXROM.BIN:→ Flash ROM Image Binary Code (where “XXXX” refers to the model name)

Normally, Areca strongly recommends customer uses the McRAID manager to upgrade the firmware. ARCXXXROM.BIN doesn't include in the shipped CD and Areca's web site. It is for customer's emergency recover purpose only.

### **● Hardware Setup**

To ensure proper communications between the RAID adapter and the DOS arcflash utility program, Short the Mode 0 Flash jumper cap in the manufacture port to enter the upgrading entire flash ROM function. Please be sure of removing the cap after you completed the flash ROM image. This way let the Adapter work in the normal mode.

# APPENDIX

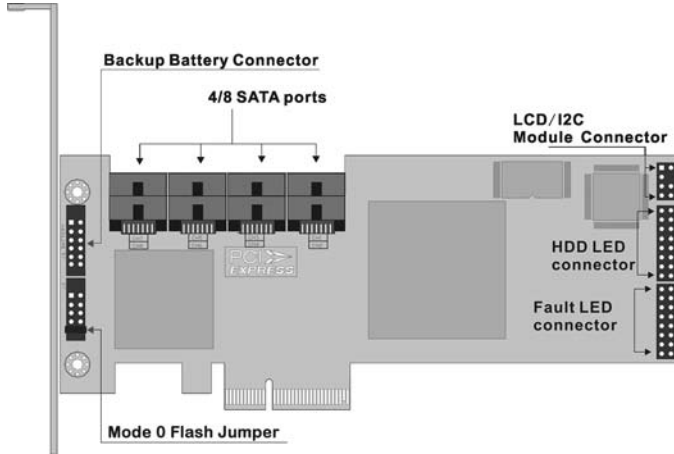

## ● Mode 0 Flash Jumper function:

Short: Causes cpu core to be held in rest (mode 0). Arcflash utility can upgrade the entire Flash ROM image.  
Open: This is the normal default board operation.  
The jumper name for each adapter to upgrade entire flash ROM image as following:

ARC-1110/1120/1210/1220/1170 for 4/8/24 ports → J3  
ARC-1130(ML)/1160(ML)/1230/1260 for 12/16 ports → J7  
ARC-1230ML/1260ML/1280ML/1280 for 12/16/24 ports → J2

### **Note:**

The Mode 0 Flash jumper is a 2x5 connector without housing, located on the left of card near bracket. The header size is 0.65mm and pitch size is 2.54mm.

## ● Starting the Arcflash Utility

Arcflash utility provides an on-line table of contents, providing brief descriptions of the help sub-commands. You can use the <arcflash> /? to get detail information about the command. Typical output looks as below:

```
D:\1.39>arcflash /?
Raid Controller Flash Utility
V1.22 2005-3-17
Command Usage:
ARCFLASH /s FileName --> save binary
ARCFLASH /s FileName /cn --> n=0,1,2,3 save binary for controller#0,1,2,3
ARCFLASH /p FileName --> write binary
ARCFLASH /p FileName /cn --> n=0,1,2,3 write binary to controller#0,1,2,3
```

## ● Flash Procedure

1. Power off system and remove power cable.
2. Take RAID controller out.
3. Set a Close Cap on the J3/J7 2x5 connector.
4. Plug RAID controller back to M/B.
5. Reconnect power cable and boot up from DOS.
6. Flash controller.
7. After flash procedure completed, then power off system.
8. Remove power cable then take Raid controller out and remove the close cap.
9. Plug Raid controller back to M/B, connect power cable, and power on your system.

# APPENDIX

## Appendix B

### Battery Backup Module (ARC-6120-BAT)

The SATA RAID controller operates using cache memory. The battery Backup Module is an add-on module that provides power to the SATA RAID controller cache memory in the event of a power failure. The Battery Backup Module monitors the write back cache on the SATA RAID controller, and provides power to the cache memory if it contains data not yet written to the hard drives when power failure occurs.

#### BBM Components

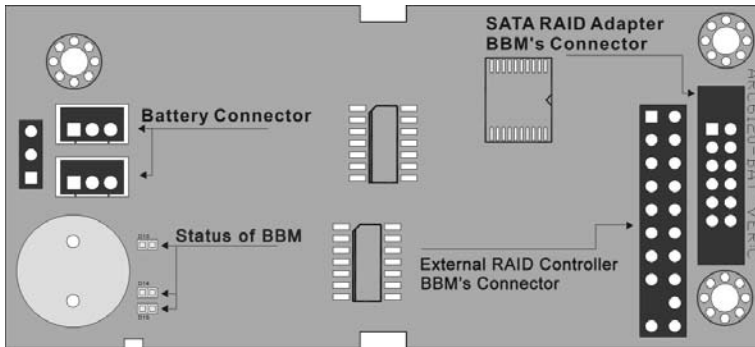

#### BBM Specifications

##### Mechanical

- Module Dimension (W x H x D)  
37.3 x 13 x 81.6 mm
- BBM Connector  
2 \* 6 box header

##### Environmental

- Operating Temperature  
Temperature: -25° C to +60° C
- Humidity: 45-85%, non-condensing
- Storage Temperature  
Temperature: -40° C to 85° C

- Humidity: 45-85%, non-condensing
- Electrical
- Input Voltage  
+3.6VDC
  - On Board Battery Capacity  
1000mAH (1\*1000mAH)

## Installation

1. Make sure all power to the system is disconnected.
2. Connector J1 is available for the optional battery backup module. Connect the BBM cable to the 12-pin battery connector on the controller.

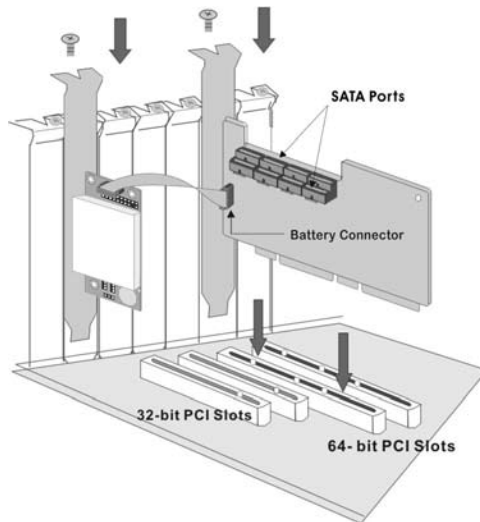

3. Integrators may provide pre-drilled holes in their cabinet for securing the BBM using its three mounting positions.

## Battery Backup Capacity

Battery backup capacity is defined as the maximum duration of a power failure for which data in the cache memory can be maintained by the battery. The BBM's backup capacity varied with the memory chips that installed on the SATA RAID controller.

# APPENDIX

---

Capacity	Memory Type	Battery Backup duration (Hours)
128MB DDR	Low Power (18mA)	56

## Operation

1. Battery conditioning is automatic. There are no manual procedures for battery conditioning or preconditioning to be performed by the user.
2. In order to make sure of all the capacity is available for your battery cells, allow the battery cell to be fully charged when installed for the first time. The first time charge of a battery cell takes about 24 hours to complete.

## Changing the Battery Backup Module

At some point, the LI-ION battery will no longer accept a charge properly. LI-ION battery life expectancy is anywhere from approximately 1 to 5 years.

1. Shutdown the operating system properly. Make sure that cache memory has been flushed.
2. Disconnect the battery backup module cable from J2 on the SATA RAID controller.
3. Disconnect the battery pack cable from JP2 on the Battery Backup Module.
4. Install a new battery pack and connect the new battery pack to JP2.
5. Connect the Battery Backup Module to J2 on the SATA RAID controller.
6. Disable the write-back function from the BIOS or Utility.

## Status of BBM

- D13 (Green) : lights when BBM activated
- D14 (Green) : lights when BBM charging
- D15 (Green) : lights when BBM normal

## Appendix C

### SNMP Operation & Definition

#### Overview

The McRAID manager includes a firmware-embedded Simple Network Management Protocol (SNMP) agent and SNMP Extension Agent for the SATA RAID controller. An SNMP-based management application (also known as an SNMP manager) can monitor the disk array. An example of An SNMP management application is Hewlett-Packard's Open View. The SNMP Extension Agent can be used to augment the SATA RAID controller if you are already running an SNMP management application at your site.

#### SNMP Definition

SNMP, an IP-based protocol, has a set of commands for getting the status of target devices. The SNMP management platform is called the SNMP manager, and the managed devices have the SNMP agent loaded. Management data is organized in a hierarchical data structure called the management Information Base (MIB). These MIBs are defined and sanctioned by various industry associations. The objective is for all vendors to create products in compliance with these MIBs so that inter-vendor interoperability can be achieved. If a vendor wishes to include additional device information that is not specified in a standard MIB, then that is usually done through MIB extensions.

# APPENDIX

---

## MIB Compilation and Definition File creation

Before the manager application accesses the SATA RAID controller, it is necessary to integrate the MIB into the management application's database of events and status indicator codes. This process is known as compiling the MIB into the application. This process is highly vendor-specific and should be well-covered in the User's Guide of your SNMP application. Ensure the compilation process successfully integrates the contents of the ARECARAID.MIB file into the traps database.

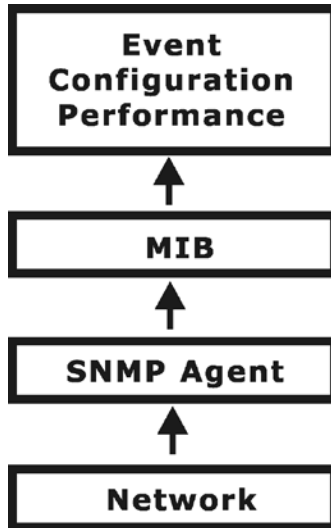

## SNMP Installation

The installation of the SNMP manager is accomplished in several phases:

- Starting the Firmware-embedded SNMP community configuration.
- Installing the SNMP Extension Agent on the server
- Installing the SNMP Manager software on the client
- Placing a copy of the management information base (MIB) in a directory which is accessible to the management application
- Compiling the MIB description file with the management application



## Starting the SNMP function setting



### ● Community Name

Community name acts as a password to screen accesses to the SNMP agent of a particular network device. Type in the community names of the SNMP agent. Before access is granted to a request station, this station must incorporate a valid community name into its request; otherwise, the SNMP agent will deny access to the system.

Most network devices use “public” as default of their community names. This value is case-sensitive.

### SNMP Extension Agent Installation for Windows

You must have administrative level permission to install SATA RAID software. This procedure assumes that the SATA RAID hardware and Windows are both installed and operational in your system. To enable the SNMP agent for Windows, configure Windows for TCP/IP and SNMP services. The ARECA SNMP Extension Agent file is ARCSNMP.DLL.

Screen captures in this section are taken from a Windows XP installation. If you are running another version of Windows, your screens may look different, but the ARECA SNMP Extension Agent installation is essentially the same.

1. Insert the SATA RAID controller CD in the CD-ROM drive.
2. Run the setup.exe file that resides at: <CD-ROM>\packages\

# APPENDIX

---

windows\http\setup.exe on the CD-ROM. (If SNMP service was not installed, please install SNMP service first.)



3. Click on the Setup file then the Welcome screen appears.



4. Click the Setup file and then the "install the program" screen appears. Follow the on-screen prompts to complete ARECA SNMP Extension Agent installation.



5. A Progress bar appears that measures the progress of the ARECA SNMP Extension Agent setup. When this screen complete, you have completed the ARECA SNMP Extension Agent setup.

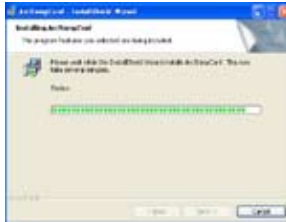

6. After a successful installation, the "Setup Complete" dialog box of the installation program is displayed. Click the **Finish** button to complete the installation.



## Starting SNMP Trap Notification Configurations

To start SNMP Trap Notification Configurations, There have two methods. First, double-click on the Areca Raid Controller.



Second, you may also use the Taskbar Start/programs/Areca Technology Corp/ArcSnmpConf menus shown below.

# APPENDIX

---

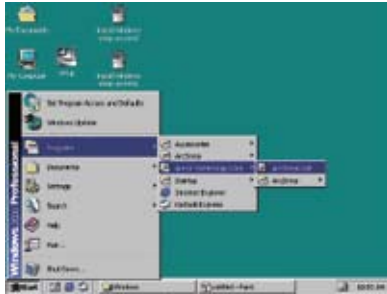

## **SNMP community Configurations**

Please refer to the community name in this appendix.

## **SNMP Trap Notification Configurations**

The Community Name should be the same as firmware-embedded SNMP Community. The SNMP Trap Notification Configurations include level 1: serious, level 2: error, level 3: Warning and level 4: Information. The level 4 covers notification events such as initialization of the controller and initiation of the rebuilding process; Level 3 includes events which require the issuance of warning messages; Level 2 covers notification events which once have happen; Level 1 is the highest level, and covers events the need immediate attention (and action) from the administrator.



## **SNMP Extension Agent Installation for Linux**

You must have administrative level permission to install SATA RAID software. This procedure assumes that the SATA RAID

hardware and Linux are installed and operational in your system. For the SNMP Extension Agent Installation for Linux procedure, please refer to **<CD-ROM>\packages\Linux\SNMP\Readme** or download from **areca.com.tw**

## **SNMP Extension Agent Installation for FreeBSD**

You must have administrative level permission to install SATA RAID software. This procedure assumes that the SATA RAID hardware and FreeBSD are installed and operational in your system. For the SNMP Extension Agent Installation for FreeBSD procedure please refer to **<CD-ROM>\packages\FreeBSD\SNMP\Readme** or download from **areca.com.tw**

# APPENDIX

## Appendix D

### Event Notification Configurations

The controller classifies disk array events into four levels depending on their severity. These include level 1: Urgent, level 2: serious, level 3: Warning and level 4: Information. The level 4 covers notification events such as initialization of the controller and initiation of the rebuilding process; Level 2 covers notification events which once have happen; Level 3 includes events which require the issuance of warning messages; Level 1 is the highest level, and covers events the need immediate attention (and action) from the administrator. The following lists sample events for each level:

#### A. Device Event

Event	Level	Meaning	Action
Device Inserted	Warning	HDD inserted	
Device Removed	Warning	HDD removed	
Reading Error	Warning	HDD reading error	Keep Watching HDD status, maybe it is caused by noise or HDD unstable.
Writing Error	Warning	HDD writing error	Keep Watching HDD status, maybe it is caused by noise or HDD unstable.
ATA Ecc Error	Warning	HDD ECC error	Keep Watching HDD status, maybe it is caused by noise or HDD unstable.
Change ATA Mode	Warning	HDD change ATA mode	Check HDD connection.
Time Out Error	Warning	HDD Time out	Keep Watching HDD status, maybe it is caused by noise or HDD unstable.
Device Failed	Urgent	HDD failure	Replace HDD
PCI Parity Error	Serious	PCI Parity error	If only happen once, it maybe caused by noise. If always happen, please check power supply or contact to us.
Device Failed(SMART)	Urgent	HDD SMART failure	Replace HDD

PassThrough Disk Created	Inform	Pass Through Disk Created	
PassThrough Disk Modified	Inform	Pass Through Disk Modified	
PassThrough Disk Deleted	Inform	Pass Through Disk Deleted	

## B. Volume Event

Event	Level	Meaning	Action
Start Initialize	Warning	Volume initialization has started	
Start Rebuilding	Warning	Volume rebuilding has started	
Start Migrating	Warning	Volume migration has started	
Start Checking	Warning	Volume parity checking has started	
Complete Init	Warning	Volume initialization completed	
Complete Rebuild	Warning	Volume rebuilding completed	
Complete Migrate	Warning	Volume migration completed	
Complete Check	Warning	Volume parity checking completed	
Create Volume	Warning	New Volume Created	
Delete Volume	Warning	Volume deleted	
Modify Volume	Warning	Volume Modified	
Volume Degraded	Urgent	Volume degraded	Replace HDD
Volume Failed	Urgent	Volume failure	
Failed Volume Revived	Urgent	Failed Volume revived	

## C. RAID Set Event

Event	Level	Meaning	Action
Create RaidSet	Warning	New Raidset created	
Delete RaidSet	Warning	Raidset deleted	
Expand RaidSet	Warning	Raidset expanded	
Rebuild RaidSet	Warning	Raidset rebuilding	
RaidSet Degraded	Urgent	Raidset degraded	Replace HDD

# APPENDIX

---

---

## D. Hardware Event

Event	Level	Meaning	Action
DRAM 1-Bit ECC	Urgent	DRAM 1-Bit ECC error.	Check DRAM
DRAM Fatal Error	Urgent	DRAM fatal error encountered.	Check the DRAM module and replace with new one if required.
Raid Powered On	Warning	Raid Power On	
Test Event	Urgent	Test Event	

**Note:**

It depends on models, not every model will encounter all events.



## Appendix E

### General Troubleshooting Tips

Most of controller errors are traceable to external factors, such as conflicts with other installed cards, motherboard incompatibility, bad or incorrectly configured drives, loose cables, improper controller installation, or other installation errors.

To troubleshoot SATA RAID controller problems, try simplifying your hardware configuration by removing some other devices from the system and then adding them back one at a time.

Look for the latest information on SATA RAID Controllers as well as the newest drivers on the ARECA web site at <http://www.areca.com.tw>. The following general guidelines are for some specific error conditions:

**Q1: The BIOS Message of the SATA RAID controller never appears on the screen**

Answer:

- (1). Ensure the controller is inserted correctly into the PCI slot.
- (2). Ensure 3.3 volts are being supplied to the PCI slot.
- (3). Check the cabling between the SATA drives or enclosure the SATA RAID controller.

**Q2: How many SATA RAID controllers can be installed into a computer system?**

Answer:

Up to 4 RAID controllers in a system are supported.

**Q3: The boot device cannot found**

Answer:

Enter the system BIOS setup utility Per manufacture directions and configure it so that the RAID card volume set is once again selected as the primary boot device (or first in the boot device list)

# APPENDIX

---

## **Q4: What PCI slots are supported by the SATA RAID controllers?**

Answer:

For all PCI-X SATA RAID controllers, install card in a 64-bit/133MHz PCI-X for the best performance. It also can be used in 64-bit / 66 MHz slots, 32-bit/66MHz PCI slots as well as 32-bit/33MHz slots. All PCI-X SATA RAID controllers can not work with 5V PCI slot. PCI-Express SATA RAID controllers require an x8 or x16 slots. The card can function in x4 or x1 signal slots if those slots are open at the end to accept larger x8 cards, but performance will be reduced in these slower slots.

Check the Areca FAQ website for motherboard a compatibility list.

## **Q5: What is the difference between RAID 6 and RAID 5?**

Answer:

RAID 6 allows two drives to fail simultaneously without downtime or data loss. However, RAID 5 only allows one drive to fail. RAID 6 thus provides a much higher level of fault tolerance than RAID 5. It is a perfect solution when data is mission-critical.

Due to this higher level of protection, users can set up larger RAID volumes, spanning up to 56 physical drives. With the ARECA RAID 6 engine, RAID 6 and RAID 5 have similar performance in the SATA RAID controller.

## **Q6: What products support RAID 6?**

Answer:

RAID 6 is available on controller models with the RAID 6 engine installed.

## **Q7: What operating systems are supported?**

Answer:

The SATA RAID controllers support Microsoft® Windows® Server 2003, Windows XP, Windows 2000, Red Hat Linux, SuSE Linux, and FreeBSD. For specific OS versions, see <http://www.areca.com.tw> for more information.

## **Q8: Will ARECA submit the Linux code to kernel.org?**

Answer:

Yes. ARECA Serial ATA II RAID the latest driver has been integrated directly into the Linux kernel 2.6.17-rc3-mm1 (and later), allowing future versions of Linux operating systems to support Areca's entire family PCI-X and PCI-Express series of high performance SATA II RAID controllers.

## **Q9: What is the warranty period?**

Answer:

Like all ARECA External RAID controllers, the PCI-X or PCI-Express SATA RAID controller is backed by a 3-year warranty.

## **Q10: Which O/S (Operating System) will support X86 64-bit processors?**

Answer:

The following O/S vendors have announced product support for AMD64 and Intel EM64T. Contact each vendor for more details. The following is our currently supported OS and version for 64-bit processor. We will support others shortly after other versions release.

### **Microsoft:**

Production support will be available in:

- Windows XP Professional x64 Edition
- Windows Server 2003 64-Bit Edition

### **Red Hat:**

Production support will be available in:

- Red Hat Enterprise Linux 3 update 2

### **SuSE:**

Production support will be available in:

- SLES9

### **FreeBSD:**

Production support will be available in:

- FreeBSD 5.3

# APPENDIX

---

## **Q11: Is it possible to write software that will run on Intel's processors with Intel® EM64T, and AMD's 64-bit capable processors?**

Answer:

Yes, in most cases. Even though the hardware microarchitecture for each company's processor is different, the operating system and software ported to one processor will likely run on the other processor due to the close similarity of the instruction set architectures. However, Intel processors support additional features, like the SSE3 instructions and Hyper-Threading Technology, which are not supported on non-Intel platforms. As such, we believe developers will achieve maximum performance and stability by designing specifically for Intel architectures and by taking advantage of Intel's breadth of software tools and enabling services.

## **Q12: How will Intel® EM64T work and what software is there to take advantage of 64-bit extensions?**

Answer:

Platforms with Intel® EM64T/AMD64 can be run in three basic ways (note: a 64-bit capable BIOS is required for all three scenarios):

1. 32-bit O/S and 32-bit applications (Legacy Mode): No software changes are required, however the user gets no benefit from Intel® EM64T or AMD64.
  2. 64-bit O/S and 32-bit applications (Compatibility Mode): This usage requires all 64-bit device drivers. In this mode, the O/S will see the 64-bit extensions, but the 32-bit application will not. Existing 32-bit applications do not need to be recompiled, and may or may not benefit from the 64-bit extensions. The application will likely need to be recertified by the vendor to run on the new 64-bit extended O/S.
  3. 64-bit O/S and 64-bit applications (64-bit Mode): This usage requires 64-bit device drivers. It also requires applications to be modified for 64-bit operation and then recompiled and validated.
- **For more FAQs, please visit knowledgebase of Areca website at: <http://faq.areca.com.tw/modules/smartfaq/>**

## Appendix F

### Technical Support

Areca Technical Support provides several options for Areca users to access information and updates. We encourage you to use one of our electric services, which provide product information updates for the most efficient service and support. If you decide to contact us, please have the information such as Product model and serial number, BIOS and driver version, and a description of the problem at **<http://www.areca.com.tw/support/index/question.htm>**. All technical support questions will receive a response from our support team.

# GLOSSARY

---

## Glossary

### 2TB

The 32-bit file systems have a maximum limitation of 2 TB per volume set. 64-bit versions remove this limitation. so, if you are building large warehouses, you should consider 64-bit versions.

### Array

An array is a logical disk comprised of multiple physical hard disks. The number of hard disks in an array is dictated by the type of the array and the number of spares that may be assigned to it. (Arrays are also sometimes referred to as containers). Furthermore, whether an array can be built using part of the space on a disk (as opposed to being forced to use the whole disk) depends upon the implementation. Arrays are typically used to provide data redundancy and/or enhanced I/O performance.

### ATA

Acronym for "**AT Bus Attachment**" - a standard interface to IDE hard disks. Western Digital's IDE disk interface was standardized by ANSI to form the ATA specification using a 16-bit ISA bus.

### Auto Reassign Sector

SATA drives perform automatic defect re-assignment for both read and write errors. Writes are always completed - if a location to be written is found to be defective, the drive will automatically relocate that write command to a new location and map out the defective location. If there is a recoverable read error, the correct data will be transferred to the host and that location will be tested by the drive to be certain the location is not defective - if it is found to have a defect, it will be automatically relocated to a new location and the defective location mapped out. In the event of an unrecoverable read error, the error will be reported to the host and the location flagged as potentially defective. A subsequent write to that location will initiate a sector test and relocation should that location have a defect.

## **Battery Backup Module**

Many modern RAID controllers are armed with a battery backup Module (BBM). While an UPS protects most servers from power fluctuations or failures, a BBM provides an additional level of protection. In the event of a power failure, a BBM supplies power to retain data in the RAID controller's cache, thereby permitting any potentially dirty data in the cache to be flushed out to secondary storage when power is restored.

## **BIOS**

(Basic Input/Output System) software is stored on a chip and provides an interface between the operating system and the hardware. Usually the BIOS is built into a ROM chip installed on the motherboard so that the BIOS will always be available and not affected by disk failure.

## **Cache**

Controller memory used to speed up data transfer to and from a disk.

## **Consistency Check**

In RAID, check consistency verifies the correctness of redundant data in an array. For example, in a system with dedicated parity, checking consistency means computing the parity of the data drives and comparing the results to the contents of the dedicated parity drive.

## **Driver**

It is a piece of software – that is often executed in kernel mode – that controls a hardware device. Typically drivers provide an interface by which applications can use the device in a uniform and hardware-independent manner.

### **Hot Spare**

An extra physical disk drive in a RAID configuration that the controller can use to automatically rebuild a system drive when another drive fails. The hot spare drive must have at least as much capacity as the largest disk drive in the array or the rebuild may not start.

# GLOSSARY

---

## Hot Spare

An extra physical disk drive in a RAID configuration that a controller can use to automatically rebuild a system drive when another drive fails. The hot spare drive must have at least as much capacity as the largest disk drive in the array or the rebuild will not start.

## Hardware RAID versus Software RAID

Beyond the different types of RAID, there are two implementation forms: hardware-based and software-based. Hardware-based RAID is obviously implemented at a physical level, whereas software-based RAID is done using the operating system. It is always optimal to have RAID done at a physical (hardware) level.

## Hot Swap

To pull out a component from a system and plug in a new one while the power is still on and the unit is still operating.

## NVRAM

(Non-Volatile Random Access Memory) A memory unit is equipped with a battery so that the data remain even after the main power had been switched off. Actually an EEPROM used to store configuration information.

## Parity

A technique used to protect a system from data loss due to faults. When parity is implemented (RAID3 and RAID5), data written is logically XOR'd together to calculate parity, which is stored on the drives along with the data. In a system with three drives, the data is written to two drives and the calculated parity is stored on a third drive. If one drive fails, data on the failed drive is reconstructed from other data and parity.

## PCI Express

An advanced version of the PCI bus introduced in 2002. Rather than the shared, parallel bus structure of PCI, PCI Express provides a high-



speed, switched architecture. Each PCI Express link is a serial communications channel made up of two differential wire pairs that provide 2.5 Gbits/sec in each direction. Up to 32 channels may be combined, creating a parallel interface of independently controlled serial links.

## **PCI-X**

(PCI extended) an enhanced PCI bus technology is backward compatible with existing PCI cards. PCI and PCI-X slots are physically the same. PCI cards run in PCI-X slots, and PCI-X cards run in PCI slots at the slower PCI rates. First introduced in 1999, PCI-X offered increased speed over PCI and has steadily increased to more than 30 times that of the original PCI bus.

## **RAID**

(Redundant Array of Independent Disks) a disk subsystem that is used to increase performance or provide fault tolerance. RAID can also be set up to provide both functions at the same time. RAID is a set of two or more ordinary hard disks and a specialized disk controller that contains the RAID functionality. RAID has been developed initially for servers and stand-alone disk storage systems. RAID is important especially when rebuilding data after a disk failure.

## **Rebuild**

When a RAID array enters into a degraded mode, it is advisable to rebuild the array and return it to its original configuration (in terms of the number and state of working disks) to ensure against operation in degraded mode.

## **SATA (Serial ATA)**

The evolution of the ATA (IDE) interface that changes the physical architecture from parallel to serial and from master-slave to point-to-point. Unlike parallel ATA interfaces that connect two drives; one configured as master, the other as slave, each Serial ATA drive is connected to its own interface. At initial introduction, Serial ATA (SATA) increases the transfer rate to 150 MB/sec (1.5Gb/s) and SATA2 to 300 MB/sec.

# GLOSSARY

---

## **SMART**

This technology provides users with advanced warning of Disk Drive failures, thus enabling the Operating System to warn Users of potential failure. S.M.A.R.T. was included in EIDE drives with the ATA-3 and later specification.

## **SNMP**

Since it was developed in 1988, the Simple Network Management Protocol has become the de facto standard for inter-network management. Because it is a simple solution, requiring little code to implement, vendors can easily build SNMP agents into their products. SNMP is extensible, allowing vendors to easily add network management functions to their existing products. SNMP also separates the management architecture from the architecture of the hardware devices, which broadens the base of multi-vendor support.

## **Volume Set**

A volume set is a concatenation of storage elements that may be RAID arrays, JBODs, or simply areas of disks that are not part of RAID arrays.

## **Write-back**

When a cache is operating in write-back mode, data written into the cache is not immediately written out to its destination in secondary storage unless the heuristics governing the flushing of dirty data demands otherwise. This methodology can improve the efficiency of write operations under favorable circumstances. However, its use can potentially lead to incoherences in a system that is not protected from power fluctuations or other failures.

## **Write-through**

When a cache is operating in write-through mode, data written into the cache is also written to the destination secondary storage devices. Essentially write completion does not occur until the data is written to secondary storage. Thus the contents of the cache and the secondary storage are always consistent. The advantage is that the possibility

of data corruption is greatly reduced. The disadvantage is that write-through operations are more time consuming.

## **XOR-Engine**

All RAID arrays (with the exception of RAID 0, RAID 1 and RAID 1E) require parity to be calculated and written to the array in conjunction with data. Typically the parity is a simple XOR on the bytes comprising a stripe. This is a computationally intensive operation that many modern RAID controllers perform using a dedicated ASIC (instead of calculating them in firmware on the main embedded processor's core). This dedicated ASIC is often referred to as a XOR-engine.

# History

---

## Version History

<b>Revision</b>	<b>Page</b>	<b>Description</b>
3.2	P117-120	Added ArchHttp Configuration
3.2	P116	Added Mac OS 10.x information
3.2	P82,134	Added expand an existing volume noticed
3.2	p34	Added illustration of ARC-1210ML/1220ML
3.2	p37, p46, p47	Revised illustration of ARC-1231ML/1261ML/1280ML/1280
3.2	p43, p44	Revised figure 2-15, added figure 2-17