

# TOSHIBA

FILE NO. A03-007

## SERVICE MANUAL

# AIR-CONDITIONER

## SPLIT TYPE

***RAV-SM561BT-E/RAV-SM560AT-E***  
***RAV-SM801BT-E/RAV-SM800AT-E***  
***RAV-SM1101BT-E/RAV-SM1100AT-E***  
***RAV-SM1401BT-E/RAV-SM1400AT-E***

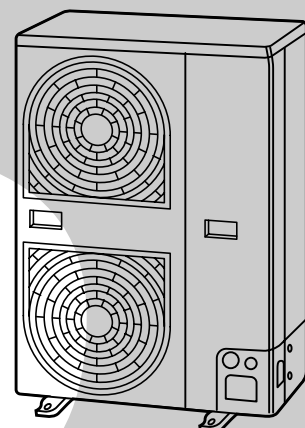
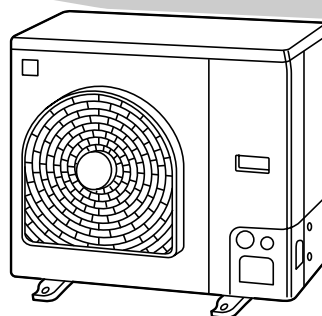
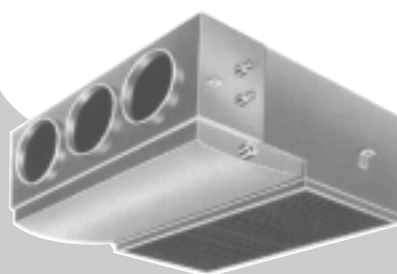

# CONTENTS

1. SPECIFICATIONS .....	1
2. AIR DUCTING WORK .....	7
3. CONSTRUCTION VIEWS (EXTERNAL VIEWS) .....	9
4. SYSTEMATIC REFRIGERATING CYCLE DIAGRAM .....	13
5. WIRING DIAGRAM .....	17
6. SPECIFICATIONS OF ELECTRICAL PARTS .....	21
7. REFRIGERANT R410A .....	23
8. INDOOR UNIT CONTROL .....	31
9. OUTDOOR CONTROL .....	40
10. TROUBLESHOOTING .....	47
11. REPLACEMENT OF SERVICE INDOOR P.C. BOARD .....	70
12. SETUP AT LOCAL SITE AND OTHERS .....	74
13. ADDRESS SETUP .....	84
14. DETACHMENTS.....	88
15. EXPLODED VIEWS AND PARTS LIST .....	114

# 1. SPECIFICATIONS

## 1-1. Indoor Unit

### Concealed Duct Type

Model name		RAV-SM561BT-E			RAV-SM801BT-E			
Standard capacity (Note 1)	(kW)	Cooling	Heating	Average	Cooling	Heating	Average	
		5.0 (1.5 – 5.6)	5.6 (1.5 – 6.3)		7.1 (2.2 – 8.0)	8.0 (2.2 – 9.0)		
Heating low temp. capacity (Note 1) (kW)		4.6			6.2			
Energy consumption effect ratio (Cooling)		2.81 [C]	3.27 [C]	3.04	2.81 [C]	3.32 [C]	3.07	
Electrical characteristics	Power supply		1 phase 230V (220 – 240V) 50Hz					
	Running current	(A)	8.99–8.24	8.18–7.50		12.25–11.21	11.65–10.68	
	Power consumption	(kW)	1.78	1.71		2.53	2.41	
	(Low temp.)	(kW)	1.98			2.86		
	Power factor	(%)	95	95		94	94	
Appearance	Main unit		Zinc hot dipping steel plate					
	Ceiling Panel (Sold separately)	Model	—					
		Panel color	—					
Outer dimension	Main unit	Height	(mm)	320		320		
		Width	(mm)	700		1000		
		Depth	(mm)	800		800		
	Ceiling panel (Sold separately)	Height	(mm)	—				
		Width	(mm)	—				
		Depth	(mm)	—				
Total weight	Main unit		(kg)	30		39		
	Ceiling panel			—				
Heat exchanger		Finned tubu						
Soundproof/Heat-insulating material		Inflammable polyethylene foam						
Fan unit	Fan		Multi-blade fan					
	Standard air flow High (Mid./Low)		(m <sup>3</sup> /h)	840		1140		
	Motor		(W)	120		120		
Air filter		Attached main unit						
Controller (Sold separately)		RBC-AMT21E						
Connecting pipe	Gas side		(mm)	Ø12.7 (1/2")		Ø15.9 (5/8")		
	Liquid side		(mm)	Ø6.4 (1/4")		Ø9.5 (3/8")		
	Drain port		(Nominal dia.)	25 (Polyvinyl chloride tube)				
Sound level	High (Mid./Low) (Note 2)	(dB•A)	42	39	36	43	40	37

**Note 1** : The cooling capacities and electrical characteristics are measured under the conditions specified by JIS B 8616 based on the reference piping 7.5m.

**Note 2** : The sound level is measured in an anechoic chamber in accordance with JIS B8616. Normally, the values measured in the actual operating environment become larger than the indicated values due to the effects of external sound.

**Note** : Rated conditions Cooling : Indoor air temperature 27°C DB/19°C WB, Outdoor air temperature 35°C DB  
Heating : Indoor air temperature 20°C DB, Outdoor air temperature 7°C DB/6°C WB

Model name		RAV-SM1101BT-E			RAV-SM1401BT-E		
Standard capacity (Note 1) (kW)		Cooling	Heating	Average	Cooling	Heating	Average
		10.0 (2.2 – 11.2)	11.2 (2.2 – 12.5)		12.5 (3.0 – 13.2)	14.0 (3.0 – 16.0)	
Heating low temp. capacity (Note 1) (kW)		8.7			11.8		
Energy consumption effect ratio (Cooling)		2.81 [C]	3.57 [B]	3.19	2.83 [C]	3.47 [B]	3.15
Electrical characteristics	Power supply	1 phase 230V (220 – 240V) 50Hz					
	Running current (A)	16.5–15.1	14.6–13.4		20.7–19.0	18.9–17.3	
	Power consumption (kW)	3.56	3.14		4.42	4.03	
	(Low temp.) (kW)	3.50			4.18		
	Power factor (%)	98	98		97	97	
Appearance	Main unit	Zinc hot dipping steel plate					
	Ceiling Panel (Sold separately)	Model	—				
		Panel color	—				
Outer dimension	Main unit	Height (mm)	320				
		Width (mm)	1340				
		Depth (mm)	800				
	Ceiling panel (Sold separately)	Height (mm)	—				
		Width (mm)	—				
		Depth (mm)	—				
Total weight	Main unit (kg)	54			54		
	Ceiling panel	—					
Heat exchanger		Finned tubu					
Soundproof/Heat-insulating material		Inflammable polyethylene foam					
Fan unit	Fan	Multi-blade fan					
	Standard air flow High (Mid./Low) (m <sup>3</sup> /h)	1620			1980		
	Motor (W)	120			120		
Air filter		Attached main unit					
Controller (Sold separately)		RBC-AMT21E					
Connecting pipe	Gas side (mm)	Ø15.9 (5/8")					
	Liquid side (mm)	Ø9.5 (3/8")					
	Drain port (Nominal dia.)	25 (Polyvinyl chloride tube)					
Sound level	High (Mid./Low) (Note 2) (dB•A)	42	39	36	44	41	38

**Note 1** : The cooling capacities and electrical characteristics are measured under the conditions specified by JIS B 8616 based on the reference piping 7.5m.

**Note 2** : The sound level is measured in an anechoic chamber in accordance with JIS B8616. Normally, the values measured in the actual operating environment become larger than the indicated values due to the effects of external sound.

**Note** : Rated conditions Cooling : Indoor air temperature 27°C DB/19°C WB, Outdoor air temperature 35°C DB  
Heating : Indoor air temperature 20°C DB, Outdoor air temperature 7°C DB/6°C WB

## 1-2. Outdoor Unit

Model name		RAV-SM560AT-E	RAV-SM800AT-E	
Appearance		Silky shade (Muncel 1Y8.5/0.5)		
Power supply		1 phase 230V (220 – 240V) 50Hz (Power exclusive to outdoor is required.)		
Compressor	Type	Hermetic compressor		
	Motor (kW)	1.1	1.6	
	Pole	8 poles		
Refrigerant charged (kg)		R410A 0.9	R410A 1.5	
Refrigerant control		Pulse motor valve		
Pipe	Standard length	20 (without additional charge)		
	Max. total length (m)	30	50	
	Over 20m	Add 20g/m (Max. 200g)	Add 40g/m (Max. 1200g)	
	Height difference	Outdoor lower (m)	30	
		Outdoor higher (m)	50	
Outer dimension	Height (mm)	595	795	
	Width (mm)	780	780	
	Depth (mm)	270	270	
Total weight (kg)		35	55	
Heat exchanger		Finned tube		
Fan unit	Fan	Propeller fan		
	Standard air flow High (m <sup>3</sup> /h)	2400	3400	
	Motor (W)	43	63	
Connecting pipe	Gas side (mm)	Ø12.7 (1/2")	Ø15.9 (5/8")	
	Liquid side (mm)	Ø6.4 (1/4")	Ø9.5 (3/8")	
Protection device		Discharge temp. sensor Over-current sensor Compressor thermo.		
Sound level (Note 2)	High (Mid./Low) (Cooling/Heating) (dB•A)	46/48	45/50	

**Note 1** : The cooling capacities and electrical characteristics are measured under the conditions specified by JIS B 8616 based on the reference piping 7.5m.

**Note 2** : The sound level is measured in an anechoic chamber in accordance with JIS B8616. Normally, the values measured in the actual operating environment become larger than the indicated values due to the effects of external sound.

**Note** : Rated conditions    Cooling : Indoor air temperature 27°C DB/19°C WB, Outdoor air temperature 35°C DB  
Heating : Indoor air temperature 20°C DB, Outdoor air temperature 7°C DB/6°C WB

Model name		RAV-SM1100AT-E	RAV-SM1400AT-E
Appearance		Silky shade (Muncel 1Y8.5/0.5)	
Power supply		1 phase 230V (220 – 240V) 50Hz (Power exclusive to outdoor is required.)	
Compressor	Type	Hermetic compressor	
	Motor (kW)	2.0	3.75
	Pole	8 poles	
Refrigerant charged (kg)		R410A 2.1	R410A 2.3
Refrigerant control		Pulse motor valve	
Pipe	Standard length	20 (without additional charge)	
	Max. total length (m)	50	
	Over 20m	Add 40g/m (Max. 1200g)	
	Height difference	Outdoor lower (m)	15
Outdoor higher (m)		30	
Outer dimension	Height (mm)	1340	
	Width (mm)	900	
	Depth (mm)	320	
Total weight (kg)		75	85
Heat exchanger		Finned tube	
Fan unit	Fan	2 Propeller fans	
	Standard air flow High (m <sup>3</sup> /h)	6800	7500
	Motor (W)	63 + 43	63 + 63
Connecting pipe	Gas side (mm)	Ø15.9 (5/8")	
	Liquid side (mm)	Ø9.5 (3/8")	
Protection device		Discharge temp. sensor Over-current sensor Compressor thermo.	
Sound level (Note 2)	High (Mid./Low) (Cooling/Heating) (dB•A)	53/54	53/54

**Note 1** : The cooling capacities and electrical characteristics are measured under the conditions specified by JIS B 8616 based on the reference piping 7.5m.

**Note 2** : The sound level is measured in an anechoic chamber in accordance with JIS B8616. Normally, the values measured in the actual operating environment become larger than the indicated values due to the effects of external sound.

**Note** : Rated conditions    Cooling : Indoor air temperature 27°C DB/19°C WB, Outdoor air temperature 35°C DB  
Heating : Indoor air temperature 20°C DB, Outdoor air temperature 7°C DB/6°C WB

### 1-3. Operation Characteristic Curve

#### RAV-SM561BT-E / SM801BT-E

<Cooling>

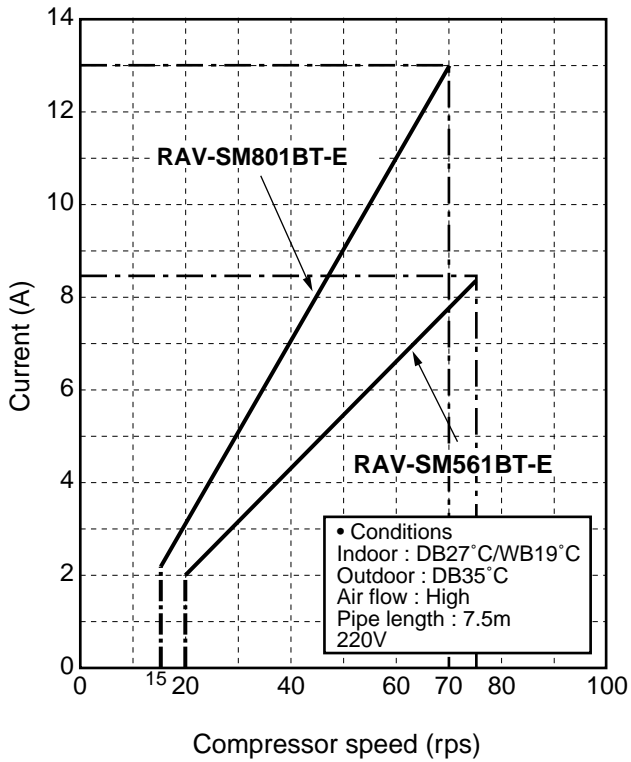

<Heating>

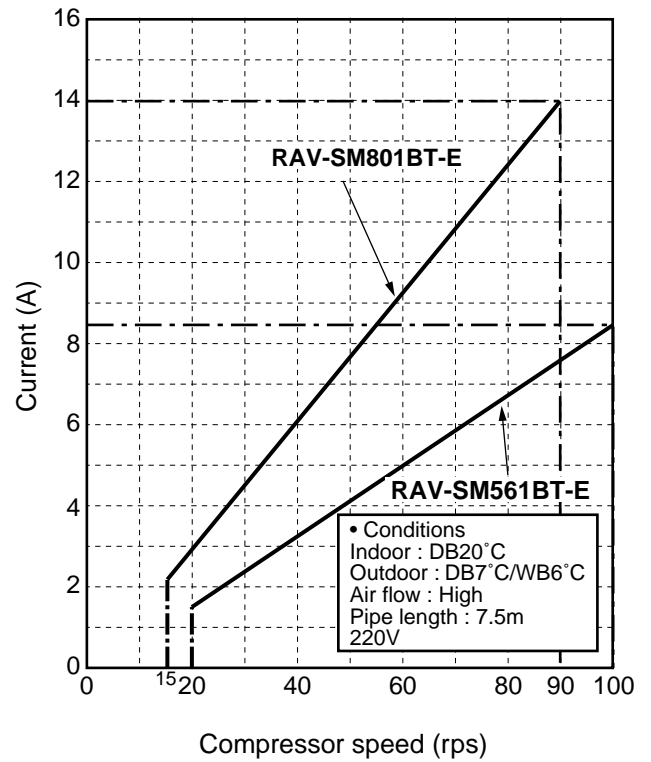

#### RAV-SM1101BT-E

<Cooling>

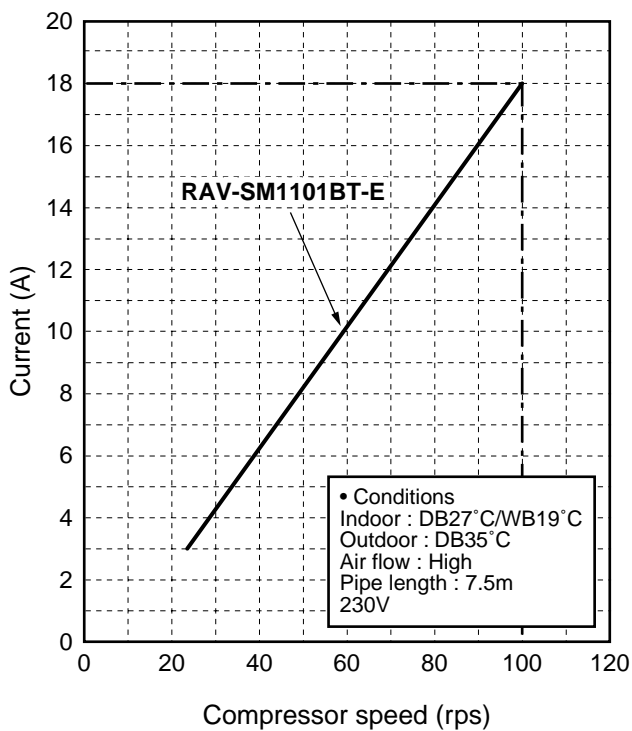

<Heating>

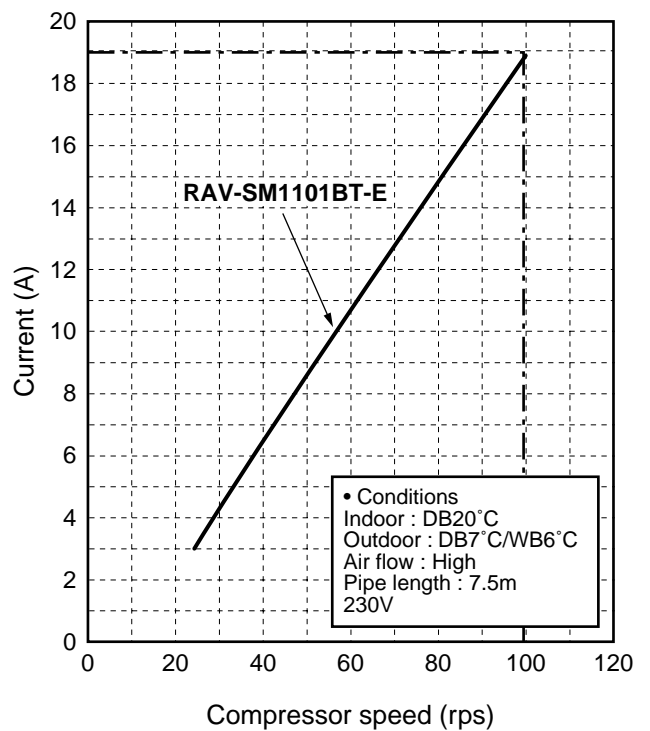

**RAV-SM1401BT-E**

<Cooling>

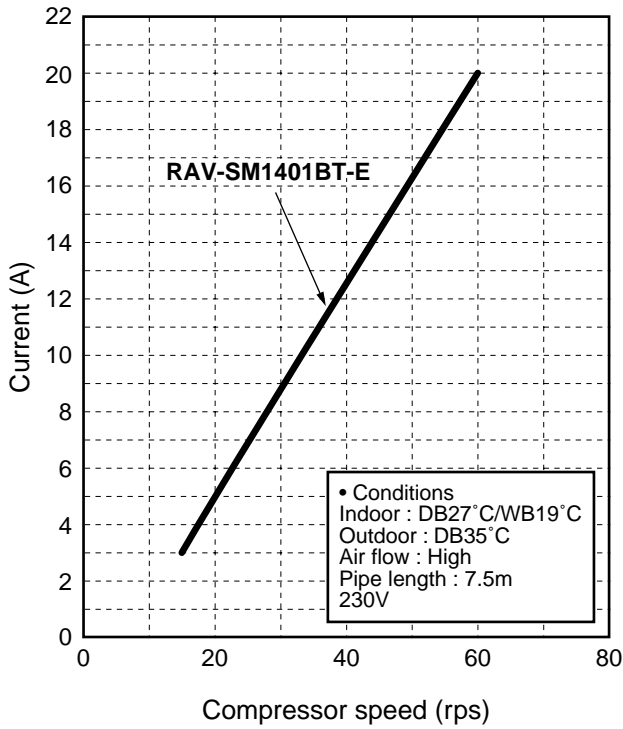

<Heating>

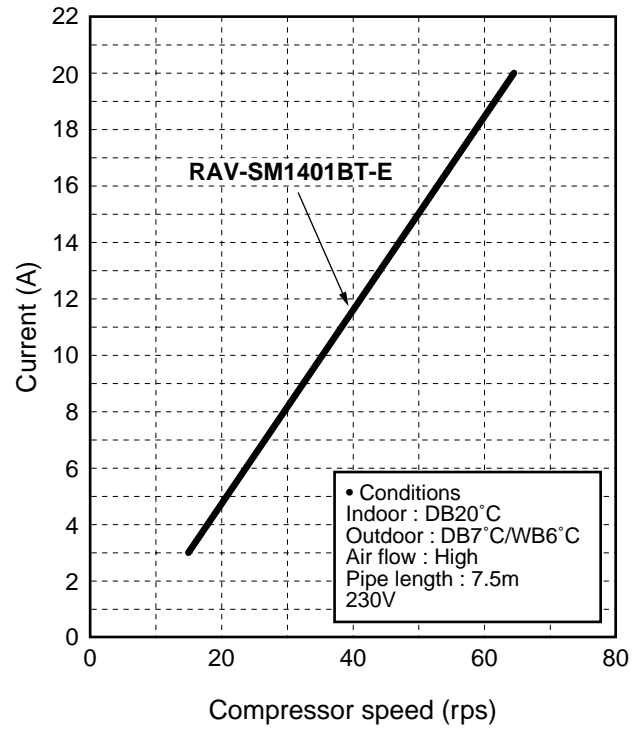

**1-4. Capacity Variation Ratio According to Temperature**

<Cooling>

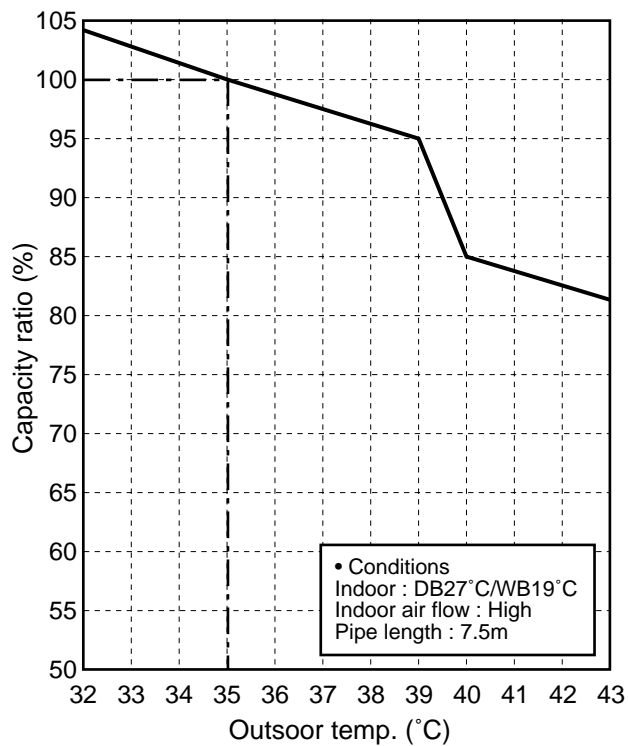

<Heating>

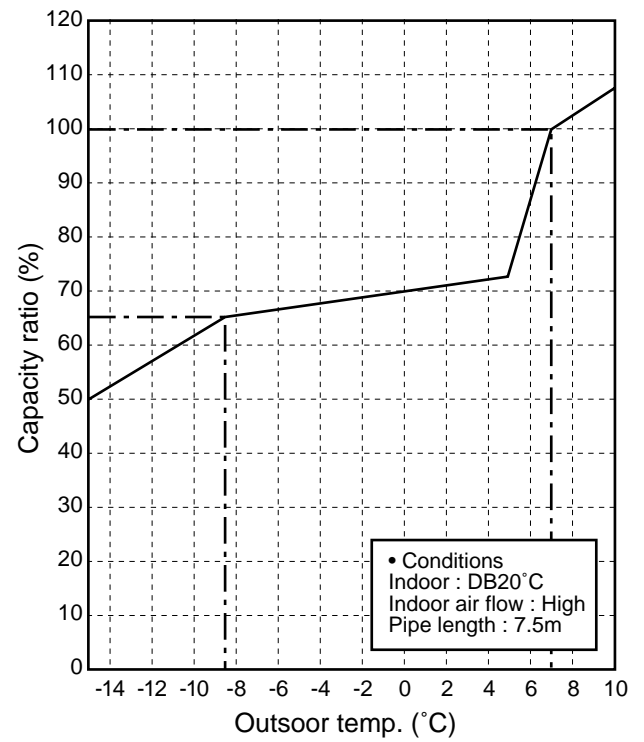



## 2. AIR DUCTING WORK

### 2-1. Static Pressure Characteristics of Each Model

Fig. 1 RAV-SM561BT-E (Round duct)

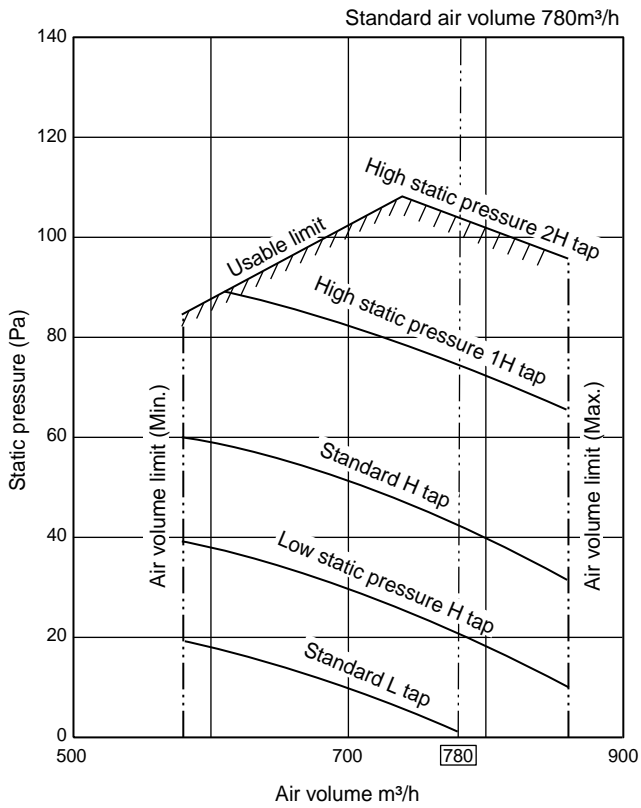

Fig. 3 RAV-SM801BT-E (Round duct)

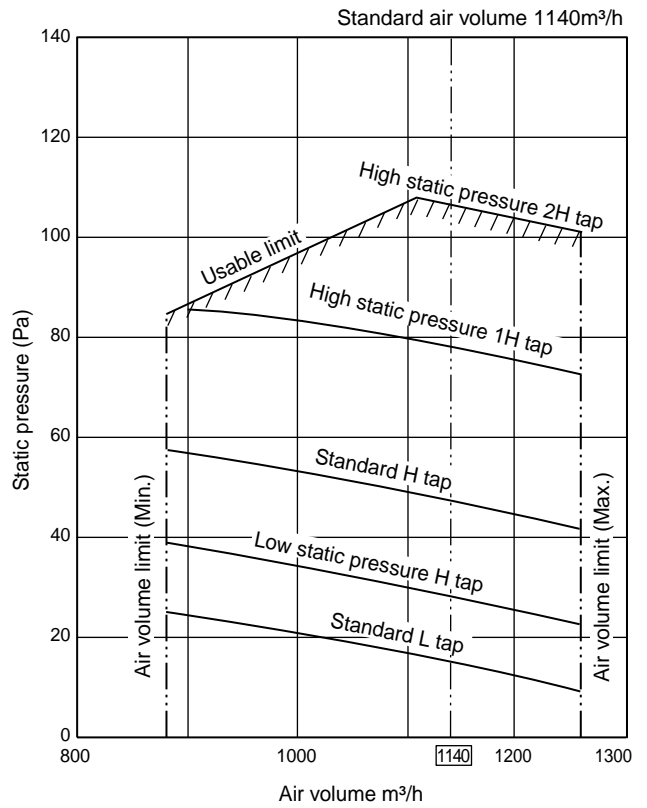

Fig. 2 RAV-SM561BT-E (Square duct)

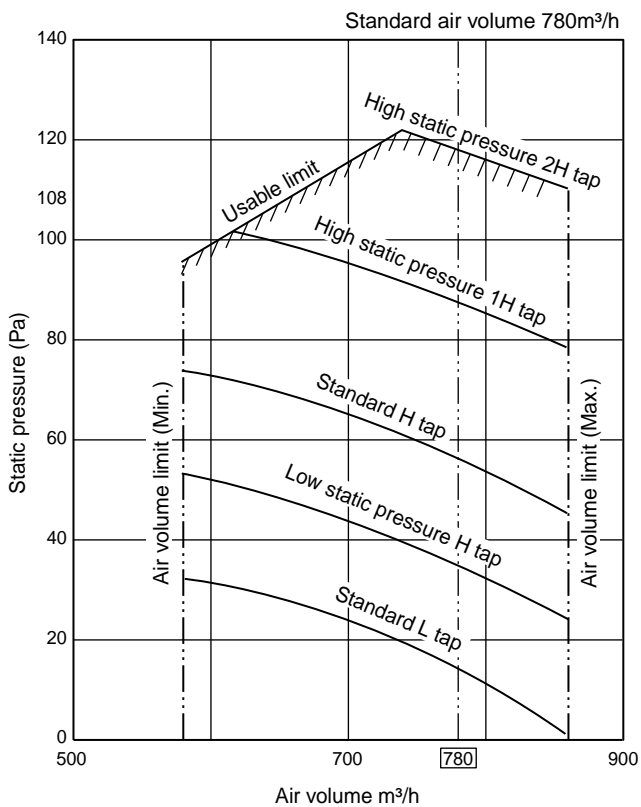
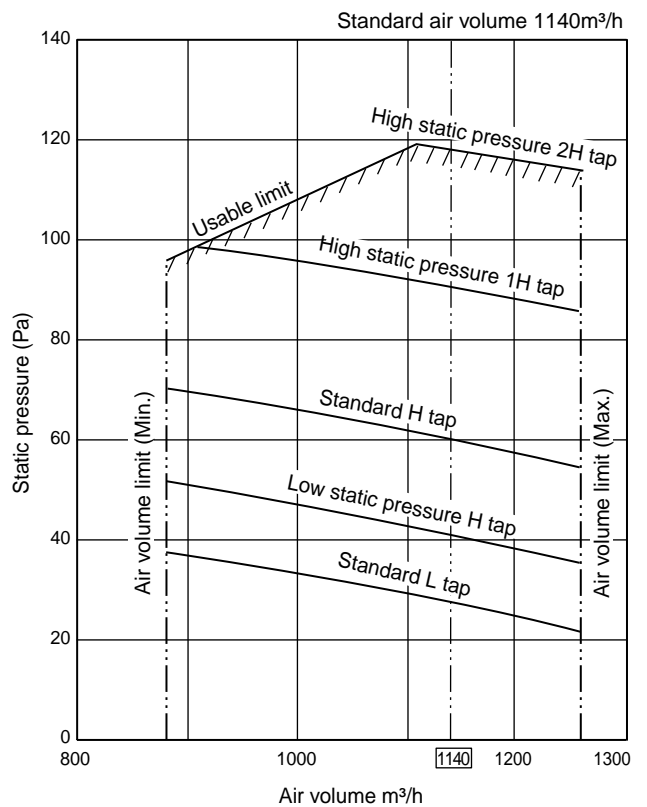
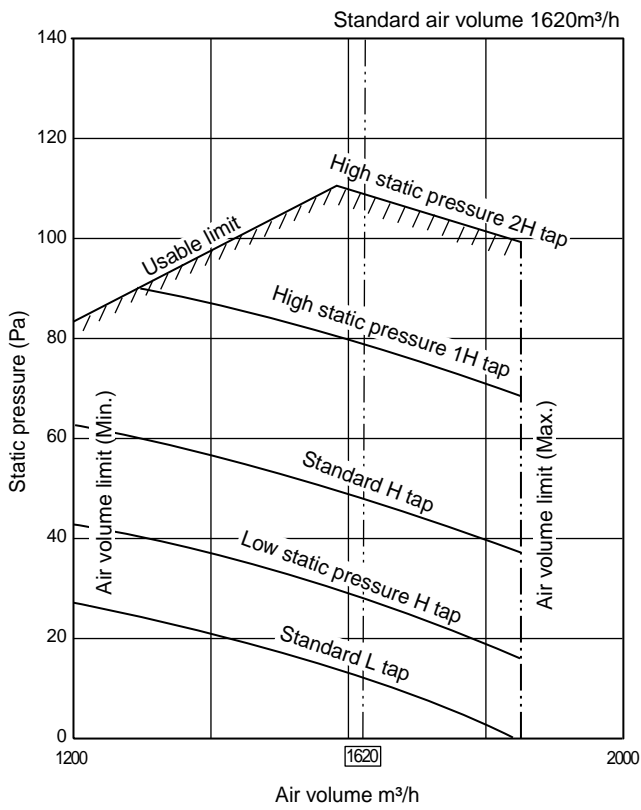

Fig. 4 RAV-SM801BT-E (Square duct)



**Fig. 5 RAV-SM1101BT-E (Round duct)**



**Fig. 7 RAV-SM1401BT-E (Round duct)**

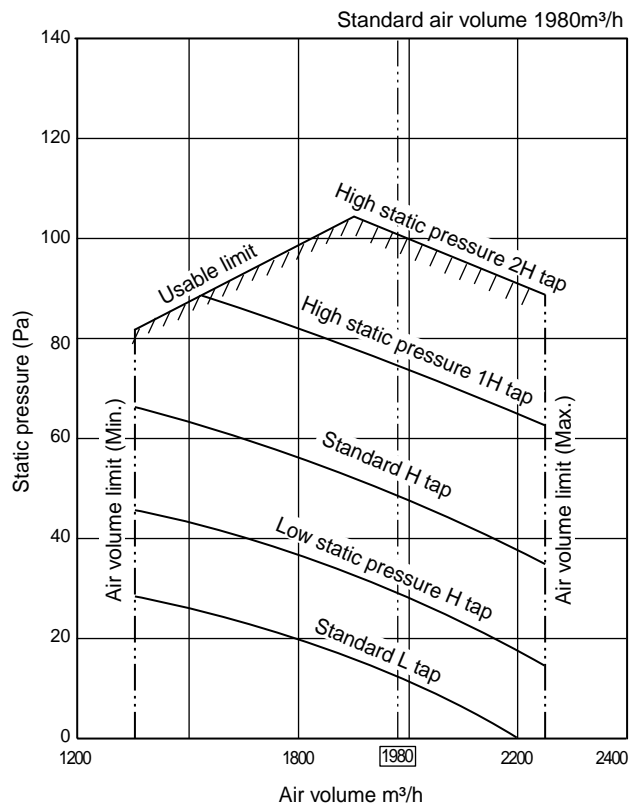

**Fig. 6 RAV-SM1101BT-E (Square duct)**

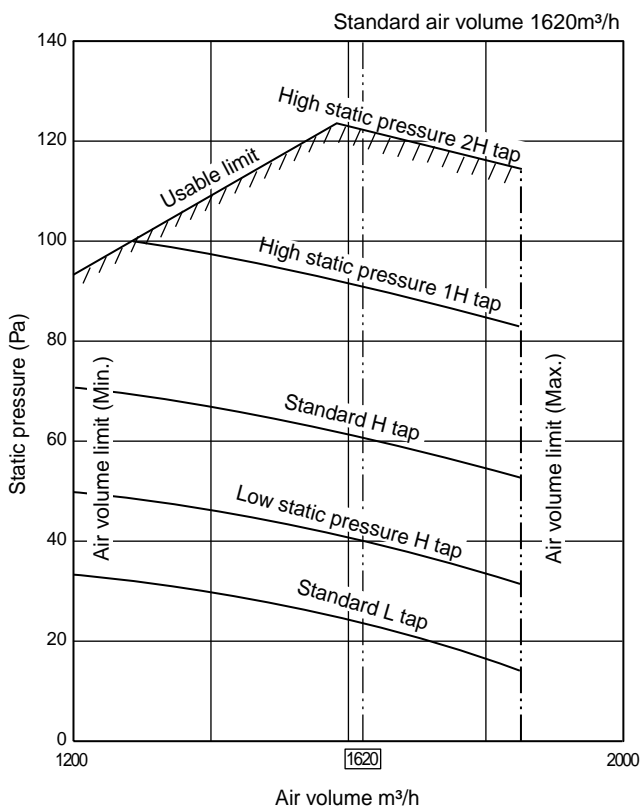

**Fig. 8 RAV-SM1401BT-E (Square duct)**

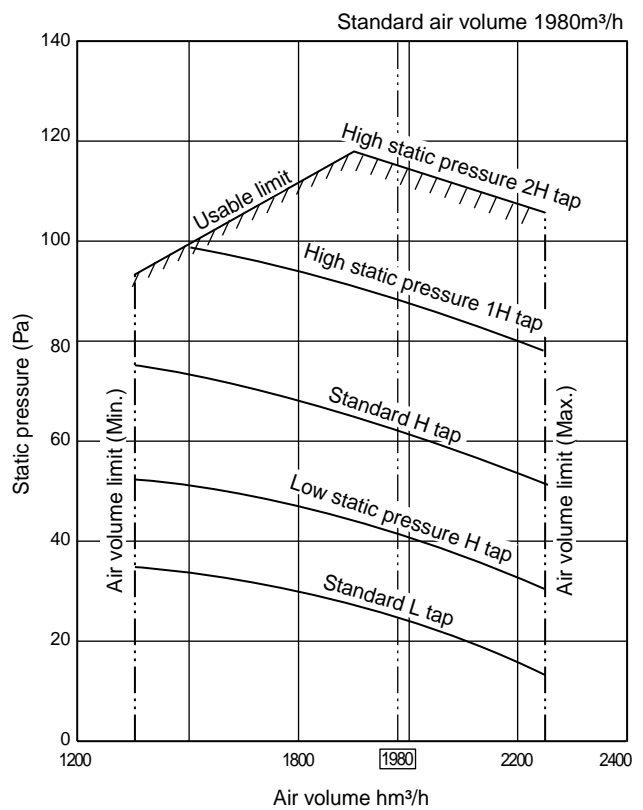

### 3. CONSTRUCTION VIEWS (EXTERNAL VIEWS)

#### 3-1. Indoor Unit

#### 3-1-1. Concealed Duct Type

RAV-SM561BT-E / SM801BT-E / SM1101BT-E / SM1401BT-E

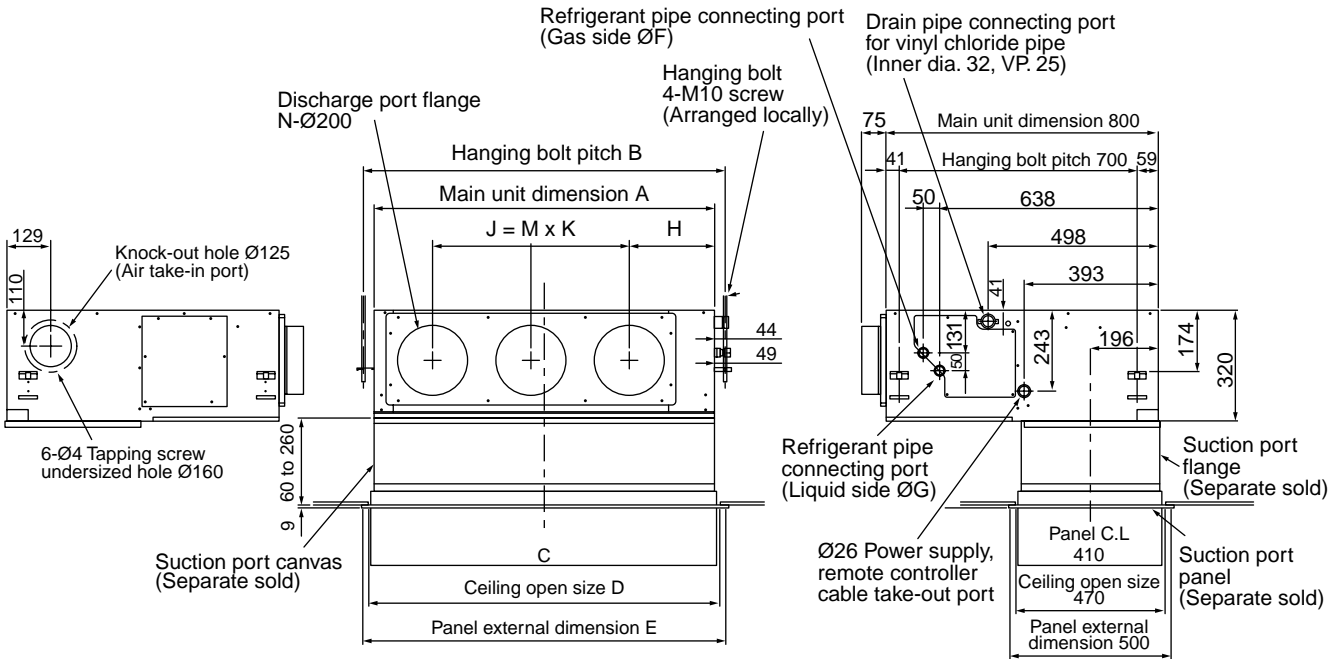

#### • Dimension

	A	B	C	D	E	F	G	H	J	K	M	N
RAV-SM561BT	700	766	690	750	780	12.7	6.4	252	280	280	1	2
RAV-SM801BT	1000	1066	990	1050	1080	15.9	9.5	252	580	290	2	3
RAV-SM1101, 1401BT	1350	1416	1340	1400	1430	15.9	9.5	252	930	310	2	4

#### NOTE :

For maintenance of the equipment, be sure to install a check port A at the position as shown below.

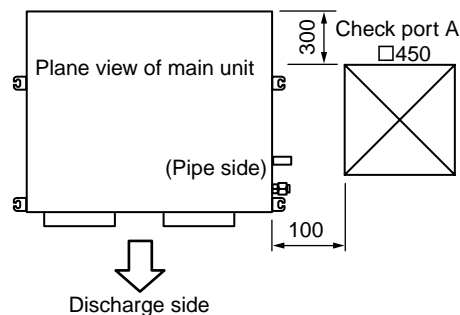

### 3-2. Outdoor Unit

#### RAV-SM560AT-E

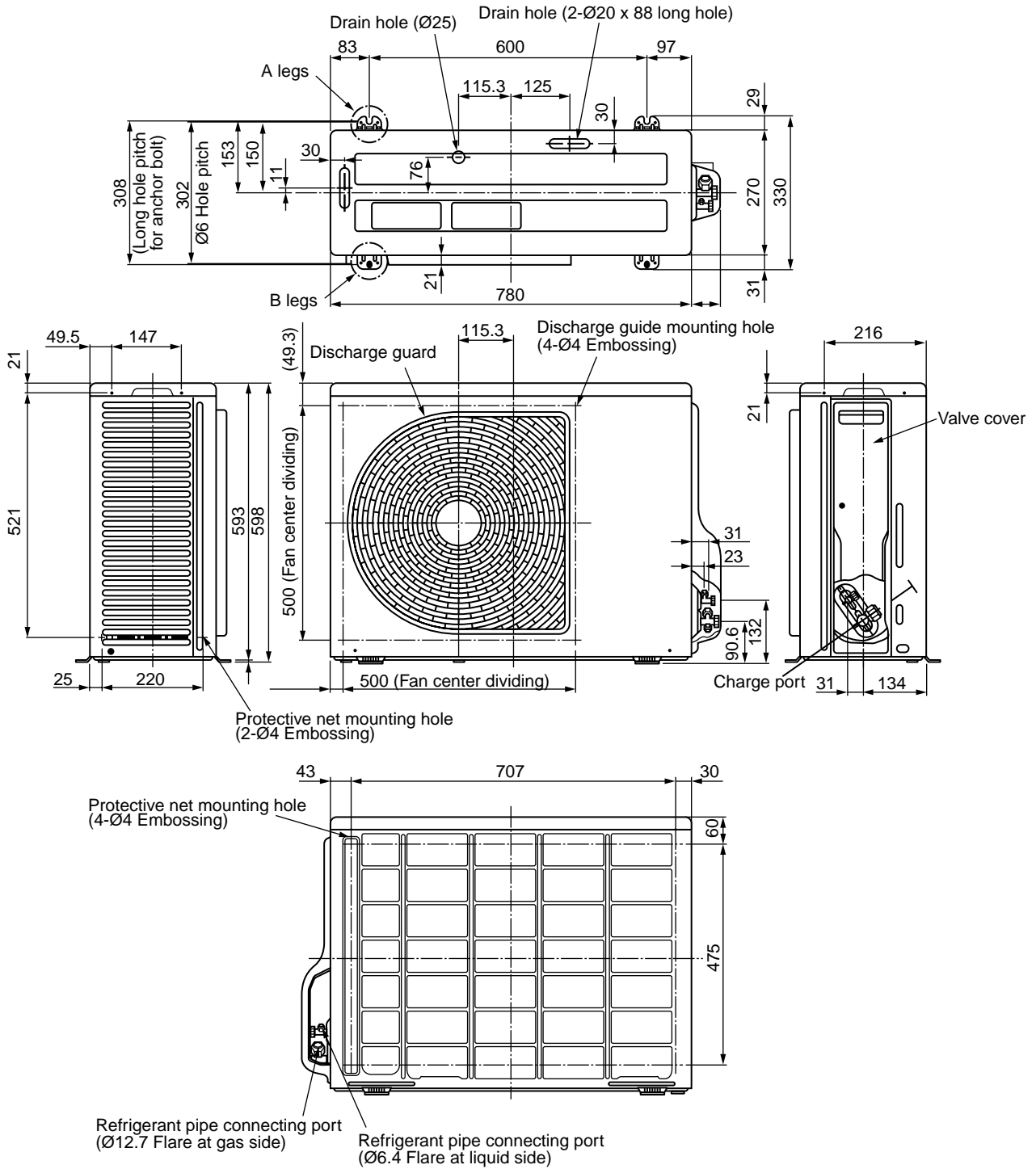

#### Space required for service

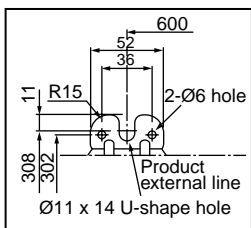

Details of A legs

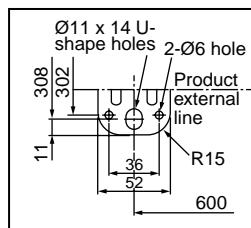

Details of B legs

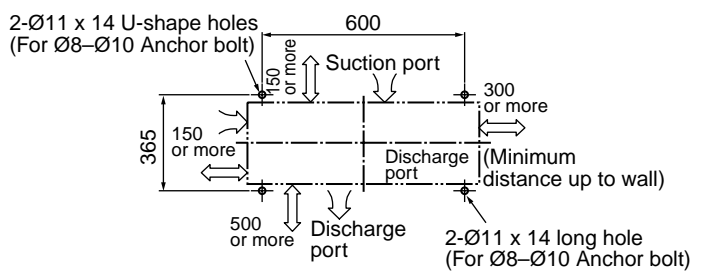

**RAV-SM800AT-E**

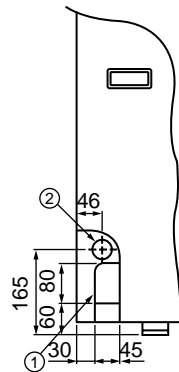
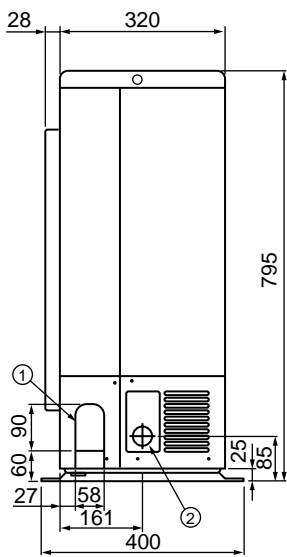
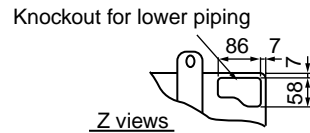
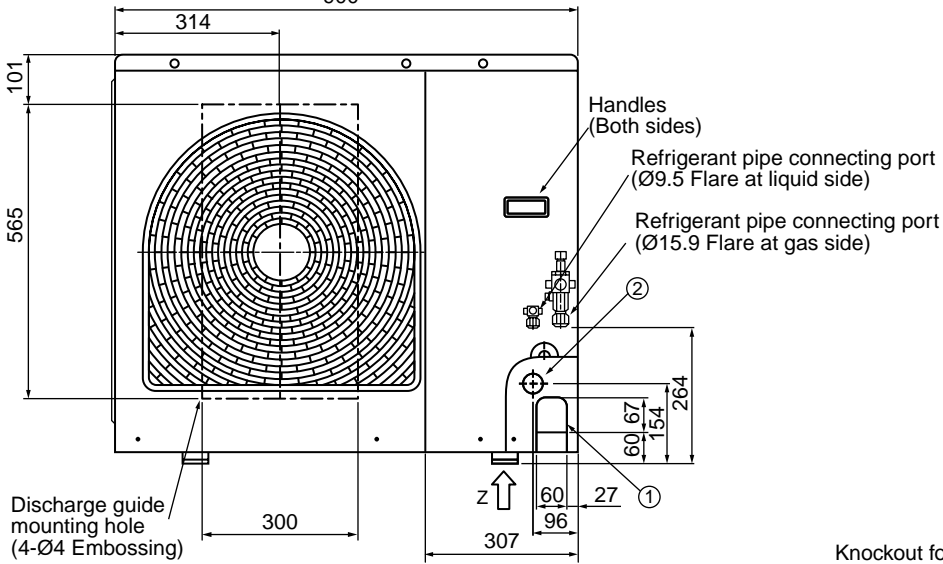
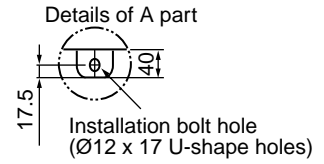
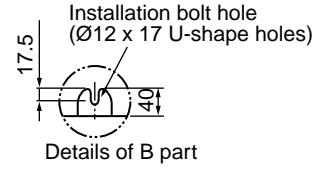
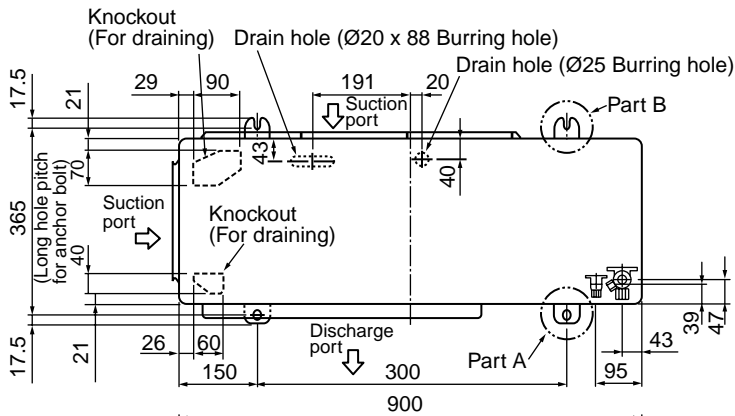

Space required for service

2-Ø12 x 17 U-shape holes (For Ø8-Ø10 Anchor bolt)

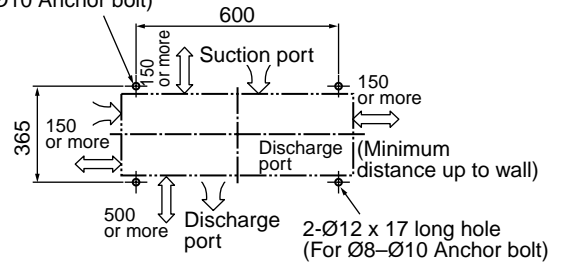

RAV-SM1100AT-E / SM1400AT-E

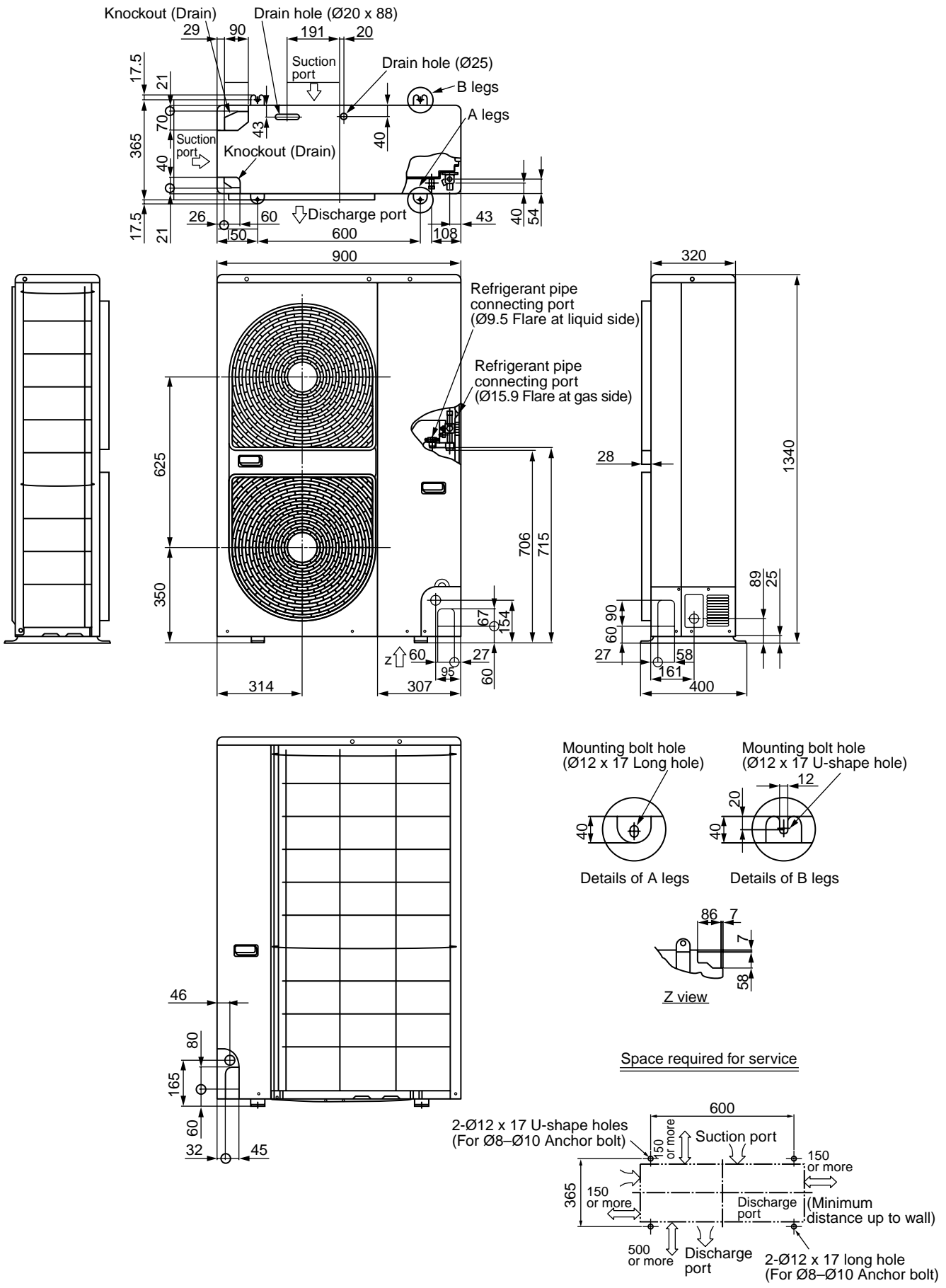

## 4. SYSTEMATIC REFRIGERATING CYCLE DIAGRAM

### 4-1. Indoor Unit/Outdoor Unit

RAV-SM561BT-E

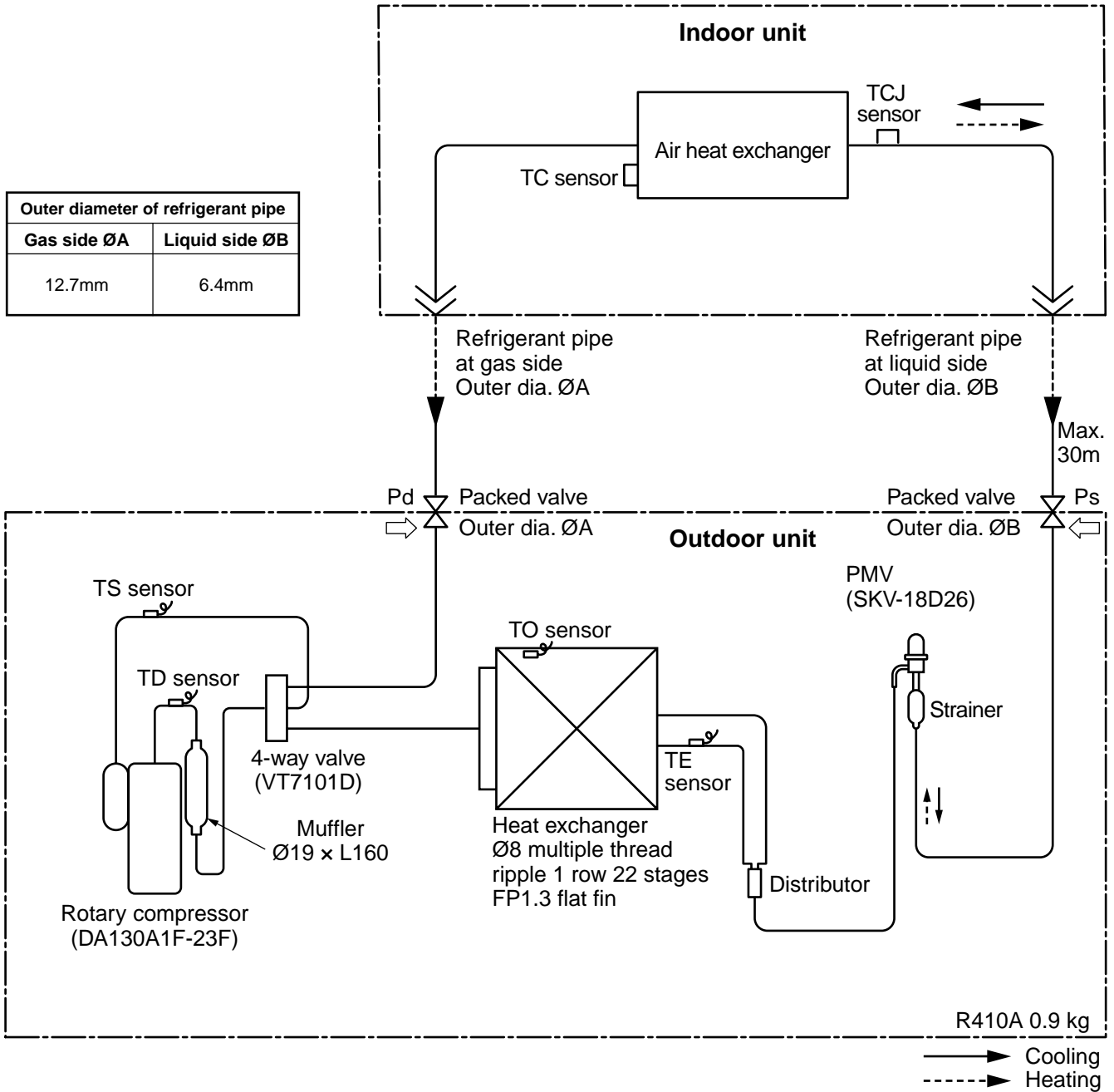

		Pressure				Pipe surface temperature (°C)				Compressor revolutions per second (rps) *	Indoor fan	Indoor/Outdoor temp. conditions (DB/WB) (°C)	
		(MPa)		(kg/cm <sup>2</sup> G)		Discharge (TD)	Suction (TS)	Indoor heat exchanger (TC)	Outdoor heat exchanger (TE)			Indoor	Outdoor
		Pd	Ps	Pd	Ps								
Cooling	Standard	3.1	0.9	31.9	8.9	85	15	10	50	74	HIGH	27/19	35/-
	Overload	3.6	1.0	37.1	10.4	93	20	15	57	72	HIGH	32/24	43/-
	Low load	0.9	0.7	9.1	7.1	20	7	3	5	28	LOW	18/15.5	-5/-
Heating	Standard	2.3	0.6	23.6	6.2	71	1	39	3	84	HIGH	20/-	7/6
	Overload	3.3	1.2	33.2	11.8	78	20	54	19	47	LOW	30.-	24/18
	Low load	1.7	0.2	16.4	1.8	110	-20	26	-22	110	HIGH	15/-	-20/(70%)

\* 4 poles are provided to this compressor.

The compressor frequency (Hz) measured with a clamp meter is 2 times of revolutions (rps) of the compressor.

RAV-SM801BT-E

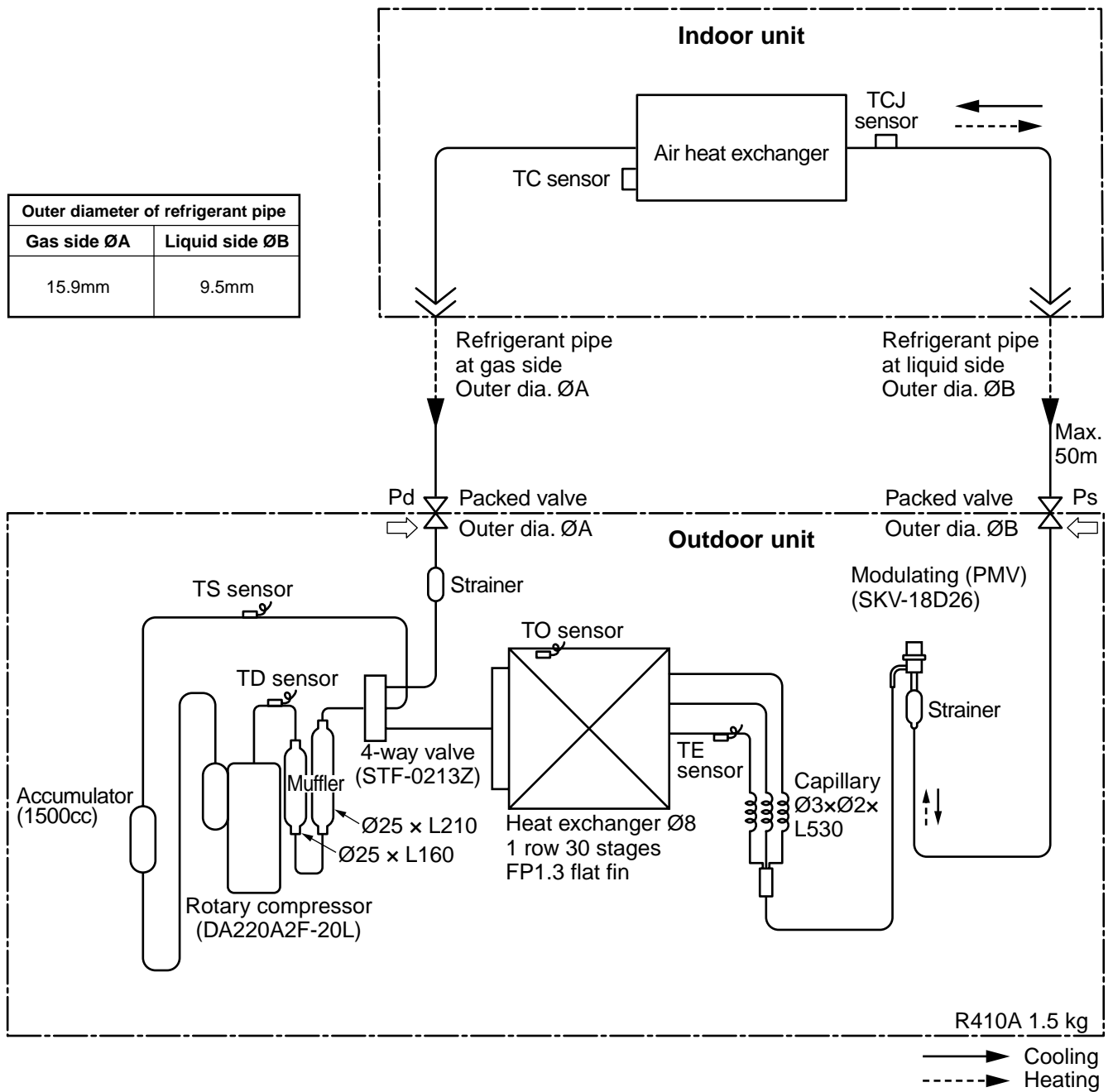

		Pressure				Pipe surface temperature (°C)				Compressor revolutions per second (rps) *	Indoor fan	Indoor/Outdoor temp. conditions (DB/WB) (°C)	
		(MPa)		(kg/cm <sup>2</sup> G)		Discharge (TD)	Suction (TS)	Indoor heat exchanger (TC)	Outdoor heat exchanger (TE)			Indoor	Outdoor
		Pd	Ps	Pd	Ps								
Cooling	Standard	3.3	0.9	33.4	8.8	86	11	9	44	64	HIGH	27/19	35/-
	Overload	3.7	1.1	37.8	11.4	90	21	18	54	52	HIGH	32/24	43/-
	Low load	1.0	0.8	10.0	7.9	19	4	4	8	27	LOW	18/15.5	-5/-
Heating	Standard	2.5	0.6	25.8	6.3	67	6	42	2	65	HIGH	20/-	7/6
	Overload	3.4	1.1	34.7	11.5	85	23	55	16	31	LOW	30.-	24/18
	Low load	2.0	0.2	20.3	2.3	89	-16	34	-18	90	HIGH	15/-	-20/(70%)

\* 4 poles are provided to this compressor.

The compressor frequency (Hz) measured with a clamp meter is 2 times of revolutions (rps) of the compressor.



RAV-SM1001BT-E

Outer diameter of refrigerant pipe	
Gas side ØA	Liquid side ØB
15.9mm	9.5mm

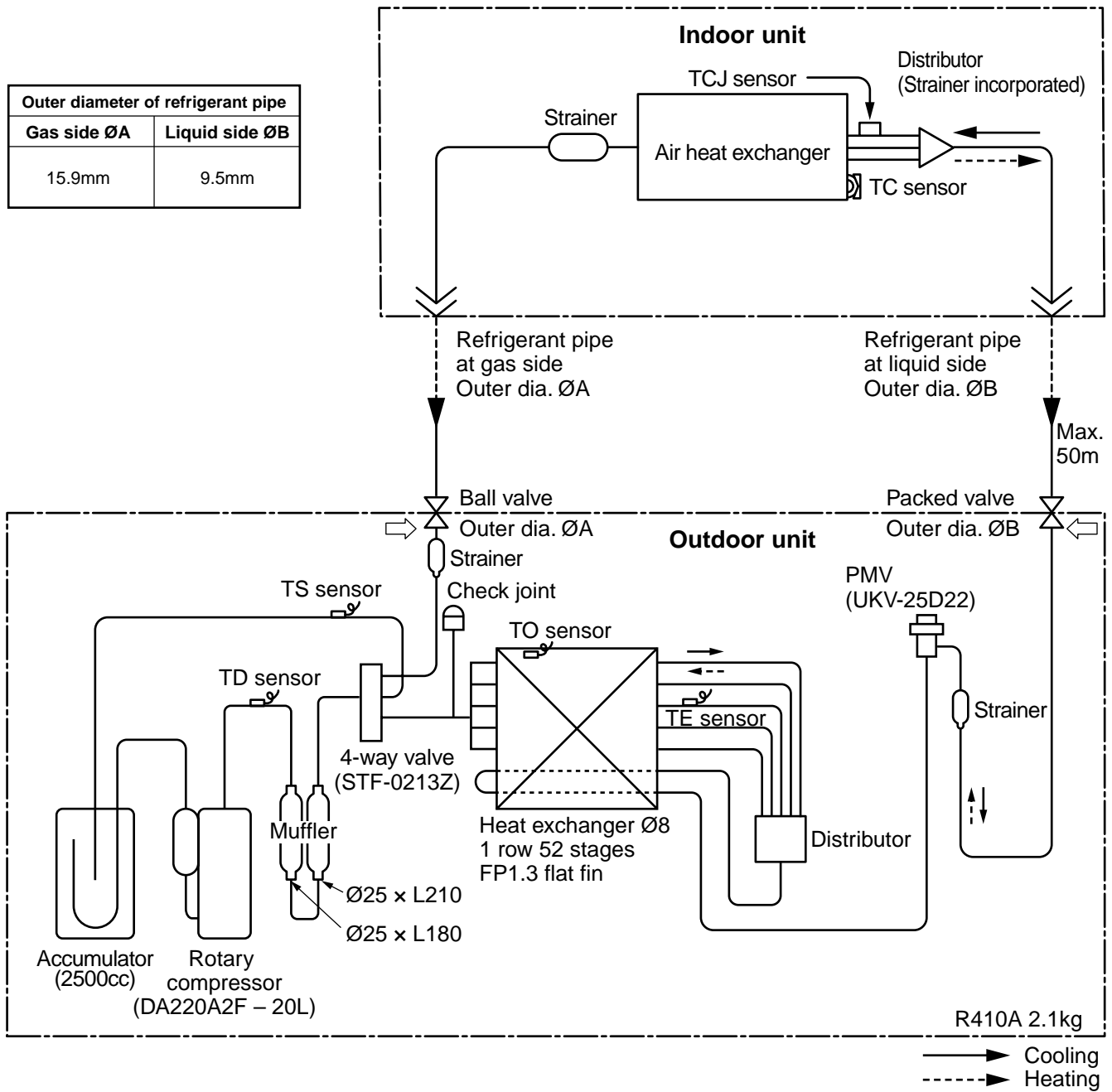

		Pressure (MPa)		Pipe surface temperature (°C)				Compressor revolutions per second (rps) *	Indoor fan	Indoor/Outdoor temp. conditions (DB/WB) (°C)	
				Discharge	Suction	Indoor heat exchanger	Outdoor heat exchanger			Indoor	Outdoor
		Pd	Ps	(TD)	(TS)	(TC)	(TE)				
Cooling	Standard	3.3	0.9	88	10	8	38	92	HIGH	27/19	35/-
	Overload	3.0	1.0	88	14	14	46	74	HIGH	32/24	43/-
	Low load	1.0	0.8	30	8	8	3	27	LOW	18/15.5	-5/-
Heating	Standard	2.5	0.6	90	4	50	2	86	HIGH	20/-	7/6
	Overload	3.3	1.1	83	17	54	13	52	LOW	30.-	24/18
	Low load	1.8	0.2	80	-23	29	-20	100	HIGH	15/-	-20/(70%)

\* 4 poles are provided to this compressor.

The compressor frequency (Hz) measured with a clamp meter is 2 times of revolutions (rps) of the compressor.

RAV-SM1401BT-E

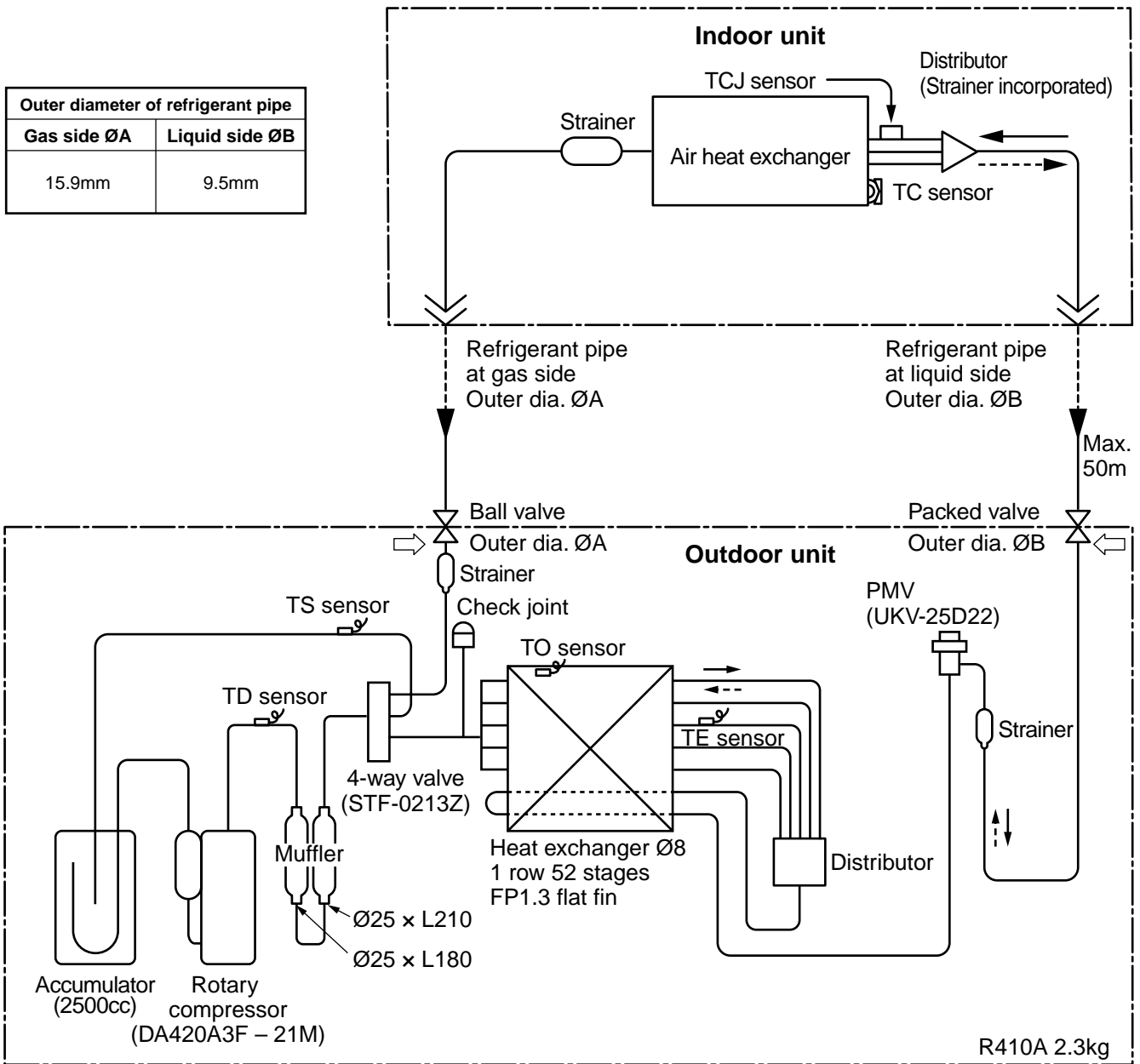

Cooling  
 Heating

		Pressure (MPa)		Pipe surface temperature (°C)				Compressor revolutions per second (rps) *	Indoor fan	Indoor/Outdoor temp. conditions (DB/WB) (°C)	
		Pd	Ps	Discharge	Suction	Indoor heat exchanger	Outdoor heat exchanger			Indoor	Outdoor
				(TD)	(TS)	(TC)	(TE)				
Cooling	Standard	3.3	0.9	84	11	10	40	56	HIGH	27/19	35/-
	Overload	3.5	1.0	87	7	15	54	54	HIGH	32/24	43/-
	Low load	1.7	0.8	44	8	4	8	27	LOW	18/15.5	-5/-
Heating	Standard	3.0	0.6	79	2	44	2	60	HIGH	20/-	7/6
	Overload	3.4	1.1	78	21	54	17	24	LOW	30.-	24/18
	Low load	2.0	0.2	82	-21	36	-18	73	HIGH	15/-	-20/(70%)

\* 4 poles are provided to this compressor.

The compressor frequency (Hz) measured with a clamp meter is 2 times of revolutions (rps) of the compressor.

## 5. WIRING DIAGRAM

### 5-1. Indoor Unit

RAV-SM561BT-E / SM801BT-E / SM1101BT-E / SM1401BT-E

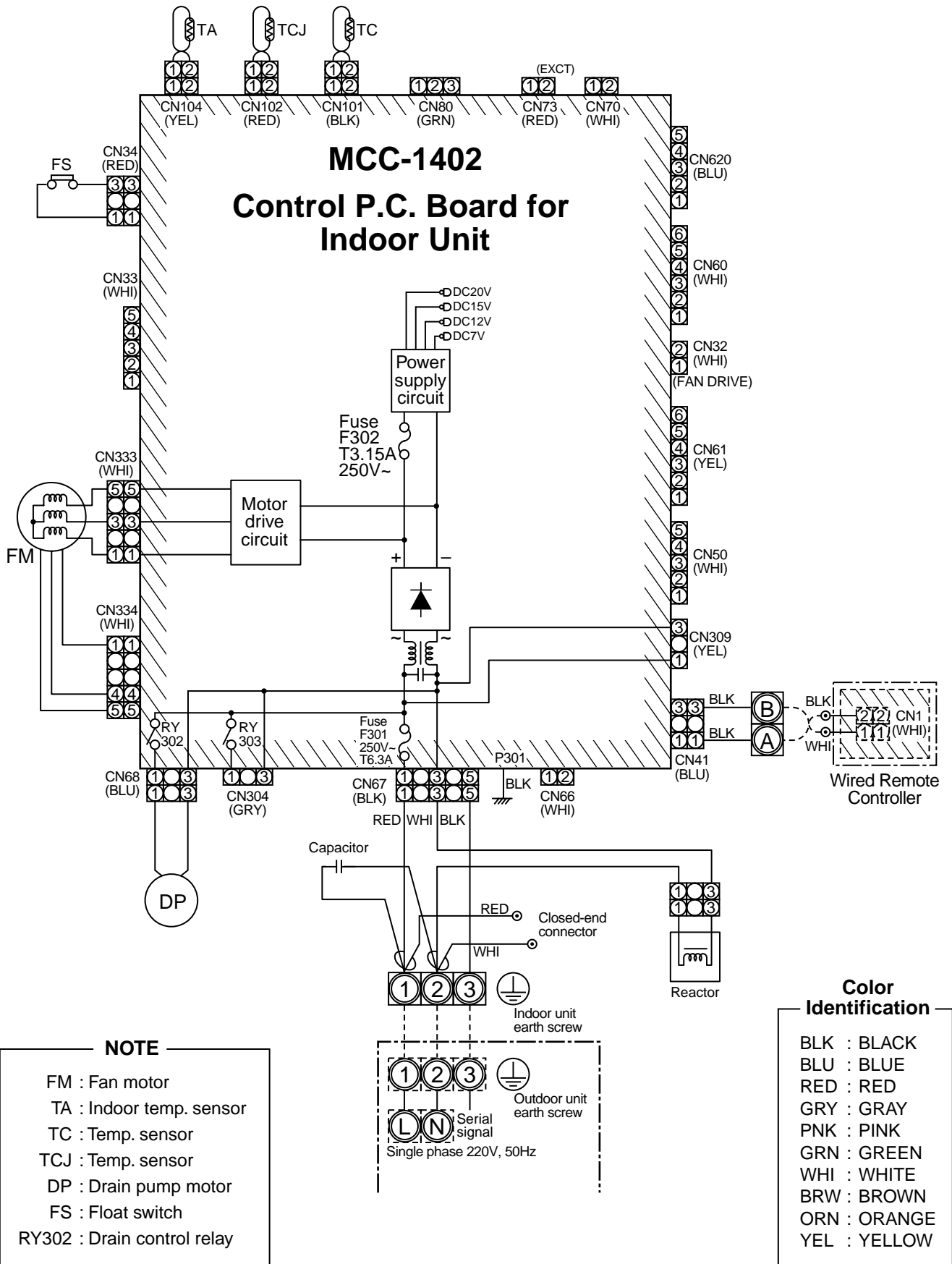

## 5-2. Outdoor Unit

### RAV-SM560AT-E

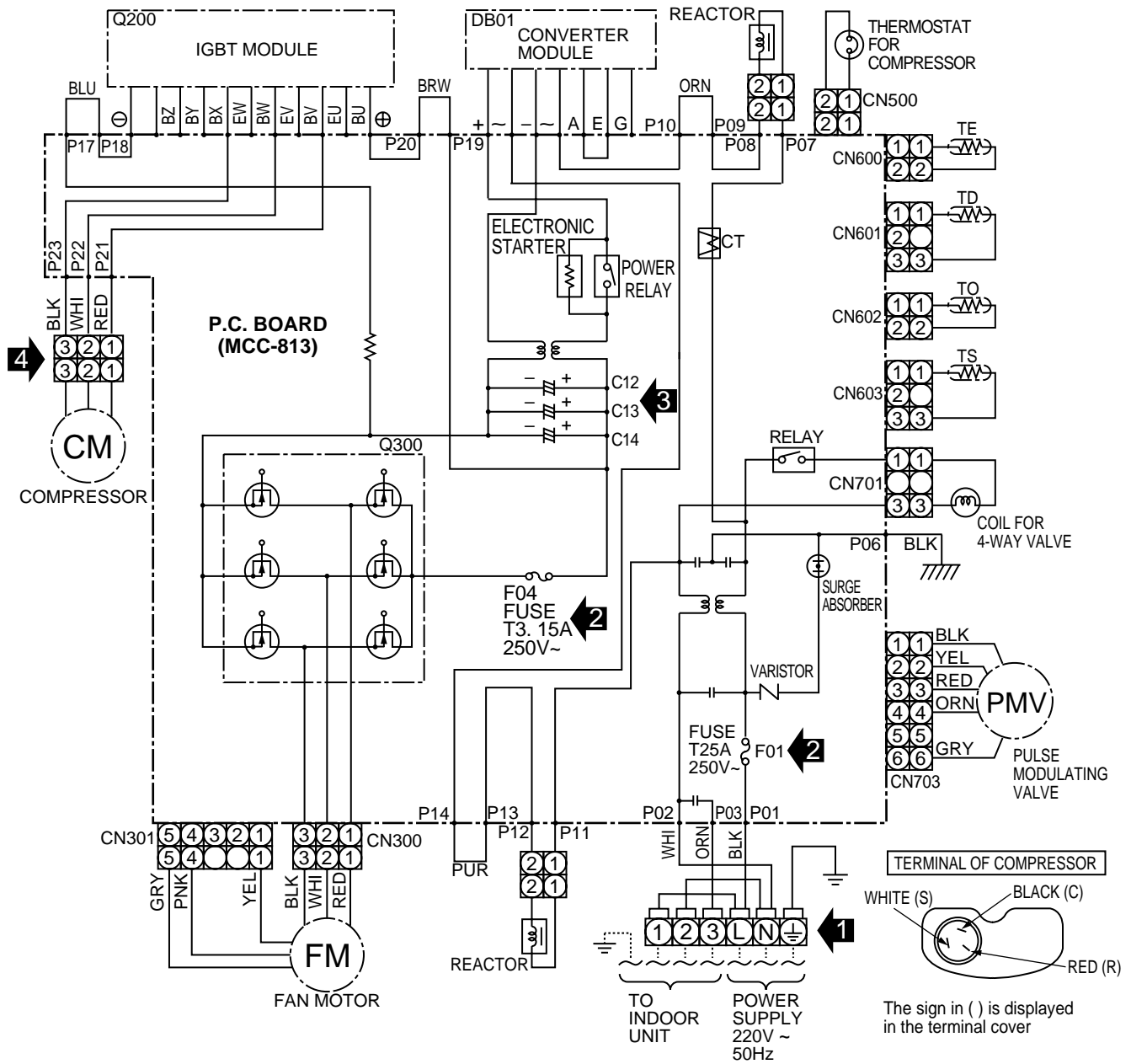

#### SIMPLE CHECK POINTS FOR DIAGNOSING FAULTS

Check items	Diagnosis result
<b>1</b>	<b>TERMINAL BLOCK</b> There is no supply voltage (AC220V) between (L - N), (1) - (2). There is no voltage (DC15 to 25V) (2) - (3). → Power supply and connecting cable check
<b>2</b>	<b>FUSE</b> T25A 250V to fuse (F01) blown → Converter module (DB01) and electrolytic capacitor (C12 to C14) check T3.15A 250V to fuse (F04) blown → IGBT module (Q200) check Fan motor check
<b>3</b>	<b>ELECTROLYTIC CAPACITOR VOLTAGE (C12, C13, C14)</b> DC320V not available between ⊕ ⊖ terminal of electrolytic capacitor → T25A fuse (F01) check P.C. board and converter module (DB01) check
<b>4</b>	<b>INVERTER OUTPUT (Inverter and compressor connector out of position)</b> (Please confirm within six minutes after instructing in the drive.) Voltage between each line of inverter side connector pins are not equal. → IGBT module and P.C. board check

#### Color Identification

BLK : BLACK	WHI : WHITE
BLU : BLUE	BRW : BROWN
RED : RED	ORN : ORANGE
GRY : GRAY	YEL : YELLOW
PNK : PINK	PUR : PURPLE
GRN : GREEN	

#### NOTE

CM	: Compressor
PMV	: Pulse modulating valve
FM	: Fan motor
TE	: Heat exchanger Temp. Sensor
TD	: Discharge Temp. Sensor
TO	: Outdoor Temp. Sensor
TS	: Suction Temp. Sensor
IGBT	: Insulated Gate Bipolar Transistor
DB01	: Converter module
CT	: Current Transformer
Q300	: Fan motor driver module

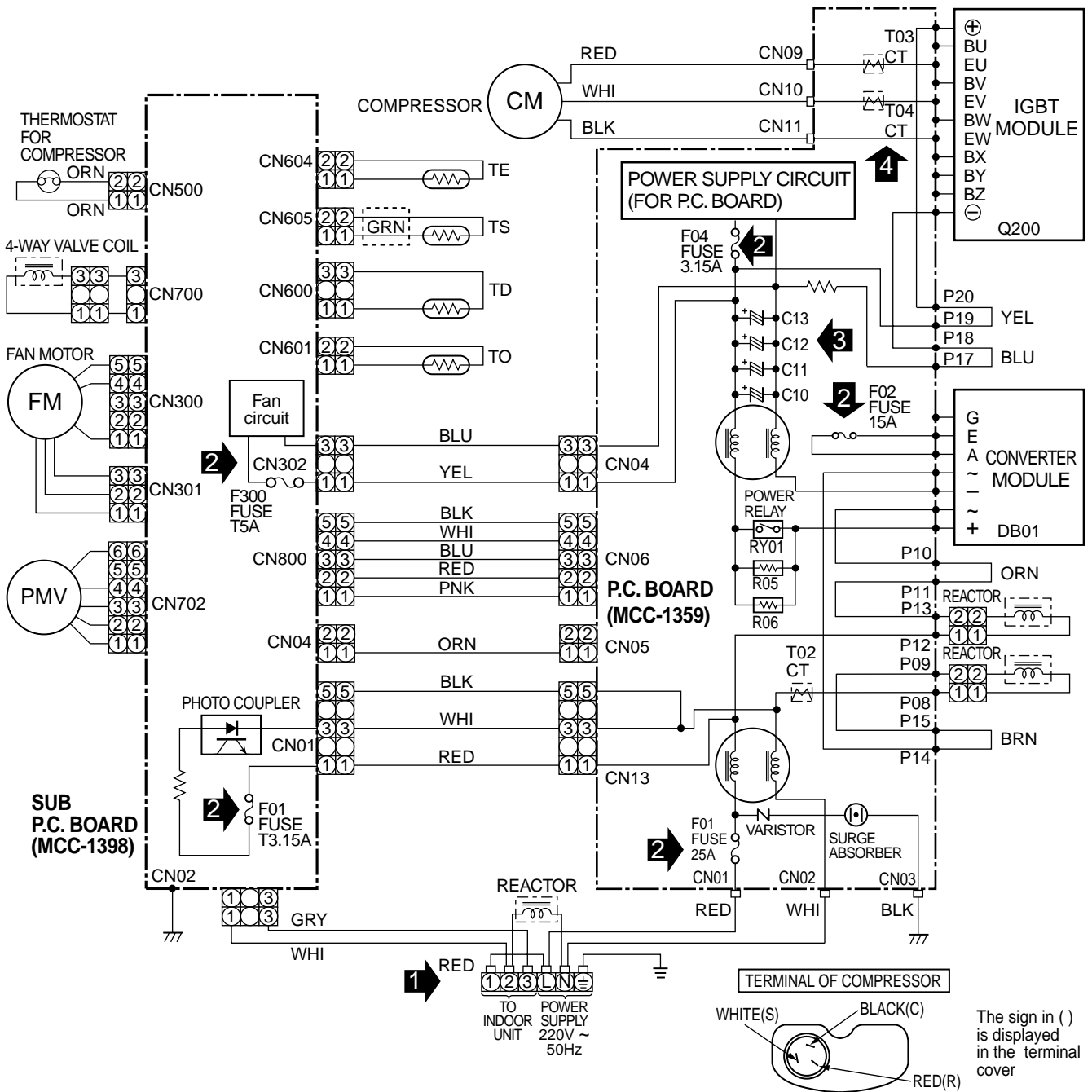

**SIMPLE CHECK POINTS FOR DIAGNOSING FAULTS**

Check items	Diagnosis result
<b>1</b>	<b>TERMINAL BLOCK</b> There is no supply voltage (AC220V) between (L - N), (1 - 2) → Connecting cable check There is no voltage (DC15 to 25V) (2) - (3)
<b>2</b>	<b>FUSE</b> 25A fuse (F01) blown, 15A fuse (F02) blown → Converter module (DB01) and electrolytic capacitor (C10 to C13) check 3.15A fuse (F04) blown, → IGBT module (Q200) check, Fan motor check T5A fuse (F300) blown (SUB P.C. board) T3.15A fuse (F01) blown (SUB P.C. board)
<b>3</b>	<b>ELECTROLYTIC CAPACITOR VOLTAGE (C10, C11, C12, C13)</b> DC320V not available between → 25A fuse (F01) check ⊕ ⊖ terminal of electrolytic capacitor → P.C. board and coverter module (DB01) check
<b>4</b>	<b>INVERTER OUTPUT (CN09, CN10, CN11)</b> (Please confirm within six minutes after instructing in the drive.) Voltage between each line of inverter side and connector pins are not equal. → IGBT module and P.C. board check

**Color Identification**

BLK : BLACK	WHI : WHITE
BLU : BLUE	BRN : BROWN
RED : RED	ORN : ORANGE
GRY : GRAY	YEL : YELLOW
PNK : PINK	PUR : PURPLE
GRN : GREEN	



## 6. SPECIFICATIONS OF ELECTRICAL PARTS

### 6-1. Indoor Unit

#### RAV-SM561BT-E / SM801BT-E / SM1101BT-E / SM1401BT-E

No.	Parts name	Type	Specifications
1	Fan motor (SM801BT-E)	ICF-280-120-1	Output (Rated) 120 W, 220–240 V
2	Fan motor (SM561BT-E/SM1101BT-E/SM1401BT-E)	ICF-280-120-2	Output (Rated) 120 W, 220–240 V
3	Thermo. sensor (TA-sensor)	258 mm	10 kΩ at 25°C
4	Heat exchanger sensor (TCJ-sensor)	Ø6 mm, 1200 mm	10 kΩ at 25°C
5	Heat exchanger sensor (TC-sensor)	Ø6 mm, 1200 mm	10 kΩ at 25°C
6	Float switch	FS-0218-106	
7	Drain pump motor	ADP-1406	
8	Reactor	CH-43-2Z-K	10 mH, 1 A

### 6-2. Outdoor Unit

#### RAV-SM560AT-E

No.	Parts name	Type	Specifications
1	Fan motor	ICF-140-43-1	Output (Rated) 40 W
2	Compressor	DA130A1F-23F	3 phase, 4P, 1100 W
3	Reactor	CH-57	10 mH, 16A
4	Outdoor temp. sensor (To-sensor)	—	10 kΩ at 25°C
5	Heat exchanger sensor (Te-sensor)	—	10 kΩ at 25°C
6	Suction temp. sensor (Ts-sensor)	—	10 kΩ at 25°C
7	Discharge temp. sensor (Td-sensor)	—	50 kΩ at 25°C
8	Fuse (Switching power (Protect))		T3.15 A, AC 250 V
9	Fuse (Inverter, input (Current protect))		25 A, AC 250 V
10	4-way valve solenoid coil	STF-0108G	
11	Compressor thermo. (Protection)	US-622	ON : 90 ± 5°C, OFF : 125 ± 4°C

#### RAV-SM800AT-E

No.	Parts name	Type	Specifications
1	Fan motor	ICF-140-63-1 or ICF-140-63-2	Output (Rated) 63 W
2	Compressor	DA220A2F-20L	3 phase, 4P, 1600 W
3	Reactor	CH-47	8 mH, 16 A
4	Outdoor temp. sensor (To-sensor)	—	10 kΩ at 25°C
5	Heat exchanger sensor (Te-sensor)	—	10 kΩ at 25°C
6	Suction temp. sensor (Ts-sensor)	—	10 kΩ at 25°C
7	Discharge temp. sensor (Td-sensor)	—	50 kΩ at 25°C
8	Fuse (Switching power (Protect))		T3.15 A, AC 250 V
9	Fuse (Inverter, input (Current protect))		25 A, AC 250 V
10	4-way valve solenoid coil	DKV-M0ZS743B0	
11	Compressor thermo. (Protection)	US-622	ON : 90 ± 5°C, OFF : 125 ± 4°C

**RAV-SM1100AT-E**

No.	Parts name	Type	Specifications
1	Fan motor	ICF-140-63-2	Output (Rated) 63 W
		ICF-140-43-2	Output (Rated) 43 W
2	Compressor	DA220A2F-20L	3 phase, 4P, 2000 W
3	Reactor	CH-56	6 mH, 18.5 A
4	Outdoor temp. sensor (To-sensor)	—	10 kΩ at 25°C
5	Heat exchanger sensor (Te-sensor)	—	10 kΩ at 25°C
6	Suction temp. sensor (Ts-sensor)	—	10 kΩ at 25°C
7	Discharge temp. sensor (Td-sensor)	—	50 kΩ at 25°C
8	Fuse (Switching power (Protect))		T3.15 A, AC 250 V
9	Fuse (Inverter, input (Current protect))		25 A, AC 250 V
10	4-way valve solenoid coil	VHV-01AJ502E1	AC 220 – 240 V
11	Compressor thermo. (Protection)	US-622	ON : 90 ± 5°C, OFF : 125 ± 4°C

**RAV-SM1400AT-E**

No.	Parts name	Type	Specifications
1	Fan motor	ICF-140-63-2	Output (Rated) 63 W
2	Compressor	DA420A3F-21M	3 phase, 4P, 3500 W
3	Reactor	CH-56	6 mH, 18.5 A
4	Outdoor temp. sensor (To-sensor)	—	10 kΩ at 25°C
5	Heat exchanger sensor (Te-sensor)	—	10 kΩ at 25°C
6	Suction temp. sensor (Ts-sensor)	—	10 kΩ at 25°C
7	Discharge temp. sensor (Td-sensor)	—	50 kΩ at 25°C
8	Fuse (Switching power (Protect))		T3.15 A, AC 250 V
9	Fuse (Inverter, input (Current protect))		25 A, AC 250 V
10	4-way valve solenoid coil	VHV-01AJ502E1	AC 220 V
11	Compressor thermo. (Protection)	US-622	ON : 90 ± 5°C, OFF : 125 ± 4°C



## 7. REFRIGERANT R410A

This air conditioner adopts the new refrigerant HFC (R410A) which does not damage the ozone layer.

The working pressure of the new refrigerant R410A is 1.6 times higher than conventional refrigerant (R22). The refrigerating oil is also changed in accordance with change of refrigerant, so be careful that water, dust, and existing refrigerant or refrigerating oil are not entered in the refrigerant cycle of the air conditioner using the new refrigerant during installation work or servicing time.

The next section describes the precautions for air conditioner using the new refrigerant. Conforming to contents of the next section together with the general cautions included in this manual, perform the correct and safe work.

### 7-1. Safety During Installation/Serviceing

As R410A's pressure is about 1.6 times higher than that of R22, improper installation/servicing may cause a serious trouble. By using tools and materials exclusive for R410A, it is necessary to carry out installation/servicing safely while taking the following precautions into consideration.

- (1) Never use refrigerant other than R410A in an air conditioner which is designed to operate with R410A.

If other refrigerant than R410A is mixed, pressure in the refrigeration cycle becomes abnormally high, and it may cause personal injury, etc. by a rupture.

- (2) Confirm the used refrigerant name, and use tools and materials exclusive for the refrigerant R410A.

The refrigerant name R410A is indicated on the visible place of the outdoor unit of the air conditioner using R410A as refrigerant. To prevent mischarging, the diameter of the service port differs from that of R22.

- (3) If a refrigeration gas leakage occurs during installation/servicing, be sure to ventilate fully.  
If the refrigerant gas comes into contact with fire, a poisonous gas may occur.
- (4) When installing or removing an air conditioner, do not allow air or moisture to remain in the refrigeration cycle. Otherwise, pressure in the refrigeration cycle may become abnormally high so that a rupture or personal injury may be caused.
- (5) After completion of installation work, check to make sure that there is no refrigeration gas leakage.

If the refrigerant gas leaks into the room, coming into contact with fire in the fan-driven heater, space heater, etc., a poisonous gas may occur.

- (6) When an air conditioning system charged with a large volume of refrigerant is installed in a small room, it is necessary to exercise care so that, even when refrigerant leaks, its concentration does not exceed the marginal level.

If the refrigerant gas leakage occurs and its concentration exceeds the marginal level, an oxygen starvation accident may result.

- (7) Be sure to carry out installation or removal according to the installation manual.  
Improper installation may cause refrigeration trouble, water leakage, electric shock, fire, etc.
- (8) Unauthorized modifications to the air conditioner may be dangerous. If a breakdown occurs please call a qualified air conditioner technician or electrician.

Improper repair's may result in water leakage, electric shock and fire, etc.

### 7-2. Refrigerant Piping Installation

#### 7-2-1. Piping Materials and Joints Used

For the refrigerant piping installation, copper pipes and joints are mainly used. Copper pipes and joints suitable for the refrigerant must be chosen and installed. Furthermore, it is necessary to use clean copper pipes and joints whose interior surfaces are less affected by contaminants.

- (1) Copper Pipes

It is necessary to use seamless copper pipes which are made of either copper or copper alloy and it is desirable that the amount of residual oil is less than 40 mg/10 m. Do not use copper pipes having a collapsed, deformed or discolored portion (especially on the interior surface). Otherwise, the expansion valve or capillary tube may become blocked with contaminants.

As an air conditioner using R410A incurs pressure higher than when using R22, it is necessary to choose adequate materials.

Thicknesses of copper pipes used with R410A are as shown in Table 7-2-1. Never use copper pipes thinner than 0.8 mm even when it is available on the market.

**Table 7-2-1 Thicknesses of annealed copper pipes**

		Thickness (mm)	
Nominal diameter	Outer diameter (mm)	R410A	R22
1/4	6.35	0.80	0.80
3/8	9.52	0.80	0.80
1/2	12.70	0.80	0.80
5/8	15.88	1.00	1.00

(2) Joints

For copper pipes, flare joints or socket joints are used. Prior to use, be sure to remove all contaminants.

a) Flare Joints

Flare joints used to connect the copper pipes cannot be used for pipings whose outer diameter exceeds 20 mm. In such a case, socket joints can be used.

Sizes of flare pipe ends, flare joint ends and flare nuts are as shown in Tables 7-2-3 to 7-2-6 below.

b) Socket Joints

Socket joints are such that they are brazed for connections, and used mainly for thick pipings whose diameter is larger than 20 mm. Thicknesses of socket joints are as shown in Table 7-2-2.

**Table 7-2-2 Minimum thicknesses of socket joints**

Nominal diameter	Reference outer diameter of copper pipe jointed (mm)	Minimum joint thickness (mm)
1/4	6.35	0.50
3/8	9.52	0.60
1/2	12.70	0.70
5/8	15.88	0.80

**7-2-2. Processing of Piping Materials**

When performing the refrigerant piping installation, care should be taken to ensure that water or dust does not enter the pipe interior, that no other oil other than lubricating oils used in the installed air conditioner is used, and that refrigerant does not leak. When using lubricating oils in the piping processing, use such lubricating oils whose water content has been removed. When stored, be sure to seal the container with an airtight cap or any other cover.

(1) Flare Processing Procedures and Precautions

a) Cutting the Pipe

By means of a pipe cutter, slowly cut the pipe so that it is not deformed.

b) Removing Burrs and Chips

If the flared section has chips or burrs, refrigerant leakage may occur. Carefully remove all burrs and clean the cut surface before installation.

c) Insertion of Flare Nut

d) Flare Processing

Make certain that a clamp bar and copper pipe have been cleaned.

By means of the clamp bar, perform the flare processing correctly.

Use either a flare tool for R410A or conventional flare tool.

Flare processing dimensions differ according to the type of flare tool. When using a conventional flare tool, be sure to secure "dimension A" by using a gauge for size adjustment.

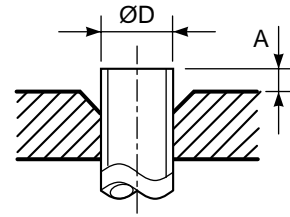

Fig. 7-2-1 Flare processing dimensions

Table 7-2-3 Dimensions related to flare processing for R410A

Nominal diameter	Outer diameter (mm)	Thickness (mm)	A (mm)		
			Flare tool for R410A clutch type	Conventional flare tool	
				Clutch type	Wing nut type
1/4	6.35	0.8	0 to 0.5	1.0 to 1.5	1.5 to 2.0
3/8	9.52	0.8	0 to 0.5	1.0 to 1.5	1.5 to 2.0
1/2	12.70	0.8	0 to 0.5	1.0 to 1.5	2.0 to 2.5
5/8	15.88	1.0	0 to 0.5	1.0 to 1.5	2.0 to 2.5

Table 7-2-4 Dimensions related to flare processing for R22

Nominal diameter	Outer diameter (mm)	Thickness (mm)	A (mm)		
			Flare tool for R22 clutch type	Conventional flare tool	
				Clutch type	Wing nut type
1/4	6.35	0.8	0 to 0.5	0.5 to 1.0	1.0 to 1.5
3/8	9.52	0.8	0 to 0.5	0.5 to 1.0	1.0 to 1.5
1/2	12.70	0.8	0 to 0.5	0.5 to 1.0	1.5 to 2.0
5/8	15.88	1.0	0 to 0.5	0.5 to 1.0	1.5 to 2.0

Table 7-2-5 Flare and flare nut dimensions for R410A

Nominal diameter	Outer diameter (mm)	Thickness (mm)	Dimension (mm)				Flare nut width (mm)
			A	B	C	D	
1/4	6.35	0.8	9.1	9.2	6.5	13	17
3/8	9.52	0.8	13.2	13.5	9.7	20	22
1/2	12.70	0.8	16.6	16.0	12.9	23	26
5/8	15.88	1.0	19.7	19.0	16.0	25	29

**Table 7-2-6 Flare and flare nut dimensions for R22**

Nominal diameter	Outer diameter (mm)	Thickness (mm)	Dimension (mm)				Flare nut width (mm)
			A	B	C	D	
1/4	6.35	0.8	9.0	9.2	6.5	13	17
3/8	9.52	0.8	13.0	13.5	9.7	20	22
1/2	12.70	0.8	16.2	16.0	12.9	20	24
5/8	15.88	1.0	19.4	19.0	16.0	23	27
3/4	19.05	1.0	23.3	24.0	19.2	34	36

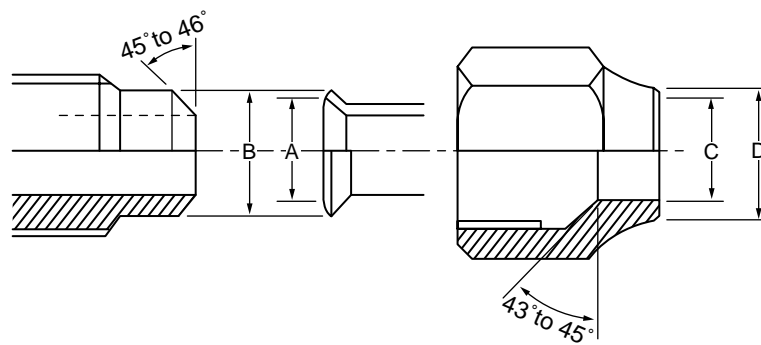

**Fig. 7-2-2 Relations between flare nut and flare seal surface**

(2) Flare Connecting Procedures and Precautions

- Make sure that the flare and union portions do not have any scar or dust, etc.
- Correctly align the processed flare surface with the union axis.
- Tighten the flare with designated torque by means of a torque wrench. The tightening torque for R410A is the same as that for conventional R22. Incidentally, when the torque is weak, the gas leakage may occur.

When it is strong, the flare nut may crack and may be made non-removable. When choosing the tightening torque, comply with values designated by manufacturers. Table 7-2-7 shows reference values.

**NOTE:**

When applying oil to the flare surface, be sure to use oil designated by the manufacturer. If any other oil is used, the lubricating oils may deteriorate and cause the compressor to burn out.

**Table 7-2-7 Tightening torque of flare for R410A [Reference values]**

Nominal diameter	Outer diameter (mm)	Tightening torque N•m (kgf•cm)	Tightening torque of torque wrenches available on the market N•m (kgf•cm)
1/4	6.35	14 to 18 (140 to 180)	16 (160), 18 (180)
3/8	9.52	33 to 42 (330 to 420)	42 (420)
1/2	12.70	50 to 62 (500 to 620)	55 (550)
5/8	15.88	63 to 77 (630 to 770)	65 (650)

## 7-3. Tools

### 7-3-1. Required Tools

The service port diameter of packed valve of the outdoor unit in the air conditioner using R410A is changed to prevent mixing of other refrigerant. To reinforce the pressure-resisting strength, flare processing dimensions and opposite side dimension of flare nut (For Ø12.7 copper pipe) of the refrigerant piping are lengthened.

The used refrigerating oil is changed, and mixing of oil may cause a trouble such as generation of sludge, clogging of capillary, etc. Accordingly, the tools to be used are classified into the following three types.

- (1) Tools exclusive for R410A (Those which cannot be used for conventional refrigerant (R22))
- (2) Tools exclusive for R410A, but can be also used for conventional refrigerant (R22)
- (3) Tools commonly used for R410A and for conventional refrigerant (R22)

The table below shows the tools exclusive for R410A and their interchangeability.

#### Tools exclusive for R410A (The following tools for R410A are required.)

Tools whose specifications are changed for R410A and their interchangeability

No.	Used tool	Usage	R410A air conditioner installation		Conventional air conditioner installation
			Existence of new equipment for R410A	Whether conventional equipment can be used	Whether new equipment can be used with conventional refrigerant
①	Flare tool	Pipe flaring	Yes	*(Note 1)	○
②	Copper pipe gauge for adjusting projection margin	Flaring by conventional flare tool	Yes	*(Note 1)	*(Note 1)
③	Torque wrench	Connection of flare nut	Yes	×	×
④	Gauge manifold	Evacuating, refrigerant charge, run check, etc.	Yes	×	×
⑤	Charge hose				
⑥	Vacuum pump adapter	Vacuum evacuating	Yes	×	○
⑦	Electronic balance for refrigerant charging	Refrigerant charge	Yes	×	○
⑧	Refrigerant cylinder	Refrigerant charge	Yes	×	×
⑨	Leakage detector	Gas leakage check	Yes	×	○
⑩	Charging cylinder	Refrigerant charge	(Note 2)	×	×

**(Note 1)** When flaring is carried out for R410A using the conventional flare tools, adjustment of projection margin is necessary. For this adjustment, a copper pipe gauge, etc. are necessary.

**(Note 2)** Charging cylinder for R410A is being currently developed.

#### General tools (Conventional tools can be used.)

In addition to the above exclusive tools, the following equipments which serve also for R22 are necessary as the general tools.

- |                                                                      |                              |                                            |
|----------------------------------------------------------------------|------------------------------|--------------------------------------------|
| (1) Vacuum pump<br>Use vacuum pump by attaching vacuum pump adapter. | (4) Reamer                   | (9) Hole core drill (Ø65)                  |
| (2) Torque wrench                                                    | (5) Pipe bender              | (10) Hexagon wrench<br>(Opposite side 4mm) |
| (3) Pipe cutter                                                      | (6) Level vial               | (11) Tape measure                          |
|                                                                      | (7) Screwdriver (+, -)       | (12) Metal saw                             |
|                                                                      | (8) Spanner or Monkey wrench |                                            |

Also prepare the following equipments for other installation method and run check.

- |                 |                                  |
|-----------------|----------------------------------|
| (1) Clamp meter | (3) Insulation resistance tester |
| (2) Thermometer | (4) Electro-scope                |

## 7-4. Recharging of Refrigerant

When it is necessary to recharge refrigerant, charge the specified amount of new refrigerant according to the following steps.

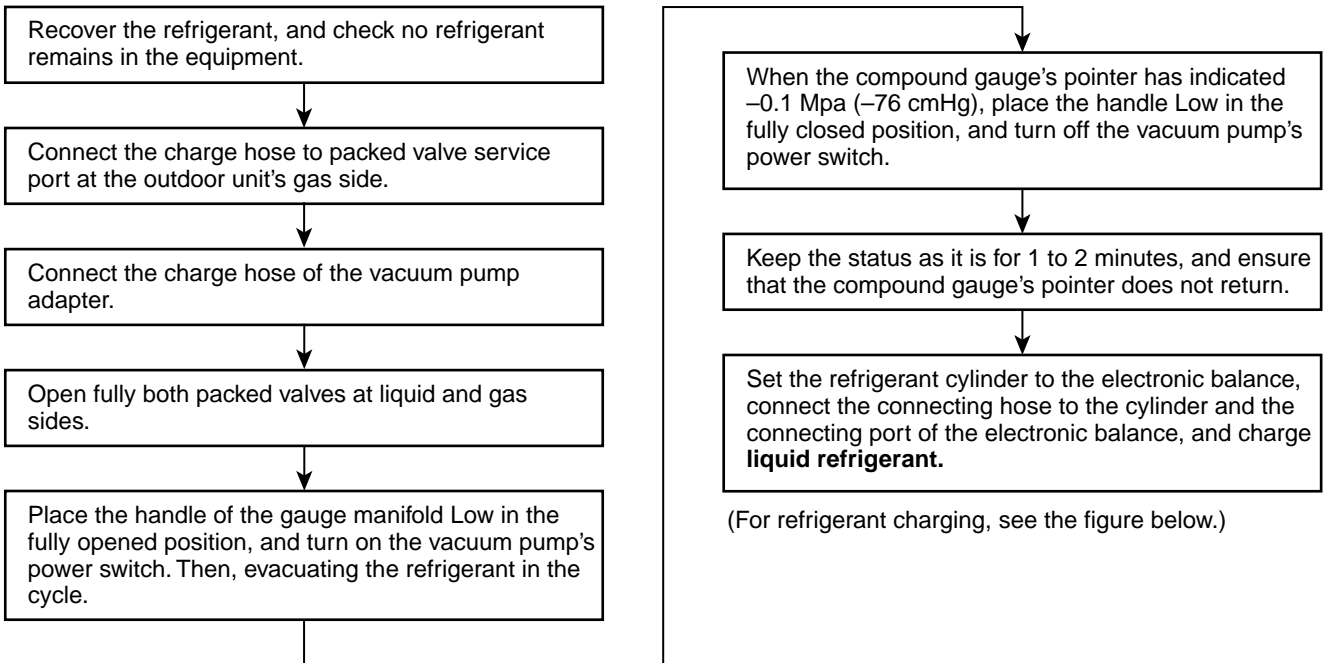

- ① Never charge refrigerant exceeding the specified amount.
- ② If the specified amount of refrigerant cannot be charged, charge refrigerant **bit by bit** in COOL mode.
- ③ Do not carry out additional charging.

When additional charging is carried out if refrigerant leaks, the refrigerant composition changes in the refrigeration cycle, that is characteristics of the air conditioner changes, refrigerant exceeding the specified amount is charged, and working pressure in the refrigeration cycle becomes abnormally high pressure, and may cause a rupture or personal injury.

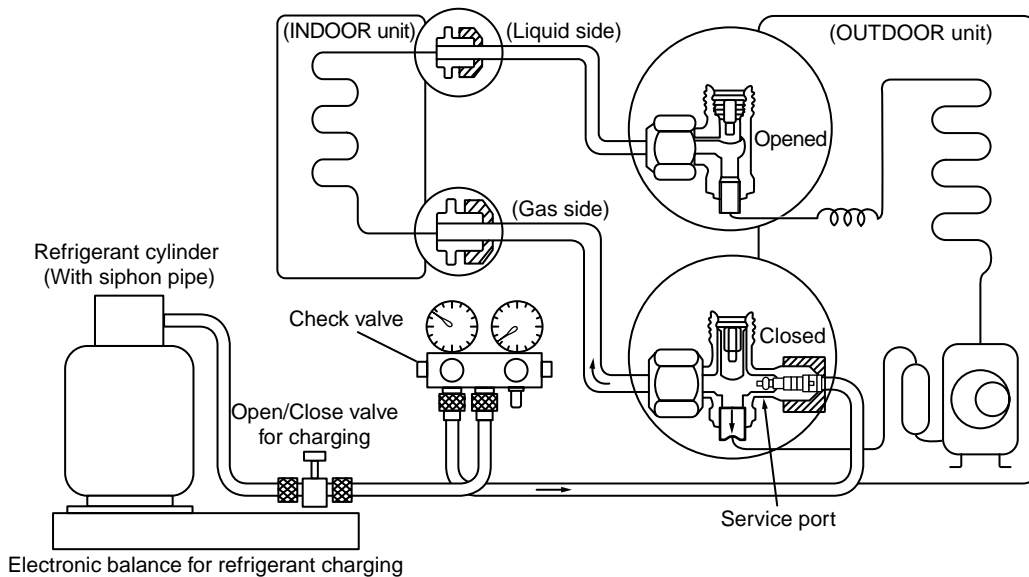
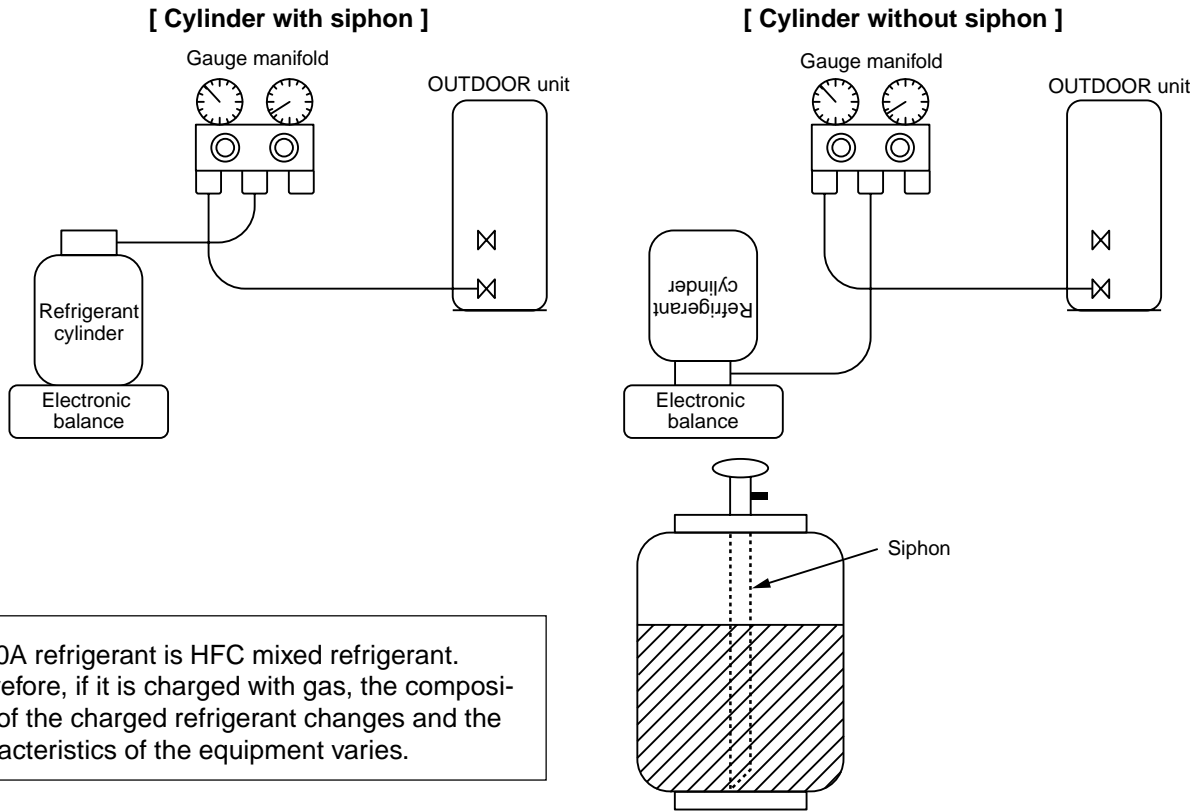

Fig. 7-4-1 Configuration of refrigerant charging

- ① Be sure to make setting so that **liquid** can be charged.
- ② When using a cylinder equipped with a siphon, liquid can be charged without turning it upside down.

It is necessary for charging refrigerant under condition of liquid because R410A is mixed type of refrigerant. Accordingly, when charging refrigerant from the refrigerant cylinder to the equipment, charge it turning the cylinder upside down if cylinder is not equipped with siphon.



R410A refrigerant is HFC mixed refrigerant. Therefore, if it is charged with gas, the composition of the charged refrigerant changes and the characteristics of the equipment varies.

Fig. 7-4-2

## 7-5. Brazing of Pipes

### 7-5-1. Materials for Brazing

#### (1) Silver brazing filler

Silver brazing filler is an alloy mainly composed of silver and copper. It is used to join iron, copper or copper alloy, and is relatively expensive though it excels in solderability.

#### (2) Phosphor bronze brazing filler

Phosphor bronze brazing filler is generally used to join copper or copper alloy.

#### (3) Low temperature brazing filler

Low temperature brazing filler is generally called solder, and is an alloy of tin and lead. Since it is weak in adhesive strength, do not use it for refrigerant pipes.

- ① Phosphor bronze brazing filler tends to react with sulfur and produce a fragile compound water solution, which may cause a gas leakage. Therefore, use any other type of brazing filler at a hot spring resort, etc., and coat the surface with a paint.
- ② When performing brazing again at time of servicing, use the same type of brazing filler.

### 7-5-2. Flux

#### (1) Reason why flux is necessary

- By removing the oxide film and any foreign matter on the metal surface, it assists the flow of brazing filler.
- In the brazing process, it prevents the metal surface from being oxidized.
- By reducing the brazing filler's surface tension, the brazing filler adheres better to the treated metal.

## (2) Characteristics required for flux

- Activated temperature of flux coincides with the brazing temperature.
- Due to a wide effective temperature range, flux is hard to carbonize.
- It is easy to remove slag after brazing.
- The corrosive action to the treated metal and brazing filler is minimum.
- It excels in coating performance and is harmless to the human body.

As the flux works in a complicated manner as described above, it is necessary to select an adequate type of flux according to the type and shape of treated metal, type of brazing filler and brazing method, etc.

## (3) Types of flux

### • Noncorrosive flux

Generally, it is a compound of borax and boric acid.

It is effective in case where the brazing temperature is higher than 800°C.

### • Activated flux

Most of fluxes generally used for silver brazing are this type.

It features an increased oxide film removing capability due to the addition of compounds such as potassium fluoride, potassium chloride and sodium fluoride to the borax-boric acid compound.

## (4) Piping materials for brazing and used brazing filler/flux

Piping material	Used brazing filler	Used flux
Copper - Copper	Phosphor copper	Do not use
Copper - Iron	Silver	Paste flux
Iron - Iron	Silver	Vapor flux

- ① Do not enter flux into the refrigeration cycle.
- ② When chlorine contained in the flux remains within the pipe, the lubricating oil deteriorates. Therefore, use a flux which does not contain chlorine.
- ③ When adding water to the flux, use water which does not contain chlorine (e.g. distilled water or ion-exchange water).
- ④ Remove the flux after brazing.

## 7-5-3. Brazing

As brazing work requires sophisticated techniques, experiences based upon a theoretical knowledge, it must be performed by a person qualified.

In order to prevent the oxide film from occurring in the pipe interior during brazing, it is effective to proceed with brazing while letting dry Nitrogen gas (N<sub>2</sub>) flow.

**Never use gas other than Nitrogen gas.**

### (1) Brazing method to prevent oxidation

- ① Attach a reducing valve and a flow-meter to the Nitrogen gas cylinder.
- ② Use a copper pipe to direct the piping material, and attach a flow-meter to the cylinder.
- ③ Apply a seal onto the clearance between the piping material and inserted copper pipe for Nitrogen in order to prevent backflow of the Nitrogen gas.
- ④ When the Nitrogen gas is flowing, be sure to keep the piping end open.
- ⑤ Adjust the flow rate of Nitrogen gas so that it is lower than 0.05 m<sup>3</sup>/Hr or 0.02 MPa (0.2kgf/cm<sup>2</sup>) by means of the reducing valve.
- ⑥ After performing the steps above, keep the Nitrogen gas flowing until the pipe cools down to a certain extent (temperature at which pipes are touchable with hands).
- ⑦ Remove the flux completely after brazing.

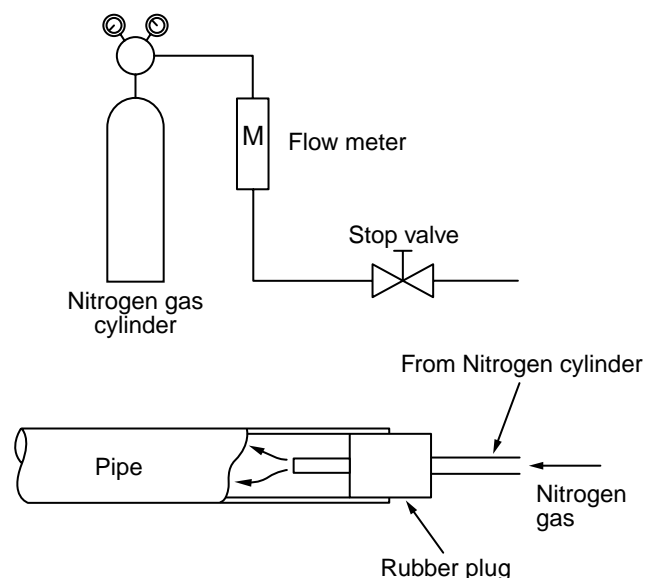
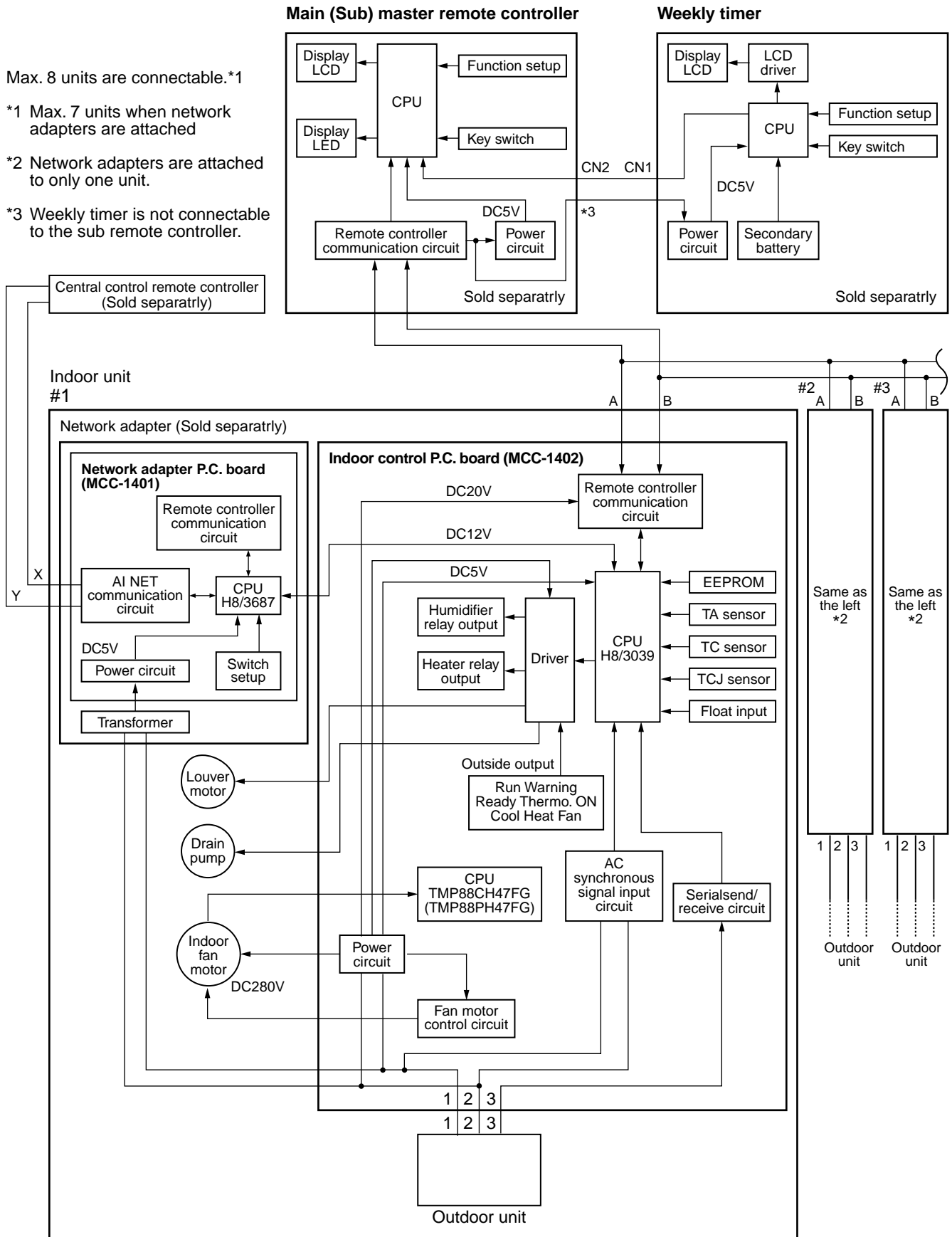

**Fig. 7-5-1 Prevention of oxidation during brazing**



# 8. INDOOR UNIT CONTROL

## 8-1. Indoor Control Circuit



## 8-2. Control Specifications

No.	Item	Outline of specifications	Remarks														
1	When power supply is reset	1) Distinction of outdoor units When the power supply is reset, the outdoors are distinguished, and control is exchanged according to the distinguished result. 2) Based on EEPROM data, speed of the indoor fan or setting whether to adjust air direction or not is selected.	Air speed/ Air direction adjustment														
2	Operation mode selection	1) Based on the operation mode selecting command from the remote controller, the operation mode is selected. <table border="1" data-bbox="459 685 1080 958" style="margin: 10px 0;"> <thead> <tr> <th>Remote controller command</th> <th>Outline of control</th> </tr> </thead> <tbody> <tr> <td>STOP</td> <td>Air conditioner stops.</td> </tr> <tr> <td>FAN</td> <td>Fan operation</td> </tr> <tr> <td>COOL</td> <td>Cooling operation</td> </tr> <tr> <td>DRY</td> <td>Dry operation</td> </tr> <tr> <td>HEAT</td> <td>Heating operation</td> </tr> <tr> <td>AUTO</td> <td> <ul style="list-style-type: none"> <li>COOL/HEAT operation mode is automatically selected by Ta and Ts for operation.</li> </ul> </td> </tr> </tbody> </table> <div data-bbox="571 1048 997 1323" style="text-align: center;"> </div> <p data-bbox="469 1352 1070 1408">1) Judge the selection of COOL/HEAT mode as shown in the figure above.</p> <p data-bbox="501 1435 1023 1543">When 10 minutes passed after thermostat had been turned off, the heating operation (Thermo OFF) is exchanged to cooling operation if Tsh exceeds +1.5 or more.</p> <p data-bbox="501 1570 1059 1626">(COOL OFF) and (COOL ON) in the figure indicate an example.</p> <p data-bbox="501 1653 1018 1760">When 10 minutes passed after thermostat had been turned off, the cooling operation (Thermo OFF) is exchanged to heating operation if Tsc exceeds -1.5 or less.</p> <p data-bbox="469 1787 1070 1843">2) For the automatic capacity control after judgment of COOL/HEAT, refer to item 4.</p> <p data-bbox="469 1843 1070 1899">3) For the temperature correction of room temperature control in automatic heating operation, refer to item 3.</p>	Remote controller command	Outline of control	STOP	Air conditioner stops.	FAN	Fan operation	COOL	Cooling operation	DRY	Dry operation	HEAT	Heating operation	AUTO	<ul style="list-style-type: none"> <li>COOL/HEAT operation mode is automatically selected by Ta and Ts for operation.</li> </ul>	<p data-bbox="1126 1059 1422 1088">Ta : Room temperature</p> <p data-bbox="1126 1095 1422 1124">Ts : Setup temperature</p> <p data-bbox="1126 1131 1445 1187">Tsc : Setup temperature in cooling operation</p> <p data-bbox="1126 1193 1445 1317">Tsh : Setup temperature + Room temperature control temperature compensation</p>
Remote controller command	Outline of control																
STOP	Air conditioner stops.																
FAN	Fan operation																
COOL	Cooling operation																
DRY	Dry operation																
HEAT	Heating operation																
AUTO	<ul style="list-style-type: none"> <li>COOL/HEAT operation mode is automatically selected by Ta and Ts for operation.</li> </ul>																

No.	Item	Outline of specifications	Remarks																				
3	Room temperature control	<p>1) Adjustment range Remote controller setup temperature (°C)</p> <table border="1" data-bbox="475 286 1082 398"> <thead> <tr> <th></th> <th>COOL/ DRY</th> <th>Heating operation</th> <th>Auto operation</th> </tr> </thead> <tbody> <tr> <td>Wired type</td> <td>18 to 29</td> <td>18 to 29</td> <td>18 to 29</td> </tr> </tbody> </table> <p>2) Using the item code 06, the setup temperature in heating operation can be compensated.</p> <table border="1" data-bbox="475 517 1082 629"> <tbody> <tr> <td>Setup data</td> <td>0</td> <td>2</td> <td>4</td> <td>6</td> </tr> <tr> <td>Setup temp. compensation</td> <td>+0°C</td> <td>+2°C</td> <td>+4°C</td> <td>+6°C</td> </tr> </tbody> </table> <p>Setting at shipment</p> <table border="1" data-bbox="475 685 762 730"> <tbody> <tr> <td>Setup data</td> <td>2</td> </tr> </tbody> </table>		COOL/ DRY	Heating operation	Auto operation	Wired type	18 to 29	18 to 29	18 to 29	Setup data	0	2	4	6	Setup temp. compensation	+0°C	+2°C	+4°C	+6°C	Setup data	2	Shift of suction temperature in heating operation
	COOL/ DRY	Heating operation	Auto operation																				
Wired type	18 to 29	18 to 29	18 to 29																				
Setup data	0	2	4	6																			
Setup temp. compensation	+0°C	+2°C	+4°C	+6°C																			
Setup data	2																						
4	Automatic capacity control (GA control)	1) Based on the difference between Ta and Ts, the operation frequency is instructed to the outdoor unit.																					
5	Air speed selection	<p>1) Operation with (HH), (H), (L), or [AUTO] mode is performed by the command from the remote controller.</p> <p>2) When the air speed mode [AUTO] is selected, the air speed varies by the difference between Ta and Ts.</p> <p><b>&lt;COOL&gt;</b></p> <p>• Controlling operation in case when thermo of remote controller works is same as a case when thermo of the body works.</p> <p>• If the air speed has been changed once, it is not changed for 3 minutes. However when the air volume is exchanged, the air speed changes.</p> <p>• When cooling operation has started, the air speed selects a downward slope, that is, the high position.</p> <p>• If the temperature is just on the difference boundary, the air speed does not change.</p> <p>• Mode in the parentheses indicates one in automatic cooling operation.</p>	HH > H > L > LL																				

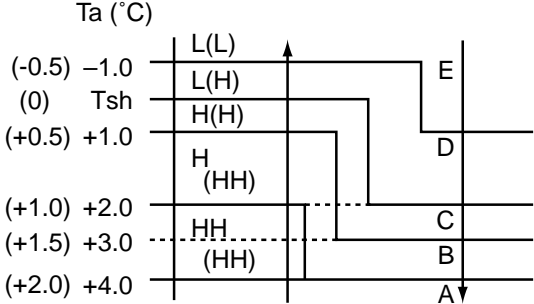
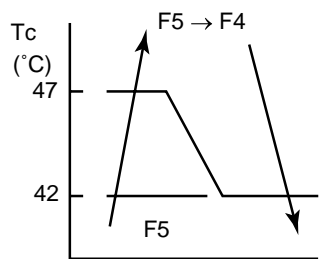
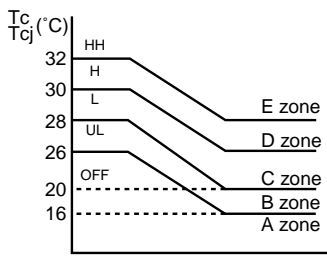
No.	Item	Outline of specifications	Remarks
5	Air speed selection (Continued)	<p><b>&lt;HEAT&gt;</b></p>  <p>Value in the parentheses indicates one when thermostat of the remote controller works. Value without parentheses indicates one when thermostat of the body works.</p> <ul style="list-style-type: none"> <li>• If the air speed has been changed once, it is not changed for 1 minute. However when the air speed is exchanged, the air speed changes.</li> <li>• When heating operation has started, the air speed selects a upward slope, that is, the high position.</li> <li>• If the temperature is just on the difference boundary, the air speed does not change.</li> <li>• Mode in the parentheses indicates one in automatic heating operation.</li> <li>• In <math>T_c \geq 60^\circ\text{C}</math>, the air speed increases by 1 step.</li> </ul> <p>3) In heating operation, the mode changes to [UL] if thermostat is turned off.</p> <p>4) If <math>T_a \geq 25^\circ\text{C}</math> when heating operation has started and when defrost operation has been cleared, it operates with HIGH (H) mode or (HH) for 1 minute from when <math>T_c</math> has entered in E zone of cool air discharge preventive control (Item 6).</p> <p>5) In automatic cooling/heating operation, the revolution frequency of [HH] is set larger than that in the standard cooling/heating operation. However the revolution frequency is restricted in the automatic heating operation as shown in the following figure.</p>	<p>[PRE-HEAT] display</p> 
6	Cool air discharge preventive control	<p>1) In heating operation, the indoor fan is controlled based on the detected temperature of <math>T_c</math> sensor or <math>T_{cj}</math> sensor. As shown below, the upper limit of the revolution frequency is determined.</p> 	<p>In D or E zone, the priority is given to setup of air volume exchange. In A and B zones, [PRE-HEAT] is displayed.</p>

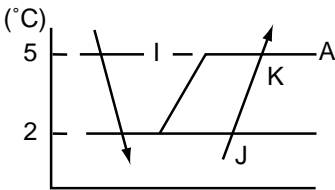
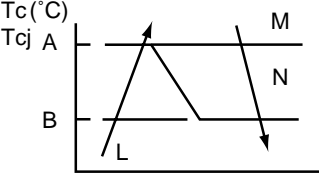
No.	Item	Outline of specifications	Remarks						
7	Freeze preventive control (Low temperature release)	<p>1) The cooling operation (including Dry operation) is performed as follows based on the detected temperature of Tc sensor or Tcj sensor.</p> <p>When [J] zone is detected for 6 minutes (Following figure), the commanded frequency is decreased from the real operation frequency. After then the commanded frequency changes every 30 seconds while operation is performed in [J] zone.</p> <p>In [K] zone, time counting is interrupted and the operation is held.</p> <p>When [I] zone is detected, the timer is cleared and the operation returns to the normal operation.</p> <p>If the commanded frequency becomes S0 because the operation continues in [J] zone, the return temperature A is raised from 5°C to 12°C until [I] zone is detected and the indoor fan operates with [M] mode.</p>  <p>In heating operation, the freeze-preventive control works if 4-way valve is not exchanged and the condition is satisfied. (However the temperature for J zone dashing control is changed from 2°C to -5°C.)</p>	<p>Tcj : Indoor heat exchanger sensor temperature</p> <p>[M] mode : Air speed selection</p>						
8	High-temp release control	<p>1) The heating operation is performed as follows based on the detected temperature of Tc sensor or Tcj sensor.</p> <ul style="list-style-type: none"> <li>• When [M] zone is detected, the commanded frequency is decreased from the real operation frequency. After then the commanded frequency changes every 30 seconds while operation is performed in [M] zone.</li> <li>• In [N] zone, the commanded frequency is held.</li> <li>• When [L] zone is detected, the commanded frequency is returned to the original value by approx. 6Hz every 60 seconds.</li> </ul> <p>Setup at shipment</p> <table border="1" data-bbox="533 1487 761 1615"> <thead> <tr> <th colspan="2">Control temp (°C)</th> </tr> </thead> <tbody> <tr> <td>A</td> <td>B</td> </tr> <tr> <td>56 (54)</td> <td>52 (52)</td> </tr> </tbody> </table>  <p><b>NOTE :</b> When the operation has started or when Tc or Tcj became lower than 30°C after start of the operation, temperature is controlled between values in parentheses of A and B.</p>	Control temp (°C)		A	B	56 (54)	52 (52)	<p>Same when thermostat is turned off.</p>
Control temp (°C)									
A	B								
56 (54)	52 (52)								
9	Drain pump control	<p>1) In cooling operation (including Dry operation), the drain pump is usually operated.</p> <p>2) If the float switch operates while drain pump operates, the compressor stops, the drain pump continues the operation, and a check code is output.</p> <p>3) If the float switch operates while drain pump stops, the compressor stops and the drain pump operates. If the float switch keeps operating for approx. 4 minutes, a check code is output.</p>	<p>Check code [P10]</p>						

No.	Item	Outline of specifications	Remarks
10	DAfter-heat elimination	When heating operation stops, the indoor fan operates with LOW mode for approx. 30 seconds.	
11	Frequency fixed operation (Test run)	<p><b>&lt;In case of wired remote controller&gt;</b></p> <ol style="list-style-type: none"> <li>1. When pushing [CHECK] button for 4 seconds or more, [TEST] is displayed on the display screen and the mode enters in Test run mode.</li> <li>2. Push [ON/OFF] button.</li> <li>3. Using [MODE] button, change the mode from [COOL] to [HEAT]. <ul style="list-style-type: none"> <li>• Do not use other mode than [COOL]/[HEAT] mode.</li> <li>• During test run operation, the temperature cannot be adjusted.</li> <li>• An error is detected as usual.</li> <li>• A frequency fixed operation is performed.</li> </ul> </li> <li>4. After the test run, push [ON/OFF] button to stop the operation. (Display in the display part is same as the procedure in item 1.)</li> <li>5. Push [CHECK] button to clear the test run mode. ([TEST] display in the display part disappears and the status returns to the normal stop status.)</li> </ol>	
12	Central control mode selection	<ol style="list-style-type: none"> <li>1) Setting at the central controller side enables to select the contents which can be operated on the remote controller at indoor unit side.</li> <li>2) <b>RBC-AMT21</b>  <b>[Last push priority] :</b>  The operation contents can be selected from both remote controller and central controller of the indoor unit side, and the operation is performed with the contents selected at the last.  <b>[Center] :</b>  Start/Stop operation only can be handled on the remote controller at indoor unit side.  <b>[Operation Prohibited] :</b>  It cannot be operated on the remote controller at indoor unit side. (Stop status is held.)</li> </ol>	<p>(No display)</p> <p>[CENTER] goes on.</p> <p>[CENTER] goes on.  In a case of wireless type, the display lamp does not change. However, contents which can be operated are same.  The status set in [CENTER]/[Operation Prohibited] mode is notified with the receiving sound "Pi, Pi, Pi, Pi, Pi" (5 times).</p>

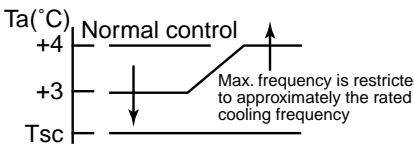
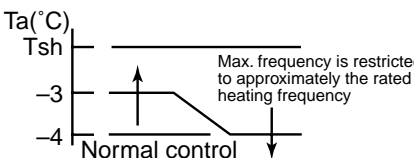
No.	Item	Outline of specifications	Remarks
13	Energy-save control (By connected outdoor unit)	1) Selecting [AUTO] mode enables an energy-saving to be operated. 2) The setup temperature is shifted (corrected) in the range not to lose the comfort ability according to input values of various sensors. 3) Data (Input value room temp. Ta, Outside temp. To, Air volume, Indoor heat exchanger sensor temp. Tc) for 20 minutes are taken the average to calculate correction value of the setup temperature. 4) The setup temperature is shifted every 20 minutes, and the shifted range is as follows. In cooling time : +1.5 to -1.0k In heating time : -1.5 to +1.0k	
14	Max. frequency cut control	1) This control is operated by selecting [AUTO] operation mode. 2) COOL operation mode: the frequency is controlled according to the following figure if $T_o < 28^{\circ}\text{C}$ .  3) HEAT operation mode: the frequency is controlled according to the right figure if $T_o > 15^{\circ}\text{C}$ . 	
15	DC motor	1) When the fan operation has started, positioning of the stator and the rotor are performed. (Moves slightly with tap sound) 2) The motor operates according to the command from the indoor controller. <b>NOTES :</b> <ul style="list-style-type: none"> <li>• When the fan rotates while the air conditioner stops due to entering of outside air, etc, the air conditioner may operated while the fan motor stops.</li> <li>• When a fan locking is found, the air conditioner stops, and an error is displayed.</li> </ul>	Check code [P12]





## 8-4. Indoor P.C. Board Optional Connector Specifications

Function	Connector No.	Pin No.	Specifications	Remarks
Option output	CN60	1	DC12V (COM)	
		2	Defrost output	ON during defrost operation of outdoor unit
		3	Thermo. ON output	ON during Real thermo-ON (Comp ON)
		4	Cooling output	ON when operation mode is in cooling system (COOL, DRY, COOL in AUTO cooling/heating)
		5	Heating output	ON when operation mode is in heating system (HEAT, HEAT in AUTO cooling/heating)
		6	Fan output	ON during indoor fan ON (Air purifier is used/Interlock cable)
Outside error input	CN80	1	DC12V (COM)	(When continued for 1 minute) Check code "L30" is output and forced operation stops.
		2	DC12V (COM)	
		3	Outside error input	
Filter option error	CN70	1	Filter/Option/Humidifier setup input	Option error input is controlled. (Protective operation for device attached to outside is displayed.)
		2	0V	* Setting of option error input is performed from remote controller. (DN=2A)
CHK Operation check	CN71	1	Check mode input	Used for operation check of indoor unit. (Communication with outdoor unit or remote controller is not performed, but the specified operation such as indoor fan "H" or drain pump ON is output.)
		2	0V	
DISP display mode	CN72	1	Display mode input	Display mode enables indoor unit and remote controller to communicate. (When power is turned on)
		2	0V	
EXCT demand	CN73	1	Demand input	Forced thermo-OFF operation in indoor unit
		2	0V	

## 9. OUTDOOR CONTROL

### 9-1. Outline of Main Controls

#### 1. Pulse Modulating Valve (PMV) control

- 1) PMV is controlled with 50 to 500 pulses during operation, respectively.
- 2) In cooling operation, PMV is controlled with the temperature difference between TS sensor and TC sensor.
- 3) In heating operation, PMV is controlled with the temperature difference between TS sensor and TE sensor.
- 4) For the temperature difference in items 2) and 3), 1 to 5K is aimed as the target in both cooling and heating operations.
- 5) When the cycle excessively rose in both cooling and heating operations, PMV is controlled by TD sensor. The aimed value is usually 105°C for SM560 and 100°C for SM800, SM1100, SM1400 in both cooling and heating operations.

#### REQUIREMENT

A sensor trouble may cause a liquid back-flow or abnormal overheat resulting in excessive shortening of the compressor life. In a case of trouble on the compressor, be sure to check there is no error in the resistance value on the refrigerating cycle of each sensor after repair and then start the operation.

#### 2. Discharge temperature release control

- 1) This function controls the operation frequency, that is, lowers the operation frequency when the discharge temperature has not lower or the discharge temperature has rapidly risen during PMV control. It subdivides the frequency control up to a unit of 0.6Hz to stabilize the cycle.
- 2) When the discharge temperature is detected in an abnormal stop zone, the unit stops the compressor and restarts after 2 minutes 30 seconds. The error counter is cleared when it has continued the operation for 10 minutes. If the abnormal stop zone has been detected by 4 times without clearing of counter, an error 'P03' is displayed.

\* The cause is considered as excessively little amount of refrigerant, defective PMV, or clogging of cycle.

[°C]

	a	b	c	d	e
<b>SM560</b>	117	112	108	105	98
<b>SM800, 1100, 1400</b>	111	106	100	95	90

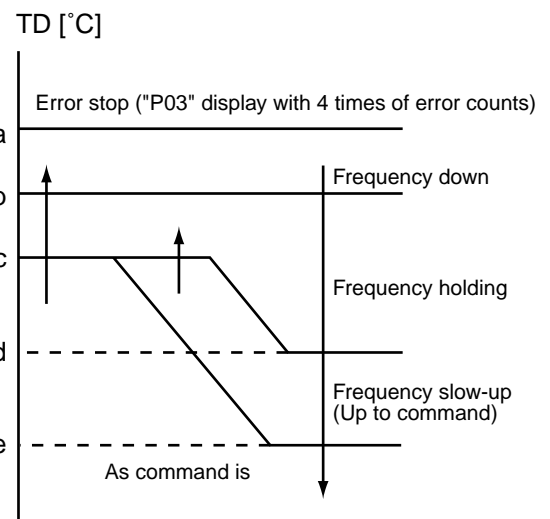

[A]

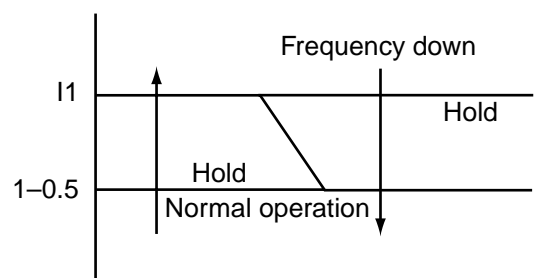

#### 3. Current release control

The output frequency and the output voltage are controlled by AC current value detected by T02 on the outdoor P.C. board so that input current of the inverter does not exceed the specified value.

Objective model	SM560		SM800		SM1100		SM1400	
	COOL	HEAT	COOL	HEAT	COOL	HEAT	COOL	HEAT
I1 value [A]	9.22	11.93	12.00	13.43	18.90	19.65	19.65	19.65

\* For the cooling only models, only COOL is objective.

#### 4. Outdoor fan control (Object: SM800, SM1100, SM1400)

Allocations of fan tap revolutions [rpm]

		W1	W2	W3	W4	W5	W6	W7	W8	W9	WA	WB	WC	WD	WE
<b>SM800</b>	—	250	270	290	310	340	370	400	440	480	520	560	610	700	780
<b>SM1100</b>	Upper fan	250	280	300	320	340	380	420	470	520	570	630	690	740	800
	Lower fan	OFF	OFF	270	290	400	480	520	560	600	660	720	780	860	940
<b>SM1400</b>	Upper fan	250	270	270	300	350	410	470	530	590	670	750	810	840	860
	Lower fan	OFF	OFF	240	270	330	390	450	510	570	650	730	790	820	840

##### 1) Cooling fan control

- ① The outdoor fan is controlled by TE sensor.  
(Cooling: Temperature conditions after medium term)  
The cooling fan is controlled by every 1 tap of DC fan control (14 taps).
- ② At the activation time, although the maximum fan tap in the following table are fixed for 60 seconds, after then the fan may not rotate with high speed for several minutes because the fan is controlled by TE sensor value. It is not an abnormal status.
- ③ When the discharge temperature sensor is abnormal or the sensor comes off the holder, the fan does not rotate with high speed, but a protective device works.
- ④ When the outdoor fan does not rotate with high speed, judge a fan error by comparing the control data in the following table with TO and TE values.

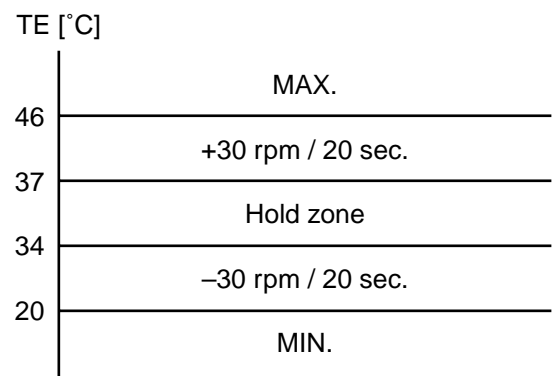

Control for fan tap by outdoor temperature in normal operation

TO	TO < 5°C	5 ≤ TO < 10°C	10 ≤ TO < 15°C	15 ≤ TO < 20°C	20 ≤ TO < 25°C	25°C ≤ TO	TO error
MIN	W1	W2	W3	W4	W5	WA	W1
MAX	W6	W8	WA	WC	WE	WE	WE

##### 2) Heating fan control

- ① This control function lowers fan tap according to TE sensor value when outdoor temperature is high.
- ② When a status TE > 20°C is detected continuously for 5 minutes, the operation may stop. This status does not output an error code and is assumed as usual status of thermo-OFF. The fan restarts after approx. 2 minutes 30 seconds and this intermittent operation is not a trouble.
- ③ If the status in item ② is frequently found, it is considered that the filter of suction part of the indoor unit is dirty. Clean the filter and restart the operation.
- ④ This control function does not work for 30 minutes after activation, 1 minute after defrosting, and during defrost operation.

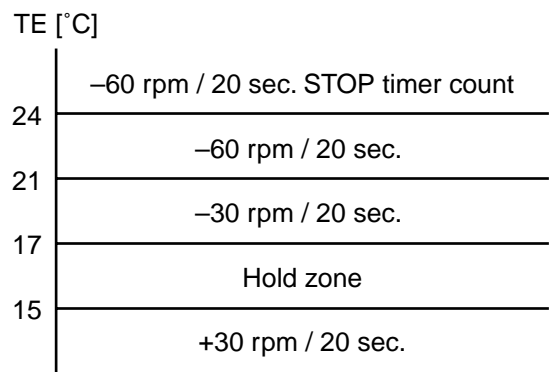

### 5. Outdoor fan control (Object: SM560)

The outdoor fan is controlled by TO sensor and the revolutions frequency of the compressor (rps). The outdoor fan is controlled by every 1 tap of DC fan control (8 taps). According to each operation mode, the fan is operated by selecting an outdoor fan operation tap in the following table based upon the conditions of TO sensor and the compressor operation (rps).

**Allocations of fan tap revolutions**

Tap		F1	F2	F3	F4	F5	F6	F7	F8
<b>SM560</b>	Revolutions per minute (rpm)	960	870	870	870	750	700	540	390

**In cooling operation**

Frequency of the compressor (rps)	To 14	To 14	35 to MAX
TO ≥ 38°C	F7	F4	F3
TO < 38°C	F7	F5	F4

**In heating operation**

Frequency of the compressor (rps)	To 14	To 14	35 to MAX
TO ≥ 5.5°C	F7	F6	F4
TO < 5.5°C	F6	F6	F3

### 6. Coil heating control

- 1) This control function heats the compressor by turning on the stopped compressor instead of a case heater. It purposes to prevent slackness of the refrigerant inside of the compressor.
- 2) As usual, turn on power of the compressor for the specified time before a test run after installation, otherwise a trouble of the compressor may be caused. As same as a test run, it is recommended to turn on power of the compressor beforehand when starting operation after power of the compressor has been interrupted for a long time.
- 3) A judgment for electricity is performed by TD and TO sensors. If TO sensor is defective, a backup control is automatically performed by TE sensor. For a case of defective TO sensor, judge it with the outdoor LED display.
- 4) Coil heating is controlled by TD and TE sensor.
- 5) For every model, the power is turned off when TD is 30°C or more.

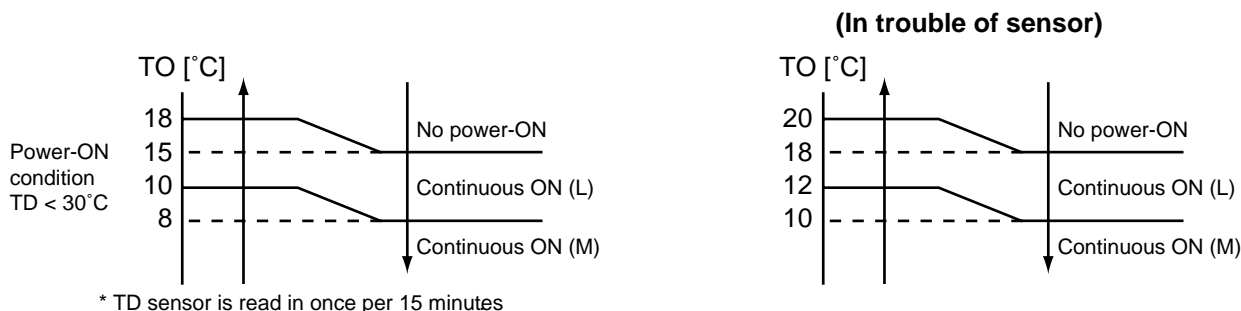

	<b>SM800</b>	<b>SM1100</b>	<b>SM1400</b>
L	20W and equivalent	20W and equivalent	25W and equivalent
M	40W and equivalent	40W and equivalent	50W and equivalent

**(Object: SM560)**

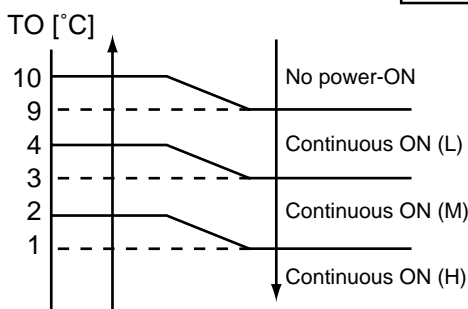

<b>SM560</b>	
L	10W and equivalent
M	20W and equivalent
H	30W and equivalent

## NOTIFICATION

It is not an abnormal phenomenon that electro-noise may be heard while heating the coil.

### 7. Short intermittent operation preventive control

- ① The compressor may not stop for preventing the compressor for 3 to 10 minutes after start of the operation even if Thermo-OFF signal has been received from the indoor. This phenomenon is not abnormal. (Continuous operation time of the compressor differs according to the operating status.)
- ② If the equipment is stopped from the remote controller, the operation does not continue.

### 8. High-pressure suppression TE control (For SM800)

- ① This control suppresses that pressure becomes abnormally higher during cooling operation.
- ② Stop the compressor under condition of  $TE \geq 67^\circ\text{C}$ , and count 1 on the error count.
- ③ After 2 minutes 30 seconds passed, if  $TE < 67^\circ\text{C}$ , the compressor restarts and the error count is cleared when the operation continues for 10 minutes.
- ④ When  $TE \geq 67^\circ\text{C}$  is detected again within 10 minutes, 1 is added to the error count and restart is repeated.
- ⑤ If the error counts 10 are recognized, it is determined as an error and restart is not performed. Error code 'P04' is displayed.
- ⑥ After restarting the compressor, continue controlling by using 70% to 90% of the control value of the current release control for minimum 30 minutes.

### 9. Over-current preventive control

- ① This control function stops the compressor when over-current preventive circuit has detected an abnormal current.
- ② The compressor restarts with error count 1 after 2 minutes 30 seconds.
- ③ If the error counts 4 are recognized, it is determined as an error and restart is not performed. Error code 'H01', 'H02' or 'P26' is displayed.

### 10. Current release value shift control

1) For SM800, SM1100, SM1400

- ① This control function prevents troubles of the electron parts such as G-Tr of inverter of compressor drive system and troubles of the compressor during cooling operation.
- ② This control function corrects the current release control value (I1) in item 3 of 9-1. by Current release control.
- ③ The value to be corrected is based upon the following control diagram and correction value table.

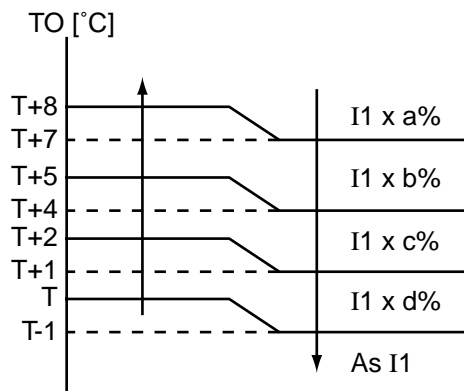

Corrected value

	T	a	b	c	d
<b>SM800</b>	39°C	40%	60%	80%	85%
<b>SM1100</b>	39°C	50%	70%	80%	90%
<b>SM1400</b>	39°C	70%	80%	90%	95%

2) For SM560

The current release value of a single-phase model is selected from the right table according to TO sensor value.

Current release value shift control

TO	SM560
$45 \leq TO$	5.92
$40 \leq TO < 45$	6.75
$TO < 40$	9.00

## 11. Defrost control

- ① In heating operation, defrost operation is performed when TE sensor temperature satisfies any condition in A zone to D zone.
- ② The defrost operation is immediately finished if TE sensor temperature has become 12°C or more, or it also is finished when condition of  $7^{\circ}\text{C} \leq \text{TE} < 12^{\circ}\text{C}$  has continued for 1 minute. The defrost operation is also finished when defrost operation has continued for 10 minutes even if TE sensor temperature has become 7°C or lower.
- ③ After defrost operation has finished, the compressor and the outdoor fan start heating operation after stopped for approx. 50 seconds.

### Start of heating operation

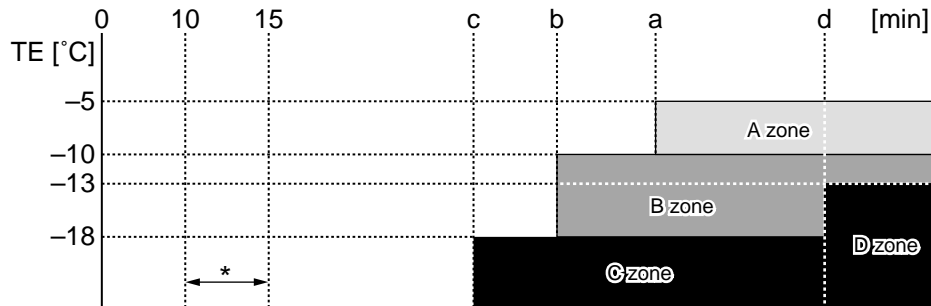

\* The minimum TE value between 10 and 15 minutes after heating operation has started is stored in memory as TE0.

A zone	Defrost operation is performed in this zone when $\text{TE0} - \text{TE} \geq 3$ continued for T seconds.
B zone	Defrost operation is performed in this zone when $\text{TE0} - \text{TE} \geq 3$ continued for T seconds.
C zone	Defrost operation is performed when this zone continued for T seconds.
D zone	Defrost operation is performed when this zone continued for T seconds.

	SM560	SM800, SM1100, SM1400
a	28	34
b	28	40
c	28	55
d	60	90
T	120	20

**9-2. Outdoor Controls**  
**9-2-1. Print Circuit Board**  
 <Viewed from parts of P.C boards>  
**MCC-813 (RAV-SMS560AT-E)**

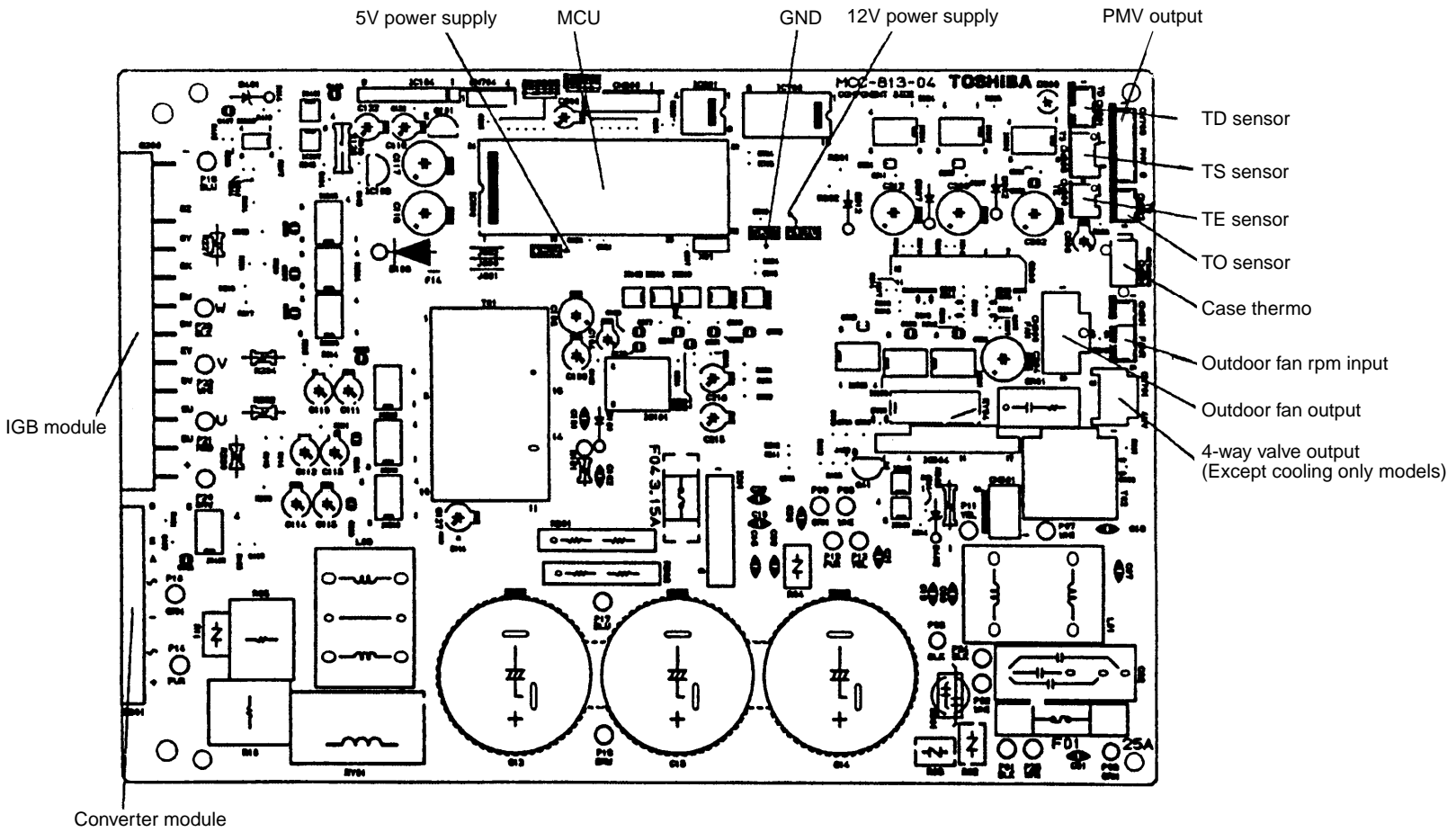

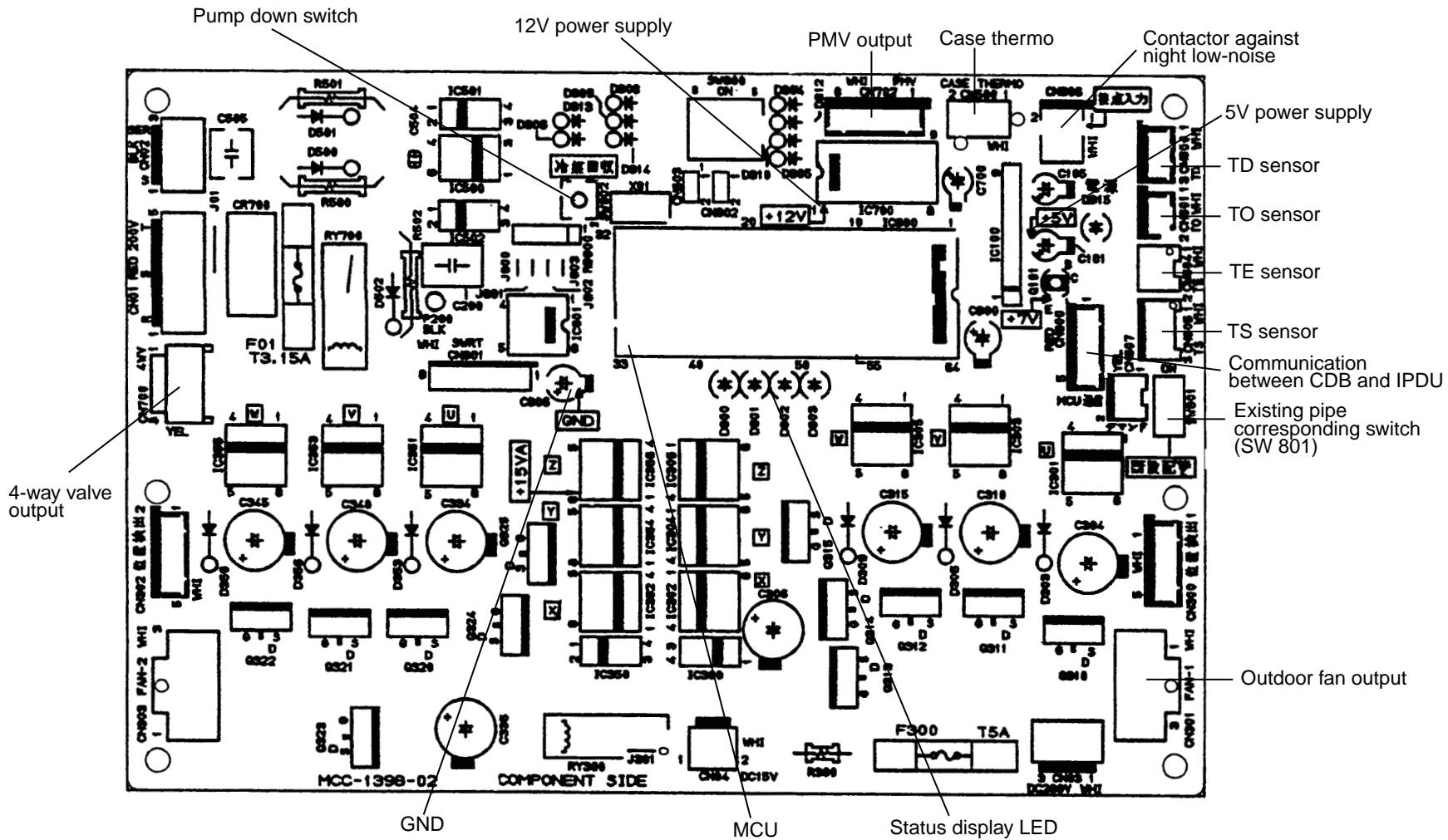



## 10. TROUBLESHOOTING

### 10-1. Summary of Troubleshooting

#### <Wired remote controller type>

##### 1. Before troubleshooting

###### 1) Required tools/instruments

- ⊕ and ⊖ screwdrivers, spanners, radio cutting pliers, nippers, push pins for reset switch
- Tester, thermometer, pressure gauge, etc.

###### 2) Confirmation points before check

###### ① The following operations are normal.

###### a) Compressor does not operate.

- Is not 3-minutes delay (3 minutes after compressor OFF)?
- Does not thermostat turn off?
- Does not timer operate during fan operation?
- Is not outside high-temperature operation controlled in heating operation?

###### b) Indoor fan does not rotate.

- Does not cool air discharge preventive control work in heating operation?

###### c) Outdoor fan does not rotate or air volume changes.

- Does not high-temperature release operation control work in heating operation?
- Does not outside low-temperature operation control work in cooling operation?
- Is not defrost operation performed?

###### d) ON/OFF operation cannot be performed from remote controller.

- Is not the control operation performed from outside/remote side?
- Is not automatic address being set up?

(When the power is turned on at the first time or when indoor unit address setting is changed, the operation cannot be performed for maximum approx. 5 minutes after power-ON.)

###### ② Did you return the cabling to the initial positions?

###### ③ Are connecting cables of indoor unit and remote controller correct?

##### 2. Troubleshooting procedure

When a trouble occurred, check the parts along with the following procedure.

**Trouble** → **Confirmation of check code display** → **Check defective position and parts.**

#### NOTE :

For cause of a trouble, power conditions or malfunction/erroneous diagnosis of microcomputer due to outer noise is considered except the items to be checked. If there is any noise source, change the cables of the remote controller to shield cables.

## 10-2. Check Code List

### Error mode detected by indoor unit

: Flash, ○ : Go on,    : Go off

Wireless sensor lamp display			Wired remote controller	Diagnostic function			Judgment and measures
Operation	Timer	Ready	Check code	Cause of operation	Status of air conditioner	Condition	
			E03	No communication from remote controller (including wireless) and communication adapters	Stop (Automatic reset)	Displayed when error is detected	1. Check cables of remote controller and communication adapters. • Handy remote controller LCD display OFF (Disconnection) • Central remote controller [97] check code
			E04	The serial signal is not output from outdoor unit to indoor unit. • Miscabling of inter-unit cables • Defective serial sensing circuit on outdoor P.C. board • Defective serial receiving circuit on indoor P.C. board	S top (Automatic reset)	Displayed when error is detected	1. Outdoor unit does not completely operate. • Inter-unit cable check, correction of miscabling, case thermo operation • Outdoor P.C. board check, P.C. board cables check 2. In normal operation P.C. board (Indoor receiving/Outdoor sending) check
			E08	Duplicated indoor unit addresses	Stop	Displayed when error is detected	1. Check whether there is modification of remote controller connection (Group/Individual) or not after power has been turned on (finish of group configuration/address check). * If group configuration and address are not normal when the power has been turned on, the mode automatically shifts to address setup mode. (Resetting of address)
			L03	Duplicated indoor master units			
			L07	There is group line in individual indoor units.			
			L08	Unsetting of indoor group address			
			L09	Unset indoor capacity	Stop	Displayed when error is detected	1. Set the indoor capacity. (DN=I1)
			L30	Abnormal outside interlock input	Stop	Displayed when error is detected	1. Check outside devices. 2. Check indoor P.C. board.
			P01	Fan motor thermal protection	Stop	Displayed when error is detected	1. Check thermal relay of fan motor. 2. Check indoor P.C. board.
			P10	Float switch operation • Disconnection, coming-off, defective float switch contactor of float circuit	Stop	Displayed when error is detected	1. Defect of drain pump 2. Clogging of drain pump 3. Check float switch. 4. Check indoor P.C. board.
			P12	Indoor DC fan error	Stop	Displayed when error is detected	1. Defective detection of position 2. Over-current protective circuit of indoor fan driving unit operates. 3. Lock of indoor fan 4. Check indoor P.C. board.
			P19	Error in 4-way valve system • Indoor heat exchanger temperature lowered after start of heating operation.	Stop (Automatic reset)	Displayed when error is detected	1. Check 4-way valve. 2. Check indoor heat exchanger (TC/TCJ) sensor. 3. Check indoor P.C. board.
			P31	Own unit stops while warning is output to other indoor units.	Stop (Sub unit) (Automatic reset)	Displayed when error is detected	1. Judge sub unit while master unit is in [E03], [L03], [L07], [L08]. 2. Check indoor P.C. board.
			F01	Coming-off, disconnection or short of indoor heat exchanger sensor (TCJ)	Stop (Automatic reset)	Displayed when error is detected	1. Check indoor heat exchanger temperature sensor (TCJ). 2. Check indoor P.C. board.
			F02	Coming-off, disconnection or short of indoor heat exchanger sensor (TC)	Stop (Automatic reset)	Displayed when error is detected	1. Check indoor heat exchanger temperature sensor (TC). 2. Check indoor P.C. board.
			F10	Coming-off, disconnection or short of indoor heat exchanger sensor (TA)	Stop (Automatic reset)	Displayed when error is detected	1. Check indoor heat exchanger temperature sensor (TA). 2. Check indoor P.C. board.
			F29	Indoor EEPROM error • EEPROM access error	Stop (Automatic reset)	Displayed when error is detected	1. Check indoor EEPROM. (including socket insertion) 2. Check indoor P.C. board.
			E10	Communication error between indoor MCU • Communication error between fan driving MCU and main MCU	Stop (Automatic reset)	Displayed when error is detected	1. Check cables of remote controller. 2. Check power cables of indoor unit. 3. Check indoor P.C. board.
			E18	Regular communication error between master and sub indoor units or between main and sub indoor units	Stop (Automatic reset)	Displayed when error is detected	1. Check cables of remote controller. 2. Check indoor power cable. 3. Check indoor P.C. board.

## Error mode detected by outdoor unit

: Flash, ○ : Go on,    : Go off

Wireless sensor lamp display			Wired remote controller	Diagnostic function			Judgment and measures
Operation	Timer	Ready	Check code	Cause of operation	Status of air conditioner	Condition	
			H01	Breakdown of compressor • Displayed when error is detected	Stop	Displayed when error is detected	1. Check power voltage. AC200V±20V 2. Overload operation of refrigerating cycle 3. Check current detection circuit at AC side.
			H02	Compressor does not rotate. • Over-current protective circuit operates after specified time passed when compressor had been activated.	Stop	Displayed when error is detected	1. Trouble of compressor (Compressor lock, etc.) : Replace compressor. 2. Defective cabling of compressor (Phase missing) 3. Phase-missing operation of power supply (3-phase model)
			H03	Current detection circuit error • Current value at AC side is high even during compressor-OFF. • Phase of power supply is missed.	Stop	Displayed when error is detected	1. Compressor immediately stops even if restarted. : Check IPDU. 2. Phase-missing operation of power supply Check 3-phase power voltage and cables.
			L29	Outdoor unit and other errors • Communication error between CDB and IPDU (Coming-off of connector) • Heat sink temperature error (Detection of temperature over specified value)	Stop	Displayed when error is detected	1. Check cables of CDB and IPDU. 2. Abnormal overload operation of refrigerating cycle
			L31	Phase detection protective circuit operates. (Normal models)	Operation continues. (Compressor stops.)	Displayed when error is detected	1. Check power phase order (Reversed phase)/phase missing. 2. Check outdoor P.C. board.
			P03	Discharge temperature error • Discharge temperature over specified value was detected.	Stop	Displayed when error is detected	1. Check refrigerating cycle. (Gas leak) 2. Trouble of PMV 3. Check Td sensor.
			P04	High-pressure protection error by TE sensor (Temperature over specified value was detected.)	Stop	Displayed when error is detected	1. Overload operation of refrigerating cycle 2. Check outdoor temperature sensor (TE). 3. Check outdoor CDB P.C. board.
			P22	Outdoor DC fan error	Stop	Displayed when error is detected	1. Defective detection of position 2. Over-current protective circuit of outdoor fan driving unit operates. 3. Lock of outdoor fan 4. Check outdoor CDB P.C. board.
			P26	Inverter over-current protective circuit operates. (For a short time) Short voltage of main circuit operates.	Stop	Displayed when error is detected	1. Inverter immediately stops even if restarted. : Compressor motor rare short 2. Check IPDU. : Cabling error
			P29	IPDU position detection circuit error	Stop	Displayed when error is detected	1. Position detection circuit operates even if operating compressor by removing 3P connector. : Replace IPDU.
			F04	Coming-off, disconnection or short of outdoor temperature sensor (TD)	Stop	Displayed when error is detected	1. Check outdoor temperature sensor (TD). 2. Check outdoor CDB P.C. board.
			F06	Coming-off, disconnection or short of outdoor temperature sensor (TE/TS)	Stop	Displayed when error is detected	1. Check outdoor temperature sensor (TE/TS). 2. Check outdoor CDB P.C. board.
			F08	Coming-off, disconnection or short of outdoor temperature sensor (TO)	Operation continues.	Displayed when error is detected	1. Check outdoor temperature sensor (TO). 2. Check outdoor CDB P.C. board.

For an error mode detected in outdoor unit, the fan operates because sub unit of a group operation does not communicate with the outdoor unit.

## Error mode detected by remote controller or network adapter

: Flash, ○ : Go on,    : Go off

Wireless sensor lamp display			Wired remote controller	Diagnostic function			Judgment and measures
Operation	Timer	Ready	Check code	Cause of operation	Status of air conditioner	Condition	
—	—	—	No check code is displayed. (Remote controller does not operate.)	No communication with master indoor unit <ul style="list-style-type: none"> <li>• Remote controller cable is not correctly connected.</li> <li>• Power of indoor unit is not turned on.</li> <li>• Automatic address cannot be completed.</li> </ul>	Stop	—	Remote controller power error, Defective indoor EEPROM <ol style="list-style-type: none"> <li>1. Check remote controller inter-unit cables.</li> <li>2. Check remote controller.</li> <li>3. Check indoor power cables.</li> <li>4. Check indoor P.C. board.</li> <li>5. Check indoor EEPROM. (including socket insertion)</li> </ol> : Phenomenon of automatic address repetition occurred.
			E01*2	No communication with indoor master unit <ul style="list-style-type: none"> <li>• Disconnection of inter-unit cable between remote controller and master indoor unit (Detected at remote controller side)</li> </ul>	Stop (Automatic restart) * When there is center, operation continues.	Displayed when error is detected	Signal receiving of remote controller is defective. <ol style="list-style-type: none"> <li>1. Check remote controller inter-unit cables.</li> <li>2. Check remote controller.</li> <li>3. Check indoor power cables.</li> <li>4. Check indoor P.C. board.</li> </ol>
			E02	Signal sending error to indoor unit (Detected at remote controller side)	Stop (Automatic restart) * When there is center, operation continues.	Displayed when error is detected	Signal sending of remote controller is defective. <ol style="list-style-type: none"> <li>1. Check sending circuit inside of remote controller.</li> </ol> : Replace remote controller.
			E09	Multiple master remote controllers are recognized. (Detected at remote controller side)	Stop (Sub unit continues operation.)	Displayed when error is detected	1. Check there are multiple master units for 2 remote controllers (including wireless). : Master unit is one and others are sub units.
			L20 Central remote controller 98	Duplicated indoor central addresses on communication of central control system (AI-NET) (Detected by central controller side)	Stop (Automatic restart)	Displayed when error is detected	1. Check address setup of central control system network. (Network adapter SW01) 2. Check network adapter P.C. board.
—	—	—	— *3 Central remote controller 99	Multiple network adapters on remote controller communication line (Detected by central controller side)	Operation continues.	Displayed when error is detected	1. Check multiple network adapters. 2. Check inter-unit cable/miscabling of remote controller. : Only one network adapter on remote controller communication line
—	—	—	— *3 Central remote controller 97	Interruption of central control system (AI-NET) communication circuit (Detected by central controller side)	Operation continues. (According to handy remote controller)	Displayed when error is detected	1. Check communication line/miscabling. Check power of indoor unit. 2. Check communication. (XY terminals) 3. Check network adapter P.C. board. 4. Check central controller (such as central control remote controller, etc.).
—	—	—	— Central remote controller b7	Indoor Gr sub unit error (Detected by central controller side)	Continuation/stop (Based on a case)	Displayed when error is detected	Check the check code of corresponding unit by handy remote controller.

\*2 Check code is not displayed by wired remote controller. (Usual operation of air conditioner is disabled.)

For wireless type models, E01 is notified by the display lamp.

\*3 These errors are related to communication of remote controllers (A, B) and central system (AI-NET, X, Y), and [E01], [E02], [E03], [E09], or [E18] is displayed or no check code is displayed on the remote controller according to the error contents.

### 10-3. Error Mode Detected by LED on Outdoor P.C. Board

#### RAV-SM800AT-E

##### <SW800: LED display in bit 1, bit 2, bit 3, bit 4 OFF>

- When multiple errors are detected, the latest error is displayed.
- While LED displays ○ (go on), there is the main cause of error in control at CDB side and it stops abnormally.
- While LED displays (flash), there is the main cause of error in control at IPDU side and it stops abnormally.
- For an error in case thermo operation, the communication is interrupted on the serial circuit. If continuing the case thermo operation, serial sending to the indoor unit is interrupted and a serial communication error is output.

	No.	Item	Check code	LED display			
			B type	D800 (Red)	D801 (Yellow)	D802 (Yellow)	D803 (Yellow)
CDB side	1	TE sensor error	18	○			
	2	TD sensor error	19	○	○		
	3	TS sensor error	18			○	
	4	TO sensor error	1B		○		
	5	Discharge temp error	1E		○	○	
	6	Out DC fan error	1A	○	○	○	
	7	Communication error between IPDU (Abnormal stop)	1C	○			○
	8	High-pressure release operation	21		○		○
			—				
	9	EEPROM error	—	○	○		○
10	Communication error between IPDU (No abnormal stop)	—			○	○	
IPDU side	11	G-Tr short-circuit protection	14				
	12	Detection circuit error	16				
	13	Current sensor error	17				
	14	Phase missing detection	17				
	15	Comp lock error	1D				
	16	Comp breakdown	1F				

○ : Go on      ( ) : Go off      ( ) : Flash (5Hz)

## RAV-SM1100AT-E / RAV-SM1400AT-E

### <SW800: LED display in bit 1, bit 2, bit 3 OFF>

- When multiple errors are detected, the latest error is displayed.
- When LED display is (Go on), there is the main cause of trouble on the objective part of control at CDB side and the unit stops.
- When LED display is (Flash), there is the main cause of trouble on the objective part of control at IPDU side and the unit stops.
- When case thermostat operates, the communication is interrupted on the serial circuit. If continuing the case thermostat operation, a serial communication error occurs because serial sending to the indoor unit is interrupted.

	No.	Item	Check code		LED display			
			Type A	Type B	D800 (Red)	D801 (Yellow)	D802 (Yellow)	D803 (Yellow)
CDB side	1	TE sensor error	F06	18				
	2	TD sensor error	F04	19				
	3	TS sensor error	F06	18				
	4	TO sensor error	F08	1B				
	5	Discharge temp. error	P03	1E				
	6	DC outdoor fan error	P22	1A				
	7	Communication error between IPDU (Abnormal stop)	L29	1C				
	8	High-pressure release operation	P04	21 —				
	9	EEPROM error	—	—				
	10	Communication error between IPDU (No abnormal stop)	—	—				
IPDU side	11	G-Tr short-circuit protection	P26	14				
	12	Detection circuit error	P29	16				
	13	Current sensor error	H03	17				
	14	Phase missing detection	H03	17				
	15	Comp. lock error	H02	1D				
	16	Comp. breakdown	H01	1F				

: Go on      : Go off      : Flash (5Hz)

### <<Check code>>

The check codes are classified into Type A according to the used remote controller. Be sure to check the remote controller which you use.

#### Type A :

Neutral 2-cores type wired remote controller such as RBC-AMT21E and RBC-AS21E.

## 10-4. Troubleshooting Procedure for Each Check Code

### 10-4-1. New Check Code/Present Check Code (Central Control Side)

#### [E01 error]/\*[99 error]

\* : When central controller [99] is displayed, there are other causes of error.

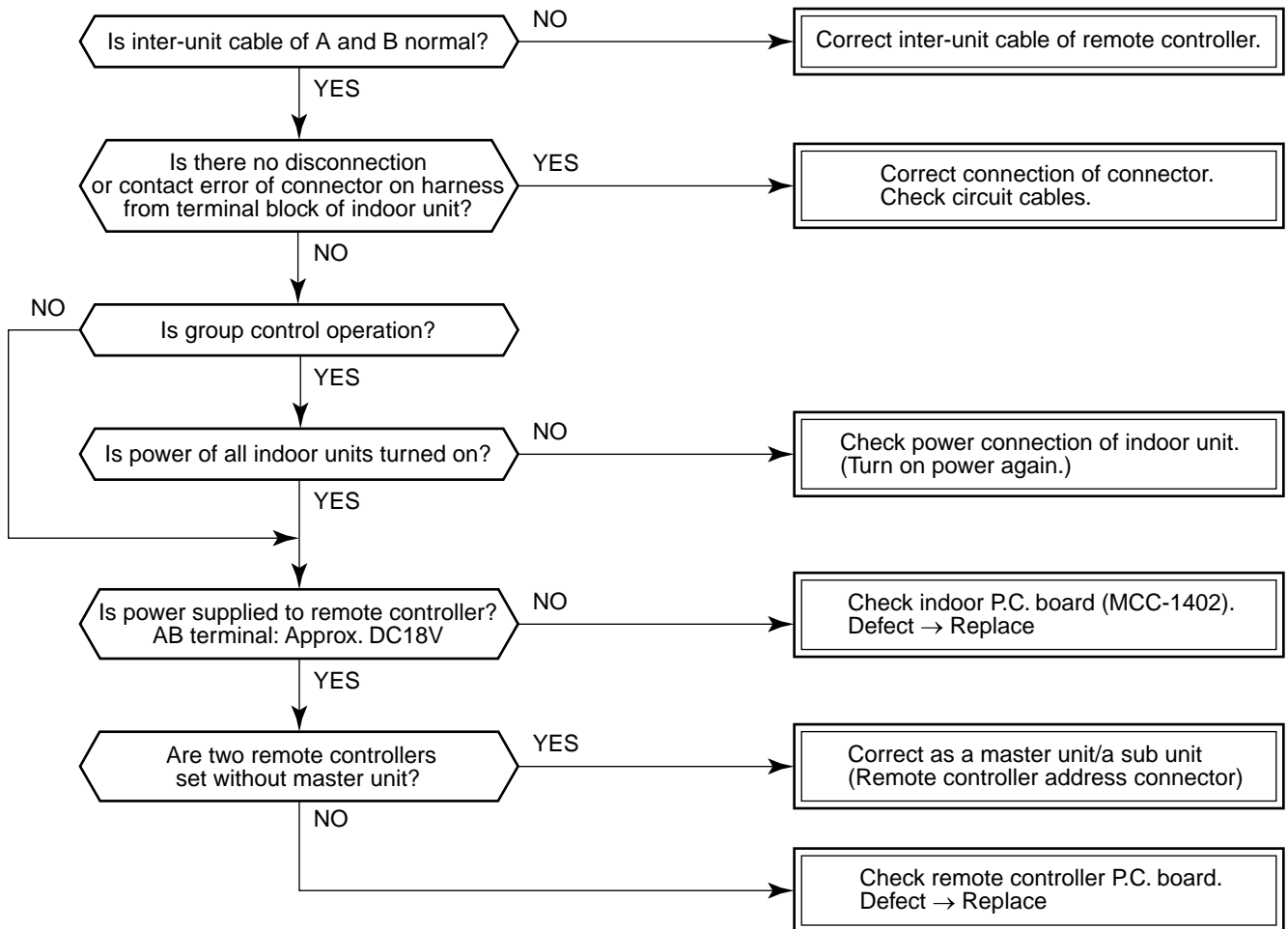

#### [E09 error]/\*[99 error]

\* : When central controller [99] is displayed, there are other causes of error.

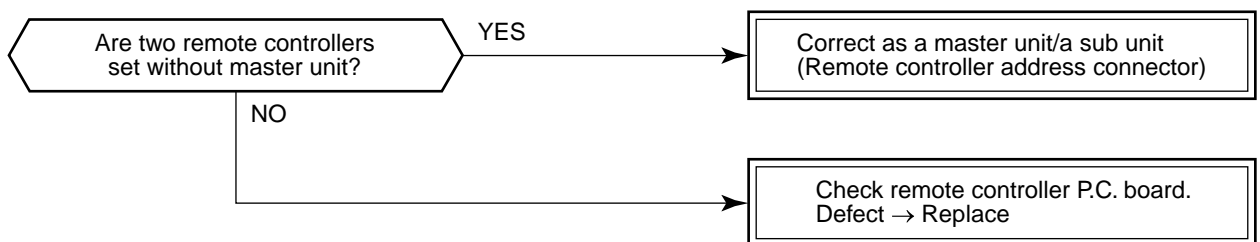

**[E04 error]/[04 error]**

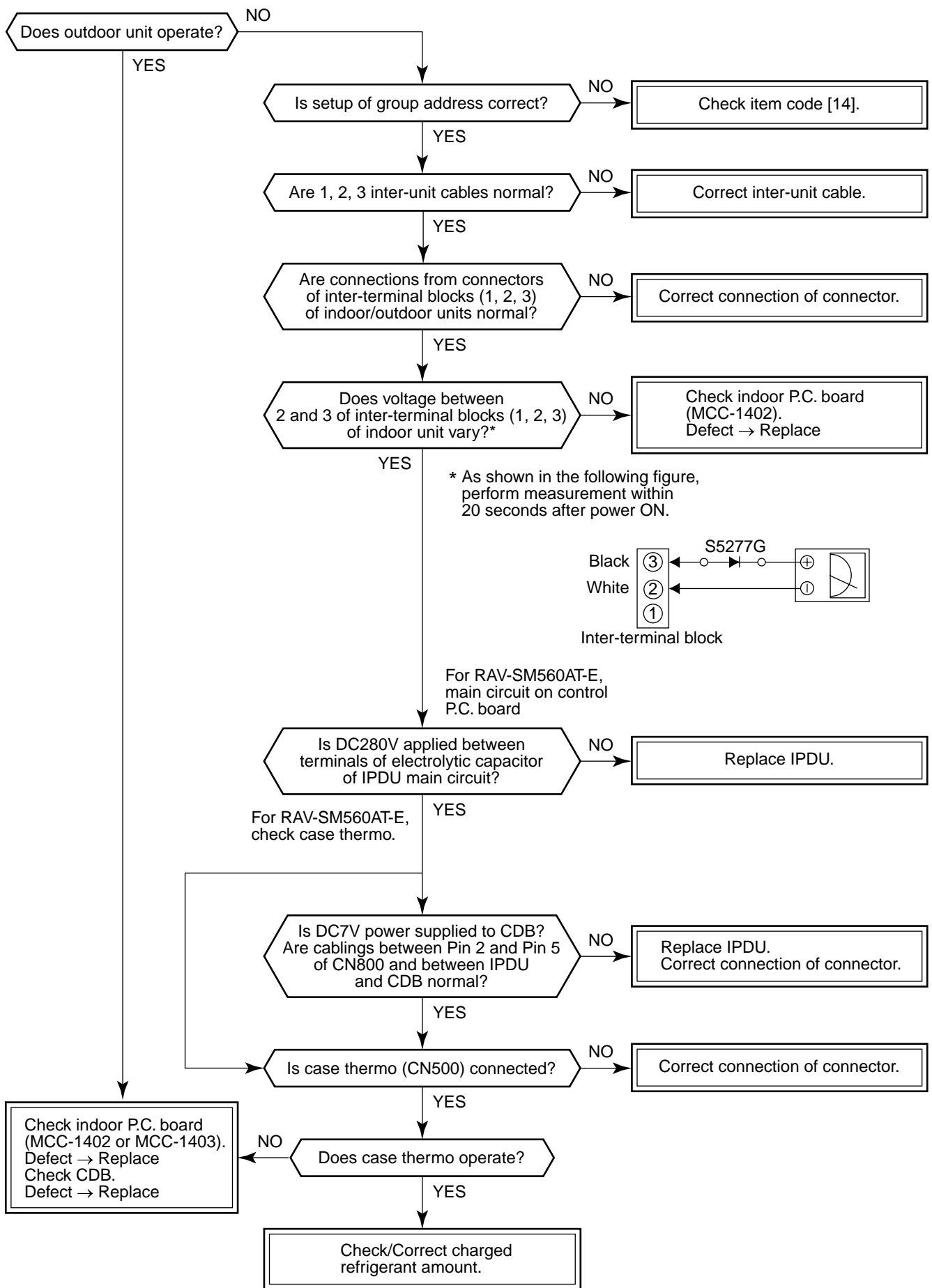



**[E10 error]/[CF error]**

Check indoor control P.C. board (MCC-1402).  
Defect → Replace

**[E18 error]/[97 error] \*[99 error]**

\* :When central controller [99] is displayed, there are other causes of trouble.

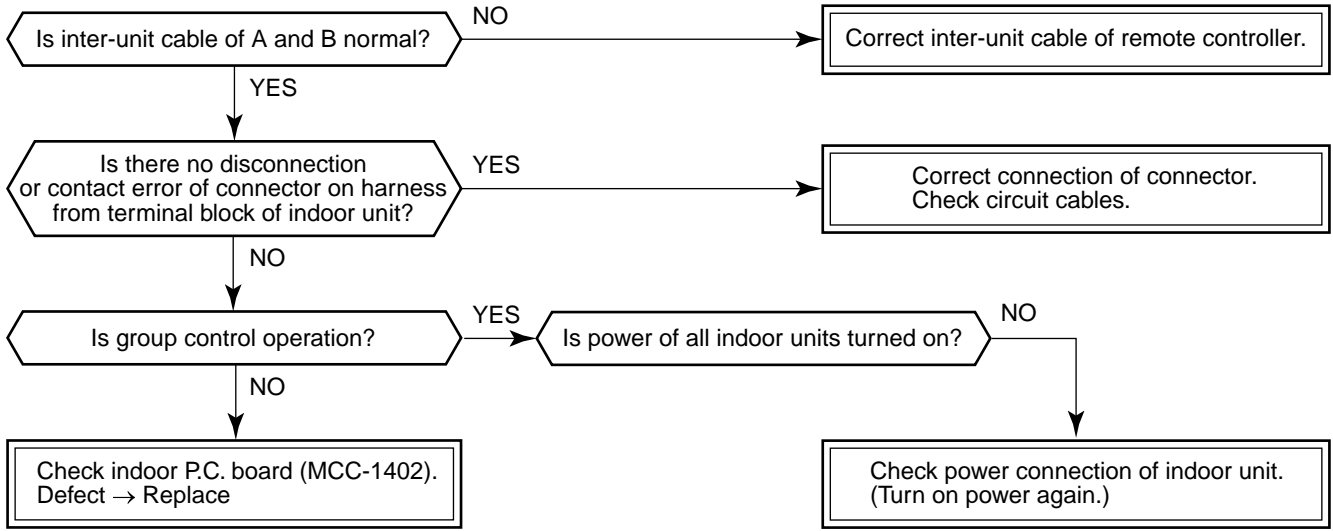

**[E08, L03, L07, L08 error]/ \*[96 error] [99 error]**

\* :When central controller [99] is displayed, there are other causes of trouble.

E08 : Duplicated indoor unit numbers

L03 : Two or more master units in a group control

L07 : One or more group addresses of [Individual] in a group control

L08 : Unset indoor group address (99)

If the above is detected when power has been turned on, the mode automatically enters in automatic address setup mode. (Check code is not displayed.)

However, if the above is detected during automatic address setup mode, the check code may be displayed.

**[L09 error]/[46 error]**

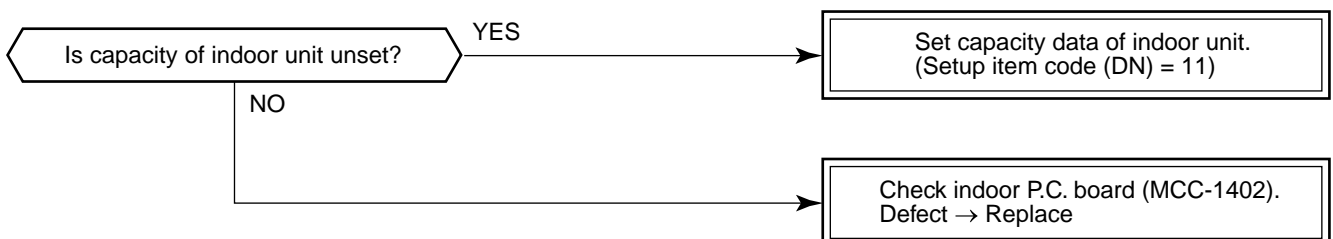

**[L20 error]/[98 error]**

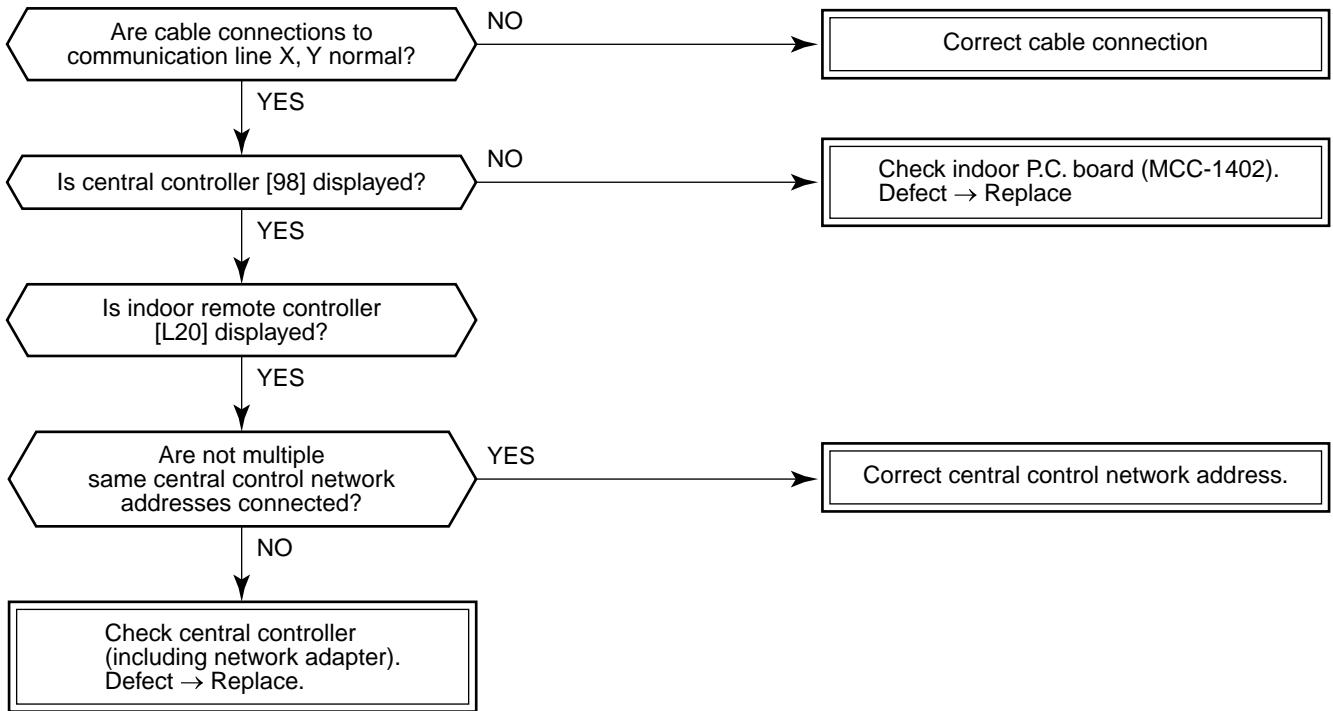

**[L30 error]/[B6 error]**

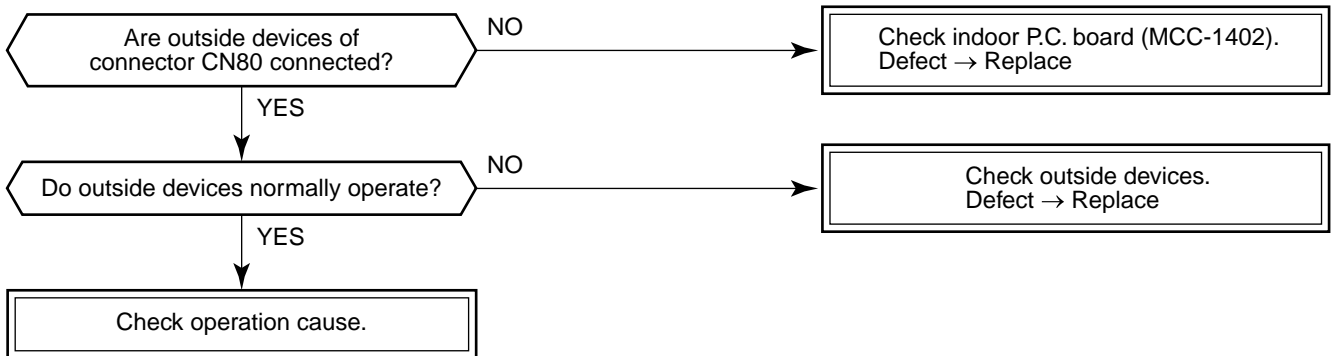

**[b7 error] (Central controller)**

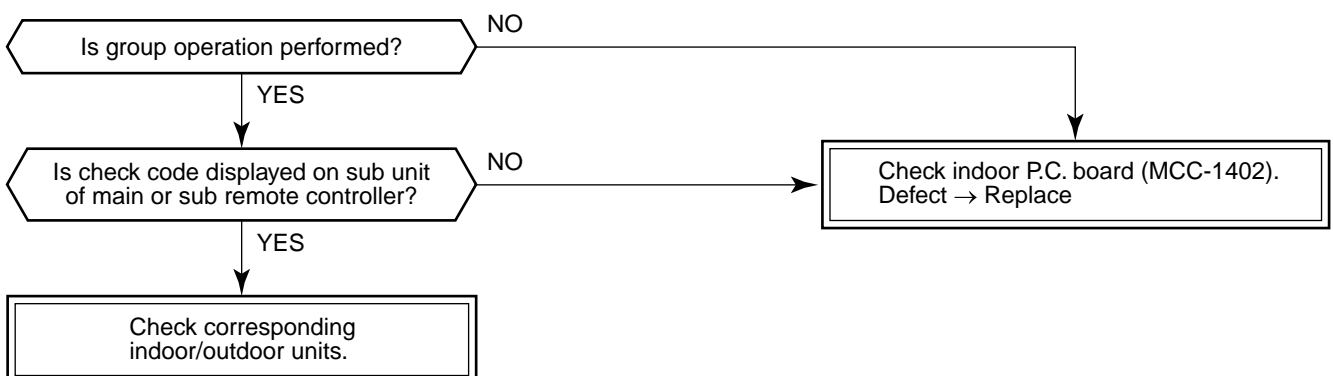

**[P10 error]/[Ob error]**

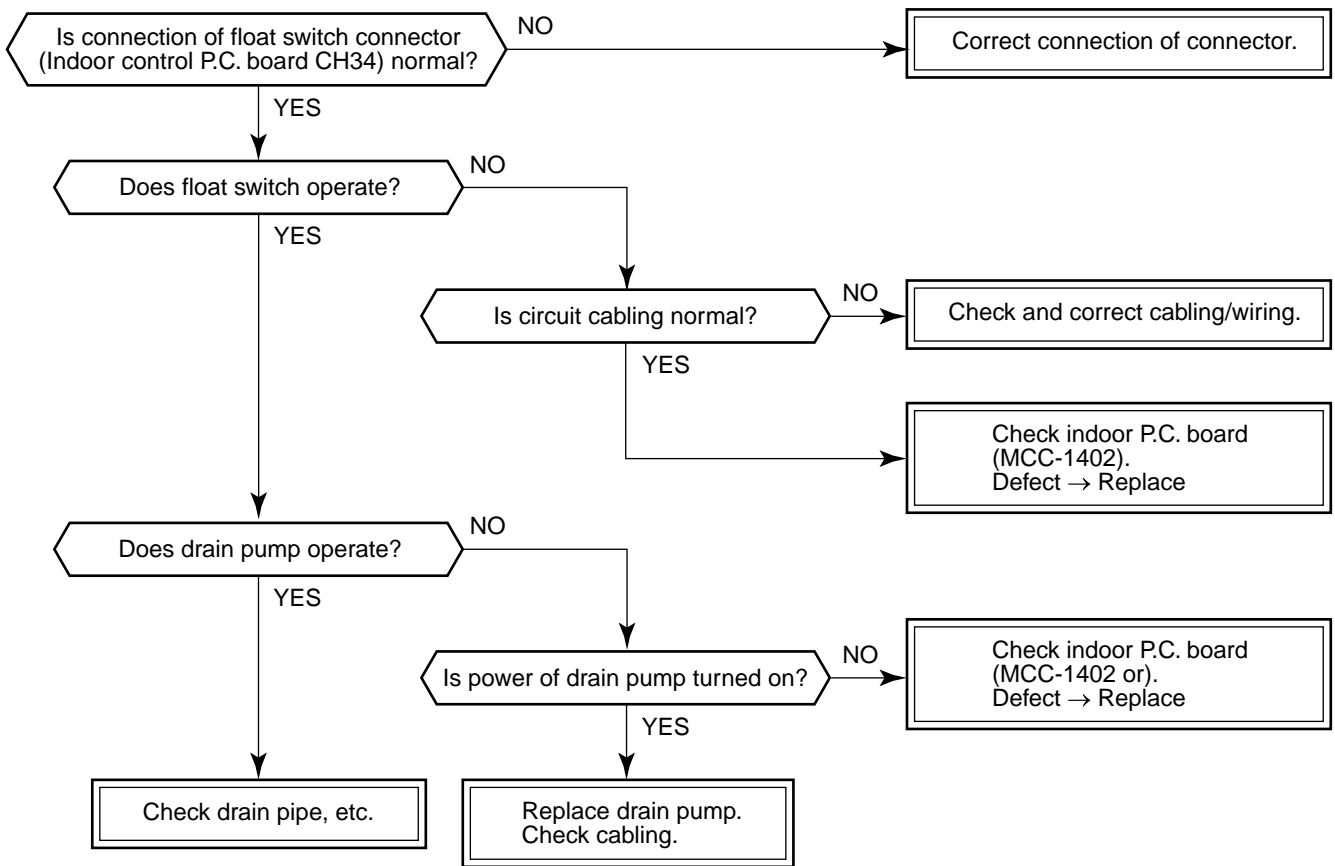

**[F10 error] [0C error]**



[P12 error]/[11 error]

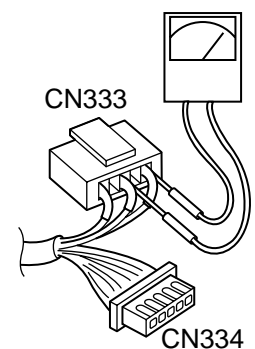
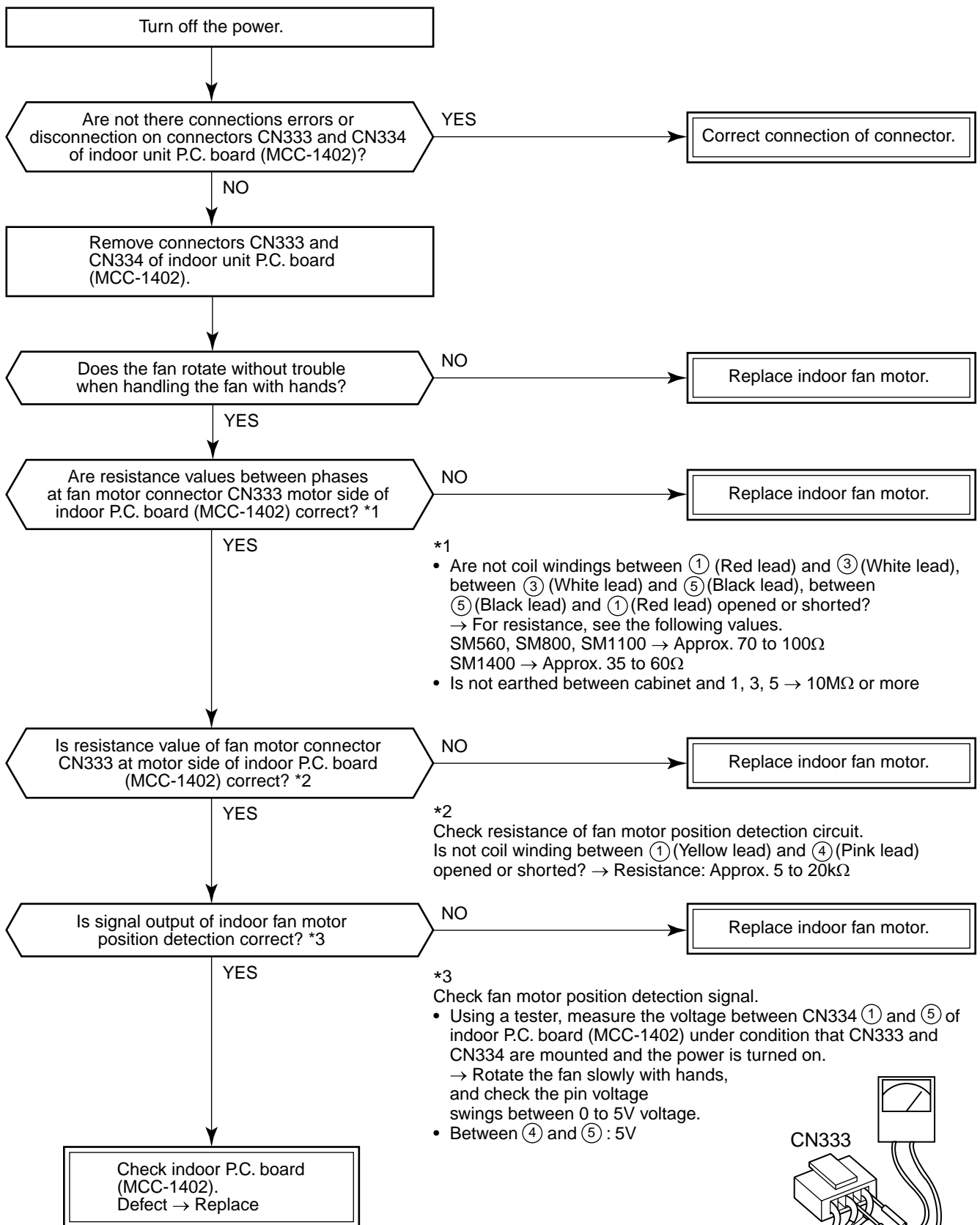

[P22 error]/[1A error]

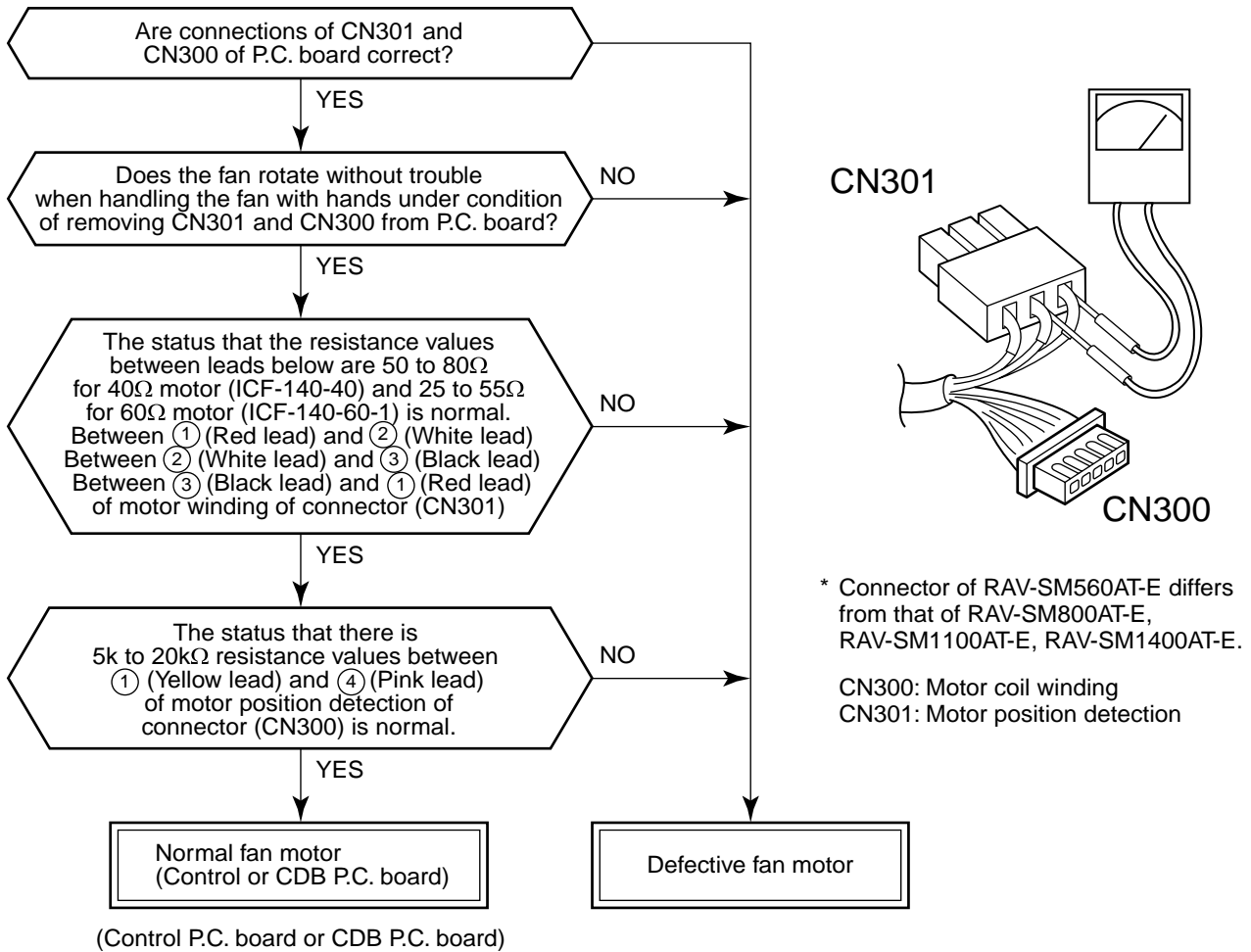

**NOTE :**

However, GND circuit error inside of the motor is rarely detected even if the above check is carried out. When the circuit does not become normal even if P.C. board has been replaced, replace outdoor fan motor.

	Single phase	Single phase	Single phase
	RAV-SM560AT-E	RAV-SM800AT-E	RAV-SM1100AT-E, SM1400AT-E
Objective P.C. board	Control P.C. board	CDB P.C. board	CDB P.C. board
Fan motor winding	CN300	CN301	CN301
Motor position detection	CN301	CN300	CN300
Fan motor winding	—	—	CN303
Motor position detection	—	—	CN302

**[P19 error]/[08 error]**

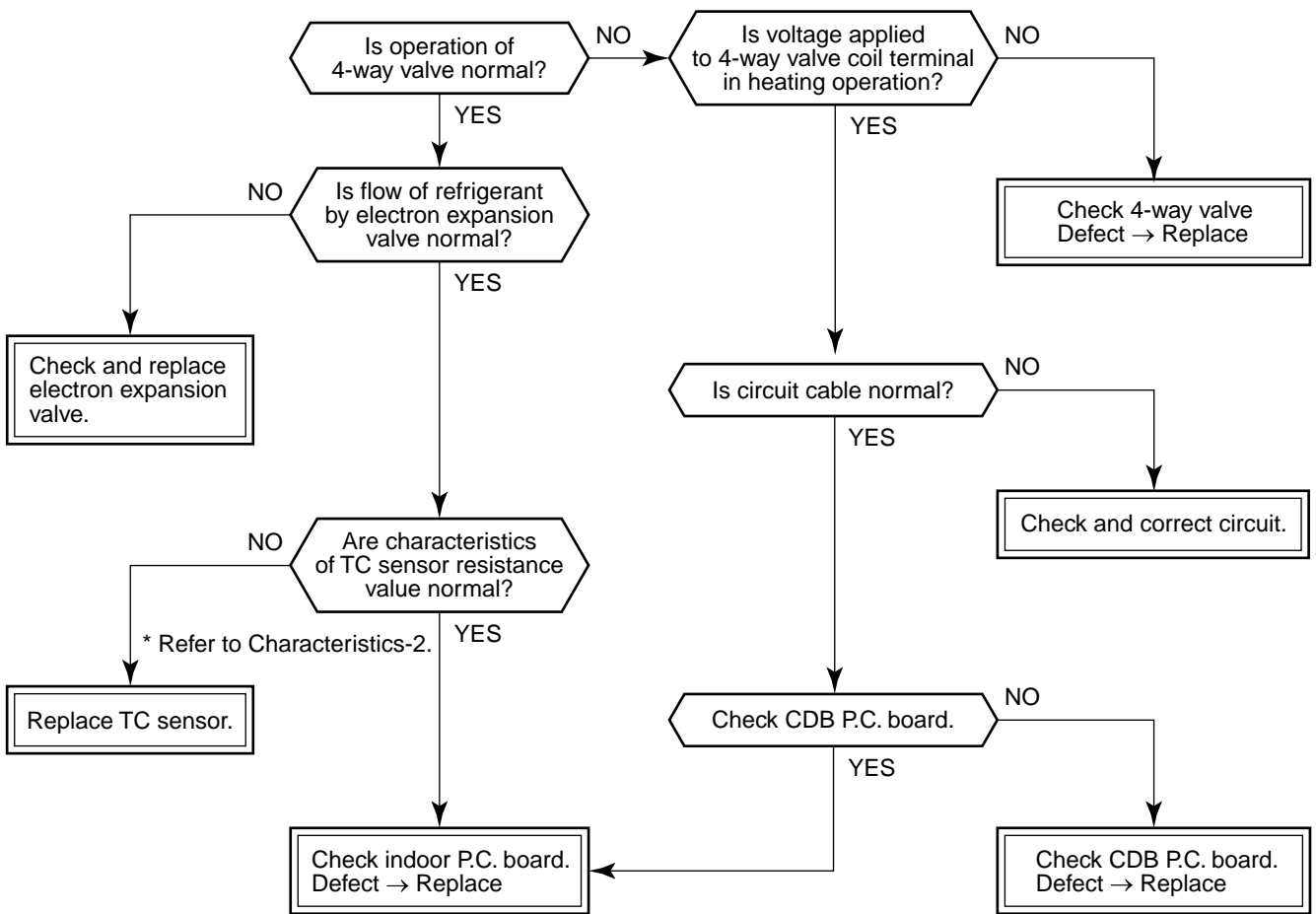

\* For RAV-SM560AT-E, check control P.C. board.

- In cooling operation, if high pressure is abnormally raised, [P19 error]/[08 error] may be displayed. In this case, remove cause of pressure up and then check again referring to the item [P04 error]/[21 error].

**[F02 error]/[0d error]**

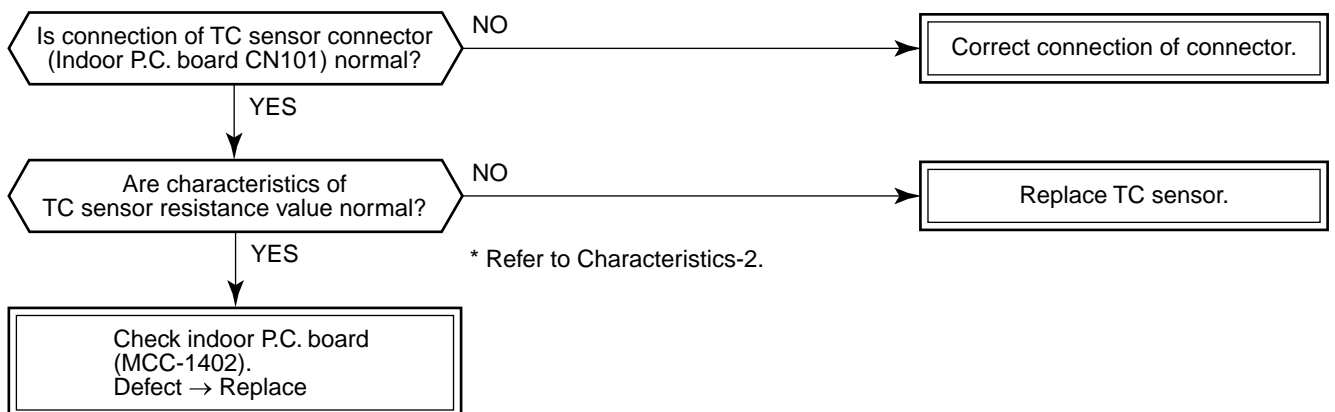

\* Refer to Characteristics-2.

**[F01 error]/[0F error]**

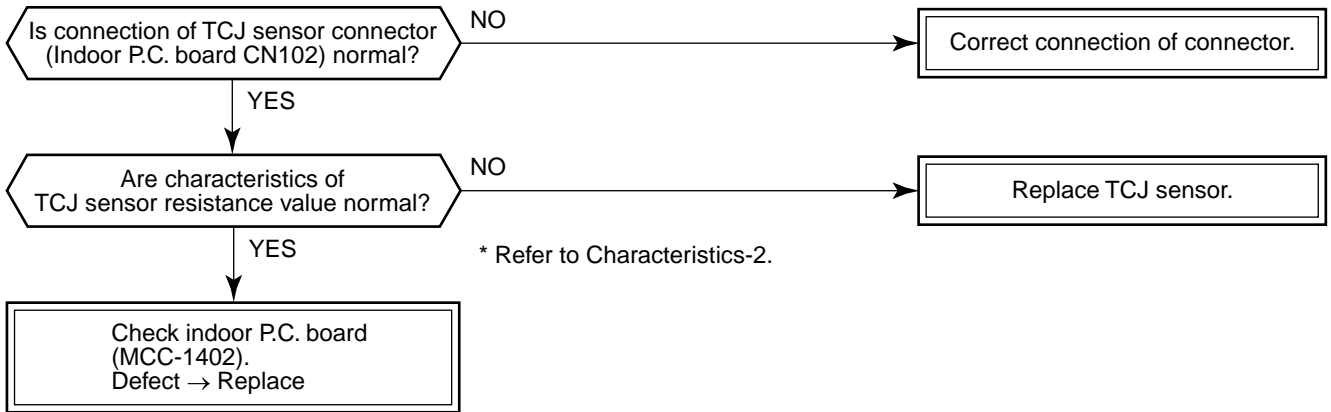

**[P26 error]/[14 error]**

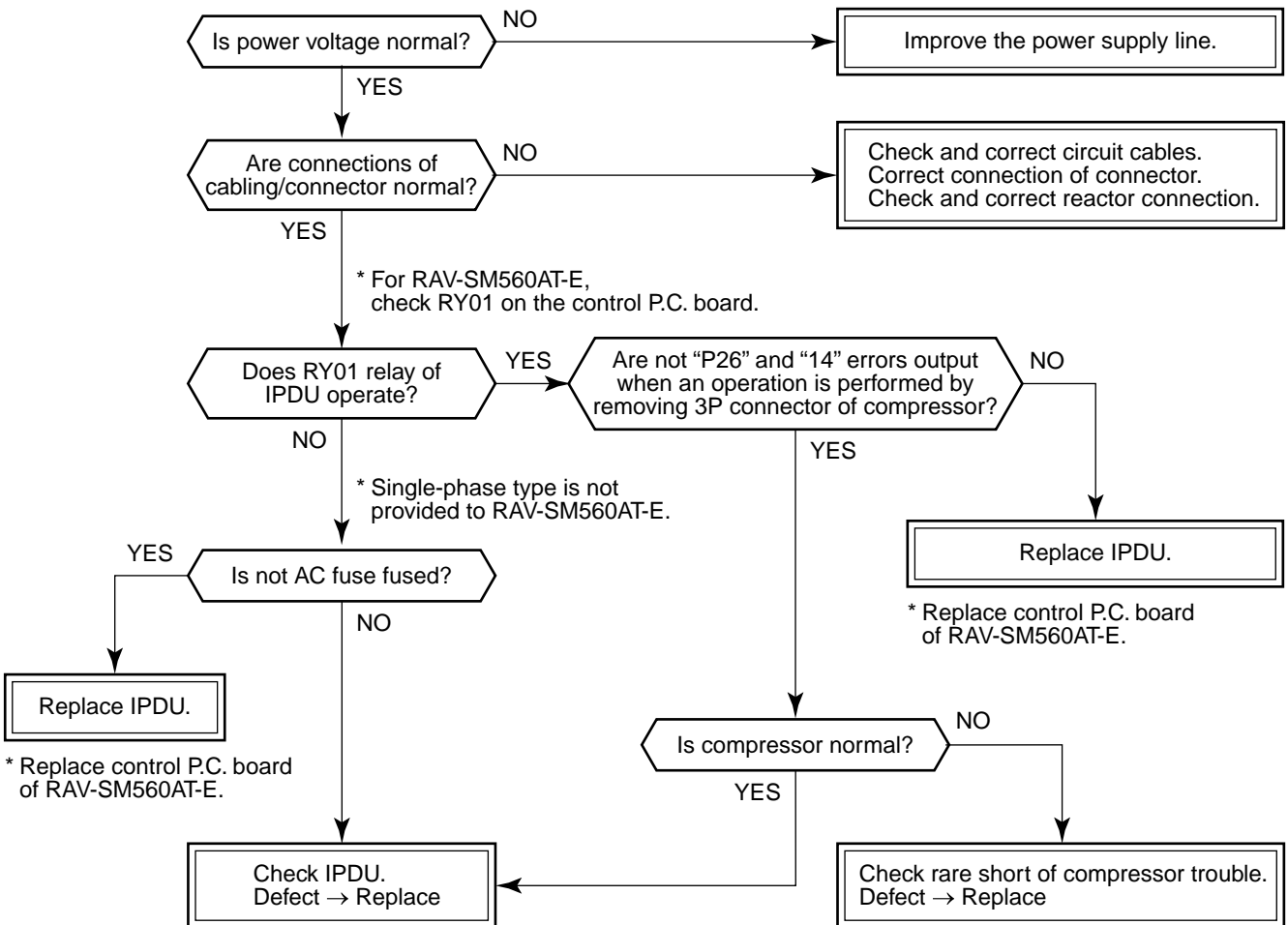

**[P29 error]/[16 error]**

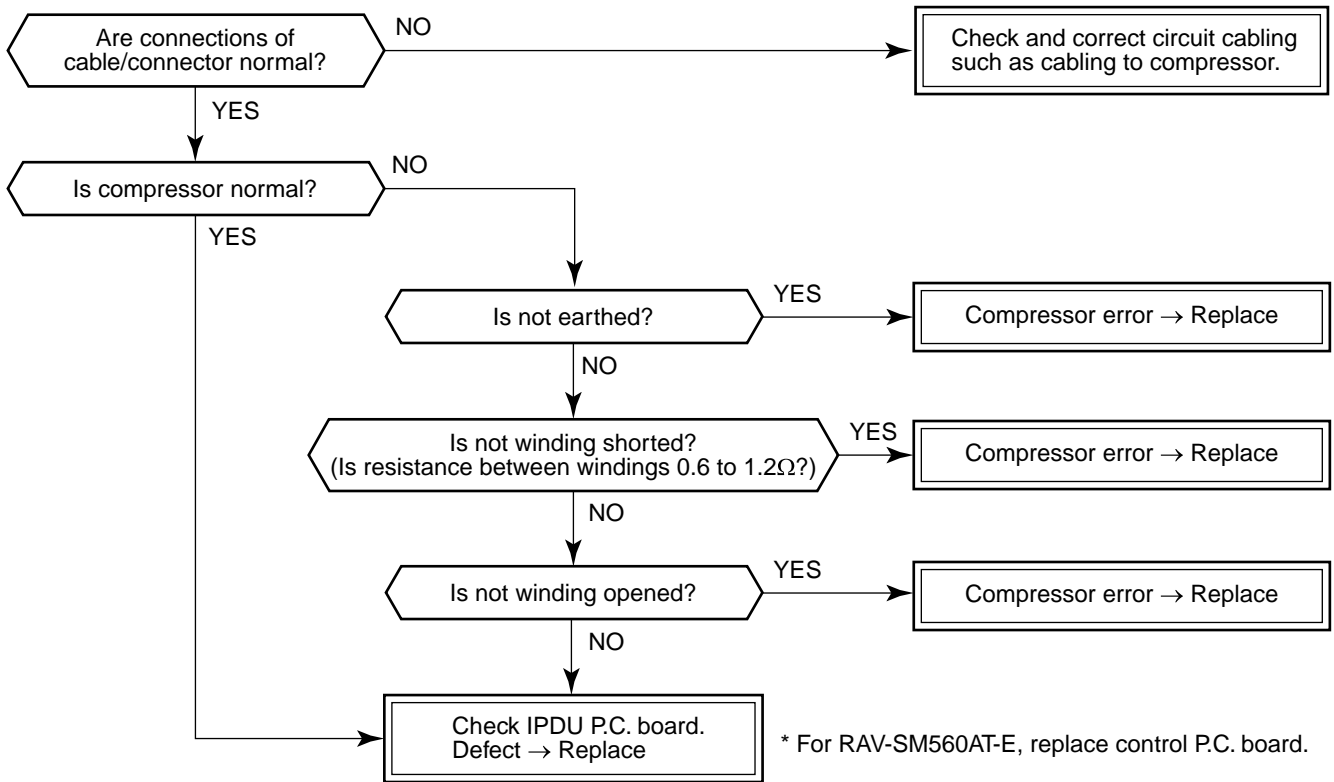

**[H03 error]/[17 error]**

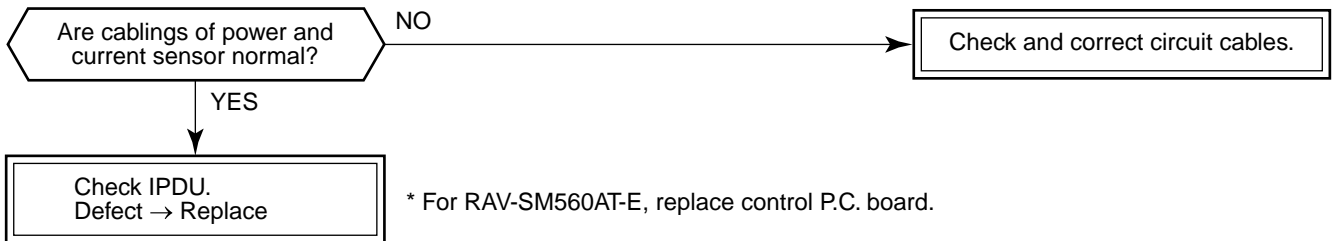



**[F06 error]/[18 error]**

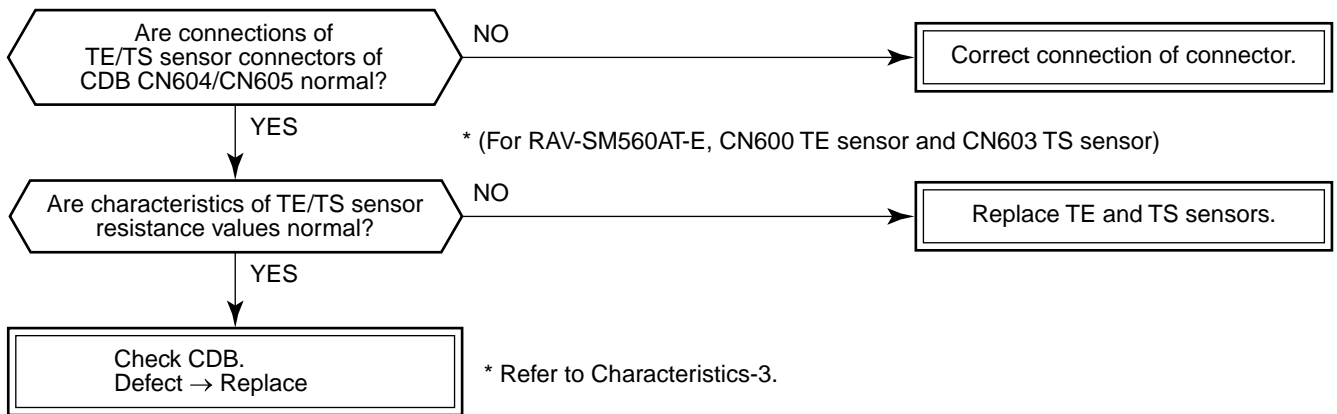

**[F04 error]/[19 error]**

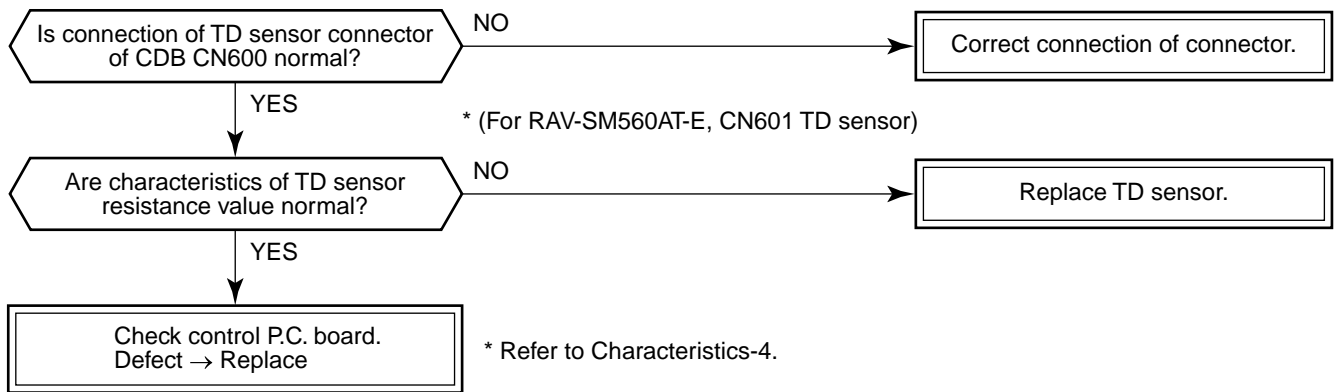

**[F08 error]/[1b error]**

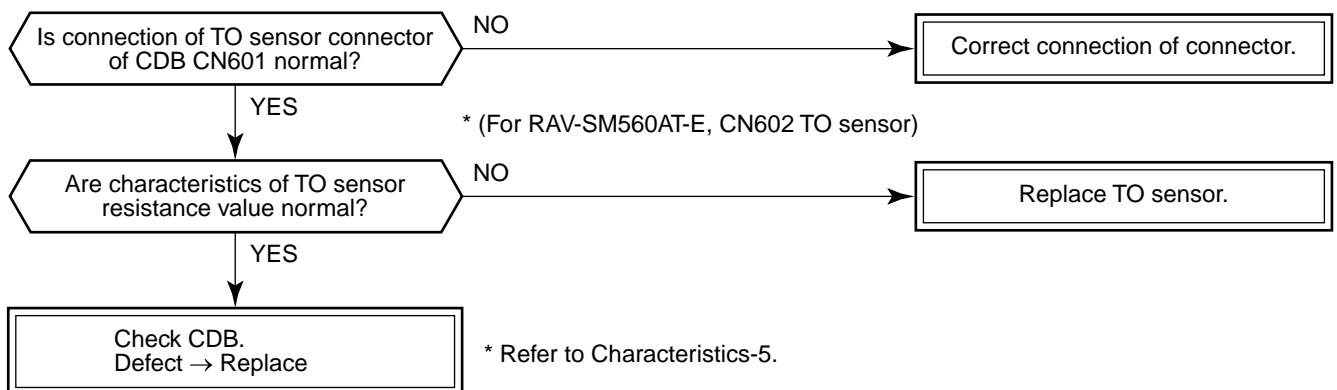

**[L29 error]/[1C error]**

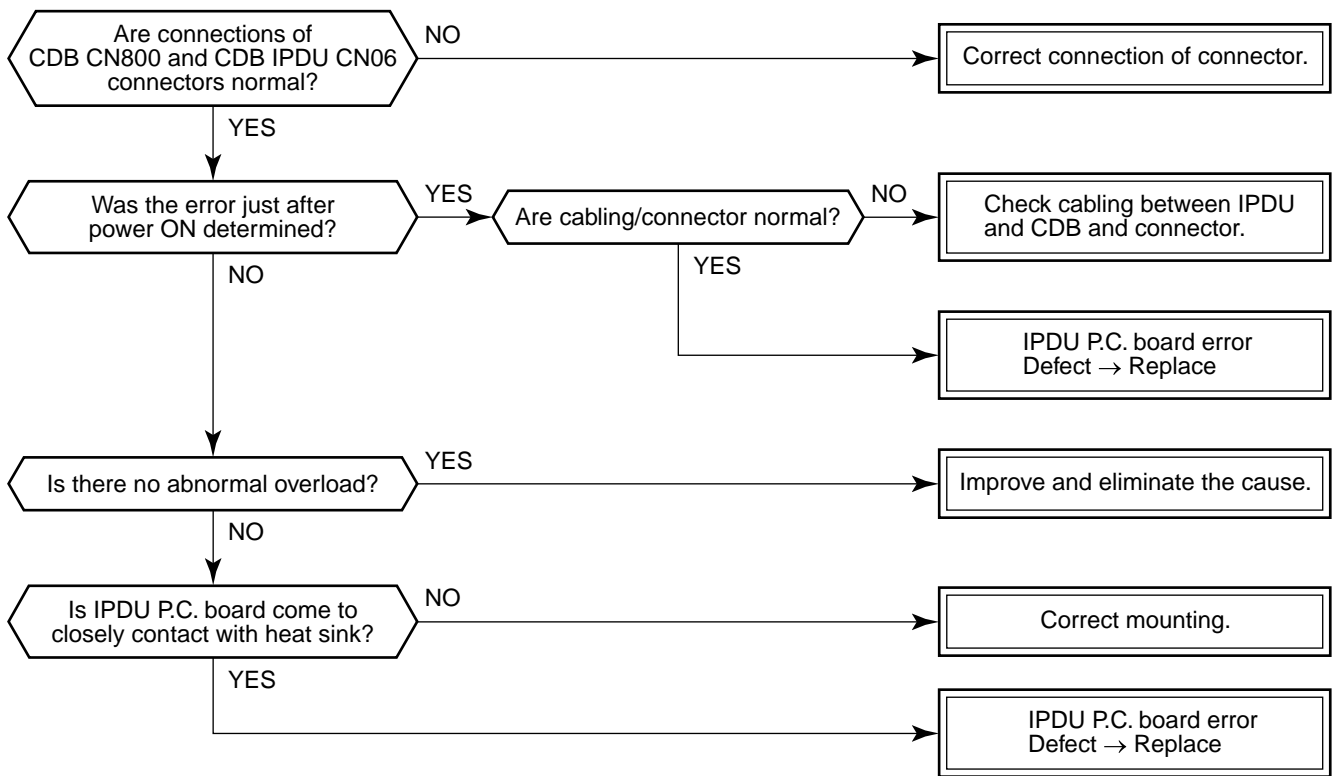

**[H02 error]/[1d error]**

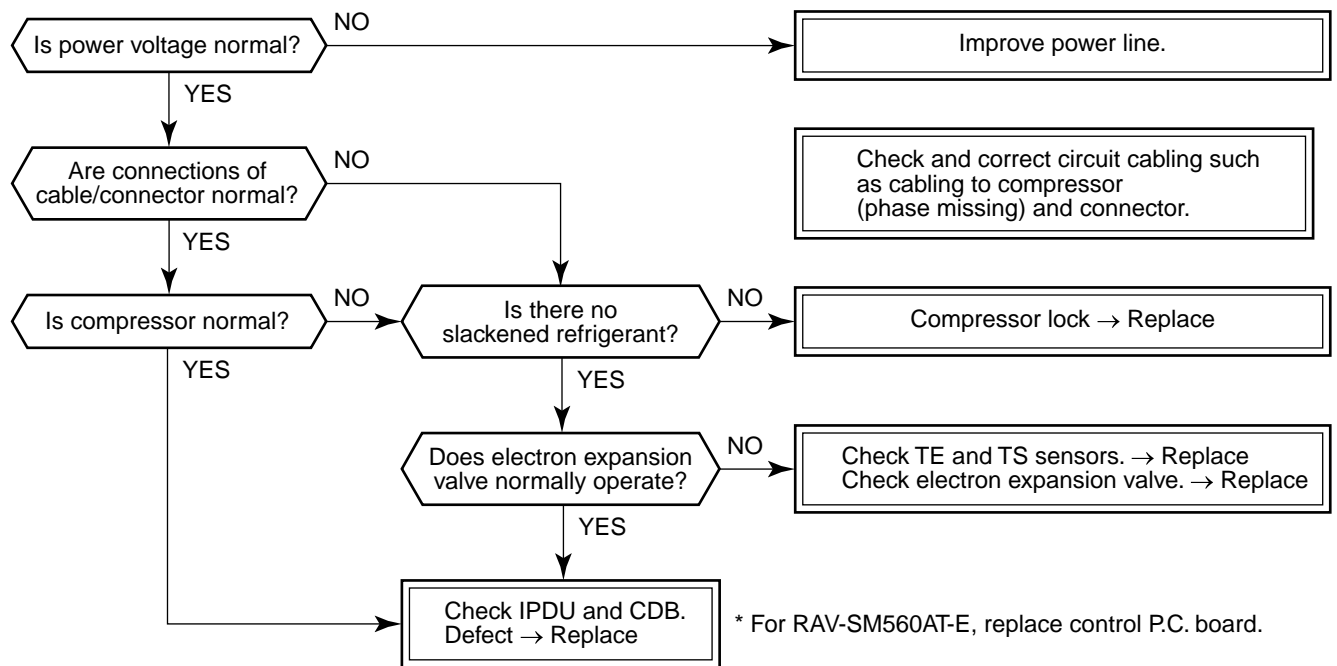

**[P03 error]/[1E error]**

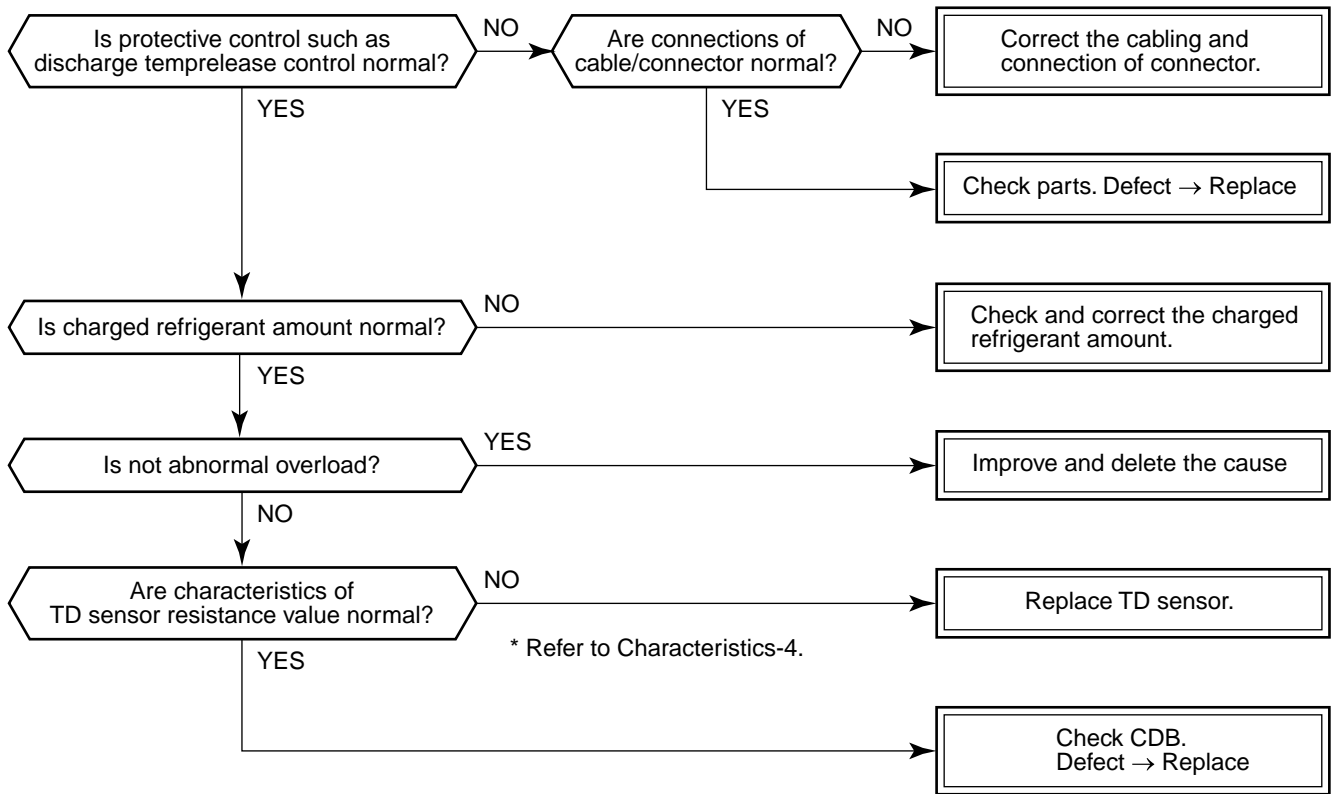

\* For RAV-SM560AT-E, replace control P.C. board.

**[H01 error]/[1F error]**

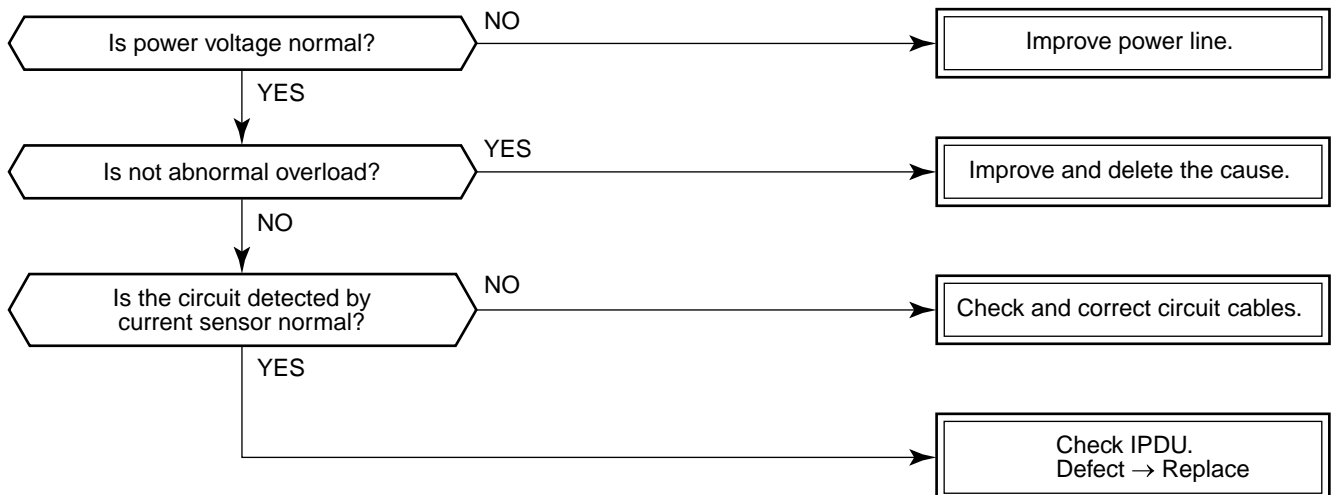

\* For RAV-SM560AT-E, replace control P.C. board.

[P04 error]/[21 error]

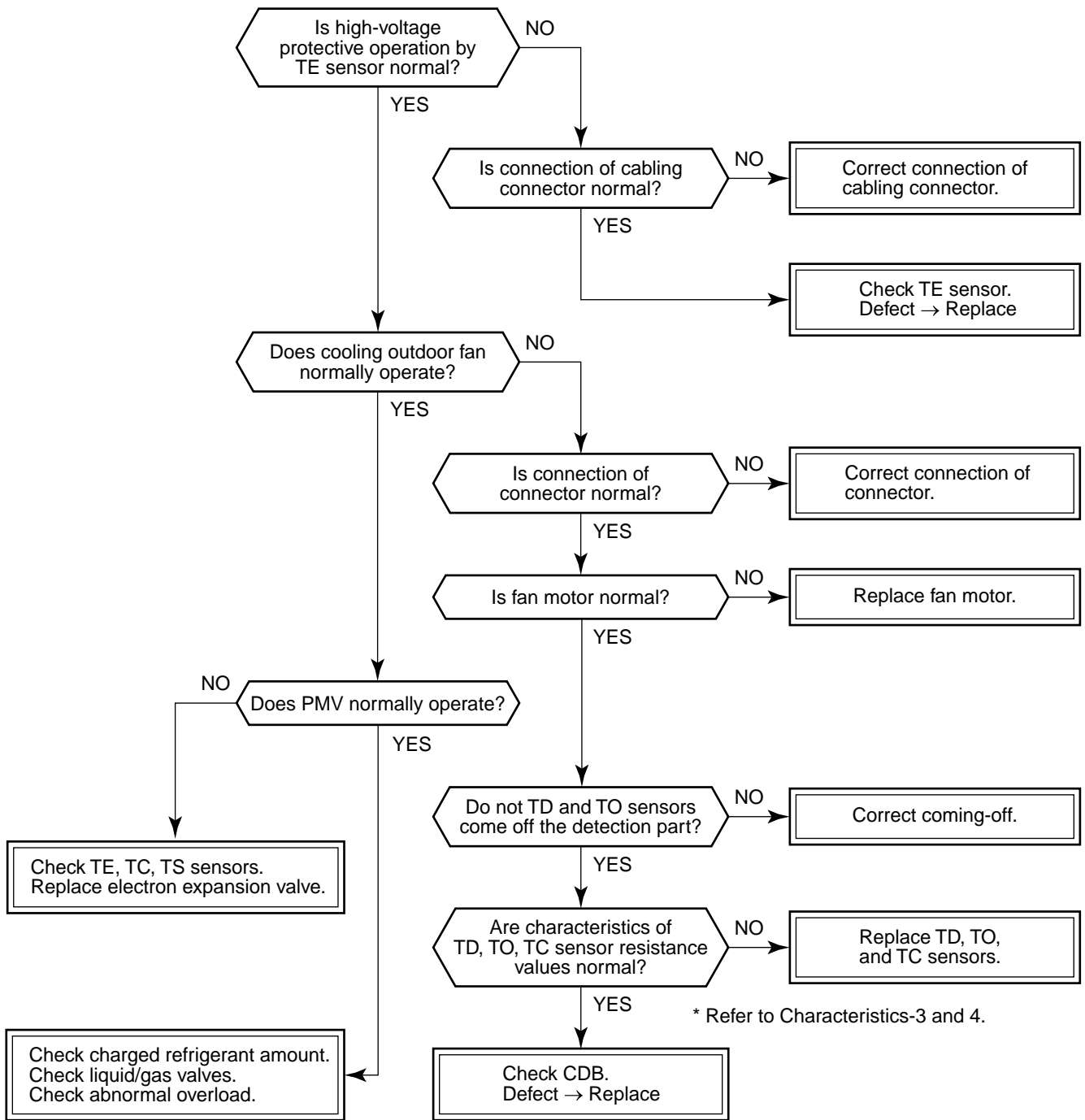

\* Refer to Characteristics-3 and 4.

\* For RAV-SM560AT-E, replace control P.C. board.

**[97 error] (Central controller)**

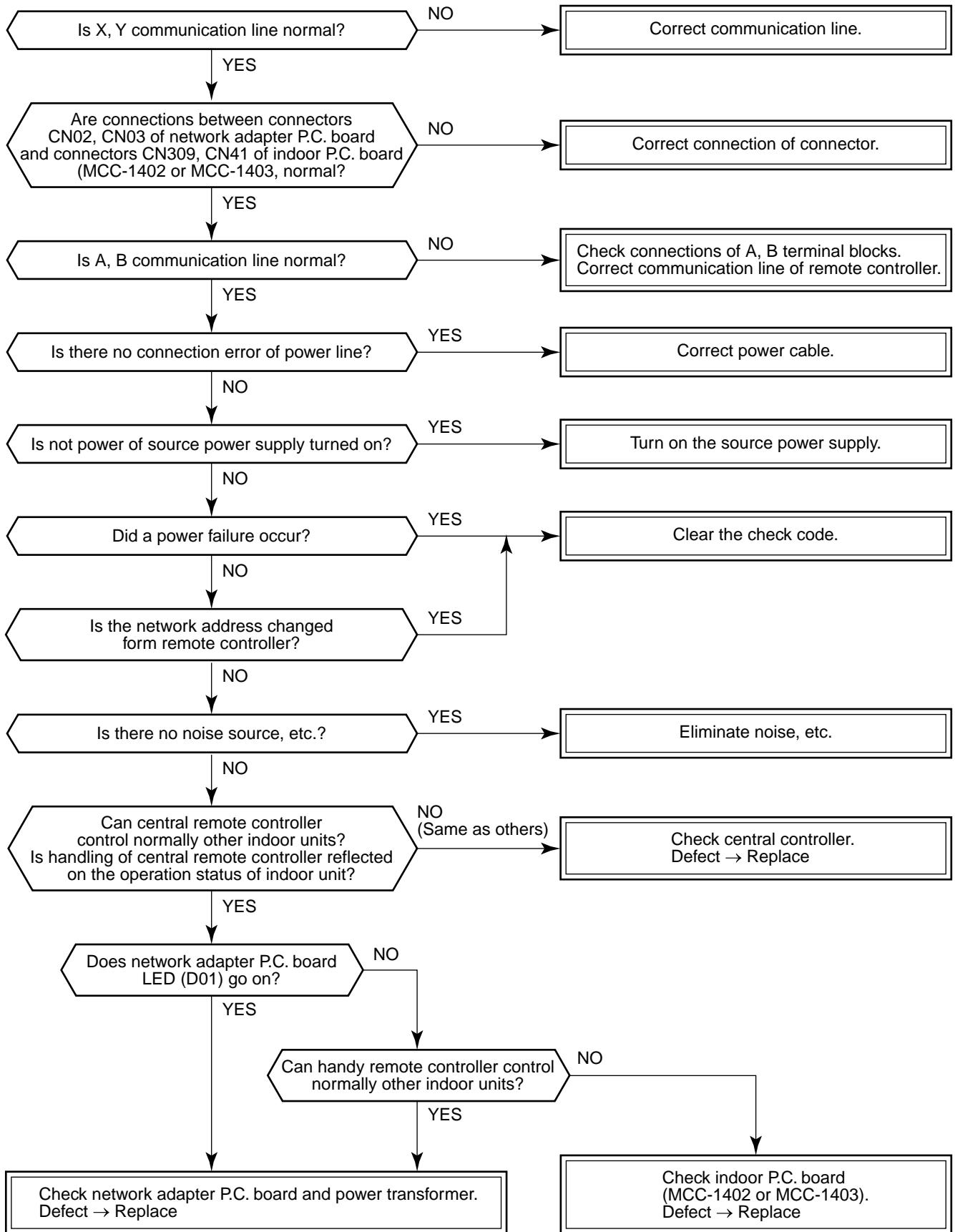

### [E03 error] (Master indoor unit)

[E03 error] is detected when the indoor unit cannot receive a signal sent from the main remote controller (and central controller).

In this case, check the communication cables of the remote controllers A and B, the central control system X and Y. As communication is disabled, [E03] is not displayed on the main remote controller and the central controller. [E01] is displayed on the main remote controller and [97 error] on the central controller, respectively. If [E03] occurs during an operation, the air conditioner stops.

### [F29 error] / [12 error]

[F29 error] or [12 error] indicates detection of trouble which occurred on IC10 non-volatile memory (EEPROM) on the indoor unit P.C. board during operation of the air conditioner. Replace the service P.C. board.

\* If EEPROM has not been inserted when the power was turned on or if EEPROM data never be read/written, the automatic address mode is repeated. In this time, the central controller displays [97 error].

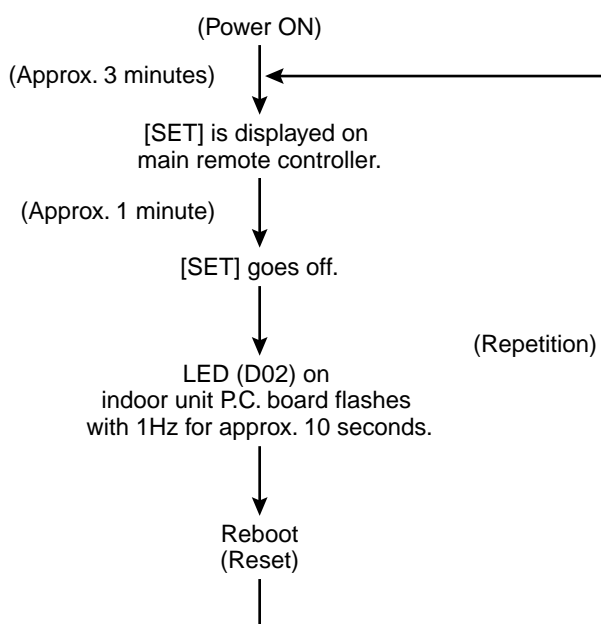

### [P31 error] (Sub indoor unit)

When the master unit of a group operation has detected [E03], [L03], [L07], or [L08] error, the sub unit of the group operation detects [P31 error] and then it stops. There is no display of the check code or alarm history of the main remote controller.

(In this model, the mode enters in automatic address set mode when the master unit has detected [E03], [L03], [L07], or [L08] error.)

**10-4-2. Relational Graph of Temperature Sensor Resistance Value and Temperature**

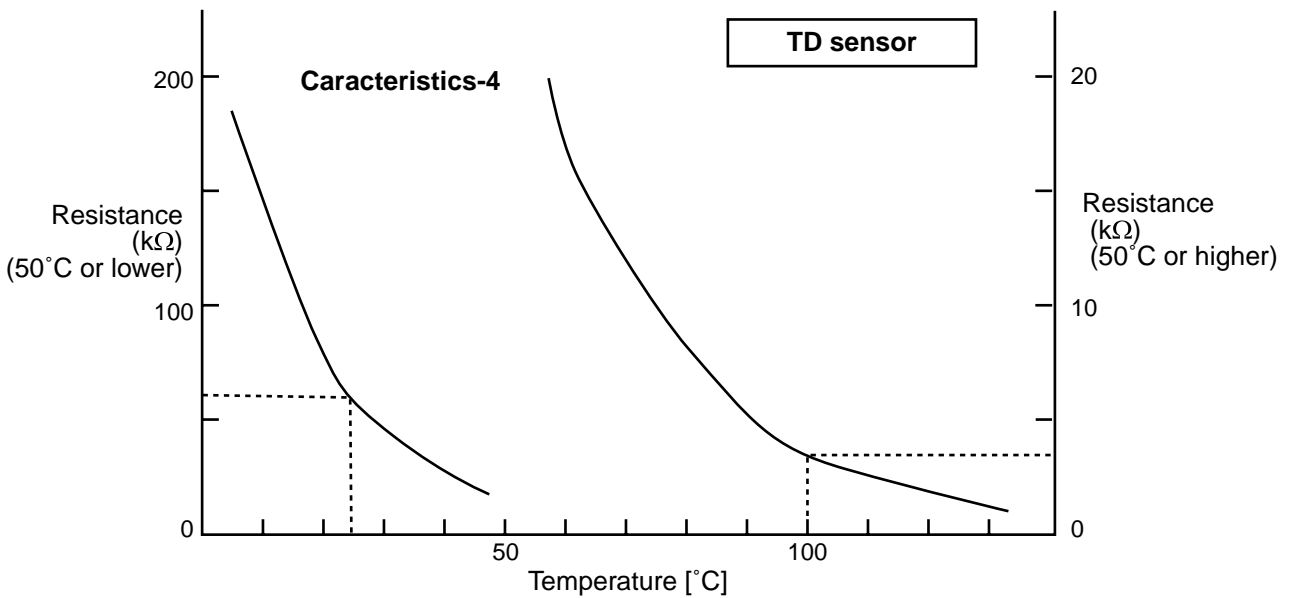
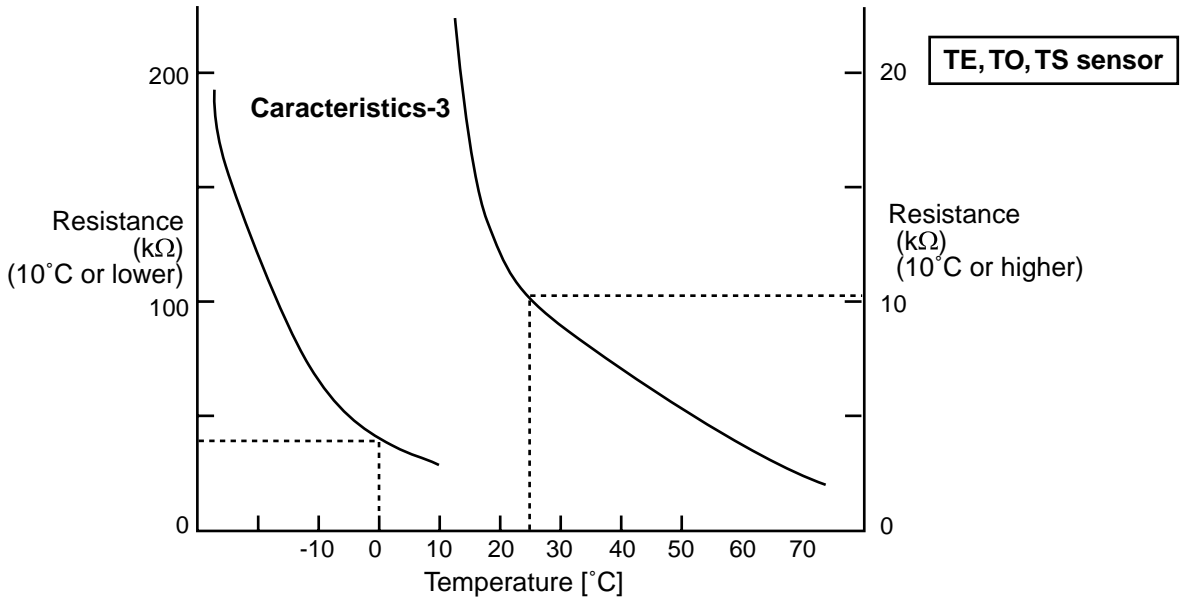
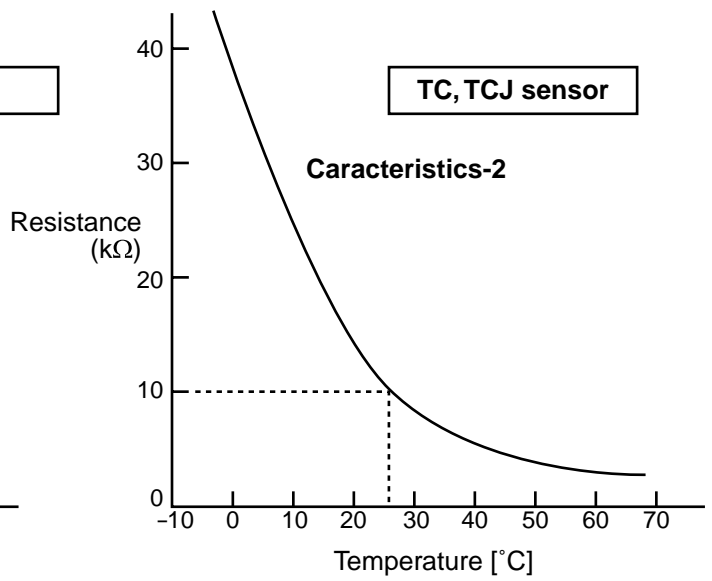
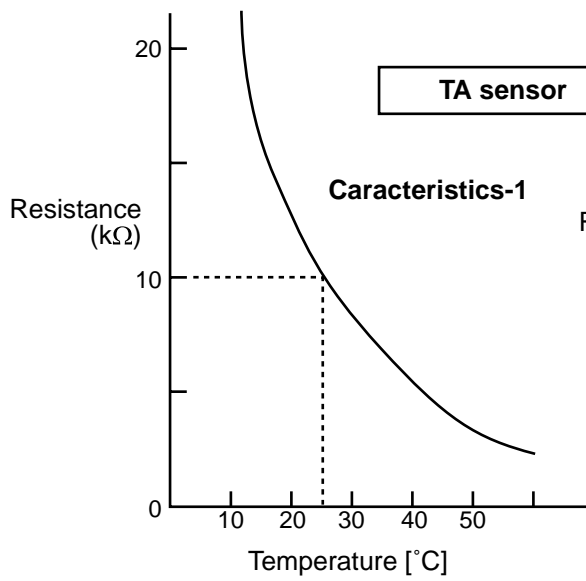

## 11. REPLACEMENT OF SERVICE INDOOR P.C. BOARD

### [Requirement when replacing the service indoor P.C. board assembly]

In the non-volatile memory (Hereinafter said EEPROM, IC10) installed on the indoor P.C. board before replacement, the type and capacity code exclusive to the corresponding model have been stored at shipment from the factory and the important setup data such as system/indoor/group address set in (AUTO/MANUAL) mode or setting of high ceiling selection have been stored at installation time. Replace the service indoor P.C. board assembly according to the following procedure.

After replacement, check the indoor unit address and also the cycle by a test run.

### <REPLACEMENT PROCEDURE>

#### **CASE 1**

**Before replacement, power of the indoor unit can be turned on and the setup data can be readout from the wired remote controller.**

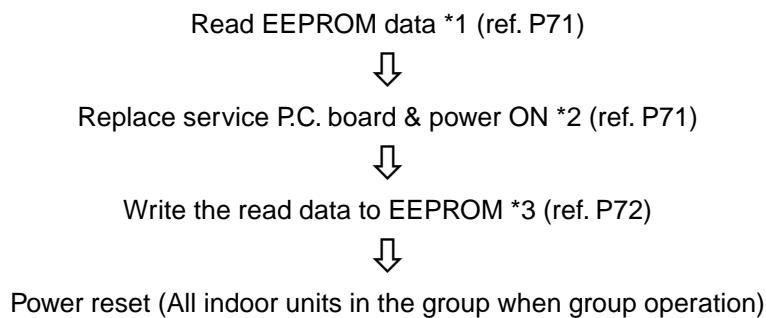

#### **CASE 2**

**Before replacement the setup data can not be readout from the wired remote controller.**

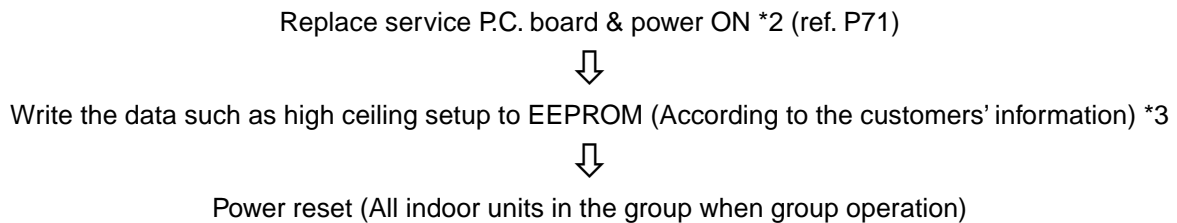



## □1 Readout of the setup data from EEPROM

(Data in EEPROM contents, which have been changed at the local site, are read out together with data in EEPROM set at shipment from the factory.)

1. Push **SET**, **CL**, and **ON** buttons of the remote controller at the same time for 4 seconds or more. **1**  
(Corresponded with No. in Remote controller)  
When group operation, the master indoor unit address is displayed at the first time. In this time, the item code (DN) **10** is displayed. The fan of the selected indoor unit operates and the flap starts swinging if any.
2. Every pushing **UNIT** button, the indoor unit address in the group are displayed successively. **2** Specify the indoor unit No. to be replaced.
3. Using the set temperature **▲** / **▼** buttons, the item code (DN) can be moved up and down one by one. **3**
4. First change the item code (DN) from **10** to **01**. (Setting of filter sign lighting time) Make a note of the set data displayed in this time.
5. Next change the item code (DN) using the set temperature **▲** / **▼** buttons. Also make a note of the set data.
6. Repeat item 5. and make a note of the important set data as shown in the later table (Ex.).  
• **01** to **9F** are provided in the item code (DN). On the way of operation, DN No. may come out.
7. After finishing making a note, push **ON** button to return the status to usual stop status. **6**  
(Approx. 1 minute is required to start handling of the remote controller.)

### Minimum requirements for item code

DN	Contents
10	Type
11	Indoor unit capacity
12	Line address
13	Indoor address
14	Group address

- (1) Type and capacity of the indoor unit is necessary to set the revolutions frequency of the fan.
- (2) If Line/Indoor/Group addresses differ from those before replacement, the mode enters in automatic address setup mode and a manual resetting may be required.

## □2 Replacement of service P.C. board

1. Replace the P.C. board with a service P.C. board.  
In this time, setting of jumper line (cut) or setting of (short-circuit) connecting connectors on the former P.C. board should be reflected on the service P.C. board.
  2. According to the system configuration, turn on power of the indoor unit with any method in the following items.
    - a) In case of single (individual) operation  
Turn on the power supply.
      - 1) Wait for completion of automatic address setup mode (Required time: Approx. 5 minutes) and then proceed to **□3**.  
(Line address = 1, Indoor address = 1, Group address = 0 (Individual) are automatically set.)
      - 2) Push **SET**, **CL**, and **ON** buttons of the remote controller at the same time for 4 seconds or more (**1** operation), interrupt the automatic address setup mode, and then proceed to **□3**.  
(Unit No. **ALL** is displayed.)
    - b) In case of group operation  
Turn on power of the indoor unit of which P.C. board has been replaced with the service P.C. board with any method in the following items.
      - 1) Turn on power of the replaced indoor unit only.  
(However, the remote controller is also connected. Otherwise **□3** operation cannot be performed.)  
Same as 1) and 2) in item a).
      - 2) Turn on power of the multiple indoor units including replaced indoor unit.
        - Only 1 system for twin, triple, double twin
        - For all units in the group
 Wait for completion of automatic address setup mode (Required time: Approx. 5 minutes) and then proceed to **□3**.
- \* The master unit of a group may change by setup of automatic address. The line address/indoor address of the replaced indoor unit are automatically set to the vacant addresses except addresses belonging to other indoor units which have not been replaced. It is recommended to make a note that the refrigerant line which includes the corresponding indoor unit and that the corresponding indoor unit is master or sub in the group control.

### □3 Writing of the setup contents to EEPROM

(The contents of EEPROM installed on the service P.C. board have been set up at shipment from the factory.)

1. Push **SET**, **CL**, and **UNIT** buttons of the remote controller at the same time for 4 seconds or more. **1**  
(Corresponded with No. in Remote controller )  
In group operation control, the master indoor unit No. is displayed at the first time. (If the automatic address setup mode is interrupted in item 2. - a) - 2) in the previous page, the unit No. *ALL* is displayed.) In this time, the item code (DN) *01* is displayed. The fan of the selected indoor unit operates and the flap starts swinging if any.
2. Every pushing **UNIT** button, the indoor unit numbers in the group control are displayed successively. **2**  
Specify the indoor unit No. of which P.C. board has been replaced with a service P.C. board.  
(When the unit No. *ALL* is displayed, this operation cannot be performed.)
3. Using the set temperature **▲** / **▼** buttons, the item code (DN) can be moved up and down one by one. **3**
4. First set a type and capacity of the indoor unit.  
(Setting the type and capacity writes the data at shipment from the factory in EEPROM.)
  - 1) Set the item code (DN) to *01*. (As it is)
  - 2) Using the timer time **▲** / **▼** buttons, set up a type. **4**  
(For example, 4-way air discharge cassette type is 0001) Refer to the attached table.
  - 3) Push **SET** button. (OK when the display goes on.) **5**
  - 4) Using the set temperature **▲** / **▼** buttons, set *11* to the item code (DN).
  - 5) Using the timer time **▲** / **▼** buttons, set the capacity.  
(For example, 0012 for class 80) Refer to the attached table.
  - 6) Push **SET** button. (OK when the display goes on.)
  - 7) Push **ON/OFF** button to return the status to usual stop status. **6**  
(Approx. 1 minute is required to start handling of the remote controller.)
5. Next write the contents which have been set up at the local site such as the address setup in EEPROM.  
Repeat the above procedure 1. and 2.
6. Using the set temperature **▲** / **▼** buttons, set *01* to the item code (DN).  
(Setup of lighting time of filter sign)
7. The contents of the displayed setup data in this time should be agreed with the contents in the previous memorandum in □1.
  - 1) If data disagree, change the displayed setup data to that in the previous memorandum by the timer time **▲** / **▼** buttons, and then push **SET** button. (OK when the display goes on.)
  - 2) There is nothing to do when data agrees.
8. Using the set temperature **▲** / **▼** buttons, change the item code (DN).  
As same as the above, check the contents of the setup data and then change them to data contents in the previous memorandum.
9. Then repeat the procedure 7. and 8.
10. After completion of setup, push **ON/OFF** button to return the status to the usual stop status. **6**  
(Approx. 1 minute is required to start handling of the remote controller.)

\* *01* to *9F* are provided in the item code (DN).  
On the way of operation, DN No. may come out.  
When data has been changed by mistake and **SET** button has been pushed, the data can be returned to the data before change by pushing **CL** button if the item code (DN) was not yet changed.

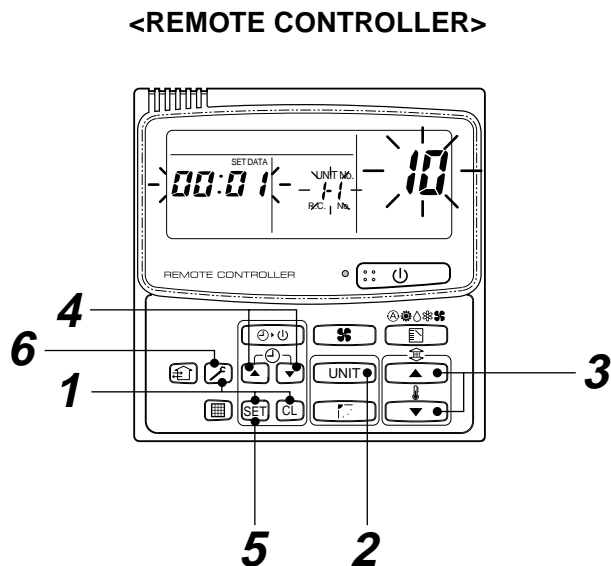

### Memorandum for setup contents (Item code table (Example))

DN	Item	Memo	At shipment
01	Filter sign lighting time		According to type
02	Dirty state of filter		0000: Standard
03	Central control address		0099: Unfixed
06	Heating suction temp shift		0002: +2°C (Floor type: 0)
0F	Cooling only		0000: Shared for cooling/heating
10	Type		According to model type
11	Indoor unit capacity		According to capacity type
12	Line address		0099: Unfixed
13	Indoor unit address		0099: Unfixed
14	Group address		0099: Unfixed
19	Flap type (Adjustment of air direction)		According to type
1E	Temp difference of automatic cooling/ heating selecting control points		0003: 3 deg (Ts ± 1.5)
28	Automatic reset of power failure		0000: None
2A	Option		0002:
2b	Thermo output selection		0000: Thermo ON
2E	Option		0000:
32	Sensor selection		0000: Body sensor
5d	High ceiling selection		0000: Standard
60	Timer set (Wired remote controller)		0000: Available
8b	Correction of high heat feeling		0000: None

#### Type

##### Item code [10]

Setup data	Type	Abbreviated name
0004	Concealed duct	RAV-SM561/801/1101/1401BT-E

\* Initial setup value of EEPROM installed on the service P.C. board

#### Indoor unit capacity

##### Item code [11]

Setup data	RAV-SM561BT-E RAV-SM801BT-E
0000*	Invalid
0009	560
0012	800

Setup data	RAV-SM1101BT-E RAV-SM1401BT-E
0000*	Invalid
0015	1100
0017	1400



\* Initial setup value of EEPROM installed on the service P.C. board

## 12. SETUP AT LOCAL SITE AND OTHERS

### 12-1. Indoor Unit

#### 12-1-1. Test Run Setup on Remote Controller











##### <Wired remote controller>

- When pushing  button on the remote controller for 4 seconds or more, "TEST" is displayed on LC display. Then push  button.
  - "TEST" is displayed on LC display during operation of Test Run.
  - During Test Run, temperature cannot be adjusted but air volume can be selected.
  - In heating and cooling operation, a command to fix the Test Run frequency is output.
  - Detection of error is performed as usual. However, do not use this function except case of Test Run because it applies load on the unit.
- Use either heating or cooling operation mode for [TEST].
 

**NOTE :** The outdoor unit does not operate after power has been turned on or for approx. 3 minutes after operation has stopped.
- After a Test Run has finished, push  button again and check that [TEST] on LC display has gone off. (To prevent a continuous test run operation, 60-minutes timer release function is provided to this remote controller.)

#### 12-1-2. Setup to Select Function

##### <Procedure> Use this function while the indoor unit stops.

- Push , , and  buttons concurrently for 4 seconds or more. The unit No. displayed at the first time indicates the indoor unit address of the master unit in the group control. In this time, fan and flap of the selected indoor unit operate.
- Every pushing  button, the indoor unit numbers in the group control are displayed successively. In this time, fan and flap of the selected indoor unit only operate.
- Using the set temperature  /  buttons, set the item code (DN).
- Using the timer time  /  buttons, select the setup data.
- Push  button. (OK if display goes on.)
  - To change the selected indoor unit, proceed to **2**.
  - To change the item to be set, proceed to **3**.
- Pushing  button returns the status to usual stop status.

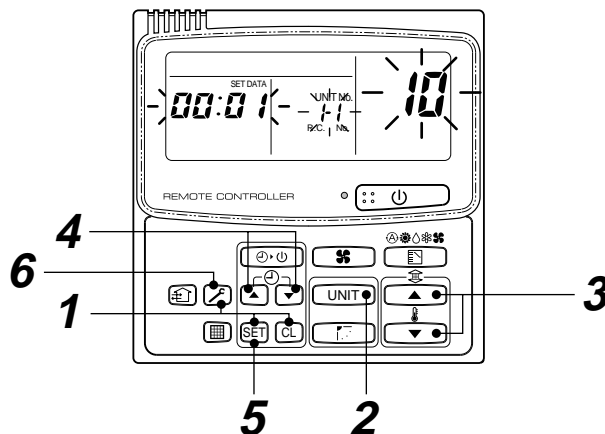

<Operation procedure>

**1 → 2 → 3 → 4 → 5 → 6 END**

**Item No. (DN) table (Selection of function)**

DN	Item	Description	At shipment
01	Filter sign lighting time	0000 : None 0002 : 2500H 0004 : 10000H 0001 : 150H 0003 : 5000H 0005 : Clogged sensor used	According to type
02	Dirty state of filter	0000 : Standard 0001 : High degree of dirt (Half of standard time)	0000 : Standard
03	Central control address	0001 : No.1 unit 0099 : Unfixed to 0064 : No.64 unit	0099 : Unfixed
06	Heating suction temp shift	0000 : No shift 0002 : +2°C to 0001 : +1°C 0010 : -10°C (Up to recommendation + 6)	0002 : +2°C (Floor type 0000: 0°C)
0F	Cooling only	0000 : Heat pump 0001 : Cooling only (No display of [AUTO] [HEAT])	0000 : Shared for cooling/ heating
10	Type	0000 : (Air discharge cassette 1) 0001 : (Air discharge cassette 4) to 0037	According to model type
11	Indoor unit capacity	0000 : Unfixed 0001 to 0034	According to capacity type
12	Line address	0001 : No.1 unit to 0030 : No.30 unit	0099 : Unfixed
13	Indoor unit address	0001 : No.1 unit to 0064 : No.64 unit	0099 : Unfixed
14	Group address	0000 : Individual 0002 : Sub of group 0001 : Master of group	0099 : Unfixed
19	Flap type (Adjustment of air direction)	0000 : No flap 0004 : 4-way 0001 : Swing only	According to type
1E	Temp difference of automatic cooling/heating mode selection COOL → HEAT, HEAT →COOL	0000 : 0 deg (For setup temperature, reversal of COOL/HEAT by ± (Data value)/2) to 0010 : 10 deg	0003 : 3 deg (Ts±1.5)
28	Automatic reset of power failure	0000 : None 0001 : Reset	0000 : None
2A	Option		0002 : Default
2b	Thermo output selection (T10 ③)	0000 : Indoor thermo ON 0001 : Output of outdoor comp-ON receiving	0000: Thermo. ON
2E	Option		0000 : Default
30	Option		0000 : Default
31	Option		0000 : Default
32	Sensor selection	0000 : Body TA sensor 0001 : Remote controller sensor	0000 : Body sensor
40	Option		0003 : Default
5d	High ceiling selection (Air volume selection)	0000 : Standard filter 0001 : Oil guard, Super-long life, Optical regenerative deodorization 0003 : High performance (65%), High performance (90%), High antibacterial performance (65%)	0000 : Standard
60	Timer set (Wired remote controller)	0000 : Available (Operable) 0001 : Unavailable (Operation prohibited)	0000 : Available
8b	Correction of high heat feeling	0000 : None 0001 : Correction	0000 : None

### 12-1-3. Cabling and Setting of Remote Controller Control

#### 2-remote controller control (Controlled by two remote controllers)

One or multiple indoor units are controlled by two remote controllers.  
(Max. 2 remote controllers are connectable.)

- 1 indoor unit is controlled by 2 remote controllers

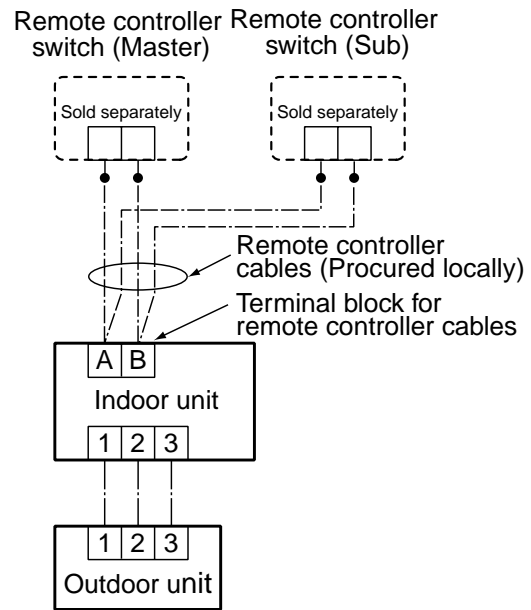

#### (Setup method)

One or multiple indoor units are controlled by two remote controllers.  
(Max. 2 remote controllers are connectable.)

#### <Wired remote controller>

##### How to set wired remote controller to sub remote controller

Insert the remote controller address connector provided on the rear side of the remote controller switch P.C. board into Sub in exchange for Master.

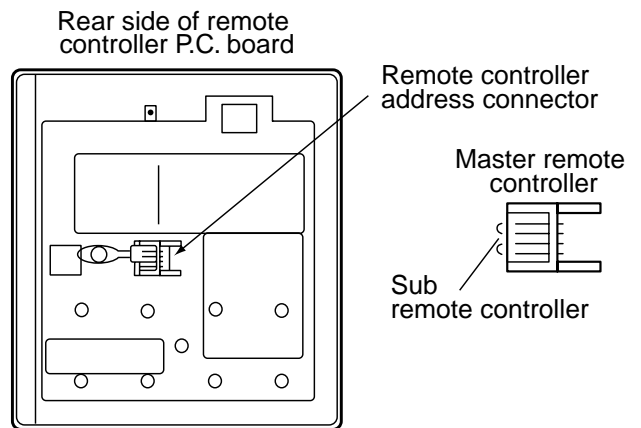

#### [Operation]

1. The operation contents can be changed by Last-push-priority.
2. Use a timer on either Master remote controller or Sub remote controller.

## 12-1-4. Monitor Function of Remote Controller Switch

### ■ Call of sensor temperature display

#### <Contents>

Each sensor temperature of the remote controller, indoor unit, and outdoor unit can become known by calling the service monitor mode from the remote controller.

#### <Procedure>

- 1 Push + buttons simultaneously for 4 seconds or more to call the service monitor mode.

The service monitor goes on, the master indoor unit No. is displayed, and then temperature of the item code is displayed.

- 2 Push the temperature setup / buttons to select the sensor No. (Item code) of the sensor to be monitored.

The sensor numbers are described below:

	Item code	Data name		Item code	Data name
Indoor unit data	00	Room temp (under control) *1	Outdoor unit data	60	Heat exchanger temp TE
	01	Room temp (remote controller)		61	Outside temp TO
	02	Indoor suction temp		62	Discharge temp TD
	03	Indoor coil temp (TCJ)		63	Suction temp TS
	04	Indoor coil temp (TC)		64	—
			65	Heat sink temp THS	

\*1 Only master unit in group control

- 3 The temperature of indoor units and outdoor unit in a group control can be monitored by pushing button to select the indoor unit to be monitored.
- 4 Pushing button returns the display to usual display.

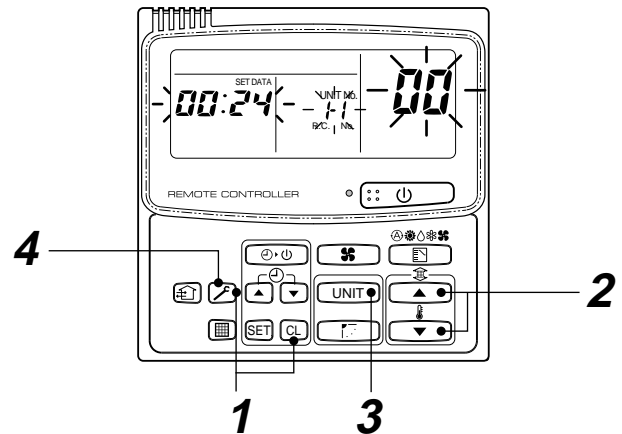

<Operation procedure>

1 → 2 → 3 → 4

Returned to usual display

## ■ Calling of error history

### <Contents>

The error contents in the past can be called.

### <Procedure>

- 1 Push + buttons simultaneously for 4 seconds or more to call the service check mode.

Service Check goes on, the item code **01** is displayed, and then the content of the latest alarm is displayed. The number and error contents of the indoor unit in which an error occurred are displayed.

- 2 In order to monitor another error history, push the set temperature / buttons to change the error history No. (Item code).

Item code **01** (Latest) → Item code **04** (Old)

NOTE : Four error histories are stored in memory.

- 3 Pushing button returns the display to usual display.

### <Requirement>

Do not push button, otherwise all the error histories of the indoor unit are deleted.

## (Group control operation)

In a group control, operation of maximum 8 indoor units can be controlled by a remote controller.

The indoor unit connected with outdoor unit (Individual/Master of twin) controls room temperature according to setting on the remote controller.

### <System example>

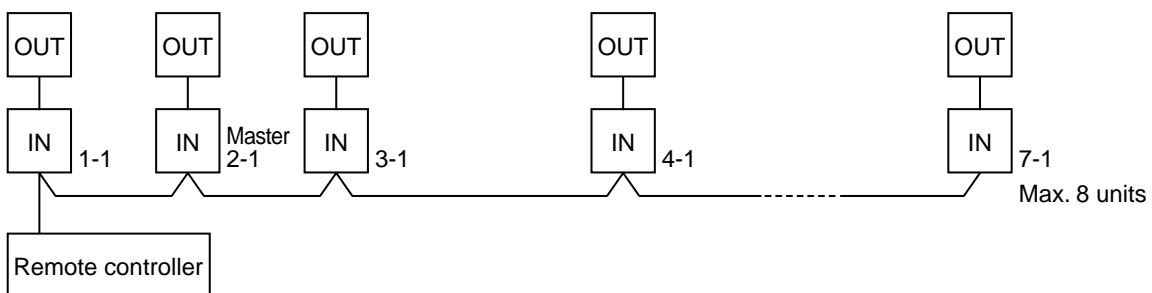

- (1) Display range on remote controller

The setup range (Operation mode/Air volume select/Setup temp) of the indoor unit which was set to the master unit is reflected on the remote controller.

- (2) Address setup

Turn on power of the indoor unit to be controlled in a group within 3 minutes after setting of automatic address.

If power of the indoor unit is not turned on within 3 minutes (completion of automatic address setting), the system is rebooted and the automatic address setting will be judged again.

- 1) Connect 3 In/Out cables surely.
- 2) Check line address/indoor address/group address of the unit one by one.
- 3) The unit No. (line/indoor gout address) which have been set once keep the present status as a rule if the unit No. is not duplicated with one of another unit.

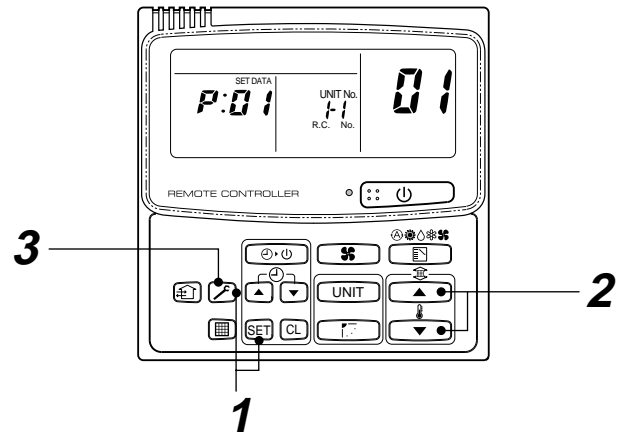

<Operation procedure>

**1 → 2 → 3**

Returned to usual display



## 12-2. Network Adapter

Model name: TCB-PCNT20E

### 12-2-1. Function

A network adapter is an optional P.C. board to connect the indoor unit to AI net (Central control remote controller).

### 12-2-2. Microcomputer Block Diagram

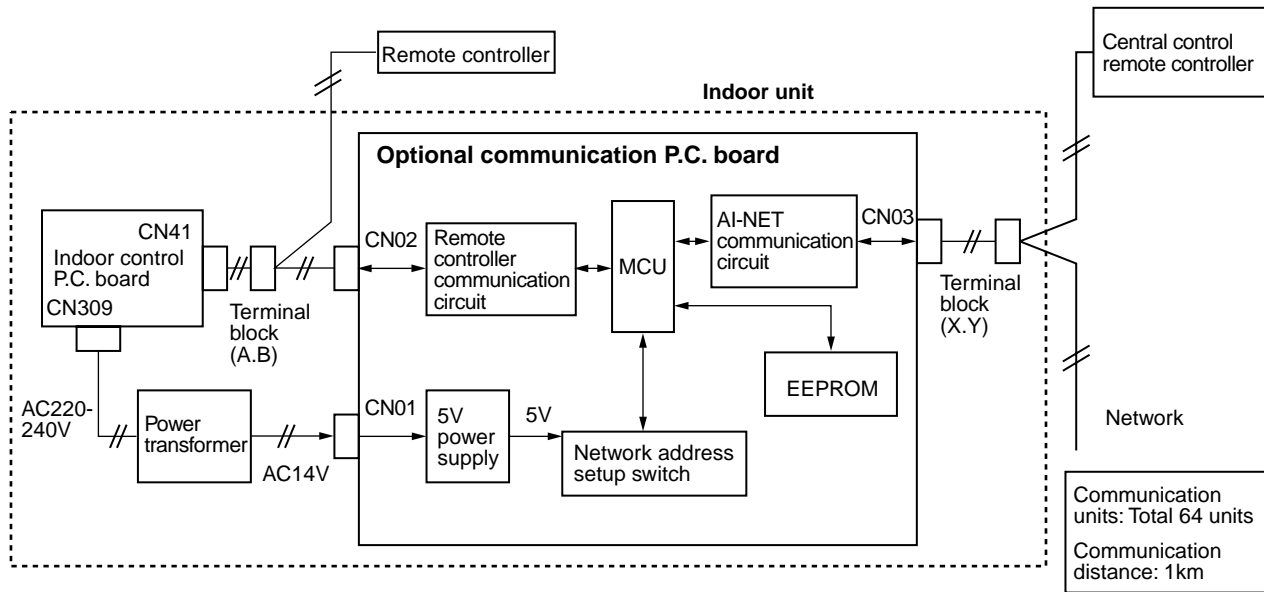

### 12-2-3. Network Address Setup Switch (SW01)

No.	Item	Setup contents
1	Central control address	1 2 3 4 5 6
2		x x x x x x : No.1 unit    x : Switch OFF
3		○ x x x x x : No.2 unit    ○ : Switch OFF
4		:
5		○○○○○ x : No.63 unit
6		○○○○○○ : No.64 unit
7	Setup availability from remote controller	Switch OFF : Setup available from remote controller
8		Switch ON : Setup unavailable from remote controller

### 12-2-4. LED Display Specification

LED No.	Function	Go on	Go off
D01 (Red)	Communication status: Remote controller	During communication	No communication (including communication error)
D02 (Red)	Communication status: Center	During communication	No communication (including communication error)
D03 (Red)	Operation status of air conditioner	Running	Stop
D04 (Red)	Air conditioner error	Error	Normal

\* For positions of LED, refer to P.C. board external view.

## 12-2-5. Communication Cable Specifications

No.	Communication circuit	Communication cable specifications	
1	Remote controller communication side	Cable	Neutral 2-cable type
		Cable type	CVV (JIS C3401) Controlling vinyl insulation vinyl seal cable VCTF (JIS C3306) Vinyl cab tire round type cord VCT (JIS C3401) 600V vinyl cab tire cable VVR (JIS C3401) Vinyl insulation seal cable round type MVVS Cable with net shielding for instrumentation CPEVS Shielded polyethylene insulation vinyl seal cable
		Cable dia.	0.5 to 2.0 mm <sup>2</sup>
		Cable length	Total cable length Max. 500m (Up to 400m when there is wireless remote controller in group)
2	AI NET side	Cable	Neutral 2-cable type
		Cable type	MVVS Cable with net shielding for instrumentation
		Cable dia.	1.25 mm <sup>2</sup> ≤ 500 m, 2.0 mm <sup>2</sup> ≤ 1 km
		Cable length	Total cable length : Up to 500m when using 1.25mm <sup>2</sup> cable, Up to 1000m when using 2.0mm <sup>2</sup> cable

## 12-2-6. Cable Connection

### <Network cable connection>

- Install a network adapter per 1 group of the group control (including single unit control). Also install a network adapter to one of the indoor units in the group control.

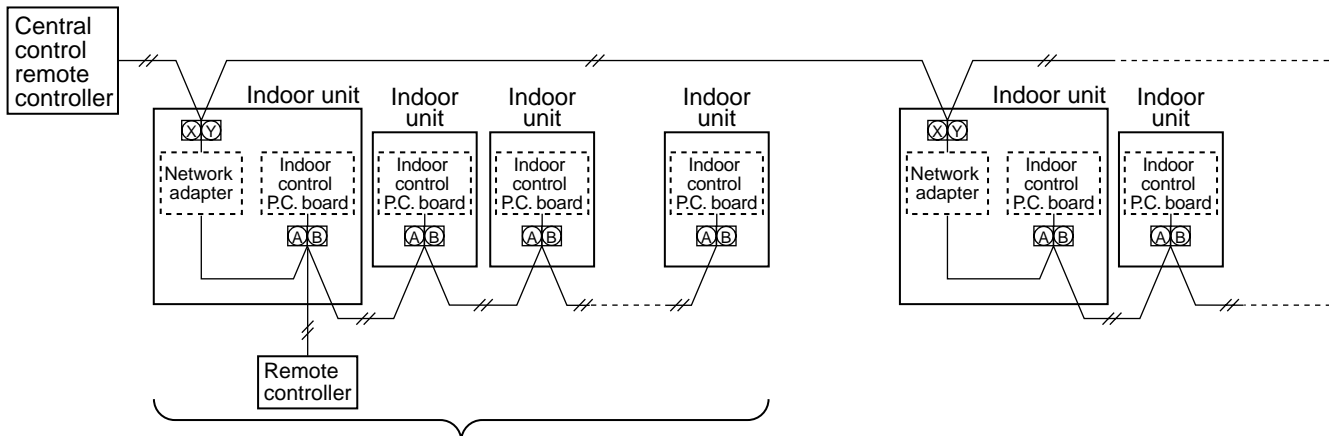

Connectable indoor units per group: Up to 8 units  
(1-remote controller system\*)

\* In case of 2-remote controllers system,  
the connectable indoor units are up to 7 units.

### 12-3. How to Set an Address Number

When connecting indoor units to the central control remote controller by using a network adapter, it is required to set up a network address No.

- The network address No. should be agreed with the line No. of the central control remote controller.
- When the unit was shipped from the factory, the network address has been set to 1.

The following two methods to set the network address are provided.

#### 1. How to set from the remote controller at indoor unit side

\* This method is effective only when ⑦ of set switch SW01 on the network adapter P.C. board is turned off.

<Procedure> Set the network address while the unit stops.

##### 1 Push + buttons for 4 seconds or more.

In the group control, the unit No. *RLU* is displayed, and then all the indoor units in the group control are selected. In this time, fans of all the selected indoor units are turned on. (Fig. 1)

(Keep status of *RLU* display without pushing button.)

For the individual remote controller which is not included in a group control, the line address and the indoor unit address are displayed.

##### 2 Specify the item code using the temperature setup / buttons.

##### 3 Using the timer time / buttons, select the setup data.

The setup data are shown in the right table (Table 1).

##### 4 Push button. (OK if display goes on)

- To change the item to be set, return to 2.

##### 5 Push button.

The status returns to the usual stop status.

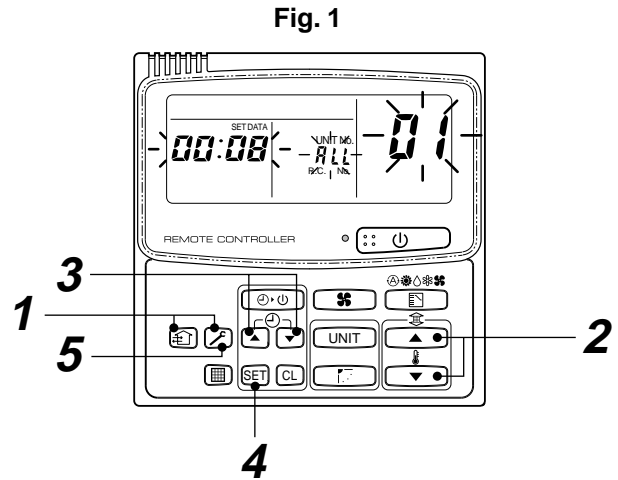

Table 1

Setup data	Network address No.
0001	1
0002	2
0003	3
⋮	⋮
0064	64
0099	Unset (Setup at shipment from factory)

#### 2. How to set by the switch on the network adapter P.C. board

When the remote controller cannot be found or when you don't want to change setting of the network address No. from the remote controller, use the setup switch SW01 on the network adapter P.C. board (Network address No. setup switch) to set the address No.

<Procedure>

- (1) Turn off the power.
- (2) Turn ⑦ of the address No. setup switch SW01 to ON side. Accordingly the address No. set on the remote controller is invalidated. (See Fig. 2.)
- (3) Set the network address No. with combination of ON and OFF of ⑥ to ① of the address No. setup switch SW01. The relation between combination of ON/OFF and address No. is described in Table 2. The right figure (Fig. 3) shows an example of case that the address No. is set to 16.

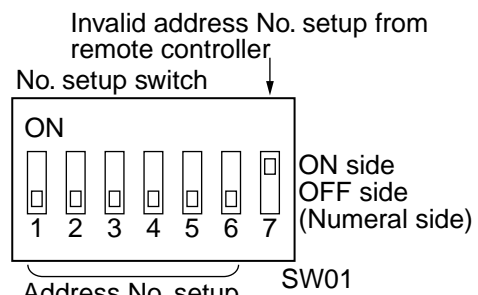

Fig. 2

Setup example of address No. 16

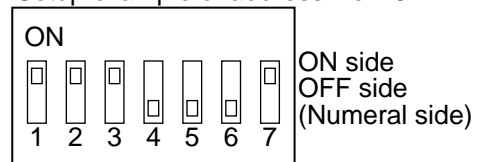

Fig. 3

When the network address No. has been changed, be sure to turn of power of the central control remote controller again or to reset the remote controller using the reset hole on the operation panel of the central control remote controller.

**Table 2 Network address No. setup table (SW01)**

○ : ON side  
 x : OFF side

Address No.						
01	x	x	x	x	x	x
02	○	x	x	x	x	x
03	x	○	x	x	x	x
04	○	○	x	x	x	x
05	x	x	○	x	x	x
06	○	x	○	x	x	x
07	x	○	○	x	x	x
08	○	○	○	x	x	x
09	x	x	x	○	x	x
10	○	x	x	○	x	x
11	x	○	x	○	x	x
12	○	○	x	○	x	x
13	x	x	○	○	x	x
14	○	x	○	○	x	x
15	x	○	○	○	x	x
16	○	○	○	○	x	x
17	x	x	x	x	○	x
18	○	x	x	x	○	x
19	x	○	x	x	○	x
20	○	○	x	x	○	x
21	x	x	○	x	○	x
22	○	x	○	x	○	x
23	x	○	○	x	○	x
24	○	○	○	x	○	x
25	x	x	x	○	○	x
26	○	x	x	○	○	x
27	x	○	x	○	○	x
28	○	○	x	○	○	x
29	x	x	○	○	○	x
30	○	x	○	○	○	x
31	x	○	○	○	○	x
32	○	○	○	○	○	x

Address No.						
33	x	x	x	x	x	○
34	○	x	x	x	x	○
35	x	○	x	x	x	○
36	○	○	x	x	x	○
37	x	x	○	x	x	○
38	○	x	○	x	x	○
39	x	○	○	x	x	○
40	○	○	○	x	x	○
41	x	x	x	○	x	○
42	○	x	x	○	x	○
43	x	○	x	○	x	○
44	○	○	x	○	x	○
45	x	x	○	○	x	○
46	○	x	○	○	x	○
47	x	○	○	○	x	○
48	○	○	○	○	x	○
49	x	x	x	x	○	○
50	○	x	x	x	○	○
51	x	○	x	x	○	○
52	○	○	x	x	○	○
53	x	x	○	x	○	○
54	○	x	○	x	○	○
55	x	○	○	x	○	○
56	○	○	○	x	○	○
57	x	x	x	○	○	○
58	○	x	x	○	○	○
59	x	○	x	○	○	○
60	○	○	x	○	○	○
61	x	x	○	○	○	○
62	○	x	○	○	○	○
63	x	○	○	○	○	○
64	○	○	○	○	○	○

**Requirement in Service**

When using this product as service part to replace the network adapter P.C. board, be sure to match the setup of the setup switch SW01 (Network address No. setup switch) on the network adapter P.C. board with the P.C. board setup before replacement.

## 12-4. Display and Operation of Main Remote Controller and Central Control Remote Controller

- Turn on all the power supplies of the air conditioner, and then turn on power of the central control remote controller (Line 16 RBC-SXC1P, Line 64 TCB-SC641). If both power supplies are simultaneously turned on or if they are turned on reversely, the check code [97] may be temporarily displayed on the central remote controller. When settings of connecting cables and central control address are correct, the connected air conditioner is displayed on the central control remote controller.
- As shown in the following table, there is difference of LCD between main remote controller (RBC-AMT21) and the central control remote controller and also there are restriction and others of operation.

	Item	Contents		Cautions
		Main remote controller	Central control remote controller	
1	Air volume selection	[SPEED] [AUTO] [HH] [H] [L]	[VOL] [AUTO] [H] [M] [L]	Display of air speed selection differs.
		[SPEED] [HH]	[VOL] [FIX]	In duct type Air speed becomes [H] and [FIX].
2	Air speed selection in FAN mode	[SPEED] [HH] [H] [L]	[VOL] [AUTO] [H] [M] [L]	When handling main remote controller, [AUTO] is not displayed. If [AUTO] is selected at center side, [AUTO] is displayed on the main remote controller. In this time, the air speed becomes [HH].
3	Air speed selection in DRY mode	[SPEED] [AUTO] [HH] [H] [L]	[VOL] [AUTO]	On the central remote controller, only [AUTO] is displayed. The display on the main remote controller changes to [AUTO] by changing the setup temperature/louver, and the air speed is automatically selected.
4	Air direction adjustment	[SWING] and air direction adjustment	[LOUVER]	On the central remote controller, only [LOUVER] is displayed. It is displayed while flap is swinging, and the setup operation of [LOUVER] becomes selection of swing ON/OFF. To set up the air direction, use the main remote controller.
		(No display)	Manual operation for [LOUVER]	In a model type without air direction adjustment
5	Check button	Test run (4 seconds)	Check code display and check reset (3 seconds)	The function of long-pushing operation for the check button differs. If the check reset operation on the central remote controller is performed during operation of air conditioner, the operation stops once, and then the operation restarts. (Error of air conditioner is cleared.)
6	Check code	3-digits display (alphabet + 2-digits numeral)	2-digits display (alphabet or numeral)	Display of check code differs. Ex. : Float switch operation Main side: [P10] Center side: [0b]

- When using the remote controller together with the former one (RBC-AM1, AT1), the display on the main remote controller differs if [Last-push priority/Center/Operation Prohibited] is selected from the central control remote controller.

	Item	Contents		Remarks
		New remote controller (RBC-AMT21)	Former remote controller (RBC-AM1, AT1)	
1	Last-push priority	(No display)	(No display)	All the settings and ON/OFF operations are available.
2	Center	[CENTER] goes on	[CENTER] goes on	The setup contents on the central control remote controller are fixed, and only ON/OFF operation and timer setup operation are available on the main remote controller.
3	Operation prohibited		[CENTER] flashes	The setup contents on the central control remote controller are fixed, and the air conditioner stops. Operation from the main remote controller is unavailable.

## 13. ADDRESS SETUP

### 13-1. Address Setup

#### <Address setup procedure>

When an outdoor unit and an indoor unit are connected, or when an outdoor unit is connected to each indoor unit respectively in the group operation even if multiple refrigerant lines are provided, the automatic address setup completes with power-ON of the outdoor unit. The operation of the remote controller is not accepted while automatic address works. (Approx. 4 to 5 minutes)

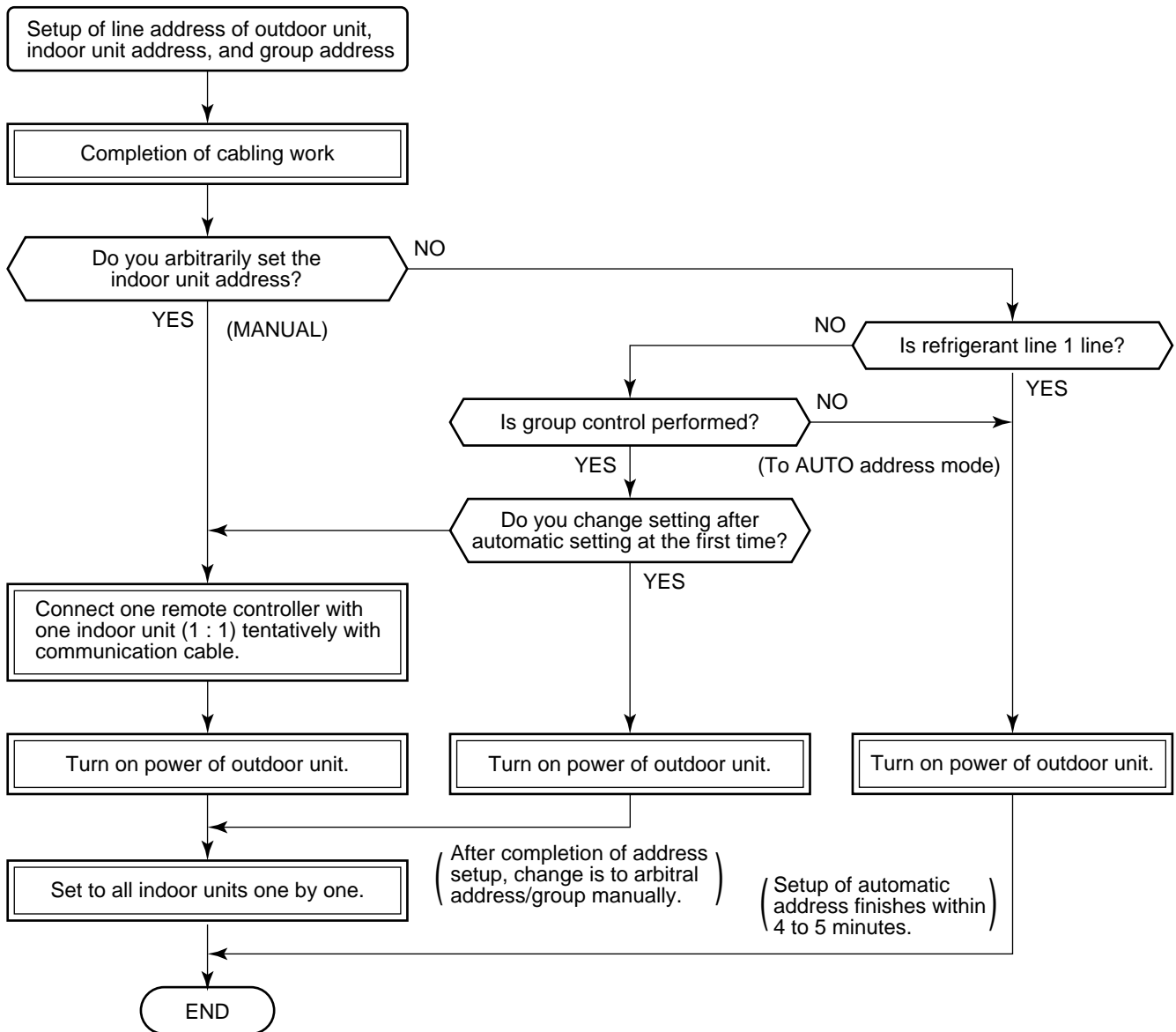

- When the following addresses are not stored in the neutral memory (IC10) on the indoor P.C. board, a test run operation cannot be performed. (Unfixed data at shipment from factory)

	Item code	Data at shipment	Setup data range
Line address	12	0099	0001 (No. 1 unit) to 0030 (No. 30 unit)
Indoor unit address	13	0099	0001 (No. 1 unit) to 0030 (No. 30 unit) Max. value of indoor units in the identical refrigerant line (Double twin = 4)
Group address	14	0099	0000 : Individual (Indoor units which are not controlled in a group) 0001 : Master unit (1 indoor unit in group control) 0002 : Sub unit (Indoor units other than master unit in group control)

## 13-2. Address Setup & Group Control

### <Terminology>

Indoor unit No. : N - n = Outdoor unit line address N (Max. 30) - Indoor unit address n (Max. 64)

Group address : 0 = Individual (Not group control)  
 1 = Master unit in group control  
 2 = Sub unit in group control

Master unit (= 1) : The representative of multiple indoor units in group operation sends/receives signals to/from the remote controllers and sub indoor units. (\* It has no relation with an indoor unit which communicates serially with the outdoor units.)

The operation mode and setup temperature range are displayed on the remote controller LCD. (Except sir direction adjustment of flap)

Sub unit (= 2) : Indoor units other than master unit in group operation  
 Basically, sub units do not send/receive signals to/from the remote controllers.  
 (Except errors and response to demand of service data)

### 13-2-1. System configuration

1. Single

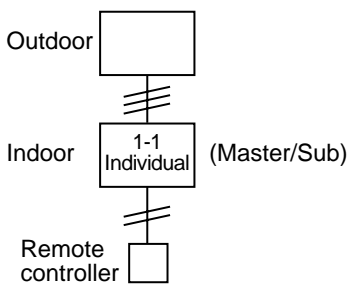

2. Single group operation

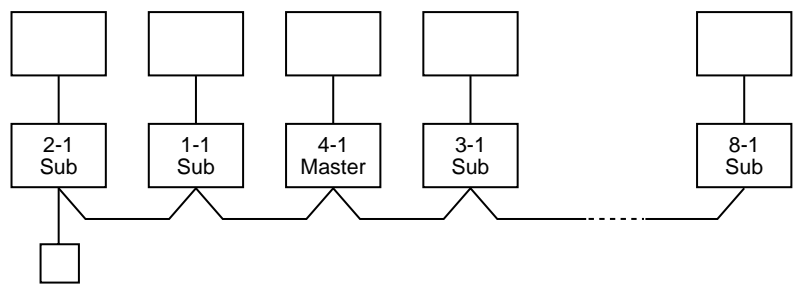

### 13-2-2. Automatic address example from unset address (No miscabling)

1. Standard (One outdoor unit)

1) Single

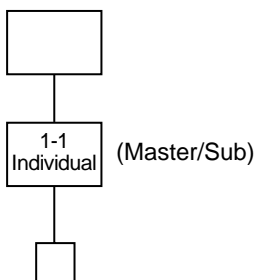

2) Gr operation

(Multiple outdoor units = Multiple indoor units only with serial communication)

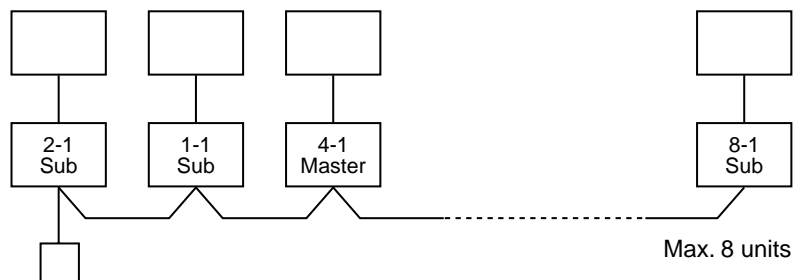

**Only turning on source power supply (Automatic completion)**

### 13-3. Address Setup

In case that addresses of the indoor units will be determined prior to piping work after cabling work  
(Manual setting from remote controller)

#### <Address setup procedure>

- Set an indoor unit per a remote controller.
- Turn on power supply.

- 1** Push **SET** + **END** + **1** buttons simultaneously for 4 seconds or more.
- 2** (← Line address) Using the temperature setup **▲** / **▼** buttons, set **1** to the item code.
- 3** Using timer time **▲** / **▼** buttons, set the line address.
- 4** Push **SET** button. (OK when display goes on.)
- 5** (← Indoor unit address) Using the temperature setup **▲** / **▼** buttons, set **1** to the item code.
- 6** Using timer time **▲** / **▼** buttons, set **1** to the line address.
- 7** Push **SET** button. (OK when display goes on.)
- 8** (← Group address) Using the temperature setup **▲** / **▼** buttons, set **1** to the item code.
- 9** Using timer time **▲** / **▼** buttons, set **0000** to Individual, **0001** to Master unit, and **0002** to sub unit.
- 10** Push **SET** button. (OK when display goes on.)
- 11** Push **END** button.  
Setup completes.  
(The status returns to the usual stop status.)

(Example of 2-lines cabling)  
(Real line: Cabling, Broken line: Refrigerant pipe)

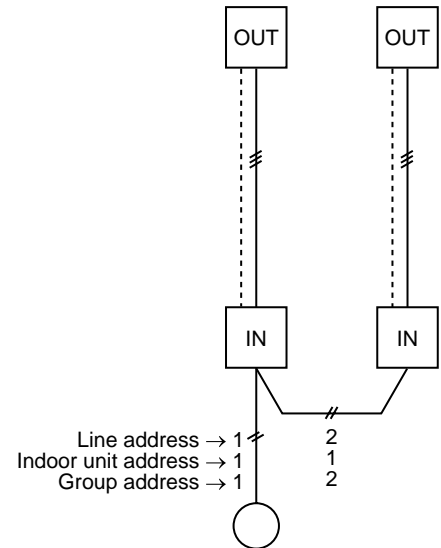

For the above example, perform setting by connecting singly the wired remote controller without remote controller inter-unit cable.

Group address  
Individual : 0000  
Master unit : 0001  
Sub unit : 0002 } In case of group control

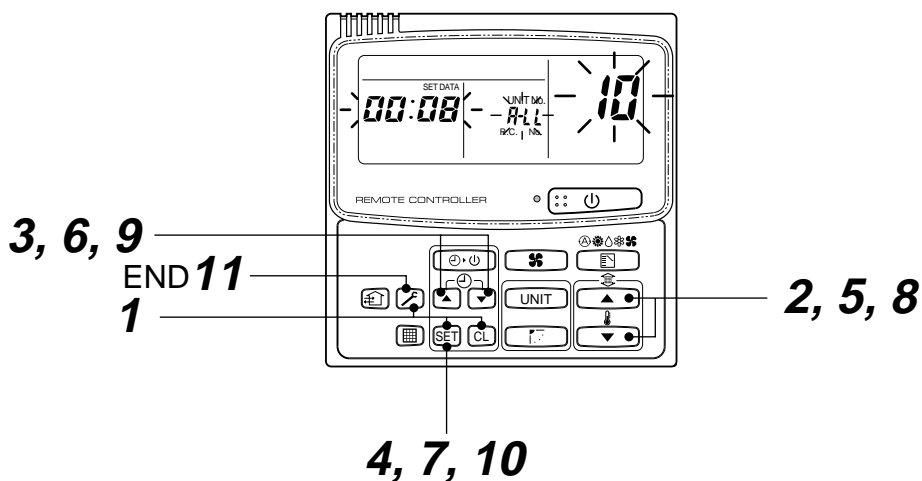

<Operation procedure>

**1 → 2 → 3 → 4 → 5 → 6 → 7 → 8 → 9 → 10 → 11 END**



■ Confirmation of indoor unit No. position

1. To know the indoor unit addresses though position of the indoor unit body is recognized

- In case of individual operation (Wired remote controller : indoor unit = 1 : 1)  
(Follow to the procedure during operation)

<Procedure>

**1** Push  button if the unit stops.

**2** Push  button.

Unit No. /-/- is displayed on LCD.

(It disappears after several seconds.)

The displayed unit No. indicate line address and indoor unit address.

(When other indoor units are connected to the identical remote controller (Group control unit), other unit numbers are also displayed every pushing  button.

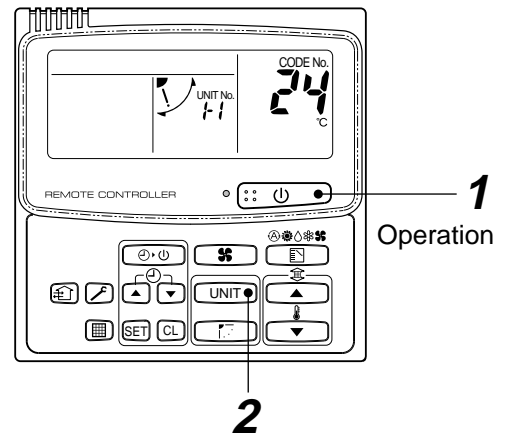

<Operation procedure>

**1 → 2** END

2. To know the position of indoor unit body by address

- To confirm the unit No. in the group control  
(Follow to the procedure during operation) (in this procedure, the indoor units in group control stop.)

<Procedure>

The indoor unit numbers in the group control are successively displayed, and fan, flap, and drain pump of the corresponding indoor unit are turned on. (Follow to the procedure during operation)

**1** Push  and  buttons simultaneously for 4 seconds or more.

- Unit No. ALL is displayed.
- Fans and flaps of all the indoor units in the group control operate.

**2** Every pushing  button, the unit numbers in the group control are successively displayed.

- The unit No. displayed at the first time indicates the master unit address.
- Fan and flap of the selected indoor unit only operate.

**3** Push  button to finish the procedure. All the indoor units in the group control stop.

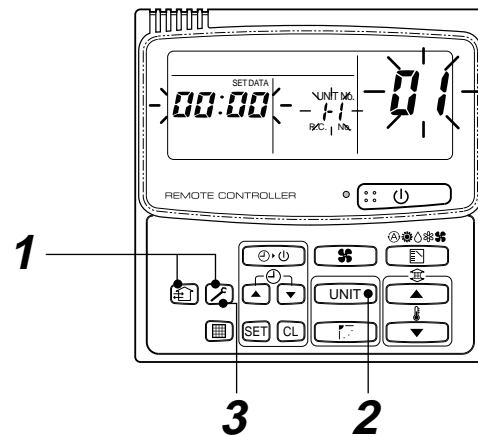

<Operation procedure>

**1 → 2 → 3** END

## 14. DETACHMENTS



### 14-1. Indoor Unit

**RAV-SM561BT-E / SM801BT-E / SM1101BT-E / SM1401BT-E**

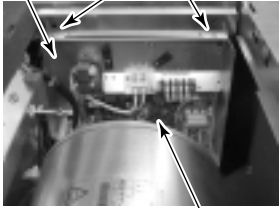
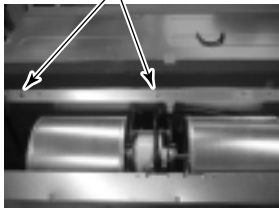
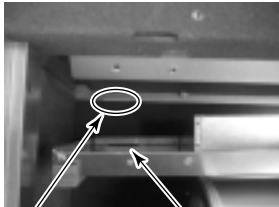
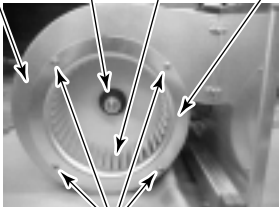
Be sure to turn off the power supply or circuit breaker before disassembling work

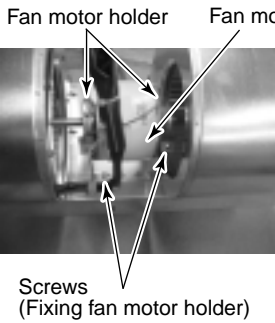
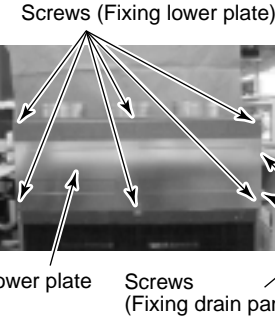
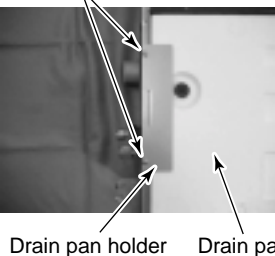
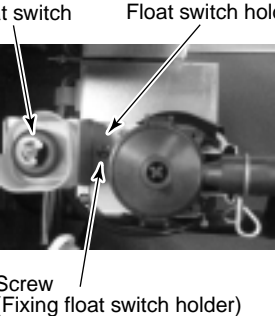
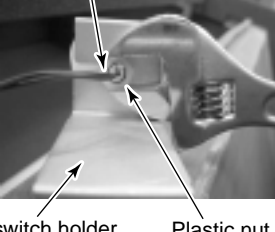

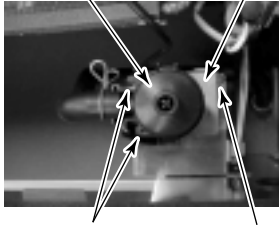
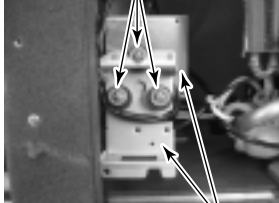
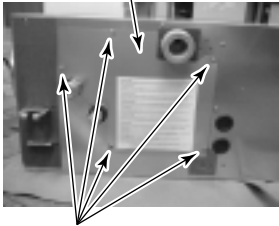
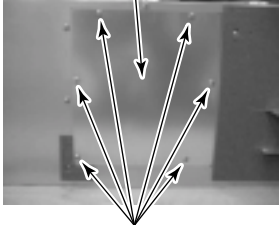
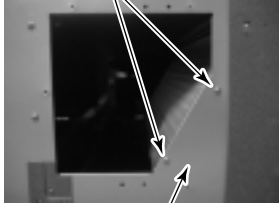
No.	Part name	Procedure	Remarks
①	Electrical parts box	<ol style="list-style-type: none"> <li>1. Remove the air filter.</li> <li>2. Remove the set screws (2 positions) of the electrical parts cover.</li> <li>3. Remove the electrical parts cover.</li> <li>4. Remove the set screws (2 positions) of the electrical parts box.</li> <li>5. Remove the electrical parts box.</li> </ol> <p>The electrical parts box is fixed to the main unit with claws at the right side.</p> <p>Lift up it once and pull toward you.</p> <p>Then claws come off.</p> <p>In this time, remove connectors of TA sensor, TC sensor and TCJ sensor if necessary.</p>	<p>Screws (Fixing electrical parts cover and box)</p> <p>Electrical parts cover</p>  <p>①-2 ①-3</p> <p>Screws (Fixing electrical parts box and main unit)</p> <p>Electrical parts box</p>  <p>①-4 ①-5</p> <p>Claw (Reverse side)</p>
②	Multi blade fan	<ol style="list-style-type: none"> <li>1. Remove the air filter.</li> <li>2. Remove the connector of the fan motor P.C. board.</li> <li>3. Remove the hexagon head screw (561: 2, 801, 1101, 1401 : 3 positions) of fixing fan assembly and main unit.</li> <li>4. Remove the fan assembly from main unit.</li> </ol> <p>The fan assembly is fixed to the main unit with claws (3 positions) at the upper side.</p> <p>Lift up it once and pull toward rear side.</p> <p>Then claws come off.</p> <ol style="list-style-type: none"> <li>5. Remove the set screws (4 positions) of fixing fan case and fan cover.</li> <li>6. Remove the fan cover.</li> <li>7. Loosen the sets crew of the Multi blade fan using hexagon wrench.</li> <li>8. Pull the Multi blade fan towered fan case side.</li> </ol> <p>Then fans come off.</p>	<p>Hexagon head screws (Fixing fan assembly and main unit)</p>  <p>②-3</p>  <p>②-4</p> <p>Fixing claw (Main unit)</p> <p>Fixing hole (Fan assembly)</p> <p>Fan case      Multi blade fan</p> <p>Set screw      Fan case cover</p>  <p>②-5 ②-6</p> <p>Screws (Fixing fan case cover)</p>

No.	Part name	Procedure	Remarks
③	Fan motor	<ol style="list-style-type: none"> <li>1. Remove the Multi blade fan.</li> <li>2. Remove the hexagon head screw of fixing fan motor holder.</li> <li>3. Remove the fan motor holder (2 positions).</li> </ol>	 <p>Fan motor holder    Fan motor</p> <p>Screws (Fixing fan motor holder)    ③-2 ③-3</p>
④	Drain pan	<ol style="list-style-type: none"> <li>1. Take down the main unit and then treat the drain pan on the floor.</li> <li>2. Remove the set screws (561 : 7, 801, 1101, 1401 : 9 positions) of fixing lower plate.</li> <li>3. Remove the lower plate from main unit.</li> <li>4. Remove the set screws (561 : Nothing, 801 : 2 positions, 1101, 1401 : 4 positions) of fixing drain pan holder and main unit.</li> <li>5. Remove the drain pan holder (561 : Nothing, 801 : 1 position, 1101, 1401 : 2 positions) from main unit.</li> <li>6. Remove the drain pan. Pull it lower side.</li> </ol>	 <p>Screws (Fixing lower plate)    ④-2 ④-3</p> <p>Lower plate    Screws (Fixing drain pan holder)</p>  <p>Screws (Fixing drain pan holder)</p> <p>Drain pan holder    Drain pan    ④-4 ④-5</p>
⑤	Float switch	<ol style="list-style-type: none"> <li>1. Remove the drain pan.</li> <li>2. Remove the set screw (1 position) of fixing float switch holder.</li> <li>3. Remove the plastics nut of foxing float switch.</li> <li>4. Remove the float switch.</li> </ol>	 <p>Float switch    Float switch holder</p> <p>Screw (Fixing float switch holder)    ⑤-2</p>  <p>Float switch (View from reverse side)</p> <p>Float switch holder    Plastic nut    ⑤-3</p>

No.	Part name	Procedure	Remarks
⑥	Drain pump	<ol style="list-style-type: none"> <li>1. Remove the drain pan and float switch.</li> <li>2. Remove the set screws (3 positions) of fixing drain pump plate and main unit.</li> <li>3. Remove the set screws (3 positions) of fixing drain pump plate and drain pump.</li> </ol>	<p>Drain pump      Drain pump holder</p>  <p>⑥-2</p> <p>Screws (Fixing drain pump holder)</p> <p>Screws (Fixing plate and drain pump)</p>  <p>⑥-3</p> <p>Drain pump holder</p> <p>⑥-3. View from reverse side of drain pump</p>
⑦	TC, TCJ sensor	<ol style="list-style-type: none"> <li>1. Remove the set screws (5 positions) and check port cover (right side).</li> <li>2. Pull out the sensor is inserted into pipe of the heat exchanger.</li> </ol>	<p>Checking port cover (Right side)</p>  <p>⑦-1</p> <p>Screws (Fixing check port cover (Right side))</p>
⑧	Heat exchanger	<ol style="list-style-type: none"> <li>1. Take down the main unit and then treat the heat exchanger on the floor.</li> <li>2. Remove the drain pan.</li> <li>3. Remove the check port cover (right side).</li> <li>4. Remove the set screws (6 positions) and check port cover (left side).</li> <li>5. Remove the set screws (2 positions) of fixing heat exchanger and main unit (left side).</li> <li>6. Remove the set screws (7 positions) of fixing heat exchanger and main unit (front right side).</li> </ol>	<p>Check port cover (Left side)</p>  <p>⑧-4</p> <p>Screws (Fixing check port cover (Left side))</p> <p>Screws (Fixing heat exchanger)</p>  <p>⑧-5</p> <p>Main unit (Left side)</p> <p>Main unit (Front side)</p>  <p>⑧-6</p> <p>Screws</p>

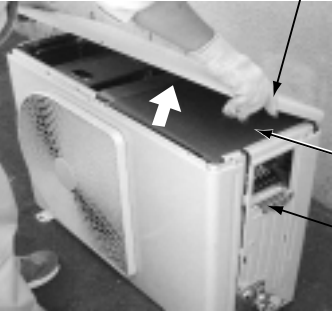
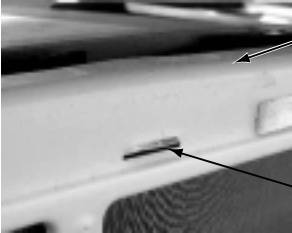

## 14-2. Outdoor Unit

### RAV-SM560AT-E

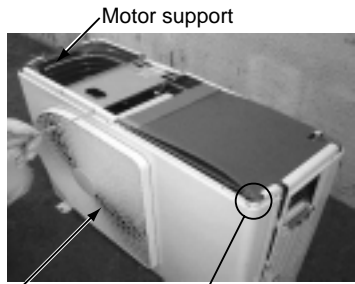
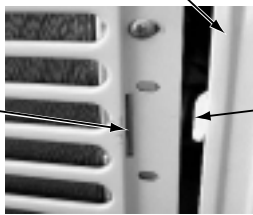
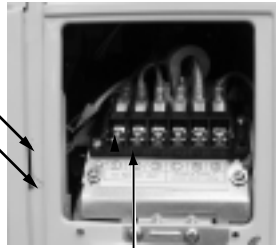
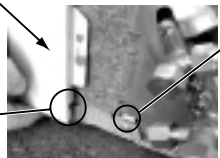

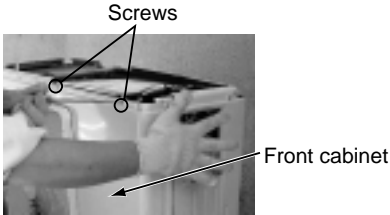
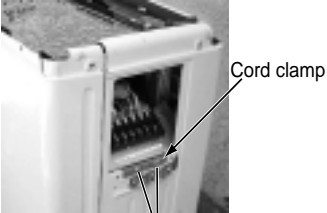
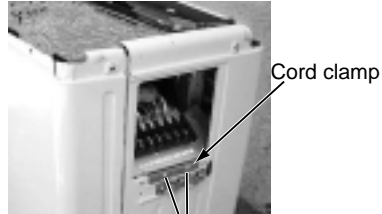
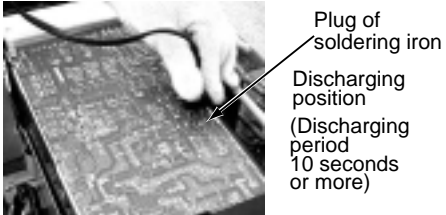
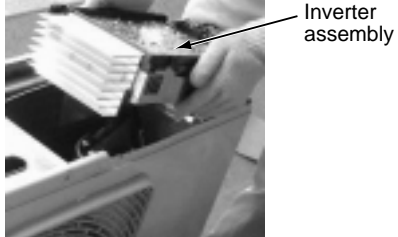
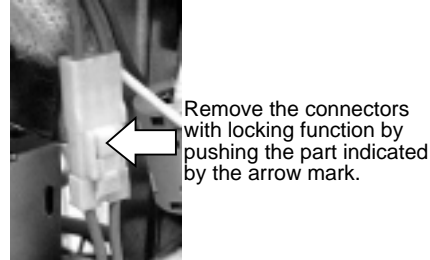
No.	Part name	Procedure	Remarks
①	Common procedure	<p style="text-align: center;"><b>CAUTION</b></p> <p>Never forget to put on the gloves at working time, otherwise an injury will be caused by the parts, etc.</p> <p><b>1. Detachment</b></p> <ol style="list-style-type: none"> <li>1) Stop operation of the air conditioner, and turn off the main switch of the breaker for air conditioner.</li> <li>2) Remove the valve cover. (ST1T Ø4 x 10L, 1 pc.) <ul style="list-style-type: none"> <li>• After removing screw, remove the valve cover pulling it downward.</li> </ul> </li> <li>3) Remove wiring cover (ST1T Ø4 x 10L, 2 pcs.), and then remove connecting cable.</li> <li>4) Remove the upper cabinet. (ST1T Ø4 x 10L, 2 pcs.) <ul style="list-style-type: none"> <li>• After taking off screws, remove the upper cabinet pulling it upward.</li> </ul> </li> </ol> <p><b>2. Attachment</b></p> <ol style="list-style-type: none"> <li>1) Attach the waterproof cover.</li> </ol> <p style="text-align: center;"><b>CAUTION</b></p> <p>Be sure to attach a waterproof cover. If it is not attached, there is a possibility that water enters inside of the outdoor unit.</p> <ol style="list-style-type: none"> <li>2) Attach the upper cabinet. (ST1T Ø4 x 10L, 2 pcs.) <ul style="list-style-type: none"> <li>• Hook the rear side of the upper cabinet to claw of the rear cabinet, and then put it on the front cabinet.</li> </ul> </li> <li>3) Perform cabling of connecting cables, and fix with cord clamp. (ST1T Ø4 x 10L 3 pcs.)</li> <li>4) Attach the wiring cover. (ST1T Ø4 x 10L, 2 pcs.)</li> <li>5) Attach the valve cover. (ST1T Ø4 x 10L, 1 pc.) <ul style="list-style-type: none"> <li>• Insert the upper part of the upper cabinet, set hooking claw of the valve cover to the slit (at three positions) of the main body, and then attach it pushing upward.</li> </ul> </li> </ol>	 <p>Valve cover</p>  <p>Wiring cover</p>  <p>Upper cabinet</p> <p>Water-proof cover</p> <p>Cord clamp</p>  <p>Rear cabinet</p> <p>Claw</p>

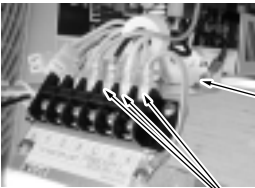
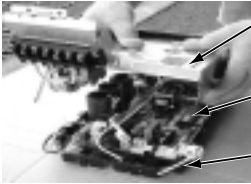
No.	Part name	Procedure	Remarks
②	Front cabinet	<p><b>1. Detachment</b></p> <ol style="list-style-type: none"> <li>1) Perform work of item 1 of ①.</li> <li>2) Remove screws (ST1T Ø4 x 10L, 2 pcs.) of the front cabinet and the inverter cover.</li> <li>3) Take off screws of the front cabinet and the bottom plate. (ST1T Ø4 x 10L 3 pcs.)</li> <li>4) Take off screws of the front cabinet and the motor support. (ST1T Ø4 x 10L, 2 pcs.) <ul style="list-style-type: none"> <li>• The left side of the front side if made to insert to the rear cabinet, so remove it pulling upward.</li> </ul> </li> </ol> <p><b>3. Attachment</b></p> <ol style="list-style-type: none"> <li>1) Insert hook at the left side of the front side into the rear cabinet.</li> <li>2) Hook the lower part at the right side of the front to concavity of the bottom plate. Insert the hook of the rear cabinet into the slit of the front cabinet.</li> <li>3) Attach the removed screws to the original positions.</li> </ol>	 <p>Motor support</p> <p>Front cabinet</p> <p>For single-phase type models, also take off this screw</p>  <p>Front cabinet (Left side)</p> <p>Slit</p> <p>Claw</p>  <p>Slit</p> <p>Hook</p> <p>Cord clamp</p>  <p>Front cabinet</p> <p>Lower slit</p> <p>Concavity at bottom plate</p>

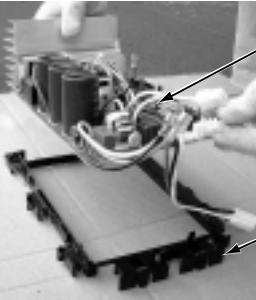
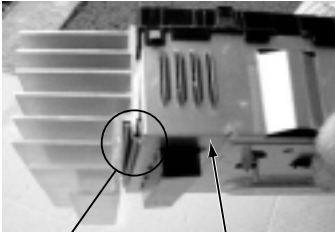
No.	Part name	Procedure	Remarks
③	Inverter assembly	<p><b>1. Detachment</b></p> <p>1) Perform work of item 1 of ①.</p> <p>2) Take off screws of the upper part of the front cabinet.</p> <ul style="list-style-type: none"> <li>• If removing the inverter cover under this condition, P.C. board can be checked.</li> <li>• If there is no space in the upper part of the upper cabinet, perform work of ②.</li> </ul> <div style="border: 1px solid black; border-radius: 10px; padding: 5px; margin: 10px 0;"> <p style="text-align: center;"><b>CAUTION</b></p> <p>Be careful to check the inverter because high-voltage circuit is incorporated in it.</p> </div> <p>3) Perform discharging by connecting ⊕, ⊖ polarities by discharging resistance (approx. 100Ω, 40W) or plug of soldering iron to ⊕, ⊖ terminals of the C14 (printed as "CAUTION HIGH VOLTAGE") electrolytic capacitor (500μF) of P.C. board.</p> <div style="border: 1px solid black; border-radius: 10px; padding: 5px; margin: 10px 0;"> <p style="text-align: center;"><b>WARNING</b></p> <p>The electrolytic capacitor may not normally discharge according to error contents and the voltage may remain. Therefore, be sure to discharge the capacitor.</p> </div> <div style="border: 1px solid black; border-radius: 10px; padding: 5px; margin: 10px 0;"> <p style="text-align: center;"><b>WARNING</b></p> <p>For discharging, never use a screwdriver and others for short-circuiting between ⊕ and ⊖ electrodes. As the electrolytic capacitor is one with a large capacity, it is very dangerous because a large electric spark will occur.</p> </div> <p>4) Take off screws (ST1T Ø4 x 10L, 2 pcs.) fixing the main body and the inverter box.</p> <p>5) Remove various lead wires from the holder at upper part of the inverter box and wiring holder at right side of the terminal block.</p> <p>6) Remove the lead wire from the bundled part at left side of the terminal block.</p> <p>7) Pull the inverter box upward.</p> <p>8) Disconnect connectors of various lead wires.</p> <div style="border: 1px solid black; border-radius: 10px; padding: 5px; margin: 10px 0;"> <p style="text-align: center;"><b>REQUIREMENT</b></p> <p>As each connector has a lock mechanism, avoid to remove the connector by holding the lead wire, but by holding the connector.</p> </div>	 <p>Screws Front cabinet</p>  <p>Cord clamp Screws</p>  <p>Cord clamp Screws</p>  <p>Plug of soldering iron Discharging position (Discharging period 10 seconds or more)</p>  <p>Inverter assembly</p>  <p>Remove the connectors with locking function by pushing the part indicated by the arrow mark.</p>

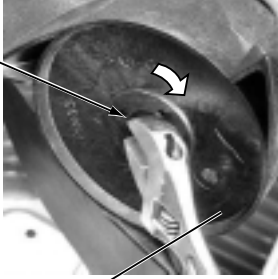

No.	Part name	Procedure	Remarks
④	Control P.C. board assembly	<p>1) Disconnect lead wires and connectors connected from the control P.C. board assembly to other parts.</p> <p>1. Lead wires</p> <ul style="list-style-type: none"> <li>• Connection with the power terminal block: 3 wires (Black, White, Orange)</li> <li>• Earth wire: 1 wire (Black)</li> </ul> <p>2. Connectors</p> <ul style="list-style-type: none"> <li>• Connection with compressor: Remove 3P connector.</li> <li>• Connection with reactor: Remove the relay connectors from P07, 08 (2P, White) and P12, 13 (2P, Yellow)</li> </ul> <p>CN300 : Outdoor fan (3P, White)            CN301 : Position detection (5P, White)            CN701 : 4-way valve (3P, Yellow)            CN600 : TE sensor (2P, White)            CN601 : TD sensor (3P, White)            CN603 : TS sensor (3P, White)            CN602 : TO sensor (3P, White)            CN500 : Case thermo. (2P, White)            CN703 : PMV (6P, White)</p> <p>2) Remove the inverter box (Metal plate).</p> <p>3) Remove the control board assembly from P.C. board base. (Remove the heat sink and the control board assembly as they are screwed.)</p> <p><b>NOTES:</b></p> <p>1. CN300, CN301 and CN701, etc. at the control board assembly side are connectors with locking function. Therefore, remove the connector while pushing the part indicated by an arrow mark.</p> <p>2. Remove 4 hooking claws of P.C. board base, and remove upward the heat sink with hands.</p> <p>4) Take off 3 screws fixing the heat sink and main control board assembly side, and replace the board with a new one.</p> <p><b>NOTE:</b>            When mounting a new board, check that the board is correctly set in the groove of the base holder of P.C. board base. Attach the P.C. board so that the heat sink comes securely contact with the metal sheet.</p>	 <p>Take off earth screws.</p> <p>Power line</p>  <p>Inverter box (Metal sheet)</p> <p>Control P.C. board assembly</p> <p>P.C. board base</p>  <p>Hooking claws (4 positions)</p>  <p>Control P.C. board assembly</p> <p>P.C. board base</p>  <p>Heat sink</p> <p>Inverter box (Metal sheet)</p>

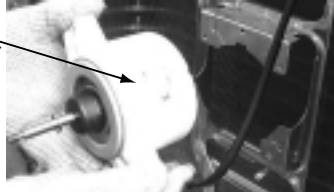

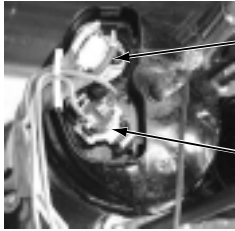
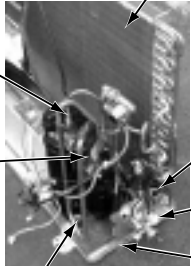
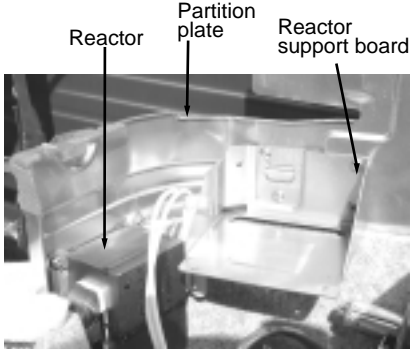
No.	Part name	Procedure	Remarks
⑤	Rear cabinet	1) Perform works of items 1 of ① and ②, ③. 2) Take off fixed screws for the bottom plate. (ST1T Ø4 x 10L, 3 pcs.) 3) Take off fixed screws for the heat exchanger. (ST1T Ø4 x 10L, 2 pcs.) 4) Take off fixed screw for the valve mounting plate. (ST1T Ø4 x 10L, 1 pc.)	
⑥	Fan motor	1) Perform works of items 1 of ① and ②. 2) Take off the flange nut fixing the fan motor and the propeller. <ul style="list-style-type: none"> <li>• Turning it clockwise, the flange nut can be loosened. (To tighten the flange nut, turn counterclockwise.)</li> </ul> 3) Remove the propeller fan. 4) Disconnect the connector for fan motor from the inverter. 5) Take off the fixing screws (3 pcs.) holding by hands so that the fan motor does not fall. <p><b>NOTE:</b> Tighten the flange nut with torque 4.9Nm (50kgf/cm).</p>	 <p>Loosen the nut by turning clockwise</p>  

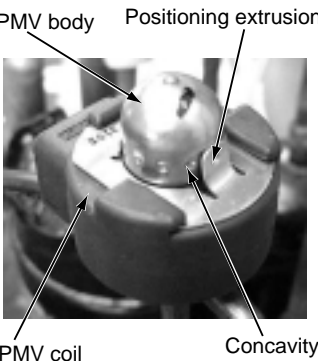
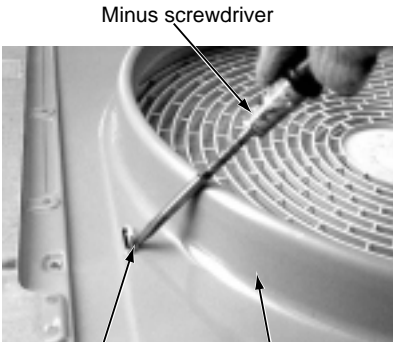
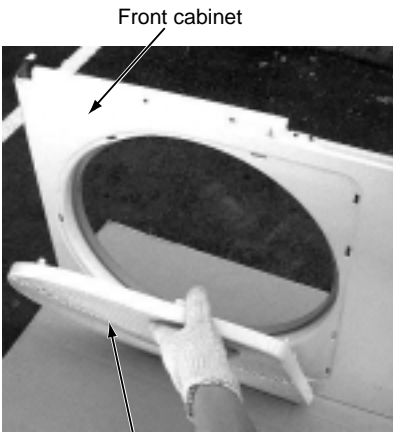

No.	Part name	Procedure	Remarks
⑦	Compressor	<ol style="list-style-type: none"> <li>1) Perform works of items 1 of ① and ②, ③, ④, ⑤.</li> <li>2) Discharge refrigerant gas.</li> <li>3) Remove the partition plate. (ST1T Ø4 x 10L, 2 pcs.)</li> <li>4) Remove the noise-insulator.</li> <li>5) Remove the terminal covers of the compressor, and disconnect lead wires of the compressor and the compressor thermo assembly from the terminal.</li> <li>6) Remove pipes connected to the compressor with a burner.</li> </ol> <div style="border: 1px solid black; border-radius: 10px; padding: 5px; margin: 10px 0; text-align: center;"> <p><b>CAUTION</b></p> <p>Pay attention to that flame does not involve 4-way valve or PMV. (If doing so, a malfunction may be caused.)</p> </div> <ol style="list-style-type: none"> <li>7) Take off the fixing screws of the bottom plate and heat exchanger. (ST1T Ø4 x 10L, 2 pcs.)</li> <li>8) Take off the fixing screws of the valve clamping plate to the bottom plate.</li> <li>9) Pull upward the refrigerating cycle.</li> <li>10) Take off nut fixing the compressor to the bottom plate.</li> </ol> <div style="border: 1px solid black; border-radius: 10px; padding: 5px; margin: 10px 0; text-align: center;"> <p><b>CAUTION</b></p> <p>When reconnecting the lead wires to the compressor terminals after replacement of the compressor, be sure to caulk the Faston terminal without loosening.</p> </div>	<p style="text-align: center;">Partition plate</p>   <p style="text-align: right;">Compressor lead Case thermo</p>  <p style="text-align: right;">Heat exchanger Remove (Discharge pipe) Remove (Suction pipe) Screw Valve support board Screws (2 pcs.) Compressor bolt (3 pcs.)</p>
⑧	Reactor	<ol style="list-style-type: none"> <li>1) Perform works of item 1 of ① and ③.</li> <li>2) First take off two screws (ST1T Ø4 x 10L) of the reactor fixed to the reactor support.</li> <li>3) Remove the reactor support from the partition plate. (ST1T Ø4 x 10L, 4 pcs.)</li> <li>4) Take off two screws (ST1T Ø4 x 10L) directly attached to the partition plate.</li> </ol>	 <p style="text-align: center;">Reactor      Partition plate      Reactor support board</p>

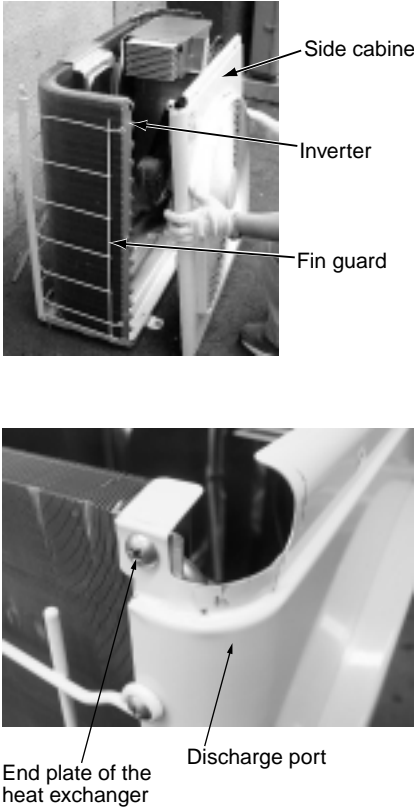
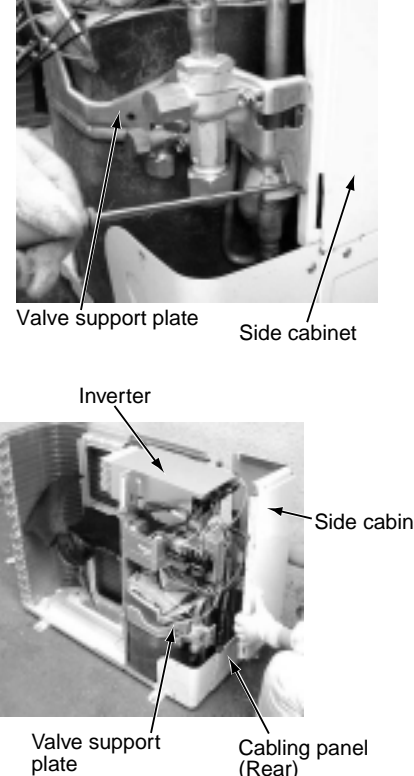

No.	Part name	Procedure	Remarks
⑨	Pulse Modulating Valve (PMV) coil	<p><b>1. Detachment</b></p> <ol style="list-style-type: none"> <li>1) Perform works of items ① and ②.</li> <li>2) Release the coil from the concavity by turning it, and remove coil from the PMV.</li> </ol> <p><b>2. Attachment</b></p> <ol style="list-style-type: none"> <li>1) Put the coil deep into the bottom position.</li> <li>2) Fix the coil firmly by turning it to the concavity.</li> </ol>	 <p>PMV body    Positioning extrusion PMV coil    Concavity</p>
⑩	Fan guard	<p><b>1. Detachment</b></p> <ol style="list-style-type: none"> <li>1) Perform works of items 1 of ①, and ②.</li> <li>2) Remove the front cabinet, and put it down so that fan guard side directs downward.</li> </ol> <div style="border: 1px solid black; border-radius: 10px; padding: 5px; text-align: center; margin: 10px 0;"><b>CAUTION</b></div> <p>Perform works on a corrugated card-board, cloth, etc. to prevent flaw on the product.</p> <ol style="list-style-type: none"> <li>3) Remove the hooking claws by pushing with minus screwdriver along with the arrow mark in the right figure, and remove the fan guard.</li> </ol> <p><b>2. Attachment</b></p> <ol style="list-style-type: none"> <li>1) Insert claws of the fan guard in the hole of the front cabinet. Push the hooking claws (10 positions) with hands and then fix the claws.</li> </ol> <div style="border: 1px solid black; border-radius: 10px; padding: 5px; text-align: center; margin: 10px 0;"><b>CAUTION</b></div> <p>All the attaching works have completed. Check that all the hooking claws are fixed to the specified positions.</p>	 <p>Minus screwdriver Hooking claw    Front cabinet</p>  <p>Front cabinet Fan guard</p>

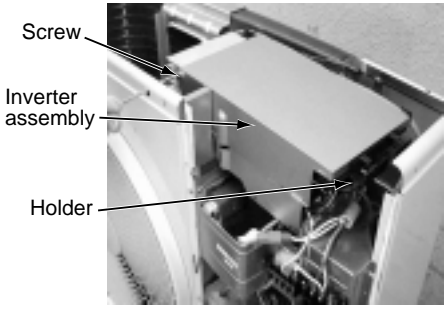
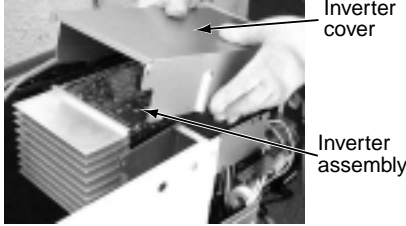
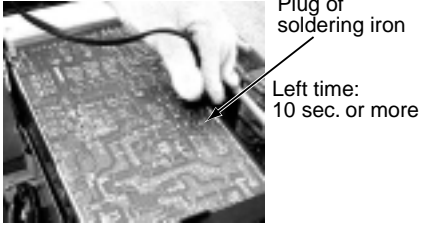
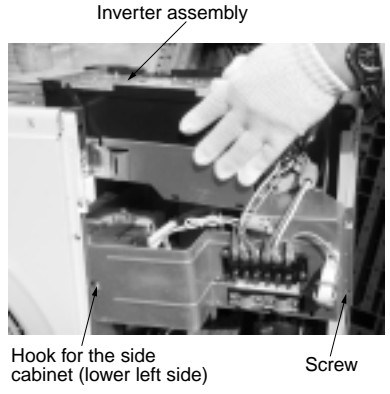
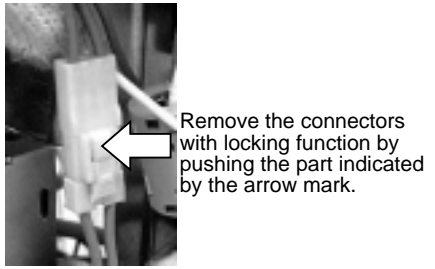
No.	Part name	Procedure	Remarks
①	Common procedure	<p style="text-align: center;"><b>CAUTION</b></p> <p>Never forget to put on the gloves at working time, otherwise an injury will be caused by the parts, etc.</p> <p><b>1. Detachment</b></p> <ol style="list-style-type: none"> <li>1) Stop operation of the air conditioner, and also turn off switch of the breaker.</li> <li>2) Remove the front panel. (ST1T Ø4 x 10L, 3 pcs.) <ul style="list-style-type: none"> <li>• After taking off screws, remove the front panel by pulling it downward.</li> </ul> </li> <li>3) Disconnect the connecting cables and power cord from the terminals and cord clamp.</li> <li>4) Remove the upper cabinet. (ST1T Ø4 x 10L, 6 pcs.)</li> </ol> <p><b>2. Attachment</b></p> <ol style="list-style-type: none"> <li>1) Attach the waterproof cover. <p style="text-align: center;"><b>CAUTION</b></p> <p>Be sure to attach a waterproof cover. If it is not attached, there is a possibility that water enters inside of the outdoor unit.</p> <ol style="list-style-type: none"> <li>2) Attach the upper cabinet. (ST1T Ø4 x 10L, 6 pcs.)</li> <li>3) Connect the connecting cable and power cord at the terminal and fix them with cord clamp. <p style="text-align: center;"><b>CAUTION</b></p> <p>Using bundling band sold at a market, be sure to fix the power cables and indoor/outdoor connecting cables along the inter-unit cable so that they do not come to contact with the compressor, valves and cables at gas side, and the discharge pipe.</p> <li>4) Attach the front cabinet. (ST1T Ø4 x 10L, 3 pcs.)</li> </li></ol> </li></ol>	 <p>Front cabinet</p>  <p>Upper plate of cabinet</p> <p>Water-proof cover</p>

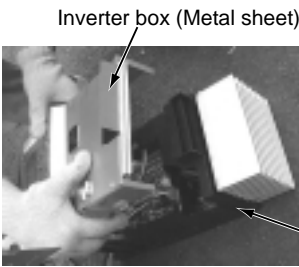
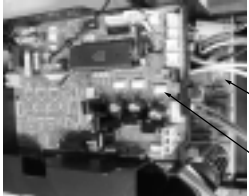
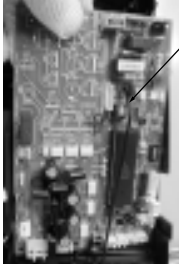

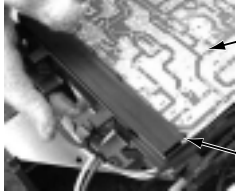
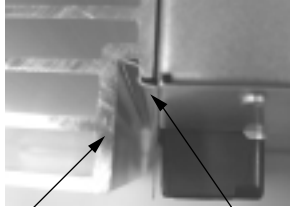
No.	Part name	Procedure	Remarks
②	Discharge port cabinet	<p><b>1. Detachment</b></p> <ol style="list-style-type: none"> <li>1) Perform work of item 1 of ①.</li> <li>2) Take off screws (ST1T Ø4 x 10L, 3 pcs.) of discharge port cabinet for the partition plate.</li> <li>3) Take off screws (ST1T Ø4 x 10L, 2 pcs.) of discharge port cabinet for the bottom plate.</li> <li>4) Take off screw (ST1T Ø4 x 10L, 1 pc.) of discharge port cabinet for the heat exchanger.</li> <li>5) Take off screws (ST1T Ø4 x 10L, 2 pcs.) of discharge port cabinet for the fin guard.</li> </ol> <p><b>2. Attachment</b></p> <ol style="list-style-type: none"> <li>1) Put the upper left side of the discharge port cabinet on the end plate of the heat exchanger, and then fix it with screw. (ST1T Ø4 x 10L, 1 pc.)</li> <li>2) Attach the removed screws to the original positions.</li> </ol>	 <p>Side cabinet Inverter Fin guard</p> <p>End plate of the heat exchanger Discharge port</p>
③	Side cabinet	<ol style="list-style-type: none"> <li>1) Perform work of item 1 of ①.</li> <li>2) Remove screw fixing the inverter and the side cabinet. (ST1T Ø4 x 10, 1 pc.)</li> <li>3) Remove screws of the side cabinet and the valve support plate. (ST1T Ø4 x 10, 2 pcs.)</li> <li>4) Remove screw of the side cabinet and the cabling panel (Rear). (ST1T Ø4 x 10, 1 pc.)</li> <li>5) Remove screw of the side cabinet and the bottom plate. (ST1T Ø4 x 10, 1 pc.)</li> <li>6) Remove screw of the side cabinet and the fin guard (Heat exchanger). (ST1T Ø4 x 10, 2 pcs.)</li> </ol>	 <p>Valve support plate Side cabinet</p> <p>Inverter Side cabinet Valve support plate Cabling panel (Rear)</p>

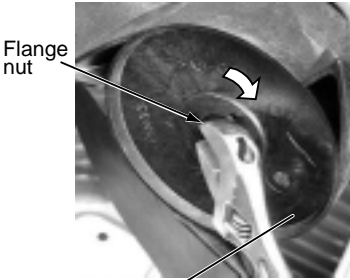
No.	Part name	Procedure	Remarks
④	Inverter assembly	<p>1) Perform works of items of 1) to 5) of ①.</p> <p>2) Take off screw (ST1T Ø4 x 10L, 1 pc.) of the upper left part of the inverter cover.</p> <ul style="list-style-type: none"> <li>• If removing the inverter cover under this condition, P.C. board can be checked.</li> <li>• If there is no space in the upper part of the upper cabinet, perform works of items 6) to 7) of (1) and remove the partition fixing plate. (ST1T Ø4 x 10L, 1 pc.)</li> </ul> <p style="text-align: center;"><b>CAUTION</b></p> <p>Be careful to check the inverter because high-voltage circuit is incorporated in it.</p> <p>3) Perform discharging by connecting the discharging resistance (approx. 100Ω, 40W) or plug of soldering iron to ⊕, ⊖ terminals of the C10 too 13 (printed as "CAUTION HIGH VOLTAGE") electrolytic capacitor (760μF) of P.C. board.</p> <p style="text-align: center;"><b>WARNING</b></p> <p>The electrolytic capacitor may not normally discharge according to error contents and the voltage may remain. Therefore, be sure to discharge the capacitor.</p> <p style="text-align: center;"><b>WARNING</b></p> <p>For discharging, never use a screwdriver and others for short-circuiting between ⊕ and ⊖ electrodes. As the electrolytic capacitor is one with a large capacity, it is very dangerous because a large electric spark will occur.</p> <p>4) Remove various lead wires from the holder at upper part of the inverter box.</p> <p>5) Remove the hook for the partition plate (lower left side).</p> <p>6) Remove the hook for the side cabinet (lower left side) and the screw, and lift up the inverter assembly upward. (ST1T Ø4 x 10L, 1 pc.) In this time, cut off the band bundling each lead wire.</p> <p>7) Disconnect connectors of various lead wires.</p> <p style="text-align: center;"><b>REQUIREMENT</b></p> <p>As each connector has a lock mechanism, avoid to remove the connector by holding the lead wire, but by holding the connector.</p>	    

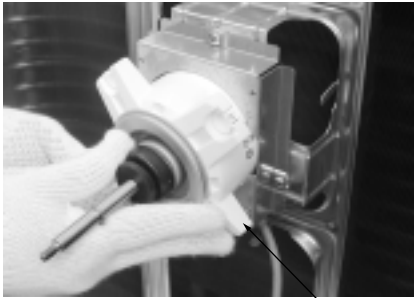
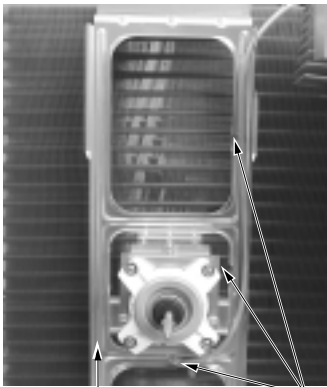
No.	Part name	Procedure	Remarks
⑤	Control P.C. board assembly	<p>1) Remove the inverter box from P.C. board base.</p> <p>2) Disconnect lead wires and connectors connected from the control P.C. board assembly to other parts.</p> <p>1. Lead wires:            With the power terminal block: 2 pcs.            (Single phase) (Red, White)            With the compressor: 3 pcs.            (Red, White, Black)</p> <p>2. Connectors            CN301 : Outdoor fan (3P, White) <b>*Note 1)</b>            CN300 : Position detection (5P, White)            CN700 : 4-way valve (3P, Yellow) <b>*Note 1)</b>            CN702 : PMV coil (6P, White)            CN600 : TD sensor (3P, White)            CN605 : TS sensor (3P, White) <b>*Note 1)</b>            CN604 : TE sensor (2P, White) <b>*Note 1)</b>            CN601 : TO sensor (2P, White)            CN02 : Indoor/Outdoor connecting terminal block (2P, Black)            CN500 : Case thermo (2P, White) <b>*Note 1)</b>            CN14, CN15 : Reactor (3P, Relay connector, Blue) <b>*Note 1)</b></p> <p><b>*Note 1)</b>            Remove the connector while releasing locking of the housing.</p> <p>3) Remove the control P.C. board assembly from P.C. board base. (Remove the heat sink and the inverter control P.C. board assembly as they are screwed.)</p> <p><b>Note 2)</b>            Remove the heat sink upward by taking off two claws of P.C. base and holding the heat sink.</p> <p>4) Take off three screws fixing the heat sink to the control P.C. board assembly.</p> <p>5) Mount a new control P.C. board assembly.</p> <p><b>Note 3)</b>            When mounting a new board, check that it is correctly set in the groove of the base holder of P.C. board base.</p>	 <p>Inverter box (Metal sheet)</p> <p>P.C. board base</p>  <p>Cycle control P.C. board assembly</p> <p>Inverter control P.C. board assembly</p>  <p>Cycle control P.C. board assembly</p>  <p>Inverter control P.C. board assembly</p>  <p>Inverter control P.C. board assembly</p> <p>Groove for P.C. board</p>  <p>Heat sink</p> <p>Inverter box (Metal sheet)</p>

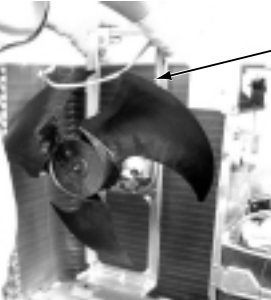
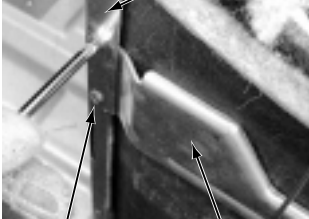

No.	Part name	Procedure	Remarks
⑥	Fan motor	<p>1) Perform works of items 1) to 5), 7) of ①</p> <p>2) Remove the flange nut fixing the fan motor and the propeller fan.</p> <ul style="list-style-type: none"> <li>• Loosen the flange nut by turning clockwise. (To tighten the flange nut, turn it counterclockwise.)</li> </ul> <p>3) Remove the propeller fan.</p> <p>4) Remove the lead wire from the hook fixing the fan motor lead wires on the motor base. (Three positions)</p> <p>5) Disconnect the connector for fan motor from the inverter.</p> <p>6) Take off the fixing screws (4 pcs.) while holding by hands so that the fan motor does not fall.</p> <p><b>NOTE :</b> Tighten the flange nut with torque 9.8Nm (100kgf/cm).</p>	 <p>Flange nut</p> <p>Loosen by turning clockwise</p>  <p>Propeller fan</p>  <p>Fan motor</p>  <p>Motor base</p> <p>Fixing claws for fan motor lead wires (3 positions)</p>

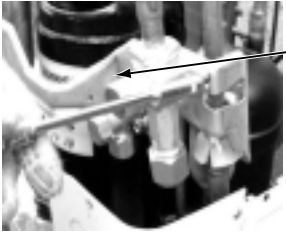
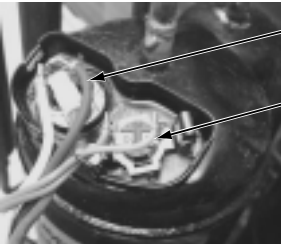
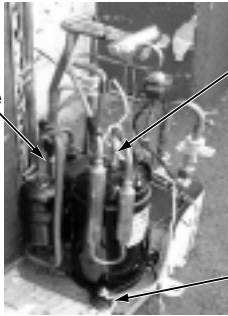

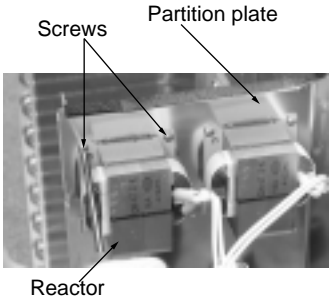
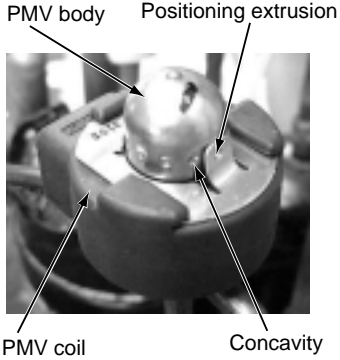
No.	Part name	Procedure	Remarks
⑦	Compressor	<ol style="list-style-type: none"> <li>1) Perform works of items ①, ②, ③, ④, and ⑤.</li> <li>2) Evacuate refrigerant gas.</li> <li>3) Disconnect the connector for fan motor from the inverter.</li> <li>4) Take off screws fixing the motor base to the bottom plate. (ST1T Ø4 x 10L, 2 pcs.)</li> <li>5) Remove the motor base together with the fan motor and the propeller fan.</li> <li>6) Take off screws fixing the partition plate to the valve support plate. (ST1T Ø4 x 10L, 2 pcs.)</li> <li>7) Remove the valve support plate. (M6 x 4 pcs.)</li> <li>8) Take off screws of the partition plate and the bottom plate. (ST1T Ø4 x 10L, 2 pcs.)</li> <li>9) Take off screws of the partition plate and the heat exchanger. (ST1T Ø4 x 10L, 2 pcs.)</li> <li>10) Remove the noise-insulator.</li> <li>11) Remove the terminal covers of the compressor, and disconnect lead wires of the compressor and the compressor thermo assembly from the terminal.</li> <li>12) Remove pipes connected to the compressor with a burner.</li> </ol> <div style="border: 1px solid black; border-radius: 10px; padding: 5px; margin: 10px 0; text-align: center;"> <p><b>CAUTION</b></p> <p>Pay attention to that flame does not involve 4-way valve or PMV. (If doing so, a malfunction may be caused.)</p> </div> <ol style="list-style-type: none"> <li>13) Pull the refrigerating cycle upward.</li> <li>14) Take off nut fixing the compressor on the bottom plate. (3 pcs.)</li> <li>15) Pull the compressor toward you.</li> </ol> <div style="border: 1px solid black; border-radius: 10px; padding: 5px; margin: 10px 0; text-align: center;"> <p><b>CAUTION</b></p> <p>When reconnecting the lead wires to the compressor terminals after replacement of the compressor, be sure to caulk the Faston terminal without loosening.</p> </div>	 <p>Motor base</p>  <p>Partition plate</p>  <p>Screw Valve support</p>  <p>Partition plate</p>  <p>Valve support</p>  <p>Compressor lead wire Case thermo</p>  <p>Remove (Suction pipe) Remove (Discharge pipe) Compressor nut (3 pcs.)</p>

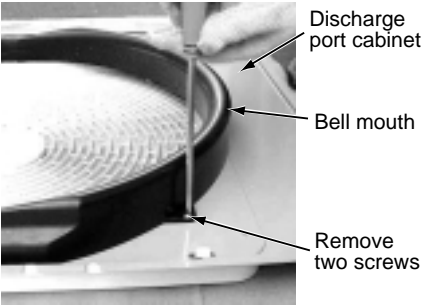
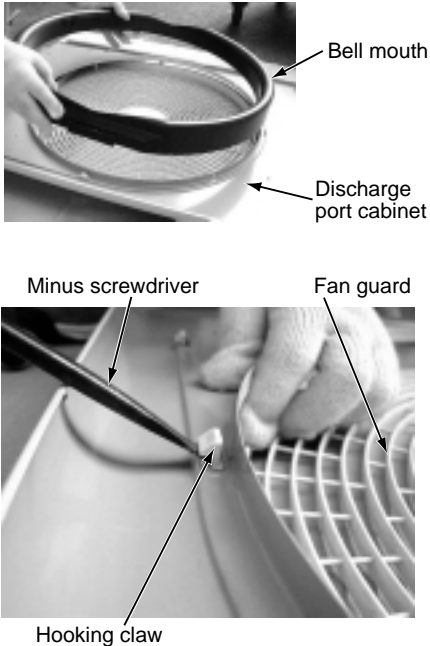
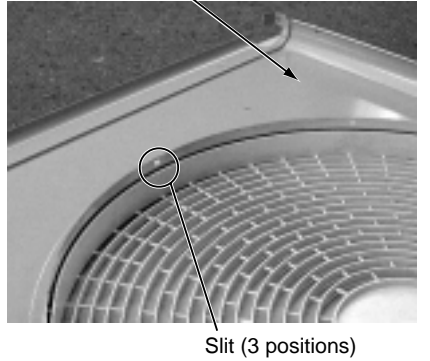
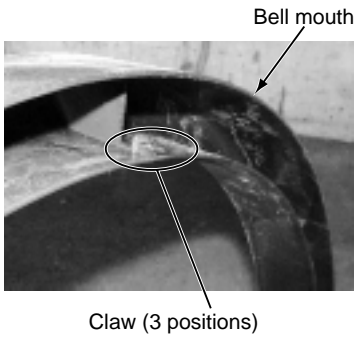
No.	Part name	Procedure	Remarks
⑧	Reactor	1) Perform works of items 1 of ① and ④. 2) Take off screws fixing the reactor. (Ø4 x 10L , 2 pcs. per one reactor. An outdoor unit has two reactors on the partition plate.)	
⑨	Pulse Modulating Valve (PMV) coil	<b>1. Detachment</b> 1) Perform works of items 1 of ① and ③. 2) Remove the coil from PMV body while pulling it upward.  <b>2. Attachment</b> 1) Match the positioning extrusion of the coil surely to the concavity of PMV body to fix it.	

No.	Part name	Procedure	Remarks
⑩	Fan guard	<p><b>1. Detachment</b></p> <p>1) Perform works of items 1 of ① and ④.</p> <p>2) Remove the air flow cabinet, and put it down so that the fan guard side directs downward.</p> <div data-bbox="416 412 944 528" style="border: 1px solid black; padding: 5px; margin: 10px 0;"> <p><b>Perform work on a corrugated cardboard, cloth, etc. to prevent flaw to the product.</b></p> </div> <p>3) Take off screws fixing the bell mouth. (ST1Tf4 x 10L, 2 pcs.)</p> <p>4) Remove the bell mouth.</p> <p>5) Remove the hooking claws by pushing with minus screwdriver along with the arrow mark as shown in right figure.</p> <p><b>2. Attachment</b></p> <p>1) Insert claw of the fan guard in hole of the discharge panel. Push the hooking claws (5 positions) with hands and fix the claws.</p> <div data-bbox="416 927 944 1077" style="border: 1px solid black; padding: 5px; margin: 10px 0;"> <p><b>After all the attachment works are completed, check that all the hooking claws are fixed to the specified positions.</b></p> </div> <p>2) Mount the bell mouth by hooking three claws at upper side of the bell mouth in the slits on the discharge cabinet.</p> <p>3) After attachment, fix the bell mouth with screws. (ST1Tf4 x 10L, 2 pcs.)</p>	   

No.	Part name	Procedure	Remarks
①	Common procedure	<div style="border: 1px solid black; border-radius: 15px; padding: 5px; text-align: center; margin-bottom: 10px;"> <b>REQUIREMENT</b> </div> <p>Before works, put on gloves, otherwise an injury may be caused by parts, etc.</p> <p><b>1. Detachment</b></p> <ol style="list-style-type: none"> <li>1) Stop operation of the air conditioner, and turn off switch of the breaker.</li> <li>2) Remove the front panel. (ST1T Ø4 × 10, 3 pcs.)                             <ul style="list-style-type: none"> <li>• After removing the screws, remove the front panel while drawing it downward.</li> </ul> </li> <li>3) Remove the power cable and the indoor/outdoor connecting cable from cord clamp and terminal.</li> <li>4) Remove the roof plate. (ST1T Ø4 × 10, 6 pcs.)</li> </ol> <p><b>2. Attachment</b></p> <ol style="list-style-type: none"> <li>1) Mount the roof plate. (ST1T Ø4 × 10, 6 pcs.)</li> <li>2) Connect the power cable and the indoor/outdoor connecting cable to terminal, and then fix them with cord clamp.</li> </ol> <div style="border: 1px solid black; border-radius: 15px; padding: 5px; text-align: center; margin-top: 10px;"> <b>REQUIREMENT</b> </div> <p>Be sure to fix the power cable and the indoor/outdoor connecting cable with bundling band on the market along the inter-unit cable so that they do not come to contact with the compressor, the valve and the cable at gas side, and the discharge pipe.</p> <ol style="list-style-type: none"> <li>3) Attach the front panel. (ST1T Ø4 × 10, 3 pcs.)</li> </ol>	<p style="text-align: center;">Front panel</p>   <p style="text-align: center;">Roof plate</p> 

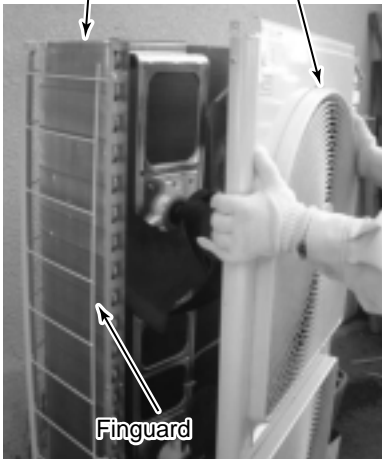
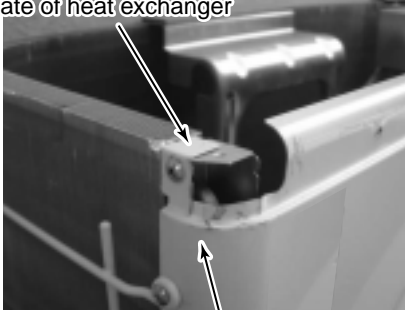
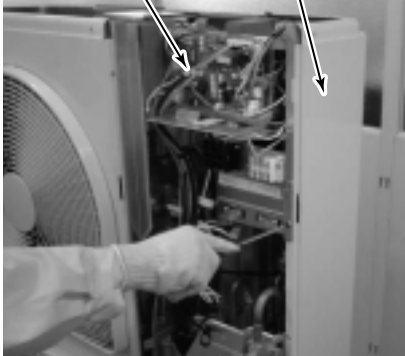
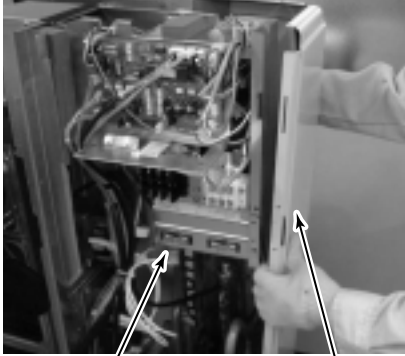

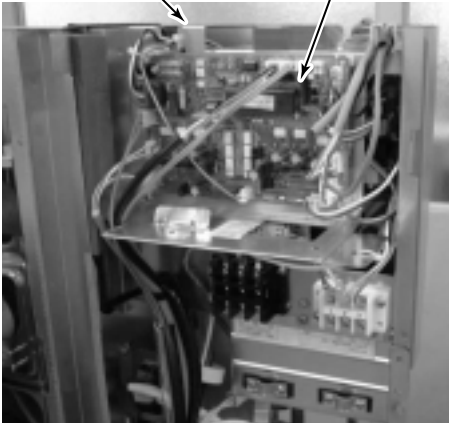
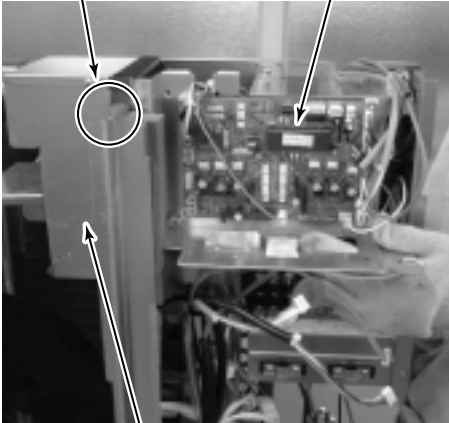

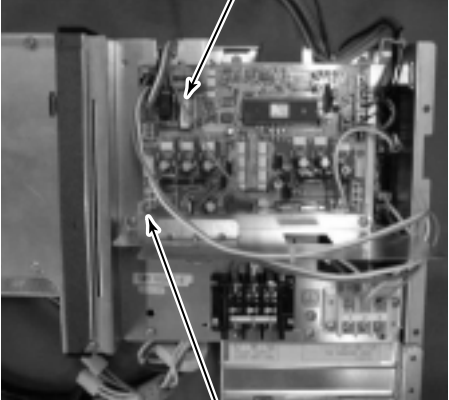
No.	Part name	Procedure	Remarks
②	Air-outlet cabinet	<p><b>1. Detachment</b></p> <ol style="list-style-type: none"> <li>1) Perform the work in 1 of ①.</li> <li>2) Take off screws for the air-outlet cabinet and the partition plate. (ST1T Ø4 × 10, 3 pcs.)</li> <li>3) Take off screws for the air-outlet cabinet and the base plate. (ST1T Ø4 × 10, 2 pcs.)</li> <li>4) Take off screw for the air-outlet cabinet and the heat exchanger. (ST1T Ø4 × 10, 1 pc.)</li> <li>5) Take off screws for the air-outlet cabinet and the fin guard. (ST1T Ø4 × 10, 2 pcs.)</li> </ol> <p><b>2. Attachment</b></p> <ol style="list-style-type: none"> <li>1) Put the upper left side of the air-outlet cabinet on the end plate of heat exchanger, and fix it with screw. (ST1T Ø4 × 10, 1 pc.)</li> <li>2) Attach the taken-off screws to the original positions.</li> </ol>	<p>Heat exchanger      Air-outlet cabinet</p>  <p>Finguard</p> <p>Upper side of the end plate of heat exchanger</p>  <p>Air-outlet cabinet</p>
③	Side cabinet	<ol style="list-style-type: none"> <li>1) Perform the work in 1 of ①.</li> <li>2) Take off screws fixing the inverter and the side cabinet. (ST1T Ø4 × 10, 2 pcs.)</li> <li>3) Take off screws for the side cabinet and the valve fixed plate. (ST1T Ø4 × 10, 2 pcs.)</li> <li>4) Take off screw for the side cabinet and the piping panel (Rear). (ST1T Ø4 × 10, 1 pc.)</li> <li>5) Take off screw for the side cabinet and the base plate. (ST1T Ø4 × 10, 1 pc.)</li> <li>6) Take off screws for the side cabinet and the fin guard. (ST1T Ø4 × 10, 4 pcs.)</li> </ol>	<p>Inverter      Side cabinet</p>   <p>Valve fixed plate      Side cabinet</p>

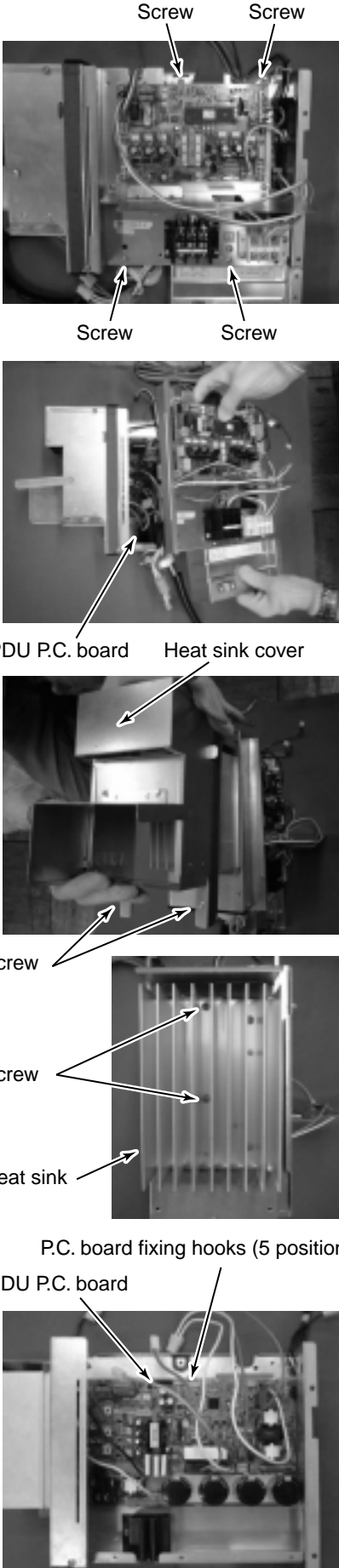
No.	Part name	Procedure	Remarks
④	Inverter assembly	<p>1) Perform the works in 1 of ① and ③.</p> <p>2) Remove connectors which are connected from the cycle P.C. board to other parts.</p> <p>CN600: TD sensor (3P: White)</p> <p>CN601: TO sensor (2P: White)</p> <p>CN604: TE sensor (2P: White) *(Note 1)</p> <p>CN605: TS sensor (3P: White) *(Note 1)</p> <p>CN301: Upper outdoor fan (3P: White) *(Note 1)</p> <p>CN300: Detection of upper position (5P: White)</p> <p>CN303: Lower outdoor fan (3P: White) *(Note 1)</p> <p>CN302: Detection of lower position (5P: White)</p> <p>CN500: Case thermo. (2P: White) *(Note 1)</p> <p>CN700: 4-way valve (3P: Yellow) *(Note 1)</p> <p>CN702: PMV (Pulse Motor Valve) coil (6P: White)</p> <p>Relay connector: Reactor 2 pcs. (3P: White) *(Note 1)</p> <p>Compressor lead: Remove terminal cover of the compressor, and remove the lead wire from terminal of the compressor.</p> <p><b>*(Note 1)</b> Remove the connectors by releasing lock of the housing.</p> <p>3) Remove various lead wires from the holder at upper part of the inverter.</p> <p>4) Cut off tie lap which fixes various lead wires to the inverter assembly.</p> <p>5) Lift up the hook (upper left) with the partition plate upward just removing.</p> <p>* Caution to mount the inverter assembly Mount the inverter assembly to the partition plate so that hooks of the heat sink cover do not come near the partition plate but also near the fan side.</p>	<p>Inverter assembly      Cycle P.C. board</p>  <p>Hooks of heat sink cover (2 positions)      Inverter assembly</p>  <p>Heat sink cover</p>

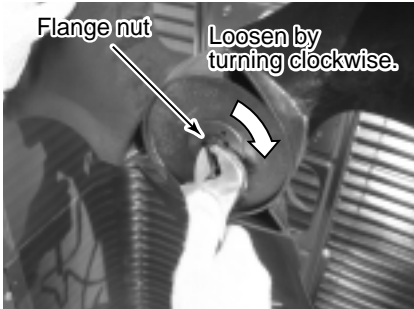

No.	Part name	Procedure	Remarks
⑤	Cycle P.C. board	<p>1) Perform the works in 1 of ① and ③.</p> <p>2) Remove connectors and lead wires which are connected from the cycle P.C. board to other parts.</p> <p>1. Connector</p> <p>CN800: Connection with IPDU P.C. board (5P: Red)</p> <p>CN01: Connection with IPDU P.C. board (5P: Red) *(Note 1)</p> <p>CN02: Indoor/Outdoor connection terminal block (3P: Black) *(Note 1)</p> <p>CN03: Connection with IPDU P.C. board (3P: White) *(Note 1)</p> <p>CN04: Connection with IPDU P.C. board (2P: White) *(Note 1)</p> <p><b>*(Note 1)</b> Remove the connectors by releasing lock of the housing.</p> <p>3) Remove the supporting hooks at 4 corners to remove the cycle P.C. board.</p> <p>4) Mount a new cycle P.C. board.</p> <p>5) Lift up the hook (upper left) with the partition plate upward just removing.</p>	<p>Cycle control P.C. board assembly</p>  <p>P.C. board fixing hooks (4 positions)</p>

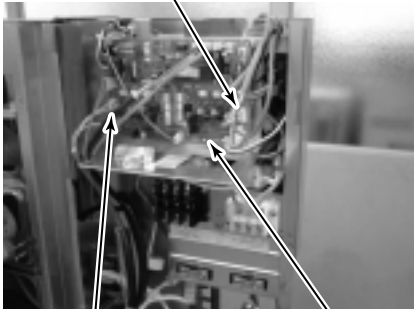
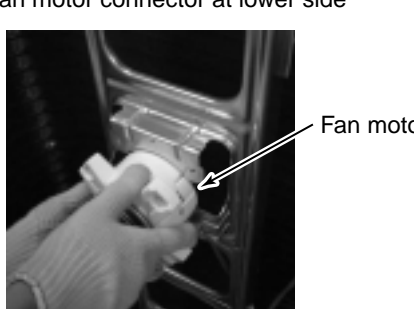
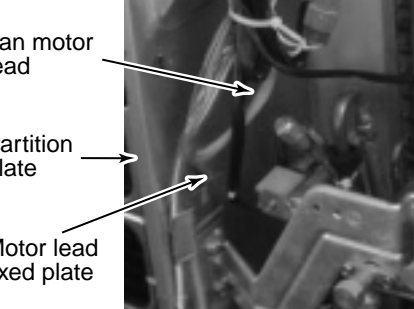
No.	Part name	Procedure	Remarks
⑥	IPDU P.C. board	<p>1) Perform the works in ④ and ⑤.</p> <p>2) Take off screws of the inverter assembly to separate the inverter assembly. (M4 × 8, 4 pcs)</p> <p>3) Remove the connectors and the lead wires which are connected from IPDU P.C. board to the other parts.</p> <p>1. Connector</p> <p>CN04: Connection with cycle P.C. board (3P: White)</p> <p>CN05: Connection with cycle P.C. board (2P: White) *(Note 1)</p> <p>CN06: Connection with cycle P.C. board (5P: White)</p> <p>CN13: Connection with cycle P.C. board (5P: Red) *(Note 1)</p> <p>CN600: Heat sink sensor (2P: Black)</p> <p>2. Lead wire</p> <p>CN01: Connection with power terminal block (Red)</p> <p>CN02: Connection with power terminal block (White)</p> <p>CN03: Connection with inverter box (Black)</p> <p>CN09: Connection with compressor (Red)</p> <p>CN10: Connection with compressor (White)</p> <p>CN11: Connection with compressor (Black)</p> <p>Rectifier diode</p> <p>⊕ : Red lead wire *Note 2</p> <p>⊖ : White lead wire *Note 2</p> <p>⊘ : Orange lead wire</p> <p>(Top)</p> <p>⊘ : Brown lead wire</p> <p>(Bottom)</p> <p><b>*(Note 1)</b> Remove the connectors by releasing lock of the housing.</p> <p>4) Remove the heat sink cover. (M4 × 8, 2pcs)</p> <p>5) Take off two screws which fix the heat sink and IGBT and also take off support hooks of the P.C. board (5 positions) to remove IPDU P.C. board.</p> <p>6) Mount a new IPDU P.C. board.</p> <p><b>*(Note 2)</b> The rectifier diode has polarity, so be careful to ⊕ and ⊖. If ⊕ and ⊖ are mistaken, a trouble is caused.</p>	 <p>Screw Screw</p> <p>Screw Screw</p> <p>IPDU P.C. board Heat sink cover</p> <p>Screw</p> <p>Screw</p> <p>Heat sink</p> <p>P.C. board fixing hooks (5 positions)</p> <p>IPDU P.C. board</p>

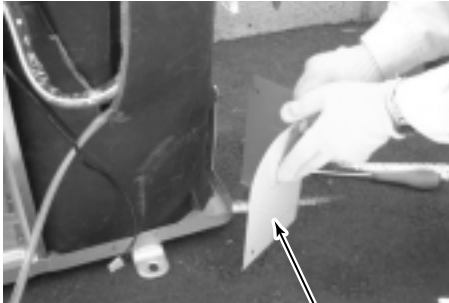
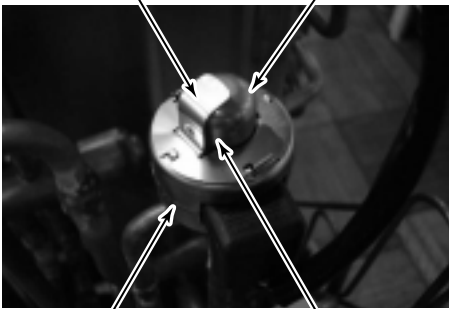

No.	Part name	Procedure	Remarks
⑦	Fan motor	<p>1) Perform the works in 1 of ① and 1 of ②.</p> <p>2) Take off flange nut fixing the fan motor with the propeller fan.</p> <ul style="list-style-type: none"> <li>Loosen the flange nut by turning clockwise. (When tightening, turn it counter-clockwise.)</li> </ul> <p>3) Remove the propeller fan.</p> <p>4) Remove connector for the fan motor from the inverter.</p> <p>5) Take off fixing screws (4 pcs) with supporting the fan motor so that it does not fall down.</p> <p>6) When replacing the fan motor at lower side, remove the motor lead fixed plate which is fixed to the partition plate with screw (ST1Tf4'10, 1 pc), pull the fan motor lead out of the partition plate, and then remove the fan motor.</p> <p><b>* Cautions in assembling fan motor</b></p> <p><b>&lt;In case of RAV-SM1100AT-E&gt;</b></p> <ul style="list-style-type: none"> <li>Be sure to mount the propeller fan and the fan motor at upper and lower sides because they are different.</li> <li>Tighten the flange nut with the following torque. <ul style="list-style-type: none"> <li>Upper side: 9.8N·m (100kgf·cm)</li> <li>Lower side: 4.9N·m (50kgf·cm)</li> </ul> </li> </ul> <p><b>&lt;In case of RAV-SM1400AT-E&gt;</b></p> <ul style="list-style-type: none"> <li>The same propeller fan and the fan motor are used at upper and lower sides.</li> <li>Tighten the flange nut with the following torque. <ul style="list-style-type: none"> <li>Upper side: 9.8N·m (100kgf·cm)</li> <li>Lower side: 9.8N·m (100kgf·cm)</li> </ul> </li> <li>Be sure to mount the motor lead fixed plate so that the fan motor lead is not caught in.</li> <li>Be sure that the propeller fan does not come to contact with the fan motor lead.</li> </ul>	 <p>Flange nut Loosen by turning clockwise.</p>  <p>Propeller fan</p>  <p>Fan motor connector at upper side Cycle P.C. board</p>  <p>Fan motor connector at lower side Cycle P.C. board</p>  <p>Fan motor</p>  <p>Fan motor lead Partition plate Motor lead fixed plate</p>

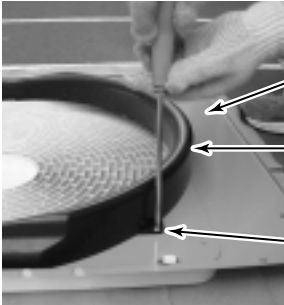
No.	Part name	Procedure	Remarks
⑧	Compressor	<ol style="list-style-type: none"> <li>1) Recover refrigerant gas.</li> <li>2) Perform the works in 1 of ① and in ③.</li> <li>3) Remove the piping panel (Front). Take off screws of the piping panel (Front) and the base plate. (ST1T Ø4 × 10, 2 pcs) Take off screws of the piping panel (Front) and the piping panel (Rear). (ST1T Ø4 × 10, 2 pcs)</li> <li>4) Remove the piping panel (Rear). Take off screws of the piping panel (Rear) and the base plate. (ST1T Ø4 × 10, 2 pcs)</li> <li>5) Remove the sound-insulation plate.</li> <li>6) Remove terminal cover of the compressor, and then remove compressor lead and case thermo. of the compressor. (ST1T Ø4 × 10, 2 pcs)</li> <li>7) Remove TD sensor fixed to the discharge pipe.</li> <li>8) Using a burner, remove pipe connected to the compressor.</li> </ol> <div style="border: 1px solid black; padding: 5px; margin: 10px 0;"> <p><b>NOTE)</b> Pay attention that 4-way valve or PMV is not exposed to a flame. (Otherwise, a malfunction may be caused.)</p> </div> <ol style="list-style-type: none"> <li>9) Pull out discharge pipe and suction pipe of the refrigerating cycle upward.</li> <li>10) Take off the compressor nuts (3 pcs) fixing the compressor to the base plate.</li> <li>11) Draw out the compressor toward you.</li> </ol>	 <p>Piping panel (Front)</p> <p>Piping panel (Rear)</p> <p>Remove (Suction pipe)</p> <p>Remove (Discharge pipe)</p> <p>TD sensor</p> <p>Case thermo.</p> <p>Compressor lead</p> <p>Compressor nuts (3 pcs)</p>
⑨	PMV coil	<ol style="list-style-type: none"> <li><b>1. Detachment</b></li> <li>1) Perform the works in 1 of ① and in ③.</li> <li>2) Hold outside of the coil by hands and turn it while lifting upward. The fixing hooks come off the fixing concavities and then the coil can be removed from PMV body.</li> <li><b>2. Attachment</b></li> <li>1) Match the positioning extrusion of the coil surely to the concave part of PMV body, and then fix it.</li> </ol>	 <p>Positioning extrusion</p> <p>PMV body</p> <p>PMV coil</p> <p>Concave part</p>

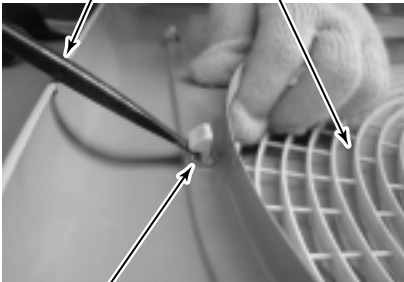
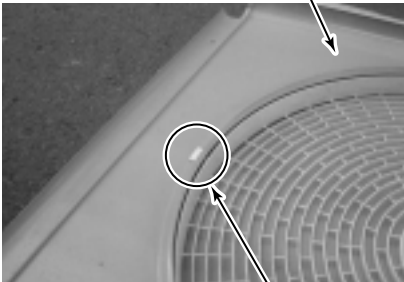
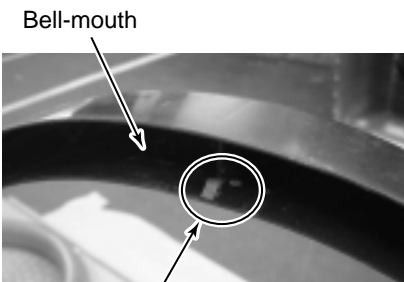
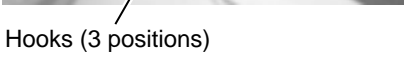
No.	Part name	Procedure	Remarks
⑩	Fan guard	<p><b>1. Detachment</b></p> <p>1) Perform the works in 1 of ① and in 1 of ②.</p> <div data-bbox="416 331 946 477" style="border: 1px solid black; padding: 5px; margin: 10px 0;"> <p style="text-align: center;"><b>REQUIREMENT</b></p> <p>To prevent damage on the products, treat component on a corrugated paper, cloth, etc.</p> </div> <p>2) Remove the air-outlet cabinet, and then put down it directing the fan guard side downward.</p> <p>3) Take off screws fixing the bell-mouth. (ST1T Ø4 × 10, 2 pcs)</p> <p>4) Remove the bell-mouth.</p> <p>5) Take off screws fixing the fan guard. (ST1T Ø4 × 10, 2 pcs)</p> <p>6) Remove hanging hook of the fan guard by pushing with a minus screwdriver.</p> <p><b>2. Attachment</b></p> <p>1) Insert the extrusion at the upper side of the fan guard into the square hole of the air-outlet cabinet, and then insert the hanging hook. Fix the hanging hooks (5 positions) by pushing with hands.</p> <div data-bbox="416 1077 946 1196" style="border: 1px solid black; padding: 5px; margin: 10px 0;"> <p style="text-align: center;"><b>REQUIREMENT</b></p> <p>Check that all the hanging hooks are fixed to the specified positions.</p> </div> <p>2) After attachment, fix it with screws. (ST1T Ø4 × 10, 2 pcs)</p> <p>3) Mount the bell-mouth by hanging hooks (3 positions) at upper side of the bell-mouth to the square holes of the air-outlet cabinet.</p> <p>4) After attachment, fix it with screws. (ST1T Ø4 × 10, 2 pcs)</p> <p><b>* Caution in assembling bell-mouth</b></p> <ul style="list-style-type: none"> <li>• The size (color) of the bell-mouth at upper side differs from that at lower side. (Only for RAV-SM1100AT-4C)</li> </ul> <p style="margin-left: 40px;"><b>&lt;In case of RAV-SM1100AT-E&gt;</b></p> <p style="margin-left: 40px;">Upper side: Black Lower side: Gray</p> <p style="margin-left: 40px;"><b>&lt;In case of RAV-SM1400AT-E&gt;</b></p> <p style="margin-left: 40px;">Upper side: Black Lower side: Black</p>	     

## 15. EXPLODED VIEWS AND PARTS LIST

### 15-1. Indoor Unit

#### 15-1-1. Concealed Duct Type

RAV-SM561BT-E

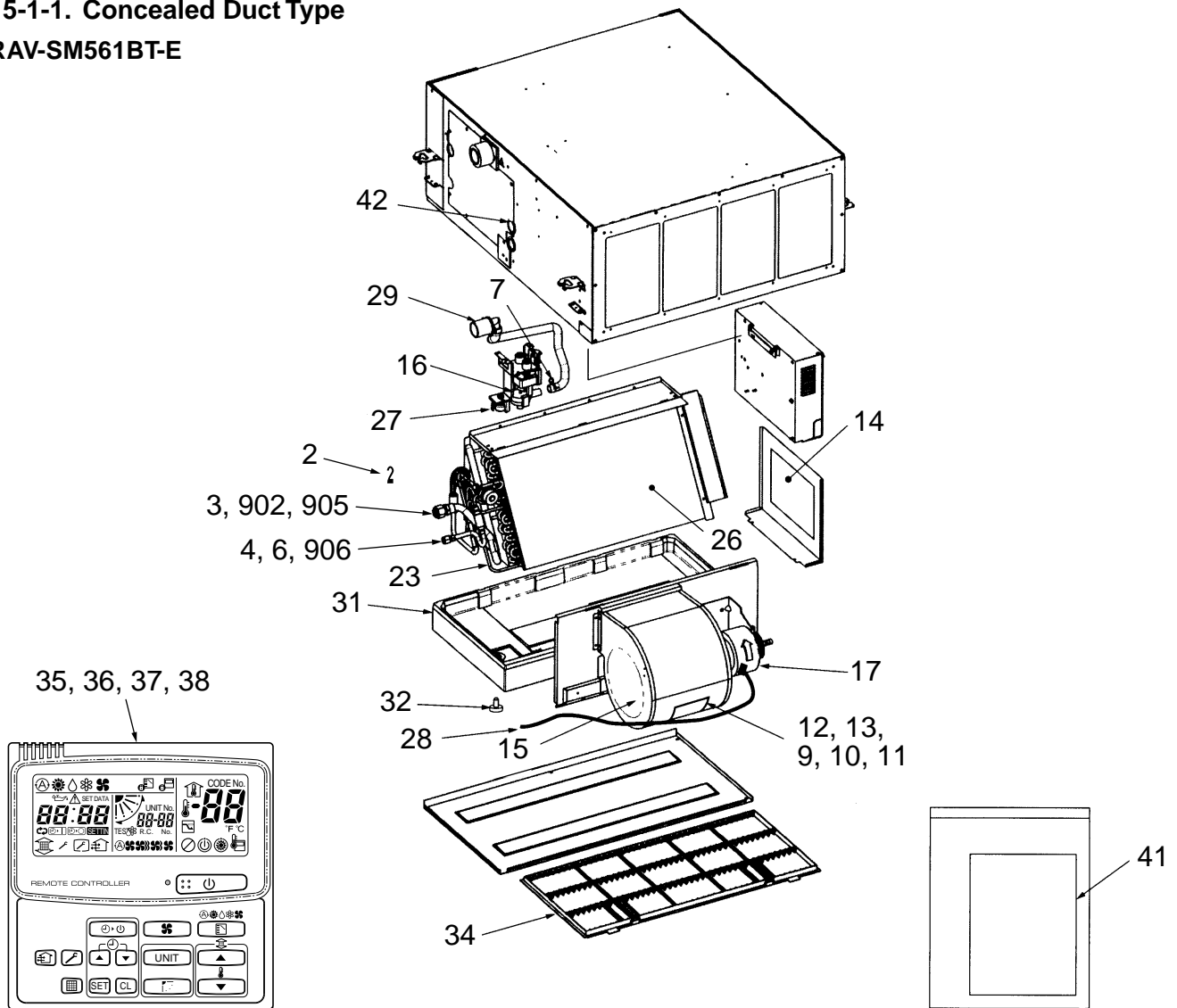

Location No.	Part	Description
2	43019904	Holder, Sensor
3	43047303	Bonnet
4	43047545	Nut, Flare, 1/4 IN
6	43049697	Band, Hose
7	43079249	Band, Hose
15	43120220	Fan, Multi Blade
16	43121713	Pump Ass'y, Drain
17	43121708	Motor, Fan
23	4314J175	Distributor Ass'y
26	4314J182	Refrigeration cycle Ass'y
27	43151281	Switch, Float
28	43160553	Lead, Motor, Fan
29	43170233	Hose, Drain

Location No.	Part	Description
31	43172168	Pan Ass'y, Drain
32	43179110	Plug
34	43180311	Air Filter
35	4316V194	Remote Controller
36	4316V195	Remote Controller
37	4316V196	Remote Controller
38	4316V197	Remote Controller
41	4318T458	Owner's Manual
42	43196012	Bushing
902	43194051	Soket
905	43194081	Nut, Flare, 1/2, IN
906	43194080	Soket

RAV-SM801BT-E

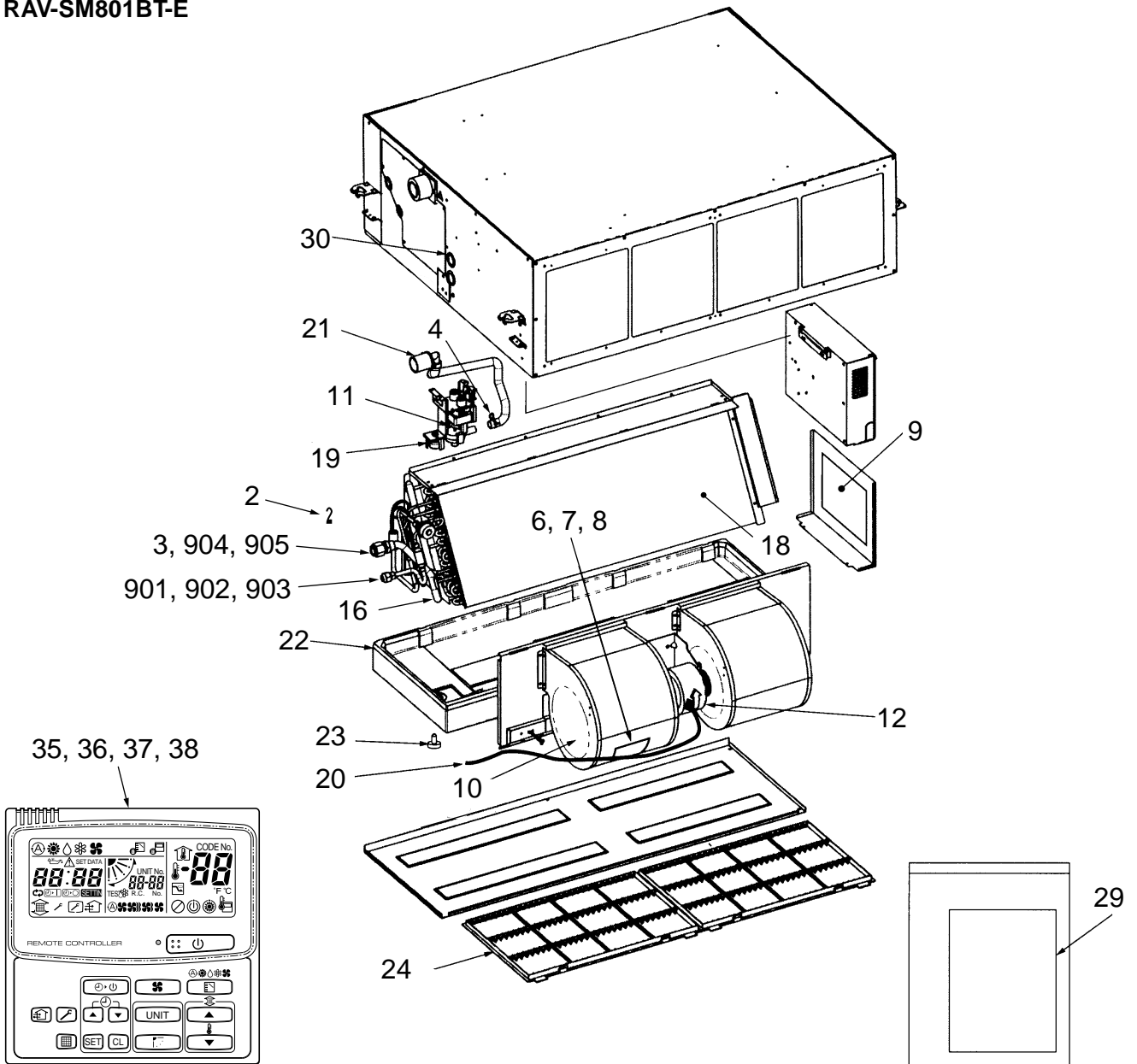

Location No.	Part	Description
2	43019904	Holder, Sensor
3	43047609	Bonnet
4	43079249	Band, Hose
10	43120220	Fan, Multi Blade
11	43121713	Pump Ass'y, Drain
12	43121707	Motor, Fan
16	4314J176	Distributor Ass'y
18	4314J183	Refrigeration cycle Ass'y
19	43151281	Switch, Float
20	43160553	Lead, Motor, Fan
21	43170233	Hose, Drain
22	43172167	Pan Ass'y, Drain
23	43179110	Plug

Location No.	Part	Description
24	43180312	Air Filter
29	4318T458	Owner's Manual
30	43196012	Bushing
35	4316V194	Remote Controller
36	4316V195	Remote Controller
37	4316V196	Remote Controller
38	4316V197	Remote Controller
901	43194026	Soket
902	43194029	Bonnet
903	43194055	Nut, Flare, 3/8, IN
904	43194078	Nut, Flare, 5/8, IN
905	43194079	Soket

RAV-SM1001BT-E / SM1401BT-E

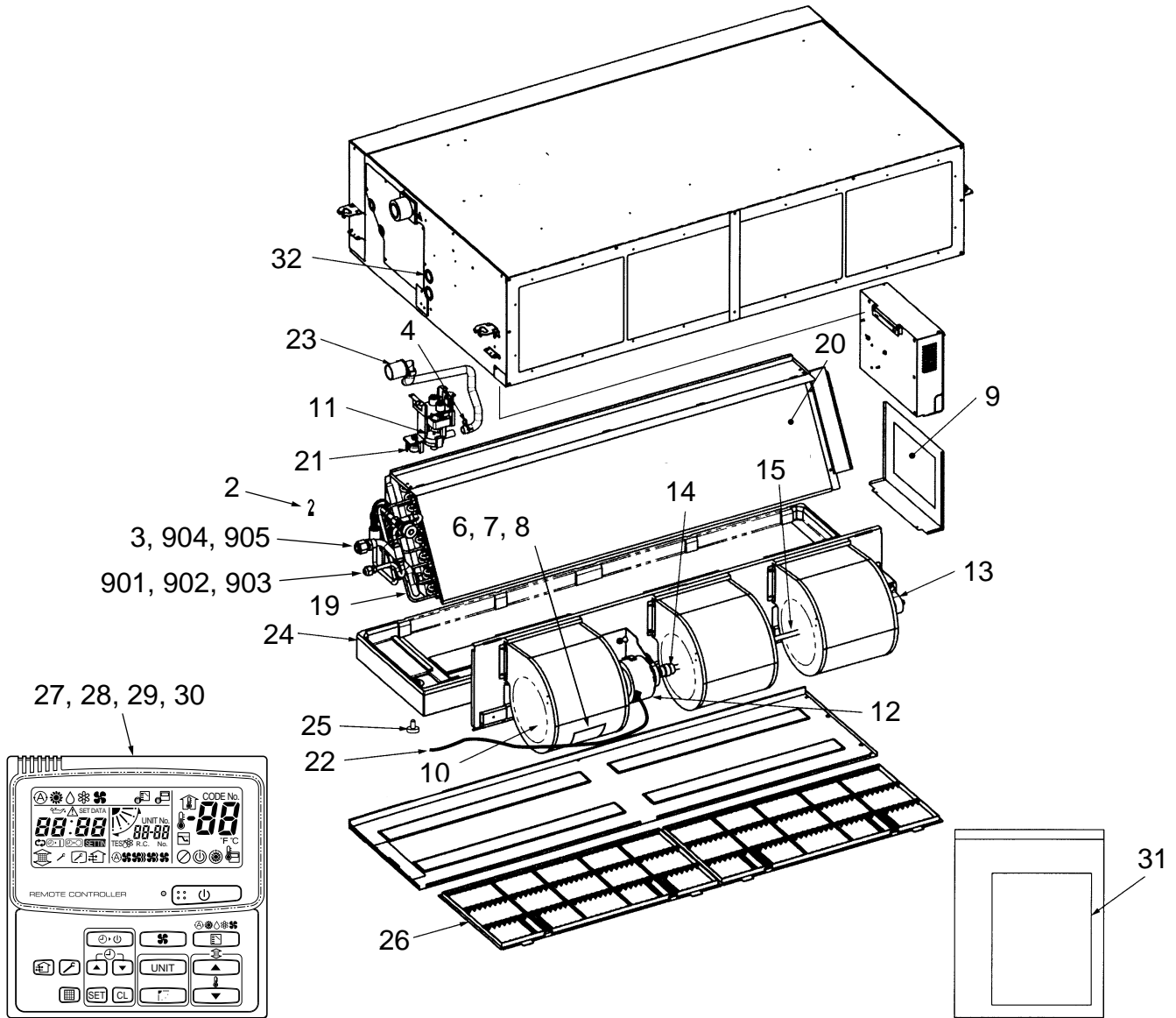

Location No.	Part	Description
2	43019904	Holder, Sensor
3	43047609	Bonnet
4	43079249	Band, Hose
10	43120220	Fan, Multi Blade
11	43121713	Pump Ass'y, Drain
12	43121708	Motor, Fan
13	43125135	Bearing, Shaft
14	43125155	Coupling
15	43125156	Shaft
19	4314J177	Distributor Ass'y
20	4314J184	Refrigeration cycle Ass'y
21	43151281	Switch, Float
22	43160553	Lead, Motor, Fan
23	43170233	Hose, Drain

Location No.	Part	Description
24	43172166	Pan Ass'y, Drain
25	43179110	Plug
26	43180311	Air Filter
27	4316V194	Remote Controller
28	4316V195	Remote Controller
29	4316V196	Remote Controller
30	4316V197	Remote Controller
31	4318T458	Owner's Manual
32	43196012	Bushing
901	43194026	Soket
902	43194029	Bonnet
903	43194055	Nut, Flare, 3/8, IN
904	43194078	Nut, Flare, 5/8, IN
905	43194079	Soket

RAV-SM561BT-E / SM801BT-E / SM1001BT-E / SM1401BT-E

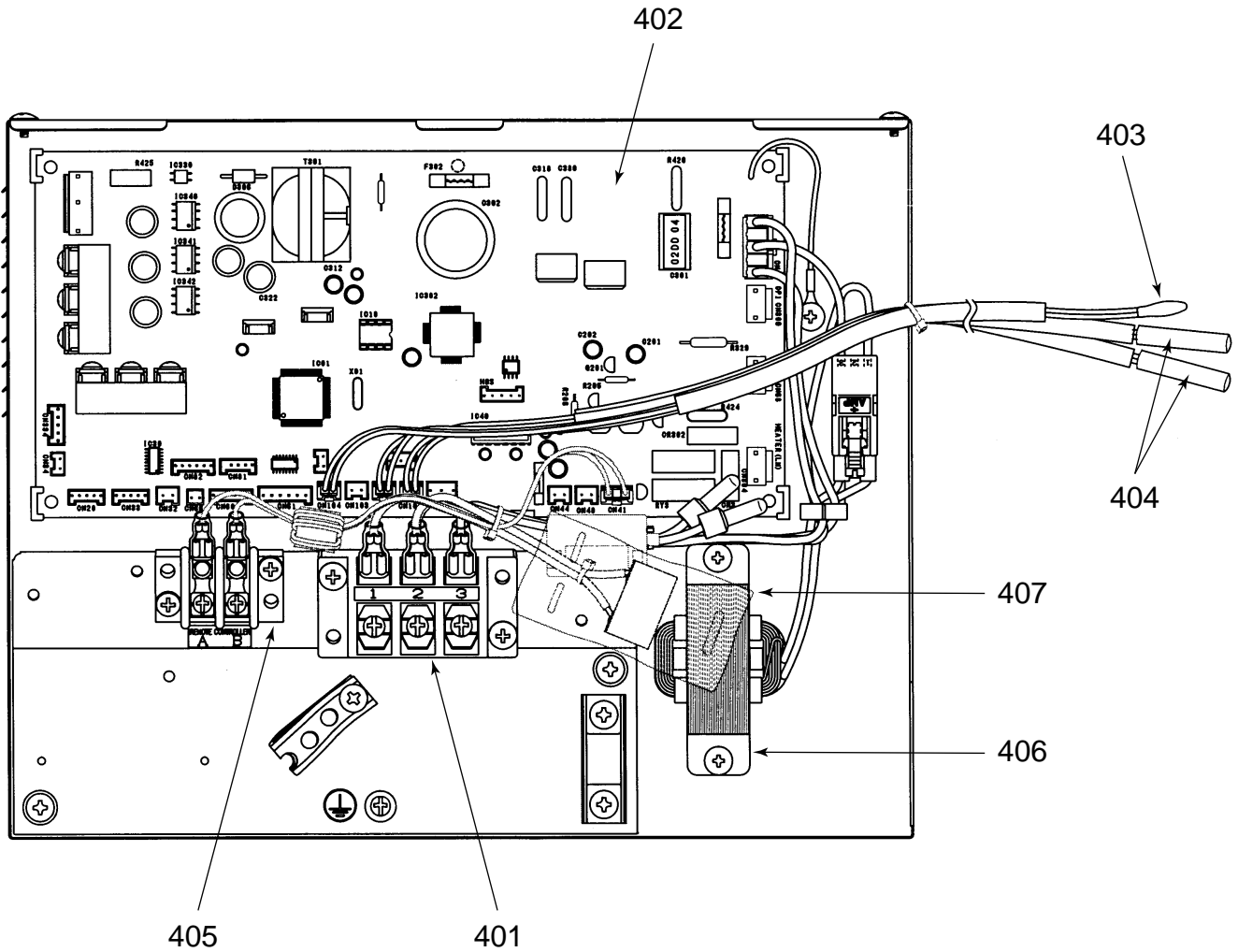

Location No.	Part	Description
401	43060750	Terminal Block, 3P
402	4316V226	P.C. Board Ass'y, MMC-1402
403	43050382	Sensor, TC (F6)
404	43150297	Sensor, TC

Location No.	Part	Description
405	43160445	Terminal Block, 2P
406	43158184	Reactor
407	43155212	Capacitor

## 15-2. Outdoor Unit

RAV-SM560AT-E

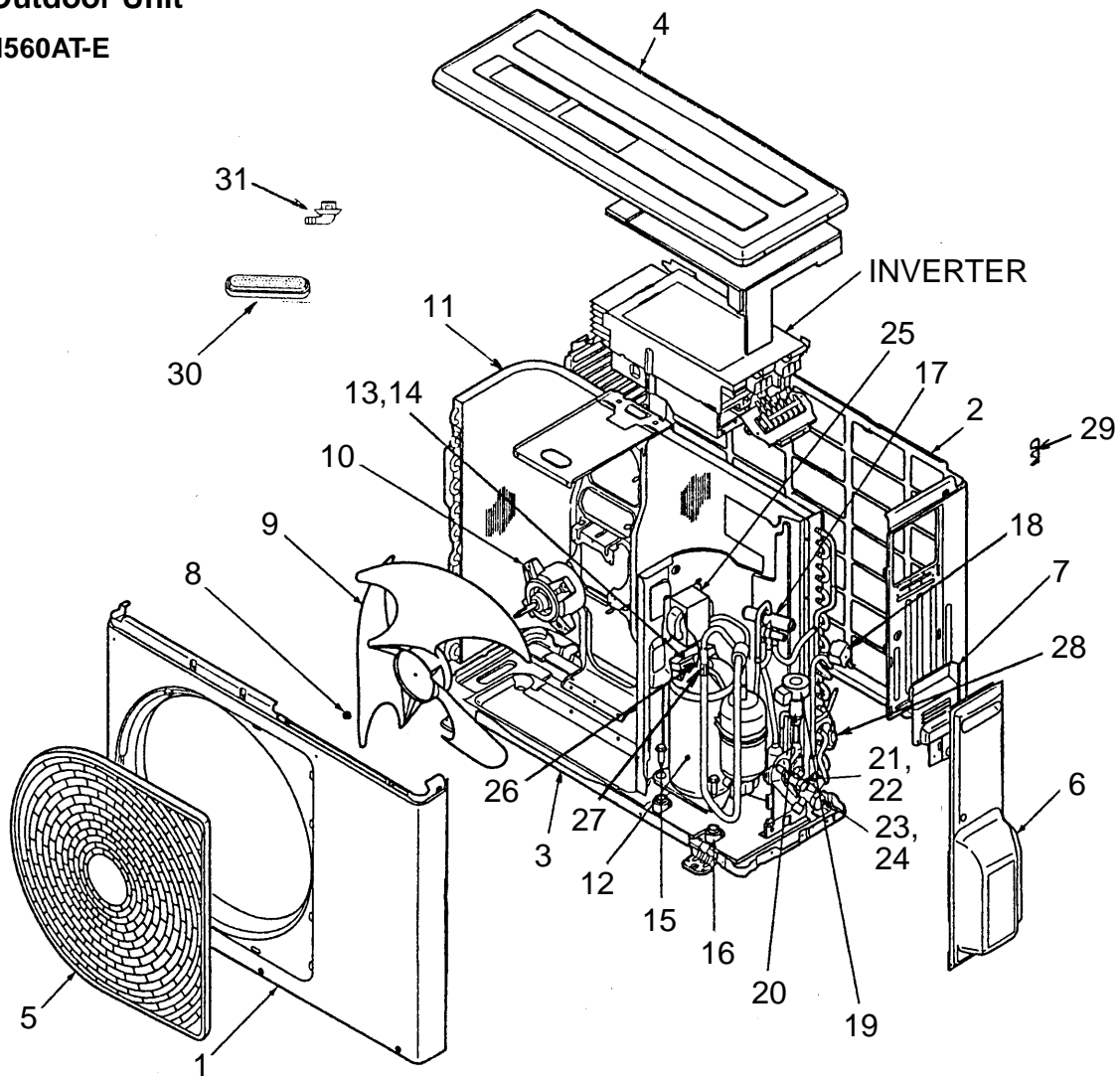

Location No.	Part	Description
1	43105037	Cabinet, Front, PCM
2	43100239	Cabinet, Back, PCM
3	43042468	Base, Ass'y
4	43005508	Cabinet, UP, PCM
5	43119460	Guard, Fan, PP
6	43119448	Cover, Packed, Valve
7	43062230	Cover, Wiring, Ass'y
8	43047667	Nut, Flange
9	43020329	Fan, Propeller, PJ421
10	4302C033	Motor, Fan, ICF-140-43-1
11	4314G128	Condenser, Ass'y
12	43041609	Compressor, DA130A1F-23F
13	43050407	Thermostat, Bimetal
14	43063317	Holder, Thermostat
15	43097206	Bolt, Compressor, M6
16	43049749	Rubber, Cushion
17	43046363	Valve, 4-WAY, VT7101D

Location No.	Part	Description
18	43146617	Solenoid, Coil, LB64045
19	43046385	Valve, Pulse, Modulating, SKV-18D26
20	43046394	Coil, PMV, DKV-MOZS744BO
21	43046392	Valve, Packed, 6.35, AO
22	43147195	Bonnet, 1/2 IN
23	43046393	Valve, Packed, 12.7, HKU-R410A-H4
24	43147196	Bonnet, 1/4 IN, 6.4 CU
25	43055521	Reactor, CH-57
26	43063321	Holder, Sensor, 4-8, 9.52
27	43063322	Holder, Sensor, 6-11.4, 12.7
28	43063325	Holder, Sensor, 6-6.35, 8
29	43063332	Holder, Sensor
30	43089160	Cap, Waterproof
31	43032441	Nipple, Drain



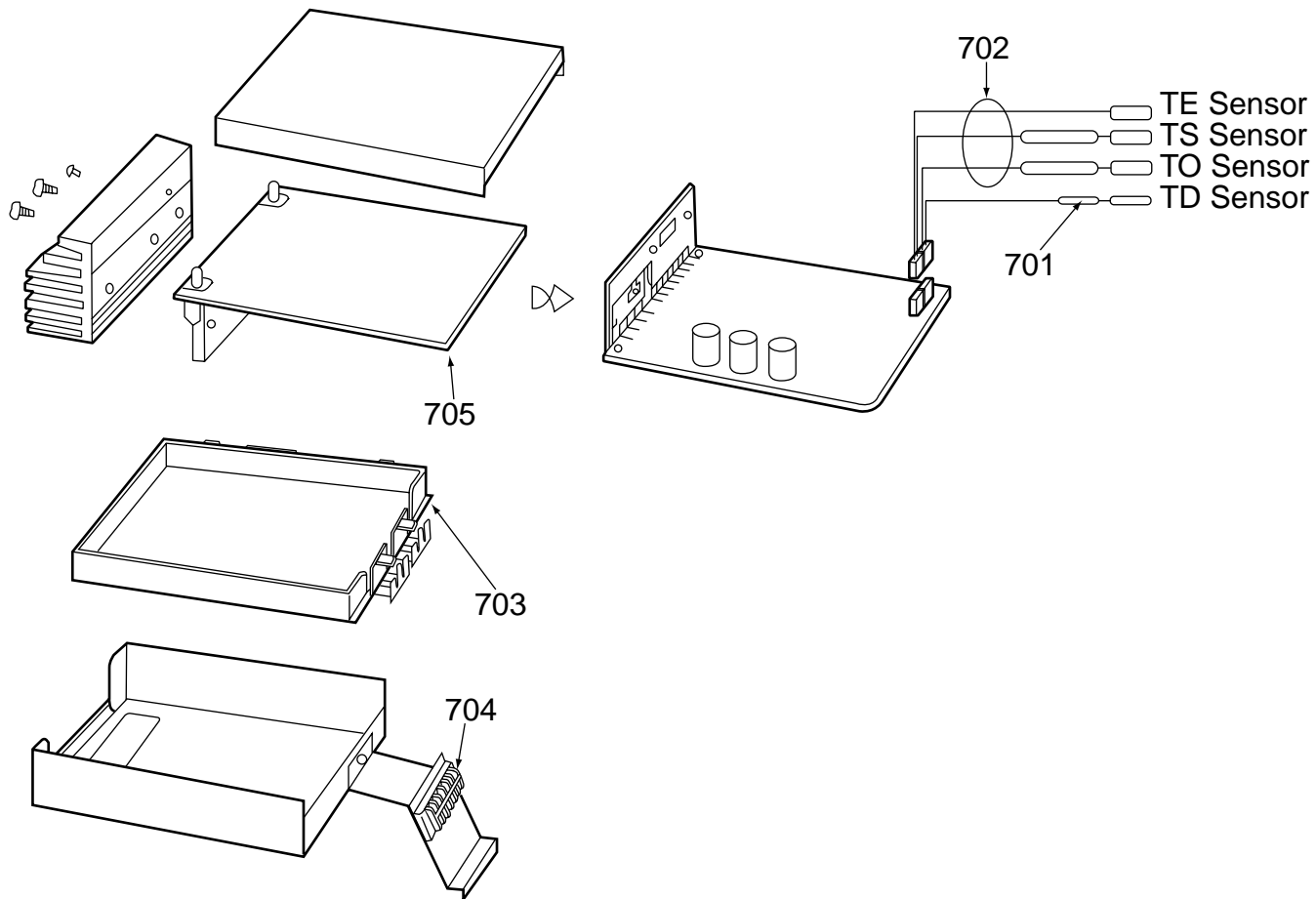

Location No.	Part	Description
701	43050334	Sensor, TD (F4), TD Sensor
702	43050382	Sensor, TC (F6), TC Sensor
703	43062228	Base, P.C. Board, ABS
704	43160469	Terminal Block, 6P, AC250V, 20A
705	4316V182	P.C. Board Ass'y, MCC-813

RAV-SM800AT-E

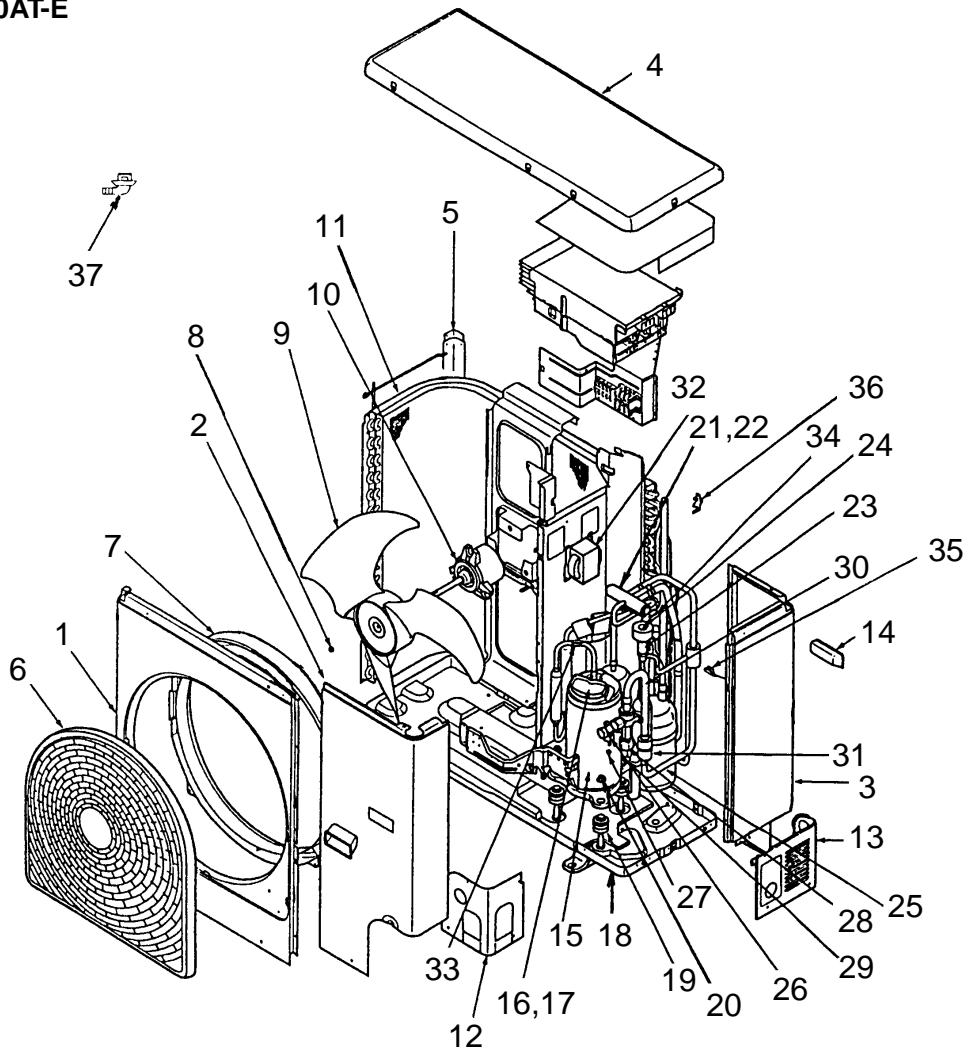

Location No.	Part	Description
1	43191634	Cabinet, Air Outled
2	43191636	Cabinet, Front, Ass'y
3	43191635	Cabinet, Side, Ass'y
4	43191637	Panel, Upper
5	43005489	Guard, Fin
6	43191630	Guard, Fan, PP-K
7	43122065	Bell Mouth, Plastic
8	43047667	Nut, Flange
9	43120123	Fan, Propeller, PJ491, AS-G
10	43121693	Motor, Fan, ICF-140-63-1
11	4314G117	Condenser, Ass'y
12	43191515	Panel, Front, Piping
13	43191605	Panel, Back, Piping
14	43119390	Hanger
15	43041772	Compressor Ass'y
16	43050407	Thermostat, Bimetal
17	43063317	Holder, Thermostat
18	43005482	Base Ass'y
19	43049739	Cushion, Rubber
20	43097204	Nut
21	43046344	Valve, 4-WAY, CHV-0213

Location No.	Part	Description
22	43046348	Coil, Solenoid, VHV-01A150A1
23	43046385	Valve, Pulse, Modulating, SKV-18D26
24	43046386	Coil, PMV, DKV-MO25743BO
25	43048066	Accumulator Ass'y
26	43146584	Valve, Packed, 9.52DIA, HKT9.52
27	43047401	Bonnet, 3/8 IN, 9.52 CU
28	43146613	Valve, Ball, B5/8F
29	43195029	Bonnet
30	43148169	Strainer
31	43148176	Strainer
32	43058266	Reactor, CH-47-Z-K
33	43063321	Holder, Sensor, 4-8, 9.52
34	43063322	Holder, Sensor, 6-11.4, 12.7
35	43063325	Holder, Sensor, 6-6.35, 8
36	43063332	Holder, Sensor
37	43032441	Nipple, Drain



RAV-SM1100AT-E / RAV-SM1400AT-E

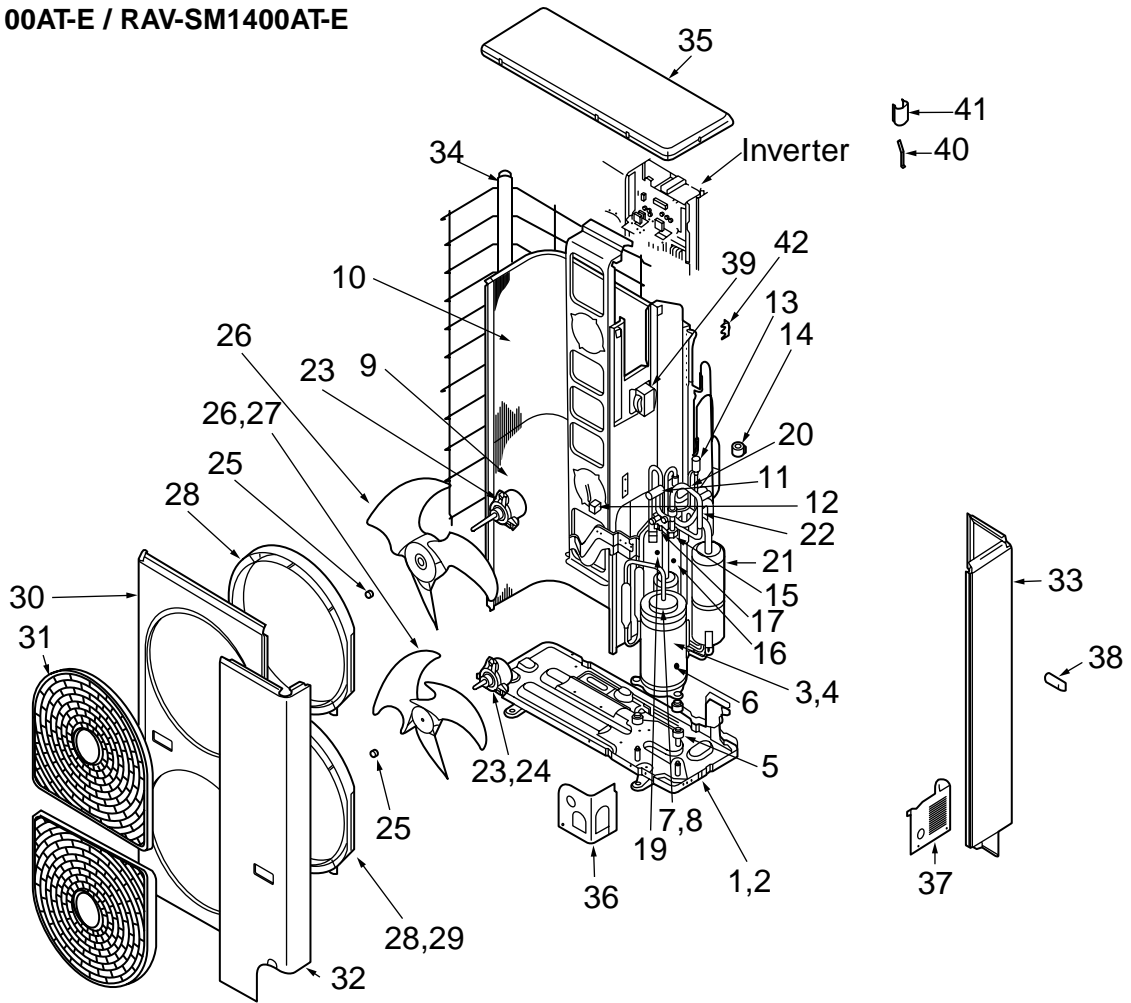

Location No.	Part	Description
1	43005482	Base Ass'y (SM1100AT-4C)
2	43100248	Base Ass'y (SM1400AT-4C)
3	43041772	Compressor Ass'y, DA220A2F-20L (SM1100AT-4C)
4	43041774	Compressor Ass'y, DA420A3F-21M (SM1400AT-4C)
5	43049739	Cushion, Rubber
6	43097204	Nut
7	43050407	Thermostat, Bimetal
8	43063317	Holder, Thermostat
9	4314G152	Condenser, Ass'y, Down
10	4314G154	Condenser, Ass'y, Up
11	43146619	Valve, 4-WAY, STF-0213Z
12	43146611	Coil, Solenoid, VHV-01AJ502E1, AC 220-240V
13	43146634	Valve, Pulse, Modulating, UKV-25D22
14	43146614	Coil, PMV
15	43146613	Valve, Ball, 5/8 IN
16	43147194	Bonnet, 5/8 IN
17	43146584	Valve, Packed, 3/8 IN
19	43047401	Bonnet, 3/8 IN
20	43147611	Strainer

Location No.	Part	Description
21	43148170	Accumulator Ass'y, 2.5L
22	43148176	Strainer
23	43121704	Motor, Fan, ICF-140-63-2
24	4302C040	Motor, Fan, ICF-140-43-2 (SM1100AT-4C)
25	43047667	Nut, Flange
26	43120213	Fan, Propeller, PJ491, AS-G
27	43020329	Fan, Propeller, PJ421, AS-G (SM1100AT-4C)
28	43122065	Bell Mouth, Plastic
29	43122074	Bell Mouth, PP (SM1100AT-4C)
30	43191606	Panel, Air Outlet
31	43191630	Guard, Fan, PP-K
32	43191607	Panel, Front
33	43191608	Panel, Side
34	43191602	Guard, Fin
35	43191609	Plate, Roof
36	43191515	Panel, Front, Piping
37	43191605	Panel, Back, Piping
38	43119390	Hanger
39	43155188	Reactor, CH-56-2Z-T
40	43019904	Holder, Sensor, SUS
41	43063188	Holder, TC Sensor
42	43063332	Holder, Sensor
43	43032441	Nipple, Drain

702 TD SENSOR  
 701 TO SENSOR  
 701 TE SENSOR  
 701 TS SENSOR

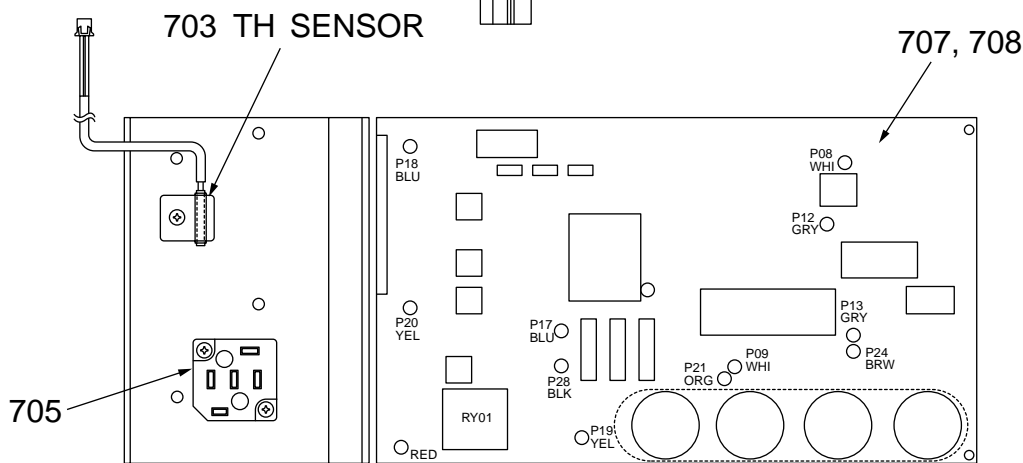
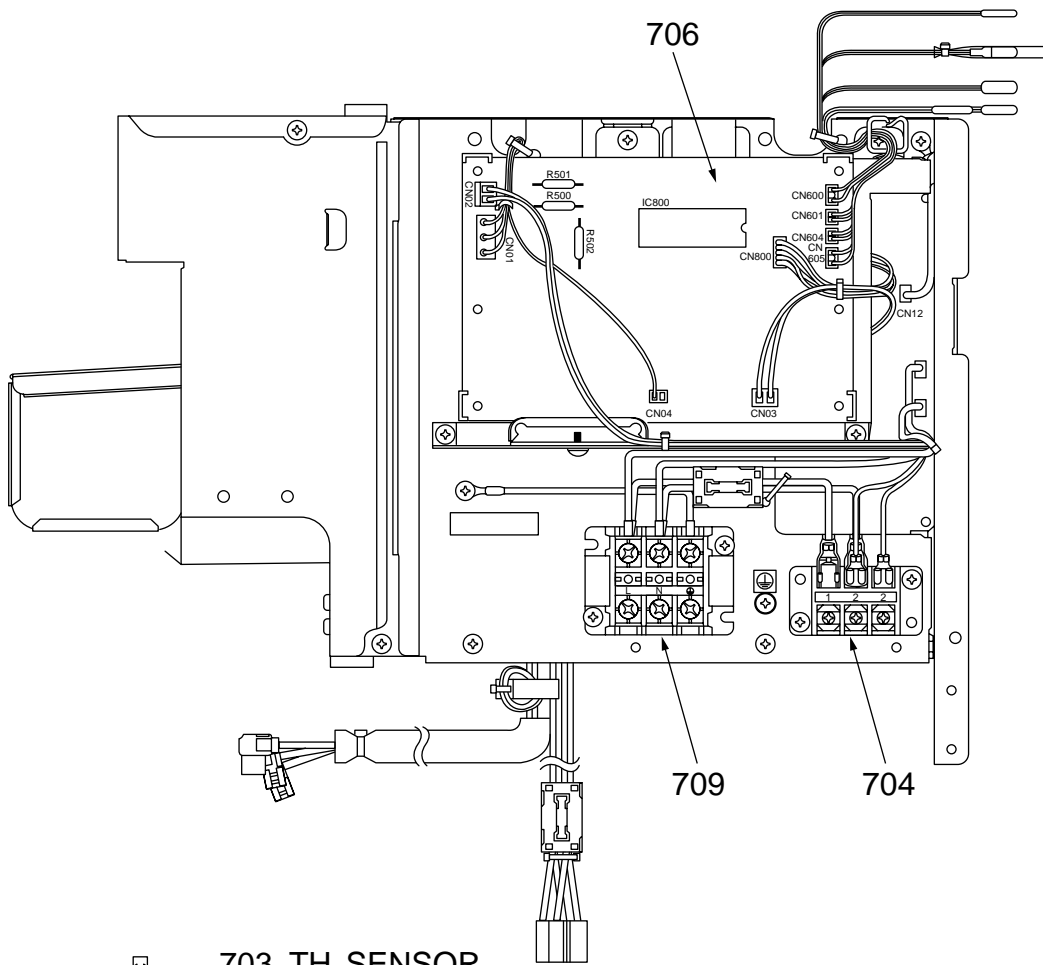

Location No.	Part	Description
701	43050382	Sensor, TC (F6)
702	43050384	Sensor, TD
703	43050398	Sensor, TH (F4)
704	43060750	Terminal Block, 3P
705	43150295	Rectifier
706	4316V217	P.C. Board Ass'y, CDB, MCC-1398, 2-Fan

Location No.	Part	Description
707	4316V218	P.C. Board Ass'y, IPDU, MCC-1438 (SM1100AT-4C)
708	4316V219	P.C. Board Ass'y, IPDU, MCC-1438 (SM1400AT-4C)
709	43160552	Terminal Block, 3P (Power Supply)

**TOSHIBA CARRIER CORPORATION**

2 CHOME 12-32, KONAN, MINATOKU, TOKYO, 108-0075, JAPAN